

Magnetic cartridges/R.I.A.A. equalization

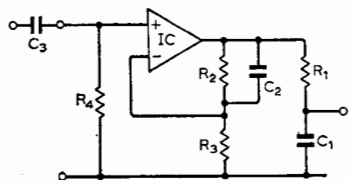

Typical performance
 IC: 741
 R_2 : 680k Ω
 R_3 : 76k Ω (82k Ω //1M Ω)
 R_1 : 15k Ω
 R_4 : 68k Ω
 C_0 : 33 μ F $_3$:

C_2 : 4.7nF
 C_1 : 4.7nF
 Supplies: \pm 10V
 Distortion: 0.05% at
 350mV r.m.s. input
 100Hz, 1kHz. 0.1% at
 10kHz

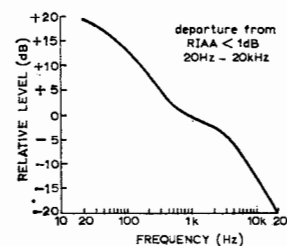

Circuit description

The required transfer function to meet the playback characteristic of BS 1928: 1965 and RIAA is of the form

$$T = K \frac{(1 + j\omega T_2)}{(1 + j\omega T_1)(1 + j\omega T_3)}$$

with $T_1 = 75$, $T_2 = 318$ and $T_3 = 3180\mu$ s. The circuit shown achieves this by using an external passive network R_1 , C_1 which gives the attenuation corresponding to $1/(1 + j\omega T_1)$ and a feedback network R_2 , R_3 , C_2 which controls the gain of the amplifier to give the remaining frequency-dependent terms. In this way three time constants are provided using only two capacitors. At very low frequencies the gain is constant at $(R_2 + R_3)/R_3$ provided the input time constant is low enough. As frequency rises X_{C_2} becomes comparable with R_2 and the gain falls, until X_{C_2} becomes comparable to R_3 . At higher frequencies amplifier gain becomes unity,

with the passive network following contributing an increasing attenuation at still higher frequencies. In some cases the limited bandwidth of the amplifier might be relied on to approximate to this final high-frequency performance, eliminating R_1 and C_1 . Input impedance is determined by R_4 except at very high frequencies where amplifier input capacitance becomes significant. Output impedance is determined by R_1 , C_1 . To obtain high-accuracy capacitors at low cost, the time constants may be obtained using resistors for R_2 , R_3 that result in a d.c. offset due to input current that conveniently cancels that due to R_4 . Lower values of resistor minimize hum pick-up problems in difficult environments.

Wireless World Circard Series 5: Audio Circuits-2

Tone control circuits/Baxandall

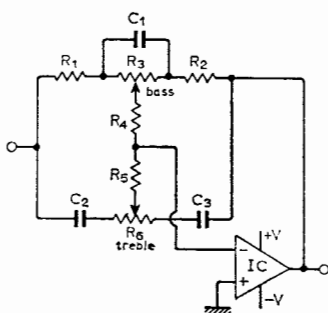

Typical performance
 IC: 741
 Supplies: \pm 15V
 R_1 , R_2 : 4.7k $\Omega \pm 5\%$
 R_3 , R_6 : 100k Ω
 R_4 : 39k Ω
 R_5 : 5.6k Ω
 C_1 : 47nF $\pm 5\%$
 C_2 , C_3 : 2.2nF $\pm 5\%$
 Input signal: 2V pk-pk
 Source impedance: 60 Ω

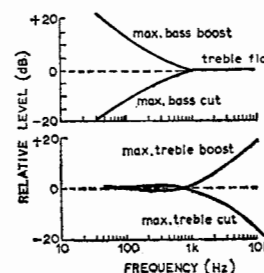

Circuit description

A tone control is a variable filter in which one or more of the elements is variable and which allows amplitude-frequency response of an amplifier to be adjusted. The above active circuit operates with a frequency-dependent feedback network and is based on the original Baxandall design. It has its greatest effect on the extreme bass and treble parts of the audio spectrum, and allows for separate bass and treble controls between which there is low interaction. The circuit features low distortion with maximum boost, and with the controls in mid-position the overall response is flat to within 1dB over the audio range. To ensure minimum restriction on the range of control available the source impedance of the driving circuit should be low. The component values used give the

characteristics shown in the graphs with approximately 20dB of bass and treble boost and cut at 30Hz and 15kHz with respect to 1kHz, where the gain is unity. Excluding hum, the total harmonic distortion and noise is better than 0.5% over the range 100Hz to 10kHz, and better than 0.01% for input signals less than 100mV.

Component changes

To make small changes in overall response of the tone control circuitry, resistors R_4 and R_5 may be increased to double their present value, or reduced to zero, e.g. for R_4 zero bass boost and cut increased by approximately 3dB for frequencies below 1kHz; for R_5 zero, treble boost and cut increased by 2dB for frequencies greater than 1kHz.

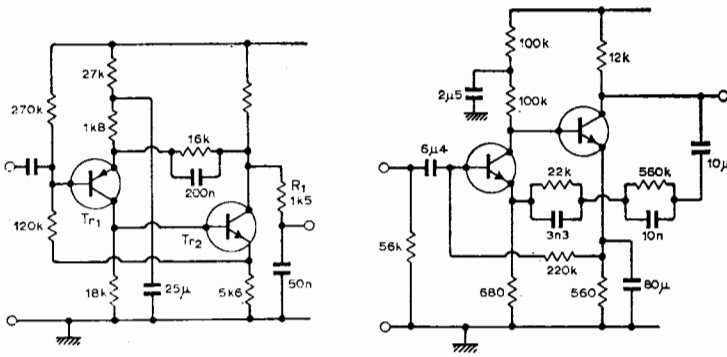

Component changes

IC: Any general purpose op-amp whose gain-bandwidth product 20kHz .

R_2 : 6.8 to $680\text{k}\Omega$

R_3 : 680Ω to $100\text{k}\Omega$

R_1 : 470Ω to $47\text{k}\Omega$

C_1 : 0.1 to $10\mu\text{F}$ (may be dispensed with if head allowed to carry small input current).

C_2 : 1nF to $1\mu\text{F}$

C_3 : 1nF to $1\mu\text{F}$

Constraints: $R_1 C_1 = 75\mu\text{s}$, $R_2 C_2 = 3180\mu\text{s}$ and

$R_2 R_3 C_3 / (R_2 + R_3) = 318\mu\text{s}$.

Within these constraints the input resistance should be around $50\text{k}\Omega$ for matching standard magnetic cartridges; the resistor values have to be compromises between drift and hum/noise problems (high R), as well as amplifier loading (low R).

Circuit modifications

- Any amplifier capable of accepting shunt-derived series-

© 1973 IPC Business Press Ltd.

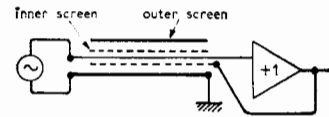

applied negative feedback may be used. Feedback is considerable and the amplifier does not need high open-loop gain to provide accurate equalization using this network. A single-ended supply may be used and the circuit is tolerant of wide variations in this supply and of transistor characteristics. The load resistance must be $\geq R_1$ if the $75\text{-}\mu\text{s}$ time constant is not to be modified though in practice loads may be accommodated by raising R_1 and accepting some attenuation at all frequencies.

- Where the amplifier is to accommodate varying types of input shunt-applied feedback leading to a see-saw type amplifier is the usual solution; this allows control over input impedance and transfer function for a wide range of requirements. Again the gain requirements are low and one or two transistors may suffice in the amplifier.

- To minimize cable capacitance effects, twin-screened cable may be used with the outer screen grounded and the inner screen connected to the feedback path. By this means inner-screen capacitance is bootstrapped. Applicable to all series applied feedback circuits.

Cross references

Series 5, cards 4, 8 & 12.

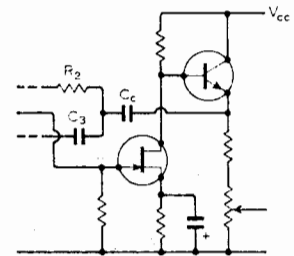
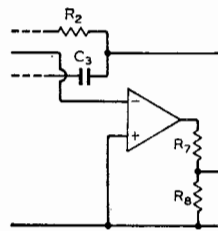
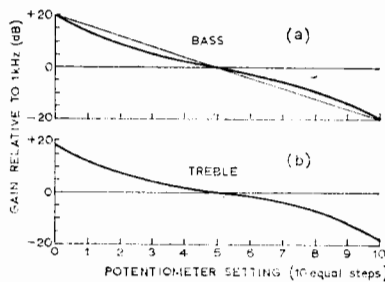

Circuit modifications

- To obtain gain with low input signals, connect feedback network to potential divider tapping across the output as shown centre i.e. gain = $(R_7 + R_8)/R_8$. Useful values for a gain of 10: R_8 : 470Ω , R_7 : $4.7\text{k}\Omega$. To ensure that the input and feedback parts of the network give correct balance with the controls in mid-position, the source resistance should be equal to R_7 and R_8 in parallel.

- For a discrete-component output stage, use a field-effect transistor in preference to a bipolar transistor because of better linearity and lower noise level (see last reference), and the high input impedance minimizes loading on the tone control circuit. Emitter-follower output provides a low output impedance and thus the arrangement can replace the op amp.

Further reading

Transistor Audio and Radio Circuits, Mullard, 1969, pp.131-9.

Baxandall, P. J., Negative-feedback tone control, *Wireless World*, vol. 58, 1952, pp.

Bailey, A. R., High performance transistor amplifier, *Wireless World*, vol. 71, 1966, p.601.

Quilter, P. M., Low distortion tone control circuit, *Wireless World*, vol. 77, 1971, pp.199-200.

Ambler, R., Tone balance control, *Wireless World*, vol. 76, 1970, pp.125/6.

Meyer, D., Audio pre-amplifier using operational amplifier techniques, *Wireless World*, July 1972, pp.309-12 & p.544 Nov.

Linsley Hood, J. L., Modular pre-amplifier design, *Wireless World*, vol. 75, 1969, pp.306-10.

Cross references

Series 5, card 6.

© 1973 IPC Business Press Ltd.

Rumble filters

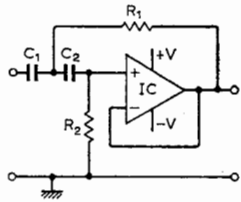

Typical performance
 IC: 741
 Supplies: $\pm 15V$
 C_1, C_2 : $100nF \pm 10\%$
 R_1, R_2 : see graphs
 Input: $100mV$ r.m.s.
 Source resistance: 60Ω

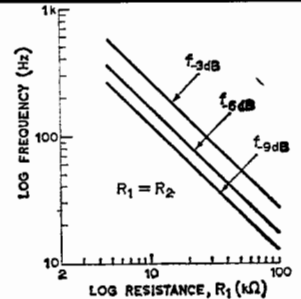

Introduction

An audio amplifier, having an amplitude-frequency response extending into the sub-audible range, can suffer from the reproduction of sub-audio-frequency signals especially when it is operated in its high output level region. Although these very low frequencies are themselves inaudible they can overload various parts of the system and/or produce intermodulation distortion and even audible tones by mixing with wanted signal components. These rumble signals may be produced from many sources such as turntable units, tape decks and microphones, in the latter case being largely due to sudden changes in breadth or due to wind when outdoors. In disc reproduction, rumble signals are generated due to the transmission of mechanical vibrations from the turntable unit to the stylus or even along the pick-up arm to the cartridge. Sometimes these rumble signals are of large amplitude due to resonances in the turntable mounting plate or plinth or due to transmission of the sub-audible slip frequency of an induction-type drive motor. To reduce the

effect of these unwanted signals many amplifiers include a high-pass, or rumble, filter which can be of active or passive form. Often the filter is a fixed-response, passive design permanently connected in the pre-amplifier and consists of high-cost inductors having high-permeability screens and capacitors. A cheaper active filter can normally be designed using transistors or integrated circuits and located between the preamplifier equalization network and tone controls. Such filters can be switched out of circuit if desired and may have a variable response. The circuit shows a simple, second-order active filter having a cut-off frequency that is easily adjusted by means of R_1 and R_2 which could be in the form of a ganged potentiometer.

Component changes

Useful range of supplies: ± 3 to $\pm 18V$. For a required cut-off frequency C_1 and C_2 could be made 1% components and R_1 and R_2 matched to give the same time constants. Ratio

Wireless World Circard Series 5: Audio Circuits-4

Tape-head preamplifier

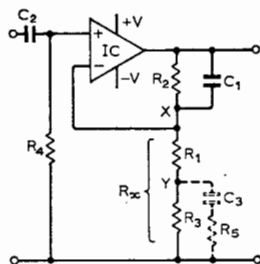

Typical performance
 IC: 741*
 Supplies: ± 5 to $\pm 15V$
 R_1 : 220Ω ; R_2 : $10k\Omega$
 ($9.5k\Omega$ preferred)
 R_3 : 47Ω
 C_1 : $0.33\mu F \pm 1\%$
 Above values suitable for $9.5cm/s$
 R_4 : $100k\Omega$; R_5 : 22Ω
 C_2 : $47nF$; C_3 : $1\mu F$
 *not optimum for low noise performance

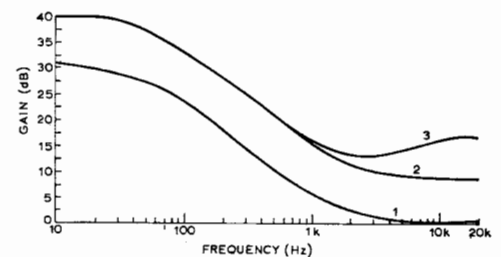

Circuit description

The circuit is closely related to that of the magnetic pickup preamplifier having a transfer function of the form $k(1 + j\omega T_1)/(1 + j\omega T_2)$.

Time constants are determined in accordance with appropriate standards. The circuit shown achieves two time-constants using a single capacitor with $T_1 = C_1(R_x \text{ in parallel with } R_2)$, $T_2 = C_1 R_2$. For widely-spaced time constants $R_2 \gg R_x$ and $T_1 \approx C_1 R_x$ i.e. independent control of the time-constants is possible in practice by varying R_x and R_2 separately. At low frequencies the gain rises to a maximum of $(R_2/R_x) + 1$ falling at high frequencies to unity. This fails to make use of the high open-loop gain of the amplifier, providing equalization without further amplification. The circuit also lacks the facility for introducing high-frequency lift to help overcome

the practical imperfections of head and recording medium (see modifications over). Input resistance of the circuit should be high and this could be accomplished by direct connection of the tape-head to the non-inverting input. This would however allow the amplifier input current to flow in the head, partially magnetizing it and increasing the resulting tape-noise. This effect may be avoided by using C_2 (low-leakage) and by regularly demagnetizing tape-heads.

The head characteristic is such that a tape recorded with constant magnetization, irrespective of frequency, would produce an e.m.f. from the playback head proportional to frequency, as e.m.f. is proportional to the rate-of-change of magnetic field. This explains the need for the rising gain at low frequencies. A complex pattern depending on record bias levels, high-frequency fall-off in remanence, play-back gap

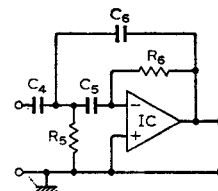
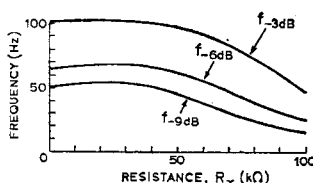
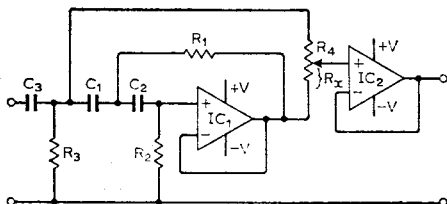

C_1/C_2 can be changed to alter response. Operational amplifier 741 can be changed to a 748 or 301 with a 30-pF compensation capacitor. Resistors R_1 and R_2 may be made continuously variable with a ganged log-law potentiometer.

Circuit modifications

It is possible to cascade a number of high-pass sections, of the type shown over, to obtain filters having a higher rate of cut-off, as the output impedance of each section is very low.

● The network shown left is a modification of the basic section requiring the addition of C_3 , R_3 , R_4 and A_2 . Components C_3 and R_3 form an additional first-order section and R_4 is connected between the output of this section and the original second-order section. Amplifier A_2 is connected as a follower having a high input impedance so that the filter response is not significantly altered by the loading of the following stage. When $R_x = R_4$, V_{out} is in the form of a first-order high-pass filter response. When $R_x = 0$, V_{out} follows the signal at the output of A_1 which is in the form of a third-order response as the passive first-order section C_3 , R_3 is then in cascade with the active second-order section; R_4 is then, ideally simply a high resistance shunt path. As R_x

changes from R_4 to zero, the cut-off frequency and the rate of cut-off increase, so that it could be useful to choose the first-order and second-order section time constants to define the end-points of the response. Graph shows the variation obtained with a 741 as A_1 , A_2 ; supplies of $\pm 15V$; C_1 , C_2 100nF; R_1 , R_2 : 33k Ω ; C_3 : 10 μF ; R_3 : 330 Ω and R_4 : 100k Ω .

● Circuit right shows an alternative high-pass section having a Bessel response and a cut-off frequency of $0.7/2\pi C_4 R_5$ when $C_4 = C_5 = C_6$ and $R_6 = 3R_5$.

Further reading

Evans, J. H. and Williams, P., Modular integrated-circuit audio mixer, *Wireless World*, Dec. 1972, pp.564-70.

Gayford, M. L., Hi-Fi for the Enthusiast, Pitman 1971.

Earl, J., How to Choose Pickups and Loudspeakers, Fountain Press 1971.

SL403A & SL402A I.C. Audio Amplifier Applications Report, publication no. 4324, Plessey Microelectronics, 1970.

Cross references

Series 5, card 6.

Series 1, cards 3, 5 & 6.

© 1973 IPC Business Press Ltd.

dimensions, record and playback gap alignments, magnetic domain size in the tape determine the number and extent of corrective actions during the record-replay process. Limiting the gain to a constant value at high frequencies is covered by the equalization standard, other actions, particularly treble boost on record and playback being considered for each specific head, tape and bias combination.

Component changes

● Improved performance obtained by using specially designed low-noise amplifiers such as the National Semiconductor dual preamplifier or the RCA quad-amplifier packages CA3048 or CA3052.

● Increase gain by connecting feedback from junction of R_1 and R_3 .

● Approximately 6dB of treble boost achieved when C_3/R_5 network inserted, the upper limitation being determined by R_5 .

Circuit modifications

These are concerned with the higher frequency range where $X_{C1} \ll R_2$.

● Network shown left is useful for variable tape speeds. If tape speed is reduced, time constant must be increased. With a lower tape speed, the output is reduced, but this will be matched by the increased gain obtained by increasing R_1 i.e. gain given by $(R_1 + R_3)/R_3$.

● Variable gain possible without alteration of time constant is available from circuit shown centre.

● Circuit on right shows an arrangement in which both a variable gain and time constant are independently achieved.

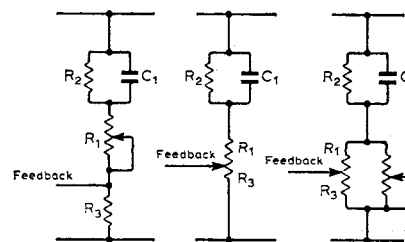

Further reading

Ridler, P. F., Transistor tape preamplifier, *Wireless World*, vol. 64, 1958, pp. 572-3.

Ridler, P. F., High quality tape preamplifier, *Wireless World*, vol. 68, 1962, pp.52-3.

Murray, J. S., Tape recorder circuits, *Wireless World*, vol. 68, 1962, pp.531-4 & 601-4.

Stuart, J. R., Tape noise reduction, *Wireless World*, March 1972, pp.104-110.

Stuart, J. R., High-quality tape recorder, *Wireless World*, vol. 76, 1970, pp.524-9 & 587-91.

BS 1568: Part 1:1970. Magnetic tape recording equipment.

National Semiconductor application note AN-64.

Linear Integrated Circuits and MOS Devices, RCA Databook series SSD-201.

Cross references

Series 5, card 1.

© 1973 IPC Business Press Ltd.

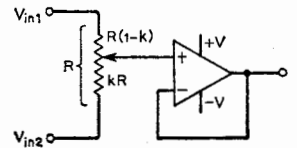
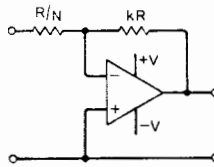
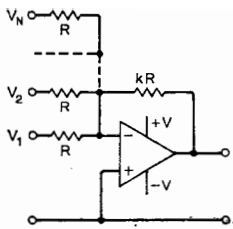

Component changes

Effects of parallel source resistance on magnitude and phase at 1kHz and 10kHz for nominal gain magnitudes of 100 and unity ($R_3 = \infty$) are tabled below $R_2 = 100k\Omega$, $R_1 = 1k$ or $100k\Omega$.

gain		frequency (kHz)	R_3 (k Ω)	phase lag (deg)
nominal	measured			
100	95	1	∞	-180
100	70	10	∞	-240
100	90	1	1	-200
100	45	10	1	-260
1	unity	1	∞	-180
1	within	10	∞	-180
1	resistor	1	1	-180
1	tolerances	10	1	-215

In the last two observations for unit gain, the $1k\Omega$ shunt resistance causes a d.c. shift of $-250mV$.

Circuit modifications

To mix two signals, use voltage follower as shown right. Output voltage is $V_{out} = kV_{in1} + (1-k)V_{in2}$. An advantage is that the degree of mixing is continuously variable, with equal mixing when $k = 0.5$. However, $R \gg$ output impedance of the signal sources, and suitable drivers would be op-amps with $R > 10k\Omega$.

Further reading

Evans, J. H. & Williams, P., Modular integrated circuit audio mixer, *Wireless World*, vol. 78, Dec. 1972, pp.564-70. Audio mixing preamplifier circuit, *Mullard Outlook*, vol. 15, no. 1. June 1965.

© 1973 IPC Business Press Ltd.

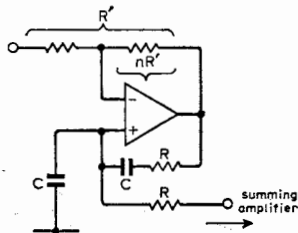

Component changes

Potentiometer resistances should be low to avoid changing characteristics of Wien networks (output resistance of pot. included in series arm of network). A compromise is necessary as multiple pots. present heavy load to the audio source - range 1 to $100k\Omega$ within above constraints.

C: 100 pF to $10\mu F$ chosen to give centre frequencies of $1/2\pi CR$.

R: 1k to $1M\Omega$

R_1 : 1 to $100k\Omega$

Any number of sections may be used in principle with the restriction that the frequency limitations of the summing amplifier dictate the high-frequency response.

Circuit modifications

● Any band-pass amplifier may be added to the system, or replace an existing passive section, to increase the boost attainable at a given frequency. Such filters as those of Circard series 1 nos 1, 3, 6 & 8 may be used. As shown, the output is an inverted version of the input at the centre frequency and adjustment of the Q by varying the tapping point results in complex variations in the response, ranging from band-pass

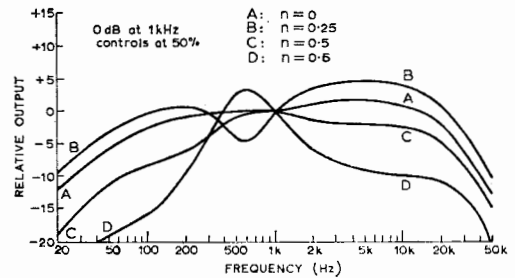

to a virtual notch. These methods must be applied with discretion but as the accompanying graph shows even a single active filter can produce dramatic variations in response (applications could include sound-effects, tone forming in electronic musical instruments).

● Combinations of low and high-pass circuits allow the raising and lowering of ranges of frequencies without the peaky response of band-pass circuits as above. Notch filters inserted in series can be used to tune out particular frequencies.

Further reading

Ambler, R., Tone-balance control, *Wireless World*, vol. 76, 1970, pp.124-6.

Hutchinson, P. B., Tone control circuit, *Wireless World*, vol. 76, 1970, pp.538-40.

Cross references

Series 5, cards 2 & 10.

Series 1, cards 1, 3, 8 & 11.

© 1973 IPC Business Press Ltd.

Scratch filters

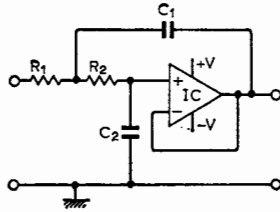

Circuit description

Many audio amplifiers provide low-pass or top-cut filters to define the upper limit of the frequency response. These filters, normally incorporated between the source equalization pre-amplifier and the tone control circuit, are used to eliminate unwanted signals such as tape hiss, surface noise and scratches from old discs, radio interference, bias oscillator pick-up. Although some undesired h.f. signals are outside the audible range they can nevertheless overload the amplifier or introduce inter-modulation distortion components that may render the output unsatisfactory unless they are attenuated by a low-pass filter. Such filters may be passive or active networks or a combination of both types. Whatever its form, the low-pass filter will normally be switched in or out of circuit as desired. Cut-off frequency of the filter may either be infinitely-variable over a wide range or selected by a multi-position switch, typical values being 4, 8, 10, 12 and 15kHz. Selection of the cut-off frequency will normally be made subjectively

Typical performance

IC: 741
 Supplies: $\pm 15V$
 C_1, C_2 : $1nF \pm 1\%$
 R_1, R_2 : see graphs opposite
 Input: $100mV$ r.m.s.
 Source resistance: 60Ω

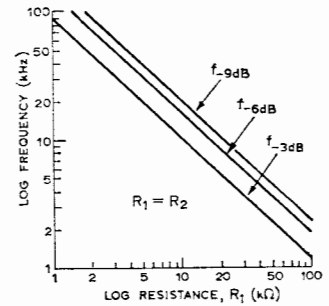

depending on the amount and nature of the high frequency noise. While the rate of cut-off could also be chosen subjectively it would not normally exceed about 18dB/octave due to the increasing likelihood of severe transient distortion or ringing in the region of the cut-off frequency as a result of the amplifier becoming conditionally stable.

The circuit shown is an example of a simply-designed, second-order active low-pass filter using RC networks that can provide a wide range of cut-off frequencies with a cut-off rate that is well within the above-stated maximum. By suitable choice of components its input impedance can be adjusted so that it does not significantly load the preceding pre-amplifier and its output impedance is low due to the operational amplifier.

Wireless World Circard Series 5: Audio Circuits-8

Microphone preamplifiers

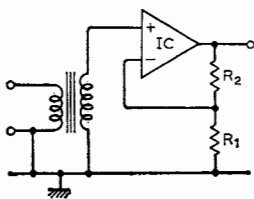

Typical performance

IC: 741
 Transformer: see note
 R_2 : $1k\Omega$
 R_1 : 100Ω
 Source resistance: 200Ω
 Response: $45Hz$ to $20kHz$, $+0dB/-3dB$
 (Application of small

bass-boost as in card 2 gave $20Hz$ to $20kHz$ $\pm 1.5dB$
 Equivalent input noise: $0.5\mu V$ r.m.s. $20Hz$ to $20kHz$
 Noise reduced by $2dB$ by reducing bandwidth to $10kHz$.

Note:

Performance of the microphone amplifier is strongly affected by the transformer. Type used was U204 by AKG, having a 15:1 turns ratio, a secondary inductance high enough to avoid l.f. limitation, and suffici-

ently low self-capacitance to prevent h.f. losses. Microphones may have specific transformers designed for them and the characteristics of the two should be considered together.

Circuit description

High-quality moving-coil microphones have a low output e.m.f. and a low internal resistance ($< 1mV$ and $100-500\Omega$). Coupled directly to any semiconductor amplifier whether discrete or integrated, the resulting signal/noise ratio would be unacceptable as "hi-fi" but might be adequate for some applications (s/n ratios of about 45-50dB being the limit attainable with low-cost i.c.s and low-sensitivity microphones). As the microphone has a relatively low resistance the dominant noise effect is due to the equivalent noise voltage at the amplifier input—the noise current fails to develop any significant p.d. across the microphone resistance. By transformer-coupling the signal to the amplifier input, and using a step-up ratio of 10:1 or greater, the signal e.m.f. can be greatly increased; no change in noise voltage generated at the amplifier input occurs but the noise current produces a proportionately larger contribution because the effective source impedance seen by the amplifier input is $n^2 R_s$ where n is the

step-up turns ratio and R_s the microphone resistance. The optimum turns ratio which results in equal contributions from voltage and current noise generators may not give the optimum from a standpoint of amplitude response; with too high a turns ratio the resulting high impedance may be shunted heavily by capacitance at high frequencies, while the secondary inductance limits the low-frequency response.

Component changes

The amplifier gain bandwidth product is $10^6 Hz$ and to leave a safe margin for amplifier limitations of upper cut-off, gains of < 50 should be accepted. The transformer has a turns ratio (e.g. 5 to 50) and the amplifier output may be up to $500 \times$ the microphone e.m.f. though 100 to 200 is more likely. Keep R_1, R_2 low from low-noise standpoint e.g.

R_1 : 10 to 500Ω .

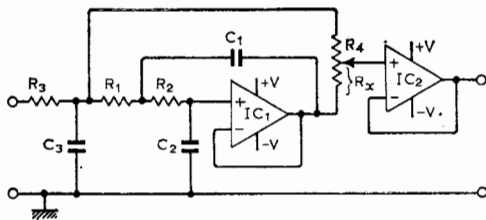

Component changes

Useful range of supplies: ± 3 to ± 18 V.

For defined cut-off frequency C_1 and C_2 may be changed with corresponding change in R_1 and R_2 to give same time constants.

Ratio C_1/C_2 may be varied to change response.

741 operational amplifier may be replaced by a 748 or 301 using a 30-pF compensation capacitor.

R_1 and R_2 may either be switched with a two-pole unit or made infinitely variable with a ganged log-law potentiometer.

Circuit modifications

● Low-pass filters capable of providing a wide range of cut-off frequencies and a variable rate of cut-off tend to become complex networks. Circuit on left shows a modification of the basic circuit which provides a compromise between network complexity, variable cut-off frequency and rate of cut-off. Components A_1 , R_1 , R_2 , C_1 and C_2 form the basic second-order active filter and R_3 and C_3 form an additional first-order passive section. Potentiometer R_4 is connected between the outputs of the first-order and second-order networks. When $R_x = R_4$, V_{out} provides a first-order cascaded first-order and second-order networks. R_4 must be reasonably large to prevent significant changes in the time

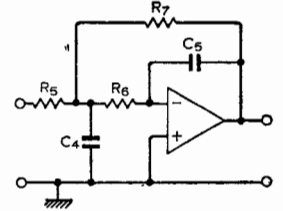
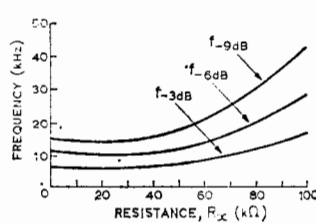

constants at the extreme values of R_x and A_2 serves as a high-input-impedance buffer to avoid excessive loading of the network. Between the extreme settings of R_x the filter provides a variable cut-off frequency and a variable rate of cut which increases as the cut-off frequency falls. The graph shows this effect with A_1 , A_2 :741; supplies of ± 15 V; C_1 , C_2 :1nF; R_1 , R_2 : 10k Ω ; C_3 : 10nF; R_3 : 1k Ω and R_4 : 100k Ω .

● Of the many alternative forms of active low-pass filters one example is shown right which provides a Bessel response – a good compromise between sharpness of cut off and transient overshoot – when $R_5 = R_6 = R_7$ and $C_4 = 3C_5$ with a cut-off frequency of $1.4/2\pi C_4 R_5$ Hz.

Further reading

Evans, J. H. and Williams, P., Modular integrated circuit audio mixer, *Wireless World*, Dec. 1972, pp.564-70.

Gayford, M. L., Hi-Fi for the Enthusiast, Pitman, 1971.

SL403A & SL402A I.C. Audio Amplifier Applications Report Publication No. 4324, Plessey Microelectronics, 1970.

Cross References

Series 5, card 6.

Series 1, cards 3, 4, 6 & 11.

© 1973 IPC Business Press Ltd.

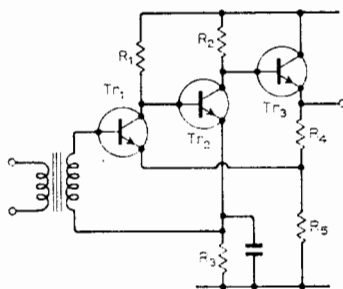

R_2 : 100 to 5k Ω .

R_2/R_1 : 5 to 50.

Coupling capacitor may be used at output though d.c. content is small.

Output stage of op amp is class B. Where crossover distortion is a worry, even though negative feedback is large, stage may be biased into class A by taking resistor from output to one supply line, drawing current greater than expected peak load current.

Circuit modifications

● Any non-inverting amplifier may use series-applied feedback in the same way. If conventional transistor amplifiers are used, one approach is to define the d.c. conditions separately and capacitively couple the transformer output to the amplifier. The method shown makes use of the low d.c. resistance of the transformer to act as a shunt-applied d.c. negative feedback from second emitter to first base. If R_4/R_5 is relatively large (high closed-loop gain) then p.d. across R_3

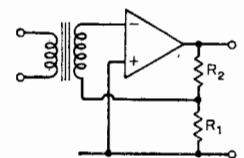
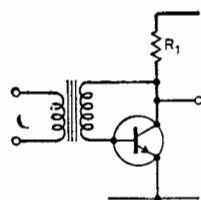

is V_{be} of Tr_1 , ≈ 0.6 V for silicon. Convenient resistors might have $R_2 = 5R_3$, $R_1 = 10R_2$, $R_2 = 10R_4$, $R_4/R_5 =$ required gain, $0.6V/R_3 =$ standing current in Tr_2 ; all for $V_s = 5$ to 15V. The values may be chosen to give a standing current in Tr_3 convenient for the required load swing, or if that is not a limiting factor, the currents may be lowered to raise the effective input impedance. The ratios are neither critical nor optimal, but are working guides.

● Using the virtual earth idea, an extremely simple self-biased stage gives no voltage gain but a lower output impedance at negligible cost. It may be similarly applied to the d.c. feedback-pair circuit or as shown to an alternative operational amplifier arrangement.

Cross References

Series 5, cards 2 & 12.

Further reading

Walker, H. P., Stereo Mixer – 1, *Wireless World*, vol. 77, 1971, pp.221-5.

Walker, H. P., Low-noise Audio Amplifiers, *Wireless World*, vol. 78, May 1972, pp.233-7.

© 1973 IPC Business Press Ltd.

Impedance matching and transforming

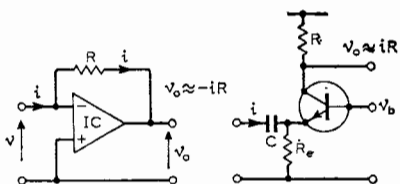

Circuit description

Shunt-applied negative feedback reduces the input resistance of an amplifier. To a first-order, for A large the input impedance is R/A , commonly called Miller effect, properly due to Blumlein. As A is frequently dependent, and for amplifiers such as 741 has 90° phase lag for $10\text{Hz} < f < 1\text{MHz}$, the feedback current lags on the applied voltage i.e. input impedance is low, predominantly inductive and is hence proportional to frequency. The assumption that the input is a virtual earth is justifiable in most cases, but may not be so at upper end of audio range ($Z_{in} \sim j1000\Omega$ at $f = 10\text{kHz}$ for $R = 100\text{k}\Omega$). If d.c. conditions not important, common-base amplifier has low input resistance ($\sim 25\Omega$ for $I_c = 1\text{mA}$) and excellent frequency response. Lower cut-off frequency determined by C and source resistance. Output may be taken at collector either as current into external load (note quiescent d.c. current) or as voltage developed across R . Values of V_b , R_e determine quiescent conditions. Input resistance non-linear and input current should be restricted to small fraction of standing current. Input resistance $\propto 1/I_c$.

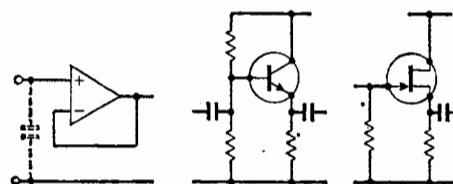

Circuit description

The basic follower circuits (voltage, emitter and source follower) have a.c. voltage gains close to unity, supply appreciable load currents and ideally draw negligible current from the source i.e. giving high input impedance. At high frequencies the finite open-loop gain of the operational amplifier together with its phase lag contribute additional shunt capacitance effects at the input depending on the amplifier input resistance. In most cases the total input capacitance is likely to be dominated by the physical system capacitances; minimum device capacitances below 1 to 3pF are rare, total capacitance may be around 10pF. For high source resistance ($> 100\text{k}\Omega$) this may bring cut-off frequency below 100kHz but not serious in audio band. Most likely limitation remains falling gain of amplifier if set for high voltage gain initially. See card 8 on mixer circuits. Input impedance of discrete circuits may be high particularly f.e.t. ($> 1\text{M}\Omega$) but a.c. coupling required, at least at output.

Wireless World Circard Series 5: Audio Circuits-10

Economy i.c. audio circuits

Circuit description

The i.c. contains four identical amplifiers each of which is similar to the d.c. feedback pair of a common-emitter stage followed by a common-collector stage. Feedback is applied externally, and the novel feature of the circuit is the second input forming part of a current mirror such that the effective current seen by the amplifier is the difference between the currents fed to the two inputs. The non-inverting input normally receives a separate bias from the positive supply or from any other convenient positive potential including the output of some preceding stage. Signal and feedback are most often applied to the inverting input with the system having properties associated with the see-saw amplifier familiar in op amp circuits. The difference is that the virtual earth is so only for a.c., having a d.c. potential equal to the input transistor V_{be} i.e. $\approx 0.6\text{V}$. This configuration allows most functions normally provided by op amps to be achieved with a single-ended supply over a wide voltage range.

Circuit 1. A basic buffer amplifier with a voltage gain of $-R_2/R_1$ and an input impedance of R_1 . If $R_3 = 2R_2$ the output voltage is approximately $V/2$. This is because the negative feedback through R_2 causes the current flowing in the inverting input to be an approximate match to operation by the d.c. at the output. Although large capacitances are then required ($> 500\mu\text{F}$) if good low-frequency response is the aim. The low voltage rating keeps capacitor cost low. Heavy feedback keeps distortion low, assisted by class A operation. Bandwidth

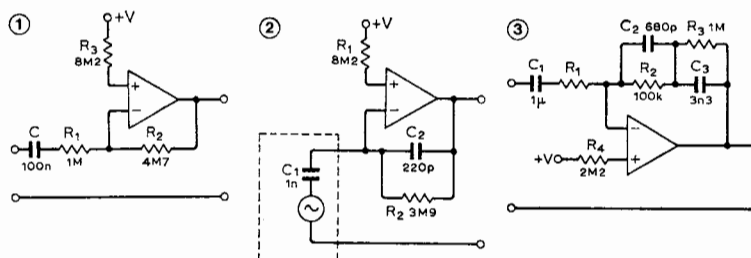

of 10Hz to 100kHz possible with distortion $< 1\%$ in range 100Hz to 10kHz. Ripple induced hum may be minimized by centre tapping R_3 and decoupling to ground.

Circuit 2. Alternative capacitance feedback for inputs such as piezoelectric pick-ups (see card 11). Resistor R_2 necessary to provide bias, reduces low-frequency gain. Possibly centre-tap and decouple to ground using capacitance of 1nF to avoid peak in audio band.

Circuit 3. Magnetic pickup may also be accommodated using feedback network of type described on card 1. Correct bias obtained for $R_4 = 2(R_2 + R_3)$ with R_1 chosen to give correct input impedance. These amplifiers are not specified for low-noise performance but are still worth considering where economy is predominant aim. It is possible to combine the properties of 3 & 4 to give direct headphone drive with one stage from such an input, but at increased distortion and reduced bandwidth. Separate circuits for 3 & 4 give full stereo operation using a single i.c. package together with

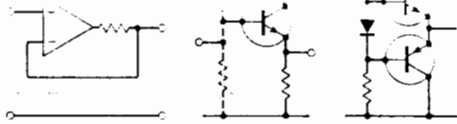

Circuit description

Amplifiers such as the 741, 301 etc. have open-loop output resistances of 50 to 150Ω, relatively frequency independent up to the useful limit of operating frequency. Falling gain of the amplifier at high frequencies does not allow the feedback to reduce the effective output impedance to almost zero as it does at low frequencies. Output impedance is largely inductive and corresponds to a few tens of microhenries e.g. at 90kHz series resonance effects can be observed with a load capacitance of 100nF. Effects are minimal at audio frequencies except where high gain is being attempted i.e. feedback much less than unity. This property is distinct from the current limiting of the amplifier into too low a load resistance, where additional internal transistors clamp the output current to ~25mA. Again emitter followers, Darlington pairs may be used. For high output currents complementary emitter followers in class B are used but the subject is then properly treated as a power amplifier.

Further reading

Evans, J. H. and Williams, P., Modular integrated circuit audio mixer, *Wireless World*, vol. 78, 1972, pp.564-70.

Series 5, cards 1, 8 & 11 high Z_{in}

4 & 5 low Z_{in}

5 fixed Z_{in}

© 1973 IPC Business Press Ltd.

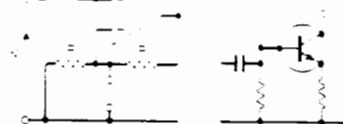

Circuit description

There is no simple way of obtaining high output resistance to a grounded load using operational amplifiers that have one output grounded. One possibility shown above uses positive and negative feedback combined to raise the impedance at point A close to infinity. This may also be viewed as a negative impedance converter circuit and has the possibility of an output resistance which while large may have either positive or negative sign. Load resistance should not be too large (say $< 10R$ if possible) so that the negative resistance effect cannot dominate. Output current is then determined by V and R . At high frequencies the amplifier gain/phase shift gives an equivalent output impedance that becomes capacitive. For a 741 using $R = 10k\Omega$, a shunt capacitance of about 60pF was observed. Upper cut-off frequencies in excess of 100kHz are possible. The transistor circuit and its complementary version allow high impedance a.c. drive but superposed on a direct standing current.

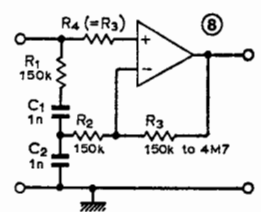
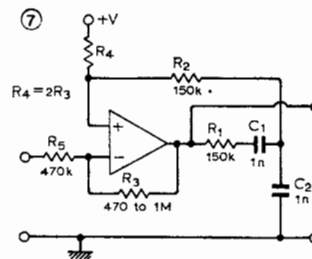
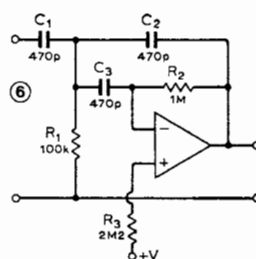
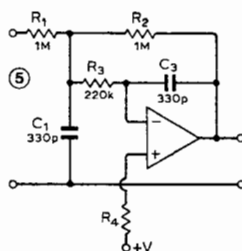
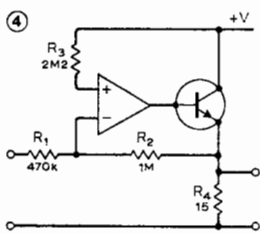

two low-cost output transistors. Major cost in such output stages must be that at the non-inverting input, and this can only be so when the output voltage is related to the supply voltage by the appropriate ratio of the resistors. An alternative bias method for an input with a d.c. resistance to ground $\ll R_1$, is to dispense with C and R_3 and choose the ratio R_2/R_1 to set the output d.c. conditions. This follows from the 0.6V at the inverting input which then defines the current in R_1 . The same current flows in R_2 as that drawn by the inverting terminal is very small. Hence $V_o(\text{d.c.}) \approx [(R_2/R_1) + 1]0.6V$. The gain option is thus restricted by the d.c. setting as the ratio R_2/R_1 is involved in both.

Circuit 4. Where higher output currents are required, a simple class A stage can be added. Output current of the amplifier is up to 10mA, allowing a load current of 100 to 200mA to be achieved without difficulty. Operating with a supply voltage of ~5V dissipation in the output transistors is $\ll 1W$ and low-cost plastic/epoxy units are satisfactory. Current levels are such that this is a very convenient output stage for low-resistance headphones—up to quadraphonic operation using identical configurations for each of the four amplifiers in the i.c. package. Capacitance coupling to the load is then

indicated since the headphones would be driven into non-linear power supply (~5V at 200 to 300mA unregulated but well filtered).

Circuits 5 & 6. Rumble and scratch filters may be constructed (cards 3 and 7) but as the voltage follower mode is not obtainable directly, different passive networks are used. Those shown are both for cut-off frequencies of around 1kHz. The damping may be adjusted without changing this frequency by varying the ratios C_2/C_1 for the scratch filter, 5, and the ratio R_2/R_1 in the rumble filter, 6. Increasing all capacitors in each circuit by a factor n reduces the cut-off frequency by the same factor.

Circuits 7 & 8. If more specialized filters are required in audio systems such as boosting response over a limited band e.g. to help overcome losses in tape heads at high frequencies, then active filters offer an alternative to LC passive sections. Circuit 7 is a low-Q bandpass filter of centre frequency $1/2\pi R_1 C_1 R_2 C_2$ while 8 represents a simple notch filter of the same frequency, adjusting R_4 to obtain the notch. R_3 sets the gain and the bias is obtained from the d.c. level of the preceding stage.

Ceramic cartridge preamplifier

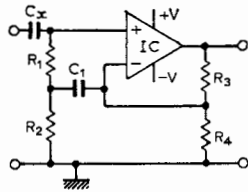

Typical performance
 IC: 741
 Supplies: $\pm 15V$
 R_1, R_2 : $10k\Omega$; R_3 :
 $220k\Omega$; R_4 : $22k\Omega$;
 C_1 : $22\mu F$ (tantalum).
 C_x : $1.5nF$ (see circuit
 description)

Input: $100mV$ r.m.s.
 Source resistance: 60Ω ;
 (see curve opposite)
 Note. Components
 chosen to show resonant
 peak.

$$\text{Gain} = 1 + \frac{R_3(R_2 + R_4)}{R_2R_4}$$

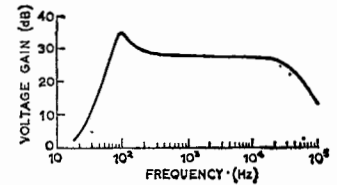

Circuit description

Unlike magnetic cartridges which produce an output proportional to the velocity of the stylus movement, a piezo-electric cartridge provides an output proportional to the amplitude of the stylus deflection and appears as an almost pure capacitance at the preamplifier input. The RIAA recording characteristic is essentially one of constant amplitude except for a small mid-band range of constant velocity recording. Piezo-electric cartridges are normally designed to provide mechanical equalization that caters for imperfections in the almost constant-amplitude recording characteristic. Thus, the preamplifier should provide a flat amplitude response and a high input impedance, not less than about $1M\Omega$. As the input impedance falls so also does the response at the bass end of the spectrum, leading to an approximation to an unequalized magnetic cartridge response. In the circuit shown, C_x represents the capacitance of a crystal or ceramic cartridge, normally in the range $400pF$ to $1nF$. Bootstrap

capacitor C_1 allows the cartridge to be lightly loaded by the high input impedance at the non-inverting input of the operational amplifier. To achieve this C_1 must be a high-value, high-quality capacitor such as a tantalum bead type. Then, the p.d. across R_1 is essentially zero as the high open-loop gain of the operational amplifier forces its differential input p.d. to be zero. Thus, no current flows in R_1 and the cartridge sees it as an open circuit. At low frequencies, the bootstrapping becomes imperfect and the inductive input impedance results in the resonant peak shown above. In the circuit shown over (left) $e = V/(1 + jC_1R_2)$ and $i = e/R_1$, hence $Z_{in} = V/i = R_1(1 + jC_1R_2)$ which contains an equivalent inductance $L = C_1R_1R_2$. This inductance resonates with C_x at $f_0 = 1/2\pi C_1R_1R_2C_x$ ($88Hz$ for above component values). For good transient performance f_0 must be well below the audio band. See below for suitable values.

Wireless World Circard Series 5: Audio Circuits-12

Multi-input preamplifier

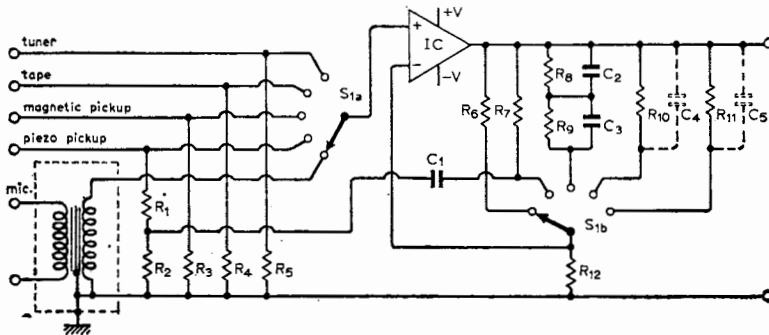

Circuit description

When designing a complete preamplifier circuit to accommodate a large range of signals from different sources, the output voltage to be fed to the main amplifier must normally be of the same value irrespective of which source is being used. The preamplifier must therefore provide different sensitivities for different sources as well as providing any equalization appropriate to a particular input. Many preamplifier circuits therefore use a single amplifier with passive input and feedback networks switched into circuit to meet the requirements of a given source. The circuit shown is of this type and uses a single integrated-circuit operational amplifier as the active block although a discrete transistor version could also be used. The operational amplifier is connected as a voltage

Typical performance

IC: 741
 Supplies: $\pm 15V$
 Transformer: AKG 0204
 R_1, R_2 : $150k\Omega$; R_3 : $47k\Omega$
 R_4, R_5 : $470k\Omega$;
 R_6 : $8.2k\Omega$; R_7 : 120Ω
 R_8 : $560k\Omega$; R_9 : $47k\Omega$
 R_{10} : 120Ω ; R_{11} : $1.2k\Omega$
 R_{12} : 820Ω
 C_1 : $22\mu F$ tantalum

C_2 : $5.6nF$; C_3 : $1.8\mu F$

Sensitivities:

For $350mV$ output at
 $1kHz$
 mic: $3.5mV$
 piezo: $308mV$
 mag: $4.82mV$
 tape: $310mV$
 tuner: $141mV$

follower with gain where the gain is defined by the feedback network components. Connected in this manner, the amplifier offers a basically high input impedance at its non-inverting input which can be reduced as far as the source is concerned by inserting suitable passive input networks where necessary. The amplifier shown accepts input signals from any one of five sources, viz magnetic microphone, piezo pickup, magnetic pickup, tape replay amplifier and a radio tuner. The amplifier was designed to give an output of $350mV$ at $1kHz$ giving, at this frequency, gains for the above inputs of approximately: 100 ; 1.15 ; 86.5 ; 1.15 and 2.47 respectively, with R_{12} chosen as a fixed value to simplify the switching arrangement. Components R_8, R_9, C_2 and C_3 provide an RIAA equalization when using the magnetic pickup input and R_3 was chosen to load the cartridge with $47k\Omega$.

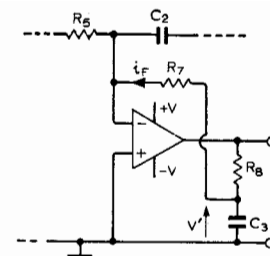
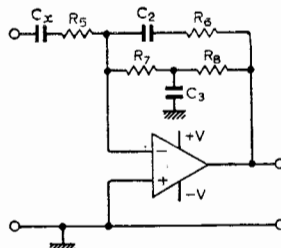
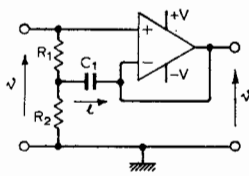

Component changes

Useful range of supplies: ± 3 to ± 18 V.

To make resonant peak occur below 10Hz with $C_1 = 22\mu\text{F}$ use $R_1 = R_2 = 180\text{k}\Omega$ for $C_x = 400\text{pF}$ and $R_1 = R_2 = 120\text{k}\Omega$ for $C_x = 1\text{nF}$.

Ratio R_3/R_4 may be adjusted to give desired gain.

Lower values of R_3 and R_4 make gain less dependent on C_1 , R_1 and R_2 .

Screened wire between cartridge and amplifier reduces gain and resonant peak frequency e.g. 1 metre of separately-screened pair (136pF/m) reduces mid-band gain by about 1.6dB and f_o from 88Hz to 78Hz.

Circuit modifications

The circuit shown centre demonstrates a method of obtaining a flat amplitude response by making the time constant $C_x R_5$ and $C_2 R_6$ equal, where C_x is the capacitance of the piezo-electric cartridge. With $R_6 = kR_5$ and $C_2 = C_x/k$ the gain of the amplifier is given by: $G = (kR_5 - jk/\omega C_x)/(R_5 - j/\omega C_x) = k$. Resistive loading of the cartridge is determined by R_5 which should not be less than about $1\text{M}\Omega$. The d.c. negative feedback provided by R_7 and R_8 will not significantly affect the response of the amplifier provided that R_7 and R_8 are both very much greater than R_6 and that C_3 adequately decouples them throughout the audio band. Incorrect choice of component values can again lead to a resonant peak at

some low audio frequency, but as its Q is not high it could be used to give a degree of bass boost if desired.

To see this effect, refer to circuit on right where $V' = V_{\text{out}}/(1 + j\omega C_3 R_8)$ and $i_F = V'/R_7$. Hence the equivalent impedance (Z_{eq}) of the d.c. feedback network is given by $Z_{\text{eq}} = V_{\text{out}}/i_F = R_7(1 + j\omega C_3 R_8)$. Thus, Z_{eq} contains an equivalent inductance $L' = C_3 R_7 R_8$. This inductance will resonate with C_2 (with which it is in parallel) at a frequency $f'_o = 1/2\pi C_2 C_3 R_7 R_8$ Hz. To demonstrate this effect, component values were chosen as: $A: 741$; $C_x: 1.5\text{nF}$; $R_5: 1\text{k}\Omega$; $R_6: 1.5\text{k}\Omega$; $C_2: 1\text{nF}$; $R_7, R_8: 10\text{k}\Omega$; $C_3: 22\mu\text{F}$ and the resonant peak found to occur at 108Hz compared with a predicted f'_o of 107Hz.

Further reading

Evans, J. H. and Williams, P., Modular integrated circuit audio mixer, *Wireless World*, Dec. 1972, pp.564-70.

Burrows, B. J. C., Ceramic pickups and transistor pre-amplifiers, *Wireless World*, 1970, pp.56-60

Earl, J., How to Choose Pickups and Loudspeakers, Fountain Press, 1971.

A preamplifier for use with crystal and ceramic pickups, Design Note 14, SGS-Fairchild, 1965.

Walton, J., Pickups—the Key to Hi-Fi, 2nd ed. Pitman, 1965.

© 1973 IPC Business Press Ltd.

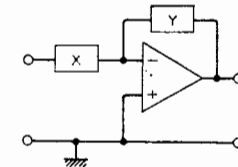
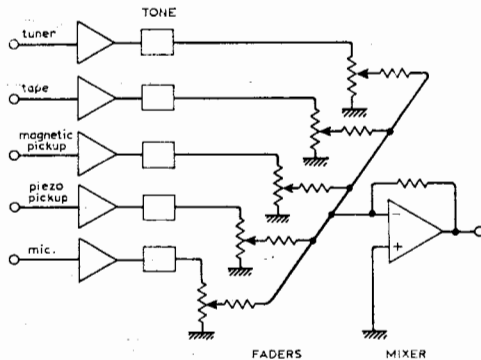

Circuit description

Useful range of supplies: ± 3 to ± 18 V.

741 operational amplifier may be replaced by a 748 or 301 using a 30-pF compensation capacitor. Break-before-make switches could be replaced by make-before-break types to prevent sudden changes causing annoying clicks in the loudspeaker.

C_4 and C_5 may be included to roll off the flat response at high frequencies. The C_4 to R_{10} network could be changed to provide additional gain and the correct equalization when the preamplifier is fed directly from a tape head instead of from a tape replay amplifier.

Circuit description

● A resistor of the order of $10\text{k}\Omega$ may be taken from the output of the preamplifier to supply a tape recorder.

● A disadvantage of the switched-network type of pre-amplifier is that only one signal source may be used at any

given time. If each source is provided with a separate and appropriate preamplifier, any or all the inputs can be fed to a following mixer stage via faders making the system more flexible. Further versatility can be obtained by inserting a separate tone control circuit between the preamplifier and fader of each channel as shown in diagram left.

● As the various input sockets must be physically separated to some extent, the provision of a separate preamplifier for each source is useful as it can be placed in close proximity to its input socket in an attempt to reduce noise and hum pick-up.

● Diagram right shows a preamplifier using the see-saw configuration where networks X and Y are designed to provide the desired gain and equalization for a particular source, the networks again being introduced by switches.

Further reading

Evans, J. H. & Williams, P., Modular integrated circuit audio mixer, *Wireless World*, Dec. 1972, pp.564-70.

Linsley Hood, J. L., Modular pre-amplifier design, *Wireless World*, vol. 75 1969, pp.306-10.

High Fidelity Audio Designs, Ferranti Ltd 1967.

Thorig, J., High-quality pre-amplifier, *Mullard Technical Communications*, vol. 11, 1970, pp.153-5.

Cross references

Series 5, cards 1, 4, 5, 8 & 11.

© 1973 IPC Business Press Ltd.