

Understanding Interference-Type Noise

How to Deal with Noise without Black Magic

There Are Rational Explanations for — and Solutions to — Noise Problems

by Alan Rich

If the circuit doesn't work, add a decoupling capacitor anywhere—a $0.01\mu\text{F}$ ceramic disc, of course; they'll fix anything! Or when your circuit is broadcasting its noise, a shield will cure it; just wrap a piece of metal around the circuit, connect that shield to "ground," and watch the noise disappear!

Unfortunately, Nature is not that kind to us in real life. That $0.01\mu\text{F}$ disc you added only increased the noise; and the shield you added was totally ineffective—or, worse yet, the noise reappeared in a remote part of the circuit.

This article is the first of a two-part series to help you understand and deal effectively with interference noise in electronic systems. We will consider here the mechanism that causes noise to be picked up, since the first step in solving any noise problem is to identify the source of the noise and the coupling mechanism; only then can an effective solution be implemented.

The second article will suggest specific techniques and guidelines for effective shielding against electrostatic and magnetically coupled noise.*

WHAT KIND OF NOISE ARE WE TALKING ABOUT?

Any electronic system contains many sources of noise. Three basic forms in which it appears are: *transmitted noise*, received with the original signal and indistinguishable from it, *intrinsic noise*, (such as thermally generated Johnson noise, shot noise, and popcorn noise) originating within the devices that constitute a circuit, and *interference noise*, picked up from outside the circuit. This last may either be due to natural disturbances (e.g., lightning) or be coupled in from other electrical apparatus in the system or its vicinity, for example computers, switching power supplies, SCR controlled heaters, radio transmitters, switch contacts, etc.

This article will consider only the last category, man-made noise, the most pervasive form of system noise in data-acquisition or test systems. Although it is most annoying in low-level circuits, no part of the system is immune to it. But it is the only form of noise that can be influenced by choices of wiring and shielding.

ASSUMPTIONS AND ANALYTICAL TOOLS

Although Maxwell's equations—with all the mathematical agony that they imply—are necessary for a complete and accurate description of how electrical systems behave, conventional circuit

*Another helpful and relevant article that appeared in these pages was "Analog Signal Handling for High Speed and Accuracy," by A. Paul Brokaw, *Analog Dialogue* 11-2, 1977, pp. 10-16.

analysis is a useful tool in most cases. The assumptions that permit circuit analysis to be valid in solving these problems are:

1. All electric fields are confined to the interior of capacitors.
2. All magnetic fields are confined to the immediate vicinity of inductors.
3. Dimensions of the circuits are small compared to the wavelengths under consideration.

Using these assumptions, we can model noise-coupling channels as lumped circuit elements. A magnetic field coupling two conductors is modeled as a mutual inductance. Stray capacitance can be modeled as two conductors with an electric field between them. Figure 1 shows an equivalent circuit of a situation where two short wires are adjacent to one another over a system ground.

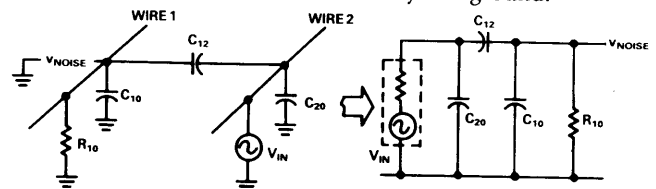

Figure 1. Noise-equivalent circuit of two adjacent wires and a ground plane.

Once the complete noise equivalent-circuit is obtained for a system, the problem becomes one of solving network equations for a desired parameter. All standard linear circuit analysis techniques can be applied, including node equations, loop equations, matrix algebra, state variables, superposition, Laplace transforms, etc. When circuits exceed 5 or 6 nodes, manual calculation becomes difficult; at this point, computer-aided programs, such as SPICE, and other CAD techniques become necessary. Experienced designers can make appropriate simplifying assumptions; but their validity should always remain in question until proven.

The lumped-element approach will not always give an accurate numerical answer, but it will show clearly how noise depends on system parameters. Just the act of drawing a reasonably faithful equivalent circuit may offer clues to methods to reduce noise levels. Once network equations or CAD programs are written, the quantitative effects of noise-suppression techniques can be studied.

In spite of all the modern technical advances, such as microprocessors and switching power supplies, wires still have resistance and inductance, capacitance still exists in the real world, and such phenomena must be reckoned with.

THE BASIC PRINCIPLE

There are always three elements involved in a noise problem: a *noise source* (line transients, relays, magnetic fields, etc.), a

coupling medium (capacitance, mutual inductance, wire), and a receiver, a circuit that is susceptible to the noise (Figure 2).

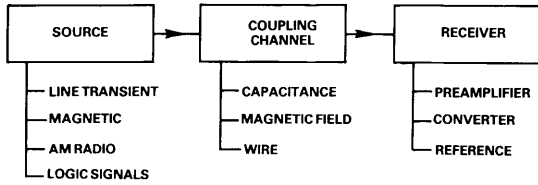

Figure 2. Noise pickup always involves a source, a coupling medium, and a receiver.

To solve the problem, one or more of these three elements must be removed, reduced, or diverted. Their role in the problem must be thoroughly understood before the problem can be solved. If the solution is inappropriate, it may only make the noise problem worse! Different noise problems require different solutions; adding a capacitor or a shield will not solve every such problem.

TYPES OF SYSTEM NOISE

Noise in any electronic system can originate at a large number of sources, including computers, fans, power supplies, adjacent equipment, test devices; noise sources can even include improperly connected shields and ground wires that were intended to combat noise. Our discussion of noise sources and coupling mechanisms will include the following topics:

- Common-impedance noise
- Capacitively coupled noise
- Magnetically coupled noise
- Power-line transients
- Miscellaneous noise sources

Common-Impedance Noise. As the name implies, common-impedance noise is developed by an impedance that is common to several circuits. Figure 3 shows the basic configuration, which might occur when a pulse output source and an op amp's reference terminal are both connected to a "ground" point having tangible impedance to the power-supply return terminal. The noise current (the noisy return current of Circuit 1) will develop across impedance, Z , a voltage, V_{noise} , which will appear as a noise signal to Circuit 2.

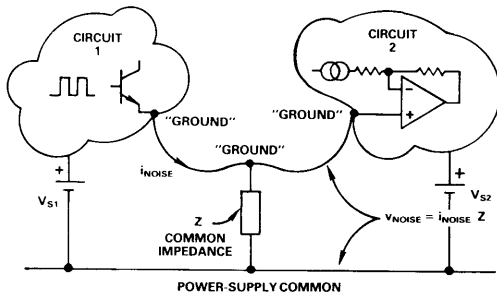

Figure 3. How noise is developed by a common circuit impedance.

Typically, this type of noise has a repetition rate that is set by the rate of the noise source. The actual waveshape is determined by the characteristics of the impedance, Z . For example, if Z is purely resistive, the noise voltage will be proportional to the noise current and of similar shape (Figure 4a). If Z is an R-L-C, the noise voltage will ring at a frequency, $1/(2\pi\sqrt{LC})$ and decay exponentially at a rate set by L/R (b).

If noise of this kind is found in a circuit, its origin may be readily deduced from the repetition rate and waveshape. The *repetition rate* will point to the source of noise, since the noise and its source are synchronized. For example, a noise waveform like that shown

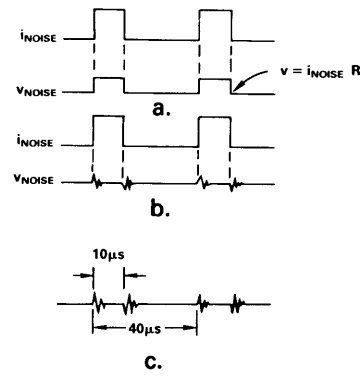

Figure 4. Noise effects in a common impedance. (a) Resistance. (b) An R-L-C circuit. (c) Switching-supply noise response.

in (c), at a 25kHz repetition rate and a 25% duty cycle, might be typical of a switching power supply containing a regulating loop using pulse-width modulation.

The *waveshape* will help identify the impedance that is actually generating the undesired noise. If, for example, the waveform of the noise is the simple damped sinusoid shown in Figure 5, the following features allow us to deduce the nature of Z :

- A constant resistance, R , is in series with the line. The voltage change, V_1 , is the product of R and a current step, I_1 .
- The natural frequency of the oscillation, f_1 , is determined by the series L and shunt C , $f = 1/(2\pi\sqrt{LC})$.
- The damping time constant, τ , is determined by L/R .

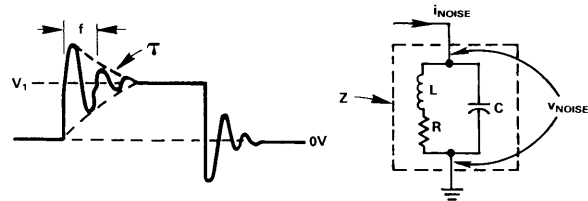

Figure 5 Waveshape for an underdamped R-L-C circuit.

Capacitively Coupled Noise. Noise is also produced by capacitive coupling from a noise source to another circuit. This type of noise is often seen when signals with fast rise-and-fall times or high frequency content are in close proximity to high-impedance circuits. Stray capacitance couples the fast edges of the signal into adjacent circuits, as the circuit model of Figure 6 shows. The nature of the impedance, Z , determines the shape of the response. Typical capacitances are listed in Table 1.

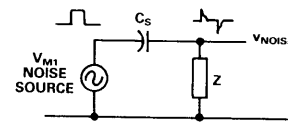

Figure 6. Stray capacitance couples noise into high-impedance circuits.

Capacitive pickup can occur in many ways, shapes, and sizes. Here are a few examples:

- A TTL digital signal produces fast edges, with a typical rise time of 10 nanoseconds and voltage swings of 5 volts. If Z is a 1-megohm resistor, even 0.1pF will produce 5-volt spikes with decay time constants of 100 nanoseconds.
- Crosstalk may result between two adjacent wires. For example, if two wires in a 10-foot (3-meter) length of cable have a capacitance of 40 pF/ft, the total capacitance is 400 pF. If a test voltage

of 10 V at 1 kHz is on one conductor, 250 mV at 1 kHz will be coupled into the adjacent wire if Z is a 10 k resistance.

•Noise on the ac power line, developed through common impedances, will couple into other circuits. A common case is when transients couple through the interwinding capacitance of power-supply transformers.

Table 1. Typical capacitances.¹

Condition	Capacitance
Human standing on an insulator to earth	700 pF
Power input (ac) to output (dc) of ±15-V dc supply	100 pF
Two-conductor shielded cable:	
Conductor to conductor	40 pF/ft
Conductor to shield	65 pF/ft
RG58 coaxial cable, center conductor to shield	33 pF/ft
Connector, pin to pin	2 pF
Optical isolator, LED to photodetector	2 pF
½-watt resistor (end to end)	1.5 pF

It is amazing how little capacitance can cause serious problems. For example, consider the situation where high noise-immunity CMOS logic is used in an industrial circuit where 2500-volt, 1.5 MHz noise transients (IEEE Standard 472-1974) are present. Suppose that stray capacitance of only 0.1 pF exists between a CMOS input and the noise source, as shown in Figure 7. The calculated noise voltage, V_c , will be 2.4 volts, steady state, with an initial 50-V transient, which will cause improper logic operation or worse!

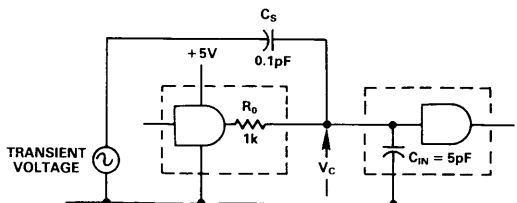

Figure 7. Coupling of high-voltage transients from test generator to logic.

Magnetically Coupled Noise. Strong magnetic fields are found where cables carry current, where ac power is distributed, and near machinery, power transformers, fans, etc. There is an analogous relationship between circuits coupled magnetically and those coupled capacitively, as shown in Figure 8 and Table 2.

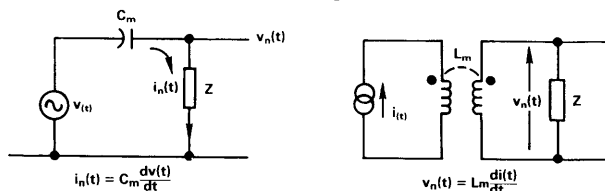

Figure 8. Comparison of magnetic and capacitive noise coupling.

Table 2. Characteristics of capacitive and magnetic coupling.

	Capacitive Coupling	Magnetic Coupling
Noise Source	Voltage change (dV/dt)	Current change (dI/dt)
Coupling Medium	Mutual capacitance	Mutual inductance
Coupled Noise	Current (frequently converted to voltage by Z)	Voltage

This analogy helps us consider some differences between capacitively and magnetically coupled noise:

•When the noise is magnetically coupled, voltage noise (V_n) appears in series with the receiver circuit; in the capacitive situation,

¹Sources: Excerpts from Ralph Morrison, *Grounding and Shielding Techniques in Instrumentation*, Second Edition (New York: John Wiley & Sons, 1977), p.30, and actual measurements.

the voltage noise produced between the receiver and ground is the voltage in Z caused by the noise current, i_n .

•Reducing the receiver impedance, Z, will reduce capacitively coupled noise. This is not the case in magnetically coupled circuits; lowering Z will not dramatically reduce voltage noise.

The voltage, V_n , induced in a closed loop (single turn) by a magnetic field is given by

$$V_n = 2\pi fBA \cos\theta \times 10^{-8} \quad (1)$$

volts, where f is the frequency of the sinusoidally varying flux density, B is the rms value of the flux density (gauss), A is the area of the closed loop (cm^2), and θ is the angle of B to area A.

For example, consider the circuit of Figure 9. It shows the calculation for two one-foot conductors, separated by 1 inch, in a 10-gauss 60-Hz magnetic field (typical of fans, power wiring, transformers). The maximum voltage induced in the wires is 3 mV.

$$V_n = (2\pi \times 60)(10)(12 \times 2.54)(1 \times 2.54)10^{-8} \text{ FOR } \theta = 0^\circ$$

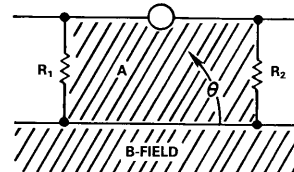

Figure 9. Example demonstrating magnitude of magnetic pickup.

The equation tells us that the noise voltage can be reduced by reducing B, A, or $\cos\theta$. The B term can be reduced by increasing the distance from the source of the field or—if the field is caused by currents flowing through nearby pairs of wires—twisting those wires to reduce the net field to zero by alternating its direction.

The loop area, A, can be reduced by placing the conductors closer together. For example, if the conductors in the example were placed 0.1" apart (separated only by insulation), the noise voltage would be reduced to 0.3mV. If they can be twisted together, the area is, in effect, reduced to small positive and negative increments that cancel, practically nullifying the magnetic pickup.

The $\cos\theta$ term can be reduced by proper orientation of the receiving wires to the field. For example, if the conductors were perpendicular to the field, the pickup would be minimized, while if they were run together in the same cable ($\theta = 0$), pickup would be maximized.

The rms induced voltage, V_n , in a conductor in parallel with a second conductor, carrying a current I_2 at an angular frequency $\omega = 2\pi f$, with a given mutual inductance, M, is

$$V_n = \omega M I_2 \quad (2)$$

The application of this relationship shown in Figure 10 illustrates why only one end of a shield should be grounded. A 100-ft length of shielded cable is used to carry a high-level low-impedance signal

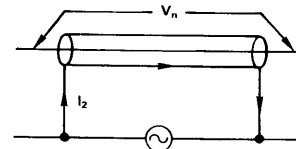

Figure 10. Magnetic pickup from current flowing through a cable shield.

(10V) to a 12-bit data-acquisition system (1 LSB = 2.4 mV). The shield, which has series resistance of 0.01 ohms per foot and mutual inductance to the conductor of 0.6μH/ft, has been grounded at both the source and the destination. A potential of 1 volt at

60 Hz exists between the two ground points, causing a current of 1 ampere to flow in the 1-ohm total resistance of the shield. By (2), the noise voltage induced in the conductor is

$$V_n = (2\pi 60 \text{ Hz})(100 \times 0.6 \times 10^{-6} \text{ H})(1 \text{ A}) \\ = 23 \text{ mV},$$

or 10 LSBs, thereby reducing the effective resolution of the system to less than 9 bits. This noise voltage is a direct consequence of the large current flowing in the shield because it is grounded at both ends. And the 1-volt potential assumed between the grounds was conservative! In heavy-industry environments, 10 to 50 volts between earth grounds is not uncommon.

Power-Line Transients. Another type of system noise is that generated by high-voltage transients in inductive circuits, such as relays, solenoids, and motors, when they are turned on and off. When devices having high self-inductance are turned off, the collapsing fields can generate transients of the order of kilovolts, with frequencies from 0.1 to 3 megahertz, that appear on the power line.

Besides creating noise in sensitive circuitry, via capacitive and conductive coupling and radiated energy, these transients are hazardous to equipment and people. Standards exist to characterize certain transient waveforms for the purpose of protection; however, besides being designed to withstand them, systems should also be designed to deal with their potential interference with signals. Figure 11 shows 4 typical waveforms existing in industry standards.

Miscellaneous Noise Sources Finally, there is a group of noise sources that can be considered as miscellaneous—or just “flakey.”

For low-level signals at high impedance, the cable itself can become a noise source. A charge can be produced on the dielectric material within the cable; if the dielectric does not maintain contact with the conductors, this charge will act as a noise source within the cable, unless the cable can be kept rigid. This noise is highly dependent on any motion of the cable; noise levels of 5 to 100 mV were reported by Belden Corporation. Noise of similar character (5 to 25 mV) was observed in the laboratory for RG188 coaxial cable, as it was moved and flexed.

Another type of motion-related noise occurs when a cable is moved through a magnetic field. Voltage will be induced in the cable as the cable cuts fixed flux lines or the flux density, B , changes. This kind of noise is troublesome in a high-vibration environment, where the cables can be in rapid motion. If the cable can be kept from vibrating relative to the field, this noise will not occur.

Finally, if instrumentation is operating in close proximity to a radio or television station, signals may be picked up from the transmissions. In addition to AM, FM, and television transmitters, the RFI may come from CB radios, amateur radios, walkie-talkies, paging systems, etc. High-frequency noise should be considered as a possible source of mysterious drifts in dc circuitry, due to rectification of picked-up rf; investigations of drift should always be conducted with a wideband oscilloscope.

SUMMARY

We have described here the different types of interference noise that will exist in any electronic system. Table 3 lists the noise sources discussed above and some effective approaches to solving the pickup problem. It is important to understand the complete noise system (source, coupling medium, receiver, and relationships) before noise-reduction techniques are employed.

Noise reduction is not a mystical job for wizards; it is a practical and analytical job for engineers. Needless to say, the most effective approach is *prevention*—applying noise-reduction analysis and minimization techniques *before the system is built*.

In part 2 of this article, we will describe the proper application of shielding and guarding techniques for noise reduction.

Further Reading:

Ralph Morrison, *op. cit.*

Henry W. Ott, *Noise Reduction Techniques in Electronic Systems* (New York: John Wiley & Sons, 1976).

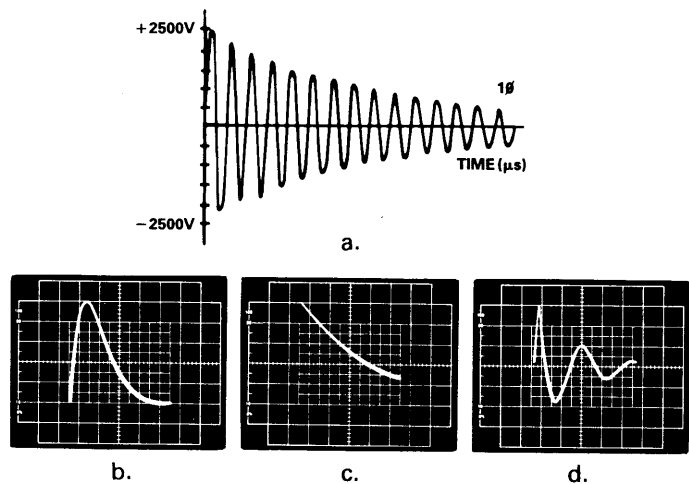

Courtesy of Key Tek Instrument Corp., Burlington, MA

Figure 11. Examples of transients existing in standards for industrial power-line equipment. (a) IEEE Standard 472-1974 “Guide for Surge Withstand Capability.” (b) Impulse wave, 8×20 , 1000V peak, $5\mu\text{s}/\text{div}$. (c) Impulse wave, 10×1000 , 1500V peak, $0.2\text{ms}/\text{div}$. (d) 100kHz ac surge, 6kV peak (500kHz leading edge); successive peaks down by 40% ($1\text{kV}/\text{div}$, $2\mu\text{s}/\text{div}$).

Table 3. Noise sources and possible solutions.

Common-Impedance Noise

- Proper circuits for distributing power
- Isolation transformers, optical isolators, analog isolators
- Shielding of sensitive circuits

Capacitively Coupled Noise

- Reducing noise sources
- Properly implemented shields (very effective)
- Reducing stray capacitance

Magnetically Coupled Noise

- Careful routing of wiring
- High-permeability (mumetal) shields (the most effective)
- Reducing area of receiver circuit (twisted pairs, physical wire placement)
- Reducing the noise source (twisted pairs, driven shields to cancel field)

Power-Line Transients

- Coil suppression on relays, solenoids, etc.
- Zero-crossing turnoff for relays, solenoids, etc.
- Shielding
- Reducing stray capacitance

Miscellaneous

- Rigid wiring
- Low-noise cable
- Shielding from RFI source