

CLASS G

High Efficiency HI-FI

Amplifier

A new high-efficiency audio amplifier circuit that can reduce the size, weight and cost of future hi-fi amplifiers. Here's an inside look at the theory and circuitry



SOME TIME AGO, THE AUDIO INDUSTRY WAS startled by the announcement that Infinity Systems, Inc. (best known for their loud-speaker systems) had come up with a more efficient way to build audio power amplifiers. They called the technique "Class D" amplification. Briefly, the system involves the use of high-frequency (in excess of 200 kHz) pulses that are first modulated by the audio signal to be amplified and then decoded by an integrating circuit that restores the audio envelope or waveshape. Since the duty cycle of each high-frequency pulse is relatively short, conduction of the output transistors is such that heat dissipation is a fraction of that encountered with more conventional Class-B circuits and overall efficiency (at least when the amplifier delivers close to its maximum power output) is high. Thus far, the product has not reached the consumer market but Infinity claims that all production problems have been licked and that the Class D, or "switching" amplifier will soon be a commercial reality.

In the meanwhile, other companies have been working on improving the efficiency of audio amplifiers. This work is so widespread, in fact, that the Hitachi Company of Japan (whose approach to better amplifier efficiency is the subject of this article) has had to change the name of their invention from Class E (which they had first proposed to use) all the way to Class G, the designation they currently plan to assign to the new and innovative circuitry we will describe here.

Class-B efficiency

When a Class-B audio amplifier delivers its maximum rated power, its efficiency (power delivered to the load divided by power used by the amplifier) is quite high—70% or more. Studies show, however, that under music listening conditions, an

LEN FELDMAN*
CONTRIBUTING HI-FI EDITOR

audio amplifier is called upon to deliver full or nearly full output for only a very small fraction of the time it is operating. Figure 1 represents the results of studies

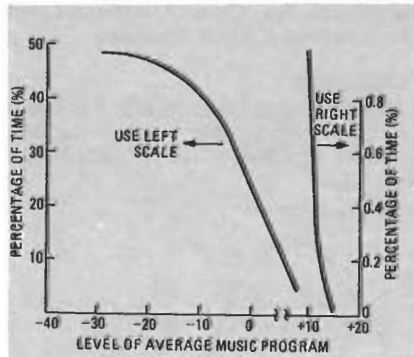

FIG. 1—AVERAGE MUSIC PROGRAM LEVEL expressed in terms of percentage of total time at which that level exists.

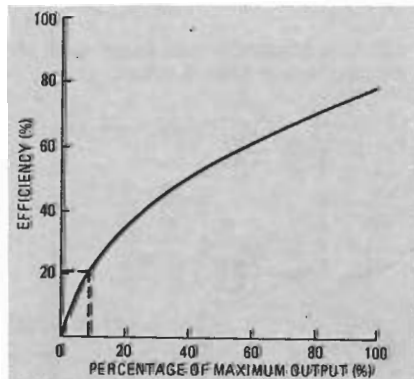

FIG. 2—CLASS-B EFFICIENCY at various percentages of maximum output.

of a variety of musical selections. It shows that while music may reach peaks of +14 dB (referred to a 0-dB average power level), for much of the time, actual power levels are even well below the 0-dB average level. In fact, for nearly 50% of the time (Fig. 1; left vertical scale), power levels are some 30-dB below the 0-dB point, while a +10-dB level is reached for only 0.7% (Fig. 1, right hand vertical scale) of the time. Even allowing for highly compressed music (in which dynamic range is restricted and music is therefore more uniformly "loud") and assuming only a 10-dB crest-factor (average power is 10% of peak power), we can see from the curve of Fig. 2 (efficiency of a Class-B circuit versus the ratio of actual output to designed maximum output) that for most of the time that an amplifier of this type is reproducing music, it is operating at approximately 20% efficiency.

The Class-G idea

Hitachi's invention is designed to enable amplifiers to operate more efficiently over more of their operating range, based upon the way in which they are called upon to actually amplify musical signals. The simple diagram of Fig. 3 illustrates the Class-G idea. The input voltage, V_{in} , is the signal to be amplified and it is ap-

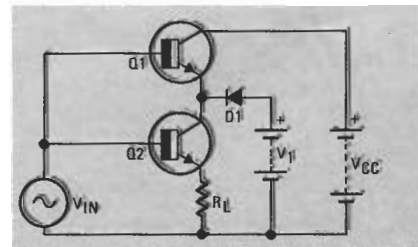

FIG. 3—BASIC CLASS-G amplifier.

plied to the base of transistors Q1 and Q2. A load resistor, R_L , is connected to the emitter of Q1. Supply voltage V_1 is applied through diode D1 to the collector of Q1 and the emitter of Q2. The collector of Q2 is connected to a second supply voltage V_{cc} that is higher than supply voltage V_1 .

Operation of the circuit is as follows: If input signal voltage V_{in} is lower than V_1 , Q2 is reverse biased between its base and its emitter and is therefore cut off. Current flowing through load R_L is supplied from V_1 through diode D1. Under these conditions, the instantaneous efficiency of the circuit is given as: Efficiency (%) = V_{in}/V_1 . If the signal voltage increases to a value beyond that of V_1 (but less than V_{cc}), transistor Q2 becomes forward biased and is turned on. Current flowing through load R_L is now supplied from the second, higher supply-voltage V_{cc} through Q2. If we neglect saturation voltage between collector and emitter of Q2 (assuming it is sufficiently low), the instantaneous efficiency of the circuit is given as: Efficiency (%) = V_{in}/V_{cc} .

Figure 4 represents the two efficiency

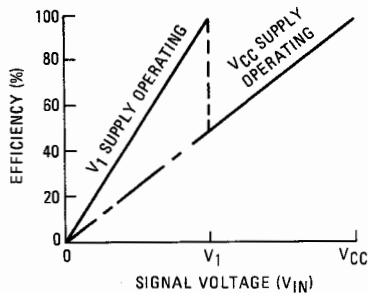

FIG. 4—INCREASED EFFICIENCY results from two-level power-supply system in Class-G amplifier.

levels of the system and the vertical line represents the point at which the supply voltage transition takes place. Thus, in the lower ranges of input signal voltage, the efficiency of this circuit is improved considerably and the amount of heat generated in the output transistor is reduced compared with conventional Class-B amplifiers. Referring once more to Fig. 3, it should be noted that diode D1 also serves to prevent current flowing from the higher supply-voltage source (V_{cc}) from flowing back into the first power source V_1 .

The thermal efficiency of the system will, of course, depend upon the choice of the two power-supply operating voltages.

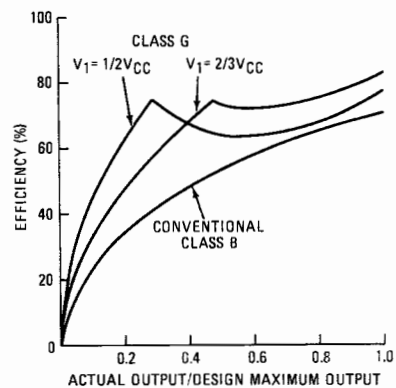

FIG. 5—EFFICIENCY OF CLASS-G amplifier depends upon V_1/V_{cc} ratio.

Figure 5 compares the efficiency level at various outputs (expressed as a fraction of maximum design output) for two different Class-G designs having different V_1/V_{cc} ratios as compared with conventional Class-B operation. Regardless of whether V_1 is half or two thirds as great as V_{cc} , we see that efficiency is far greater than that of Class-B operation, particularly at lower output levels where, as we have seen earlier, the amplifier is likely to operate most of the time when reproducing actual music programs.

Along with improvement in efficiency comes reduced internal heat dissipation of the output devices used in the Class-G approach. Figure 6 illustrates this point for

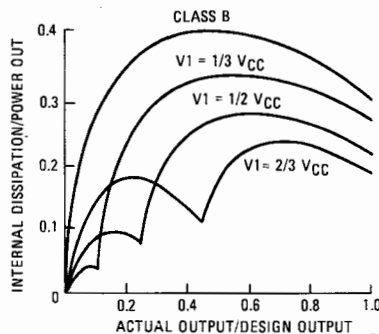

FIG. 6—HEAT DISSIPATION for various V_1/V_{cc} ratios.

various V_1/V_{cc} ratios. Internal dissipation is plotted as a fraction of maximum power output on the vertical axis, while the ratio of output power to designed maximum power is shown along the horizontal axis of the graph. As expected, internal dissipation is lower at all operating conditions for Class-G compared with conventional Class-B operation.

Distortion

Closer examination of Fig. 3 points up certain problems that exist in the basic concept of Class G. In the simple form

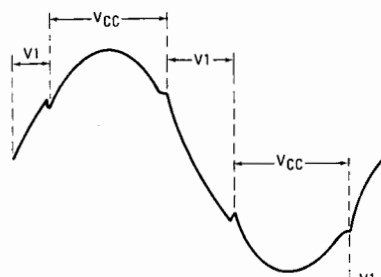

FIG. 7—DISTORTION that would result from simplest form of Class-G circuit.

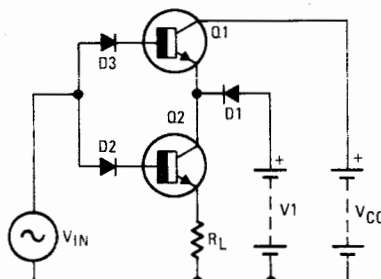

FIG. 8—SWITCHOVER DISTORTION is reduced by the addition of diode D2.

of the circuit shown, Q2 is not turned on until input signal voltage exceeds the collector voltage of Q1 by an amount equal to the base-emitter voltage V_{be} of Q2. Thus, when the value of input signal voltage V_{in} is in the range between V_1 and $V_1 + V_{be}$, Q1 is already saturated (between collector and emitter) before conduction of Q2 begins. This results in a distorted output waveform signal as shown in Fig. 7.

To prevent this form of distortion during the changeover from one power supply level to the other, the circuit must be modified so that saturation of Q1 does not occur until Q2 is turned on. This is accomplished by adding another diode, D2, as shown in the simplified schematic of Fig. 8. Now, when V_1 is less than the input signal, the voltage between the collector and the emitter of Q1 is lower than the saturation level by an amount equal to the threshold value of D2 and thus Q1 remains unsaturated. Diode D2 may be a Zener diode or even a resistor since it is only required to maintain a voltage difference equal to the V_{be} voltage of Q2. Still another diode, D3, is added to the basic circuit as shown in Fig. 7. Since a reverse bias is applied between the base and emitter of Q2 when the signal voltage is lower than supply voltage V_1 , the base-emitter junction of Q2 must be able to stand a reverse voltage higher than V_1 . Since the maximum inverse voltage of the base-emitter circuit of most transistors is generally low, diode D3 is provided to prevent the flow of reverse current through the base-emitter junction of Q2, thus protecting this junction against the reverse voltage.

Push-Pull operation

Figure 9 shows the required configura-

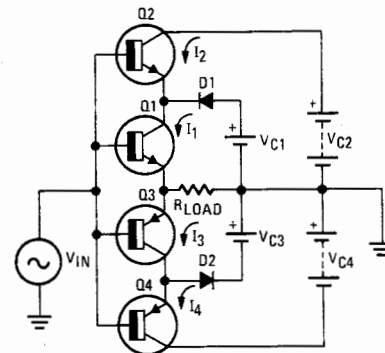

FIG. 9—PUSH-PULL Class-G amplifier.

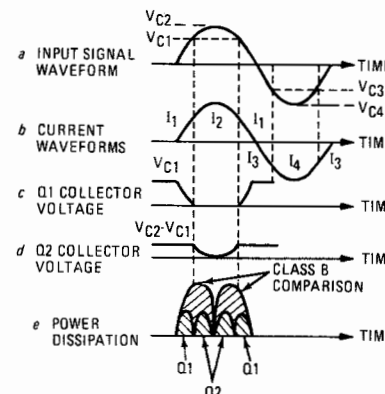

FIG. 10—VOLTAGE AND CURRENT relationships in push-pull Class-G amplifier.

tion for a push-pull output circuit. Diodes D2 and D3 shown in Fig. 8 have been omitted for the sake of clarity. Two values of positive and negative supply voltages are required and transistors Q3 and Q4 operate at opposite polarity voltages compared with Q1 and Q2 to form the familiar complementary configuration (NPN and PNP pairs are used). Fig. 10-a shows the input signal waveform, together with the voltage levels V_{C1} and V_{C2} (for the first half of the cycle) and V_{C3} and V_{C4} for the opposite half of the signal waveform. Fig. 10-b shows the current waveforms resulting from the four supply-voltages (two voltages for each polarity). Fig. 10-c represents that portion of the output waveform powered by the lower-level supply voltage V_{C1} , while Fig. 10-d shows the contribution of output waveform powered by the higher supply voltage V_{C2} . Finally, Fig. 10-e shows a comparison of power losses (or dissipation) in Q1 and Q2 (for the half cycle shown) as compared with the power loss that would take place in a conventional Class-B configuration.

Practical Class-G circuit

The first product which Hitachi intends to introduce that will incorporate the Class-G principle is their Model SR-903 AM/FM stereo receiver, pictured in Fig. 11. By way of illustrating the improvement

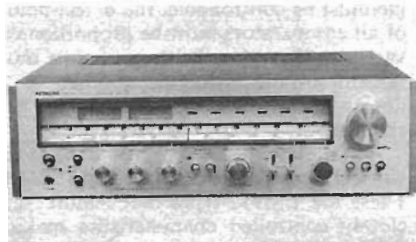

FIG. 11—HITACHI SR-903 stereo receiver uses Class-G output circuit.

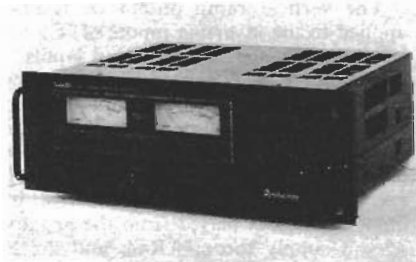

FIG. 12—HITACHI HMA-8300 power amplifier will be introduced in the near future and will contain Class-G output circuitry.

in efficiency attained because of this new output circuit, Dr. Gentaro Miyazaki of Hitachi Consumer Products Research Center was kind enough to supply me with some advance comparisons between this 75 watts-per-channel receiver (from 20-Hz to 20-kHz, 8-ohm loads, 0.3% maximum THD) and a typical Class-B unit having the same FTC power rating. The SR-903 will weigh in at 28.7 lbs as against 40.8 lbs for the Class-B unit. Under "music power" measurement conditions (abandoned by the industry since the advent of the FTC power rule, but nevertheless indicative of the short-term power output capability of an amplifier), the SR-903 will deliver 160 watts-per-channel

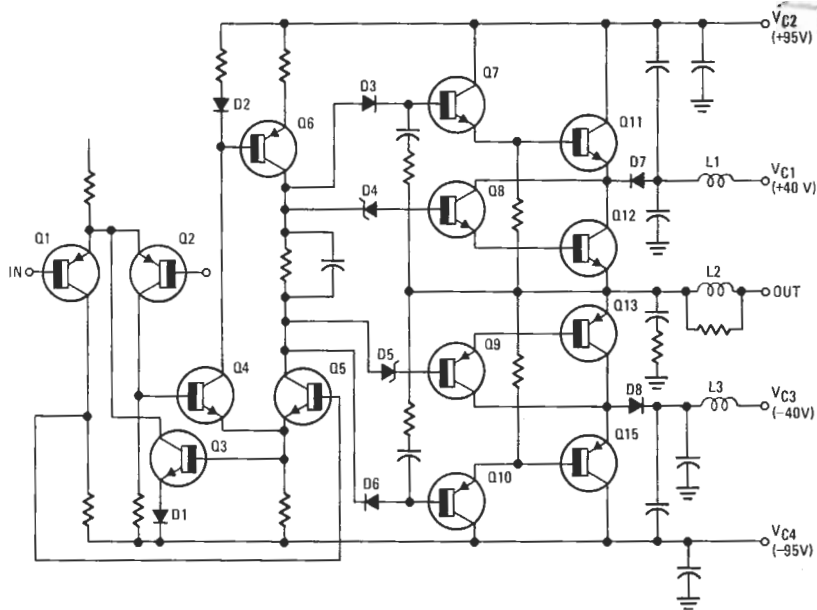

FIG. 13—OUTPUT CIRCUIT of the Hitachi HMA-8300 power amplifier.

Hitachi plans to introduce many more units employing Class-G circuitry. Typical of these will be the stereo power amplifier, model HMA-8300, pictured in Fig. 12. A circuit of the power output stages of this unit is shown in the schematic diagram of Fig. 13. In addition to the circuit elements already described, we see one more refinement that should be mentioned. Note, that in series with supply voltages V_{C1} and V_{C3} are small inductors L1 and L3. Because transistors have finite turn-on and turn-off times, a form of distortion can be introduced to the output waveform as illustrated in the waveforms of Fig. 14. This form of distortion is due to an effect known as storage time-delay and is quite independent of the base-emitter V_{be} voltage discussed earlier. To counteract this effect (and to further reduce output waveform distortion in Class-G circuits), a coil is added in series with diode D6 shown in the improved circuit of Fig. 15.

The effect of storage delay would be

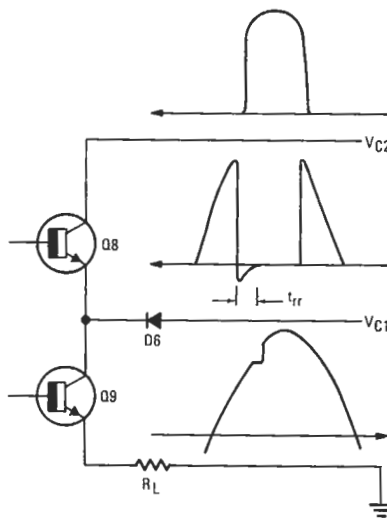

FIG. 14—DISTORTION resulting from storage time delay in Class-G circuit.

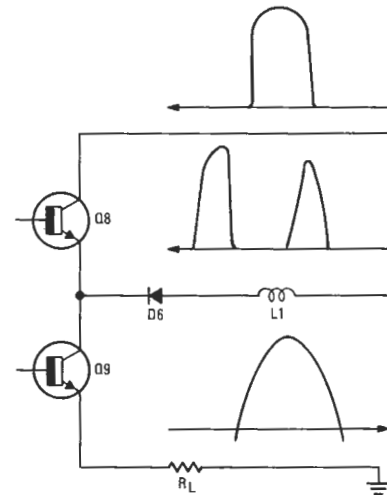

FIG. 15—DISTORTION resulting from storage time delay is reduced by the addition of L1 to circuit.

as opposed to 110 watts-per-channel for the Class-B unit against which it was compared.

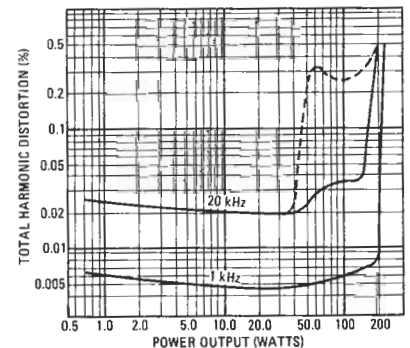

FIG. 16—THD VS. POWER OUTPUT at 20-kHz before and after addition of L1 (Fig. 15) in circuit. Distortion characteristic at 1-kHz is also shown.

particularly noticeable when reproducing high frequencies, since the time required for amplification of a single cycle of a 20 kHz signal is only 50 microseconds. The curves of distortion versus output measured at 1 kHz and 20 kHz for a typical Class-G circuit shows clearly that without

(continued on page 87)