

# Project 471

## High performance stereo preamp control unit

Phil Wait

This project is designed to complement our 60 watt low distortion amplifier module and forms part of a complete stereo system, our "Series 4000" project — to be described in a forthcoming issue.

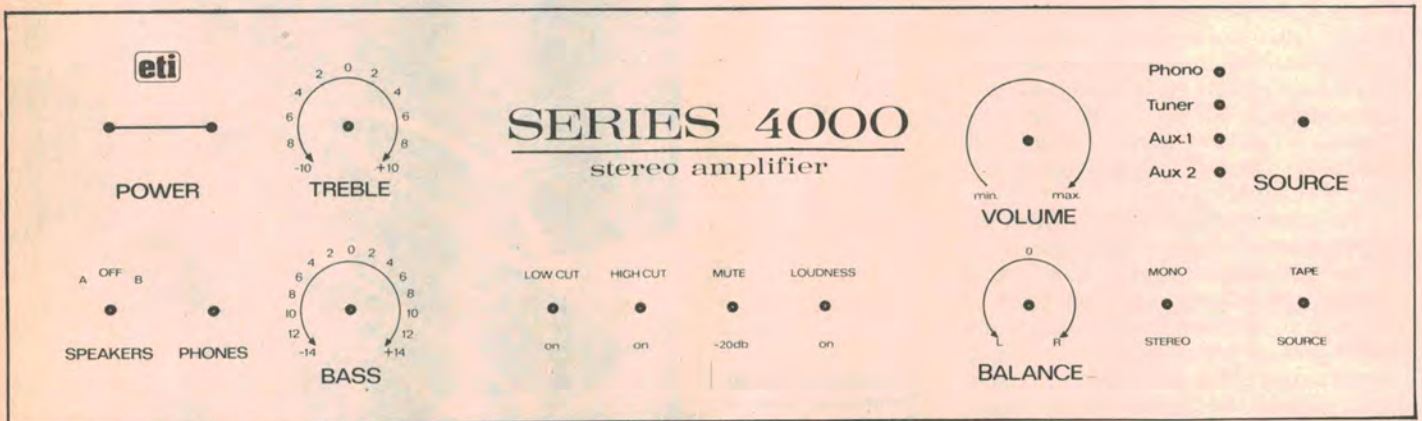

THIS stereo preamplifier is designed to drive two 60 watt, low distortion amplifier modules (ETI 470), described last month.

The requirements for this preamplifier/control unit were set down after many hours of office discussion. In fact it would be fair to say that the final design was evolved, rather than conceived.

Amongst the first requirements were low hum and noise and low distortion — much lower distortion than the amplifier modules it would be required to drive. Low distortion in a preamplifier is relatively easy to achieve and makes the subsequent addition of a high quality class A headphone amplifier worthwhile.

In the final design, we feel we have achieved performance figures well up front amongst commercial equipment.

Features considered essential included loudness, high cut and low cut filters. These are common in commercial preamp/control units but lacking on most kit designs. The low cut filter incorporated in our design will effectively reduce bass rumble while the high cut filter is useful for reducing tape hiss or 'monkey chatter' and heterodynes from an AM tuner.

The disc amplifier stage of a preamp must be capable of handling very high input signals before clipping to preserve

dynamic range, especially as moving coil cartridges with voltage boosting transformers and/or amplifiers are finding increasing popularity. The disc input of this design can handle 400 mV peak-to-peak before clipping, giving it a dynamic range in excess of 100 dB!

Finally, and by far the most difficult of our requirements to implement, was the idea that all switches and potentiometers be mounted directly onto the pc board, with as few links and external leads as possible. All this, while preserving an attractive and stylish front panel layout! The advantage of this is that assembly is easy, and straightforward and there is less room for wiring errors to creep in and, should it be necessary, the board can be removed for servicing in its complete, functional form. All interconnections to and from the board are via RCA sockets using standard audio 'jumper' leads.

The 60 watt power amplifier module and this preamp/control unit project form the basis of our "Series 4000" high performance stereo amplifier project, complete details of which we plan to present next issue.

### Construction

All the components, including the pots, switches and LEDs, are mounted onto the pc board. The board is then fixed,

component side forward, behind the mounting panel of the case using standard 25 mm spacers and countersunk screws. A dummy fascia — with the control markings etc on it, is subsequently held in place by the switch nuts.

If all directions are followed, then construction is quite straightforward — it's easier to do than describe!

Firstly, the mounting panel and fascia must be cut and drilled to the dimensions shown on the drawing (unless you have bought a kit, in which case this may already be done). The drilled pc board may be used as a template. Dimensions shown in brackets refer to the fascia panel which must be cut slightly smaller if you wish to use the same case for your stereo as we have.

The holes for the pot shafts are only 7 mm in diameter on the fascia panel to ensure correct knob alignment. Countersunk holes are drilled in the mounting panel, but not in the fascia, for the bolts securing the pc board through the spacers.

Once the mounting panel and fascia are drilled, carefully check the alignment of all holes with the corresponding holes in the pc board. The drilling must be reasonably accurate.

### ETI 471 – STEREO PREAMPLIFIER SPECIFICATIONS (Measured on prototype)

<b>Distortion</b> . . . . .	0.015% at 1 kHz 0.015% at 10 kHz (For all inputs, with 500 mV RMS output – distortion is mainly 2nd harmonic).	<b>Output</b> . . . . .	7 V p-p before clipping
<b>Hum and Noise</b> . . . . .	.83 dB unweighted (With respect to 10 mV phono input).	<b>Tape output</b> . . . . .	150 mV RMS
<b>Frequency Response</b> . . . . .	Phono: Within 0.5 dB of RIAA from 20 Hz to 20 kHz (Follows new IEC curve).  Other inputs: 20 Hz to 20 kHz $\pm$ 0.5 dB  Subsonic rolloff: 6 dB/octave below 20 Hz	<b>Sensitivity</b> . . . . .	For 500 mV RMS output phono: 3 mV RMS other: 150 mV RMS (Phono overload level is 400 mV p-p).
		<b>Tone controls</b> . . . . .	Bass: $\pm$ 13 dB at 50 Hz Treble: $\pm$ 11 dB at 10 kHz
		<b>Filters</b> . . . . .	High: 6 dB/octave, –3 dB at 5 kHz Low: 6 dB/octave, –3 dB at 100 Hz
		<b>Loudness</b> . . . . .	.8 dB boost at 15 kHz and 10 kHz.
		<b>Mute switch</b> . . . . .	.20 dB attenuation

Once this mechanical work is completed the components may be mounted on the pc board. Start with the RCA sockets. Take care not to use too much force on the nuts and check that electrical contact has been made to the earth plane of the pcb using an ohm-meter. Join the centre pin of the RCA sockets to the pc board pads using lengths of tinned copper wire – refer to the overlay.

Mount the potentiometers next so that their terminals are directly above the pads on the pc board. The lower pot terminals can be cut, bent down and soldered directly onto the pads. Connect the upper pot terminals to the pc board, as shown in the overlay, using tinned copper wire.

Either of two types of rotary switch may be used for the source selector. We have specified a C & K pc-mounting

type but a standard rotary wafer switch may be used instead. The C & K switch mounts directly onto the pc board. If a standard rotary switch is used it will bolt to the front panel of the case and is wired in as detailed shortly.

Once the major parts are assembled onto the pc board, all the minor components may be loaded and soldered in place. Make sure that any large components (electrolytics particularly) are less than 25 mm high, otherwise they will foul the front panel. Check that all transistors, tantalums and electrolytics are correctly oriented. Refer to the overlay as you proceed.

The switches and LEDs must be mounted and spaced correctly off the pc board. Solder 50 mm lengths of tinned copper wire onto each of the switch terminals and LED leads (see illustration). Pass the wires through the

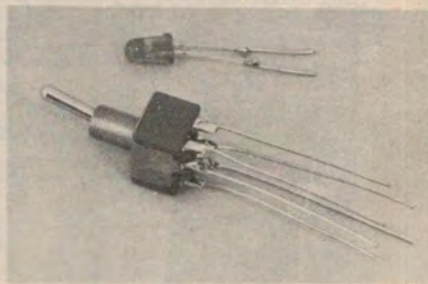

Above: The switches and LEDs have lengths of wire soldered on to them so that they can be inserted into the pcb before being attached to the front panel. They can then be soldered in place. This procedure ensures that there is no strain on the joints. Below: the completed unit. Full details of metalwork will be given in a later article, in which we will describe how to use this preamp with two of the ETI 470 60W units to build a high-performance, low cost stereo amplifier.

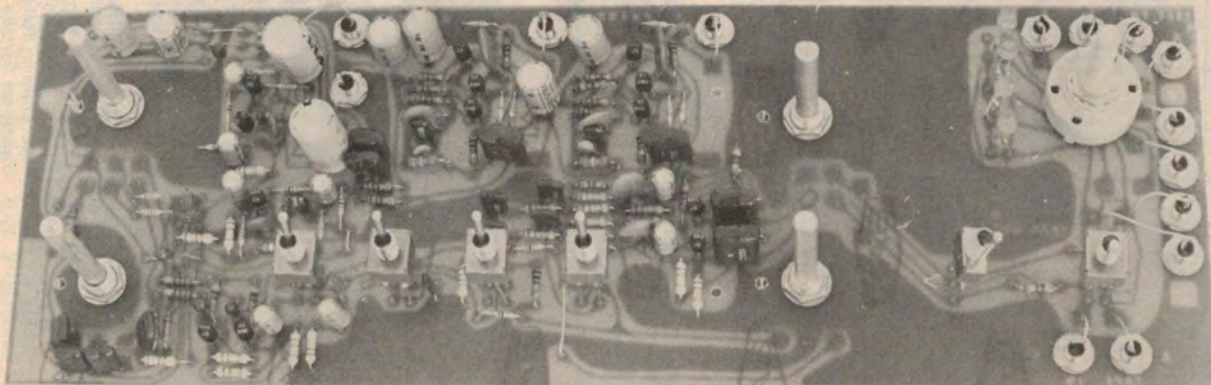

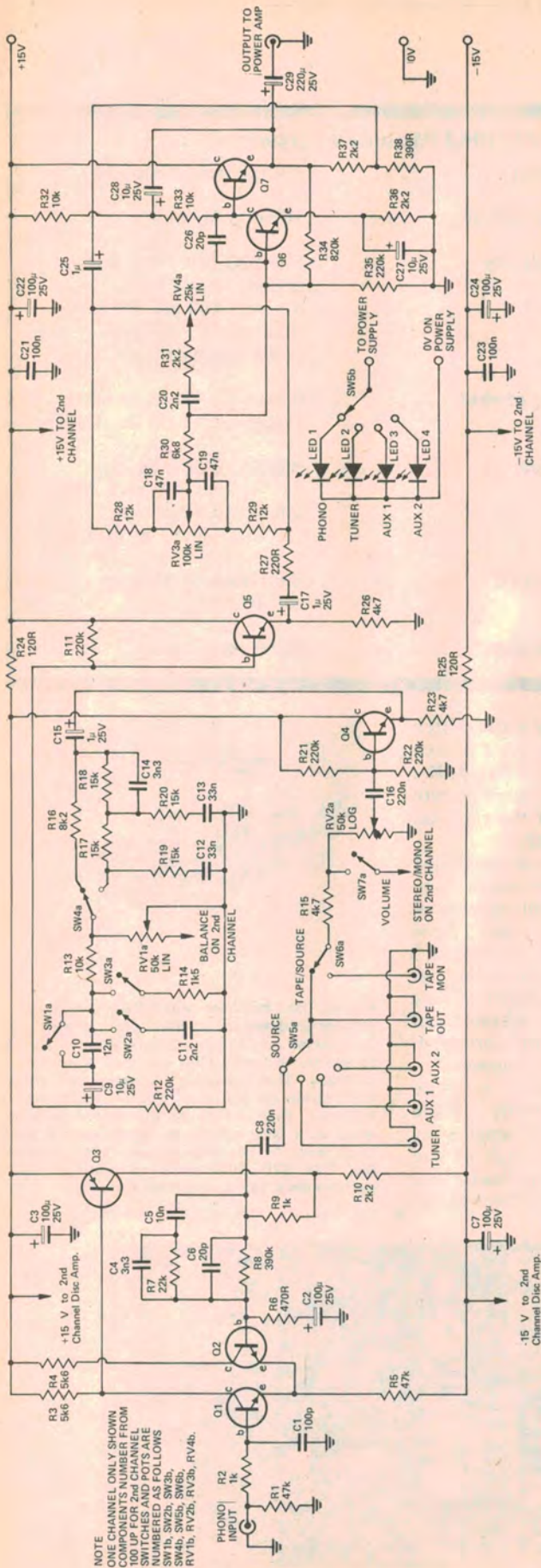

NOTE  
ONE CHANNEL ONLY SHOWN  
COMPONENTS NUMBERED FROM  
100 UP FOR 2nd CHANNEL  
AND 200 UP FOR 3rd CHANNEL  
AND 300 UP FOR 4th CHANNEL  
SW1b, SW2b, SW3b, SW4b,  
SW5b, SW6b, SW7b, RV1b,  
RV2b, RV3b, RV4b.

Fig. 1. Preamplifier circuit diagram. Only one channel has been shown for clarity. The component numbering of the other channel begins at 101.

The signal from a magnetic cartridge is fed to the base of Q1 via a low pass filter, (R2 and C1) for attenuation of radio frequencies. Q1 and Q2 form a differential pair, each half operating at low collector current to minimise noise. The output of the differential pair is taken from the collector of Q1 and further amplified by Q3. Feedback is taken to the base of Q2, the negative input of the differential pair, through the RIAA equalisation network. Overall gain of the phono stage is set by the ratio of the feedback network impedance to the value of R6.

Subsonic bass roll-off of 6 dB/octave, to conform to the new IEC 65 specification, is achieved by a high pass filter consisting of C8 and RV2.

Output from the disc preamplifier is then fed via the Source Switch (SW5), Tape-Source switch (SW6), R15 and the volume control (RV2), to an emitter follower, Q4. This emitter follower presents a high impedance for the aux inputs and a constant impedance for driving the filters.

### HOW IT WORKS - ETI 471

When switched in, the loudness network boosts the high and low frequencies with respect to the midrange. In actual fact, all frequencies are attenuated but the midrange is attenuated more. When the loudness is switched out, R16 approximates the impedance of the network.

Muting is achieved by switching R14 to earth. The ratio of R14 to R13 sets the attenuation to 20 dB. C11 shunts high frequencies to earth for high cut, while C10 reduces low frequency content when switched in, providing low cut.

A second emitter follower, Q5, presents a constant impedance to the filters and acts as a low impedance source to the tone control stage.

A Baxandall tone stage is used here, a common circuit in many designs. Q6 is a gain stage with a bootstrapped collector load, via C28, to the output. Bootstrapping increases the gain by increasing the effective collection load impedance. Q7 is an emitter follower connected directly to the collector of Q6. This provides a very low output impedance. DC bias for Q6 is

taken from the output.

Some of the output signal is fed back to the tone controls and split into high and low frequencies by RV3 and RV4. By adjusting the controls the percentage of the input to the negative feedback signal appearing at the base of Q6 can be varied, thereby varying the overall gain of the amplifier at either high or low frequencies. The gain of the tone stage is set by the ratio of R37 to R38. As R38 is reduced in value the negative feedback is reduced and therefore the overall gain is increased.

To preserve the very low output impedance of the pre-amplifier the balance control is placed ahead of, rather than after, the tone stage.

Power supply filtering and decoupling is provided by 100  $\mu$ F capacitors and resistors in each rail.

Source indication is by LEDs from the spare section of the source switch. No current limiting resistor is on the pc board for the LEDs as one will be included in the power supply. (To be described).

corresponding pc board holes for these components but do not solder them in the right way round.

Assemble the pc board onto the case mounting panel (using the 25 mm spacers and countersunk screws). Place the fascia over the front panel, securing it in place with the switch nuts (three hands and a prehensile nose might help! ... a little sticky tape and deft juggling is all that's really necessary). Once you've got it all together the protruding wires may be soldered to the pc board. Ensure that no short circuits have occurred.

That completes the assembly. For servicing purposes the pc board and all switches, LEDs and pots - all the operating controls - may be removed simply by undoing several nuts, removing the fascia and the countersunk screws beneath.

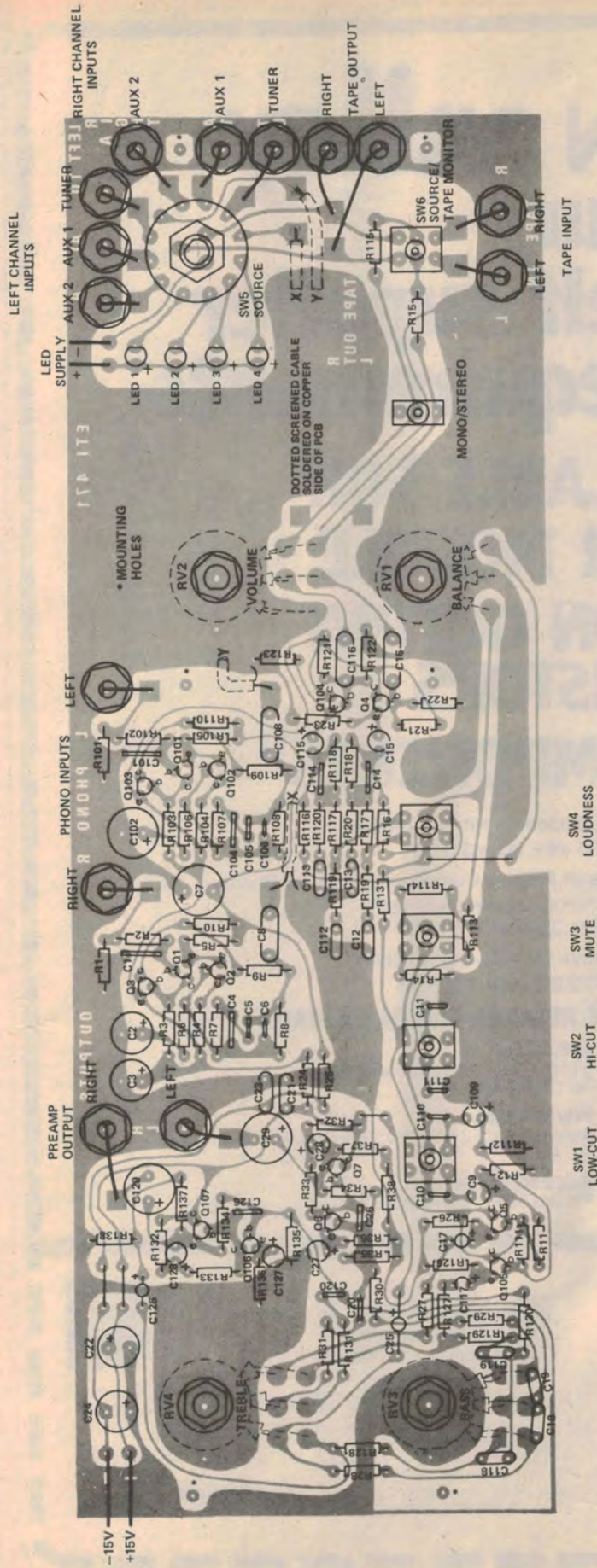

Fig. 2. Component overlay. Note that lengths of shielded cable are used to connect the outputs of the disc preamplifiers to the selector switch.

### PARTS LIST - ETI 471

#### Resistors

- all 1/4W 5%
- R1, R101 . . . 47k
  - R2, R102 . . . 1k
  - R3, R4, R103, . . . 5k6
  - R5, R105 . . . 47k
  - R6, R106 . . . 470R
  - R7, R107 . . . 22k
  - R8, R108 . . . 390k
  - R9, R109 . . . 1k
  - R10, R110 . . . 2k2
  - R11, R12, . . . 220k
  - R13, R113 . . . 10k
  - R14, R114 . . . 1k5
  - R15, R115 . . . 4k7
  - R16, R116 . . . 8k2
  - R17 - R20, . . . 15k
  - R21, R22, . . . 220k
  - R121, R122 . . . 4k7
  - R23, R123 . . . 4k7
  - R24, R25 . . . 120R
  - R26, R126 . . . 4k7

- R27, R127 . . . 220R
- R28, R29, . . . 12k
- R30, R130 . . . 6k8
- R31, R131 . . . 2k2
- R32, R33, . . . 10k
- R132, R133 . . . 820k
- R34, R134 . . . 220k
- R35, R135 . . . 220k
- R36, R37, . . . 2k2
- R136, R137 . . . 390R
- R38, R138 . . . 390R

#### Potentiometers

- RV1 . . . . . 50k single linear
- RV2 . . . . . 50k dual log
- RV3 . . . . . 100k dual linear
- RV4 . . . . . 25k dual linear

#### Capacitors

- C1, C101, . . . 100p ceramic
- C2, C3, C102 . . . 100µ 25V electro
- C4, C104 . . . 3n3 greencap
- C5, C105 . . . 10n greencap

- C6, C106 . . . 20p ceramic
- C7 . . . . . 100µ 25V electro
- C8, C108 . . . 220n greencap
- C9, C109 . . . 10µ 25V electro
- C10, C110 . . . 12n greencap
- C11, C111 . . . 2n2 greencap
- C12, C13, . . . 33n greencap
- C14, C114 . . . 3n3 greencap
- C15, C115 . . . 1µ 25V tantalum
- C16, C116 . . . 220n greencap
- C17, C117 . . . 1µ 25V tantalum
- C18, C19, . . . 47n greencap
- C118, C119 . . . 2n2 greencap
- C20, C120 . . . 100n greencap
- C21 . . . . . 100µ 25V electro
- C22 . . . . . 100n greencap
- C23 . . . . . 100µ 25V electro
- C24 . . . . . 100µ 25V electro
- C25, C125 . . . 1µ 25V tantalum
- C26, C126 . . . 20p ceramic
- C27, C28, . . . 10µ 25V electro
- C127, C128 . . . 220µ 25V electro
- C29, C129 . . . 220µ 25V electro

#### Semiconductors

- Q1, Q2 . . . BC549, DS549, BC109
- Q101, Q102 . . . BC559, DS559, BC179
- Q3, Q103 . . . BC549, DS549, BC109
- Q4-Q7, Q104 -Q107 . . . (see text)

#### LED1-LED4 . TIL220R or sim LED's

Switches . . . . . (see text)

- SW1-SW4 . . . DpDT min toggle switch
- SW5 . . . . . 3 pole 4 pos rotary switch
- SW6 . . . . . DpDT min toggle switch
- SW7 . . . . . spdt min toggle switch

#### Miscellaneous

- 14 RCA panel mounting single hole sockets, ETI 471 pcb, tinned copper wire, length shielded cable, 25 mm spacers, 30 mm screws, nuts, mounting panel and fascia plate.

# Project 471

## Power Supply

The preamplifier/control unit is capable of giving extremely good performance — but only with a good power supply. The supply should be well regulated and filtered for noise, especially if zener regulation is used.

Next month we will be publishing a suitable power supply design which will provide dc for both the 4000 preamplifier and two of the 60 W modules described last month.

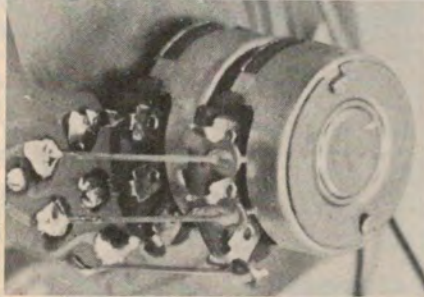

Potentiometer connections to the pcb are made via lengths of tinned copper wire.

## Further Suggestions

We have designed this preamplifier to use commonly available components. However, some constructors or kit suppliers may wish to improve the appearance and the ease of construction of the project. One way of doing this is to use different switches.

The SOURCE switch which we suggest is a C & K Lorlin three-pole, four position pc mounting rotary switch. If only wire terminal models

Rear view of the assembled preamp, showing how the potentiometers and shielded cables are mounted. Note the use of pc mounting phono sockets for ease of assembly.



are available, the eyelets can be cut off and the switch mounted as if it were a pc mounting model.

C & K toggle switches may be used for the other switch functions. These are available on order with 'paddle' levers and 25 mm wire wrap terminals. The switches make the preamp look very professional and can also be directly mounted onto the pcb.

The appearance of the LEDs can be improved by using C & K Cliplite covers. These are available in a variety of colours.

C & K switches are available from:

Radio Despatch Service,  
869 George Street,  
Sydney 2000

George Brown,  
174 Paramatta Road,  
Camperdown, NSW

JES Electronic Components,  
13 Melrose Street,  
Sandringham, VIC

C & K Electronics,  
2/6 McFarlane Street,  
Merrylands, NSW

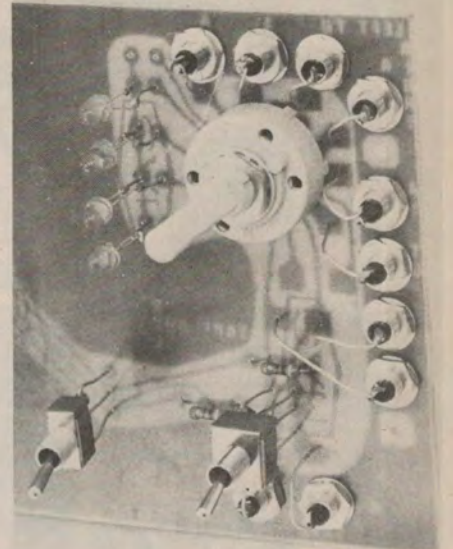

This photo shows how the input sockets are wired into the pcb.



### HOLES MARKED

- A - 6mm
- B - 4.5mm
- C - 3mm COUNTERSUNK
- D - 10mm
- E - 7mm

### HOLE SIZES IN BRACKETS ARE FOR FACIA PANEL ONLY

FOR HEIGHT OF FACIA PANEL TRIM 4mm FROM TOP AND BOTTOM OF FRONT PANEL DIMENSION. (AS INDICATED BY DOTTED LINE.)

ALL DIMENSIONS ARE IN MILLIMETRES

DO NOT SCALE DRAWING