

Hi-fi Wireless Head

2.4 GHz digital audio link

Christian Tavernier (France)

Although they've been on the shelves of audio and video equipment retailers for quite a few years now, wireless headsets have been conspicuously absent from hobby electronics magazines. It has to be said that building this sort of headset, especially if we set ourselves a certain level of quality, is far from simple — or rather, *was* far from simple, until these recently-brought-out modules came along to help us out.



Thanks to three new modules marketed by the Aurel company, it's now possible not just to build a wireless headset, but also to give it a level of performance that would make most commercial products green with envy. Before we go into greater detail at the end of the article, we can tell you right away that our headset offers distortion as low as 0.016% at 1 kHz and a signal-to-noise ratio of 75 dB; these are figures actually measured on the Elektor prototype between the transmitter input and the receiver headphone output socket, i.e. including the radio link; the connoisseurs will appreciate this!

Overview

Our wireless headset obviously consists of two separate elements: a transmitter designed to be connected to any audio or video source (CD or DVD

player, TV, stereo, etc.) and a receiver to which you can connect any headphones you like. It's worth choosing very high quality ones, given the performance of the transmitter/receiver combination. The project can also be used just as a wireless audio link without a headset. Several systems can be used at the same time, so you could, for example, build a wireless 5.1 surround system.

In the field of wireless headsets, there are currently two competing technologies: infrared and radio link. As far as we are concerned, and given the spec of these Aurel modules, we opted for the radio link, operating here in the 2.4 GHz band, on frequencies that are of course legally authorized in most countries.

Construction is extremely simple, easily within the capacities of any ama-

teur who know how to hold a soldering iron (by the right end!)

The Aurel 2.4 GHz audio modules

Intended to gradually supersede Aurel's earlier TX FM audio and RX FM audio modules, these three new modules enable a leap forward in terms of quality. These are genuine digital audio modules, i.e. the LF signals are converted to digital at the transmitter. They are then transmitted in digital form, making them immune to the distortion and noise that affect analogue radio transmissions, to be converted back to analogue in the receiver.

On the transmitter side, there are two different modules, the TX-AUDIO-2.4 and the more recent TX-AUDIO-2.4/AE. In terms of performance, the two modules are virtually equivalent, and our project can use either equally well. The

set



Technical specifications

(transmitter/receiver distance: 0.5 m)

Frequency response: 18.5 kHz

Distortion THD + N: 0.009 % (100 Hz, B = 22 kHz)
0.016 % (1 Hz, B = 22 kHz)
0.06 % (10 kHz, B = 22 kHz)
0.36 % (10 kHz, B = 80 kHz)

SNR: 75 dB (B = 22 kHz)
82 dBA

L/R separation: 78 dB (1 kHz)
57 dB (20 kHz)

Receiver

Min. supply: +7.5 V / -3.5 V (negative voltage for 2 Vrms output)

Current consumption: +97 mA / -16 mA

Max. output voltage: 5.7 V

Output impedance: 100 Ω

Balance control attenuation (at centre): 3.5 dB

Transmitter

Min. supply voltage: 6 V

Current consumption: 72 mA

Max. input voltage: 1.92 V

Input impedance: 32 k Ω (20 k Ω at module input)

Frequencies:

2.3979 GHz (OB closed, CH open, power on)
2.4096 GHz (SW0/1/2 = open/open/open, CH closed)
2.4186 GHz (SW0/1/2 = closed/open/open, CH closed)
2.4276 GHz (SW0/1/2 = open/closed/open, CH closed)
2.4368 GHz (SW0/1/2 = on/on/open, CH closed)
2.4458 GHz (SW0/1/2 = open/open/closed, CH closed)
2.4548 GHz (SW0/1/2 = closed/open/open, CH closed)
2.4639 GHz (SW0/1/2 = open/closed/closed, CH closed)
2.4728 GHz (SW0/1/2 = closed/closed/closed, CH closed)
2.4458 GHz (CH open)

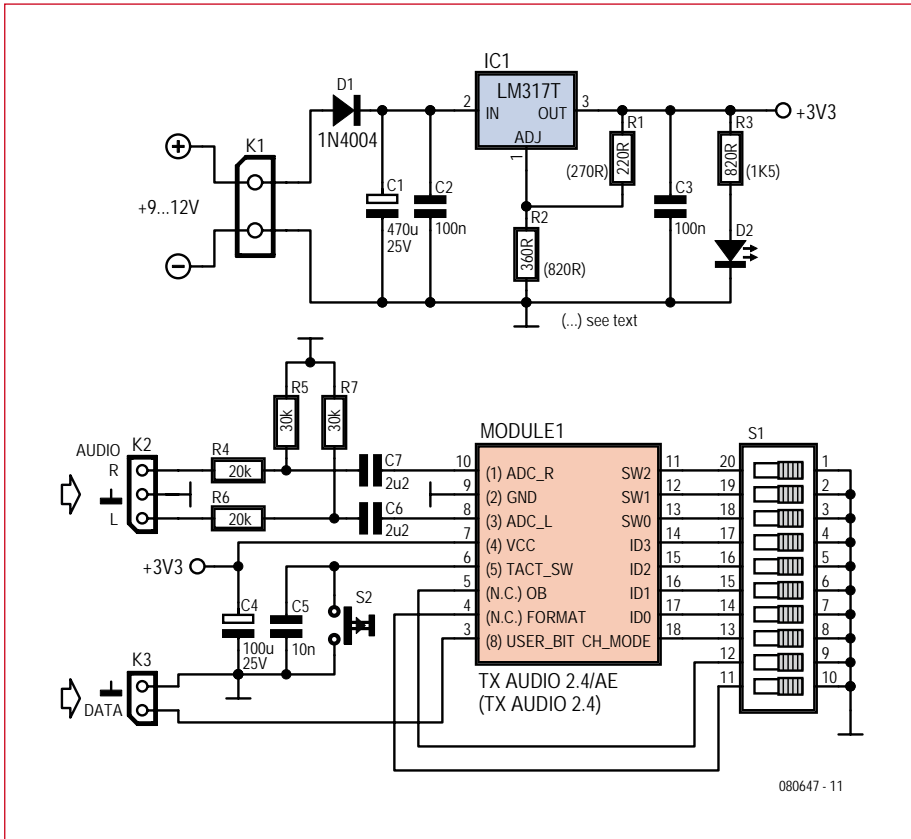

Figure 1. Transmitter circuit. If you use the 2.4 module, make sure you use the values in brackets for R1, R2, and R3.

only 'visible' differences are the channel select system, which is a little more comprehensive on the -AE model, and the pin-outs, which are not quite identical. In addition, both modules also let you transmit digital data at 5 kbit/s along with the audio signal.

The principal specifications of all these module are given in **Tables 1 and 2**.

Transmitter circuit

Given the high level of integration of the Aurel transmitter modules, the circuit for our project is extremely simple, as you can see in **Figure 1**.

Powering is entrusted to a 'plug-top' mains unit that needs to provide a DC voltage between 7.5 V and 10 V at 120 mA minimum. This voltage doesn't need to be stabilized, as it is stabilized in the transmitter by IC1, an LM317 whose output voltage is defined by the ratio of resistors R1 and R2. This slightly complicated power supply arrangement was necessary because Aurel has had the 'bright' idea of powering the 2.4 module at 5 V and the 2.4/AE at 3.3 V. Use the values of R1, R2, and R3 in brackets for the 2.4 module.

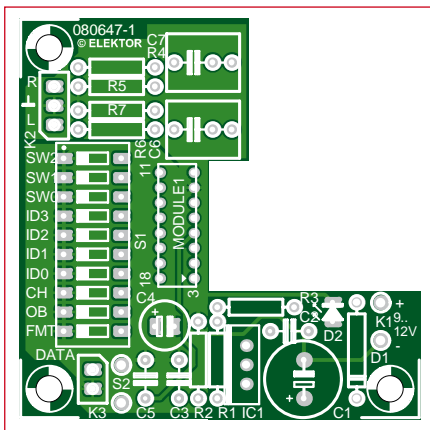
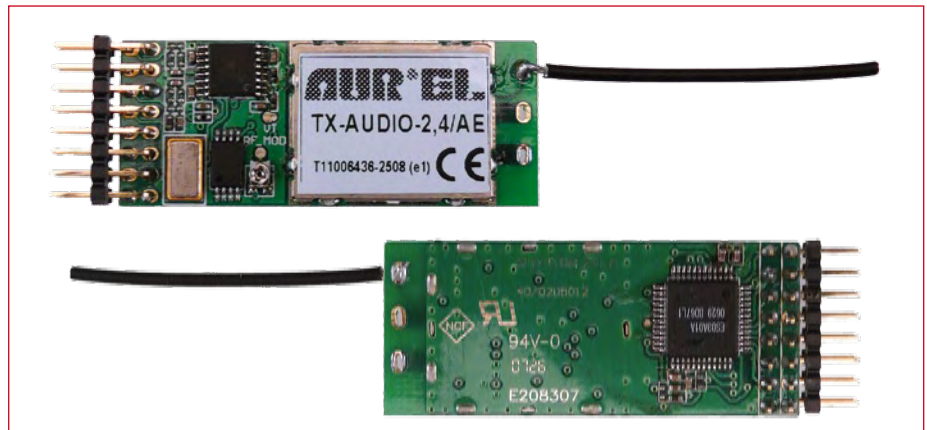

Figure 2. Transmitter circuit board.



Transmitter

COMPONENTS LIST transmitter

Resistors

0.5 or 0.25 watt, metal film, 5%

- R1 = 220Ω (270Ω for 2.4 module)
- R2 = 360Ω (E96: 357Ω) (820Ω for 2.4 module)
- R3 = 820Ω (1kΩ5 for 2.4. module)
- R4, R6 = 20kΩ
- R5, R7 = 30kΩ (E96: 30kΩ1)

Capacitors

- C1 = 470µF 25V radial, lead pitch 5mm
- C2, C3 = 100 nF ceramic, lead pitch 5mm
- C4 = 100µF 25V radial, lead pitch 2.5 mm
- C5 = 10 nF ceramic, lead pitch 5mm
- C6, C7 = 2µF2 MKT, lead pitch 5 or 7.5mm

Semiconductors

- D1 = 1N4004
- D2 = LED, red, low current
- IC1 = LM317 (TO220)

Miscellaneous

- K1 = PCB screw terminal block, lead pitch 5mm
- K2 = 3-way pinheader
- K3 = 2-way pinheader
- S1 = DIL switch block, 10 contacts
- S2 = pushbutton, 1 contact
- Module1 = TX-AUDIO-2.4/AE (Aurel.) + 2 x 8 pin connector with 2.0 mm lead pitch (e.g. Molex type 872641652, Farnell # 856-0145)
- PCB, no. **080647-1**

Table 1. Principal specifications of the Aurel TX Audio 2.4 and TX Audio 2.4/AE modules (Aurel figures).

Parameter	TX-Audio-2.4			TX-Audio-2.4/AE			Units
	Min.	Typ.	Max.	Min.	Typ.	Max.	
Supply voltage	3,6	–	5	2	–	3,4	V
Power consumption	–	93	–	–	68	–	mA
Frequency range	2,400	–	2,4835	2,400	–	2,4835	GHz
Frequency stability	–	+/-100	–	–	+/-100	–	kHz
RF power	–	10	–	–	10	–	dBm
Number of channels	–	8	–	–	8	–	–
Frequency response (–1 dB)	20	–	20 000	20	–	20 000	Hz
Dynamic range	–	92	–	–	90	–	dBm
Channel separation	–	80	–	–	70	–	dB
Signal-to-noise ratio	–	87	–	–	90	–	dB
Input impedance	>10	–	–	>10	–	–	kΩ
Operating temperature	–10	–	+80	–10	–	+60	°C

The audio source connected to K2 is isolated from the transmitter by capacitors C6 and C7; despite their high values, these must not under any circumstances be electrolytics, in order to maintain the overall quality of the link.

Push-button S2 enables you to change the transmit channel. If you use the 2.4/AE module, the right-hand part of **Figure 1** comes into play, and lets you set the transmit channel ‘manually’ using the top three switches of S1, S2 then being inactive. The other switches on S1 allow us to experiment with the other options available in the 2.4/AE module, as shown in **Table 3**.

One other interesting option of the modules, accessible via K3, is the additional channel for transmitting digital data at a maximum rate of 5 kbits/s.

Constructing the transmitter

As seen in **Figure 2**, the suggested PCB is L-shaped, as the transmitter modules have components on both faces, which means they can’t be mounted onto the PCB, even though

the small size of their connector really demands it.

Watch out for the 16-pin female connector for this module: it’s a 2 mm pitch type, available from Farnell, for example. Take care as well to select the correct values for R1, R2, and R3, depending on which of the Aurel modules you’ve chosen, as shown in the circuit, as the 2.4/AE module really doesn’t like being powered from 5 V!

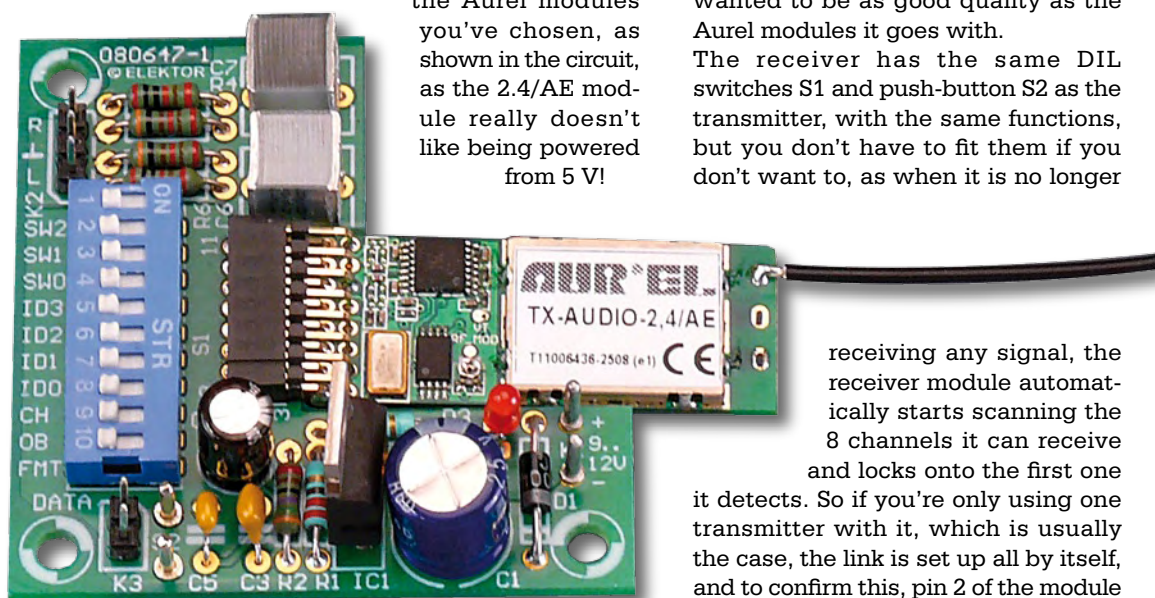

Before plugging the module into the female connector on the PCB, note that if it’s a 2.4 with a single-row connector, it plugs into the bottom row of the female connector, with the side marked “Aurel Tx-Audio-2.4” up, as in the photos of our prototype. If it’s a 2.4/AE, it takes up all of the female connector. The transmitter can’t be tested with-

out its associated receiver, so let’s take a look at that right away.

Receiver circuit

The receiver circuit shown in **Figure 3** is a little more complicated than the transmitter, mainly because of the headphone amplifier, which we wanted to be as good quality as the Aurel modules it goes with. The receiver has the same DIL switches S1 and push-button S2 as the transmitter, with the same functions, but you don’t have to fit them if you don’t want to, as when it is no longer

receiving any signal, the receiver module automatically starts scanning the 8 channels it can receive and locks onto the first one it detects. So if you’re only using one transmitter with it, which is usually the case, the link is set up all by itself, and to confirm this, pin 2 of the module goes to 2.7 V, as shown by D3 lighting, after amplification in T1. See **Table 4** for the other channel select modes — four in all — that can be configured using S1-8 and a jumper on J1.

The audio outputs are available on pins 8 and 10 and drive two identical channels. A first stage, built around IC2A (or IC2B), forms a second-order Sallen & Key low-pass filter. This lets us cut off everything above 24 kHz, thereby

COMPONENTS LIST receiver

Resistors

0.5 or 0.25 watt, metal film, 5%

R1 = 270Ω
R2 = 22Ω
R3 = 820Ω
R4,R23 = 1kΩ
R5,R13 = 47kΩ
R6,R7,R14,R15 = 8kΩ
R8,R16 = 2kΩ
R9,R17 = 100kΩ
R10,R18 = 1kΩ
R11,R19 = 10kΩ
R12,R20 = 100Ω
R21,R22 = 4kΩ
P1 = 50Ω preset

P2 = 10kΩ potentiometer, dual linear (Vishay-Sfernice type P9A2RFISX1BB2103MAE3)
P3 = 10kΩ potentiometer, dual logarithmic (Vishay-Sfernice type P9A2RFISX1BB2103MLE3)

Capacitors

C1,C4 = 470μF 25V, radial, lead pitch 5mm
C2,C3,C9,C10,C15,C16 = 100nF, ceramic, lead pitch 5mm
C5,C8,C11,C14 = 2μF2, MKT, lead pitch 5 or 7.5mm
C6,C12 = 820pF
C7,C13 = 560pF
C17 = 10nF ceramic, lead pitch 5mm

Semiconductors

D1 = 1N4004
D2,D3 = LED red, low current
T1 = BC547B
IC1 = LM317 (TO220)
IC2,IC3 = OPA2134PA (DIP8)

Miscellaneous

K1 = 2-way pinheader
K2 = 3-way pinheader
J1 = 3-way pinheader with jumper
S1 = DIL switch block, 10 contacts
S2 = pushbutton, 1 contact
BT1,BT2 = 9V PP3 battery with clip-on lead (optionally with double-pole switch)
Module1 = RX-AUDIO-2.4 (Aurel) + 2 off 2 x 8 contacts with 2.0mm lead pitch (e.g. Molex type 872641652, Farnell # 856-0145)
PCB no. **080647-2**

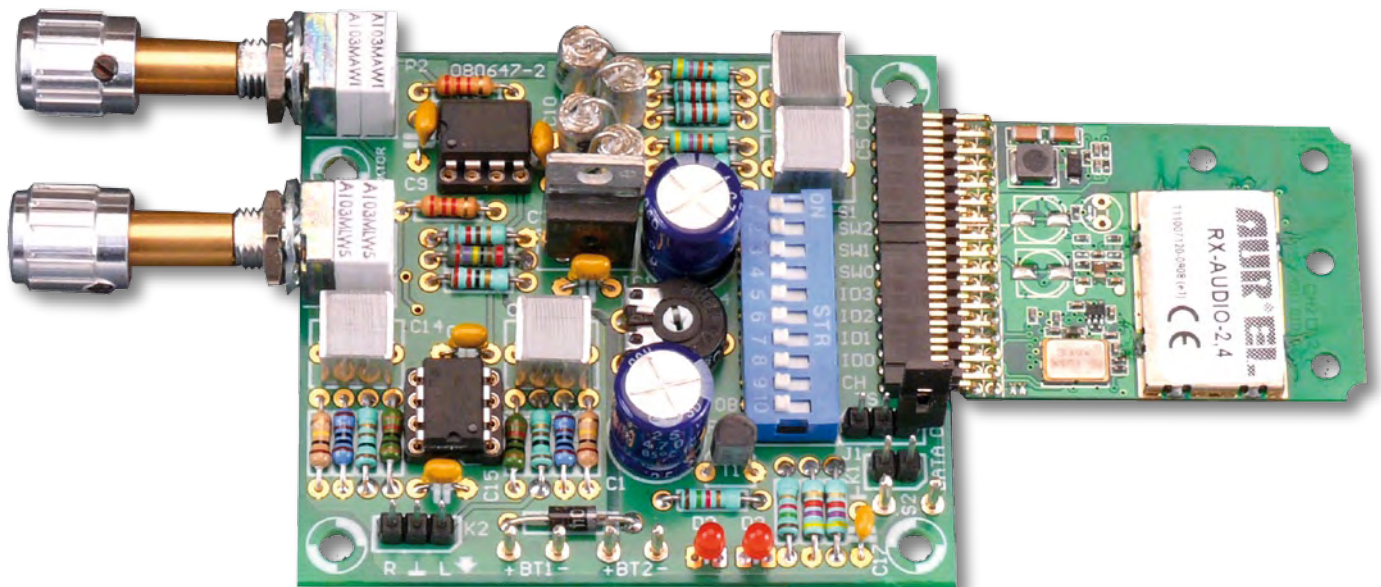

erwise be needed. Despite the receiver's consumption of nearly 100 mA, we've used two 9 V batteries in the 6F22 (PP3) format. If you're sure you won't ever connect the batteries the wrong way round, you can replace D1 with a wire link and gain a little longer battery life. Another option would be to use 12 rechargeable AA cells in series, tapping off

Table 2. Principal specifications of the Aurel RX Audio 2.4 modules (Aurel figures).

Parameter	RX-Audio-2.4			Units
	Min.	Typ.	Max.	
Supply voltage	-	5	-	V
Power consumption	-	65	-	mA
Frequency range	2,400	-	2,4835	GHz
Frequency stability	-	+/-100	-	kHz
Sensitivity	-	-83	-	dBm
Number of channels	-	8	-	-
Frequency response (-1 dB)	20	-	20 000	Hz
Dynamic range	-	92	-	dBm
Channel separation	-	80	-	dB
Signal-to-noise ratio	-	87	-	dB
Operating temperature	-10	-	+60	°C

the ground at 4.8 V, i.e. after 4 cells, giving power rails of +9.6 V and -4.8 V. The circuit copes perfectly well with this asymmetry. According to its data sheet, the Aurel module must be powered from 5 V ± 0.1 V, corresponding to a precision of 2%. Pot P1 in conjunction with R2 makes it possible to adjust the voltage to 5 V exactly.

Table 3. The function of the DIL switches on the transmitter and receiver.

The receiver and 2.4/AE transmitter have all the options, unlike the 2.4 transmitter. The ID bits make it possible to use several wireless systems in parallel without interference. In this way, a wireless 5.1 system is easy to achieve.

S1	Module 1	Function
S1-1	SW2	Channel select, bit 2
S1-2	SW1	Channel select, bit 1
S1-3	SW0	Channel select, bit 0
S1-4	ID3	Identification bit 3 (2.4/AE)
S1-5	ID2	Identification bit 2 (2.4/AE)
S1-6	ID1	Identification bit 1 (2.4/AE)
S1-7	ID0	Identification bit 0 (2.4/AE)
S1-8	CH_MODE	Use S2 to select channels
S1-9	OB	Out-of-band communication for testing (2.4/AE)
S1-10	FORMAT	Encrypted (2.4/AE)

Constructing the receiver

The suggested PCB is shown in **Figure 4** and doesn't present any particular problems in construction. However, sourcing the components is worth a few comments.

The OPA 2314s are available from Farnell or RS Components, for example. The same goes for the pots we've used, from the special audio range by Vishay-Sfernice in order not to degrade the performance of our system by using types that might have the ill grace to start 'crackling' after only a few uses. Just as for the transmitter, the female connector for the receiver module is a 2 mm pitch type, but needs to have 2 rows of 16 contacts. As such a type doesn't seem to exist, we used two 2x8-contact types stacked end-to-end.

Although in tricky reception conditions LED D3 can be quite handy, to see if the receiver has indeed been able to find the signal, it is entirely optional, especially if you are keen to minimize power consumption.

Tests and measurement results

Given the cost of the Aurel modules, it's wise to carry out a few simple

checks before powering up the project. On the transmitter side, check that regulator IC1 is indeed supplying the correct voltage required by the module you're using before you plug it into its connector. Re-read if necessary what we've said above about the correct position for it in the connector.

On the receiver side, check too that the supply to the Aurel module is indeed $5\text{ V} \pm 0.1\text{ V}$.

If all is well, plug the modules and ICs into their respective sockets and apply the power. LED D3 on the receiver should light very quickly if you are in automatic channel search mode. Otherwise, and if you are using a 2.4/AE transmitter module, it will only light if DIL switches S1-1 to 7 are set the same on both transmitter and receiver. You can then connect an audio source to the transmitter and note the fine quality of the whole link via the receiver headset.

Even though the author — a serious hifi enthusiast — (still) has fairly reliable ears, a few measurements were added to support the good impression left by the first listening. In order for these to be meaningful, they were made over the whole of the audio chain, i.e. from the transmitter input to the receiver output.

The signal-to-noise ratio is better than on many commercial audio amplifiers used in headphone mode, while the distortion, even though it does increase slightly above 5 kHz because of the digital conversion technique used, is still way below what even the most experienced ears can hear.

The sound level that can be achieved from the headphone output using the OPA 2134 is more than adequate, whether you use a medium- or low-impedance headset, and will even let you damage your eardrums if you turn the volume up too high.

The frequency response, measured under the same conditions as the distortion, is from 15 Hz to 18.5 kHz at the -3 dB points. The power consumption is the sole drawback of this project, but unfortunately there's nothing we can do about that, as it's mainly due to the Aurel modules. It amounts to 72 mA for the transmitter and 97 mA/-16 mA for the receiver, with both LEDs lit.

Whether you've never used a wireless headset before, or have already been disappointed by certain commercial models, we have not the slightest hesitation in recommending this project which makes no compromises in terms of audio quality.

Table 4. How to choose the receiver's various channel select modes (X = pin floating).

Mode	CH_MODE (S1-8)	TACT_SCAN (J1-1)	CT_INU (J1-3)	Function
DIP	GND	X	X	Channel selected by S1-1, S1-2, and S1-3
TACT	X	GND	X	Channel change using S2
TACT SCAN	X	X	GND	Performs a scan after S2 is pressed
AUTO SCAN	X	X	X	Automatic scan

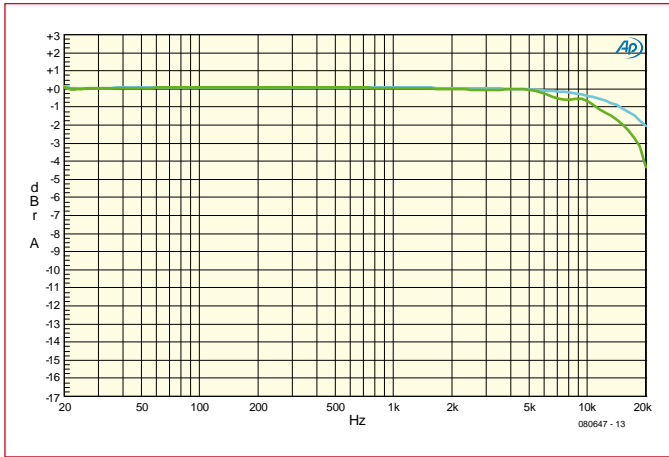

Figure 5. Frequency response.

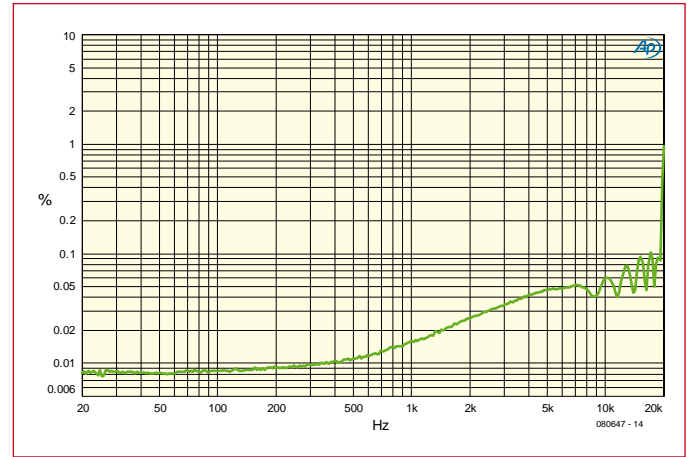

Figure 6. Distortion measurements.

The sample Aurel digital wireless audio modules used by Elektor in this article were kindly supplied by P2M (France)

(080647-1)

Internet links

Aurel:

www.aurelwireless.com

UK distributors:

J&C Components (info@jandccomponents.co.uk); Radio-Tech Limited (sales@radio-mo-dem.com); CHARTLAND Ltd. (chartland@dial.pipx.con).

US distributor:

ABACOM (abacom@abacom-tech.com)

Author's website:

www.tavernier-c.com