



BCA 05

7 607 005 200

K7/VKD 8 622 400 395 01/96

Datenblatt • Data sheet • Feuille de données • Hoja de datos

<p>(D)</p> <p>Weitere Dokumentationen Bedienungsanleitung K7/VKD 3 D95 161 014 Schaltbild K7/VKD 8 622 400 396 Ersatzteilliste K7/VKD 8 622 400 397</p>	<p>(GB)</p> <p>Supplementary documentation Operating instructions K7/VKD 3 D95 161 014 Schematic diagram K7/VKD 8 622 400 396 Spare parts list K7/VKD 8 622 400 397</p>	<p>(F)</p> <p>Documentation complémentaire Mode d'emploi K7/VKD 3 D95 161 014 Schéma de connexions K7/VKD 8 622 400 396 Liste de rechanges K7/VKD 8 622 400 397</p>	<p>(E)</p> <p>Documentación suplementaria Instrucciones de manejo K7/VKD 3 D95 161 014 Esquema de conexión K7/VKD 8 622 400 396 Lista de repuestos K7/VKD 8 622 400 397</p>
---	---	---	---

Technische Daten	Technical data	Données techniques	Datos técnicos
<p>Maße siehe Maßzeichnung</p> <p>Masse ca. 0,90 kg</p> <p>Betriebsspannung 15 V Service</p> <p>Stromaufnahme 400 mA</p> <p>Relais - Ausgang je 24 V / 5 A</p>	<p>Dimensions see dimensioned drawing</p> <p>Weight approx. 0.90 kg</p> <p>Operating voltage Service 15 V</p> <p>Current consumption 400 mA</p> <p>Relay outputs 24 V / 5 A each</p>	<p>Dimensions voir dessin coté</p> <p>Poids env. 0.90 kg</p> <p>Tension de fonctionnement Service 15 V</p> <p>Consommation de courant 400 mA</p> <p>Sorties de relais 24 V / 5 A respectivement</p>	<p>Dimensiones véase dibujo acotado</p> <p>Peso 0,90 kg aprox.</p> <p>Tensión de operación Servicio 15 V</p> <p>Consumo de corriente 400 mA</p> <p>Salidas de relé 24 V / 5 A cada una</p>
<p>Regelumfang Cockpit - Regler VOLUME > 60 dB Cabin - Regler VOLUME > 60 dB Pegel - Regler MIC > 50 dB Pegel - Regler MIX > 40 dB</p> <p>Treble-Regler ± 8 dB (bei 10 kHz) Bass-Regler + 7 dB (bei 100 Hz) Balance-Regler - 8 dB</p>	<p>Control range Cockpit control VOLUME > 60 dB Cabin control VOLUME > 60 dB Level control MIC > 50 dB Level control MIX > 40 dB</p> <p>Treble control ± 8 dB (at 10 kHz) Bass control ± 7 dB (at 100 Hz) Balance control - 8 dB</p>	<p>Plage de contrôle Contrôle cockpit VOL. (niveau) > 60 dB Contrôle cabin VOL. (niveau) > 60 dB Contrôle level MIC (niveau) > 50 dB Contrôle level MIX (niveau) > 40 dB</p> <p>Contrôle treble (aiguës) ± 8 dB (avec 10 kHz) Contrôle bass (basses) ± 7 dB (avec 100 Hz) Contrôle balance - 8 dB</p>	<p>Gama de control Regulador cockpit VOL. (nivel) > 60 dB Regulador cabin VOL. (nivel) > 60 dB Regulador level MIC (nivel) > 50 dB Regulador level MIX (nivel) > 40 dB</p> <p>Regulador treble (agudos) ± 8 dB (con 10 kHz) Regulador bass (bajos) ± 7 dB (con 100 Hz) Regulador balance - 8 dB</p>
<p>Übertragungsbereich RADIO, TAPE, CD, VIDEO 40 Hz - 20 kHz Mikrofon 100 Hz - 6,5 kHz</p>	<p>Transmission range RADIO, TAPE, CD, VIDEO 40 Hz - 20 kHz Microphone 100 Hz - 6.5 kHz</p>	<p>Bande passante RADIO, TAPE, CD, VIDEO 40 Hz - 20 kHz Microphone 100 Hz - 6,5 kHz</p>	<p>Gama de transmisión RADIO, TAPE, CD, VIDEO 40 Hz - 20 kHz Micrófono 100 Hz - 6,5 kHz</p>
<p>Eingangspiegel RADIO, TAPE, CD 2 V VIDEO 0,6 V</p>	<p>Input level RADIO, TAPE, CD 2 V VIDEO 0.6 V</p>	<p>Niveau d'entrée RADIO, TAPE, CD 2 V VIDEO 0,6 V</p>	<p>Nivel de entrada RADIO, TAPE, CD 2 V VIDEO 0,6 V</p>
<p>Klirrfaktor RADIO, TAPE, CD, VIDEO < 0,2 % Mikrofon 1 %</p>	<p>Distortion RADIO, TAPE, CD, VIDEO < 0.2 % Microphone 1 %</p>	<p>Taux de distorsion RADIO, TAPE, CD, VIDEO < 0,2 % Microphone 1 %</p>	<p>Factor de distorsión RADIO, TAPE, CD, VIDEO < 0,2 % Micrófono 1 %</p>
<p>Impedanz Mikrofoneingang 1 kΩ / 1 mV Impedanz CD-Eingang > 10 kΩ / 2 V</p>	<p>Microphone input impedance 1 kΩ / 1 mV CD input impedance > 10 kΩ / 2 V</p>	<p>Impédance entrée microphone 1 kΩ / 1 mV Impédance entrée CD > 10 kΩ / 2 V</p>	<p>Impedancia entrada micrófono 1 kΩ / 1 mV Impedancia entrada CD > 10 kΩ / 2 V</p>

Maßzeichnung • Dimensioned drawing • Dessin coté • Dibujo acotado

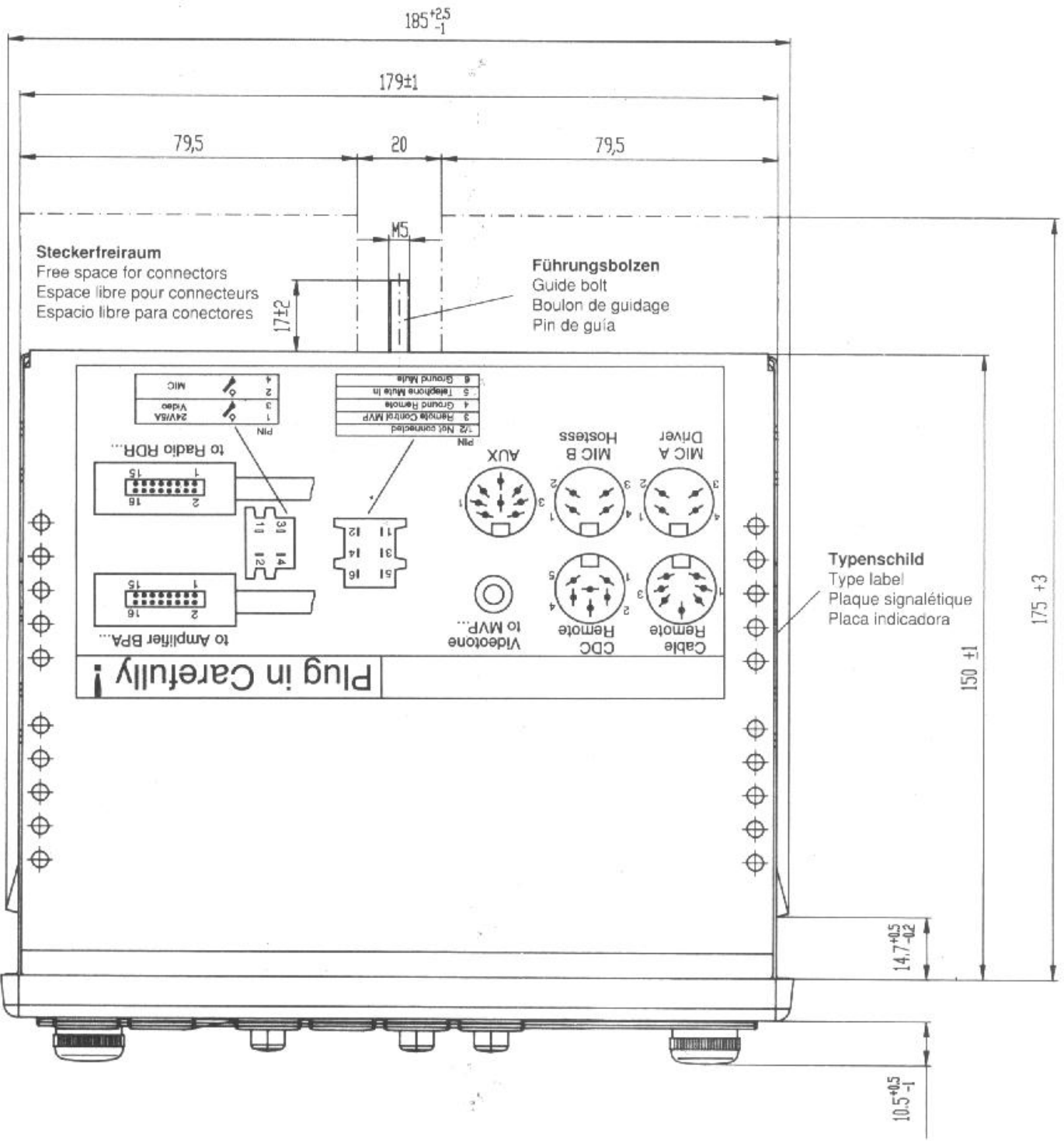
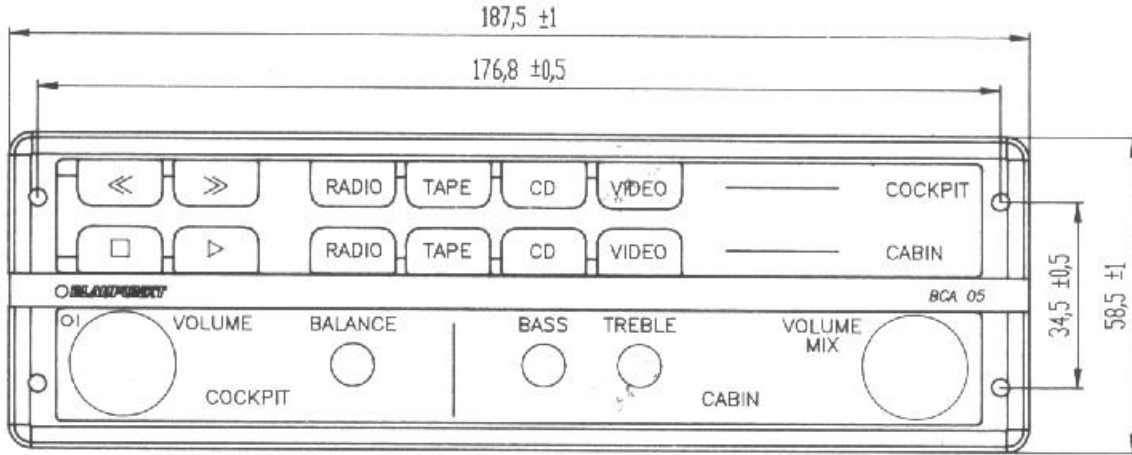

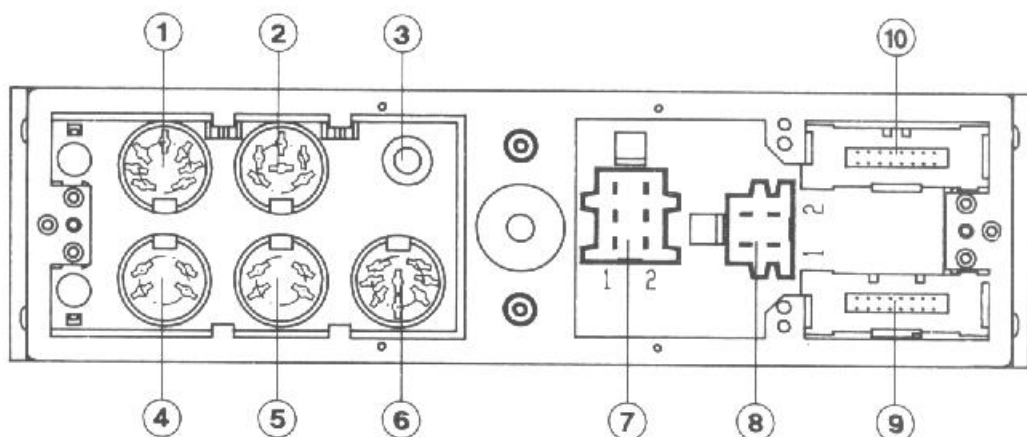

Anschlüsse • Connections • Connexions • Conexiones

Nr./No.	Anschluß	Connection	Connexion	Conexión
①	Kabelfernbedienung BCA - R 06 für Bedienteil BCA 05	Wired remote control BCA - R 06 for BCA 05 control unit	Télécommande à câble BCA - R 06 pour l'unité de commande BCA 05	Mando a distancia por cable BCA - R 06 para unidad de control BCA 05
②	Fernbedienungsschnitt- stelle für CD - Changer	Remote control interface for CD changer	Interface de télécommande pour changeur CD	Interface de mando a distancia para cambiadiscos
③	Video Ton	Video sound	Son vidéo	Sonido vídeo
④	Fahrer - Mikrofon (Vorrang)	Driver microphone (priority)	Microphone conducteur (priorité)	Micrófono del conductor (prioridad)
⑤	Begleiter - Mikrofon	Guide microphone	Microphone guide	Micrófono de guía
⑥	AUX (CD) - Eingang	AUX (CD) input	Entrée AUX (CD)	Entrada AUX (CD)
⑦	1: ---- 2: ----	1: ---- 2: ----	1: ---- 2: ----	1: ---- 2: ----
	3: MVP - Fernsteuerung 4: MVP - Fernst. Masse	3: MVP remote control 4: MVP remote control GND	3: Télécommande MVP 4: Masse de télécomm. MVP	3: Mando a distancia MVP 4: Mando a dist. MVP - masa
	5: Telefon - Stummschalt. 6: Telefon - Stummschalt. Masse	5: Telephone mute 6: Telephone mute GND	5: Attén. sonore du téléphone 6: Attén. sonore masse du téléphone	5: Mutización del teléfono 6: Multización del teléfono - masa
⑧	1: ⚡ Video - Monitor 3: ⚡ 24V / 5A max.	1: ⚡ Video monitor 3: ⚡ 24V / 5A max.	1: ⚡ Moniteur vidéo 3: ⚡ 24V / 5A max.	1: ⚡ Pantalla de vídeo 3: ⚡ 24V / 5A máx.
	2: ⚡ Fahrer - Mikrofon 4: ⚡ 24V / 5A max.	2: ⚡ Driver microphone 4: ⚡ 24V / 5A max.	2: ⚡ Micro. conducteur 4: ⚡ 24V / 5A max.	2: ⚡ Micró. del conductor 4: ⚡ 24V / 5A máx.
⑨	Steckverbindung zum Radio RDR 05,	Plug connection to radio RDR 05,	Connecteur à fiches pour la radio RDR 05,	Conexión a la radio RDR 05,
⑩	Steckverbindung zum Verstärker BPA 24	Plug connection to amplifier BPA 24	Connecteur à fiches pour l'amplificateur BPA 24	Conexión al amplificador BPA 24

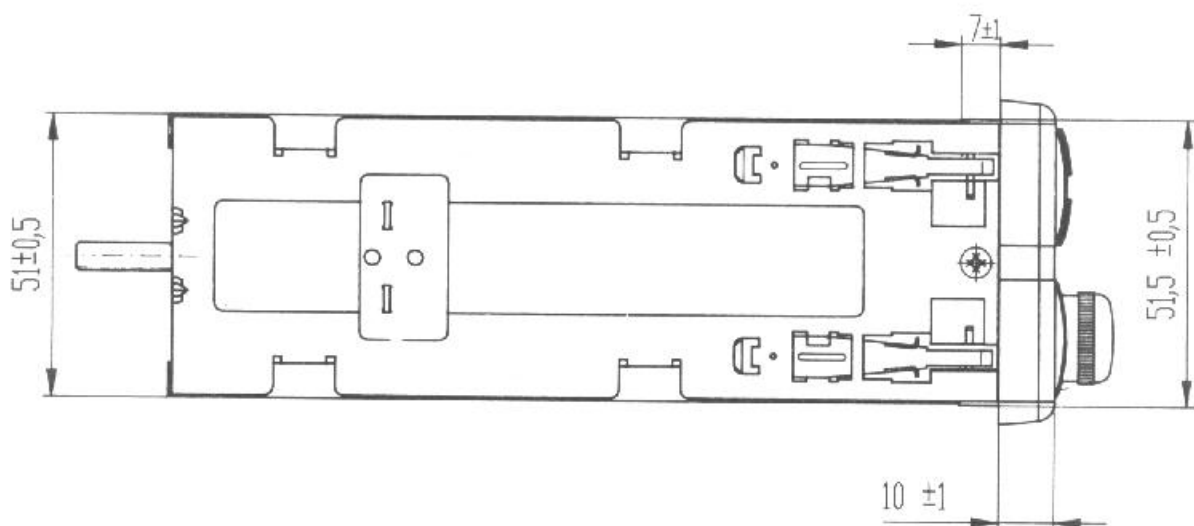

Sonderzubehör • Special accessories • Accessoires spéciaux • Accesorios especiales

Sonderzubehör • Special accessories Accessoires spéciaux • Accesorios especiales	für • for • pour • para	Nr. • No. • N° • N°	
Verdrahtungssatz (Steckergehäuse, Kontakte, Antennen-adapter mit Halter) Wiring set (connector housing, contacts, antenna adapter with holder) Set de connexions (longement de prise, contacts, adaptateur d'antenne avec support) Set de conexiones (caja de conductor, contactos, adaptador de antena con soporte)	BCA 05 / RDR 05 / BPA 2480 - 24120	7 607 006 302	
Anschlußkabel Connecting cable Câble de connexion Cable de conexión	BCA 05 / BPA 2480 - 24120	1,7 m	7 607 006 303
		3,0 m	7 607 006 304
		4,0 m	7 607 006 305
		5,0 m	7 607 006 006
		8,0 m	7 607 006 007
Remote Kabel Remote cable Câble de télécommande Cable remoto	BCA 05 / MVP 01	1,5 m	7 607 006 313
		8,0 m	7 607 006 309
Metall - Einbaurahmen (2x) Metal mounting sleeves (2x) Cadre de montage en métal (2x) Marco metálico de instalación (2x)	BCA 05 / RDR 05	7 607 006 308	
Kabelfernbedienung BCA - R 06 Wired remote control BCA - R 06 Télécommande à câble BCA - R 06 Mando a distancia por cable BCA - R 06	BCA 05	7 607 005 708	
Verlängerungskabel Extension cable Câble de rallonge Cable de prolongación	BCA - R 06	7 607 006 403	
Changer CDC A 05 Coach	BCA 05	7 607 005 407	
Spannungsteiler 24/12 V Voltage divider 24/12 V Diviseur de tension 24/12 V Divisor de tensión 24/12 V	CDC A 05	7 607 363 510	

D Beschreibung

Das Bedienteil BCA 05 ist die Zentraleinheit der Busanlage, zu der außerdem das Radio RDR 05 und der Verstärker BPA 2480 bzw. 24120 gehören.

Über das Bedienteil werden alle wichtigen Funktionen des Busanlagensystems gesteuert.

Die Ausstattung des Bedienteils BCA 05:

- Zentraler Ein-/ Ausschalter mit integriertem Lautstärkereglern und beleuchtetem Einschaltssymbol.
- Ein-/ und Ausschalten der Busanlage mit dem Fahrermikrofon für Durchsagen.
- Relais- Schaltausgang für Information Fahrermikrofon ein / aus.
- Nachtdesign für einfache Bedienung.
- Programmtrennung zwischen Cockpit und Cabin, d.h. Fahrer und Fahrgäste können unterschiedliche Programmquellen hören.
- Balance- Regler für den Cockpit- Bereich, Bass- und Höhenregler für den Cabin- Bereich.
- Fernbedienfunktion für Radiosuchlauf und Laufwerkfunktionen des Video- Players und CD- Changers CDC A 05.
- Anzeige der Fernbedienfunktionen im Radio- Display des RDR 05.
- Rote Rückmeldung der Fernbedientasten für Radio, Video- Player und CD- Changer.
- Tonquellen für Cockpit und Cabin werden bei Anwahl durch rote Tastenbeleuchtung bestätigt.
- Getrennte Mikrofoneingänge für Fahrer und Reisebegleiter.
- Volume Memory für Mikrofone, MIX- Memory für Reisebegleitermikrofon.
- MIX- Betrieb, d.h. einblenden der laufenden Tonquelle bei Durchsagen mit dem Reisebegleiter- Mikrofon.
- AUX- Eingang für zusätzliche Tonquelle (CD- Changer).
- Eingang für Video- Ton.
- Schalteingang für Telefon- Stummschaltung.
- Relais- Schaltausgang zum Schalten der Video- Monitore.
- Anschluß für Kabelfernbedienung BCA- R 06.

Hinweis: Anschluß der Radios SQR 08, SQR 01 und RDR 01 möglich, jedoch ohne Anzeige der Bedientfunktionen im Radio- Display.

Bei Anschluß des SQR 08 oder SQR 01 keine Verkehrsfunkdurchsagen im Fahrerbereich möglich.

GB Description

The BCA 05 is the central control unit for the coach system, which also includes the radio RDR 05 and the amplifier BPA 2480 or 24120. The control unit is used to operate all major functions of the coach system.

Specifications of the BCA 05 control unit:

- Central on-switch with integrated volume control and illuminated power-on symbol.
- Coach system switched on and off centrally through the driver microphone for the duration of an announcement.
- Relay switching output for information „driver micro on/off“.
- Night design for easy operation.
- Programme separation between the cockpit and the cabin, i.e. the driver and the passengers can listen to different audio sources.
- Balance control for the cockpit, bass and treble control for the cabin area.
- Remote control function for radio seek tuning and the tape drive functions of the video player and CD changer CDC A 05.
- Remote control functions displayed on the RDR 05.
- When activated, the lettering of the remote control functions for the radio, video player and CD changer switches to red.
- The activated audio source buttons for the cockpit and cabin areas switch from yellow to red.
- Separate microphone inputs for the driver and the tour guide.
- Volume memory function for microphones, MIX-memory for the tour guide microphone.
- MIX operation, i.e. accompanying an announcement made with the guide microphone with a musical background provided by the currently active audio source.
- AUX input for additional audio source (CD changer).
- Input for video sound.
- Switching input for telephone mute.
- Relay switching output for operating the video monitors.
- Connector for wired remote control BCA - R 06.

Note: Generally, it is possible to connect the BCA 05 also to the car radio models SQR 08, SQR 01, and RDR 01. In this case, however, the operating functions will not be displayed on the radio panel. When connecting the SQR 08 or SQR 01, it will not be possible to receive traffic messages in the cockpit area.

Ersatzteilliste • Spare Parts List • Liste de rechanges • Lista de repuestos

ME 3401
8 636 592 890

ME 3401
9 648 053 786



H 544
9 648 059 044

ME 3402
9 648 050 723



R 874 / R875 / R876
9 648 059 043

ME 3401
9 648 053 786









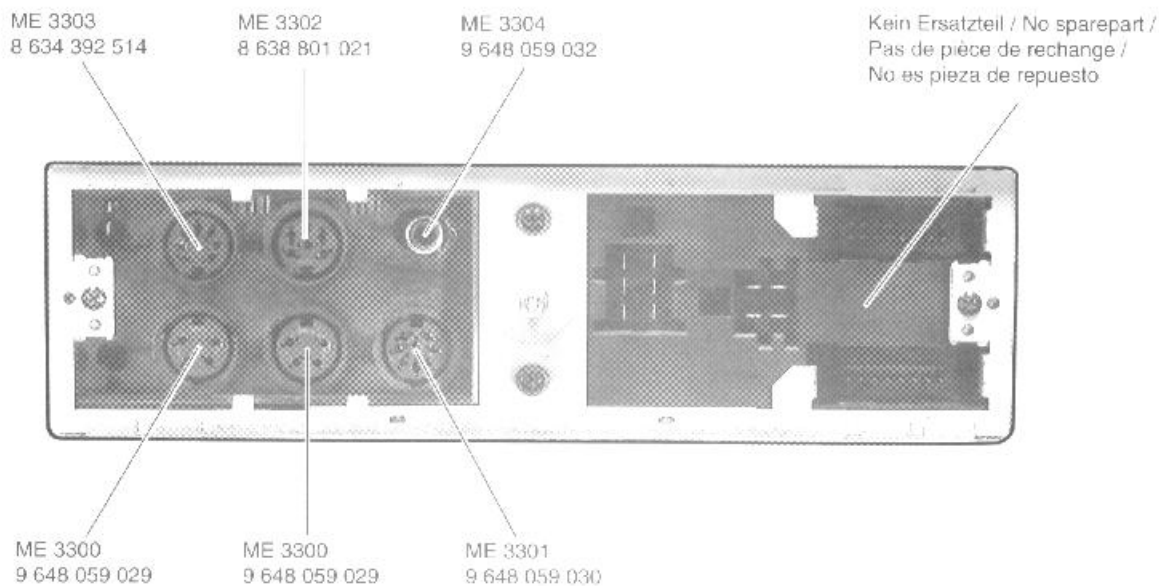
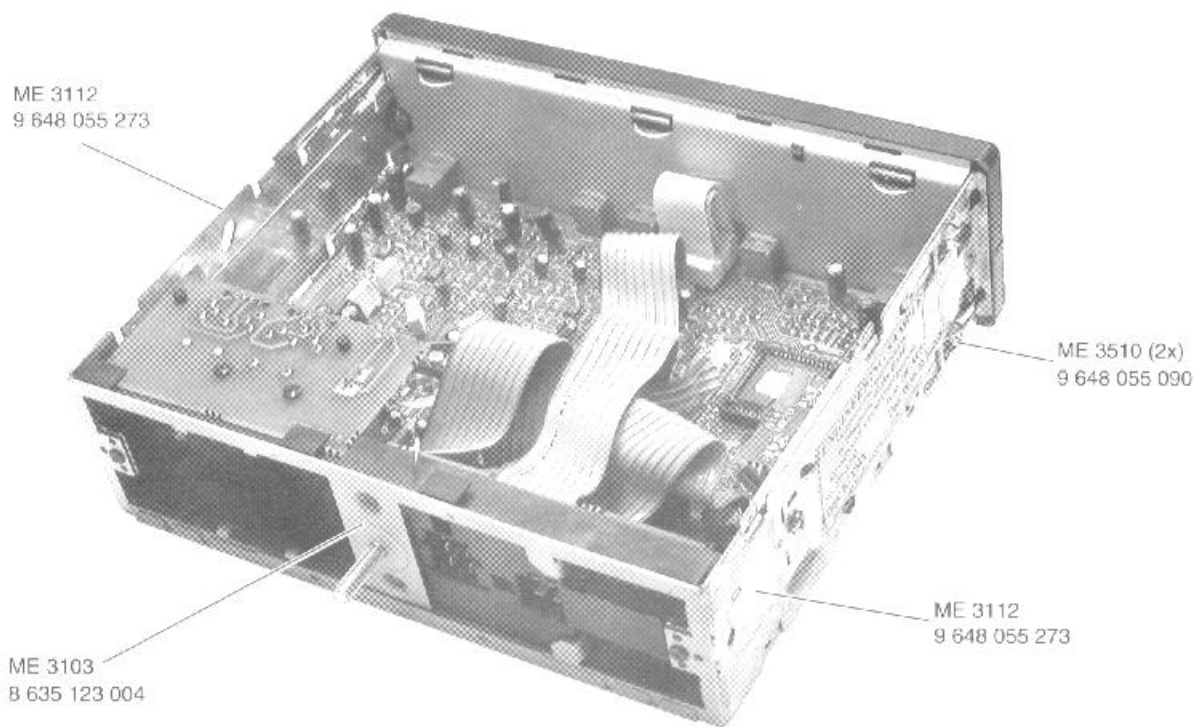

H 842
9 648 059 044

Mechanische Bauteile
Composants mécaniques

Mechanical components
Piezas mecánicas

	(D)	(GB)	(F)	(E)	
ME 3101	DECKEL (OBEN-UNTEN)	HOUSING COVER	COUVERCLE DE BOIT.	TAPA DEL CARTER	8 635 132 602
ME 3610	SCHALTERPLATTE	SWITCH BOARD	PLAQUE D'INTERRUPTION	PLACA DE INTERRUPT	9 648 308 134
ME 3620	ANSCHLUBPLATTE	CONNECTION PLATE	PLAQUE D'CONNEX	PLACA DE CONEXION	9 648 308 143
ME 3988	DEMONTAGEBUEGEL	DISMANTLING AID	ETRIER DE DEMONT.	ESTRIBO DE DESMONT	8 601 910 002
ME 3990	HALTERAHMEN	FRAME	CADRE SUPPORT	MARCO DE FIJACION	8 601 310 742



Position Position Position Posición	Bezeichnung Designation Dénomination Denominación	Bestell-Nr. Part no. No. de commande Número de pedido
		
D 800	MC 68HC05B16	8 925 901 646
D 830	L 4949	8 925 900 348
D 1100	BA 3121	8 925 901 034
D 1150	BA 3121	8 925 901 034
D 1200	MC 33078	8 925 900 225
D 1250	BA 3121	8 925 901 034
D 1300	TEA 6320	8 925 901 095
D 1310	MC 33178	8 945 900 622
D 1360	MC 33178	8 945 900 622
D 1400	TEA 6320	8 925 901 095
D 1410	MC 33178	8 945 900 622
D 1500	MC 33078	8 925 900 225
D 1570	TEA 6320	8 925 901 095
D 1580	MC 33178	8 945 900 622
D 2000	LM 317 T	8 945 901 736
D 2010	LM 317 T	8 945 901 736
D 3300	SAA 1064 T	8 925 901 092
		
H 3300- H 3354	LSY T670 K	8 925 405 458
		
H 842	VOLUME CABIN	9 648 059 044
H 844	VOLUME COCKPIT	9 648 059 044
		
K 860		8 948 100 048
K 860		8 948 100 048
		
S 3312- S 3335		8 638 800 167
		
R 874	100 kΩ	BALANCE 9 648 059 043
R 875	100 kΩ	BASS 9 648 059 043
R 875	100 kΩ	TREBLE 9 648 059 043
R 1323	10 kΩ	8 941 500 072
		
V 801	BAV 99	8 925 405 124
V 830	BAV 99	8 925 405 124
V 834	BAV 99	8 925 405 124
V 849	BAV 99	8 925 405 124
V 851	BC 848 C	8 925 705 037
V 853	BC 848 C	8 925 705 037
V 860	BC 548 C	9 933 051 058
V 861	1 N4148	8 925 405 822
V 862	BC 848 C	8 925 705 037
V 863	BC 858 C	8 925 705 039
V 864	BC 848 C	8 925 705 037
V 865	BC 848 C	8 925 705 037
V 875	BC 858 C	8 925 705 039

Position Position Position Posición	Bezeichnung Designation Dénomination Denominación	Bestell-Nr. Part no. No. de commande Número de pedido
V 876	BAV 99	8 925 405 124
V 1511	BC 858 C	8 925 705 039
V 1513	BC 848 C	8 925 705 037
V 1514	BAV 99	8 925 405 124
V 1515	BC 337/40	8 905 707 200
V 1518	BZX 55/C5V1	8 905 421 272
V 1522	BC 848 C	8 925 705 037
V 1561	BC 858 C	8 925 705 039
V 1563	BC 848 C	8 925 705 037
V 1564	BAV 99	8 925 405 124
V 1565	BC 337/40	8 905 707 200
V 1568	BZX 55/C5V1	8 905 421 272
V 1590	BC 548 C	9 933 051 058
V 1591	1 N4148	8 925 405 822
V 1801	BC 848 C	8 925 705 037
V 1802	BC 858 C	8 925 705 039
V 1803	BZX 55/C5V1	8 905 421 272
V 1811	BC 848 C	8 925 705 037
V 1812	BC 858 C	8 925 705 039
V 1813	BZX 55/C5V1	8 905 421 272
V 1840	BAV 99	8 925 405 124
V 1842	BC 848 C	8 925 705 037
V 1843	BC 848 C	8 925 705 037
V 1845	BZX 55/C5V1	8 905 421 272
V 2020	BC 848 C	8 925 705 037
V 2023	BC 558 C	8 925 707 327
V 3338	BC 849 C	8 925 705 035
V 3339	BC 849 C	8 925 705 035
V 5000	BC 848 C	8 925 705 037
V 5001	BC 858 C	8 925 705 039
V 5004	BC 848 C	8 925 705 037
V 5006	BC 337/40	8 905 707 200
V 5007	1 N4002	8 905 405 636
V 5008	1 N4002	8 905 405 636
		
Z 850	4 MHz	9 939 050 237
Hinweis: Handelsübliche Kondensatoren und Widerstände sind in der Ersatzteilliste nicht aufgeführt. Wir bitten Sie, diese Teile im Fachhandel zu beziehen.		Note: Capacitors and resistors usual in trade are not mentioned in the spare parts list. Kindly buy these parts from the specialized trade.
Nota: Des condensateurs et résistances commerciaux ne sont pas inclus dans la liste des pièces détachées. Veuillez acheter ces pièces chez votre spécialiste.		Nota: No se indican en la lista de piezas de requestos los condensadores y los resistores de uso comercial. Les rogamos comprar esas piezas en el comercio especializado.

BCA 05

7 607 005 200

8 622 400 396 BN 12/96

Schaltbild • Circuit diagramm • Schema du poste • Esquema del aparato**(D)****Weitere Dokumentationen**Ersatzteilliste
8 622 400 397**(GB)****Supplementary documentation**Spare parts list
8 622 400 397**(F)****Documentation supplémentaire**Liste de rechanges
8 622 400 397**(E)****Documentación suplementaria**Lista de repuestos
8 622 400 397**Platte
board
PL 8147 A05**

D2000

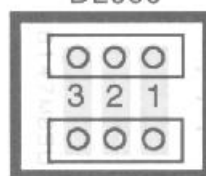

X2001

Anschlußplatte Connection board PL 8143 A06

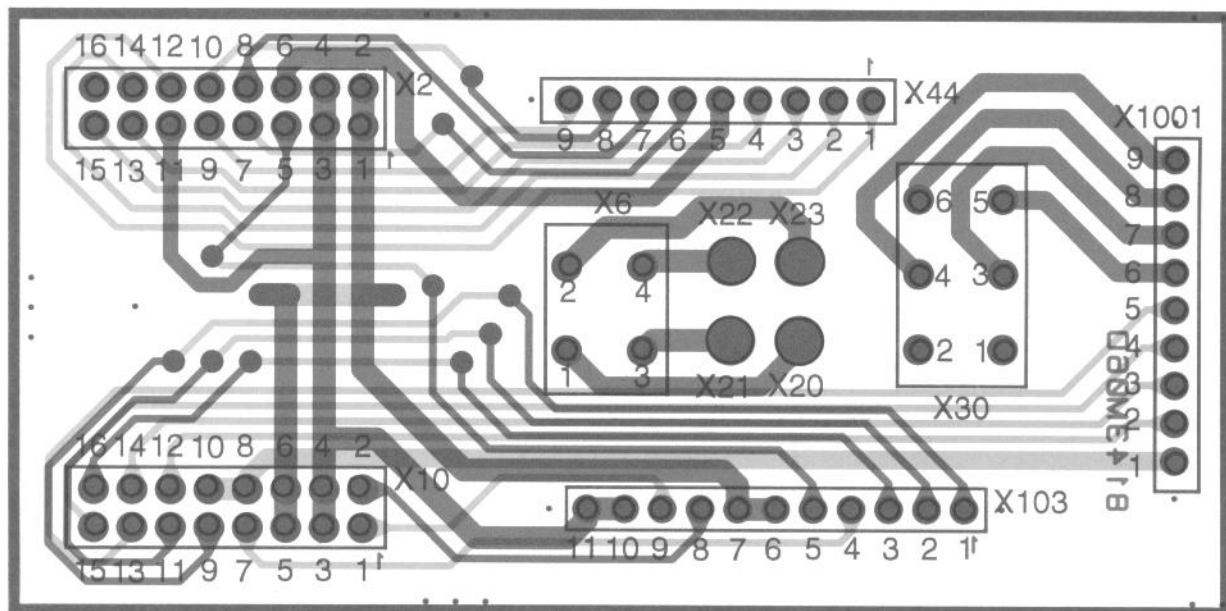

X10

1 = SDA	11 = MIKE
2 = SCL	12 = Tape L
3+4 = Masse	13 = Radio R
5+6 = U15	14 = Tape R
7 = DK / WT	15 = Radio L
8+10 = Signal-Masse	16 = SL
9 = MIC - NF	

X103

1 = MIC = NF
2 = MIKE
3 = SL
4 = DK / WT
5 = EIN
6+7 = U15
8 = SCL - CDA
9 = SDA - CDA
10+11 = Masse

X30

3 = REM - MVP
4 = MVP - Masse
5 = TEL Mute
6 = TEL Masse

X6

1+3 = VIDEO - TON
2+4 = MIC

X2

1+2 = U15	10 = COC P. R+
3+4 = Minus/Masse	11 = Masse
5 = Ein	12 = CAB L-
6 = U150	13 = CAB L+
7 = COCP. L-	14 = CAB R-
8 = COCP. L+	15 = CAB R+
9 = COCP. R-	

X44

1 = CAB L-
2 = CAB R-
3 = CAB R+
4 = CAB L+
5 = COCP. L-
6 = COCP. L+
7 = COCP. R+
8 = COCP. R-

X1001

1 = Signal - Masse
2 = Tape L
3 = Tape R
4 = Radio L
5 = Radio R
6 = TEL Mute
7 = REM - MVP
8+9 = Masse

Schalterplatte
Key board
PL 8134 A07



Cockpit

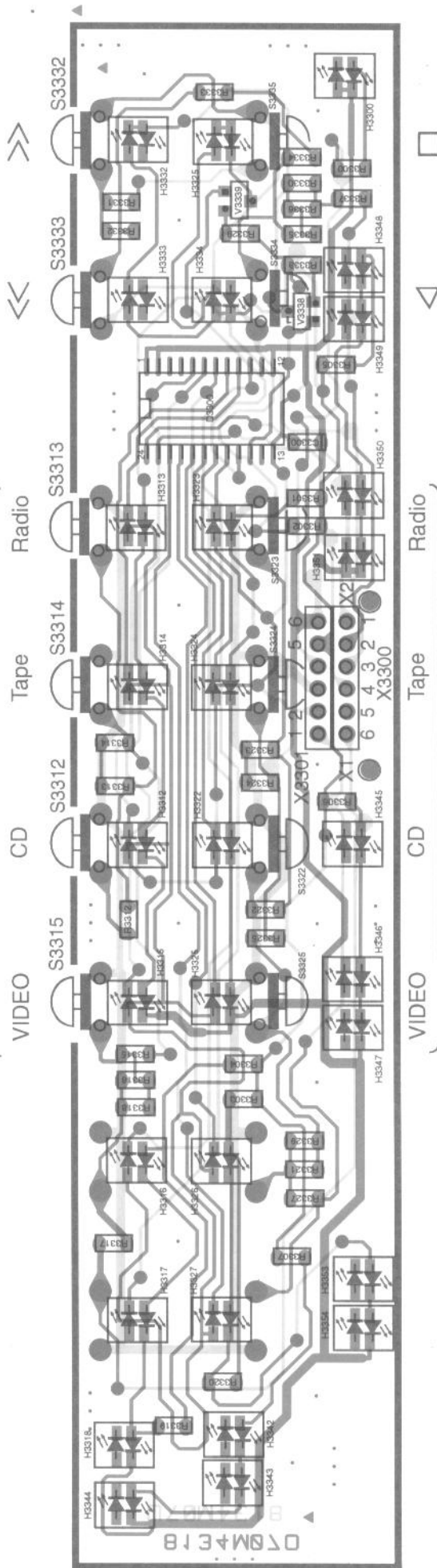

Cabine

X3301
1 = TA - C
2+4 = U5
3 = Masse
5 = U15
6 = Masse

X3300
1 = SCL - COM
2 = TA - REM
3 = CODE
4 = SDA MIC
6 = TA - F

X80 = MIC A	X90 = MIC B	X60 = CD
1 = NF - IN	1 = NF - IN	2 = Masse
2 = MIC - EIN	2 = MIC - EIN	3 = L - IN
3 = Masse	3 = Masse	5 = R - IN
4 = NF - IN	4 = NF - IN	8 = 12V → CD

X1000	
1 = Masse	6 = Tel - Mute
2 = Tape - L	7 = REM - MVP
3 = Tape - R	8+9 = Masse
4 = Radio - L	
5 = Radio - R	

X200 = Video Ton
1 = Masse
2 = Video Ton - IN
X1590 + X1591 =
X860 + X831 =

Hauptplatte
Main board
PL 8138 A09

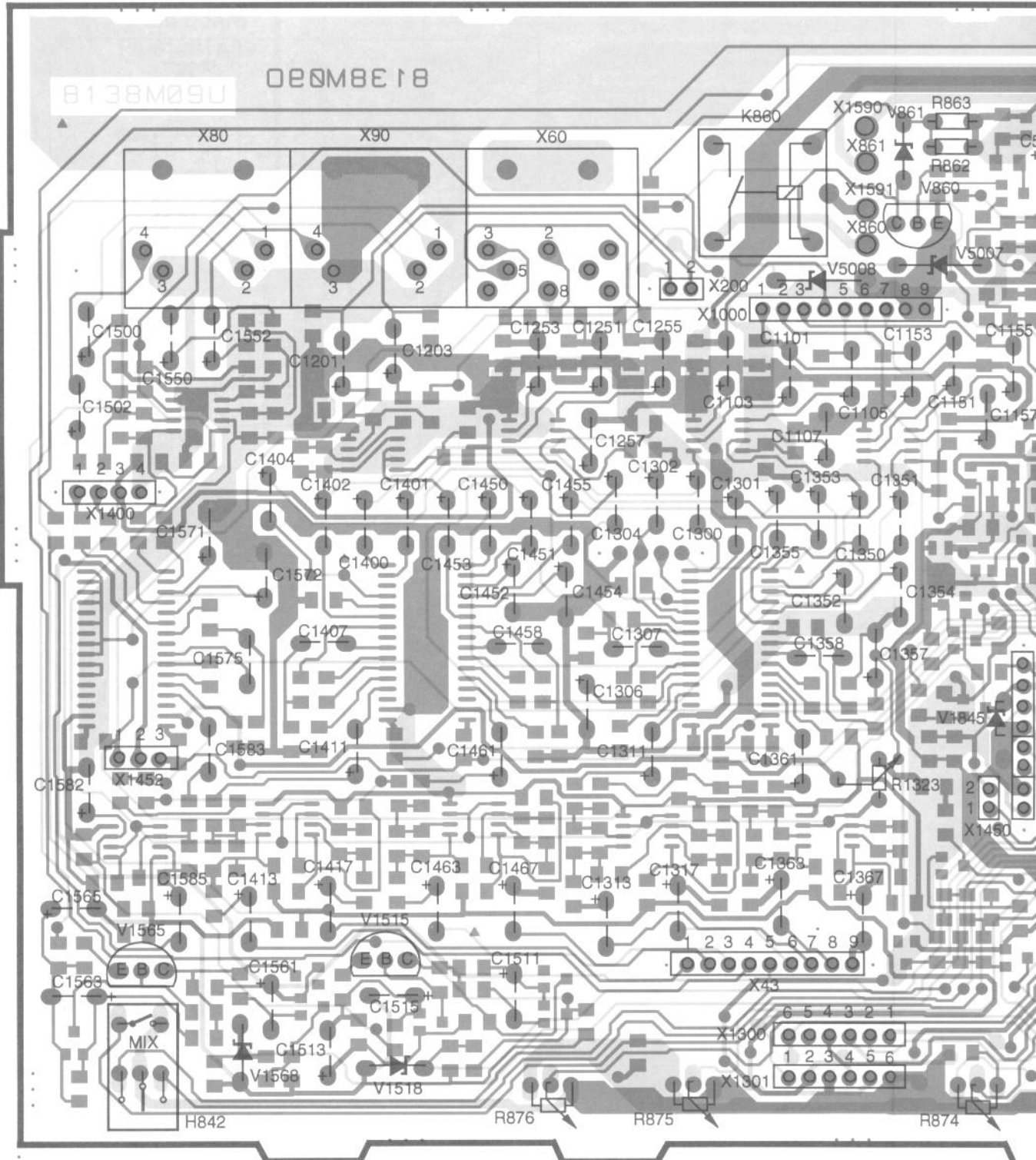

Volume
Cabin

Treble

Bass

Balance

X1300	
1 = SCL - COM	
2 = TA - REM	
3 = CODE	
4 = SDA MIC	
6 = TA - F	

X1301	
1 = TA - C	
2+4 = U5	
3 = Masse	
5 = U15	
6 = Masse	

Mute
M - MVP
se

X200 = Video Ton

- 1 = Masse
- 2 = Video Ton - IN

X1590 + X1591 = MIC

X860 + X831 = Video - Ton

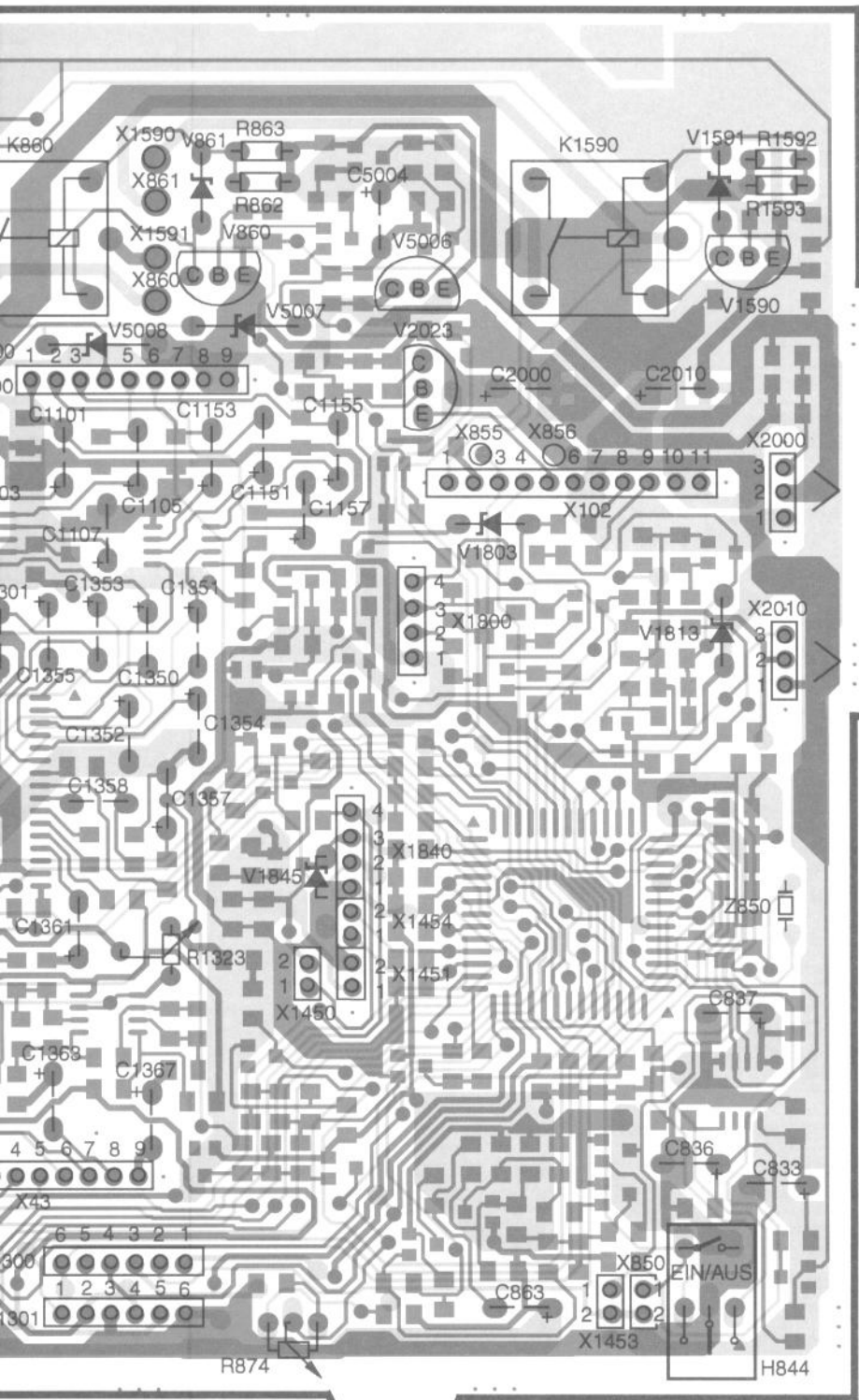

X102	
1	MIC - NF
2	MIKE
3	SL
4	DK / WT
5	EIN
6+7	U15
8	SCL - CDA
9	SDA - CDA
10+11	Masse

8V
STABY

X1800	
1	U15D
2	SCL - CDA
3	Masse
4	SDA - CDA

5V
STABY

X1840	
1	Masse
2	CDC - ON
3	FB - TOD
4	FB - RD1

X43	
1	CAB L-
2	CAB R-
3	CAB R+
4	CAB L+
5	COCP. L-
6	COCP. L+
7	COCP. R+
8	COCP. R-

Balance

Volume
Cockpit

300
- COM
REM
E
MIC
F

X1301	
1	TA - C
2+4	U5
3	Masse
5	U15
6	Masse

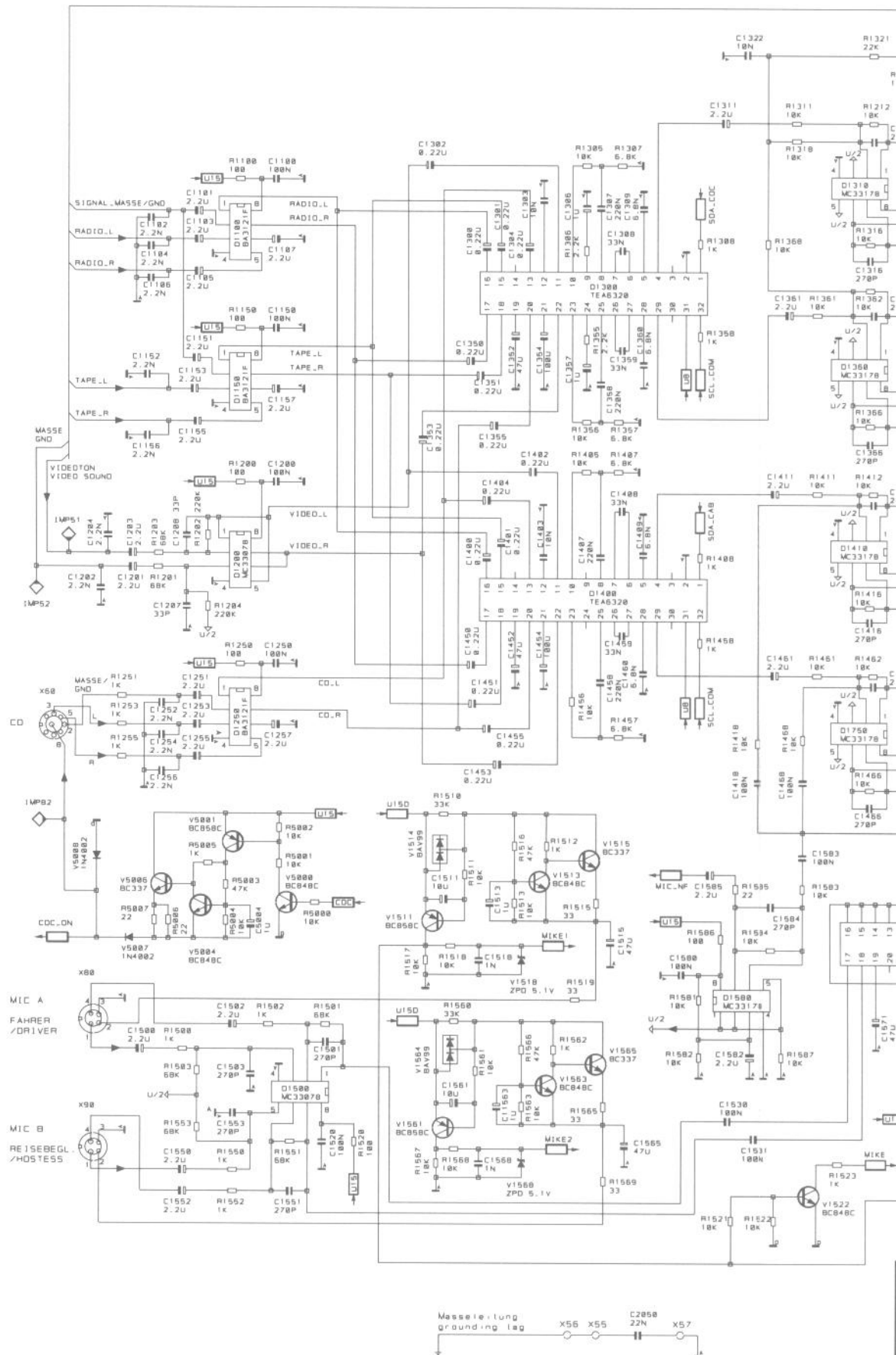

PL138 HAUPTPLATTE
MAIN-PCB

(auf der Unterseite)
(at the bottom)

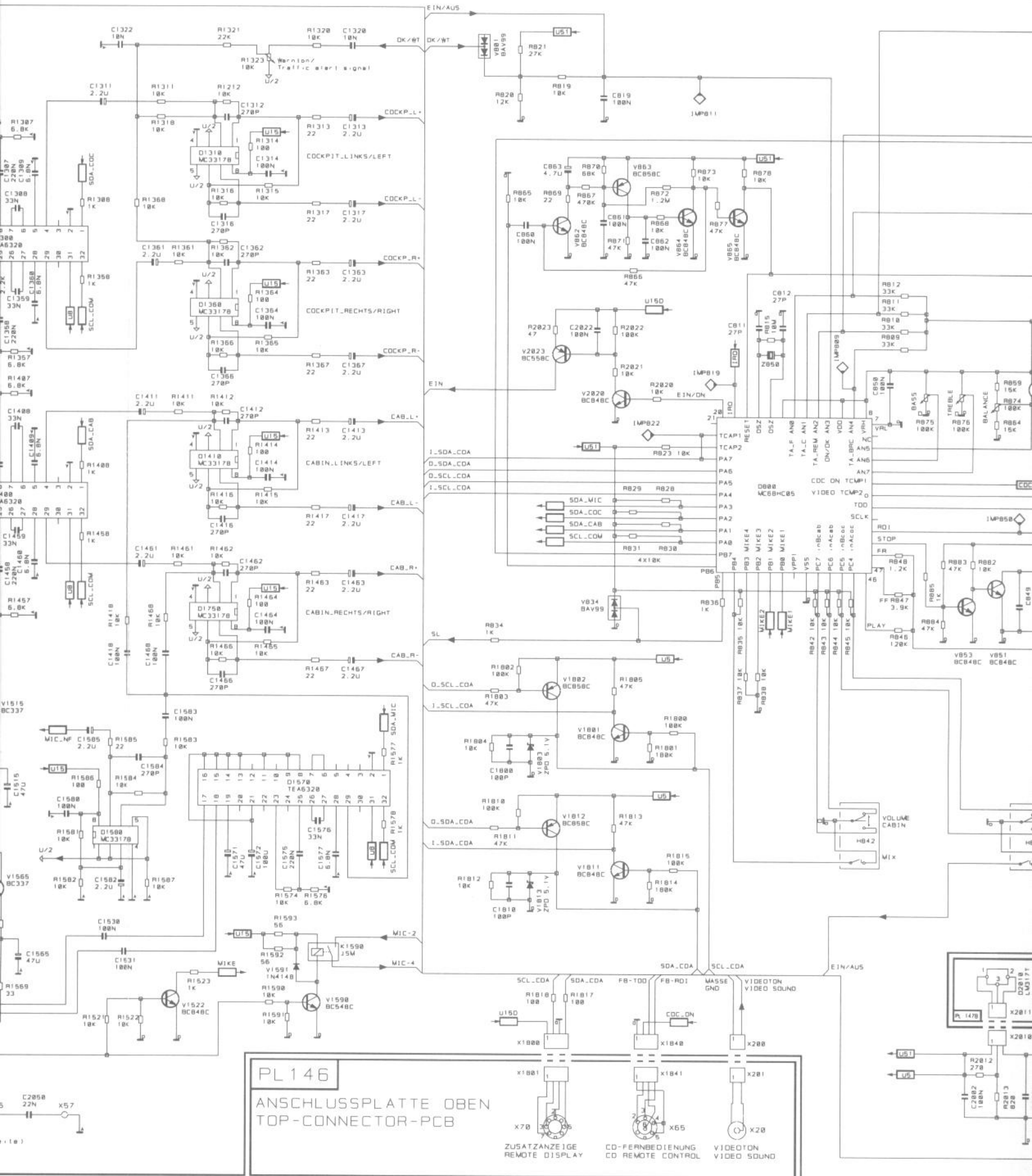

PL 146
ANSCHLUSSPLATTE OBEN
TOP-CONNECTOR-PCB
 ZUSATZANZEIGE REMOTE DISPLAY
 CD-FERNBEDIENUNG CD REMOTE CONTROL
 VIDEO/TON VIDEO SOUND

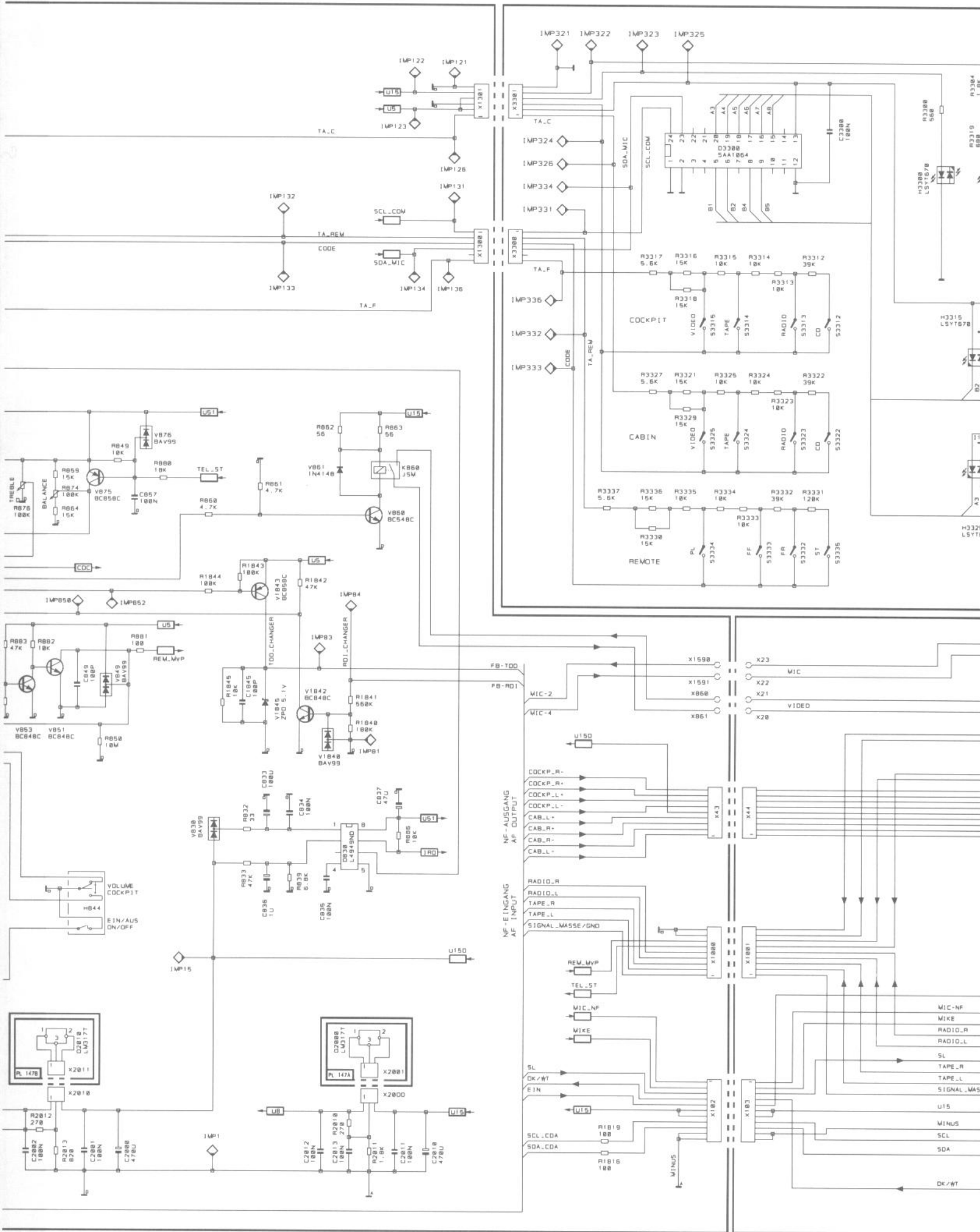

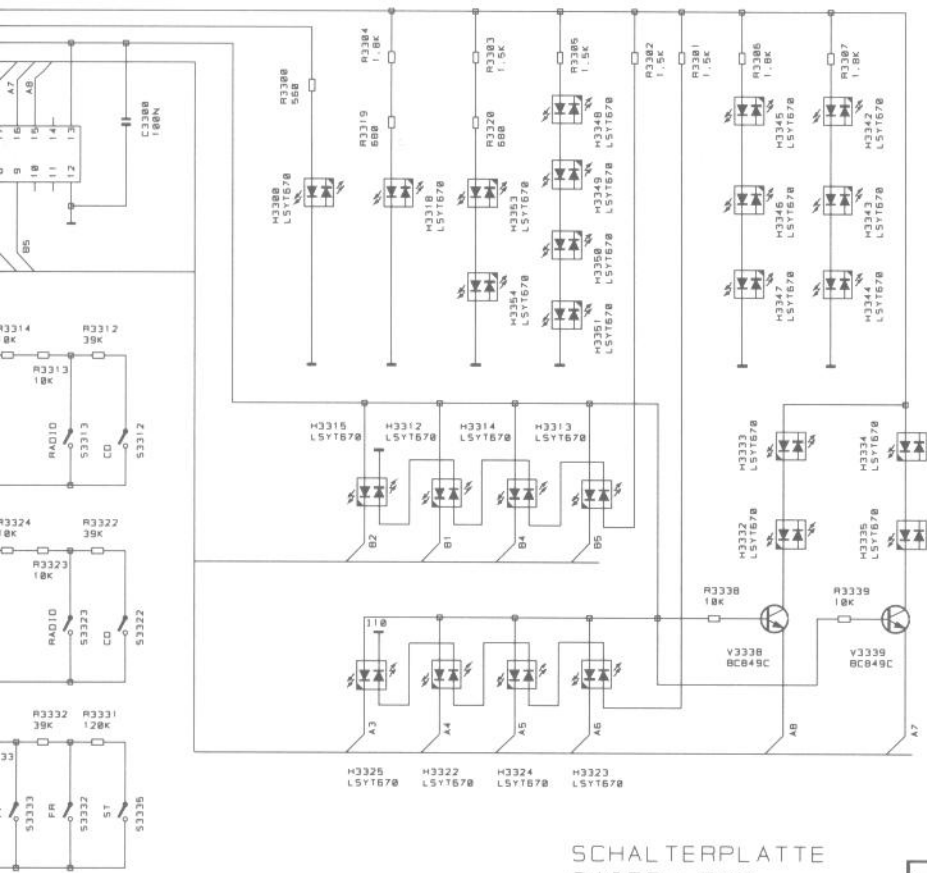

SCHALTERPLATTE
SWITCH-PCB

PL 134

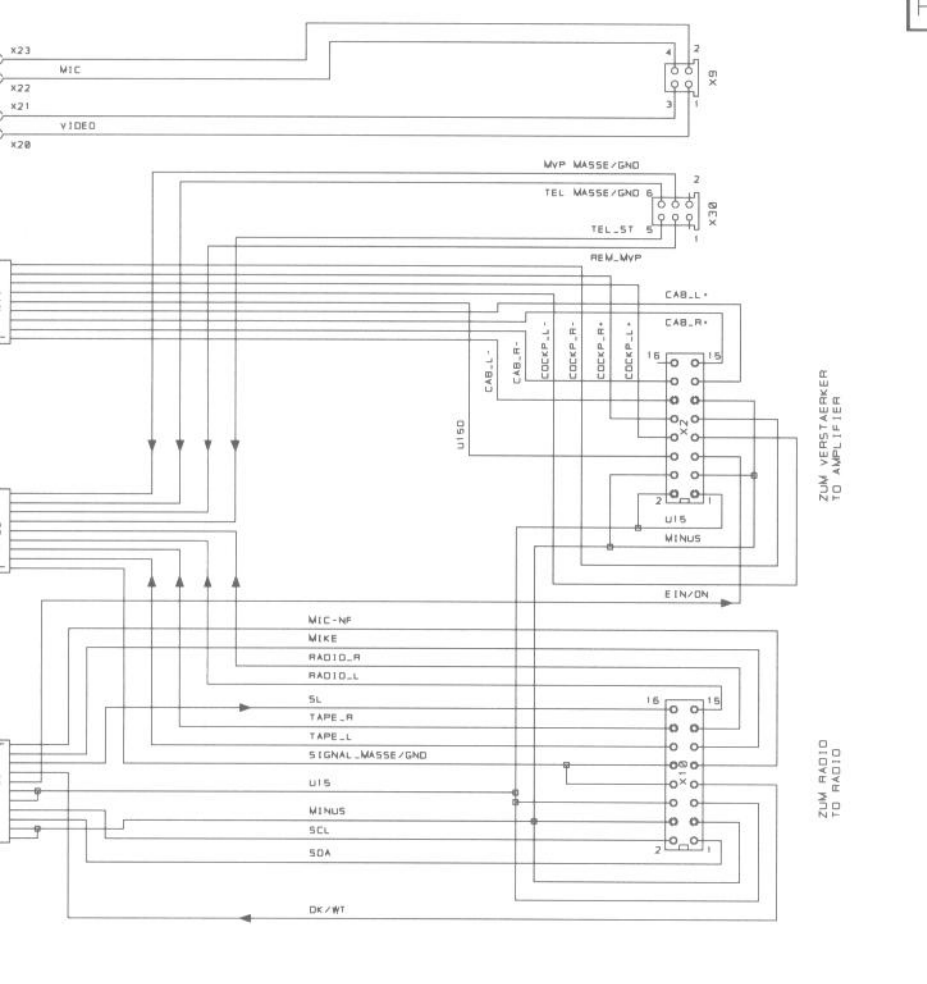

ANSCHLUSSPLATTE
CONNECTOR-PCB

PL 143

Hauptplatte
Main board
PL 8138 A09

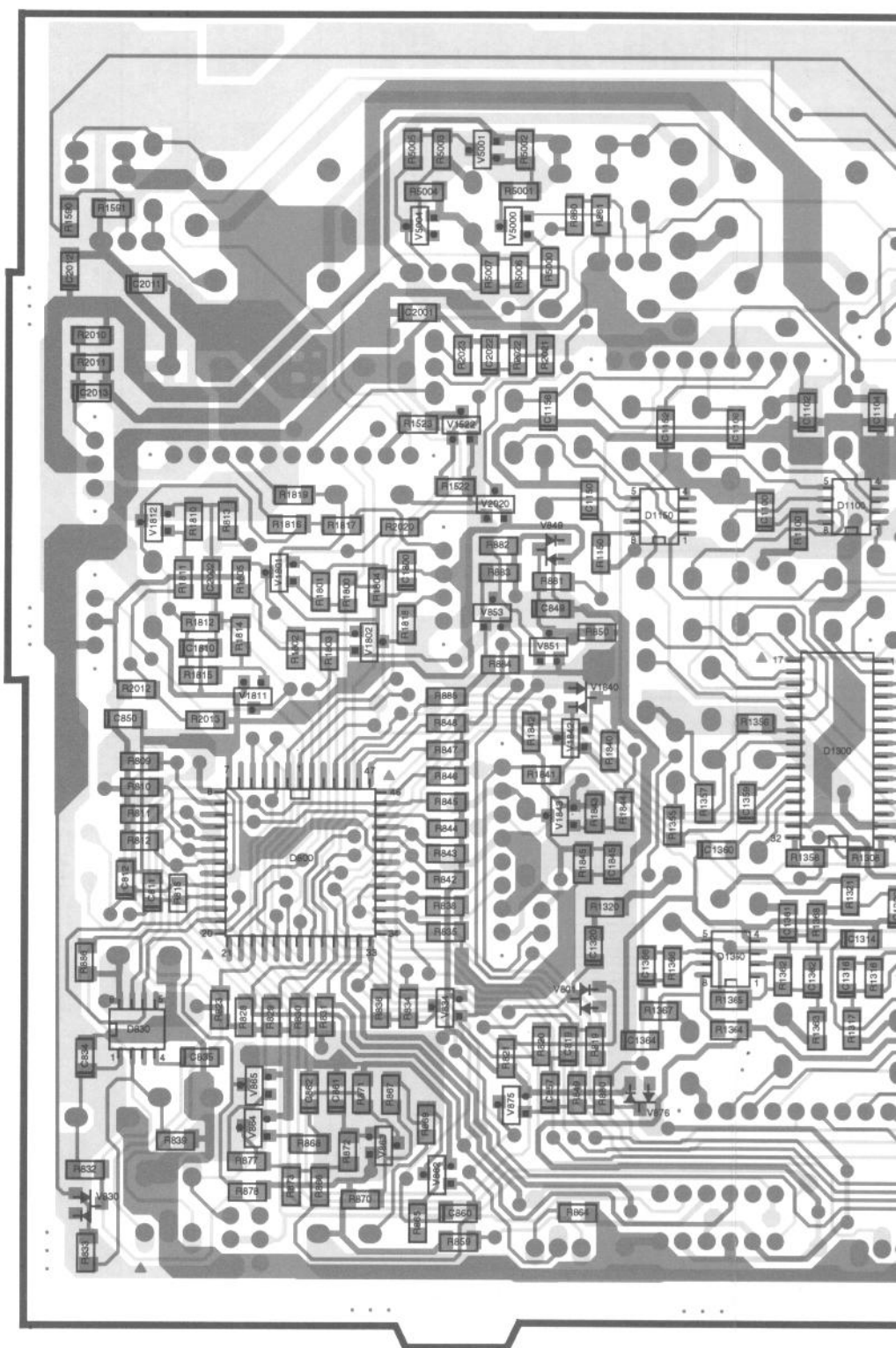



8138M090

UP0M8E18

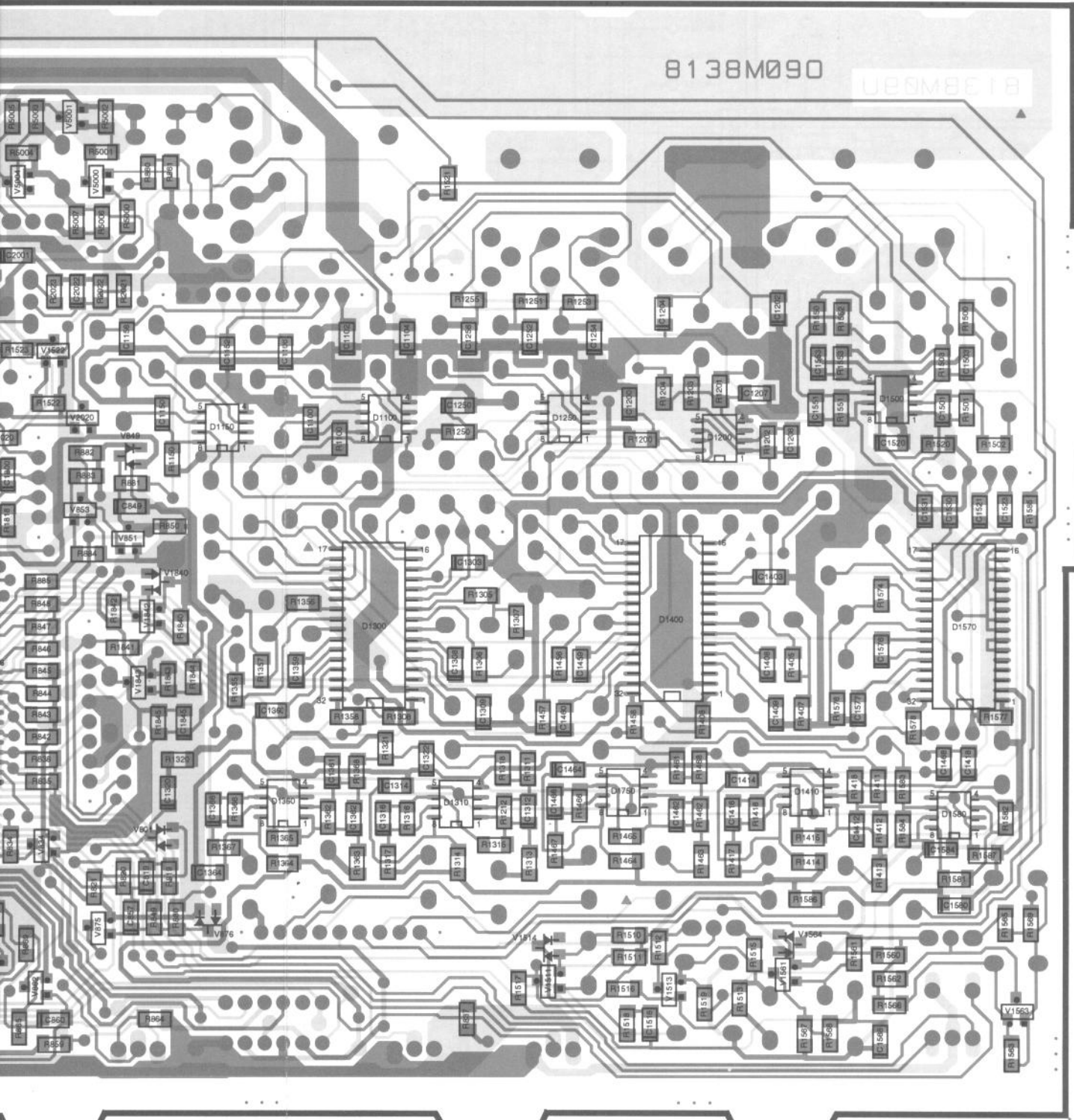

Blaupunkt-Werke GmbH, Hildesheim

Änderungen vorbehalten! Nachdruck - auch auszugsweise - nur mit Quellenangabe gestattet!

Modification réservées! Reproduction - aussi en abrégé - permise seulement avec indication des sources utilisées

Gedruckt in Deutschland
Printed in Germany by Oeding Druck
38100 Braunschweig

Modification reserved! Reproduction - also in abbreviated form - only permitted with indication of sources used
Modificaciones reservadas! Reproduction - también en abreviado - solamente permitida con indicación de fuentes utilizadas