

GTS50  
2 CHANNEL  
AUTOMOTIVE  
POWER AMPLIFIER  
TECHNICAL MANUAL

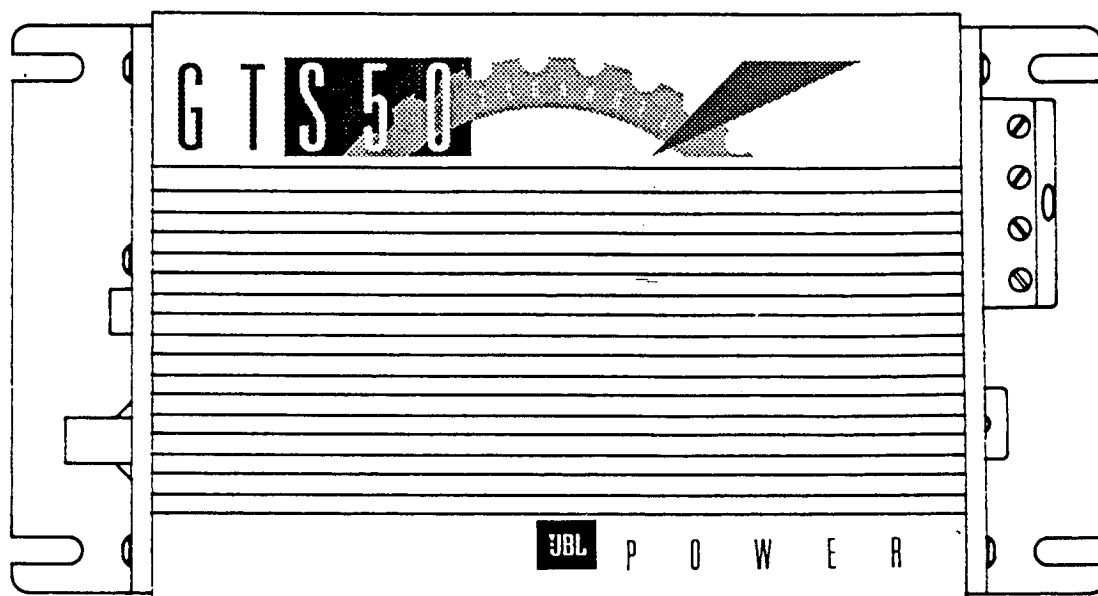

JBL Consumer Products Inc.  
240 Crossways Park West  
Woodbury, NY 11797  
800-645-7484

## GTS50 TABLE OF CONTENTS

Features .....	1
Specifications .....	1-2
Disassembly Procedure .....	2
Exploded View .....	3
Parts List .....	4-5
Block Diagram .....	6
Detail of IC's/Transistors .....	7
IC/ Transistor Pin Voltages .....	8
Wiring Diagram .....	9
PC Board Layout .....	10
Schematic Diagram .....	11
Packaging Exploded View .....	12
Installation Wiring Diagram .....	13

## JBL GTS50 POWER AMPLIFIER FEATURES

### **Minimal Negative Feedback**

All amplifiers require some form of negative feedback to minimize distortion and stabilize the amplifier. Too much feedback, however, increases the Transient Intermodulation Distortion (T.I.M.), and reduces its musicality. JBL's Minimal Negative Feedback design provides just enough feedback to stabilize the amplifier., remove DC offset, and offer excellent Total Harmonic Distortion (T.H.D.) characteristics.

### **Speaker Level Input Capability**

These inputs can be connected to high or standard power head units that do not have a pre-amp output. The head unit's internal fader and balance controls will continue to function properly as this speaker input circuitry emulates a speaker instead of an open load.

### **Quiet Start Circuitry**

Special turn on and turn off circuitry have been implemented to prevent amplifier turn on and turn off pops.

### **Second Order (12dB per octave) Capacitive/Inductive Power Supply Input Filtering**

This specially designed battery voltage input section provides excellent immunity to system noises such as alternator whine.

### **Full Protection Circuitry**

All JBL amplifiers are protected against over-temperature, over-current, over-voltage, input overload, and DC offset. These special circuitries protect the amplifier from installation errors and unfriendly environmental conditions. However, none of these protection systems is in the signal path. They cannot interfere with the sonic performance of the amplifier.

## JBL GTS50 POWER AMPLIFIER SPECIFICATIONS

1. Minimum Power Output into 4 ohms, 2-channel mode, 1 kHz, 1% THD:  
**18 Watts x 2**
2. Minimum Power Output into 2 ohms, 2-channel mode, 1 kHz, 10% THD:  
**22 Watts x 2**
3. Maximum THD at 1 watt into 4 ohms, 1kHz, 2-channel mode:  
**1% (400 Hz HPF, 30 kHz LPF)**

4. Minimum Signal-to-Noise Ratio into 4 ohms, inputs shorted, Gain Controls at Min., 2-channel mode:

**85 dBA**

5. Input Sensitivity, Gain Control at maximum:

**RCA Inputs: 150 mV  $\pm$ 25%**

**Speaker Inputs: 2.5 V  $\pm$ 25%**

6. Minimum Channel Separation, referenced to 20 watts into 4 ohms, 2-channel mode:

**1 kHz: 45 dB**

7. Gain Control Range, from MIN to MAX, 1 watt, 2-channel mode:

**1 kHz: 20 dB  $\pm$  20%**

8. Output Level Deviation into 4 ohms, 1 watt, 1 kHz reference, 2-channel mode:

**20 Hz: -3 dB or less**

**1 kHz: 0 dB (reference)**

**20 kHz: -3 dB or less**

9. Current Consumption, 4 ohms, 2-channel mode, 1 kHz signal, 14.4V battery:

**18 Watts x 2: 8 A or less**

**No Input Signal: 1 A or less**

### GTS50 DISASSEMBLY PROCEDURE

**Note:** REFER TO EXPLODED VIEW FOR PARTS DESIGNATION.

1. Remove 6 screws (17) securing bottom plate (4).
2. Remove bottom plate to expose main P.C. board assembly.
3. To remove main P.C. board assembly from chassis/heat sink assembly:
  - a) Remove 1-Phillips screw (16) from RCA input jack.
  - b) Release speaker input jack by compressing mounting tabs.
  - c) Remove 4 T-10 torx screws (15) from opposite end of chassis.
  - d) Remove 3 screws (12) that secure I.C. heat sink bracket (9) to chassis.
  - e) Main P.C. board will now slide out of chassis. Care should be taken to protect leads of red L.E.D. that extend beyond P.C. board. During reassembly, align the red L.E.D. before securing panel.

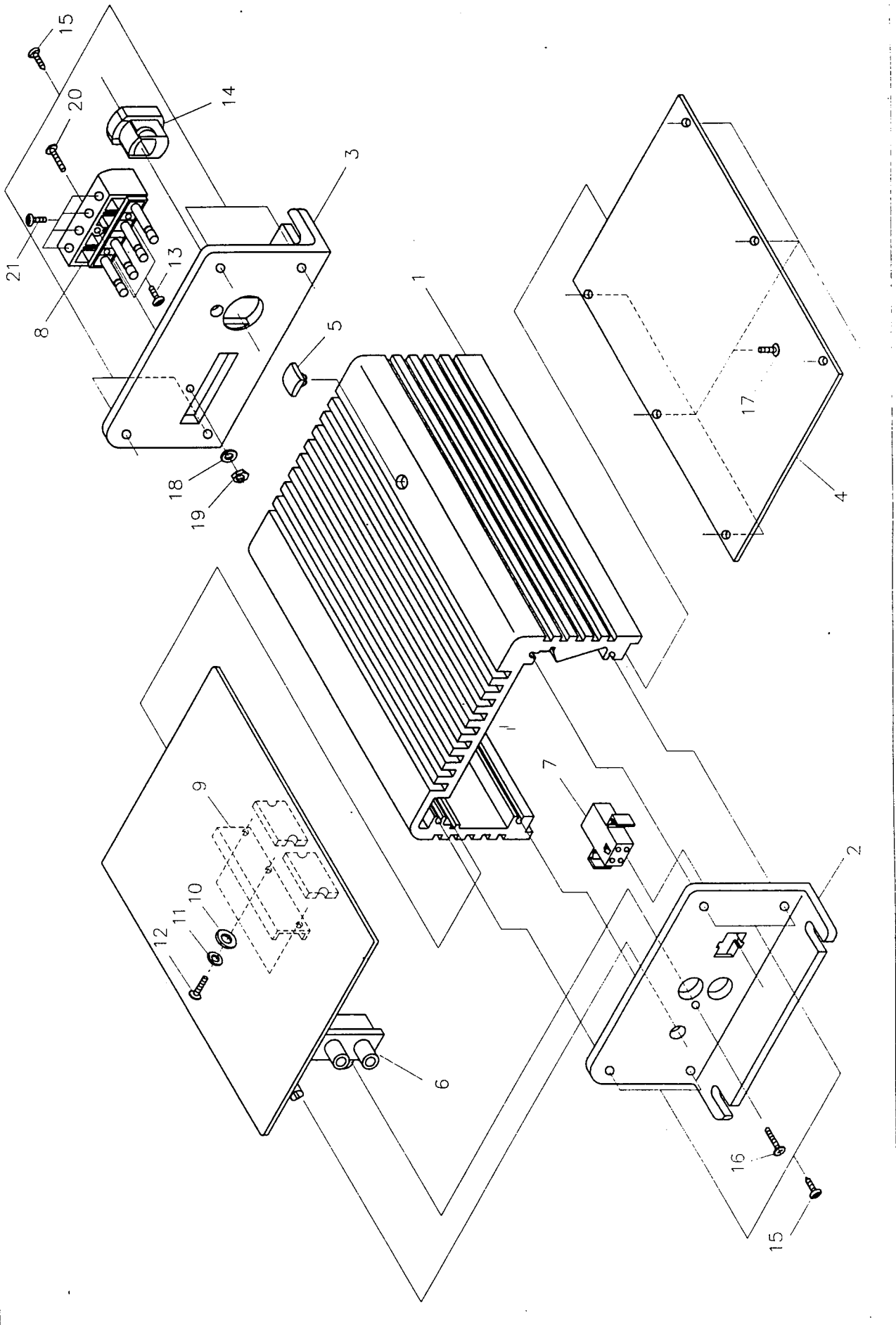

REV: D	MODEL: GTS50	REVISE DATE: SEPT. 9, 1992		
PART NO.	REFERENCE NO.	CODE	DESCRIPTION	QTY
*** P.C.B. SECTION ***				
1-18-010	R13,R16,R29,R32	RES	1/4W +-5% PS 1 OHM	4
1-18-075	R12,R15,R28,R31		1/4W +-5% PS 75 OHM	4
1-18-310	R34,R36		1/4W +-5% PS 1K OHM	2
1-18-322	R37,R38,R39		1/4W +-5% PS 2.2K OHM	3
1-18-330	R3 ,R7 ,R8 ,R11,R14,R19, R23,R24,R27,R30,R35		1/4W +-5% PS 3K OHM	11
1-18-410	R9 ,R25		1/4W +-5% PS 10K OHM	2
1-18-427	R40		1/4W +-5% PS 27K OHM	1
1-18-433	R10,R26		1/4W +-5% PS 33K OHM	2
1-18-468	R4 ,R5 ,R6 ,R20,R21, R22,R33		1/4W +-5% PS 68K OHM	7
1-18-518	R2 ,R18		1/4W +-5% PS 180K OHM	2
1-20-210	R1 ,R17		1W +-5% METAL OXIDE 100 OHM	2
1-10-301	C3 ,C14,C17,C28	M. CAP	100V +-10% 0.001UF	4
1-10-347	C9 ,C12,C23,C26,C32		100V +-10% 0.047UF	5
1-12-010	C2 ,C6 ,C16,C20	E. CAP	50V +-20% 5x11 1UF	4
1-12-110	C1 ,C4 ,C15,C18,C29,C31		16V +-20% 5x11 10UF	6
1-12-147	C7 ,C21		16V +-20% 5x11 47UF	2
1-12-210	C8 ,C11,C22,C25		10V +-20% 6x11 100UF	4
1-12-220	C10,C13,C24,C27,C30		10V +-20% 6x11 220UF	5
1-12-522	C33,C34		16V +-20% 13x21 2200UF	2
1-16-110	C5 ,C19	C. CAP	50V +-10% 100PF B TYPE	2
1-09-009	IC1,IC2	IC	TA8225H	2
1-07-004	TR1,TR2,TR3	TRAN	9014C	3
1-05-001	D2,D3,D4	DIODE	IN4001	3
1-06-001	D1	ZENER	1/2W +-5% 5.1V	1
1-25-150	LD1	LED	MRB31D RED LED	1
1-01-101	T3	COIL	E1-19 24Ts	1
1-01-104	T1,T2		E1-19 10K:10K	2
1-26-104	VR1A,VR1B	VAR. R	RK14K12200A02A 20Kax2	1
1-50-035A	PC1	FUSE	GTS50 F/WIRE SET + 7A F/SET	1
1-50-026	GC1	WIRE	30/0.193x3mm PVC J/W	1
1-50-26B	RC1		BLACK WIRE 610mm (5+15) 23/0.193x2.25mm PVC J/W DACK	1
1-51-036	WS1,WS2		BLUE/WHITE STRIPE 610mm (5+15) AWG#28 SHIELD WIRE 2 PIN BROWN	2
3-60-009B	MAIN PCB	PCB	70mm (20+20) A/B 2031 MAIN P.C.B. REV. C	1

## MECHANICAL PARTS LIST

REV: D	MODEL: GTS50	REVISE DATE: SEPT. 9, 1992		
PART NO.	REFERENCE NO.	CODE	DESCRIPTION	QTY
3-60-014	1	PANEL	2031B-4 TOP COVER HEAT SINK	1
3-60-011	2		2031B-1 FRONT PANEL	1
3-60-012	3		2031B-2 REAR PANEL	1
3-60-013	4		2031B-3 BOTTOM COVER	1
3-61-009	5		2018B-9 BADGE	1
1-43-012	6	JACK	B217A 2RCA JACK (R/W) GOLD P.	1
1-50-045	7	CON	2004-04R 4POLE FEMALE CON. SET	1
3-60-015A	8		SPEAKER TERMINAL ASSEMBLY	1
3-60-008	9	BKT	2031-8 IC BKT.	1
1-37-130	10	S&W	M3 FLAT WASHER ZNC	2
1-37-230	11		M3 SPRING WASHER ZNC	3
1-35-314	12		3x14 TTB-PH ZNC	3
1-33-206	13		2x6 PT BZ	2
1-44-470	14		WIRE CLIP CONNECTOR SR-F42	1
1-35-307	15		TORX T10 TTB-BTN 3x10 TIN	8
1-35-308	16		TTB-PH 3x10 TIN	1
1-35-305	17		MSB 3x6 TIN	6
1-37-230	18		M3 SPRING WASHER ZNC	1
1-37-030	19		M3 NUT	1
1-35-381	20		MSP 3x20 TIN	1
3-24-007	21		M3x7 NI BM	4

## PARTS LIST FOR PACKAGE

REV: D	MODEL: GTS50	REVISE DATE: SEPT. 9, 1992		
PART NO.	REFERENCE NO.	CODE	DESCRIPTION	QTY
GTS50-1	22		GTS50 SET	1
GTS50-2	23		GIFT BOX	1
2031-P1	24		INNER BOX 2031-P1 BIG	1
2031-P2	25,26		INNER BOX 2031-P2 SMALL	2
1-29-104	26-1		FUSE LAMP 7A	1
1-36-120	26-2		10x5/8 PA BZ	4
1-37-150	26-3		M5 FLAT WASHER BZ	4
1-37-250	26-4		M5 SPRING WASHER BZ	4
GTS50-3	27-1		OWNER'S MANUAL	1
GTC-001	27-2		WARRANTY CARD	1
1-50-044	28		2004-04P1 4POLE MALE CON. SET	1

GTS--50 BLOCK DIAGRAM

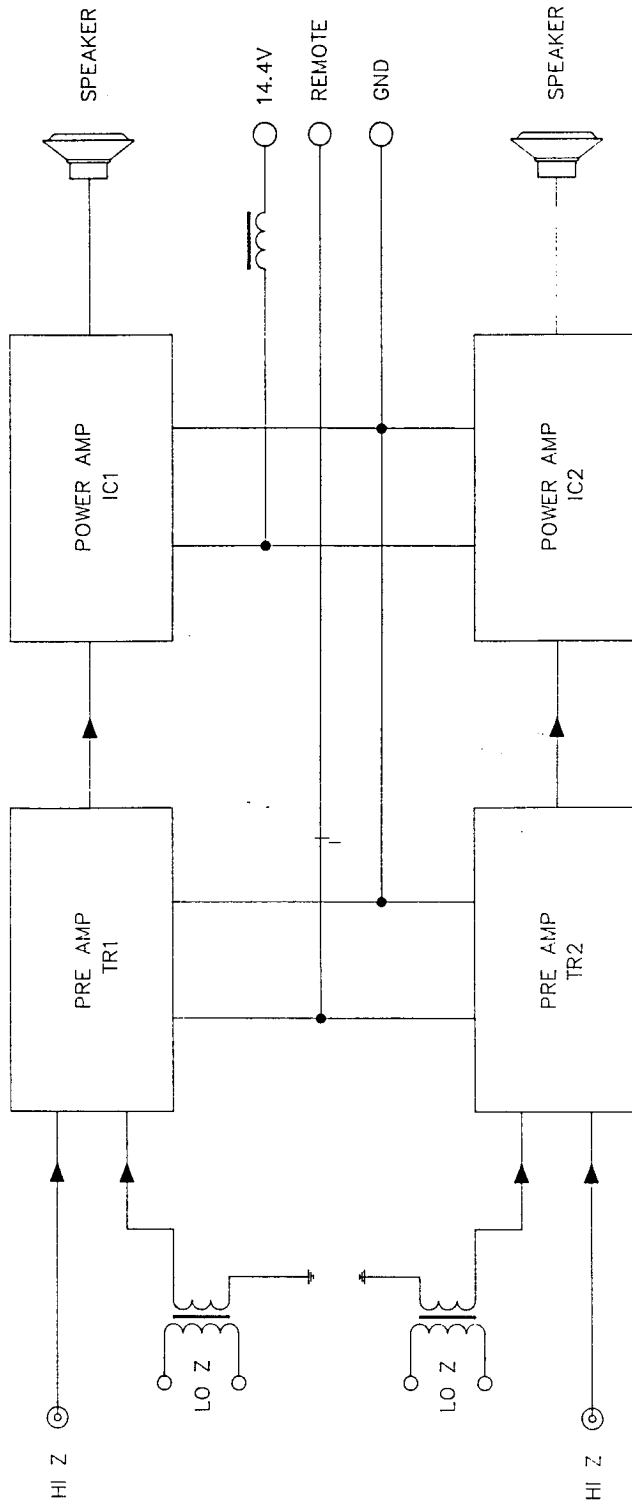



DETAIL OF IC'S

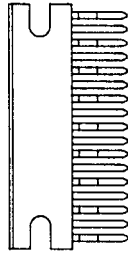

TA8225H

DETAIL OF TRANSISTORS

2N3904  
MPS-A06  
MPS-A56  
9014C  
9015C

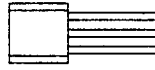

GTS-50

MEASUREMENT REQUIRED

TYPICAL AT IC PINS

MEASUREMENT METER: DIGITAL MULTI METER

POWER SOURCE: DC +14.4V

INPUT: NO SIGNAL INPUT

PIN NO. IC NO.	1	2	3	4	5	6	7	8	9	10	11	12	13	14	15	16	17
IC1,IC2	6.4V	N.C.	1.9V	0V	0V	0V	1.9V	N.C.	7.3V	14.4V	0V	13.4V	0V	0V	13.3V	0V	14.4V

TYPICAL AT TRANSISTOR PINS

TRANSISTORS (UNIT: VOLTS)

PIN NO. TRA.NO.	C	B	E
TR1	6V	3V	2.4V
TR2	6V	3V	2.4V
TR3	1.7V	2.3V	1.7V

# GTS50 WIRING DIAGRAM

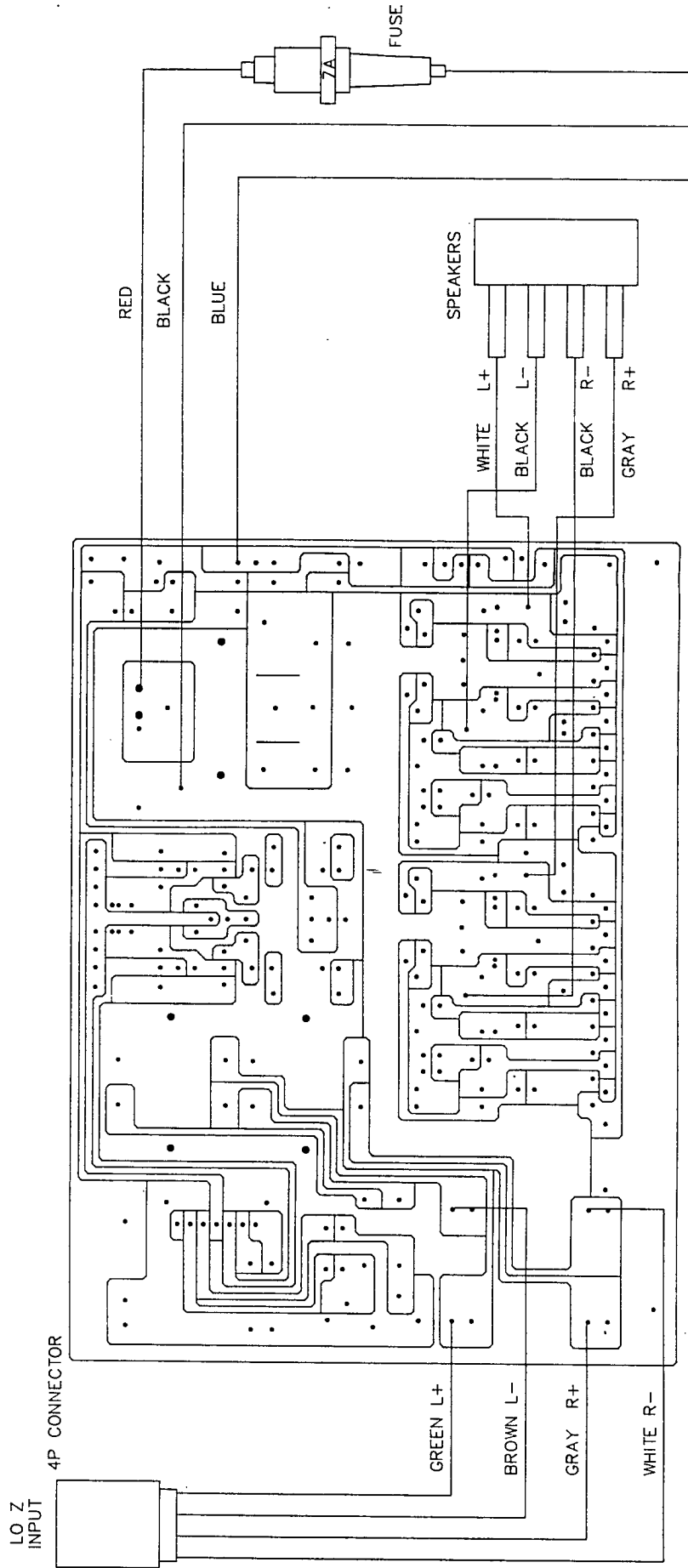

# GTS50 PC BOARD LAYOUT

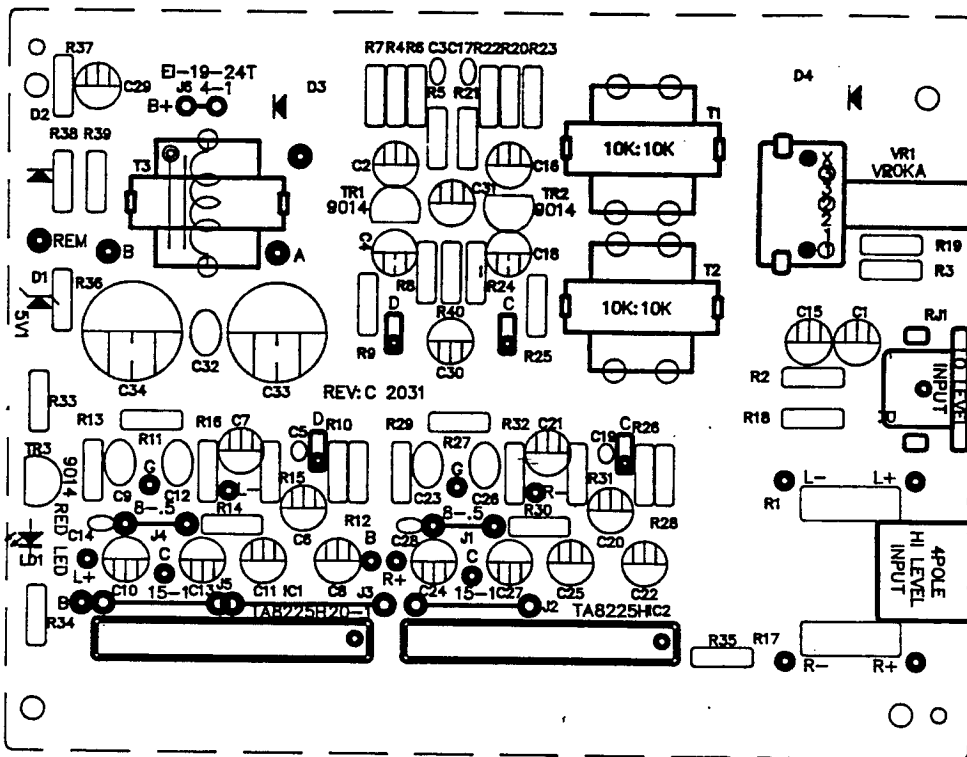

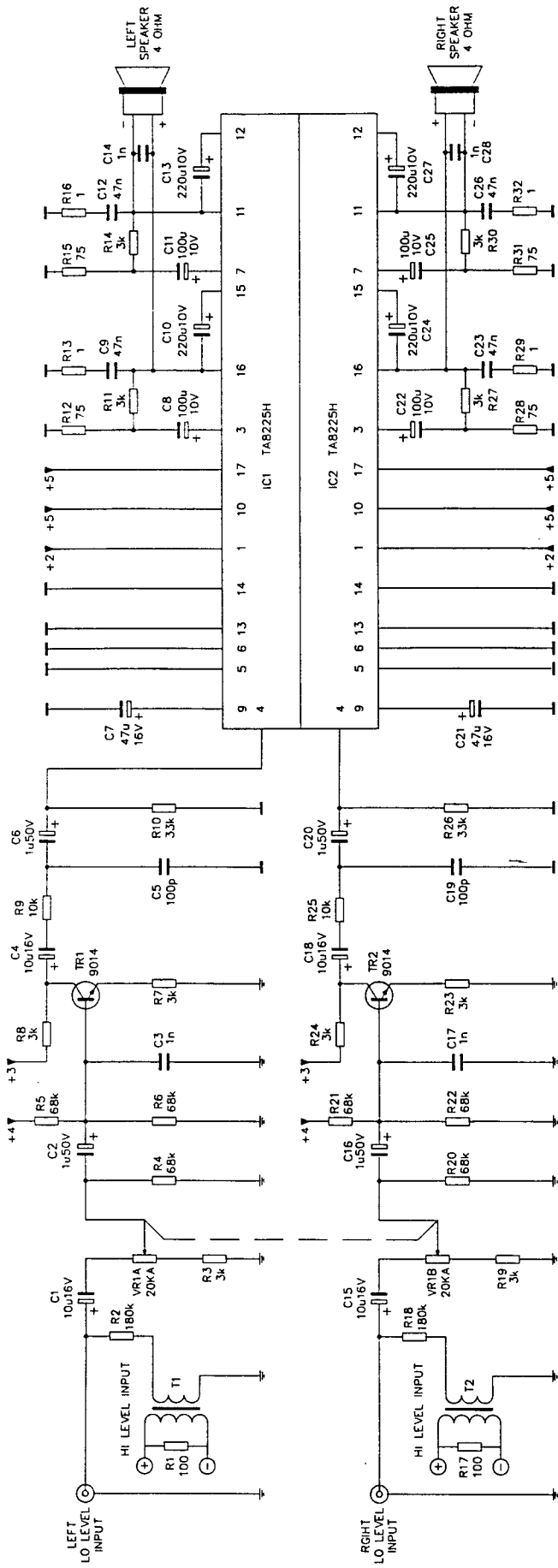

MODEL: GTS-50  
SCHEMATIC DIAGRAM

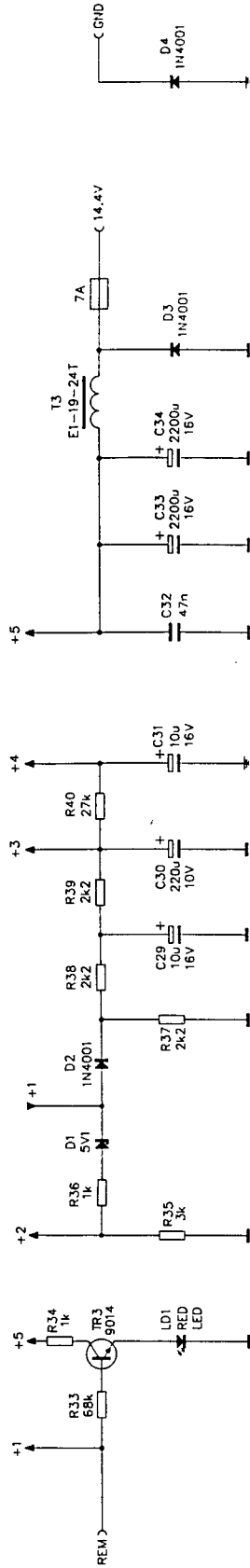

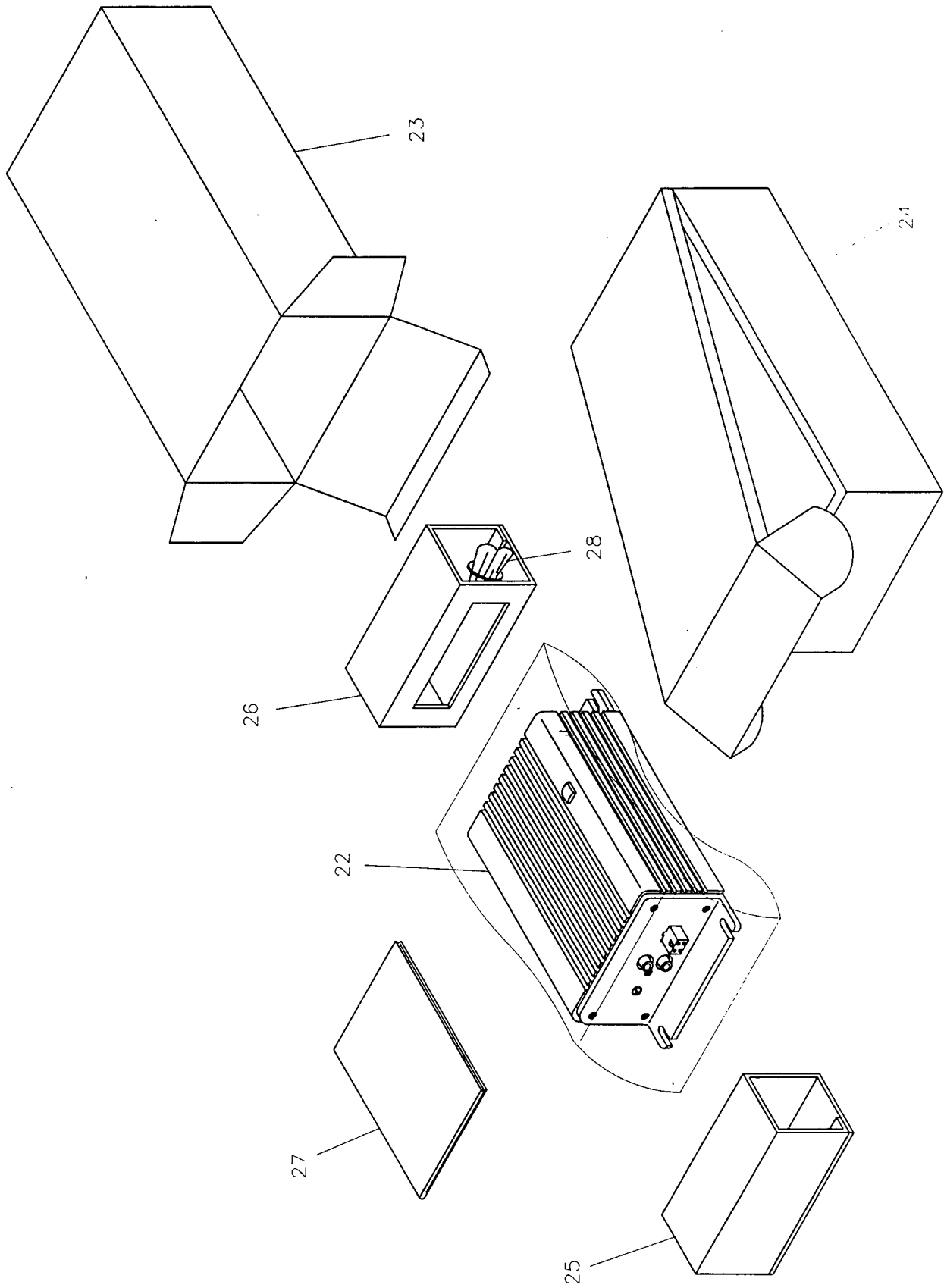

# GTS 50 WIRING DIAGRAM

