

DVD

Service Manual

1. Ergänzung / Supplement 1

DVD
VIDEO

COMPACT
disc
DIGITAL AUDIO



XENARO

GDP 5100	GMI8600
GDP 5100 /1	GMI6100
GDP 5100 /2	GMI8700
GDP 5102	GMI8900
GDP 5120	GMI9200
GDP 6150 /1	GMI6000
GDP 6150 /2	GMI9300

MALAGA

SE 1230	GMI6200
----------------	---------

Zusätzlich erforderliche Unterlagen für den Komplettservice
Additionally required Service Documents for the Complete Service

Service Manual

**GDP 51...
GDP 61...
SE 1230**

Materialnr./Part No.
720105408500

Service Manual

**Sicherheit
Safety**

Materialnr./Part No.
720108000000

Grundig Service

Hotline Deutschland...
...Mo.-Fr. 8.00-18.00 Uhr

Technik:

TV	0180/52318-41
TV	0180/52318-49
SAT	0180/52318-48
VCR/LiveCam	0180/52318-42
HiFi/Audio	0180/52318-43
Car Audio	0180/52318-44
Telekommunikation	0180/52318-45
Fax:	0180/52318-51

Planatron (8.00-22.00 Uhr) 0180/52318-99

Ersatzteil-Verkauf: Mo.-Fr. 8.00-19.00 Uhr

Telefon: 0180/52318-40
Fax: 0180/52318-50

Kundendienst/Werkstätten: Mo.-Fr. 8.00-18.00 Uhr

Telefon: 0180/52318-52
Fax: 0180/52318-46

gebührenpflichtig

Materialnummer/Part Number 720105408600

Änderungen vorbehalten/Subject to alteration • Printed in Germany

E-BS-SA15 1001

<http://www.grundig.com>

Es gelten die Vorschriften und Sicherheitshinweise gemäß dem Service Manual "Sicherheit", Materialnummer 720108000000, sowie zusätzlich die eventuell abweichenden, landesspezifischen Vorschriften!



The regulations and safety instructions shall be valid as provided by the "Safety" Service Manual, part number 720108000000, as well as the respective national deviations.

Inhaltsverzeichnis

	Seite
Allgemeiner Teil	2...3
Einführung	2
Geräteübersicht	3
Platinenabbildungen und Schaltpläne	4...12
Digital-Platte	4
• Audio/Interface (P2)	4
Analog-Platte	5
• AC3	7
• Audio/Video	9
Bedieneinheit	11
Explosionszeichnung und Ersatzteilliste	13...15

Table of Contents

	Page
General Section	2...3
Introduction	2
DVD Overview	3
Layout of PCBs and Circuit Diagrams	4...12
Digital Board	4
• Audio/Interface (P2)	4
Analog Board	5
• AC3	7
• Audio/Video	9
Keyboard Control	11
Exploded View and Spare Parts List	13...15

Allgemeiner Teil

Einführung

In dieser Service-Manual-Ergänzung ist das Gerät GDP5120 der Serie Xenaro GDP51.../6150 dokumentiert. Des Weiteren enthält diese die geänderten Schaltpläne und Platinenabbildungen der gesamten Serie Xenaro. Nähere Informationen entnehmen Sie bitte der Geräteübersicht.

Hinweis:

Grundlage für den Service sind folgende Service Manuals:

- Service Manual Sicherheit, Materialnummer 720108000000
- Service Manual GDP51.../6150, Materialnummer 720105408500

General Section

Introduction

This Supplement Service Manual describes the DVD player GDP5120 in the series Xenaro GDP51.../6150. In addition changed circuit diagrams and PCB illustration of the series Xenaro are included. For detailed information please see chapter DVD Overview.

Note:

Basic instructions for servicing are given in the following Service Manuals:

- Service Manual Safety, Part Number 720108000000
- Service Manual GDP51.../6150, Part Number 720105408500

„Dolby“, „Dolby Pro Logic“, „AC 3“ ist gefertigt unter Lizenz von Dolby Laboratories Licensing Corporation.
„Dolby“, „Dolby Pro Logic“, „AC 3“ und das Doppel-D-Symbol „DD“ sind Warenzeichen der Dolby Laboratories Licensing Corporation. Copyright 1992 Dolby Laboratories, Inc. Alle Rechte vorbehalten.

“Dolby”, “Dolby Pro Logic”, “AC 3” manufactured under license from Dolby Laboratories Licensing Corporation.
“Dolby”, “Dolby Pro Logic”, “AC 3” and the double-D symbol “DD” are trademarks of the Dolby Laboratories Licensing Corporation. Copyright 1992 Dolby Laboratories, Inc. All rights reserved.

Geräteübersicht / DVD Overview

	Ergänzung Supplement Materialnr./Part No. 720105408600	Service Manual Materialnr./Part No. 720105408500		GDP 5100	GDP 5100/1	GDP 5100/2	GDP 5102	GDP 5120	GDP 6150/1	GDP 6150/2	SE 1230
Bausteinübersicht / Table of Modules		S./P. 3-10	Netzteil / Power Supply	●	●	●	●	●	●	●	●
	S./P. 4	S./P. 3-12 S./P. 3-15 S./P. 3-17 S./P. 3-19 S./P. 3-19 S./P. 3-20 S./P. 3-21	Digital-Platte / Board • Hauptschaltplan / Main Circuit Diagram (P1) • Audio/Interface (P2) • Frontend (P3) • SDRAM (P4) • FLASH (P5) • Interface (P6)	●	●	●	●	●	●	●	●
		S./P. 3-22	Analog-Platte / Board	●	●	●	●				●
	S./P. 5 S./P. 7 S./P. 9		Analog-Platte / Board • AC3 • Audio/Video					●	●	●	
	S./P. 11		Bedieneinheit / Keyboard Control	●	●	●	●	●	●	●	●
		S./P. 3-35	Laufwerk-Platte / Drive Board	●	●	●	●	●	●	●	●
	Feature-Übersicht / Table of Features	DVD-Video			●	●	●	●	●	●	●
DVD-R			●	●	●	●	●	●	●	●	
Audio-CD			●	●	●	●	●	●	●	●	
CD-R			●	●	●	●	●	●	●	●	
CD-RW			●	●	●	●	●	●	●	●	
Video-CD			●	●	●	●	●	●	●	●	
S-VCD			●	●	●	●	●	●	●	●	
MP3-CD			●	●	●	●	●	●	●	●	
2 Laser (DVD / CD)			●	●	●	●	●	●	●	●	
PAL-Wiedergabe / Playback			●	●	●	●	●	●	●	●	
NTSC-Wiedergabe / Playback			●	●	●	●	●	●	●	●	
Konverter / Converter (PAL-NTSC / NTSC-PAL)			●	●	●	●	●	●	●	●	
OSD			●	●	●	●	●	●	●	●	
Bildschirmschoner / Screen Saver			●	●	●	●	●	●	●	●	
Virtual Surround Sound			●	●	●	●	●	●	●	●	
Digital-Audio-Decoder (AC3, MPEG2)			●	●	●	●	●	●	●	●	
Digital-Audio-Decoder (DTS)							●	●	●		
Kindersicherung / Child Lock			●	●	●	●	●	●	●	●	
Digital Sound Processing							●	●	●	●	
Dauerlauf-Wiedergabe / Continuous Playback			●	●	●	●	●	●	●	●	
EURO-AV-Buchse / Socket TV			●	●	●	●	●	●	●	●	
EURO-AV-Buchse / Socket Video							●	●	●		
Data-Link (IR-Fernbedienung – EURO-AV-Kontakt 8 / IR Remote – EURO-AV contact 8)			●	●	●	●	●	●	●	●	
S-Video-Ausgang / Output			●	●	●	●	●	●	●	●	
Digital-Audio-Ausgang optisch / Digital Audio Output optical (AC3 / MPEG2 / DTS / PCM)							●	●	●		
Digital-Audio-Ausgang koaxial / Digital Audio Output coaxial (AC3 / MPEG2 / DTS / PCM)			●	●	●	●	●	●	●	●	
LINE-Ausgangs-Buchsen / Output Sockets			●	●	●	●	●	●	●	●	
Subwoofer-Ausgangs-Buchse / Output Socket							●				
5.1 Audio-Ausgangs-Buchsen / Output Sockets								●	●		
Kopfhörerbuchse / Headphone Socket 3.5mm								●	●		
Jog / Shuttle								●	●		
Energiesparend / Low Power (Standby <0.2W)							●	●	●		
Energiesparend / Low Power (Standby <5W)			●	●	●	●				●	

Digital-Platte / Board – Audio/Interface (P2)

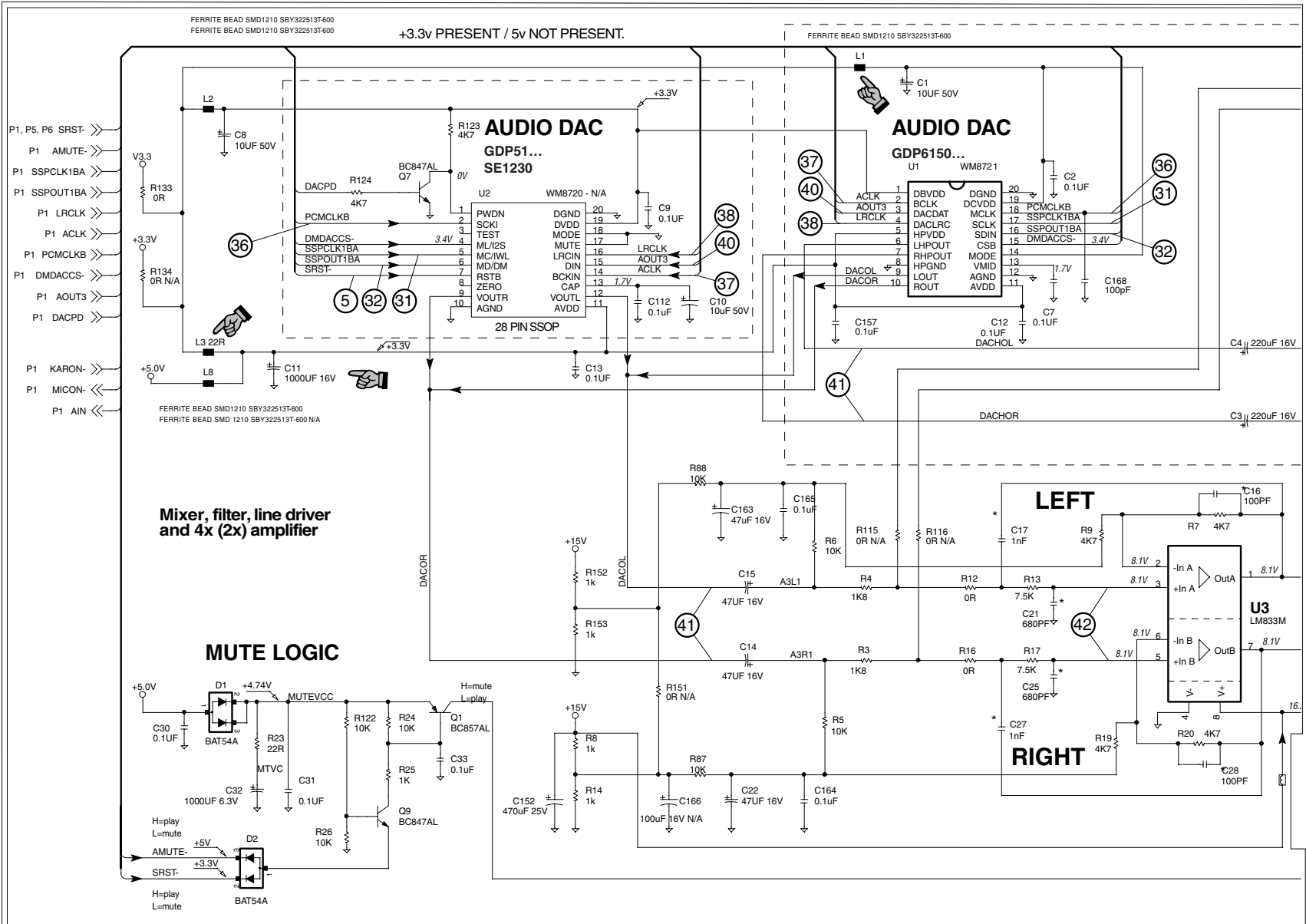

Reference

IC Block Diagrams	3-4
Oscillograms	3-43
Analog Board GDP510.....	3-23
Analog Board GDP5120/6150	
- AC3	7
- Audio / Video	9
Digital Board	
- P1	3-15
- P2	4 / 3-17
- P3	3-19
- P4	3-19
- P5	3-20
- P6	3-21
Drive Board	3-37
Keyboard Control	11
Power Supply	3-11

Seiten "3-..." - siehe Basis-Service-Manual
 Pages "3-..." - see Main Service Manual

Analog-Platte / Board (GDP5120, GDP6150...)

Ansicht von der Bestückungsseite / View of Component Side

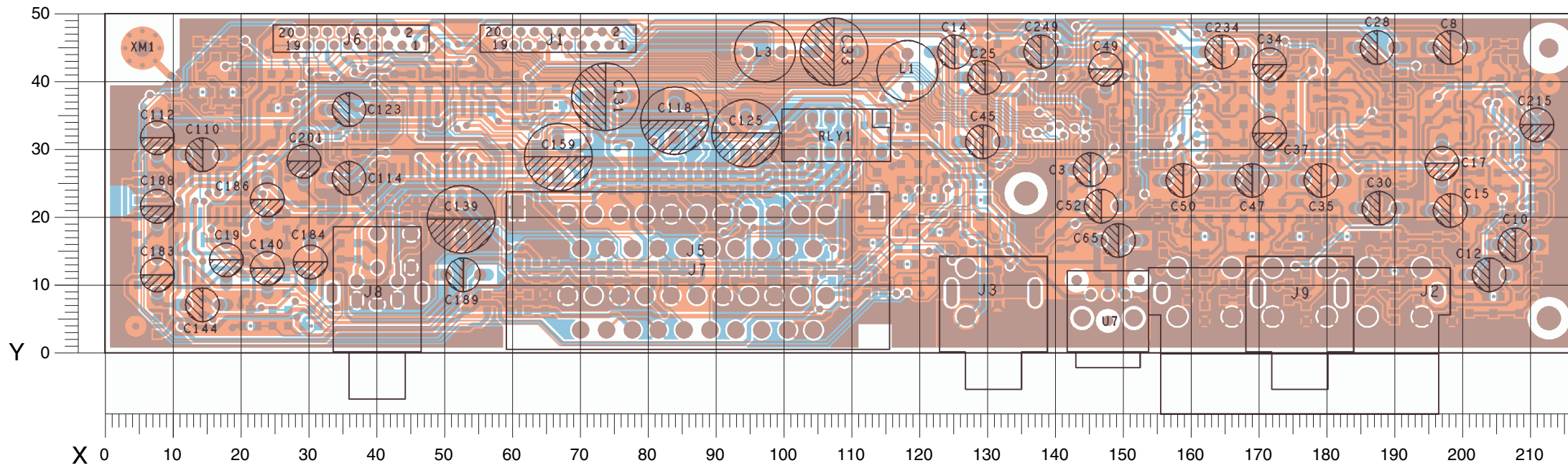

POS.	X	Y	POS.	X	Y
C3	143	27	C139	52	17
C8	196	45	C140	24	10
C10	205	16			
C12	201	11	C144	12	7
C14	123	44	C159	67	26
			C183	8	9
C15	196	21	C184	30	11
C17	197	25	C186	24	20
C19	18	11			
C25	127	41	C188	8	19
C28	185	45	C189	50	11
			C201	29	26
C30	185	21	C215	211	31
C33	105	44	C234	162	44
C34	171	40	C249	135	44
C35	177	25			
C37	171	30	J1	76	45
			J2	194	12
C45	127	31	J3	127	5
C47	166	25	J5	106	8
C49	147	39	J6	46	45
C50	156	25			
C52	144	22	J7	106	20
			J8	40	17
C65	147	17	J9	172	5
C110	12	29			
C112	8	29	L1	118	44
C114	33	26	L3	95	44
C118	84	32			
			RLY1	114	35
C123	33	36			
C125	94	30	XM1	5	45
C131	71	38			

Ansicht von der Lötseite / View of Solder Side

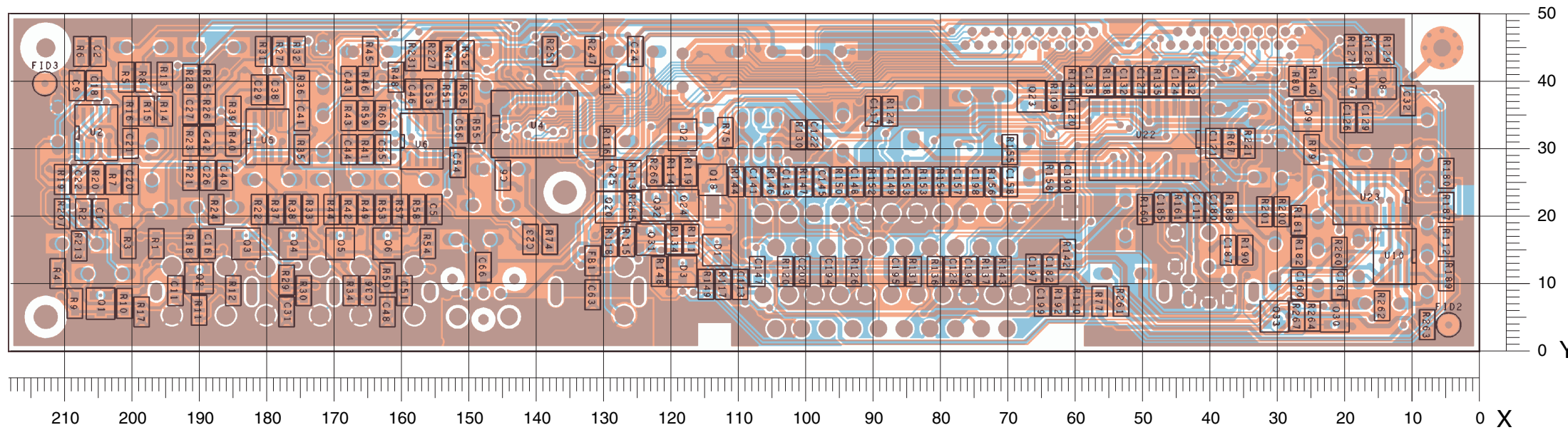

POS.	X	Y	POS.	X	Y	POS.	X	Y	POS.	X	Y	POS.	X	Y	POS.	X	Y	POS.	X	Y	POS.	X	Y	POS.	X	Y	POS.	X	Y																
C1	204	20	C32	10	37	C111	42	21	C149	87	25	D1	113	15	Q25	129	26	R13	195	41	R49	165	21	R80	27	40	R130	101	32	R150	95	25	R201	32	21	U4	140	34							
C2	205	44	C36	165	9	C113	110	10	C153	85	25	D2	118	32	Q30	21	5	R14	195	36	R32	175	44	R50	162	11	R109	63	38	R131	84	12	R152	90	25	R207	210	20	U5	180	32				
C5	155	21				C117	90	36				D3	118	12				R15	198	36	R33	173	21			R110	60	7	R153	82	25				U6	157	31								
C6	145	26	C38	178	39	C120	60	35	C157	77	25			Q31	123	17	R34	167	9	R51	153	38	R111	117	17	R132	43	40	R154	80	25	R213	208	16	U7	150	9								
C9	208	39	C40	186	26	C121	39	31	C158	70	25	FB1	131	13	Q32	122	22	R16	200	36	R52	150	44	R112	5	16	R134	119	17	R155	70	30	R221	34	31				U10	12	14				
			C41	175	35				C160	27	10			Q33	30	5	R17	198	6	R53	163	21			R135	48	40	R156	72	25	R227	155	44				U22	50	31						
C11	193	9	C42	189	31	C122	98	32	C161	21	10	Q1	204	7			R18	191	16	R54	156	16	R113	125	26	R136	81	12	R156	72	25	R231	158	44				U23	16	23					
C13	129	40	C43	168	40	C124	45	40	C180	39	21	Q2	190	11	R1	196	16	R19	210	25	R55	149	33	R114	120	27	R137	73	12	R158	64	26	R247	131	44										
C16	189	16				C126	19	35			Q3	183	16	R2	207	20	R20	205	25	R38	176	21			R115	126	16	R160	49	21															
C18	205	39	C44	168	30	C128	50	40	C182	64	12	Q4	176	16	R3	200	16			R39	185	36	R56	150	38	R116	129	31	R161	44	21	R251	138	44											
C20	200	25	C46	158	38	C128	78	12	C185	47	21	Q5	169	16	R4	211	11	R21	191	26	R40	185	31	R57	160	21	R117	112	10	R162	5	26	R260	21	15										
			C48	162	6				C187	37	15			Q6	162	16	R5	201	41	R22	181	21	R58	157	21	R141	60	40	R180	5	26	R261	53	7											
C21	200	31	C51	159	9	C129	17	35	C190	61	26	Q7	19	40	R6	207	44	R23	191	31	R41	165	30	R59	165	35	R118	129	16	R181	27	19	R262	14	7										
C22	208	25	C53	156	38	C132	53	40	C194	97	12	Q8	17	40	R7	203	25	R24	187	21	R42	168	21	R60	163	35	R119	117	27	R182	27	15	R263	8	4										
C23	141	17				C135	58	40			Q8	14	40			R8	198	41	R25	189	40	R43	168	35			R120	103	12	R187	5	21													
C24	125	44	C54	151	28	C141	108	25	C195	86	12	Q9	25	35	R8	198	41	R44	170	21	R44	170	21	R67	37	31	R124	87	36	R144	110	25	R188	37	21	R264	25	5							
C26	189	26	C55	163	30	C143	103	25	C196	76	12	Q18	114	25	R9	208	7	R26	189	36	R45	164	44	R74	138	17	R126	93	12	R146	105	25	R189	5	11	R265	125	21							
			C56	151	33				C197	66	12			R10	201	7	R27	178	44	R27	178	44	R75	112	32			R147	100	25	R190	35	15	R266	122	27									
C27	191	36	C63	131	8	C145	97	25	C198	75	25	Q20	129	21	R11	190	6	R28	191	40	R46	165	40	R77	56	7	R127	19	45	R148	122	12	R190	35	15	R267	27	5							
C29	181	39	C66	148	12	C147	107	12	C199	65	7	Q23	66	38	R12	185	9	R29	177	10	R47	153	44	R79	25	30	R128	16	45	R149	115	10	R192	62	7										
C31	177	6				C148	92	25	C200	100	12	Q24	118	22				R30	174	9	R48	161	41			R129	14	45	R199	29	21	U2	205	32											

Analog-Platte / Board – AC3 (GDP5120, GDP6150...)

Reference
 IC Block Diagrams 3-4
 Oscillograms 3-43
 Analog Board GDP510..... 3-23
 Analog Board GDP5120/6150
 – AC3 7
 – Audio / Video 9
Digital Board
 – P1 3-15
 – P2 4 / 3-17
 – P3 3-19
 – P4 3-19
 – P5 3-20
 – P6 3-21
 Drive Board 3-37
 Keyboard Control 11
 Power Supply 3-11

Seiten "3-..." – siehe Basis-Service-Manual
 Pages "3-..." – see Main Service Manual

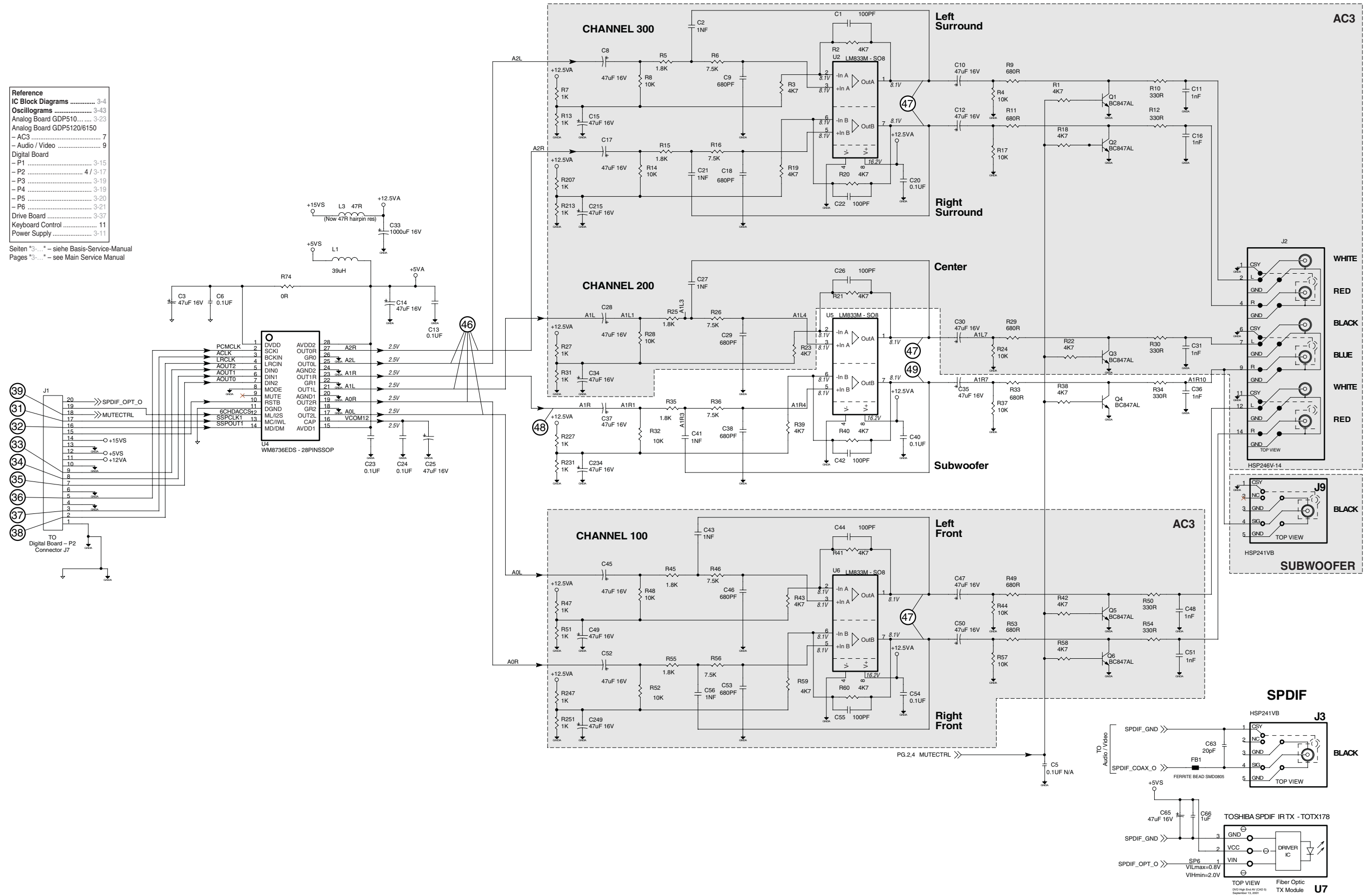

Analog-Platte / Board – Audio/Video (GDP5120, GDP6150...)

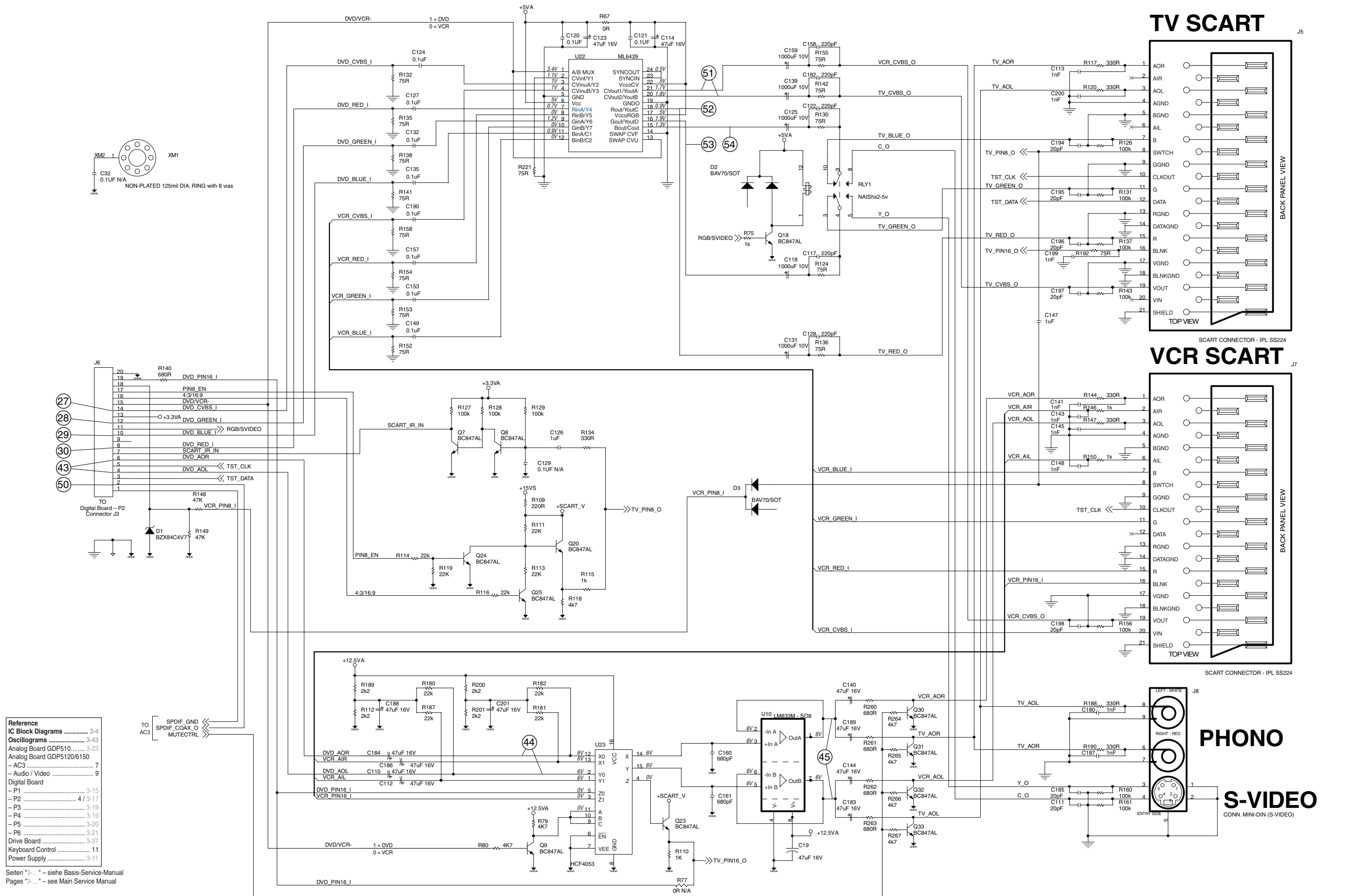

Reference

IC Block Diagrams	3-4
Oscillograms	3-43
Analog Board GDP510...	3-23
Analog Board GDP5120/6150	3-23
- AC3	7
- Audio / Video	9
Digital Board	
- P1	3-15
- P2	4 / 3-17
- P3	3-19
- P4	3-19
- P5	3-20
- P6	3-21
Drive Board	3-37
Keyboard Control	11
Power Supply	3-11

Seiten "3-..." - siehe Basis-Service-Manual
Pages "3-..." - see Main Service Manual

Bedieneinheit / Keyboard Control

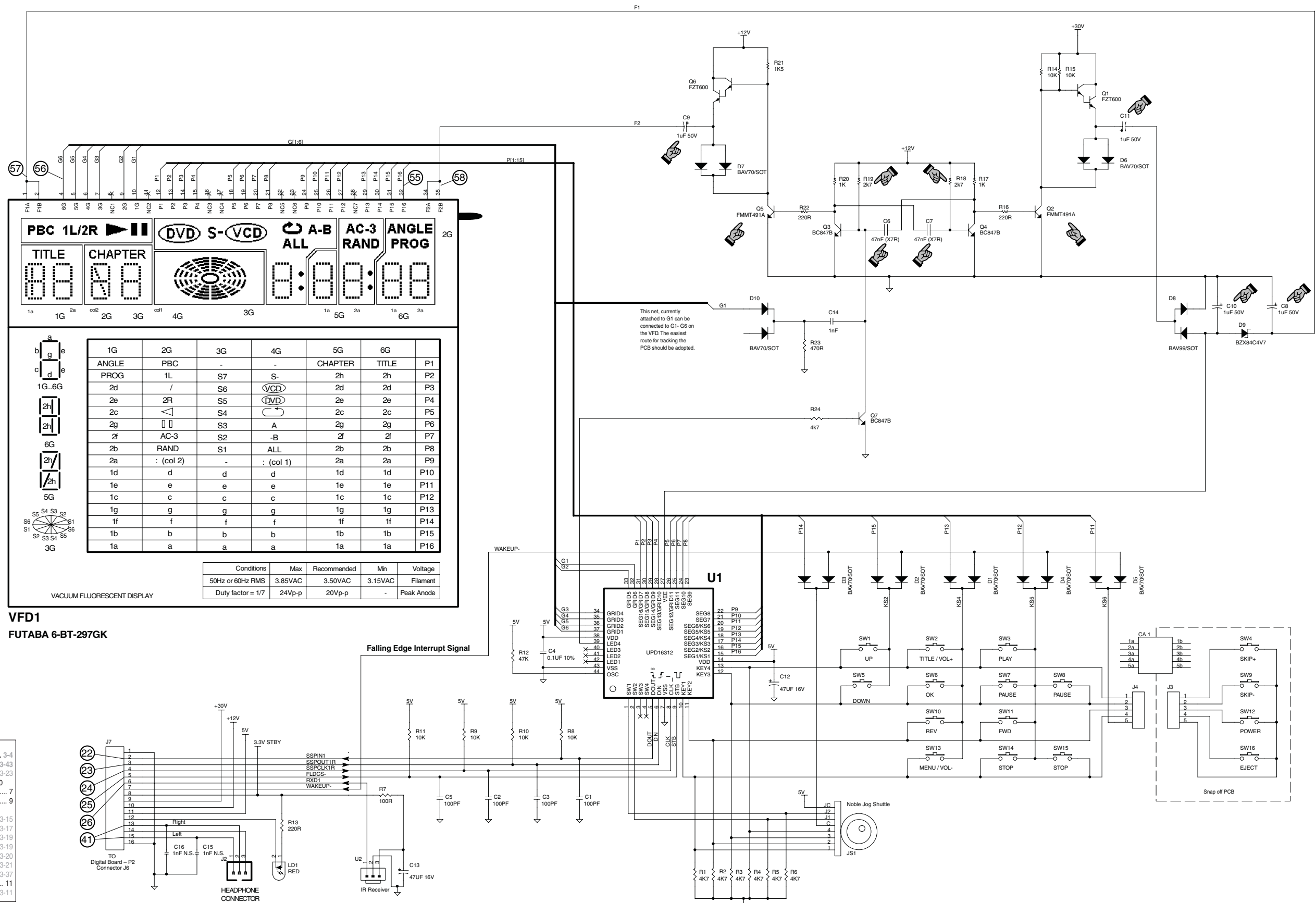

Reference

- IC Block Diagrams 3-4
- Oscillograms 3-43
- Analog Board GDP510..... 3-23
- Analog Board GDP5120/6150
- AC3 7
- Audio / Video 9
- Digital Board
- P1 3-15
- P2 4 / 3-17
- P3 3-19
- P4 3-19
- P5 3-20
- P6 3-21
- Drive Board 3-37
- Keyboard Control 11
- Power Supply 3-11

Seiten *3-...* - siehe Basis-Service-Manual
Pages *3-...* - see Main Service Manual

Explosionszeichnung und Ersatzteillisten Exploded View and Spare Parts Lists

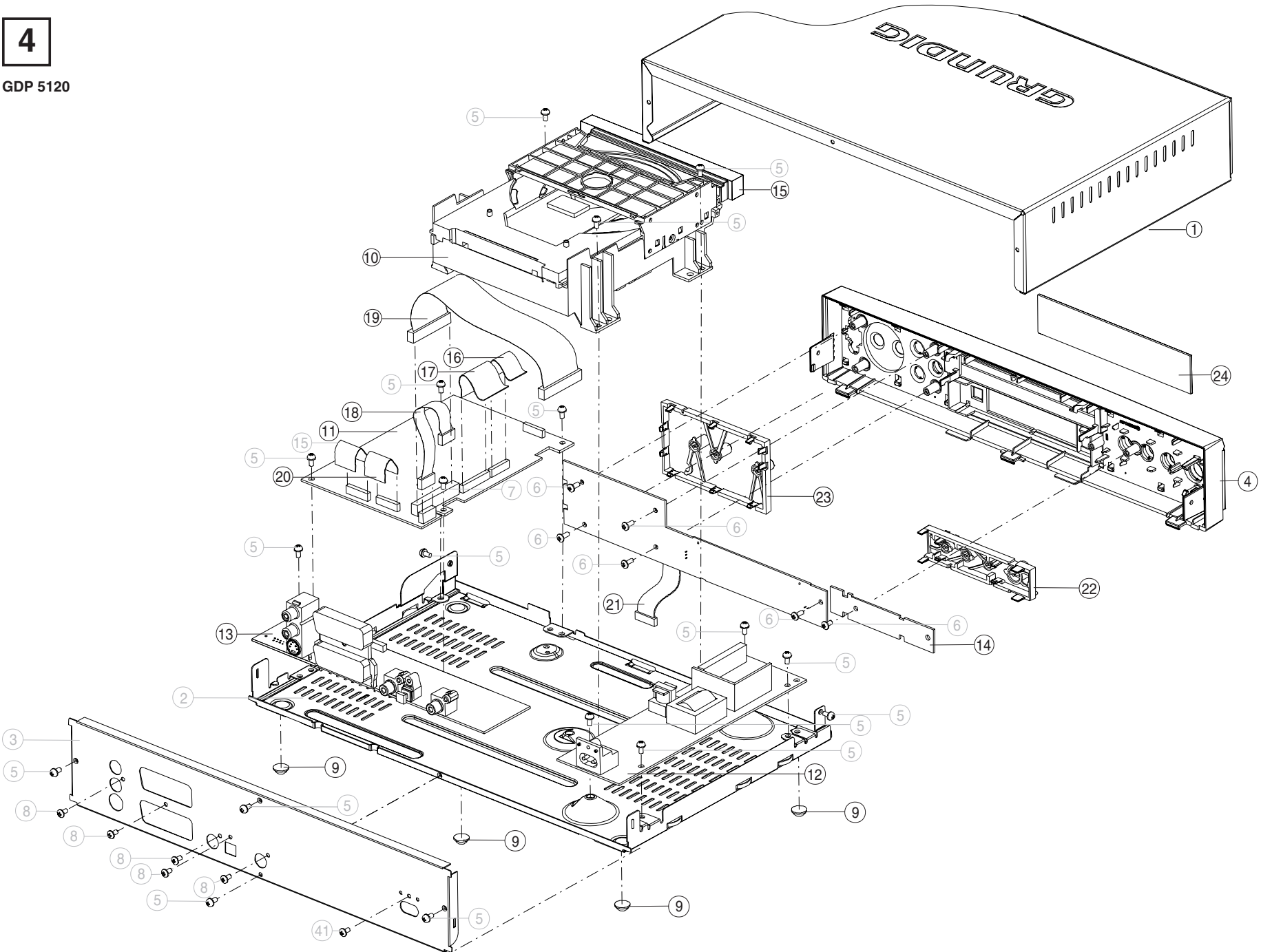

4

GDP 5120

Ersatzteilliste
Spare Parts List

DVD

7 / 2001

XENARO GDP 5120

MATERIAL-NR. / PART NO.: 926710150301
BESTELL-NR. / ORDER NO.: GMI9200 SILBER/SILVER

POS. NR. POS. NO.	ABB. FIG.	MATERIAL-NR. PART NUMBER	ANZ. QTY.	BEZEICHNUNG (D)	DESCRIPTION (GB)
		926710150301		XENARO GDP 5120 SILBER KEIN E-TEIL	XENARO GDP 5120 SILVER NO SPARE PART
0001.000	4	267210030001		GEH-OBERTEIL	TOP COVER
0004.000	4	267120210003		FRONTBLLENDE SILBER KPL.	FRONT PANEL SILVER CPL
0009.000	4	267160020001	4	FUSS GUMMI	RUBBER FEET
0010.000	△	267275000301		DVD-LAUFWERK DVD-KIT310LE KEIN E-TEIL	DVD DRIVE SANYO DVD-KIT310LE NO SPARE PART
0011.000	4	267290730101	X	DVD-DIGITALPLATTE	DVD DIGITAL BOARD
0012.000	△	267270150001	X	DVD-NETZTEILPLATTE PSSH370603A	DVD POWER SUPPLY PSSH370603A
0013.000	4	267290740101	X	DVD-ANALOGPLATTE KPL.	DVD ANALOG BOARD ASSY
0014.000	4	267290600201	X	DVD-BEDIENPLATTE KPL. KEIN E-TEIL	DVD CONTROL BOARD ASSY NO SPARE PART
0015.000	4	267170080003		ABDECKUNG SCHUBLADE	DRAWER COVER
0016.000	4	267260310001		FLEXIBLE LEITUNG 16-POL	FLEXIBLE CABLE 16P
0017.000	4	267260320001		FLEXIBLE LEITUNG 26-POL	FLEXIBLE CABLE 26P
0018.000	4	267260330001		FLEXIBLE LEITUNG 6-POL	FLEXIBLE CABLE 6P
0019.000	4	267260340001		FLEXIBLE LEITUNG 18-POL	FLEXIBLE CABLE 18P
0020.000	4	267260360001		FLEXIBLE LEITUNG 20-POL	FLEXIBLE CABLE 20P
0021.000	4	267260350001		FLEXIBLE LEITUNG 16-POL	FLEXIBLE CABLE 16P
0022.000	4	267140070002		TASTENLEISTE LINKS	BUTTON SET LEFT
0023.000	4	267140090002		TASTENLEISTE RECHTS	BUTTON SET RIGHT
0024.000	4	267130120001		FENSTER	WINDOW
0027.000	△	829099122000		NETZKABEL KPL.	POWER CABLE CPL
0028.000		267280120101		TP 83 D FERNBEDIENUNG	TP 83 D REMOTE CONTROL
		267109414001		BEDIENUNGSANLEITUNG D/GB/F/I/NL	INSTRUCTION MANUAL D/GB/F/I/NL
		720105408500		SERVICE MANUAL D/GB	SERVICE MANUAL D/GB
		720105408600		SERVICE MANUAL D/GB ERGAENZUNG 1	SERVICE MANUAL D/GB SUPPLEMENT 1
				X = SIEHE GESONDERTE E-LISTE	X = SEE SEPARATE PARTS LIST

Es gelten die Vorschriften und Sicherheitshinweise gemäß dem Service Manual "Sicherheit", Mat.-Nummer 720108000000, sowie zusätzlich die eventuell abweichenden, landesspezifischen Vorschriften!



The regulations and safety instructions shall be valid as provided by the "Safety" Service Manual, part number 720108000000, as well as the respective national deviations.

ÄNDERUNGEN VORBEHALTEN / SUBJECT TO ALTERATION

Ersatzteilliste
Spare Parts List

DVD

7 / 2001

DVD-DIGITALPLATTE

MATERIAL-NR. / PART NO.: 267290730101

POS. NR. POS. NO.	ABB. FIG.	MATERIAL-NR. PART NUMBER	ANZ. QTY.	BEZEICHNUNG (D)	DESCRIPTION (GB)			
		267290730101		GDP5120 DIGITAL HAND ASSY	GDP5120 DIGITAL HAND ASSY			
POS. NR. POS. NO.		MATERIAL-NR. PART NUMBER		BEZEICHNUNG DESCRIPTION	POS. NR. POS. NO.	MATERIAL-NR. PART NUMBER		BEZEICHNUNG DESCRIPTION
D1		832521205300		SMD-DIODE BAT54A	RP4	877003403700		SMD R-NETZ 1206 4X33 OHM
D2		832521205300		SMD-DIODE BAT54A	RP6	877003403700		SMD R-NETZ 1206 4X33 OHM
D3		832521205300		SMD-DIODE BAT54A	RP8	877003403700		SMD R-NETZ 1206 4X33 OHM
D4		830938404700		SMD-Z DIODE BZX 84 C4V7	RP9	877003403700		SMD R-NETZ 1206 4X33 OHM
D5		830938404700		SMD-Z DIODE BZX 84 C4V7	RP12	877003403700		SMD R-NETZ 1206 4X33 OHM
D9		830931307000		SMD-DIODE BAV70	U2	830487872000		SMD IC WM8720EDS WOLFSON
J3		829017545000		LP-VERBINDER 20-POL FPC/FFC	U3	830575983400		SMD IC LM833M NSC
J7		829017545000		LP-VERBINDER 20-POL FPC/FFC	U5	830497454100		SMD IC 74VHCT541AMTC FAI
J10		829017545600		LP-VERBINDER 26-POL FPC/FFC	U6	830576636100		SMD IC LP3962-EMP-1.8 NS
L1		814052980900		FERRITE BEAD SMD1210	U7	830596001600		SMD IC M24C16CM1TR/MN6T/
L4		814052980600		SMD DR 2.2UH 5% 1008NLV25	U8	830477202500		SMD IC PANTERA NDV8601VWA
L5		814052980600		SMD DR 2.2UH 5% 1008NLV25	U9	830470057400		SMD IC 74LCX574MTC FAI
L6		814052980600		SMD DR 2.2UH 5% 1008NLV25	U10	830470057400		SMD IC 74LCX574MTC FAI
L7		814052980600		SMD DR 2.2UH 5% 1008NLV25	U11	830579125700		SMD IC 74ACT257MTC FAI
L8		814052980900		SMD DR 1210 400MA SBY3225	U12	830470057300		SMD IC 74LCX573MTC FAI
L10		814052498400		SIEB-DR 39UH 10% LHL08	U13	830470980100		SMD IC M29W800AT-90N1 ST
L11		814052498400		SIEB-DR 39UH 10% LHL08	U14	830470057300		SMD IC 74LCX573MTC FAI
L12		814052981200		SMD DR 10UH 5% 1008NLV25T	U15	830470980100		SMD IC M29W800AT-90N1 ST
L13		814052980600		SMD DR 2.2UH 5% 1008NLV25	U19	830576470900		SMD IC L7809CD2T STM
L14		814052980600		SMD DR 2.2UH 5% 1008NLV25	U22	830593351000		SMD IC HY57V333210BTC-8
L15		814052980600		SMD DR 2.2UH 5% 1008NLV25	Y1	838233627200		QUARZ #336-1 13C 27MHZ 30
L16		814052980600		SMD DR 2.2UH 5% 1008NLV25				
L17		814052980600		SMD DR 2.2UH 5% 1008NLV25				
L21		814052981200		SMD DR 10UH 5% 1008NLV25T				
Q1		830100785700		SMD TRANS BC857				
Q2		830100784700		SMD TRANS BC847				
Q3		830140250200		SMD TRANS FET IRLML2502				
Q4		830100784700		SMD TRANS BC847				
Q5		830100784700		SMD TRANS BC847				
Q6		830100784700		SMD TRANS BC847				
Q7		830100784700		SMD TRANS BC847				
Q8		830100784700		SMD TRANS BC847				
Q9		830100784700		SMD TRANS BC847				
Q10		830100785700		SMD TRANS BC857				
Q11		830100784700		SMD TRANS BC847				
Q12		830100784700		SMD TRANS BC847				
Q13		830100784700		SMD TRANS BC847				
RP1		877003403700		SMD R-NETZ 1206 4X33 OHM				

Es gelten die Vorschriften und Sicherheitshinweise gemäß dem Service Manual "Sicherheit", Mat.-Nummer 720108000000, sowie zusätzlich die eventuell abweichenden, landesspezifischen Vorschriften!



The regulations and safety instructions shall be valid as provided by the "Safety" Service Manual, part number 720108000000, as well as the respective national deviations.

ÄNDERUNGEN VORBEHALTEN / SUBJECT TO ALTERATION

GRUNDIGErsatzteilliste
Spare Parts List**DVD****7 / 2001****DVD-ANALOGPLATTE
DVD ANALOG BOARD**

MATERIAL-NR. / PART NO.: 267290740101

POS. NR. POS. NO.	ABB. FIG.	MATERIAL-NR. PART NUMBER	ANZ. QTY.	BEZEICHNUNG (D)	DESCRIPTION (GB)
		267290740101		DVD-ANALOGPLATTE KEIN E-TEIL	DVD ANALOG BOARD NO SPARE PART

POS. NR. POS. NO.	MATERIAL-NR. PART NUMBER	BEZEICHNUNG DESCRIPTION
----------------------	-----------------------------	----------------------------

D1	830938404700	SMD-Z DIODE BZX 84 C4V7
D2	830931307000	SMD-DIODE BAV70
D3	830931307000	SMD-DIODE BAV70
FB1	810498233000	SMD DAEMPF-PERLE 0805 BLM
FB2	810498233000	SMD DAEMPF-PERLE 0805 BLM
J1	829017545000	LP-VERBINDER 20-POL FPC/FFC
J3	812612524600	CINCH-BUCHSE 1-FACH LP SK
J6	829017545000	LP-VERBINDER 20-POL FPC/FFC
J5/J7	829017504400	EURO-AV BUCHSENLS.SSS224
J8	813200154000	RCA-EINBAUBUCHSE RJ114200
J9	812612524600	CINCH-BUCHSE 1-FACH LP SK
L1	814052498400	SIEB-DR 39UH 10% LHL08T
LS2	831200313700	RELAIS HX2-5V MAT
Q4	830100784700	SMD TRANS BC847
Q7	830100784700	SMD TRANS BC847
Q8	830100784700	SMD TRANS BC847
Q9	830100784700	SMD TRANS BC847
Q18	830100784700	SMD TRANS BC847
Q20	830100784700	SMD TRANS BC847
Q23	830100784700	SMD TRANS BC847
Q24	830100784700	SMD TRANS BC847
Q25	830100784700	SMD TRANS BC847
U4	830487873600	SMD IC WM8736EDS WOLFSON
U5	830575983400	SMD IC LM833M NSC
U7	829017680300	OPTISCHER STECKVBDG.12.5M
U10	830575983400	SMD IC LM833M NSC
U22	830592362900	SMD IC ML6429
U23	830455405300	SMD IC HCF4053BM1 STM

Es gelten die Vorschriften und Sicherheitshinweise gemäß dem Service Manual "Sicherheit", Mat.-Nummer 720108000000, sowie zusätzlich die eventuell abweichenden, landesspezifischen Vorschriften!



The regulations and safety instructions shall be valid as provided by the "Safety" Service Manual, part number 720108000000, as well as the respective national deviations.

ÄNDERUNGEN VORBEHALTEN / SUBJECT TO ALTERATION

GRUNDIGErsatzteilliste
Spare Parts List**DVD****7 / 2001****DVD-BEDIENPLATTE
DVD-CONTROL BOARD**

MATERIAL-NR. / PART NO.: 267290600201

POS. NR. POS. NO.	ABB. FIG.	MATERIAL-NR. PART NUMBER	ANZ. QTY.	BEZEICHNUNG (D)	DESCRIPTION (GB)
		267290600201		DVD-BEDIENPLATTE (GDP5100) KEIN E-TEIL	DVD-CONTROL BOARD KEIN E-TEIL

POS. NR. POS. NO.	MATERIAL-NR. PART NUMBER	BEZEICHNUNG DESCRIPTION
----------------------	-----------------------------	----------------------------

D1	830931307000	SMD-DIODE BAV70
D2	830931307000	SMD-DIODE BAV70
D3	830931307000	SMD-DIODE BAV70
D4	830931307000	SMD-DIODE BAV70
D5	830931307000	SMD-DIODE BAV70
D6	830931307000	SMD-DIODE BAV70
D7	830931307000	SMD-DIODE BAV70
D8	830931309900	SMD DIODE BAV99
D9	830938404700	SMD-Z DIODE BZX 84 C4V7
D10	830931307000	SMD-DIODE BAV70
Q1	830139660000	SMD TRANS FZT600 ZETEX
Q2	830139549100	SMD TRANS FMMT491A
Q3	830100484700	SMD TRANS BC847B
Q4	830100484700	SMD TRANS BC847B
Q5	830139549100	SMD TRANS FMMT491A
Q6	830139660000	SMD TRANS FZT600 ZETEX
SW3	813402018600	SCHALTER SKQAC ALPS
SW4	813402018600	SCHALTER SKQAC ALPS
SW7	813402018600	SCHALTER SKQAC ALPS
SW9	813402018600	SCHALTER SKQAC ALPS
SW12	813402018600	SCHALTER SKQAC ALPS
SW15	813402018600	SCHALTER SKQAC ALPS
SW16	813402018600	SCHALTER SKQAC ALPS
U1	830587131200	SMD IC UPD16312GB-3BS NE

Es gelten die Vorschriften und Sicherheitshinweise gemäß dem Service Manual "Sicherheit", Mat.-Nummer 720108000000, sowie zusätzlich die eventuell abweichenden, landesspezifischen Vorschriften!



The regulations and safety instructions shall be valid as provided by the "Safety" Service Manual, part number 720108000000, as well as the respective national deviations.

ÄNDERUNGEN VORBEHALTEN / SUBJECT TO ALTERATION