

L80

SPECIFICATIONS

ACOUSTIC & ELECTRICAL SPECIFICATIONS:

- * Nominal Impedance: 4 ohm
- * Recommended Amp Power: 50-250W
- * Frequency Response: 55 Hz - 20 kHz (± 2 dB)
- * Sensitivity: 89 dB / 2,83V / 1 m
- * Crossover frequency: 350HZ / 2,5 kHz

SYSTEM COMPONENTS:

- * Cabinet: CL80 (Not for sale)
- * Grille: GL80 (240741)
- * Woofer: 708G 210mm Woofer
50mm voice coil
- DC Resistance: 4,1 ohm
- * Midrange: 704G 130mm Midrange
30mm voice coil

SYSTEM COMPONENTS: (cont'd)

- DC Resistance: 4,4 ohm
- * Tweeter: 050TI 25mm
Titanium Dome Tweeter
- DC Resistance: 3,8 ohm
- * Crossover Network: NL80 (270742)

PHYSICAL SPECIFICATIONS:

- * Enclosure Dimensions (H.W.D): 37x11,8x13 in. D
(940x300x330mm D)
- * Shipping Weight: 59 lbs. (27 kg.)

WARRANTY INFORMATION:

- * Refer to the Warranty Statement packed with each product

PACKAGE

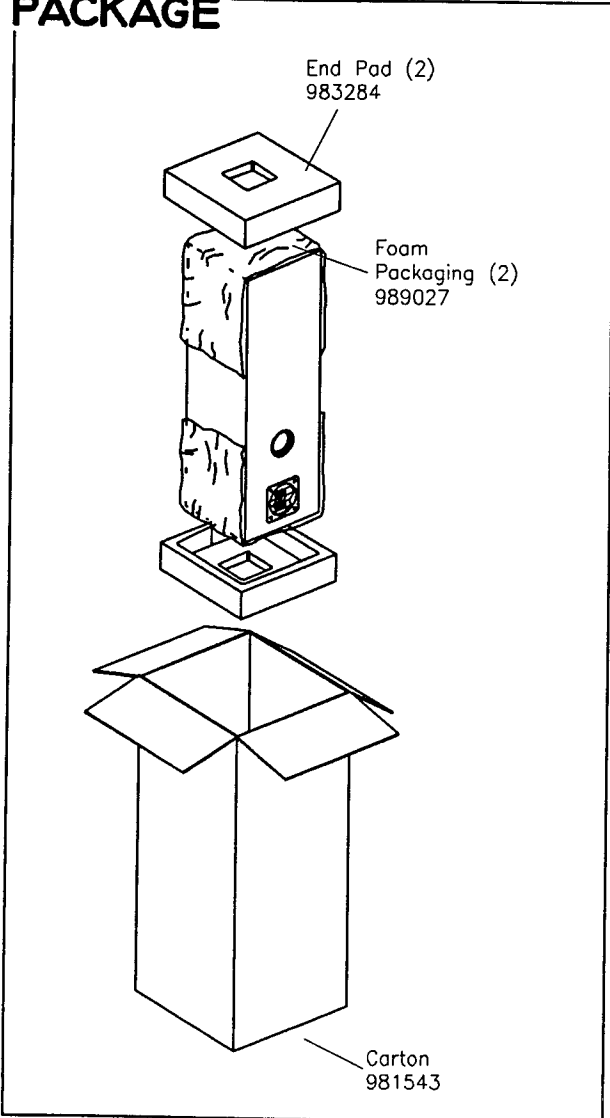

WIRING DIAGRAM

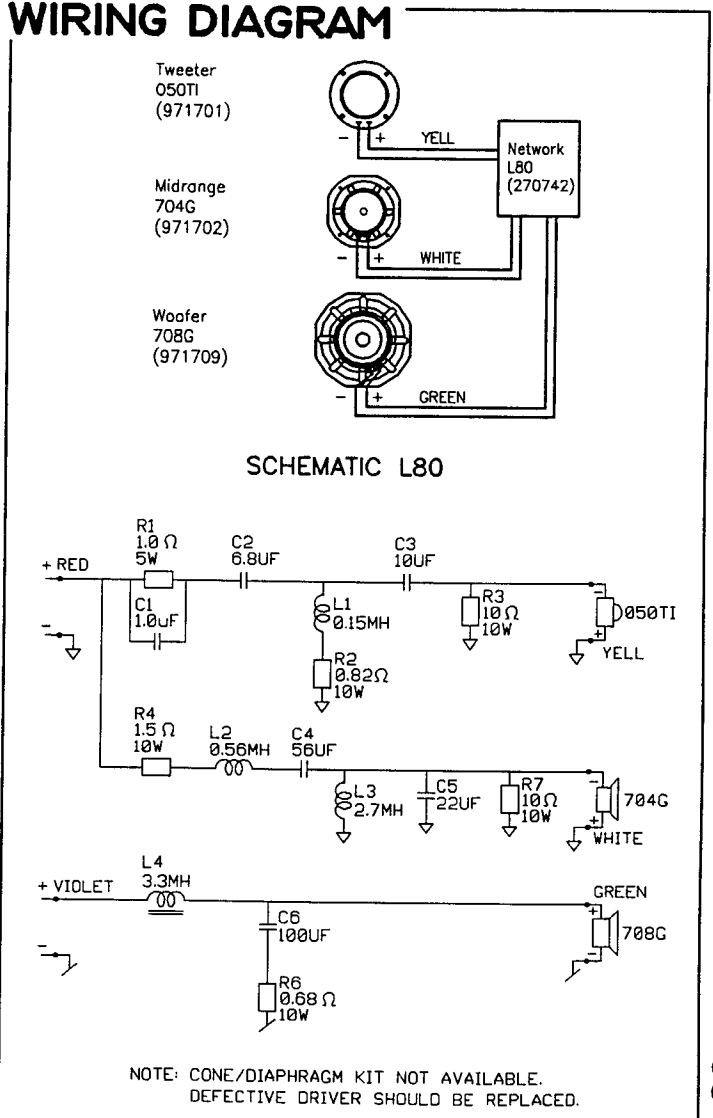

L80

Valid from serial no. 05901
Rev. 3/1-96

COMPONENT EXPLODED VIEW

