

LX3GR

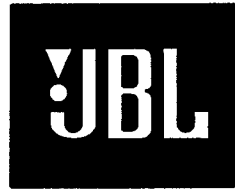

SPECIFICATIONS

ACOUSTIC & ELECTRICAL SPECIFICATIONS:

- * Nominal Impedance: 6 ohm
- * Recommended Amp Power: 10-150W
- * Frequency Response: 50 Hz - 20 kHz (-6dB)
- * Sensitivity: 88 dB / 2,83V / 1 m
- * Crossover frequency: 600 HZ / 2,5 KHZ

SYSTEM COMPONENTS:

- * Cabinet: CLX3GR (Not for sale)
- * Grille: GLX3GR (2408980)
- * Woofer: NJ170-5 165mm Woofer
30mm voice coil
- DC Resistance: 4,8 ohm
- * Midrange: NJ130-M 130mm Midrange
30mm voice coil

SYSTEM COMPONENTS: (cont'd)

- DC Resistance: 4,6 ohm
- * Tweeter: NJ026T 25mm
Titanium Dome Tweeter
- DC Resistance: 4,3 ohm
- * Crossover Network: NLX3GR (2708980)

PHYSICAL SPECIFICATIONS:

- * Enclosure Dimensions (H.W.D): 21,7x8,7x11,1 In. D
(550x220x283mm D)
- * Shipping Weight: 48 lbs. (22 kg.)

WARRANTY INFORMATION:

- * Refer to the Warranty Statement packed with each product

PACKAGE

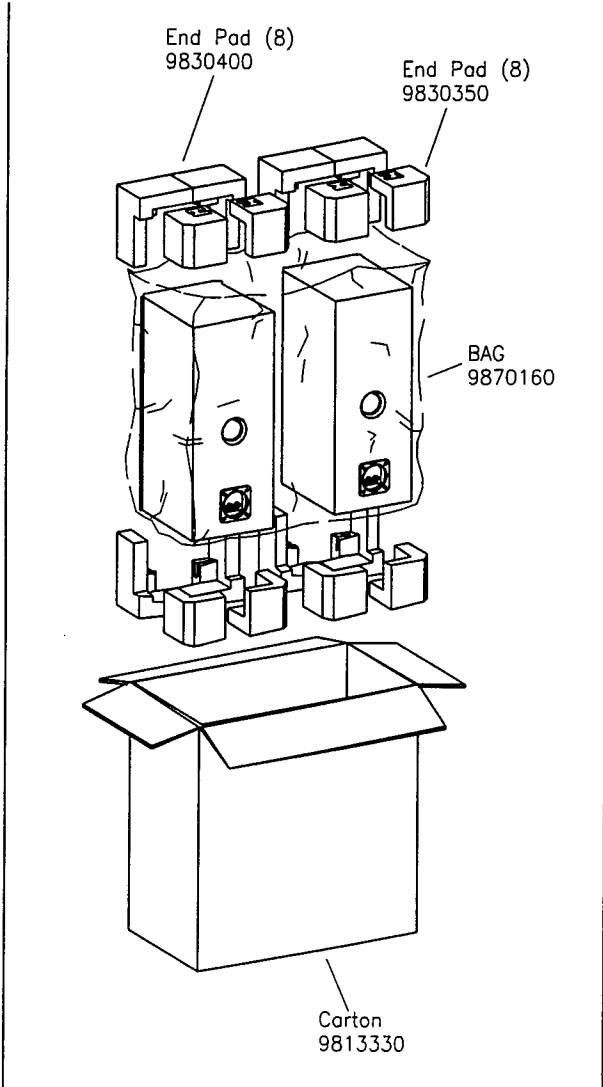

WIRING DIAGRAM

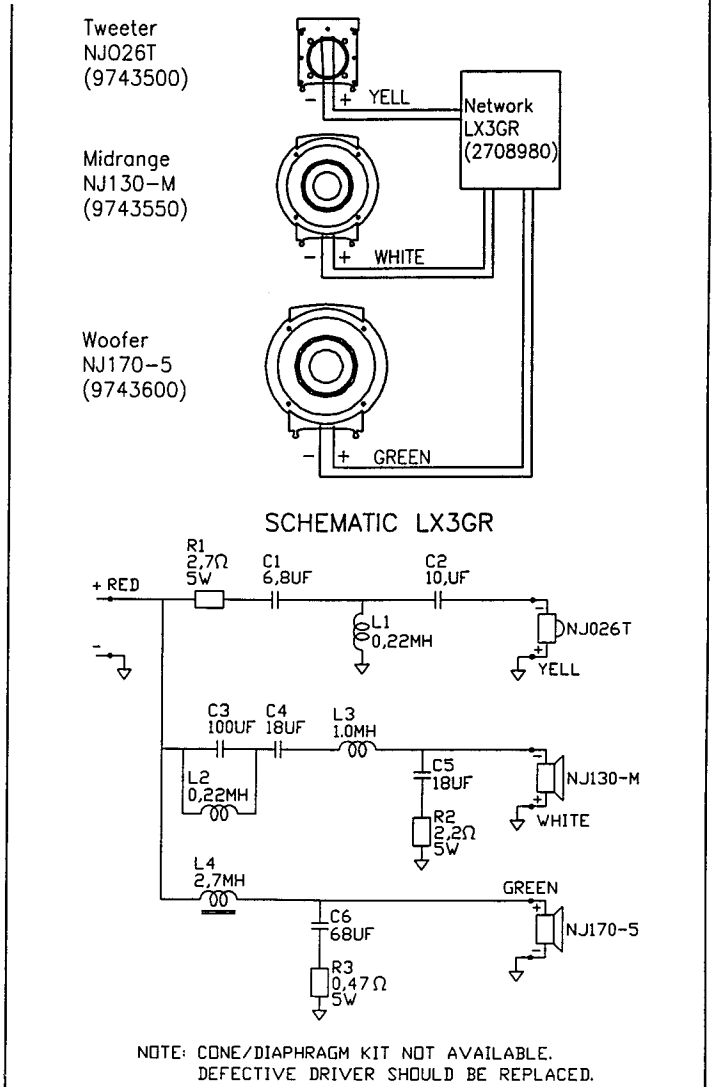

LX3GR

Valid from serial no. 01001 BK
Valid from serial no. 01001 CH
Rev. 28/08-1997

LX3GR

COMPONENT EXPLODED VIEW

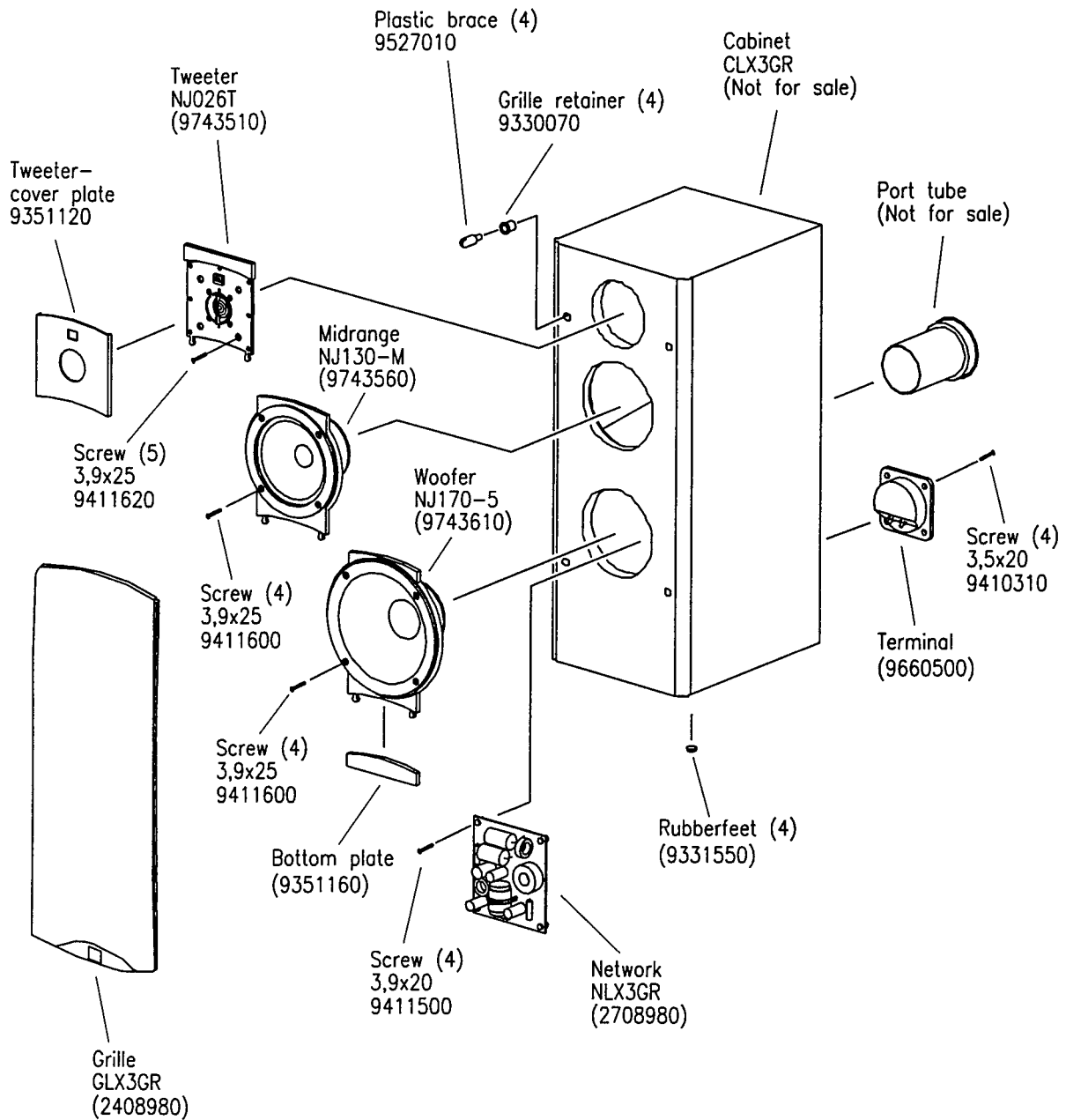

LX3GR