

# TLX171



## SPECIFICATIONS

### ACOUSTIC & ELECTRICAL SPECIFICATIONS:

- \* Nominal Impedance: 8 ohm
- \* Recommended Amp Power: 10-150W
- \* Frequency Response: 45 Hz - 20 kHz (-6dB)
- \* Sensitivity: 90 dB / 2,83V / 1 m
- \* Crossover frequency: 600HZ / 4 kHz

### SYSTEM COMPONENTS:

- \* Cabinet: CTLX171 (Not for sale)
- \* Grille: GTLX171 (2407800)
- \* Woofer: A0908A 210mm Woofer  
Polymer laminate cone
- \* Midrange: A0904A 100mm Midrange  
Polymer laminate cone

### SYSTEM COMPONENTS: (cont'd)

- \* Tweeter: TW010MR 10mm  
Titanium Dome Tweeter
- \* Crossover Network: NTLX171 (2707760)

### PHYSICAL SPECIFICATIONS:

- \* Enclosure Dimensions (H.W.D): 33,8x10,2x12,4 in. D  
(860x260x315mm D)
- \* Shipping Weight: 39,5 lbs. (18 kg.)

### WARRANTY INFORMATION:

- \* Refer to the Warranty Statement packed with each product

## PACKAGE

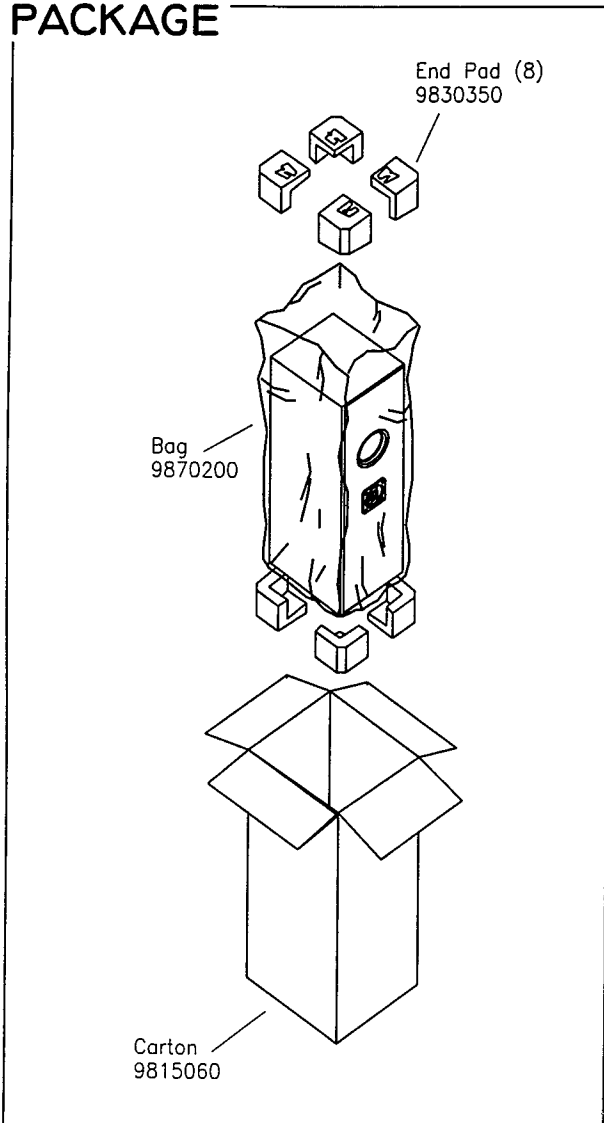

## WIRING DIAGRAM

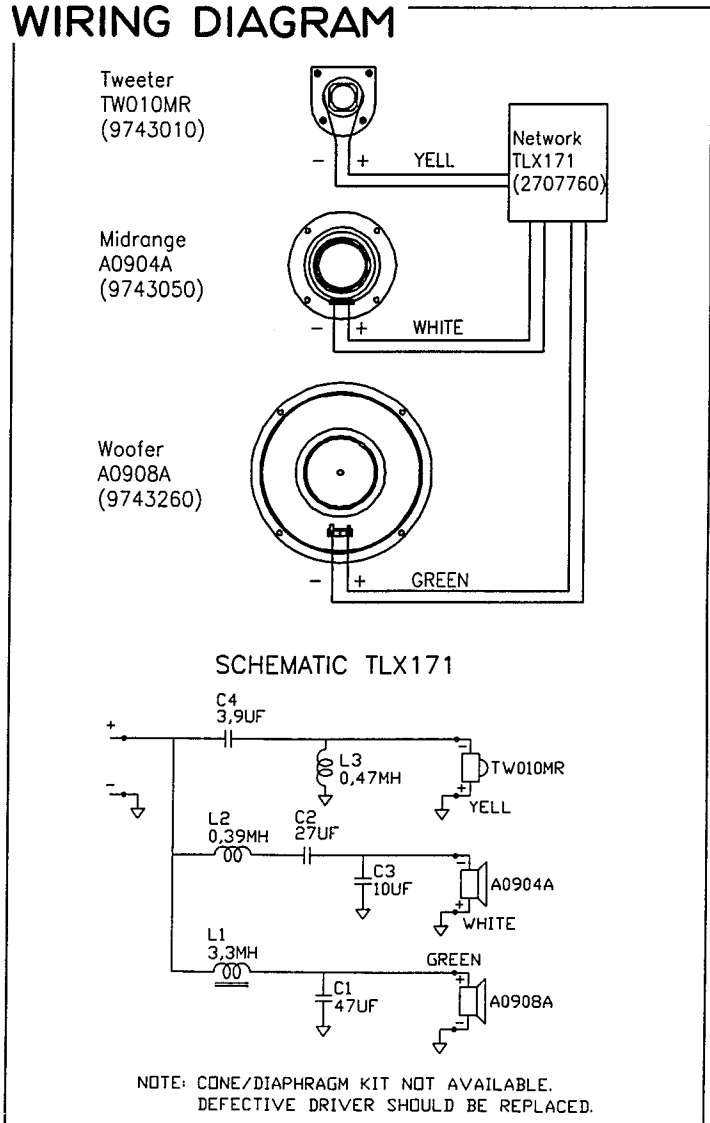

TLX171

Valid from serial no. 10601  
Rev. 19/8-1996

# TLX171

## COMPONENT EXPLODED VIEW

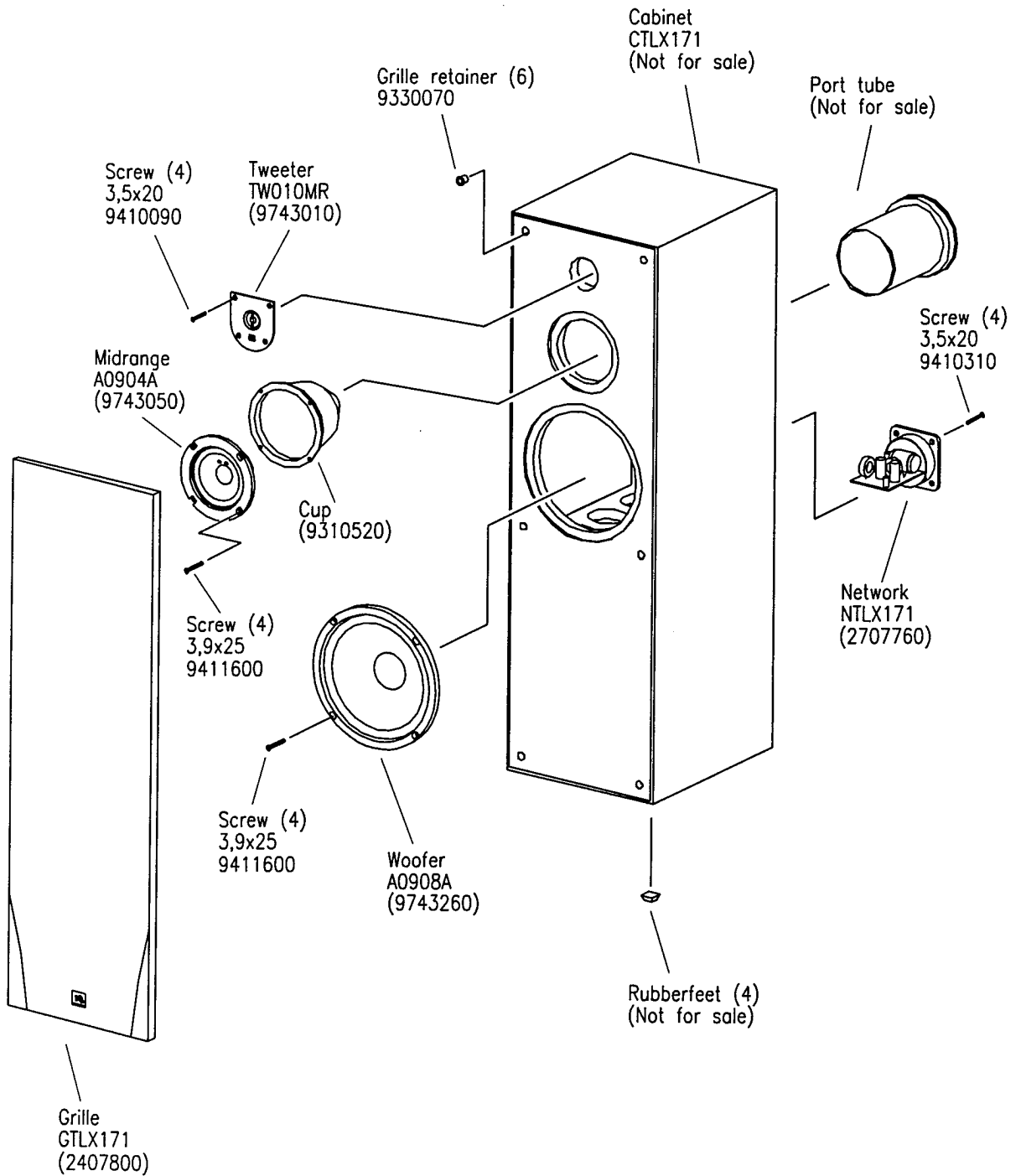

TLX171