

# DVP-NS50P/NS41P/NS52P

RMT-D175A/RMT-D175P

## SERVICE MANUAL



Photo : DVP-NS50P  
RMT-D175A



Notes: US, Canadian and Oceania model only

*US/Canadian Model*

*DVP-NS50P/NS41P*

*Australia/NZ Model*

*Korean Model*

*Middle East Model*

*Singapore Model*

*Taiwan Model*

*DVP-NS50P/NS52P*

*Malaysia Model*

*E Model*

*Hong Kong Model*

*IND, PAK, MAR Model*

*Iran Model*

*MX Model*

*PX Model*

*Saudi Arabia Model*

*DVP-NS50P*

### SPECIFICATIONS

#### System

**Laser:** Semiconductor laser

#### Signal format system:

PAL/NTSC: (NS52P/NS50P  
Except US,CND,MX,PX) NTSC:  
(NS41P/NS50P:US,CND,MX,PX)

#### Audio characteristics

**Frequency response:** DVD VIDEO (PCM  
96 kHz): 2 Hz to 44 kHz ( $\pm 1.0$  dB)/  
DVD VIDEO (PCM 48 kHz): 2 Hz to  
22 kHz ( $\pm 0.5$  dB)/CD: 2 Hz to 20 kHz  
( $\pm 0.5$  dB)

**Signal-to-noise ratio (S/N ratio):** 115 dB  
(LINE OUT L/R (AUDIO) jacks only)

**Harmonic distortion:** 0.003%

**Dynamic range:** DVD VIDEO: 103 dB/  
CD: 99 dB

**Wow and flutter:** Less than detected value  
( $\pm 0.001\%$  W PEAK)

#### Outputs

(**Jack name:** Jack type/Output level/  
Load impedance)

**LINE OUT (AUDIO):** Phono jack/  
2 Vrms/ 10 kilohms

#### DIGITAL OUT (OPTICAL)

Optical output jack/ $-18$  dBm  
(wave length 660 nm) (DVP-NS52P/  
NS50P:AUS,SPTW,HK,ME2,ME5,EA,IR,KR)

**DIGITAL OUT (COAXIAL):** Phono jack/  
0.5 Vp-p/75 ohms

#### COMPONENT VIDEO OUT

(**Y, Pb/Cb, Pr/Cr**)  
Phono jack/Y: 1.0 Vp-p,  
Pb/Cb, Pr/Cr: 0.7 Vp-p/75 ohms  
(NS52P/NS50P Except  
US,CND,PX,MX,E)

#### COMPONENT VIDEO OUT

(**Yz, Pb, Pr**)  
Phono jack/Y: 1.0 Vp-p/Pb,Pr:  
interface<sup>\*1</sup> = 0.648 Vp-p, progressive or  
interface<sup>\*2</sup> = 0.7 Vp-p/75 ohms

<sup>\*1</sup> BLACK LEVEL  
(COMPONENT OUT) is ON

<sup>\*2</sup> BLACK LEVEL  
(COMPONENT OUT) is OFF  
(NS41P/NS50P:US,CND,PX,MX,E)

**LINE OUT (VIDEO):** Phono jack/  
1.0 Vp-p/75 ohms

#### S VIDEO OUT

4-pin mini DIN/Y: 1.0 Vp-p,  
C: 0.3 Vp-p (PAL), 0.286 Vp-p  
(NTSC)/75 ohms (NS52P/NS50P:  
Except US,CND,PX,MX)

#### S VIDEO OUT

4-pin mini DIN/Y: 1.0 Vp-p,  
C: 0.286 Vp-p/75 ohms  
(NS41P/NS50P:US,CND,PX,MX)

#### General

##### Power requirements:

110 V AC, 60 Hz  
(NS50P:TW/NS52P:TW)  
110 - 240 V AC, 50/60 Hz  
(Except NS41P/NS50P:  
US,CND,MX,TW/NS52P:TW)  
120 V AC, 60 Hz  
(NS41P/NS50P:US,CND,MX)

**Power consumption:** 10 W

##### Dimensions (approx.):

430 × 43 × 237.2 mm  
(17 × 11 <sup>11</sup>/<sub>16</sub> × 9 <sup>3</sup>/<sub>8</sub> in.)  
(width/height/depth)  
incl. projecting parts  
430 × 43 × 237.3 (DVP-NS52P)

**Mass (approx.):** 1.92 kg (4 <sup>1</sup>/<sub>3</sub> lb)

**Operating temperature:** 5°C to 35°C

**Operating humidity:** 25% to 80%

##### Supplied accessories

See page 14 (Except NS41P/  
NS50P:US,CND,PX)  
See page 16 (NS41P/NS50P:US,CND,PX)

Specifications and design are subject to  
change without notice.

ENERGY STAR® is a U.S. registered mark.  
As an ENERGY STAR® Partner, Sony  
Corporation has determined that this  
product meets the ENERGY STAR®  
guidelines for energy efficiency.

(DVP-NS41P/NS50P:US,CND,AUS/  
NS52P:AUS)



CD/DVD PLAYER

SONY®

## SAFETY CHECK-OUT

After correcting the original service problem, perform the following safety checks before releasing the set to the customer:

1. Check the area of your repair for unsoldered or poorly-soldered connections. Check the entire board surface for solder splashes and bridges.
2. Check the interboard wiring to ensure that no wires are "pinched" or contact high-wattage resistors.
3. Look for unauthorized replacement parts, particularly transistors, that were installed during a previous repair. Point them out to the customer and recommend their replacement.
4. Look for parts which, though functioning, show obvious signs of deterioration. Point them out to the customer and recommend their replacement.
5. Check the line cord for cracks and abrasion. Recommend the replacement of any such line cord to the customer.
6. Check the B+ voltage to see it is at the values specified.
7. Check the antenna terminals, metal trim, "metallized" knobs, screws, and all other exposed metal parts for AC leakage. Check leakage as described below.

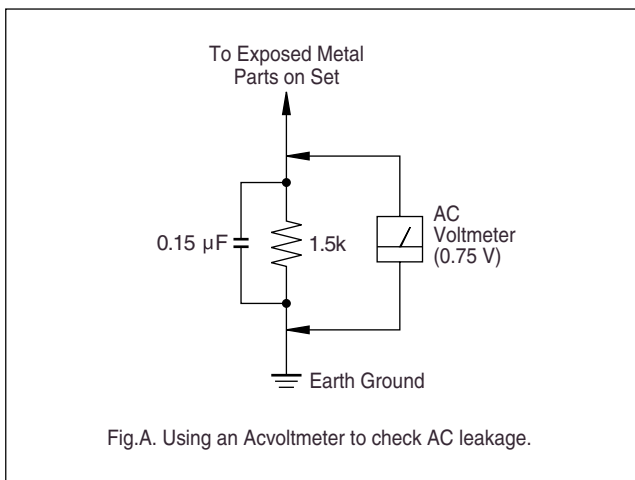

Fig.A. Using an Acvoltmeter to check AC leakage.

### WARNING!!

**WHEN SERVICING, DO NOT APPROACH THE LASER EXIT WITH THE EYE TOO CLOSELY. IN CASE IT IS NECESSARY TO CONFIRM LASER BEAM EMISSION, BE SURE TO OBSERVE FROM A DISTANCE OF MORE THAN 25 cm FROM THE SURFACE OF THE OBJECTIVE LENS ON THE OPTICAL PICK-UP BLOCK.**

### CAUTION:

The use of optical instrument with this product will increase eye hazard.

### CAUTION

Use of controls or adjustments or performance of procedures other than those specified herein may result in hazardous radiation exposure.

### SAFETY-RELATED COMPONENT WARNING!!

**COMPONENTS IDENTIFIED BY MARK  $\triangle$  OR DOTTED LINE WITH MARK  $\triangle$  ON THE SCHEMATIC DIAGRAMS AND IN THE PARTS LIST ARE CRITICAL TO SAFE OPERATION. REPLACE THESE COMPONENTS WITH SONY PARTS WHOSE PART NUMBERS APPEAR AS SHOWN IN THIS MANUAL OR IN SUPPLEMENTS PUBLISHED BY SONY.**

### LEAKAGE TEST

The AC leakage from any exposed metal part to earth ground and from all exposed metal parts to any exposed metal part having a return to chassis, must not exceed 0.5mA (500 microampers). Leakage current can be measured by any one of three methods.

1. A commercial leakage tester, such as the Simpson 229 or RCA TW-540A. Follow the manufacturers' instructions to use these instruments.
2. A battery-operated AC milliammeter. The Data Precision 245 digital multimeter is suitable for this job.
3. Measuring the voltage drop across a resistor by means of a VOM or battery-operated AC voltmeter. The "limit" indication is 0.75V, so analog meters must have an accurate low voltage scale. The Simpson 250 and Sanwa SH-63Trd are examples of a passive VOM that is suitable. Nearly all battery operated digital multimeters that have a 2V AC range are suitable. (See Fig. A)

### Unleaded solder

Boards requiring use of unleaded solder are printed with the lead-free mark (LF) indicating the solder contains no lead.

(Caution: Some printed circuit boards may not come printed with the lead free mark due to their particular size.)



### : LEAD FREE MARK

Unleaded solder has the following characteristics.

- Unleaded solder melts at a temperature about 40°C higher than ordinary solder.  
Ordinary soldering irons can be used but the iron tip has to be applied to the solder joint for a slightly longer time. Soldering irons using a temperature regulator should be set to about 350°C  
Caution: The printed pattern (copper foil) may peel away if the heated tip is applied for too long, so be careful!
- Strong viscosity  
Unleaded solder is more viscous (sticky, less prone to flow) than ordinary solder so use caution not to let solder bridges occur such as on IC pins, etc.
- Usable with ordinary solder  
It is best to use only unleaded solder but unleaded solder may also be added to ordinary solder.

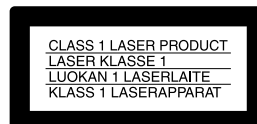

### ATTENTION AU COMPOSANT AYANT RAPPORT À LA SÉCURITÉ!

LES COMPOSANTS IDENTIFÉS PAR UNE MARQUE  $\triangle$  SUR LES DIAGRAMMES SCHÉMATIQUES ET LA LISTE DES PIÈCES SONT CRITIQUES POUR LA SÉCURITÉ DE FONCTIONNEMENT. NE REMPLACER CES COMPOSANTS QUE PAR DES PIÈCES SONY DONT LES NUMÉROS SONT DONNÉS DANS CE MANUEL OU DANS LES SUPPLÉMENTS PUBLIÉS PAR SONY.

## TABLE OF CONTENTS

**SERVICE NOTE**

1. Disc Removal Procedure (at POWER OFF) .....	4
<b>1. GENERAL</b>	
Precautions .....	1-1
This Player Can Play the Following Discs .....	1-1
Index to Parts and Controls .....	1-1
Guide to the Control Menu Display .....	1-2
Hookups .....	1-3
Hooking Up the Player .....	1-3
Step 1: Unpacking .....	1-3
Step 2: Inserting Batteries into the Remote .....	1-3
Step 3: Connecting the Video Cords .....	1-3
Step 4: Connecting the Audio Cords .....	1-4
Step 5: Connecting the Power Cord .....	1-4
Step 6: Quick Setup .....	1-4
Playing Discs .....	1-5
Playing Discs .....	1-5
Resuming Playback from the Point Where You Stopped the Disc (Multi-disc Resume) .....	1-5
Using the DVD's Menu .....	1-6
Selecting "ORIGINAL" or "PLAY LIST" on a DVD-RW .....	1-6
Playing VIDEO CD's With PBC Functions (PBC Playback) .....	1-6
Various Play Mode Functions (Programme Play, Shuffle Play, Repeat Play, A-B Repeat Play) .....	1-6
Searching for a Scene .....	1-7
Searching for a Particular Point on a Disc (Search, Scan, Slow-motion Play, Freeze Frame) .....	1-7
Searching for a Title/Chapter/Track/Scene, etc. ....	1-8
Searching by Scene (PICTURE NAVIGATION) .....	1-8
Viewing Information About the Disc .....	1-8
Checking the Playing Time and Remaining Time .....	1-8
Sound Adjustments .....	1-9
Changing the Sound .....	1-9
TV Virtual Surround Settings (TVS) .....	1-9
Enjoying Movies .....	1-10
Changing the Angles .....	1-10
Displaying the Subtitles .....	1-10
Adjusting the Playback Picture (CUSTOM PICTURE MODE) .....	1-10
Sharpening the Pictures (SHARPNESS) .....	1-11
Enjoying MP3 Audio and JPEG Images .....	1-11
About MP3 Audio Tracks and JPEG Image Files .....	1-11
Playing MP3 Audio Tracks and JPEG Image Files .....	1-11
Enjoying JPEG Images as a Slide Show .....	1-12
Using Various Additional Functions .....	1-12
Locking Discs (CUSTOM PARENTAL CONTROL, PARENTAL CONTROL) .....	1-12
Controlling Your TV with the Supplied Remote .....	1-13
Settings and Adjustments .....	1-13
Using the Setup Display .....	1-13
Setting the Display or Sound Track Language (LANGUAGE SETUP) .....	1-14
Settings for the Display (SCREEN SETUP) .....	1-14
Custom Settings (CUSTOM SETUP) .....	1-14
Settings for the Sound (AUDIO SETUP) .....	1-14
Additional Information .....	1-15
Troubleshooting .....	1-15
Self-diagnosis Function (When letters/ numbers appear in the display) .....	1-16
Glossary .....	1-16
Specifications .....	1-16

**2. DISASSEMBLY**

2-1. Upper Case .....	2-1
2-2. Front Panel Assembly .....	2-1
2-3. Loading Assembly .....	2-2
2-4. Optical Pick-Up (Device, Optical KHM-310CAA/C2RP) .....	2-3
2-5. MV-045 and IF124 Boards .....	2-4
2-6. Switching Regulator .....	2-4
2-7. Interval Views .....	2-5
2-8. Circuit Boards Location .....	2-6

**3. BLOCK DIAGRAMS**

3-1. Overall Block Diagram .....	3-1
3-2. Power Line Block Diagram .....	3-3
3-3. System Control/Signal Processor Block Diagram .....	3-5
3-4. RF/Servo Block Diagram .....	3-7
3-5. Audio Block Diagram .....	3-9
3-6. Video Block Diagram .....	3-11
3-7. Interface Control Block Diagram .....	3-13

**4. PRINTED WIRING BOARDS AND SCHEMATIC DIAGRAMS**

4-1. Frame Schematic Diagram .....	4-1
4-2. Printed Wiring Boards and Schematic Diagrams .....	4-3
Waveform .....	4-4
• MV-045 Printed Wiring Board .....	4-5
• MV-045 (CPU, Servo-DSP, AVDEC) Schematic Diagram .....	4-7
• MV-045 (Drive) Schematic Diagram .....	4-9
• MV-045 (Video) Schematic Diagram .....	4-11
• MV-045 (Audio) Schematic Diagram .....	4-13
• MV-045 (Power) Schematic Diagram .....	4-15
• IF-124 Printed Wiring Board .....	4-17
• IF-124 (Interface) Schematic Diagram .....	4-19
• Power Block (SRV1487UC) Printed Wiring Board ..	4-21
• Power Block (SRV1487UC) Schematic Diagram .....	4-23
• Power Block (SRV1501WW) Printed Wiring Board ..	4-25
• Power Block (SRV1501WW) Schematic Diagram ..	4-27

**5. IC PIN FUNCTION DESCRIPTION**

5-1. System Control-Video Pin Function (MV-045 BOARD IC101) .....	5-1
--	-----

**6. TEST MODE**

6-1. Executing IOP Measurement .....	6-1
6-2. Emergency History Check .....	6-1
6-3. Initializing Setup Data .....	6-2
6-4. Version Information .....	6-3
6-5. If Con Self Diagnostic Function .....	6-3

**7. ELECTRICAL ADJUSTMENT**

7-1. Power Supply Output Voltage Check .....	7-1
7-2. Adjustment of Video System .....	7-2

**8. REPAIR PARTS LIST**

8-1. Exploded Views .....	8-1
8-1-1. Main Section .....	8-1
8-1-2. Mechanism Deck Assembly .....	8-3
8-2. Electrical Parts List .....	8-4

## SERVICE NOTE

### 1. DISC REMOVAL PROCEDURE (at POWER OFF)

- 1) Open dust cover to access to a hole insert a tapering driver into the aperture of the unit bottom, and move the lever of chuck can in the direction of the arrow A. (See Fig. 1)
- 2) Draw out the tray in the direction of the arrow B, and remove a disc. (See Fig. 1)

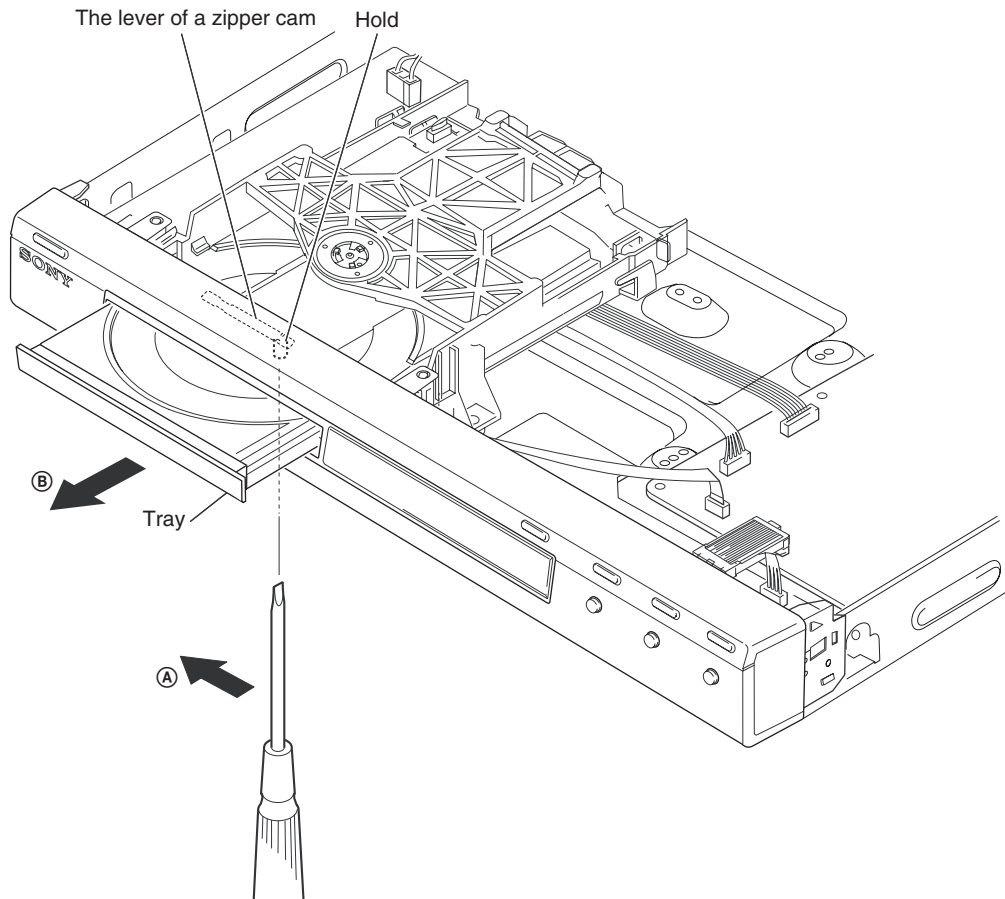

Fig. 1.

# SECTION 1 GENERAL

This section is extracted from instruction manual. 2-581-693-13

## WARNING

To reduce the risk of fire or electric shock, do not expose this apparatus to rain or moisture.

To avoid electrical shock, do not open the cabinet. Refer servicing to qualified personnel only.

The AC power cord must be changed only at a qualified service shop.

## CAUTION

The use of optical instruments with this product will increase eye hazard. As the laser beam used in this CD/DVD player is harmful to eyes, do not attempt to disassemble the cabinet.

Refer servicing to qualified personnel only.



This symbol is intended to alert the user to the presence of uninsulated "dangerous voltage" within the product's enclosure that may be of sufficient magnitude to constitute a risk of electric shock to persons.

This symbol is intended to alert the user to the presence of important operating and maintenance (servicing) instructions in the literature accompanying the appliance.

## CAUTION

You are cautioned that any changes or modifications not expressly approved in this manual could void your authority to operate this equipment.

2

- Never place the set in a confined space, such as a bookcase, or built-in cabinet, unless proper ventilation is provided.
- Do not place the set near or over a radiator or heat register, or where it is exposed to direct sunlight.



## Antennas

### Outdoor antenna grounding

If an outdoor antenna or cable system is installed, follow the precautions below.

An outdoor antenna system should not be located in the vicinity of overhead power lines or other electric light or power circuits, or where it can come in contact with such power lines or circuits.

WHEN INSTALLING AN OUTDOOR ANTENNA SYSTEM, EXTREME CARE SHOULD BE TAKEN TO KEEP FROM CONTACTING SUCH POWER LINES OR CIRCUITS AS CONTACT WITH THEM IS ALMOST INVARIABLY FATAL. Be sure the antenna system is grounded so as to provide some protection against voltage surges and built-up static charges. Section 810 of the National Electrical Code provides information with respect to proper grounding of the mast and supporting structure, grounding of the lead-in wire to an antenna discharge unit, size of grounding conductors, location of antenna-discharge unit, connection to grounding electrodes, and requirements for the grounding electrode.

### Antenna Grounding According to the National Electrical Code

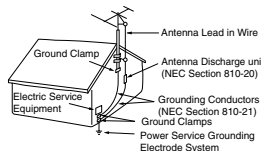

NEC-NATIONAL ELECTRICAL CODE

## Lightning

For added protection for this set during a lightning storm, or when it is left unattended and unused for long periods of time, unplug it from the wall outlet and disconnect the antenna or cable system. This will prevent damage to the set due to lightning and power-line surges.

4

## Notes About the Discs

### Note

This equipment has been tested and found to comply with the limits for a Class B digital device, pursuant to Part 15 of the FCC Rules. These limits are designed to provide reasonable protection against harmful interference in a residential installation. This equipment generates, uses, and can radiate radio frequency energy and, if not installed and used in accordance with the instructions, may cause harmful interference to radio communications. However, there is no guarantee that interference will not occur in a particular installation. If this equipment does cause harmful interference to radio or television reception, which can be determined by turning the equipment off and on, the user is encouraged to try to correct the interference by one or more of the following measures:

- Reorient or relocate the receiving antenna.
- Increase the separation between the equipment and receiver.
- Connect the equipment into an outlet on a circuit different from that to which the receiver is connected.
- Consult the dealer or an experienced radio/TV technician for help.

- To keep the disc clean, handle the disc by its edge. Do not touch the surface.



- Do not expose the disc to direct sunlight or heat sources such as hot air ducts, or leave it in a car parked in direct sunlight as the temperature may rise considerably inside the car.
- After playing, store the disc in its case.
- Clean the disc with a cleaning cloth. Wipe the disc from the center out.



- Do not use solvents such as benzene, thinner, commercially available disc/lens cleaners, or anti-static spray intended for vinyl LPs.
- If you have printed the disc's label, dry the label before playing.

# Important Safeguards

For your protection, please read these safety instructions completely before operating the appliance, and keep this manual for future reference. Carefully observe all warnings, precautions and instructions on the appliance, or the one described in the operating instructions and adhere to them.

## Use

### Power sources

This set should be operated only from the type of power source indicated on the marking label. If you are not sure of the type of electrical power supplied to your home, consult your dealer or local power company. For those sets designed to operate from battery power, or other sources, refer to the operating instructions.



### Grounding or Polarization

This set is equipped with a polarized ac power cord plug (a plug having one blade wider than the other), or with a three-wire grounding type plug (a plug having a third pin for grounding). Follow the instructions below:

### For the set with a polarized AC power cord plug:

This plug will fit into the power outlet only one way. This is a safety feature. If you are unable to insert the plug fully into the outlet, try reversing the plug. If the plug should still fail to fit, contact your electrician to have a suitable outlet installed. Do not defeat the safety purpose of the polarized plug by forcing it in.



### For the set with a three-wire grounding type AC plug:

This plug will only fit into a grounding-type power outlet. This is a safety feature. If you are unable to insert the plug into the outlet, contact your electrician to have a suitable outlet installed. Do not defeat the safety purpose of the grounding plug.



### Overloading

Do not overload wall outlets, extension cords or convenience receptacles beyond their capacity, since this can result in fire or electric shock.



### Object and Liquid Entry

Never push objects of any kind into the set through openings as they may touch dangerous voltage points or short out parts that could result in a fire or electric shock. Never spill liquid of any kind on the set.



## Attachments

Do not use attachments not recommended by the manufacturer, as they may cause hazards.



## Cleaning

Unplug the set from the wall outlet before cleaning or polishing it. Do not use liquid cleaners or aerosol cleaners. Use a cloth lightly dampened with water for cleaning the exterior of the set.



## Installation

### Water and Moisture

Do not use power-line operated sets near water—for example, near a bathtub, washbowl, kitchen sink, or laundry tub, in a wet basement, or near a swimming pool, etc.



### Power-Cord Protection

Route the power cord so that it is not likely to be walked on or pinched by items placed upon or against them, paying particular attention to the plugs, receptacles, and the point where the cord exits from the appliance.



### Accessories

Do not place the set on an unstable cart, stand, tripod, bracket, or table. The set may fall, causing serious injury to a child or an adult, and serious damage to the set. Use only a cart stand, tripod, bracket, or table recommended by the manufacturer.



An appliance and cart combination should be moved with care. Quick stops, excessive force, and uneven surfaces may cause the appliance and cart combination to overturn.



## Ventilation

The slots and openings in the cabinet are provided for necessary ventilation. To ensure reliable operation of the set, and to protect it from overheating, these slots and openings must never be blocked or covered.

- Never cover the slots and openings with a cloth or other materials.



- Never block the slots and openings by placing the set on a bed, sofa, rug or other similar surface.



→ continued 3

## Precautions

The power requirements and power consumption of this player are indicated on the back of the player. Check that the player's operating voltage is identical with your local power supply.

Power requirements and power consumption →



## On safety

- To prevent fire or shock hazard, do not place objects filled with liquids, such as vases, on the apparatus.
- Should any solid object or liquid fall into the cabinet, unplug the player and have it checked by qualified personnel before operating it any further.

## On power sources

- The player is not disconnected from the AC power source as long as it is connected to the wall outlet, even if the player itself has been turned off.
- If you are not going to use the player for a long time, be sure to disconnect the player from the wall outlet. To disconnect the AC power cord, grasp the plug itself; never pull the cord.

## On placement

- Place the player in a location with adequate ventilation to prevent heat build-up in the player.
- Do not place the player on a soft surface such as a rug.
- Do not place the player in a location near heat sources, or in a place subject to direct sunlight, excessive dust, or mechanical shock.
- Do not install the player in an inclined position. It is designed to be operated in a horizontal position only.
- Keep the player and the discs away from equipment with strong magnets, such as microwave ovens, or large loudspeakers.
- Do not place heavy objects on the player.

## On operation

- If the player is brought directly from a cold to a warm location, or is placed in a very damp room, moisture may condense on the lenses inside the player. Should this occur, the player may not operate properly. In this case, remove the disc and leave the player turned on for about half an hour until the moisture evaporates.
- When you move the player, take out any discs. If you don't, the disc may be damaged.

## For the model supplied with the AC plug adaptor

If the AC plug of your unit does not fit into the wall outlet, attach the supplied AC plug adaptor.

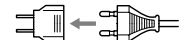

## On adjusting volume

Do not turn up the volume while listening to a section with very low level inputs or no audio signals. If you do, the speakers may be damaged when a peak level section is played.

## On cleaning

Clean the cabinet, panel, and controls with a soft cloth slightly moistened with a mild detergent solution. Do not use any type of abrasive pad, scouring powder or solvent such as alcohol or benzene.

## On cleaning discs, disc/lens cleaners

Do not use a commercially available cleaning disc or disc/lens cleaner (wet or spray type). These may cause the apparatus to malfunction.

## IMPORTANT NOTICE

Caution: This player is capable of holding a still video image or on-screen display image on your television screen indefinitely. If you leave the still video image or on-screen display image displayed on your TV for an extended period of time you risk permanent damage to your television screen. Plasma display panel televisions and projection televisions are susceptible to this.

If you have any questions or problems concerning your player, please consult your nearest Sony dealer.

5

### This Player Can Play the Following Discs

Format of discs	
DVD VIDEO	
DVD-RW/R	
DVD+RW/+R	
VIDEO CD/ Music CD	
CD-RW/-R	

"DVD+RW," "DVD-RW," "DVD+R," "DVD-R," "DVD VIDEO," and "CD" logos are trademarks.

#### Note about CDs/DVDs

The player can play CD-ROMs/CD-Rs/CD-RWs recorded in the following formats:  
 - music CD format  
 - video CD format  
 - MP3 audio tracks and JPEG image files of format conforming to ISO 9660\* Level 1/ Level 2, or its extended format, Joliet  
 - KODAK Picture CD format  
 \* A logical format of files and folders on CD-ROMs, defined by ISO (International Organization for Standardization).

The player can play DVD-ROMs/ DVD+RWs/DVD-RWs/DVD+Rs/DVD-Rs recorded in the following format:  
 - MP3 audio tracks and JPEG image files of format conforming to UDF (Universal Disk Format).

### Example of discs that the player cannot play

The player cannot play the following discs:  
 • CD-ROMs/CD-Rs/CD-RWs other than those recorded in the formats listed on this page.  
 • CD-ROMs recorded in PHOTO CD format.  
 • Data part of CD-Extras.  
 • DVD Audio discs.  
 • HD layer on Super Audio CDs.

Also, the player cannot play the following discs:  
 • A DVD VIDEO with a different region code.  
 • A disc recorded in a color system other than NTSC, such as PAL or SECAM (this player conforms to the NTSC color system).  
 • A disc that has a non-standard shape (e.g., card, heart).  
 • A disc with paper or stickers on it.  
 • A disc that has the adhesive of cellophane tape or a sticker still left on it.

#### Region code

Your player has a region code printed on the back of the unit and only will play DVD VIDEOS (playback only) labeled with identical region codes. This system is used to protect copyrights.

DVD VIDEOS labeled will also play on this player.

If you try to play any other DVD VIDEO, the message "Playback prohibited by area limitations." will appear on the TV screen. Depending on the DVD VIDEO, there may be no region code indication, even though playing the DVD VIDEO is prohibited by area restrictions.

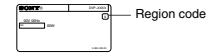

### About This Manual

- Instructions in this manual describe the controls on the remote. You can also use the controls on the player if they have the same or similar names as those on the remote.
- "DVD" may be used as a general term for DVD VIDEOS, DVD+RWs/DVD+Rs and DVD-RWs/DVD-Rs.
- The meaning of the icons used in this manual is described below:

Icons	Meanings
	Functions available for DVD VIDEOS and DVD+RWs/DVD+Rs in +VR mode or DVD-RWs/DVD-Rs in video mode
	Functions available for DVD-RWs in VR (Video Recording) mode
	Functions available for VIDEO CDs (including Super VCDs or CD-Rs/CD-RWs in video CD format or Super VCD format)
	Functions available for music CDs or CD-Rs/CD-RWs in music CD format
	Functions available for DATA CDs (CD-ROMs/CD-Rs/CD-RWs) containing MP3* audio tracks, and JPEG image files
	Functions available for DATA DVDs (DVD-ROMs/DVD+RWs/DVD+Rs/ DVD-RWs/DVD-Rs) containing MP3* audio tracks, and JPEG image files.

\* MP3 (MPEG-1 Audio Layer III) is a standard format defined by ISO (International Organization for Standardization)/IEC (International Electrotechnical Commission) MPEG which compresses audio data.

### Notes

- **Notes about DVD+RWs/DVD+Rs, DVD-RWs/ DVD-Rs or CD-Rs/CD-RWs**  
 Some DVD+RWs/DVD+Rs, DVD-RWs/DVD-Rs, or CD-Rs/CD-RWs cannot be played on this player due to the recording quality or physical condition of the disc, or the characteristics of the recording device and authoring software. The disc will not play if it has not been correctly finalized. For more information, refer to the operating instructions for the recording device. Note that some playback functions may not work with some DVD+RWs/DVD+Rs, even if they have been correctly finalized. In this case, view the disc by normal playback. Also some DATA CDs/DATA DVDs created in Packet Write format cannot be played.
- **Music discs encoded with copyright protection technologies**  
 This product is designed to playback discs that conform to the Compact Disc (CD) standard. Recently, various music discs encoded with copyright protection technologies are marketed by some record companies. Please be aware that among those discs, there are some that do not conform to the CD standard and may not be playable by this product.
- **Note on DualDiscs**  
 A DualDisc is a two sided disc product which mates DVD recorded material on one side with digital audio material on the other side. However, since the audio material side does not conform to the Compact Disc (CD) standard, playback on this product is not guaranteed.

### Note on playback operations of DVDs and VIDEO CDs

Some playback operations of DVDs and VIDEO CDs may be intentionally set by software producers. Since this player plays DVDs and VIDEO CDs according to the disc contents the software producers designed, some playback features may not be available. Also, refer to the instructions supplied with the DVDs or VIDEO CDs.

### Copyrights

This product incorporates copyright protection technology that is protected by U.S. patents and other intellectual property rights. Use of this copyright protection technology must be authorized by Macrovision, and is intended for home and other limited viewing uses only unless otherwise authorized by Macrovision. Reverse engineering or disassembly is prohibited.

### Index to Parts and Controls

For more information, see the pages indicated in parentheses.

#### Front panel

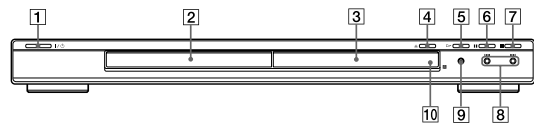

- 1 (on/standby) button (24)
- 2 Disc tray (24)
- 3 Front panel display (11)
- 4 (open/close) button (24)
- 5 (play) button (24)
- 6 (pause) button (25)
- 7 (stop) button (25)
- 8 (previous/next) buttons (34)
- 9 (19)  
Lights up when the player outputs progressive signals.
- 10 (remote sensor) (16)

#### Rear panel

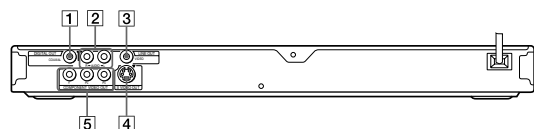

- 1 DIGITAL OUT (COAXIAL) jack (20)
- 2 LINE OUT L/R (AUDIO) jacks (20)
- 3 LINE OUT (VIDEO) jack (17)
- 4 S VIDEO OUT jack (17)
- 5 COMPONENT VIDEO OUT jacks (17)

**Front panel display**

**When playing back a DVD VIDEO/DVD-RW**

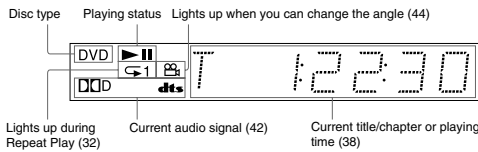

**When playing back a VIDEO CD with Playback Control (PBC) (28)**

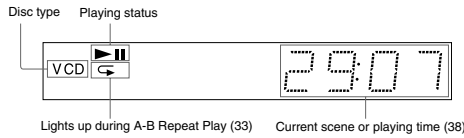

**When playing back a CD, DATA CD/DATA DVD (MP3 audio), or VIDEO CD (without PBC)**

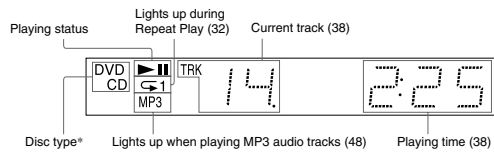

\* When playing DATA DVDs, the DVD indicator is displayed.

→ continued 11

**Remote**

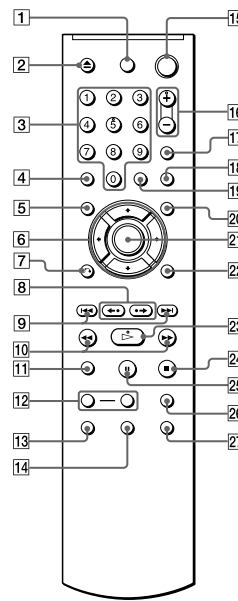

- 9 ◀▶ PREV/NEXT (previous/next) buttons (25)
- 10 ◀◀▶▶ SCAN/SLOW buttons (35)
- 11 ZOOM button (25, 51)
- 12 SLOW PLAY/FAST PLAY buttons (25)
- 13 AUDIO button (41)
- 14 SUBTITLE button (44)
- 15 I/O (on/standby) button (24)
- 16 VOL (volume) +/- buttons (57). The + button has a tactile dot.\*
- 17 TV/VIDEO button (57)
- 18 PICTURE NAVI button (picture navigation) button (37, 51)
- 19 TIME/TEXT button (38)
- 20 MENU button (27)
- 21 ENTER button (22)
- 22 DISPLAY button (13)
- 23 ▷ PLAY button (24). The ▷ button has a tactile dot.\*
- 24 ■ STOP button (25)
- 25 || PAUSE button (25)
- 26 SUR (surround) button (42)
- 27 ◂◃ ANGLE button (44)

\* Use the tactile dot as a reference when operating the player.

- 1 TV I/O (on/standby) button (57)
- 2 ▲ OPEN/CLOSE button (25)
- 3 Number buttons (27). The number 5 button has a tactile dot.\*
- 4 CLEAR button (29)
- 5 TOP MENU button (27)
- 6 ◀/▶/◂/◃ buttons (27)
- 7 ↶ RETURN button (25)
- 8 ◀◂◃▶▶ REPLAY/STEP/ADVANCE/STEP buttons (25, 35)

12

**Guide to the Control Menu Display**

Use the Control Menu to select a function and to view related information. Press DISPLAY repeatedly to turn on or change the Control Menu display as follows:

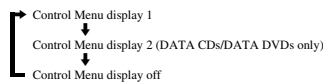

**Control Menu display**

The Control Menu display 1 and 2 will show different items depending on the disc type. For details about each item, see the pages in parentheses.

Example: Control Menu display 1 when playing a DVD VIDEO.

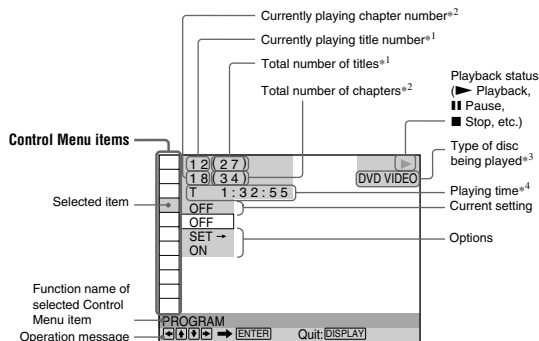

\*1 Displays the scene number for VIDEO CDs (PBC is on), track number for VIDEO CDs/CDs, album number for DATA CDs/DATA DVDs.

\*2 Displays the index number for VIDEO CDs, MP3 audio track number or JPEG image file number for DATA CDs/DATA DVDs.

\*3 Displays Super VCD as "SVCD."

\*4 Displays the date for JPEG files.

**To turn off the display**

Press DISPLAY.

→ continued 13

**List of Control Menu items**

Item	Item Name, Function
	<b>TITLE (page 35)/SCENE (page 35)/TRACK (page 35)</b> Selects the title, scene, or track to be played.
	<b>CHAPTER (page 35)/INDEX (page 35)</b> Selects the chapter or index to be played.
	<b>TRACK (page 35)</b> Selects the track to be played.
	<b>ORIGINAL/PLAY LIST (page 27)</b> Selects the type of titles (DVD-RW) to be played, the ORIGINAL one, or an edited PLAY LIST.
	<b>TIME/TEXT (page 35)</b> Checks the elapsed time and the remaining playback time. Input the time code for picture and music searching. Displays the DVD/CD text, or the DATA CD/DATA DVD track/file name.
	<b>PROGRAM (page 29)</b> Selects the title, chapter, or track to play in the order you want.
	<b>SHUFFLE (page 31)</b> Plays the title, chapter, or track in random order.
	<b>REPEAT (page 32)</b> Plays the entire disc (all titles/all tracks/all albums) repeatedly or one title/chapter/track/album repeatedly.
	<b>A-B REPEAT (page 33)</b> Specifies the parts you want to play repeatedly.
	<b>CUSTOM PICTURE MODE (page 45)</b> Adjusts the video signal from the player. You can select the picture quality that best suits the program you are watching.
	<b>SHARPNESS (page 47)</b> Exaggerates the outline of the image to produce a sharper picture.
	<b>PARENTAL CONTROL (page 54)</b> Set to prohibit playback on this player.
	<b>SETUP (page 58)</b> QUICK Setup (page 22) Use Quick Setup to choose the desired language of the on-screen display, the aspect ratio of the TV and the audio output signal. CUSTOM Setup In addition to the Quick Setup setting, you can adjust various other settings. RESET Returns the settings in "SETUP" to the default setting.
	<b>ALBUM (page 48)</b> Selects the album to be played.
	<b>FILE (page 35)</b> Selects the JPEG image file to be played.
	<b>DATE (page 51)</b> Displays the date the picture was taken by a digital camera.
	<b>INTERVAL (page 53)</b> Specifies the duration for which the slides are displayed on the screen.
	<b>EFFECT (page 53)</b> Selects the effects to be used for changing slides during a slide show.

14

**MODE (MP3, JPEG) (page 52)**  
 Selects the data type: MP3 audio track (AUDIO), JPEG image file (IMAGE) or both (AUTO) to be played when playing a DATA CD or DATA DVD.

**Hint**  
 The Control Menu icon indicator lights up in green when you select any item except "OFF," "PROGRAM," "SHUFFLE," "REPEAT," "A-B REPEAT," "CUSTOM PICTURE MODE," "SHARPNESS" only). The "ORIGINAL/PLAY LIST" indicator lights up in green when you select "PLAY LIST" (default setting).

**Hookups**

**Hooking Up the Player**

Follow steps 1 to 6 to hook up and adjust the settings of the player.

**Notes**

- Plug cords securely to prevent unwanted noise.
- Refer to the instructions supplied with the components to be connected.
- You cannot connect this player to a TV that does not have a video input jack.
- Be sure to disconnect the power cord of each component before connecting.

**Step 1: Unpacking**

Check that you have the following items:  
 • Audio/Video cord (phono plug × 3 ↔ phono plug × 3) (1)  
 • Remote commander (remote) (1)  
 • Size AA (R6) batteries (2)  
 A plug adaptor is included with some models

**Step 2: Inserting Batteries Into the Remote**

You can control the player using the supplied remote. Insert two Size AA (R6) batteries by matching the ⊕ and ⊖ ends on the batteries to the markings inside the compartment. When using the remote, point it at the remote sensor **1** on the player.

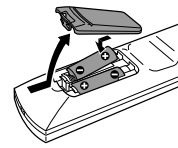

**Notes**

- Do not leave the remote in an extremely hot or humid place.
- Do not drop any foreign object into the remote casing, particularly when replacing the batteries.
- Do not expose the remote sensor to direct light from the sun or a lighting apparatus. Doing so may cause a malfunction.
- If you do not use the remote for an extended period of time, remove the batteries to avoid possible damage from battery leakage and corrosion.

15

16

**Step 3: Connecting the Video Cords**

Connect this player to your TV monitor, projector, or AV amplifier (receiver) using a video cord. Select one of the patterns **A** through **C**, according to the input jack on your TV monitor, projector, or AV amplifier (receiver). In order to view progressive signal (480p) pictures with a compatible TV, projector, or monitor, you must use pattern **C**.

Hookups

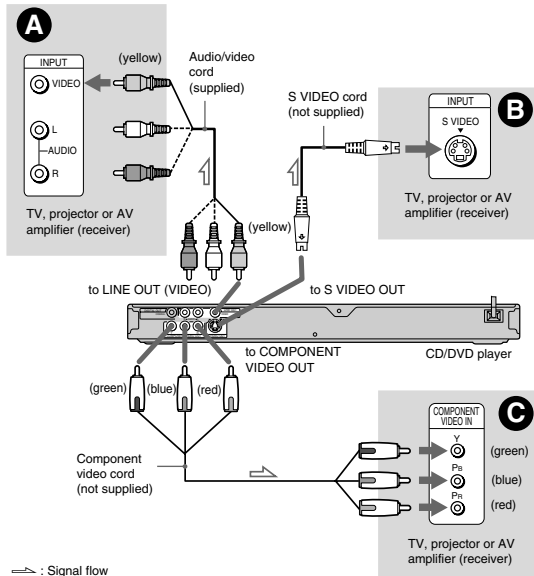

**A If you are connecting to a video input jack**

Connect the yellow plug of an audio/video cord (supplied) to the yellow (video) jack. You will enjoy standard quality images. With this connection, select "NORMAL (INTERLACE)" (default) by pressing the PROGRESSIVE button on the front panel.

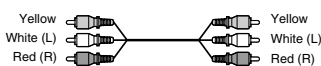

→ continued 17

**B If you are connecting to an S VIDEO input jack**

Connect an S VIDEO cord (not supplied). You will enjoy high quality images. With this connection, select "NORMAL (INTERLACE)" (default) by pressing the PROGRESSIVE button on the front panel.



**C If you are connecting to a monitor, projector, or AV amplifier (receiver) having component video input jacks (Y, Pb, Pr)**

Connect the component via the COMPONENT VIDEO OUT jacks using a component video cord (not supplied) or three video cords (not supplied) of the same kind and length. You will enjoy accurate color reproduction and high quality images. If your TV accepts progressive 480p format signals, use this connection and press the PROGRESSIVE button on the front panel to output progressive signals. For details, see "Using the PROGRESSIVE button" (page 19).

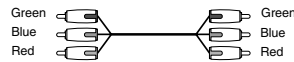

**When connecting to a wide screen TV**

Depending on the disc, the image may not fit your TV screen. To change the aspect ratio, see page 60.

**Notes**

- Do not connect a VCR, etc., between your TV and the player. If you pass the player signals via the VCR, you may not receive a clear image on the TV screen. If your TV has only one audio/video input jack, connect the player to this jack.

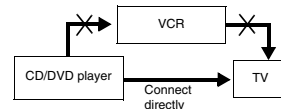

- Consumers should note that not all high definition television sets are fully compatible with this product and may cause artifacts to be displayed in the picture. In case of 480 progressive scan picture problems, it is recommended that the user switch the connection to the "standard definition" output. If there are questions regarding your TV set compatibility with this 480p DVD player model, please contact our customer service center.

18



### Using the PROGRESSIVE button

By using the PROGRESSIVE button on the front panel, you can select the signal format in which the player outputs video signals (Progressive or Interlace), and the conversion method for progressive signals. The PROGRESSIVE indicator lights up when the player outputs progressive signals. Each time you press PROGRESSIVE, the display changes as follows:

PROGRESSIVE AUTO  
↓  
PROGRESSIVE VIDEO  
↓  
NORMAL (INTERLACE)

#### ◆PROGRESSIVE AUTO

Select this setting when:  
– your TV accepts progressive signals, and,  
– the TV is connected to the COMPONENT VIDEO OUT jacks.  
Normally select this under the above condition. This automatically detects the software type, and selects the appropriate conversion method. Note that the picture will not be clear or no picture will appear if you select these settings when either of the above conditions is not met.

#### ◆PROGRESSIVE VIDEO

Select this setting when:  
– your TV accepts progressive signals, and,  
– the TV is connected to the COMPONENT VIDEO OUT jacks, and,  
– you want to fix the conversion method to PROGRESSIVE VIDEO for video-based software. Select this if the image is not clear when you select PROGRESSIVE AUTO. Note that the picture will not be clear or no picture will appear if you select these settings when either of the above conditions is not met.

#### ◆NORMAL (INTERLACE)

Select this setting when:  
– your TV does not accept progressive signals, or,  
– your TV is connected to jacks other than the COMPONENT VIDEO OUT jacks (LINE OUT (VIDEO) or S VIDEO OUT).

### About DVD software types and the conversion method

DVD software can be divided into two types: film-based software and video based software. Video-based software is derived from TV, such as dramas and sit-coms, and displays images at 30 frames/60 fields per second. Film-based software is derived from film and displays images at 24 frames per second. Some DVD software contains both video and film. In order for these images to appear natural on your screen when output in progressive format, the progressive signals need to be converted to match the type of DVD software that you are watching.

#### Notes

- When you play video-based software in progressive signal format, sections of some types of images may appear unnatural due to the conversion process when output through the COMPONENT VIDEO OUT jacks. Images from the S VIDEO OUT and LINE OUT (VIDEO) jacks are unaffected as they are output in the normal (interlace) format.
- When using LINE OUT (VIDEO) or S VIDEO OUT, the picture may appear to flicker each time the PROGRESSIVE button on the front panel is pressed (Interface switches to Progressive or vice versa).

Hooks

### Step 4: Connecting the Audio Cords

Select one of the following patterns **A** or **B**, according to the input jack on your TV monitor, projector, or AV amplifier (receiver). This will enable you to listen to sound.

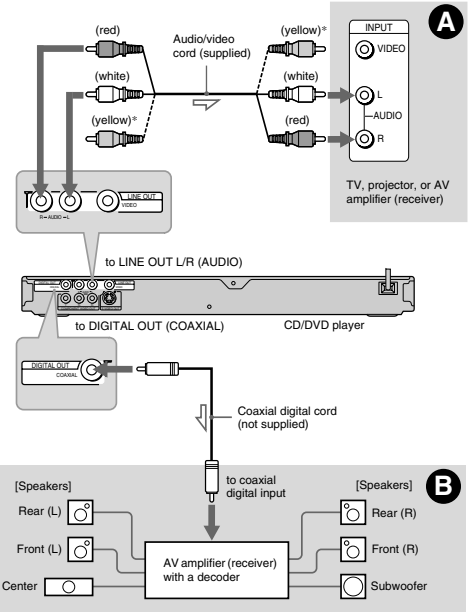

⤵ : Signal flow

\* The yellow plug is used for video signals (page 17).

#### Hint

For correct speaker location, see the operating instructions supplied with the connected components.

19

20

### A Connecting to audio L/R input jacks

This connection will use your TV's or stereo amplifier's (receiver's) two speakers for sound. Connect using the audio/video cord (supplied).

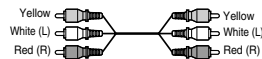

- Surround effect (page 43)  
TV: Dynamic Theater, Dynamic, Wide, Night



Stereo amplifier (receiver): Standard, Night



### B Connecting to a digital audio input jack

If your AV amplifier (receiver) has a Dolby<sup>®</sup>1 Digital or DTS<sup>®</sup>2 decoder and a digital input jack, use this connection. Connect using a coaxial digital cord (not supplied).



- Surround effect  
Dolby Digital (5.1ch), DTS (5.1ch)



<sup>1</sup> Manufactured under license from Dolby Laboratories. "Dolby," "Pro Logic," and the double-D symbol are trademarks of Dolby Laboratories.  
<sup>2</sup> "DTS" and "DTS Digital Out" are trademarks of Digital Theater Systems, Inc.

#### Notes

- After you have completed the connection, make the appropriate settings in Quick Setup (page 22). Otherwise, no sound or a loud noise will come from your speakers.
- The surround sound effects of this player cannot be used with this connection.
- In order to listen to DTS sound tracks, you must use this connection. DTS sound tracks are not output through the LINE OUT L/R (AUDIO) jacks, even if you set "DTS" to "ON" in Quick Setup (page 22).

Hooks

### Step 5: Connecting the Power Cord

Plug the player and TV power cords into an AC outlet.

### Step 6: Quick Setup

Follow the steps below to make the minimum number of basic adjustments for using the player. To skip an adjustment, press **▶▶**. To return to the previous adjustment, press **◀◀**.

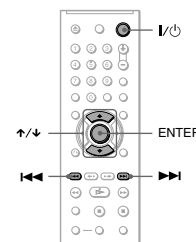

**1** Turn on the TV.

**2** Press I/Power.

**3** Switch the input selector on your TV so that the signal from the player appears on the TV screen.

"Press [ENTER] to run QUICK SETUP" (press enter to run Quick Setup) appears at the bottom of the screen. If this message does not appear, select "QUICK" (quick) under "SETUP" (setup) in the Control Menu to run Quick Setup (page 59).

**4** Press ENTER without inserting a disc.

The Setup Display for selecting the language used in the on-screen display appears.

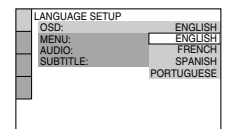

**5** Press **↑/↓** to select a language. The player displays the menu and subtitles in the selected language.

**6** Press ENTER.

The Setup Display for selecting the aspect ratio of the TV to be connected appears.

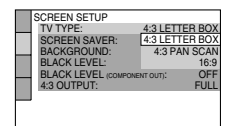

21

22

**7** Press  $\uparrow/\downarrow$  to select the setting that matches your TV type.

- ◆ If you have a 4:3 standard TV
  - 4:3 LETTER BOX or 4:3 PAN SCAN (page 60)
- ◆ If you have a wide-screen TV or a 4:3 standard TV with a wide-screen mode
  - 16:9 (page 60)

**8** Press ENTER.

The Setup Display for selecting the type of jack used to connect your amplifier (receiver) appears.

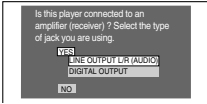

**9** Press  $\uparrow/\downarrow$  to select the type of jack (if any) you are using to connect to an amplifier (receiver), then press ENTER.

If you did not connect an AV amplifier (receiver), select "NO," then go to step 13.  
If you connected an AV amplifier (receiver) using just an audio cord, select "YES: LINE OUTPUT L/R (AUDIO)," then go to step 13.  
If you connected an AV amplifier (receiver) using a digital coaxial cord, select "YES: DIGITAL OUTPUT."

**10** Press  $\uparrow/\downarrow$  to select the type of Dolby Digital signal you wish to send to your amplifier (receiver).

If your AV amplifier (receiver) has a Dolby Digital decoder, select "DOLBY DIGITAL." Otherwise, select "D-PCM."

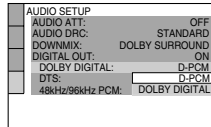

**11** Press ENTER.

"DTS" is selected.

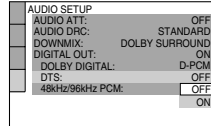

**12** Press  $\uparrow/\downarrow$  to select whether or not you wish to send a DTS signal to your amplifier (receiver).

If your AV amplifier (receiver) has a DTS decoder, select "ON." Otherwise, select "OFF."

**13** Press ENTER.

Quick Setup is finished. All connections and setup operations are complete.

Hookups

Playing Discs



Depending on the DVD or VIDEO CD, some operations may be different or restricted. Refer to the operating instructions supplied with your disc.

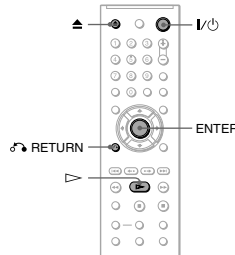

- Turn on your TV.
- Press I/Power. The player turns on.
- Switch the input selector on your TV so that the signal from the player appears on the TV screen.
  - ◆ When using an amplifier (receiver) select the appropriate channel so that you can hear sound from the player.

**4** Press  $\triangle$  on the player, and place a disc on the disc tray.

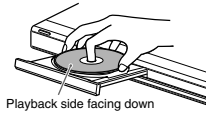

**5** Press  $\triangleright$ .

The disc tray closes. The player starts playback (continuous play). Adjust the volume on the TV or the amplifier (receiver). Depending on the disc, a menu may appear on the TV screen. For DVD VIDEOS, see page 27. For VIDEO CDs, see page 28.

**To turn off the player**  
Press I/Power. The player enters standby mode.

**Hint**  
You can have the player turn off automatically whenever you leave it in stop mode for more than 30 minutes. To turn this function on or off, set "AUTO POWER OFF" in "CUSTOM SETUP" to "ON" or "OFF" (page 61).

**Notes on playing DTS sound tracks on a DVD VIDEO**

- DTS audio signals are output only through the DIGITAL OUT (COAXIAL) jack.
- When you play a DVD VIDEO with DTS sound tracks, set "DTS" to "ON" in "AUDIO SETUP" (page 63).
- If you connect the player to audio equipment without a DTS decoder, do not set "DTS" to "ON" in "AUDIO SETUP" (page 63). A loud noise may come out from the speakers, affecting your ears or causing the speakers to be damaged.

**Note**  
Discs created on DVD recorders must be correctly finalized before they can be played. For more information about finalizing, refer to the operating instructions supplied with the DVD recorder.

Additional operations

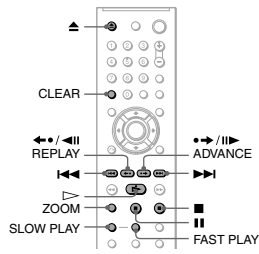

To	Operation
Stop	Press $\blacksquare$
Pause	Press $\parallel$
Resume play after pause	Press $\parallel$ or $\triangleright$
Go to the next chapter, track, or scene in continuous play mode	Press $\triangleright$
Go back to the previous chapter, track, or scene in continuous play mode	Press $\triangleleft$
Stop play and remove the disc	Press $\triangle$
Replay the previous scene <sup>#1</sup>	Press $\triangleleft$ REPLAY during playback
Briefly fast forward the current scene <sup>#2</sup>	Press $\triangleright$ ADVANCE during playback
Magnify the image <sup>#3</sup>	Press ZOOM repeatedly. Press CLEAR to cancel.

<sup>#1</sup> DVD VIDEOS/DVD-RWs/DVD-Rs only  
<sup>#2</sup> DVD VIDEOS/DVD-RWs/DVD-Rs/DVD+Rws/DVD+Rs only  
<sup>#3</sup> Video and JPEG pictures only (except BACKGROUND pictures). You can move the enlarged picture using  $\triangleleft/\triangleright/\uparrow/\downarrow$ . Depending upon the contents of the disc, the zoom function may be canceled automatically when the picture is moved.

**Note**  
You may not be able to use the Replay or Advance function with some scenes.

Playback quickly or slowly with sound

You can listen to dialog or sound while playing the current scene quickly or slowly.

**During Playback, press FAST PLAY or SLOW PLAY.**  
The speed changes when you press either FAST PLAY or SLOW PLAY.

**To return to normal playback**  
Press  $\triangleright$ .

- Notes**
- You can only use this function with DVDs/VIDEO CDs/Super VCDs and DVD-RWs in VR mode only.
  - "Operation not possible" will appear when maximum or minimum speed is reached.
  - During Fast Play or Slow Play mode, you cannot change the angle (page 44), subtitle (page 44) and sound (page 41). The sound can only be changed for VIDEO CDs/Super VCDs.
  - Fast Play and Slow Play functions do not work when playing DTS sound tracks.
  - You cannot use Fast Play or Slow Play functions when playing a still picture on DVD-RW in VR mode.

Locking the disc tray (Child Lock)

You can lock the disc tray to prevent children from opening it.

**When the player is in standby mode, press  $\triangleleft$  RETURN, ENTER, and then I/Power on the remote.**  
The player turns on and "LOCKED" appears on the front panel display. The  $\triangle$  and  $\triangleleft$  buttons on the player or the remote do not work while the Child Lock is set.

**To unlock the disc tray**  
When the player is in standby mode, press  $\triangleleft$  RETURN, ENTER, and then I/Power again.

**Note**  
Even if you select "RESET" under "SETUP" in the Control Menu (page 59), the disc tray remains locked.

Playing Discs

Resuming Playback From the Point Where You Stopped the Disc (Multi-disc Resume) DVD-V VCD

The player stores the point where you stopped the disc for up to 6 discs and resumes playback the next time you insert the same disc. If you store a resume playback point for the seventh disc, the resume playback point for the first disc is deleted.

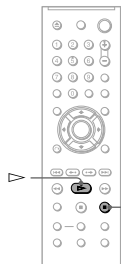

- While playing a disc, press  $\blacksquare$  to stop playback. "RESUME" appears on the front panel display.
- Press  $\triangleright$ . The player starts playback from the point where you stopped the disc in step 1.

**Hint**  
To play from the beginning of the disc, press  $\blacksquare$  twice, then press  $\triangleright$ .

## Using the DVD's Menu **DVD-V**

A DVD is divided into long sections of a picture or a music feature called "titles." When you play a DVD which contains several titles, you can select the title you want using the TOP MENU button. When you play DVDs that allow you to select items such as language for the sound and subtitles, select these items using the MENU button.

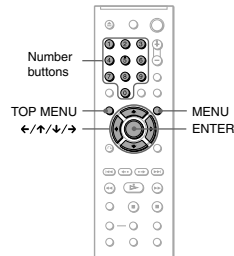

### 1 Press TOP MENU or MENU.

The disc's menu appears on the TV screen. The contents of the menu vary from disc to disc.

### 2 Press ←/→/↔ or the number buttons to select the item you want to play or change.

If you press the number buttons, the following display appears. Press the number buttons to select the item you want.

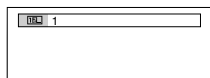

### 3 Press ENTER.

## Selecting "ORIGINAL" or "PLAY LIST" on a DVD-RW **DVD-RW**

Some DVD-RWs in VR (Video Recording) mode have two types of titles for playback: originally recorded titles (ORIGINAL) and titles that can be created on recordable DVD players for editing (PLAY LIST). You can select the type of title to be played.

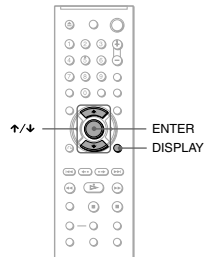

### 1 Press DISPLAY when the player is in stop mode.

The Control Menu appears.

### 2 Press ↑/↓ to select (ORIGINAL/PLAY LIST), then press ENTER.

The options for "ORIGINAL/PLAY LIST" appear.

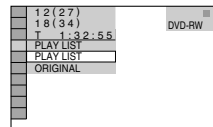

→ continued 27

### 3 Press ↑/↓ to select a setting.

- PLAY LIST: plays the titles created from "ORIGINAL" for editing.
- ORIGINAL: plays the titles originally recorded.

### 4 Press ENTER.

Playing Discs

## Playing VIDEO CDs With PBC Functions (PBC Playback) **VCD**

PBC (Playback Control) allows you to play VIDEO CDs interactively by following the menu on the TV screen.

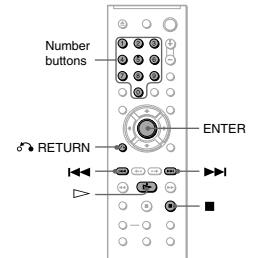

### 1 Start playing a VIDEO CD with PBC functions.

The menu for your selection appears.

### 2 Press the number buttons to select the item number you want.

### 3 Press ENTER.

### 4 Follow the instructions in the menu for interactive operations.

Refer to the instructions supplied with the disc, as the operating procedure may differ depending on the VIDEO CD.

To return to the menu Press RETURN.

### Hint

To play without using PBC, press ←/→/↔ or the number buttons while the player is stopped to select a track, then press ▷ or ENTER. "Play without PBC" appears on the TV screen and the player starts continuous play. You cannot play still pictures such as a menu. To return to PBC playback, press ■ twice then press ▷.

### Note

Depending on the VIDEO CD, "Press ENTER" in step 3 may appear as "Press SELECT" in the instructions supplied with the disc. In this case, press ▷.

## Various Play Mode Functions (Program Play, Shuffle Play, Repeat Play, A-B Repeat Play)

You can set the following play modes:

- Program Play (page 29)
- Shuffle Play (page 31)
- Repeat Play (page 32)
- A-B Repeat Play (page 33)

Playing Discs

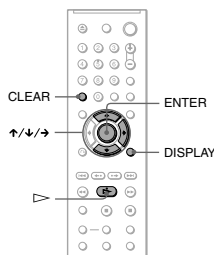

### Note

The play mode is canceled when:  
 - you open the disc tray.  
 - the player enters standby mode by pressing I/O.

## Creating your own program (Program Play) **DVD-V VCD CD**

You can play the contents of a disc in the order you want by arranging the order of the titles, chapters, or tracks on the disc to create your own program. You can program up to 99 titles, chapters, and tracks.

### 1 Press DISPLAY.

The Control Menu appears.

### 2 Press ↑/↓ to select (PROGRAM), then press ENTER.

The options for "PROGRAM" appear.

→ continued 29

28

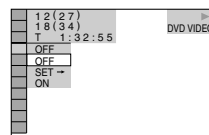

### 3 Press ↑/↓ to select "SET →," then press ENTER.

"TRACK" is displayed when you play a VIDEO CD, or CD.

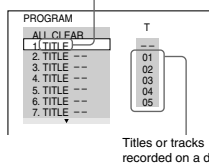

### 4 Press →.

The cursor moves to the title or track row "T" (in this case, "01").

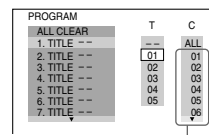

### 5 Select the title, chapter, or track you want to program.

#### ◆ When playing a DVD VIDEO

For example, select chapter "03" of title "02."

Press ↑/↓ to select "02" under "T," then press ENTER.

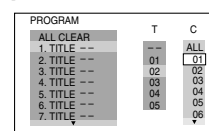

Next, press ↑/↓ to select "03" under "C," then press ENTER.

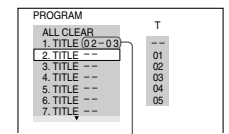

Selected title and chapter

#### ◆ When playing a VIDEO CD, or CD

For example, select track "02." Press ↑/↓ to select "02" under "T," then press ENTER.

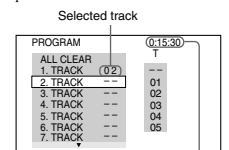

Total time of the programmed tracks

### 6 To program other titles, chapters, or tracks, repeat steps 4 to 5.

The programmed titles, chapters, and tracks are displayed in the selected order.

### 7 Press ▷ to start Program Play.

Program Play begins. When the program ends, you can restart the same program again by pressing ▷.

### To return to normal play

Press CLEAR, or select "OFF" in step 3. To play the same program again, select "ON" in step 3 and press ENTER.

### To change or cancel a program

1 Follow steps 1 to 3 of "Creating your own program (Program Play)."

2 Select the program number of the title, chapter, or track you want to change or cancel using ↑/↓ and press →. If you want to delete the title, chapter, or track from the program, press CLEAR.

**Playing repeatedly (Repeat Play)**

DVD-V DVD-RW VCD CD DATA CD DATA DVD

You can play all of the titles or tracks on a disc, or a single title, chapter, or track repeatedly. You can use a combination of Shuffle or Program Play modes.

1 Press **DISPLAY** during playback. The Control Menu appears.

2 Press **↑/↓** to select **REPEAT**, then press **ENTER**. The options for "REPEAT" appear.

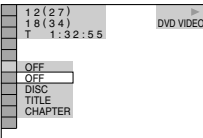

3 Press **↑/↓** to select the item to be repeated.

- ◆ When playing a DVD VIDEO
  - DISC: repeats all of the titles.
  - TITLE: repeats the current title on a disc.
  - CHAPTER: repeats the current chapter.
- ◆ When playing a DVD-RW
  - DISC: repeats all the titles of the selected type.
  - TITLE: repeats the current title on a disc.
  - CHAPTER: repeats the current chapter.
- ◆ When playing a VIDEO CD or CD
  - DISC: repeats all of the tracks.
  - TRACK: repeats the current track.
- ◆ When playing a DATA CD or DATA DVD with MP3 audio tracks or JPEG image files
  - DISC: repeats all of the albums.
  - ALBUM: repeats the current album.
  - TRACK (MP3 audio tracks only): repeats the current track.

◆ When Program Play or Shuffle Play is activated

- ON: repeats Program Play or Shuffle Play.

4 Press **ENTER**. Repeat Play starts.

To return to normal play Press CLEAR, or select "OFF" in step 3.

Hint You can set Repeat Play while the player is stopped. After selecting the "REPEAT" option, press **▷**. Repeat Play starts.

- Notes**
- You cannot use this function with VIDEO CDs or Super VCDs with PBC playback.
  - When repeating a DATA CD/DATA DVD which contains MP3 audio tracks and JPEG image files, and their playing times are not the same, the sound will not match the image.
  - When "MODE (MP3, JPEG)" is set to "IMAGE (JPEG)" (page 52), you cannot select "TRACK."

**Repeating a specific portion (A-B Repeat Play)**

DVD-V DVD-RW VCD CD

You can play a specific portion of a title, chapter or track repeatedly. (This function is useful when you want to memorize lyrics, etc.)

1 Press **DISPLAY** during playback. The Control Menu appears.

2 Press **↑/↓** to select **A-B REPEAT**, then press **ENTER**. The options for "A-B REPEAT" appear.

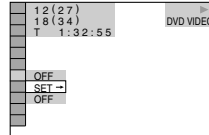

3 Press **↑/↓** to select "SET →," then press **ENTER**. The "A-B REPEAT" setting bar appears.

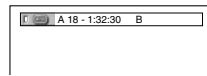

4 During playback, when you find the starting point (point A) of the portion to be played repeatedly, press **ENTER**. The starting point (point A) is set.

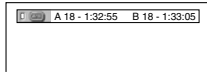

5 When you reach the ending point (point B), press **ENTER** again. The set points are displayed and the player starts repeating this specific portion.

To return to normal play Press CLEAR, or select "OFF" in step 3.

- Notes**
- When you set A-B Repeat Play, the settings for Shuffle Play, Repeat Play, and Program Play are canceled.
  - A-B Repeat Play does not work across multiple titles.
  - You may not set A-B Repeat Play for contents on a DVD-RW (VR mode) that contains still pictures.

Playing Discs

**Searching for a Scene**

**Searching for a Particular Point on a Disc (Search, Scan, Slow-motion Play, Freeze Frame)**

You can quickly locate a particular point on a disc by monitoring the picture or playing back slowly.

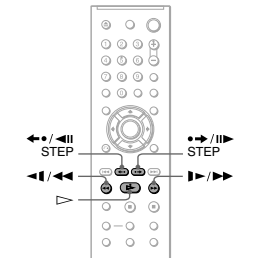

- Notes**
- Depending on the disc, you may not be able to do some of the operations described.
  - For DATA CDs/DATA DVDs, you can search for a particular point only on an MP3 audio track.

**Locating a point quickly using the PREV (previous)/NEXT (next) buttons (Search)**

DVD-V DVD-RW VCD CD DATA CD DATA DVD

You can search for the next or previous chapter, track, or scene using **◀▶** on the player. During playback, press **▶** or **◀** once briefly to go to the next or previous chapter/track/scene. Or, press and hold **▶** or **◀** to search forward or backwards, and release the button when you find the point you want to return to normal playback. (Search)

**Locating a point quickly by playing a disc in fast forward or fast reverse (Scan)**

DVD-V DVD-RW VCD CD DATA CD DATA DVD

Press **▶▶** or **◀◀** while playing a disc. When you find the point you want, press **▷** to return to normal speed. Each time you press **▶▶** or **◀◀** during scan, the scan speed changes. With each press the indication changes as shown below. Actual speeds may differ between discs.

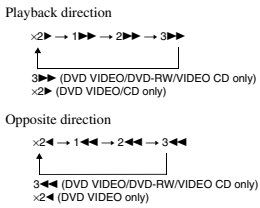

The "x2▶▶"/"x2◀◀" playback speed is about twice the normal speed. The "3▶▶"/"3◀◀" playback speed is faster than "2▶▶"/"2◀◀" and the "2▶▶"/"2◀◀" playback speed is faster than "1▶▶"/"1◀◀".

**Watching frame by frame (Slow-motion Play)**

DVD-V DVD-RW VCD

Press **◀◀** or **▶▶** when the player is in pause mode. To return to normal speed, press **▷**. Each time you press **◀◀** or **▶▶** during Slow-motion Play, the playback speed changes. Two speeds are available. With each press the indication changes as follows:

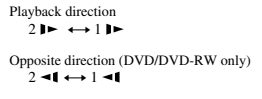

The "2▶▶"/"2◀◀" playback speed is slower than "1▶▶"/"1◀◀".

**Playing one frame at a time (Freeze Frame)**

When the player is in the pause mode, press **▶▶** STEP to go to the next frame. Press **◀◀** STEP to go to the preceding frame (DVD/DVD-RW only). To return to normal playback, press **▷**.

- Note**
- You cannot search for a still picture on a DVD-RW in VR mode.

**Searching for a Title/Chapter/Track/Scene, etc.**

DVD-V DVD-RW VCD CD DATA CD DATA DVD

You can search a DVD by title or chapter, and you can search a VIDEO CD/DATA CD/DATA DVD by track, index, or scene. As titles and tracks are assigned unique numbers on the disc, you can select the desired one by entering its number. You can also search for a scene using the time code.

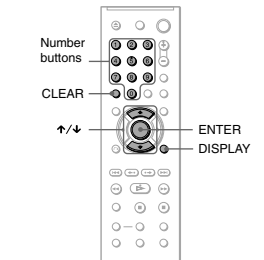

- 1 Press **DISPLAY**. (When playing a DATA CD or DATA DVD with JPEG image files, press twice.) The Control Menu appears.
- 2 Press **↑/↓** to select the search method.

- ◆ When playing a DVD VIDEO/DVD-RW
  - ◀ TITLE
  - ◀ CHAPTER
  - ◀ TIME/TEXT

Select "TIME/TEXT" to search for a starting point by inputting the time code.

Searching for a Scene

◆ When playing a VIDEO CD or Super VCD without PBC Playback  
 TRACK  
 INDEX

◆ When playing a VIDEO CD or Super VCD with PBC Playback  
 SCENE

◆ When playing a CD  
 TRACK

◆ When playing a DATA CD/DATA DVD  
 ALBUM  
 TRACK (MP3 audio tracks only)  
 FILE (JPEG image files only)

Example: when you select CHAPTER  
 \*\*\* (\*\*\*) is selected (\*\* refers to a number). The number in parentheses indicates the total number of titles, chapters, tracks, indexes, scenes, albums or files.

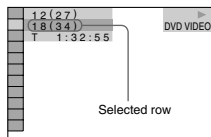

3 Press ENTER.

\*\*\* (\*\*\*) changes to "... (\*\*\*)"

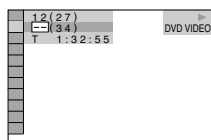

4 Press the number buttons to select the title, chapter, track, index, scene, etc., number you want to search.

If you make a mistake  
 Cancel the number by pressing CLEAR, then select another number.

5 Press ENTER.

The player starts playback from the selected number.

To search for a scene using the time code (DVD VIDEO/DVD-RW only)

1 In step 2, select TIME/TEXT. "T \*\*: \*\*: \*\*: \*" (playing time of the current title) is selected.

2 Press ENTER.  
 "T \*\*: \*\*: \*\*: \*" changes to "T --:--:--."

3 Input the time code using the number buttons, then press ENTER.  
 For example, to find the scene at 2 hours, 10 minutes, and 20 seconds after the beginning, just enter "2:10:20."

**Hints**

- When the Control Menu display is turned off, you can search for a chapter (DVD VIDEO/DVD-RW) or track (CD/DATA CD/DATA DVD) by pressing the number buttons and ENTER.
- You can display the first scene of titles, chapters, or tracks recorded on the disc on a screen divided into 9 sections. You can start playback directly by selecting one of the scenes. For details, see "Searching by Scene (PICTURE NAVIGATION)" (page 37).

**Notes**

- The title, chapter, or track number displayed is the same number recorded on the disc.
- You cannot search for a scene on a DVD+RW/DVD+R using the time code.

**Searching by Scene**

(PICTURE NAVIGATION) DVD-V VCD

You can divide the screen into 9 sections and find the desired scene quickly.

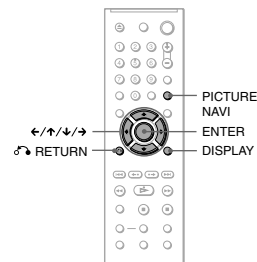

1 Press PICTURE NAVI during playback.

The following display appears.

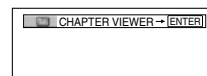

2 Press PICTURE NAVI repeatedly to select an item.

- CHAPTER VIEWER (DVD VIDEO only): displays the first scene of each chapter.
- TITLE VIEWER (DVD VIDEO only): displays the first scene of each title.
- TRACK VIEWER (VIDEO CD/ Super VCD only): displays the first scene of each track.

3 Press ENTER.

The first scene of each chapter, title, or track appears as follows.

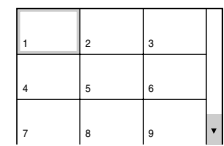

4 Press / to select a chapter, title, or track, and press ENTER. Playback starts from the selected scene.

To return to normal play during setting  
 Press RETURN or DISPLAY.

**Hint**

If there are more than 9 chapters, titles, or tracks, ▼ is displayed at the bottom right of the screen. To display the additional chapters, titles, or tracks, select the bottom scenes and press ▼. To return to the previous scene, select the top scenes and press ↑.

**Note**

Depending on the disc, you may not be able to select some items.

**Viewing Information About the Disc**

**Checking the Playing Time and Remaining Time**

DVD-V DVD-RW VCD CD

DATA CD DATA DVD

You can check the playing time and remaining time of the current title, chapter, or track. Also, you can check the DVD/CD text or track name (MP3 audio) recorded on the disc.

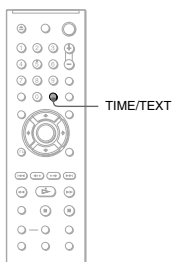

1 Press TIME/TEXT during playback.

The following display appears.

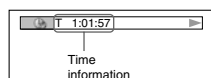

2 Press TIME/TEXT repeatedly to change the time information.

The available time information depends upon the type of disc you are playing.

◆ When playing a DVD VIDEO or DVD-RW

- T \*: \*: \*: \* (hours: minutes: seconds) Playing time of the current title
- T --:--:-- Remaining time of the current title
- C \*: \*: \*: \* Playing time of the current chapter
- C --:--:-- Remaining time of the current chapter

◆ When playing a VIDEO CD or Super VCD (with PBC functions)

- \*: \*: \* (minutes: seconds) Playing time of the current scene

◆ When playing a VIDEO CD (without PBC functions), or CD

- T \*: \*: \* (minutes: seconds) Playing time of the current track
- T --:--:-- Remaining time of the current track
- D \*: \* Playing time of the current disc
- D --:--:-- Remaining time of the current disc

◆ When playing a Super VCD (without PBC functions)

- T \*: \*: \* (minutes: seconds) Playing time of the current track

◆ When playing a DATA CD or DATA DVD (MP3 audio)

- T \*: \*: \* (minutes: seconds) Playing time of the current track

**Checking the play information of the disc**

To check the DVD/CD text

Press TIME/TEXT repeatedly in step 2 to display text recorded on the DVD/CD. The DVD/CD text appears only when text is recorded in the disc. You cannot change the text. If the disc does not contain text, "NO TEXT" appears.



To check DATA CD/DATA DVD (MP3 audio) album name, etc.

By pressing TIME/TEXT while playing MP3 audio tracks on a DATA CD/DATA DVD, you can display the name of the album/track, and the audio bit rate (the amount of data per second of the current audio track) on your TV screen.

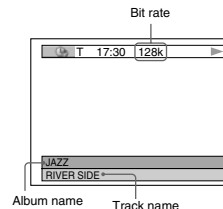

**Checking the information on the front panel display**

You can view the time information and text displayed on the TV screen also on the front panel display. The information on the front panel display changes as follows when you change the time information on your TV screen.

When playing a DVD VIDEO or DVD-RW

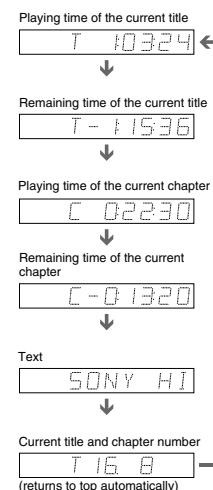

Viewing Information About the Disc

**When playing a DATA CD/DATA DVD (MP3 audio)**

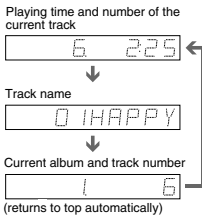

**When playing a VIDEO CD (without PBC functions), or CD**

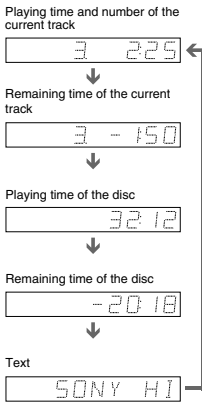

**Hints**

- When playing VIDEO CDs without PBC functions, the track number and the index number are displayed after the text.
- When playing VIDEO CDs with PBC functions, the scene number or the playing time are displayed.
- Long text that does not fit in a single line will scroll across the front panel display.
- You can also check the time information and text using the Control Menu (page 13).

**Notes**

- Depending on the type of disc being played, the DVD/CD text or track name may not be displayed.
- The player can only display the first level of the DVD/CD text, such as the disc name or title.
- Playing time of MP3 audio tracks may not be displayed correctly.
- If you play a disc containing JPEG image files only, "NO AUDIO DATA" appears when "MODE (MP3, JPEG)" is set to "AUTO." "JPEG" appears when "MODE (MP3, JPEG)" is set to "IMAGE (JPEG)" in the front panel display.

**Sound Adjustments**

**Changing the Sound DVD-V**

- DVD-RW
- VCD
- CD
- DATA CD
- DATA DVD

When playing a DVD VIDEO recorded in multiple audio formats (PCM, Dolby Digital, or DTS), you can change the audio format. If the DVD VIDEO is recorded with multilingual tracks, you can also change the language.

With CDs, DATA CDs, DATA DVDs, or VIDEO CDs, you can select the sound from either the right or left channel and listen to the sound of the selected channel through both the right and left speakers. For example, when playing a disc containing a song with the vocals on the right channel and the instruments on the left channel, you can hear the instruments from both speakers by selecting the left channel.

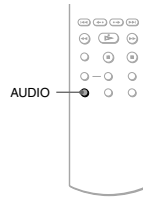

**1 Press AUDIO during playback.**

The following display appears.

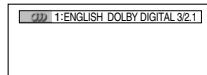

**2 Press AUDIO repeatedly to select the desired audio signal.**

**◆ When playing a DVD VIDEO**

Depending on the DVD VIDEO, the choice of language varies. When 4 digits are displayed, they indicate a language code. See "Language Code List" on page 70 to see which language the code represents. When the same language is displayed two or more times, the DVD VIDEO is recorded in multiple audio formats.

**◆ When playing a DVD-RW**

The types of sound tracks recorded on a disc are displayed. The default setting is underlined.

- Example:
- 1: MAIN (main sound)
  - 1: SUB (sub sound)
  - 1: MAIN+SUB (main and sub sound)

**◆ When playing a VIDEO CD, CD, or DATA CD/DATA DVD (MP3 audio)**

- The default setting is underlined.
- STEREO: the standard stereo sound
  - 1/L: the sound of the left channel (monaural)
  - 2/R: the sound of the right channel (monaural)

**◆ When playing a Super VCD**

- The default setting is underlined.
- 1: STEREO: the stereo sound of the audio track 1
  - 1: 1/L: the sound of the left channel of the audio track 1 (monaural)
  - 1: 2/R: the sound of the right channel of the audio track 1 (monaural)
  - 2: STEREO: the stereo sound of the audio track 2
  - 2: 1/L: the sound of the left channel of the audio track 2 (monaural)
  - 2: 2/R: the sound of the right channel of the audio track 2 (monaural)

Sound Adjustments

**Notes**

- While playing a Super VCD on which the audio track 2 is not recorded, no sound will come out when you select "2: STEREO," "2: 1/L," or "2: 2/R."
- When playing DVD-RW in VR mode: If you connected to an AV amplifier (receiver) using the DIGITAL OUT (COAXIAL or OPTICAL) jack and want to switch between the sound tracks, set "DOLBY DIGITAL" to "D-PCM" in "AUDIO SETUP."

→ continued 41

**Checking the audio signal format DVD-V**

You can check the audio signal format by pressing AUDIO repeatedly during playback. The format of the current audio signal (Dolby Digital, DTS, PCM, etc.) appears as shown below.

**Example:**  
Dolby Digital 5.1 ch

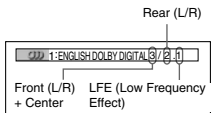

**Example:**  
Dolby Digital 3 ch

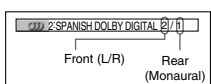

**About audio signals**

Audio signals recorded in a disc contain the sound elements (channels) shown below. Each channel is output from a separate speaker.

- Front (L)
- Front (R)
- Center
- Rear (L)
- Rear (R)
- Rear (Monaural): This signal can be either the Dolby Surround Sound processed signals or the Dolby Digital sound's monaural rear audio signals.
- LFE (Low Frequency Effect) signal

**Note**

If "DTS" is set to "OFF" in "AUDIO SETUP" (page 63) the DTS track selection option will not appear on the screen even if the disc contains DTS tracks.

**TV Virtual Surround Settings (TVS) DVD-V**

When you connect a stereo TV or 2 front speakers, TVS (TV Virtual Surround) lets you enjoy surround sound effects by using sound imaging to create virtual rear speakers from the sound of the front speakers (L: left, R: right) without using actual rear speakers. TVS was developed by Sony to produce surround sound for home use using just a stereo TV.

This only works when playing a multichannel Dolby audio sound track. Furthermore, if the player is set up to output the signal from the DIGITAL OUT (COAXIAL) jack, the surround effect will only be heard when "DOLBY DIGITAL" is set to "D-PCM" in "AUDIO SETUP" (page 63).

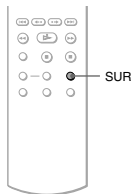

**1 Press SUR during playback.**

The following display appears.

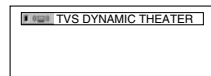

**2 Press SUR repeatedly to select one of the TVS sounds.**

See the explanations given for each item in the following section.

- TVS DYNAMIC THEATER
- TVS DYNAMIC
- TVS WIDE
- TVS NIGHT
- TVS STANDARD

**To cancel the setting**

Select "OFF" in step 2.

**◆ TVS DYNAMIC THEATER**

Creates one set of LARGE virtual rear speakers and virtual subwoofer from the sound of the front speakers (L, R) without using actual rear speakers and subwoofer (shown below). This mode is effective when the distance between the front L and R speakers is short, such as with built-in speakers on a stereo TV.



**◆ TVS DYNAMIC**

Creates one set of virtual rear speakers from the sound of the front speakers (L, R) without using actual rear speakers (shown below). This mode is effective when the distance between the front L and R speakers is short, such as with built-in speakers on a stereo TV.

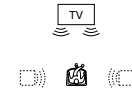

**◆ TVS WIDE**

Creates five sets of virtual rear speakers from the sound of the front speakers (L, R) without using actual rear speakers (shown below). This mode is effective when the distance between the front L and R speakers is short, such as with built-in speakers on a stereo TV.

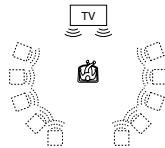

**◆ TVS NIGHT**

Large sounds, such as explosions, are suppressed, but the quieter sounds are unaffected. This feature is useful when you want to hear the dialog and enjoy the surround sound effects of "TVS WIDE" at low volume.

**◆ TVS STANDARD**

Creates three sets of virtual rear speakers from the sound of the front speakers (L, R) without using actual rear speakers (shown below). Use this setting when you want to use TVS with 2 separate speakers.

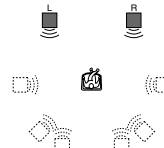

- L: Front speaker (left)
- R: Front speaker (right)
- : Virtual speaker

**Notes**

- When the playing signal does not contain a signal for the rear speakers, the surround effects cannot be heard.
- When you select one of the TVS modes, turn off the surround setting of the connected TV or amplifier (receiver).
- Make sure that your listening position is between and at an equal distance from your speakers, and that the speakers are located in similar surroundings.
- Not all discs will respond to the "TVS NIGHT" function in the same way.
- The TVS effects do not work when using the Fast Play or Slow Play functions, even though you can change the TVS modes.

Sound Adjustments

Enjoying Movies

### Changing the Angles

DVD-V

If various angles (multi-angles) for a scene are recorded on the DVD VIDEO, "ANGLE" appears in the front panel display. This means that you can change the viewing angle.

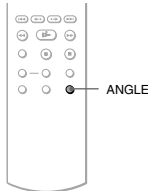

**1 Press ANGLE during playback.**

The number of the angle appears on the display.

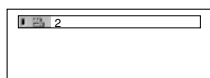

**2 Press ANGLE repeatedly to select an angle number.**

The scene changes to the selected angle.

**Note**

Depending on the DVD VIDEO, you may not be able to change the angles even if multi-angles are recorded on the DVD VIDEO.

### Displaying the Subtitles

DVD-V DVD-RW

If subtitles are recorded on the discs, you can change the subtitles or turn them on and off whenever you want while playing a DVD.

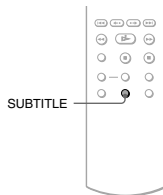

**1 Press SUBTITLE during playback.**

The following display appears.

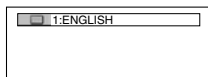

**2 Press SUBTITLE repeatedly to select a setting.**

- ◆ **When playing a DVD VIDEO**  
Select the language.  
Depending on the DVD VIDEO, the choice of language varies.  
When 4 digits are displayed, they indicate a language code. See "Language Code List" on page 70 to see which language the code represents.
- ◆ **When playing a DVD-RW**  
Select "ON."

**To turn off the subtitles**  
Select "OFF" in step 2.

**Notes**

- Depending on the DVD VIDEO, you may not be able to change the subtitles even if multilingual subtitles are recorded on it. You also may not be able to turn them off.
- While playing a disc with subtitles, the subtitle may disappear when you press FAST PLAY or SLOW PLAY button.

### Adjusting the Playback Picture (CUSTOM PICTURE MODE)

DVD-V DVD-RW VCD DATA CD DATA DVD

You can adjust the video signal of the DVD, VIDEO CD or DATA CD/DATA DVD in JPEG format from the player to obtain the picture quality you want. Choose the setting that best suits the program you are watching. When you select "MEMORY," you can make further adjustments to each element of the picture (color, brightness, etc.).

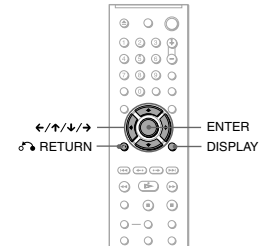

**1 Press DISPLAY during playback. (When playing a DATA CD/DATA DVD, press twice)**

The Control Menu appears.

**2 Press ←/→ to select [CUSTOM PICTURE MODE], then press ENTER.**

The options for "CUSTOM PICTURE MODE" appear.

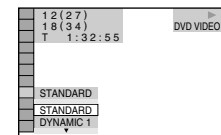

**4 Press ENTER.**

The selected setting takes effect.

**To cancel the "SHARPNESS" setting**  
Select "OFF" in step 3.

**Note**

This setting is not effective if you connect the player via the LINE OUT (VIDEO) or S VIDEO OUT jack and select "PROGRESSIVE AUTO" or "PROGRESSIVE VIDEO" by using the PROGRESSIVE button on the front panel.

**3 Press ←/→ to select the setting you want.**

- The default setting is underlined.
- **STANDARD:** displays a standard picture.
- **DYNAMIC 1:** produces a bold dynamic picture by increasing the picture contrast and the color intensity.
- **DYNAMIC 2:** produces a more dynamic picture than DYNAMIC 1 by further increasing the picture contrast and color intensity.
- **CINEMA 1:** enhances details in dark areas by increasing the black level.
- **CINEMA 2:** white colors become brighter and black colors become richer, and the color contrast is increased.
- **MEMORY:** adjusts the picture in greater detail.

**4 Press ENTER.**

The selected setting takes effect.

**Hint**

When you watch a movie, "CINEMA 1" or "CINEMA 2" is recommended.

### Adjusting the picture items in "MEMORY"

You can adjust each element of the picture individually.

- **PICTURE:** changes the contrast
- **BRIGHTNESS:** changes the overall brightness
- **COLOR:** makes the colors deeper or lighter
- **HUE:** changes the color balance

**1 In step 3 of "Adjusting the Playback Picture," select "MEMORY" and press ENTER.**

The "PICTURE" adjustment bar appears.

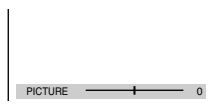

**2 Press ←/→ to adjust the picture contrast.**

To go the next or previous picture item without saving the current setting, press ←/→.

**3 Press ENTER.**

The adjustment is saved, and "BRIGHTNESS" adjustment bar appears.

**4 Repeat step 2 and 3 to adjust "BRIGHTNESS," "COLOR," and "HUE."**

**To turn off the display**

Press RETURN, or DISPLAY.

**Note**

The "BRIGHTNESS" setting is not effective if you connect the player via the LINE OUT (VIDEO) or S VIDEO OUT jack and select "PROGRESSIVE AUTO" or "PROGRESSIVE VIDEO" by using the PROGRESSIVE button on the front panel.

### Sharpening the Pictures (SHARPNESS)

DVD-V DVD-RW VCD DATA CD DATA DVD

You can enhance the outlines of images to produce a sharper picture.

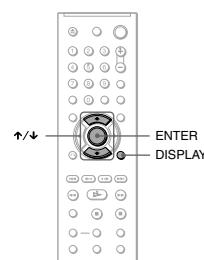

**1 Press DISPLAY during playback (when playing a DATA CD/DATA DVD, press twice).**

The Control Menu appears.

**2 Press ←/→ to select [SHARPNESS], then press ENTER.**

The options for "SHARPNESS" appear.

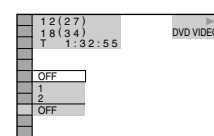

**3 Press ←/→ to select a level.**

- 1: enhances the outline.
- 2: enhances the outline more than 1.

Enjoying MP3 Audio and JPEG Images

About MP3 Audio Tracks and JPEG Image Files

MP3 is audio compression technology that satisfies the ISO/IEC MPEG regulations. JPEG is image compression technology. You can play DATA CDs/DATA DVDs that contain MP3 audio tracks or JPEG image files.

DATA CDs/DATA DVDs that the player can play

You can play back DATA CDs (CD-ROMs/CD-Rs/CD-RWs) or DATA DVDs (DVD-ROMs/DVD+RWs/DVD-Rs/DVD-RWs/DVD-Rs) recorded in MP3 (MPEG-1 Audio Layer III) and JPEG format. However, this player only plays DATA CDs whose logical format is ISO 9660 Level 1/Level 2 or Joliet, and DATA DVDs of Universal Disk Format (UDF). Refer to the instructions supplied with the disc drives and the recording software (not supplied) for details on the recording format.

Note

The player may not be able to play some DATA CDs/DATA DVDs created in the Packet Write format.

MP3 audio track or JPEG image file that the player can play

The player can play the following tracks and files:

- MP3 audio tracks with the extension ".MP3."
- JPEG image files with the extension ".JPEG" or ".JPG."
- JPEG image files that conform to the DCF\* image file format.

\* "Design rule for Camera File system". Image standards for digital cameras regulated by JEITA (Japan Electronics and Information Technology Industries Association).

Notes

- The player will play any data with the extension ".MP3," ".JPG," or ".JPEG," even if they are not in MP3 or JPEG format. Playing these data may generate a loud noise which could damage your speaker system.
- The player does not conform to audio tracks in mp3PRO format.
- Some JPEG files cannot be played.

About playback order of albums, tracks, and files

Albums play in the following order:

Structure of disc contents

Tree 1 Tree 2 Tree 3 Tree 4 Tree 5

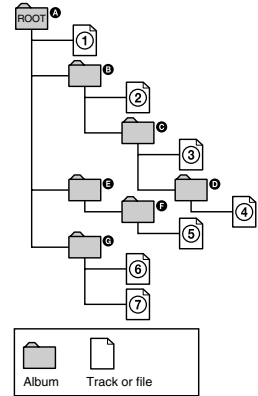

When you insert a DATA CD/DATA DVD and press  $\triangleright$ , the numbered tracks (or files) are played sequentially, from ① through ⑦. Any sub-albums/tracks (or files) contained within a currently selected album take priority over the next album in the same tree. (Example: ② contains ① so ① is played before ②.)

When you press MENU and the list of album names appears (page 50), the album names are arranged in the following order: ① → ② → ③ → ④ → ⑤ → ⑥ → ⑦. Albums that do not contain tracks (or files) (such as album ⑥) do not appear in the list.

Hints

- If you add numbers (01, 02, 03, etc.) to the front of the track/file names when you store the tracks (or files) in a disc, the tracks and files will be played in that order.
- Since a disc with many trees takes longer to start playback, it is recommended that you create albums with no more than two trees.

Notes

- Depending on the software you use to create the DATA CD/DATA DVD, the playback order may differ from the above illustration.
- The playback order above may not be applicable if there are more than 200 albums and 300 tracks/files in each album.
- The player can recognize up to 200 albums (the player will count just albums, including albums that do not contain MP3 audio tracks and JPEG image files) beyond the 200th album.
- Proceeding to the next or another album may take some time.

Playing MP3 Audio Tracks or JPEG Image Files DATA CD DATA DVD

You can play MP3 audio tracks and JPEG image files on DATA CDs (CD-ROMs/CD-Rs/CD-RWs) or DATA DVDs (DVD-ROMs/DVD+RWs/DVD-Rs/DVD-RWs/DVD-Rs).

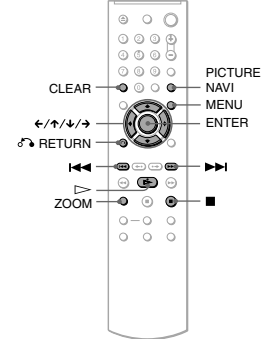

Hint

You can view the disc information while playing MP3 audio tracks (page 38).

Notes

- DATA CDs recorded in KODAK Picture CD format automatically start playing when inserted.
- If no MP3 audio track or JPEG image file is recorded on the DATA CD/DATA DVD, "No audio data" or "No image data" appears on the screen.

Enjoying MP3 Audio and JPEG Images

Selecting an album

1 Press MENU.

The list of albums on the disc appears. When an album is being played, its title is shaded.



2 Press  $\uparrow/\downarrow$  to select the album you want to play.

- 3 Press  $\triangleright$ . Playback starts from the selected album. To select MP3 audio tracks, see "Selecting an MP3 audio track" (page 50). To select JPEG image files, see "Selecting a JPEG image file" (page 51).

To stop playback

Press ■.

To go to the next or previous page

Press  $\rightarrow$  or  $\leftarrow$ .

To turn on or off the display

Press MENU repeatedly.

Hint

Of the selected album, you can select to play only the MP3 audio tracks, JPEG image files, or both, by setting "MODE (MP3, JPEG)" (page 52).

Selecting an MP3 audio track

1 After step 2 of "Selecting an album," press ENTER.

The list of tracks in the album appears.

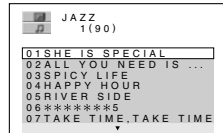

2 Press  $\uparrow/\downarrow$  to select a track, and press ENTER.

Playback starts from the selected track.

To stop playback

Press ■.

To go to the next or previous page

Press  $\rightarrow$  or  $\leftarrow$ .

To return to the previous display

Press  $\hookrightarrow$  RETURN.

To go to the next or previous MP3 audio track

Press  $\triangleright$  or  $\triangleleft$  during playback. You can select the first track of the next album by pressing  $\triangleright$  during playback of the last track of the current album.

Note that you cannot return to the previous album by using  $\triangleleft$ , and that you need to select the previous album from the album list.

Selecting a JPEG image file

1 After step 2 of "Selecting an album," press PICTURE NAVI.

The image files in the album appear in 16 subscreens. A scroll box is displayed on the right.

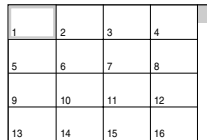

To display the additional image, select the bottom images and press  $\downarrow$ . To return to the previous image, select the top images and press  $\uparrow$ .

2 Press  $\leftarrow/\rightarrow$  to select the image you want to view, and press ENTER.

The selected image appears. Example

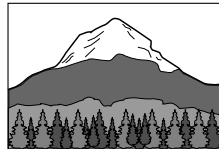

To go to the next or previous JPEG image file

Press  $\leftarrow$  or  $\rightarrow$  during playback. You can select the first file of the next album by pressing  $\rightarrow$  during playback of the last file of the current album.

Note that you cannot return to the previous album by using  $\leftarrow$ , and that you need to select the previous album from the album list.

To rotate a JPEG image

Press  $\uparrow/\downarrow$  while viewing the image. Each time you press  $\uparrow$ , the image rotates counterclockwise by 90 degrees.

To return to normal view, press CLEAR. Note that the view also returns to normal if you press  $\leftarrow/\rightarrow$  to go to the next or previous image.

Example: when  $\uparrow$  is pressed once.

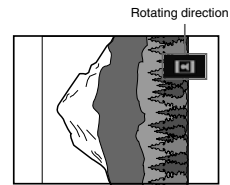

To magnify a JPEG image (ZOOM)

Press ZOOM while viewing the image. You can enlarge the image up to four times the original size, and scroll using  $\leftarrow/\rightarrow/\uparrow/\downarrow$ . To return to normal view, press CLEAR.

◆When pressed once (x2)

The image enlarges twice the original size.

◆When pressed twice (x4)

The image enlarges four times the original size.

To stop viewing the JPEG image

Press ■.

Hints

- While viewing JPEG image files, you can set options such as "INTERVAL" (page 53), "EFFECT" (page 53), and "SHARPNESS" (page 47).
- You can view JPEG images files without MP3 audio by setting "MODE (MP3, JPEG)" to "IMAGE (JPEG)" (page 52).
- The date the picture was taken is displayed beside "DATE" in the Control Menu (page 13). Note that no date may appear depending on the digital camera.

Note

PICTURE NAVI does not work if "AUDIO (MP3)" is selected in "MODE (MP3, JPEG)" (page 52).

Enjoying MP3 Audio and JPEG Images



## Enjoying JPEG Images as a Slide Show

DATA CD DATA DVD

You can play JPEG image files on a DATA CD or DATA DVD successively as a slide show.

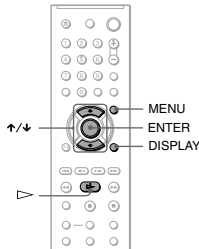

- Press MENU.**  
The list of albums on the DATA CD/ DATA DVD appears.
- 
- Press  $\uparrow/\downarrow$  to select an album.**
  - Press  $\triangleright$ .**  
The JPEG images in the selected album start playing as a slide show.

To stop playback Press  $\blacksquare$ .

### Notes

- The slide show stops when  $\uparrow/\downarrow$  or ZOOM is pressed. To resume the slide show, press  $\triangleright$ .
- This function does not work if "MODE (MP3, JPEG)" is set to "AUDIO (MP3)" (page 52).

## Viewing a slide show with sound (MODE (MP3, JPEG))

When JPEG image files and MP3 audio tracks are placed in the same album, you can enjoy a slide show with sound.

- Press DISPLAY during stop mode.**  
The Control Menu appears.
  - Press  $\uparrow/\downarrow$  to select  $\text{MODE}$  (MODE (MP3, JPEG)), and press ENTER.**  
The options for "MODE (MP3, JPEG)" appear.
- 
- Press  $\uparrow/\downarrow$  to select "AUTO" (default), and press ENTER.**
    - AUTO: plays both the JPEG image files and MP3 audio tracks in the same album as a slide show.
    - AUDIO (MP3): plays only MP3 audio tracks continuously.
    - IMAGE (JPEG): plays only JPEG image files continuously.
  - Press MENU.**  
The list of albums on the DATA CD/ DATA DVD appears.
- 
- Press  $\uparrow/\downarrow$  to select the album that contains both the MP3 audio tracks and JPEG images you want to play.**
  - Press  $\triangleright$ .**  
A slide show starts with sound.

### Hints

- To repeat both MP3 audio tracks and JPEG image files in a single album, repeat the same MP3 audio track or album when "MODE (MP3, JPEG)" is set to "AUTO." See "Playing repeatedly (Repeat Play)" (page 32) to repeat the track or album.
- The player recognizes a maximum of 200 albums regardless of the selected mode. Of each album, the player recognizes up to 300 MP3 audio tracks and 300 JPEG image files when "AUTO" is selected, 600 MP3 audio tracks when "AUDIO (MP3)" is selected, 600 JPEG image files when "IMAGE (JPEG)" is selected.

### Notes

- This function does not work if the MP3 audio tracks and JPEG image files are not placed in the same album.
- If playing time of JPEG image or MP3 audio is longer than the other, the longer one continues without sound or image.
- If you play large MP3 track data and JPEG image data at the same time, the sound may skip. It is recommended that you set the MP3 bit rate to 128 kbps or lower when creating the file. If the sound still skips, then reduce the size of the JPEG file.

## Setting the pace for a slide show (INTERVAL)

You can set the time the slides are displayed on the screen.

- Press DISPLAY twice while viewing a JPEG image or when the player is in stop mode.**  
The Control Menu appears.
  - Press  $\uparrow/\downarrow$  to select  $\text{INTERVAL}$  (INTERVAL), then press ENTER.**  
The options for "INTERVAL" appear.
- 
- Press  $\uparrow/\downarrow$  to select a setting.**  
The default setting is underlined.
    - NORMAL: sets the duration to between 6 to 9 seconds.
    - FAST: sets a duration shorter than NORMAL.
  - Press  $\uparrow/\downarrow$  to select a setting.**  
The default setting is underlined.
    - NORMAL: sets the duration to between 6 to 9 seconds.
    - FAST: sets a duration shorter than NORMAL.

- SLOW 1: sets a duration longer than NORMAL.
- SLOW 2: sets a duration longer than SLOW 1.

## 4 Press ENTER.

### Note

Some JPEG files, especially progressive JPEG files or JPEG files of 3,000,000 pixels or more, may take longer to display than others, which may make the duration seem longer than the setting you selected.

## Selecting the slides' appearance (EFFECT)

You can select the way the slides are displayed during a slide show.

- Press DISPLAY twice while viewing a JPEG image or when the player is in stop mode.**
  - Press  $\uparrow/\downarrow$  to select  $\text{EFFECT}$  (EFFECT), then press ENTER.**  
The options for "EFFECT" appear.
- 
- Press  $\uparrow/\downarrow$  to select a setting.**  
The default setting is underlined.
    - MODE 1: the image sweeps in from top to bottom.
    - MODE 2: the image sweeps in from left to right.
    - MODE 3: the image stretches out from the center of the screen.
    - MODE 4: the images randomly cycle through the effects.
    - MODE 5: the next image slides over the previous image.
    - OFF: turns off this function.
  - Press ENTER.**

## Using Various Additional Functions

### Locking Discs (CUSTOM PARENTAL CONTROL, PARENTAL CONTROL)

You can set two kinds of playback restrictions for a disc.

- Custom Parental Control  
You can set playback restrictions so that the player will not play inappropriate discs.
- Parental Control  
Playback of some DVD VIDEOS can be limited according to a predetermined level such as the age of the users. Scenes may be blocked or replaced with different scenes. The same password is used for both Parental Control and Custom Parental Control.

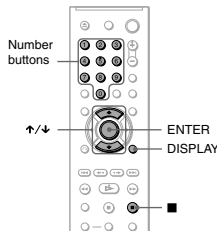

### Custom Parental Control

DVD-V VCD CD

You can set the same Custom Parental Control password for up to 40 discs. When you set the 41st-disc, the first disc is canceled.

- Insert the disc you want to lock.**  
If the disc is playing, press  $\blacksquare$  to stop playback.
- Press DISPLAY while the player is in stop mode.**  
The Control Menu appears.
- Press  $\uparrow/\downarrow$  to select  $\text{PARENTAL CONTROL}$ , then press ENTER.**

The options for "PARENTAL CONTROL" appear.

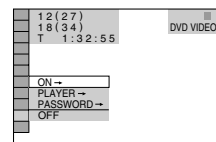

- Press  $\uparrow/\downarrow$  to select "ON  $\rightarrow$ ," then press ENTER.**
    - If you have not entered a password  
The display for registering a new password appears.
    - If you have already registered a password  
The display for entering the password appears.
  - Enter or re-enter your 4-digit password using the number buttons, then press ENTER.**  
"Custom parental control is set." appears and then the screen returns to the Control Menu.
- 

To turn off the Custom Parental Control function

- Follow steps 1 to 3 of "Custom Parental Control."
- Press  $\uparrow/\downarrow$  to select "OFF  $\rightarrow$ ," then press ENTER.
- Enter your 4-digit password using the number buttons, then press ENTER.

To play a disc for which Custom Parental Control is set

- Insert the disc for which Custom Parental Control is set.  
The "CUSTOM PARENTAL CONTROL" display appears.

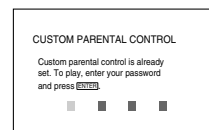

- Enter your 4-digit password using the number buttons, then press ENTER.  
The player is ready for playback.

### Hint

If you forget your password, enter the 6-digit number "199703" using the number buttons when the "CUSTOM PARENTAL CONTROL" display asks you for your password, then press ENTER. The display will ask you to enter a new 4-digit password.

### Parental Control (limited playback) DVD-V

Playback of some DVD VIDEOS can be limited according to a predetermined level such as the age of the users. The "PARENTAL CONTROL" function allows you to set a playback limitation level.

- Press DISPLAY while the player is in stop mode.**  
The Control Menu appears.
- Press  $\uparrow/\downarrow$  to select  $\text{PARENTAL CONTROL}$ , then press ENTER.**  
The options for "PARENTAL CONTROL" appear.

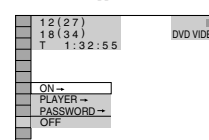

- Press  $\uparrow/\downarrow$  to select "PLAYER  $\rightarrow$ ," then press ENTER.**

If you have not entered a password The display for registering a new password appears.



Enter a 4-digit password using the number buttons, then press ENTER. The display for confirming the password appears.

If you have already registered a password The display for entering the password appears.

- Enter or re-enter your 4-digit password using the number buttons, then press ENTER.**

The display for setting the playback limitation level appears.

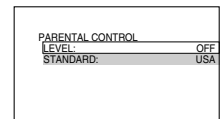

- Press  $\uparrow/\downarrow$  to select "STANDARD," then press ENTER.**  
The selection items for "STANDARD" are displayed.

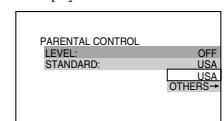

**6** Press  $\uparrow/\downarrow$  to select a geographic area as the playback limitation level, then press ENTER.

The area is selected. When you select "OTHERS  $\rightarrow$ ," select and enter a standard code in the table on page 70 using the number buttons.

**7** Press  $\uparrow/\downarrow$  to select "LEVEL," then press ENTER.

The selection items for "LEVEL" are displayed.

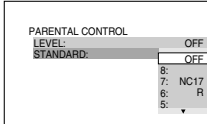

**8** Select the level you want using  $\uparrow/\downarrow$ , then press ENTER.

Parental Control setting is complete.

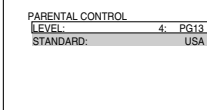

The lower the value, the stricter the limitation.

**To turn off the Parental Control function**  
Set "LEVEL" to "OFF" in step 8.

**To play a disc for which Parental Control is set**

- 1 Insert the disc and press  $\triangleright$ . The display for entering your password appears.
- 2 Enter your 4-digit password using the number buttons, then press ENTER. The player starts playback.

**Hint**

If you forget your password, remove the disc and repeat steps 1 to 3 of "Parental Control (limited playback)." When you are asked to enter your password, enter "199703" using the number buttons, then press ENTER. The display will ask you to enter a new 4-digit password. After you enter a new 4-digit password, replace the disc in the player and press  $\triangleright$ . When the display for entering your password appears, enter your new password.

**Notes**

- When you play discs which do not have the Parental Control function, playback cannot be limited on this player.
- Depending on the disc, you may be asked to change the parental control level while playing the disc. In this case, enter your password, then change the level. If the Resume Play mode is canceled, the level returns to the previous level.

**Changing the password**

- 1 Press DISPLAY while the player is in stop mode. The Control Menu appears.
- 2 Press  $\uparrow/\downarrow$  to select (PARENTAL CONTROL), then press ENTER. The options for "PARENTAL CONTROL" appear.
- 3 Press  $\uparrow/\downarrow$  to select "PASSWORD  $\rightarrow$ ," then press ENTER. The display for entering the password appears.
- 4 Enter your 4-digit password using the number buttons, then press ENTER.
- 5 Enter a new 4-digit password using the number buttons, then press ENTER.
- 6 To confirm your password, re-enter it using the number buttons, then press ENTER.

**If you make a mistake entering your password**

Press  $\leftarrow$  before you press ENTER and input the correct number.

**Controlling Your TV with the Supplied Remote**

You can control the sound level, input source, and power switch of your Sony TV with the supplied remote.

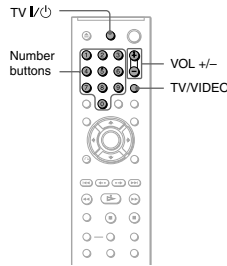

You can control your TV using the buttons below.

By pressing	You can
TV I/O	Turn the TV on or off
VOL +/-	Adjust the volume of the TV
TV/VIDEO	Switch the TV's input source between the TV and other input sources.

**Note**

Depending on the connected unit, you may not be able to control your TV using all or some of the buttons on the supplied remote.

**Controlling other TVs with the remote**

You can control the sound level, input source, and power switch of non-Sony TVs as well. If your TV is listed in the table below, set the appropriate manufacturer's code.

**1** While holding down TV I/O, press the number buttons to select your TV's manufacturer's code (see the table below).

**2** Release TV I/O.

**Code numbers of controllable TVs**

If more than one code number is listed, try entering them one at a time until you find the one that works with your TV.

Manufacturer	Code number
Sony	01 (default)
Daewoo	04, 22
Hitachi	02, 04
JVC	09
LG/Goldstar	04
MGA/Mitsubishi	04, 13
Panasonic	19
Philips	21
RCA	04, 10
Samsung	04, 20
Sharp	18
Toshiba	07, 18

**Notes**

- When you replace the batteries of the remote, the code number you have set may be reset to the default setting. Set the appropriate code number again.
- Depending on the connected unit, you may not be able to control your TV using all or some of the buttons on the supplied remote.

Using Various Additional Functions

**Settings and Adjustments**

**Using the Setup Display**

By using the Setup Display, you can make various adjustments to items such as picture and sound. You can also set a language for the subtitles and the Setup Display, among other things.

For details on each Setup Display item, see pages from 59 to 63.

**Note**

Playback settings stored in the disc take priority over the Setup Display settings and not all of the functions described may work.

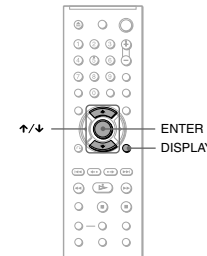

**1** Press DISPLAY when the player is in stop mode.

The Control Menu appears.

**2** Press  $\uparrow/\downarrow$  to select (SETUP), then press ENTER.

The options for "SETUP" appear.

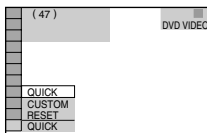

**3** Press  $\uparrow/\downarrow$  to select "CUSTOM," then press ENTER.

The Setup Display appears.

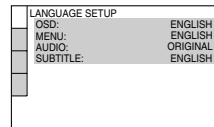

**4** Press  $\uparrow/\downarrow$  to select the setup item from the displayed list:

"LANGUAGE SETUP," "SCREEN SETUP," "CUSTOM SETUP," or "AUDIO SETUP." Then press ENTER.

The Setup item is selected. Example: "SCREEN SETUP"

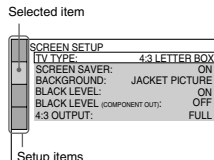

**5** Press  $\uparrow/\downarrow$  to select an item, then press ENTER.

The options for the selected item appear. Example: "TV TYPE"

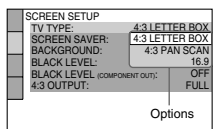

**6** Press  $\uparrow/\downarrow$  to select a setting, then press ENTER.

The setting is selected and setup is complete. Example: "16:9"

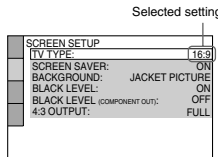

**To enter the Quick Setup mode**

Select "QUICK" in step 3. Follow from step 5 of the Quick Setup explanation to make basic adjustments (page 22).

**To reset all of the "SETUP" settings**

- 1 Select "RESET" in step 3 and press ENTER.
- 2 Select "YES" using  $\uparrow/\downarrow$ . You can also quit the process and return to the Control Menu by selecting "NO" here.
- 3 Press ENTER. All the settings explained on pages 59 to 63 return to the default settings. Do not press I/O while resetting the player, which takes a few seconds to complete.

**Setting the Display or Sound Track Language (LANGUAGE SETUP)**

"LANGUAGE SETUP" allows you to set various languages for the on-screen display or sound track.

Select "LANGUAGE SETUP" in the Setup Display. To use the display, see "Using the Setup Display" (page 58).

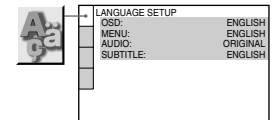

**◆ OSD (On-Screen Display)**

Switches the display language on the screen.

**◆ MENU (DVD VIDEO only)**

You can select the desired language for the disc's menu.

**◆ AUDIO (DVD VIDEO only)**

Switches the language of the sound track. When you select "ORIGINAL," the language given priority in the disc is selected.

**◆ SUBTITLE (DVD VIDEO only)**

Switches the language of the subtitle recorded on the DVD VIDEO. When you select "AUDIO FOLLOW," the language for the subtitles changes according to the language you selected for the sound track.

**Hint**

If you select "OTHERS  $\rightarrow$ " in "MENU," "SUBTITLE," or "AUDIO," select and enter a language code from "Language Code List" on page 70 using the number buttons.

**Note**

If you select a language in "MENU," "SUBTITLE," or "AUDIO" that is not recorded on a DVD VIDEO, one of the recorded languages will be automatically selected.

Settings and Adjustments

## Settings for the Display (SCREEN SETUP)

Choose settings according to the TV to be connected.

Select "SCREEN SETUP" in the Setup Display. To use the display, see "Using the Setup Display" (page 58). The default settings are underlined.

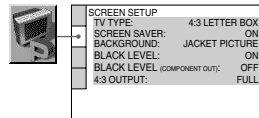

### ◆ TV TYPE

Selects the aspect ratio of the connected TV (4:3 standard or wide).

4:3 LETTER BOX	Select this when you connect a 4:3 screen TV. Displays a wide picture with bands on the upper and lower portions of the screen.
4:3 PAN SCAN	Select this when you connect a 4:3 screen TV. Automatically displays the wide picture on the entire screen and cuts off the portions that do not fit.
16:9	Select this when you connect a wide-screen TV or a TV with a wide mode function.

4:3 LETTER BOX



4:3 PAN SCAN



16:9



### Note

Depending on the DVD, "4:3 LETTER BOX" may be selected automatically instead of "4:3 PAN SCAN" or vice versa.

### ◆ SCREEN SAVER

The screen saver image appears when you leave the player in pause or stop mode for 15 minutes, or when you play a CD, or DATA CD/DATA DVD (MP3 audio) for more than 15 minutes. The screen saver will help prevent your display device from becoming damaged (ghosting). Press  $\triangleright$  to turn off the screen saver.

ON	Turns on the screen saver.
OFF	Turns off the screen saver.

### ◆ BACKGROUND

Selects the background color or picture on the TV screen when the player is in stop mode or while playing a CD, or DATA CD/DATA DVD (MP3 audio).

JACKET PICTURE	The jacket picture (still picture) appears, but only when the jacket picture is already recorded on the disc (CD-EXTRA, etc.). If the disc does not contain a jacket picture, the "GRAPHICS" picture appears.
GRAPHICS	A preset picture stored in the player appears.
BLUE	The background color is blue.
BLACK	The background color is black.

### ◆ BLACK LEVEL

Selects the black level (setup level) for the video signals output from the jacks other than COMPONENT VIDEO OUT.

ON	Sets the black level of the output signal to the standard level.
OFF	Lowers the standard black level. Use this when the picture becomes too white.

## Additional Information

### Troubleshooting

If you experience any of the following difficulties while using the player, use this troubleshooting guide to help remedy the problem before requesting repairs. Should any problem persist, consult your nearest Sony dealer (For customers in the USA only).

#### Power

**The power is not turned on.**

- Check that the power cord is connected securely.

#### Picture

**There is no picture/picture noise appears.**

- Re-connect the connecting cord securely.
- The connecting cords are damaged.
- Check the connection to your TV (page 17) and switch the input selector on your TV so that the signal from the player appears on the TV screen.
- The disc is dirty or flawed.
- If the picture output from your player goes through your VCR to get to your TV or if you are connected to a combination TV/VIDEO player, the copy-protection signal applied to some DVD programs could affect picture quality. If you still experience problems even when you connect your player directly to your TV, try connecting your player to your TV's S VIDEO input (page 17).
- You have selected "PROGRESSIVE AUTO" or "PROGRESSIVE VIDEO" using the PROGRESSIVE button on the front panel (the PROGRESSIVE indicator lights up) even though your TV cannot accept the progressive signal. In this case, select "NORMAL (INTERLACE)" so that the PROGRESSIVE indicator turns off.

- Even if your TV is compatible with progressive format 480p signals, the image may be affected when you set the player to progressive format. In this case, select "NORMAL (INTERLACE)" using the PROGRESSIVE button on the front panel so that the PROGRESSIVE indicator turns off and the player is set to normal (interlace) format.

**The picture does not fill the screen, even though the aspect ratio is set in "TV TYPE" under "SCREEN SETUP."**

- The aspect ratio of the disc is fixed on your DVD.

#### Sound

**There is no sound.**

- Re-connect the connecting cord securely.
- The connecting cord is damaged.
- The player is connected to the wrong input jack on the amplifier (receiver) (page 20).
- The amplifier (receiver) input is not correctly set.
- The player is in pause mode or in Slow-motion Play mode.
- The player is in fast forward or fast reverse mode.
- If the audio signal does not come through the DIGITAL OUT (COAXIAL) jack, check the audio settings (page 63).
- While playing a Super VCD on which the audio track 2 is not recorded, no sound will come out when you select "2:STEREO," "2:1/L," or "2:2/R."

**Sound distortion occurs.**

- Set "AUDIO ATT" in "AUDIO SETUP" to "ON" (page 62).

**The sound volume is low.**

- The sound volume is low on some DVDs. The sound volume may improve if you set "AUDIO DRC" in "AUDIO SETUP" to "TV MODE" (page 62).
- Set "AUDIO ATT" in "AUDIO SETUP" to "OFF" (page 62).

## Operation

**The remote does not function.**

- The batteries in the remote are weak.
- There are obstacles between the remote and the player.
- The distance between the remote and the player is too far.
- The remote is not pointed at the remote sensor on the player.

**The disc does not play.**

- The disc is turned over.
- Insert the disc with the playback side facing down.
- The disc is skewed.
- The player cannot play certain discs (page 8).
- The region code on the DVD does not match the player.
- Moisture has condensed inside the player (page 5).
- The player cannot play a recorded disc that is not correctly finalized (page 9).

**The MP3 audio track cannot be played (page 49).**

- The DATA CD is not recorded in an MP3 format that conforms to ISO 9660 Level 1/Level 2 or Joliet.
- The DATA DVD is not recorded in MP3 format that conforms to UDF (Universal Disk Format).
- The MP3 audio track does not have the extension ".MP3."
- The data is not formatted in MP3 even though it has the extension ".MP3."
- The data is not MPEG-1 Audio Layer III data.
- The player cannot play audio tracks in mp3PRO format.
- "MODE (MP3, JPEG)" is set to "IMAGE (JPEG)" (page 52).

**The JPEG image file cannot be played (page 49).**

- The DATA CD is not recorded in a JPEG format that conforms to ISO 9660 Level 1/Level 2, or Joliet.
- The DATA DVD is not recorded in JPEG format that conforms to UDF (Universal Disk Format).
- The file has an extension other than ".JPEG" or ".JPG."

- The image is larger than 3072 (width) × 2048 (height) in normal mode, or more than 3,300,000 pixels in progressive JPEG. (Some progressive JPEG files cannot be displayed even if the file size is within this specified capacity.)
- The image does not fit the screen (the image is reduced).
- "MODE (MP3, JPEG)" is set to "AUDIO (MP3)" (page 52).

**The MP3 audio tracks and JPEG image files start playing simultaneously.**

- "MODE (MP3, JPEG)" is set to "AUTO" (page 52).

**The album/track/file names are not displayed correctly.**

- The player can only display numbers and alphabet. Other characters are displayed as "?".

**The disc does not start playing from the beginning.**

- Program Play, Shuffle Play, Repeat Play, or A-B Repeat Play is selected (page 29).
- Resume play has taken effect (page 26).

**The player starts playing the disc automatically.**

- The disc features an auto playback function.
- "AUTO PLAY" in "CUSTOM SETUP" is set to "ON" (page 61).

**Playback stops automatically.**

- While playing discs with an auto pause signal, the player stops playback at the auto pause signal.

**Some functions such as Stop, Search, Fast Play, Slow Play, Slow-motion Play, Repeat Play, Shuffle Play, or Program Play cannot be performed.**

- Depending on the disc, you may not be able to do some of the operations above. Refer to the operating manual that comes with the disc.

Additional Information

**The language for the sound track cannot be changed.**

- Try using the DVD's menu instead of the direct selection button on the remote (page 27).
- Multilingual tracks are not recorded on the DVD being played.
- The DVD prohibits the changing of the language for the sound track.

**The subtitle language cannot be changed or turned off.**

- Try using the DVD's menu instead of the direct selection button on the remote (page 27).
- Multilingual subtitles are not recorded on the DVD being played.
- The DVD prohibits the changing of subtitles.

**The angles cannot be changed.**

- Try using the DVD's menu instead of the direct selection button on the remote (page 27).
- Multi-angles are not recorded on the DVD being played.
- The angle can only be changed when the "CO" indicator lights up on the front panel display (page 11).
- The DVD prohibits changing of the angles.

**The player does not operate properly.**

- When static electricity, etc., causes the player to operate abnormally, unplug the player.

**5 numbers or letters are displayed on the screen and on the front panel display.**

- The self-diagnosis function was activated. (See the table on page 67.)

**The disc tray does not open and "LOCKED" appears on the front panel display.**

- Child Lock is set (page 25).

**The disc tray does not open and "TRAY LOCKED" appears on the front panel display.**

- Contact your Sony dealer or local authorized Sony service facility.

**Self-diagnosis Function**

(When letters/numbers appear in the display)

When the self-diagnosis function is activated to prevent the player from malfunctioning, a five-character service number (e.g., C 13 50) with a combination of a letter and four digits appears on the screen and the front panel display. In this case, check the following table.

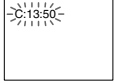

First three characters of the service number	Cause and/or corrective action
C 13	The disc is dirty or recorded in a format that this player cannot play (page 8). ➔ Clean the disc with a soft cloth or check its format (page 2).
C 31	The disc is not inserted correctly. ➔ Re-insert the disc correctly.
E XX (xx is a number)	To prevent a malfunction, the player has performed the self-diagnosis function. ➔ Contact your nearest Sony dealer or local authorized Sony service facility and give the 5-character service number. Example: E 61 10

**Glossary**

**Album (page 48, 50)**

A unit in which to store JPEG image files or MP3 audio tracks on a DATA CD/DATA DVD. ("Album" is an exclusive definition for this player.)

**Chapter (page 11)**

Sections of a picture or a music feature that are smaller than titles. A title is composed of several chapters. Depending on the disc, no chapters may be recorded.

**Dolby Digital (page 21, 63)**

Digital audio compression technology developed by Dolby Laboratories. This technology conforms to multi-channel surround sound. The rear channel is stereo and there is a discrete subwoofer channel in this format. Dolby Digital provides the same discrete channels of high quality digital audio found in "Dolby Digital" theater surround sound systems. Good channel separation is realized because all of the channel data is recorded discretely and little deterioration is realized because all channel data processing is digital.

**DTS (page 21, 63)**

Digital audio compression technology that Digital Theater Systems, Inc. developed. This technology conforms to multi-channel surround sound. The rear channel is stereo and there is a discrete subwoofer channel in this format. DTS provides the same discrete channels of high quality digital audio. Good channel separation is realized because all of the channel data is recorded discretely and little deterioration is realized because all channel data processing is digital.

**DVD VIDEO (page 7)**

A disc that contains up to 8 hours of moving pictures even though its diameter is the same as a CD.

The data capacity of a single-layer and single-sided DVD is 4.7 GB (Giga Byte), which is 7 times that of a CD. The data capacity of a double-layer and single-sided DVD is 8.5 GB, a single-layer and double-sided DVD is 9.4 GB, and double-layer and double-sided DVD is 17 GB.

The picture data uses the MPEG 2 format, a worldwide standard of digital compression technology. The picture data is compressed to about 1/40 (average) of its original size. The DVD also uses a variable rate coding technology that changes the data to be allocated according to the status of the picture. Audio information is recorded in a multi-channel format, such as Dolby Digital, allowing you to enjoy a more realistic audio presence.

Furthermore, various advanced functions such as the multi-angle, multilingual, and Parental Control functions are provided with the DVD.

**DVD-RW (page 7)**

A DVD-RW is a recordable and rewritable disc that is the same size as a DVD VIDEO. The DVD-RW has two different modes: VR mode and Video mode. DVD-RWs created in Video mode have the same format as a DVD VIDEO, while discs created in VR (Video Recording) mode allow the contents to be programmed or edited.

**DVD+RW (page 7)**

A DVD+RW (plus RW) is a recordable and rewritable disc. DVD+RWs use a recording format that is comparable to the DVD VIDEO format.

**File (page 48, 51)**

A JPEG image recorded on a DATA CD/DATA DVD ("File" is an exclusive definition for this player.) A single file consist of a single image.

**Film based software, Video based software (page 19)**

DVDs can be classified as Film based or Video based software. Film based DVDs contain the same images (24 frames per second) that are shown at movie theaters. Video based DVDs, such as television dramas or sit-coms, displays images at 30 frames/60 fields per second.

**Normal (Interlace) format (page 19)**

Normal (Interlace) format shows every other line of an image as a single "field" and is the standard method for displaying images on television. The even number field shows the even numbered lines of an image, and the odd numbered field shows the odd numbered lines of an image.

**Progressive format (page 19)**

Compared to the Interlace format that alternately shows every other line of an image (field) to create one frame, the Progressive format shows the entire image at once as a single frame. This means that while the Interlace format can show 30 frames/60 fields in one second, the Progressive format can show 60 frames in one second. The overall picture quality increases and still images, text, and horizontal lines appear sharper. This player is compatible with the 480 progressive format.

**Progressive JPEG**

Progressive JPEGs are used mostly on the internet. They are different from other JPEGs in that they "fade in" gradually instead of being drawn from top to bottom when displayed on a browser. This lets you view the image while it is being downloaded.

**Title (page 11)**

The longest section of a picture or music feature on a DVD, movie, etc., in video software, or the entire album in audio software.

Additional Information

➔ continued 67

68

**Specifications**

**System**

**Laser:** Semiconductor laser  
**Signal format system:** NTSC

**Audio characteristics**

**Frequency response:** DVD VIDEO (PCM 96 kHz): 2 Hz to 44 kHz (±1.0 dB)/DVD VIDEO (PCM 48 kHz): 2 Hz to 22 kHz (±0.5 dB)/CD: 2 Hz to 20 kHz (±0.5 dB)  
**Signal-to-noise ratio (S/N ratio):** 115 dB (LINE OUT L/R (AUDIO) jacks only)  
**Harmonic distortion:** 0.003 %  
**Dynamic range:** DVD VIDEO: 103 dB/CD: 99 dB  
**Wow and flutter:** Less than detected value (±0.001% W PEAK)

**Outputs**

(**Jack name:** Jack type/Output level/Load impedance)  
**LINE OUT (AUDIO):** Phono jack/2 Vrms/10 kilohms  
**DIGITAL OUT (COAXIAL):** Phono jack/0.5 Vp-p/75 ohms  
**COMPONENT VIDEO OUT(Y, Pb, Pr):** Phono jack/Y: 1.0 Vp-p/Pb, Pr: interlace\*1 = 0.648 Vp-p, progressive or interlace\*2 = 0.7 Vp-p/75 ohms  
\*1 BLACK LEVEL (COMPONENT OUT) is ON  
\*2 BLACK LEVEL (COMPONENT OUT) is OFF  
**LINE OUT (VIDEO):** Phono jack/1.0 Vp-p/75 ohms  
**S VIDEO OUT:** 4-pin mini DIN/Y: 1.0 Vp-p, C: 0.286 Vp-p/75 ohms

**General**

**Power requirements:** U.S./Canadian models: 120 V AC, 60 Hz  
Models for other areas: 110 -240 V AC, 50/60 Hz  
See page 5 for further information.  
**Power consumption:** 10 W  
**Dimensions (approx.):** 430×43×237.2 mm (17×1 11/16×9 3/8 in.) (width/height/depth) incl. projecting parts  
**Mass (approx.):** 1.92 kg (4 1/5 lb)  
**Operating temperature:** 5 °C to 35 °C (41 °F to 95 °F)  
**Operating humidity:** 25 % to 80 %

**Supplied accessories**

See page 16.  
Specifications and design are subject to change without notice.

ENERGY STAR® is a U.S. registered mark. As an ENERGY STAR® Partner, Sony Corporation has determined that this product meets the ENERGY STAR® guidelines for energy efficiency.

Additional Information

## SECTION 2 DISASSEMBLY

**Note:** Follow the disassembly procedure in the numerical order given.

### 2-1. UPPER CASE

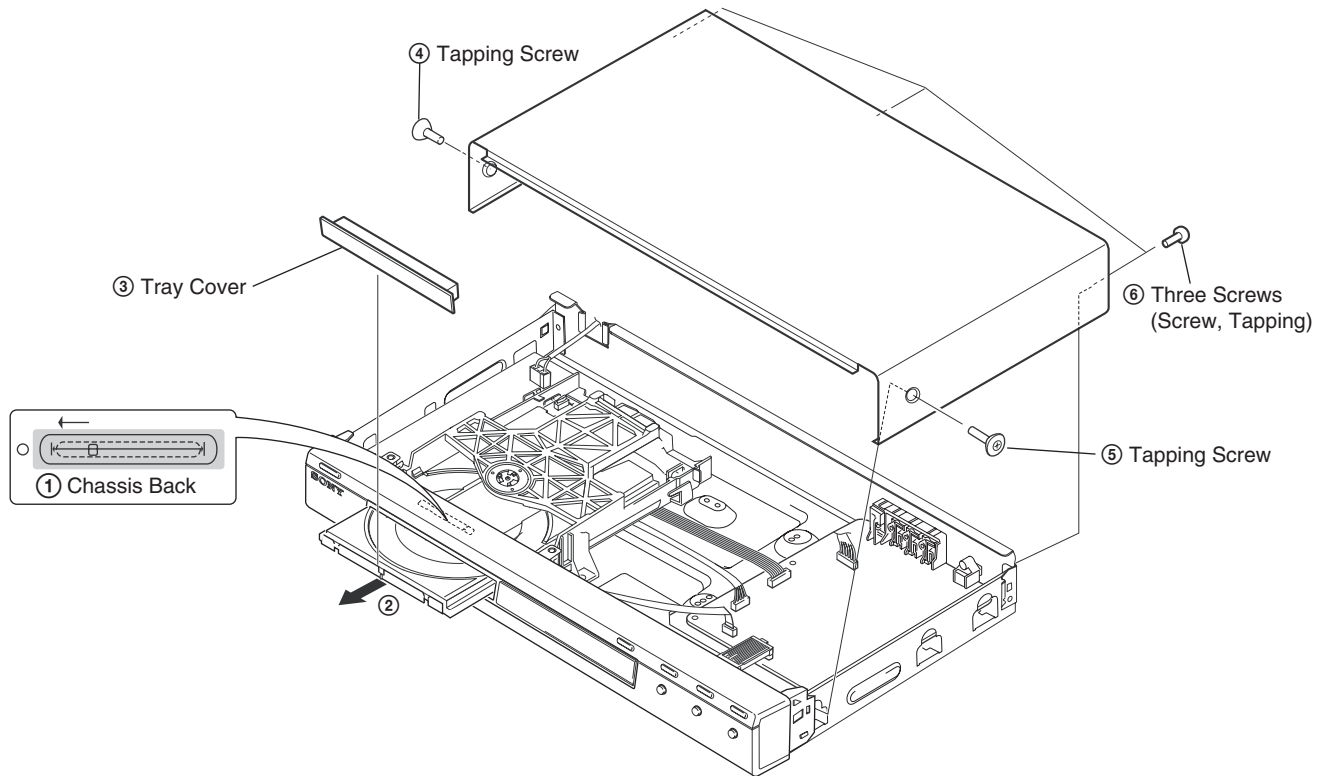

### 2-2. FRONT PANEL ASSEMBLY

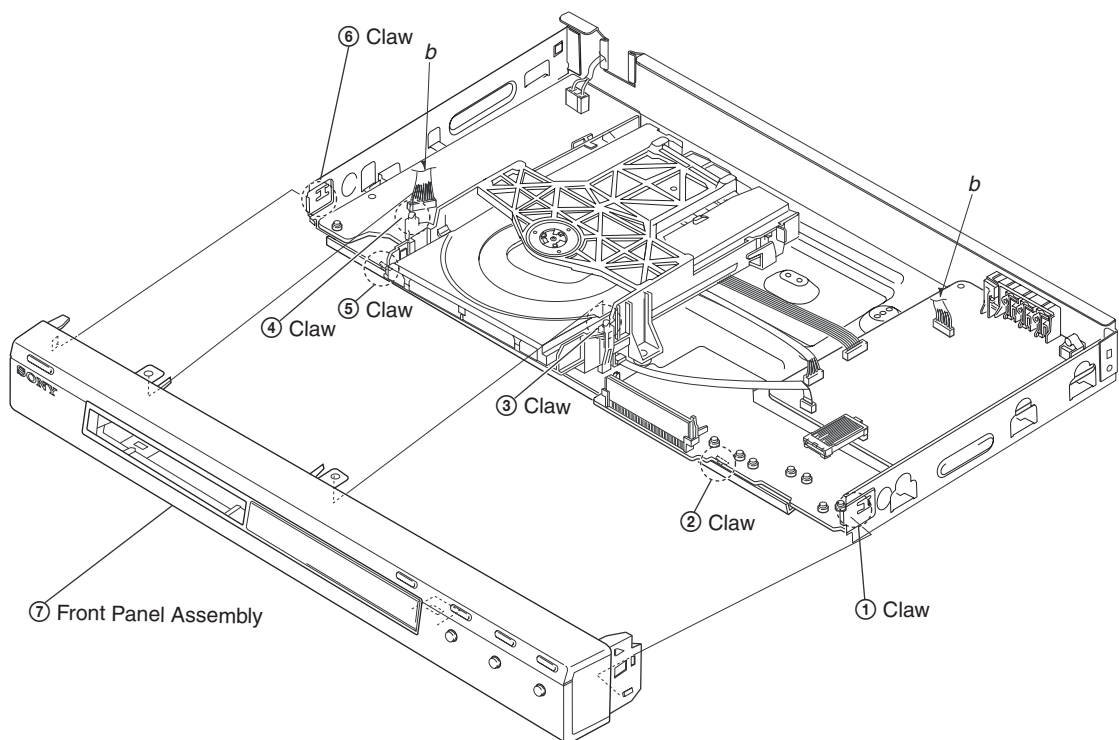

2-3. LOADING ASSEMBLY

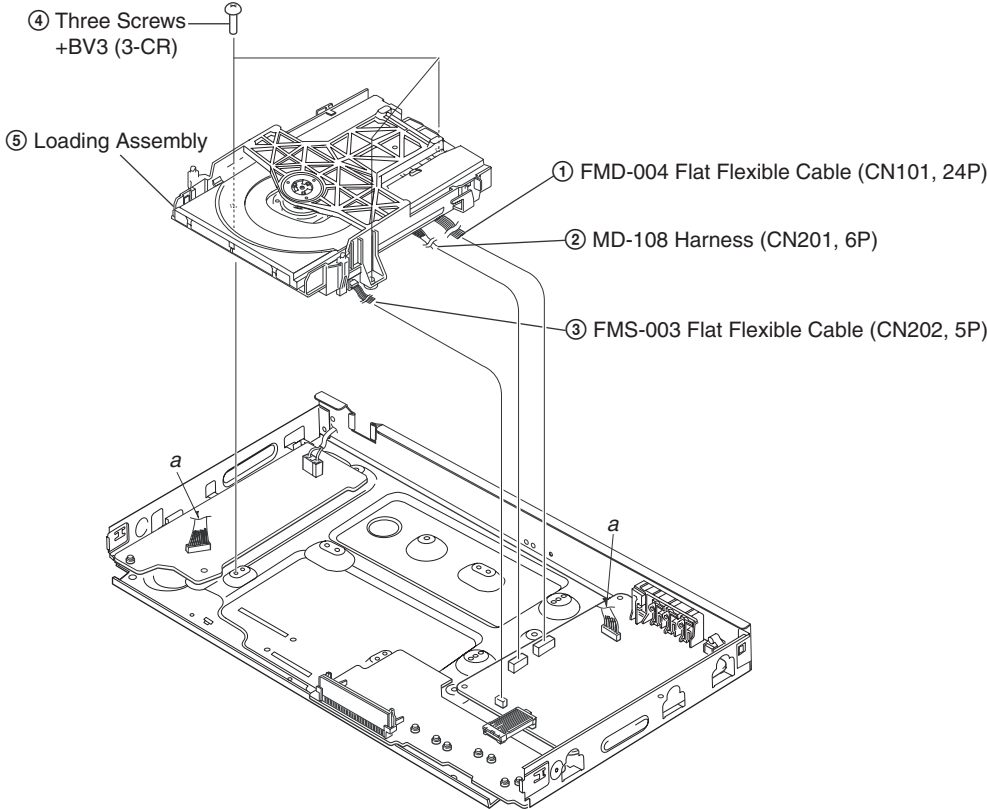

**2-4. OPTICAL PICK-UP  
(DEVICE, OPTICAL KHM-310CAA/C2RP)**

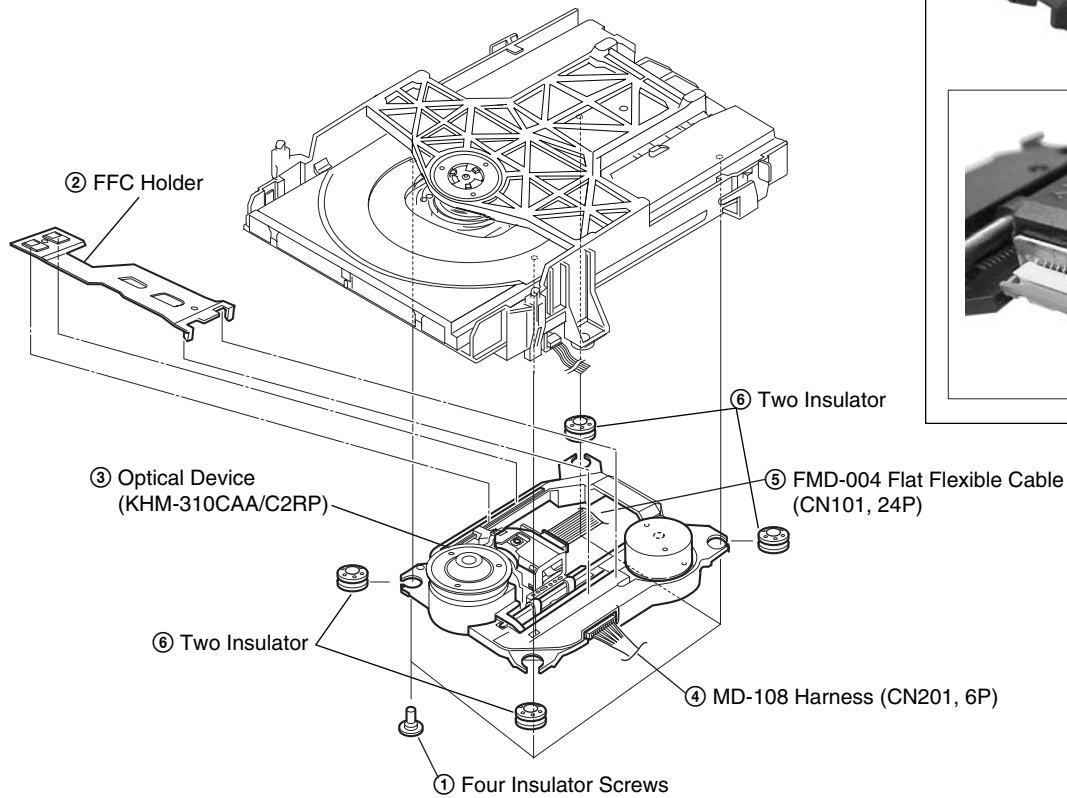

**Note:**

Solder short land before remove the harness from 24 pin BU connector.

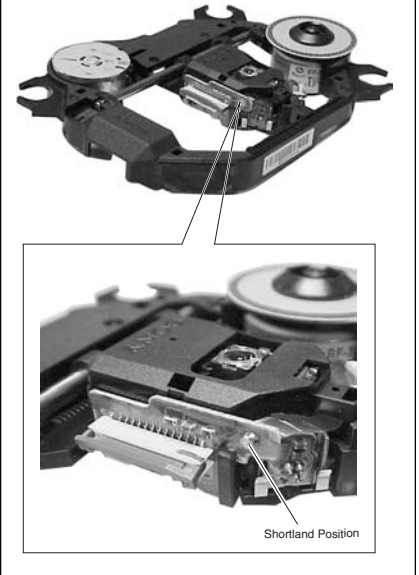

**Caution Point on the Laser Diode:**

Laser Diode in the optical Device is very sensitive to Surge Current or ElectroStatic Discharge (ESD):

After take-out FMD-004 Flexible cable from CN101 of MV-045 board immediately ground FMD-004 Flexible cable pattern using short clip. Metal paper clip can be used as short clip.

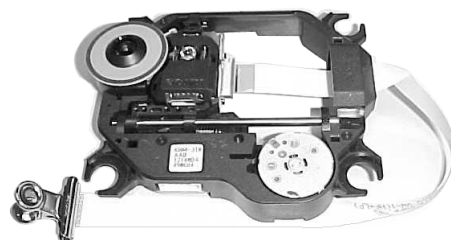

2-5. MV-045 and IF124 BOARDS

**Note:**

**Caution Point on the PWB IF-124**

When handling IF-124 PWB avoid contact with the sharp metal edge on the top side of Vacuum Fluorescent Display (ND401).

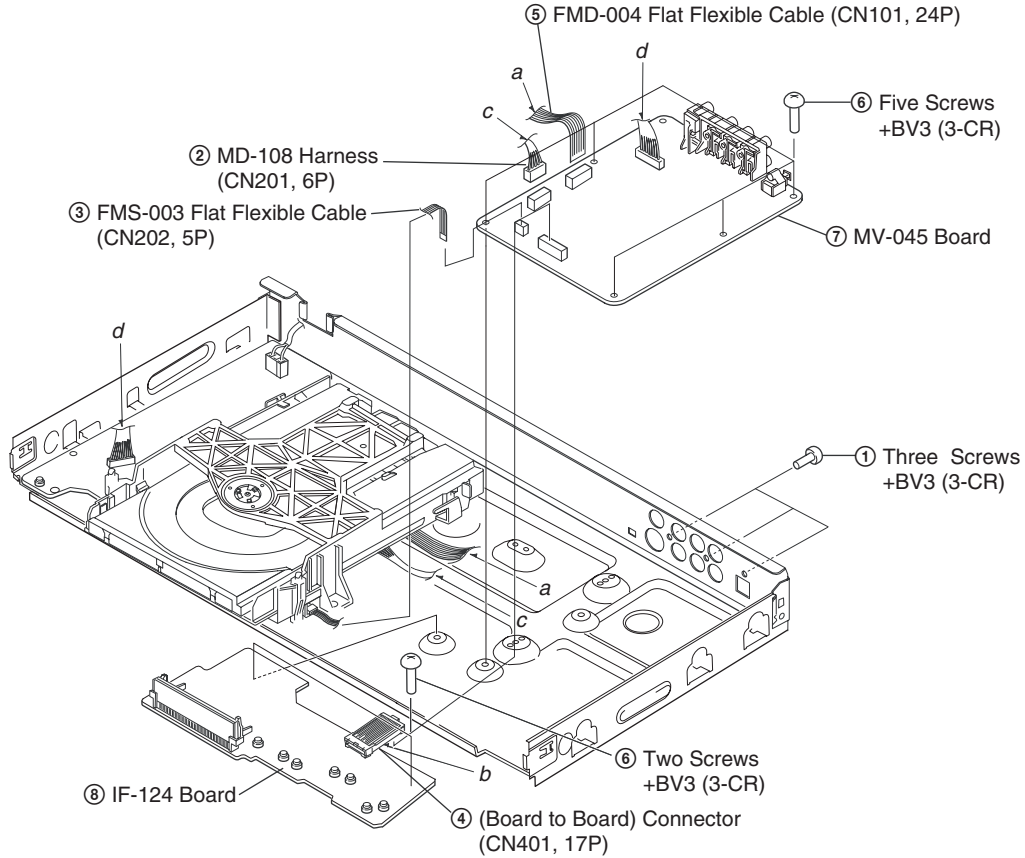

2-6. SWITCHING REGULATOR

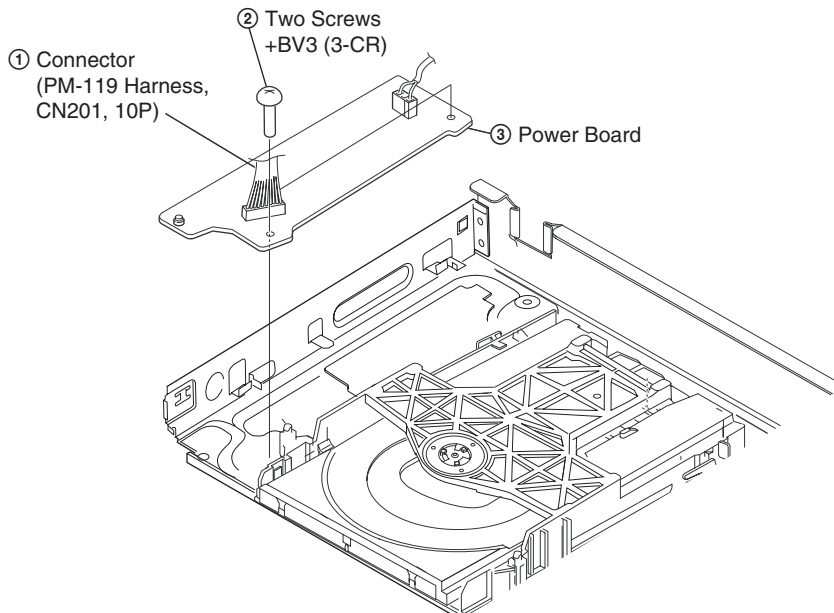



2-7. INTERNAL VIEWS

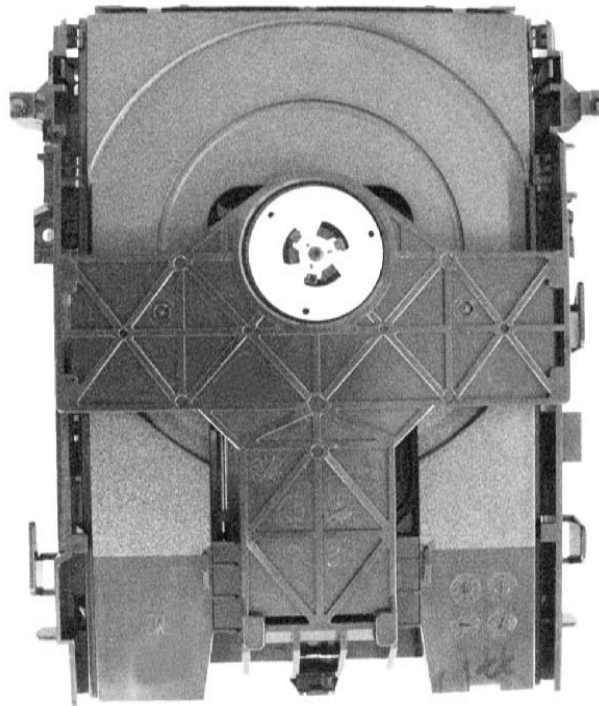

TOP VIEW

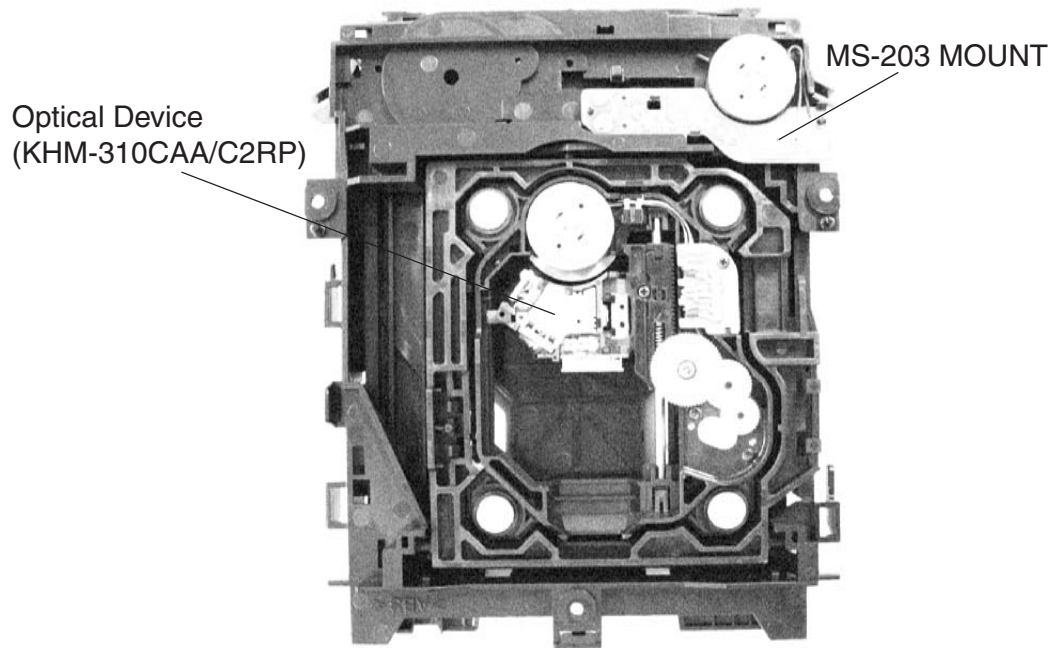

BOTTOM VIEW

2-8. CIRCUIT BOARDS LOCATION

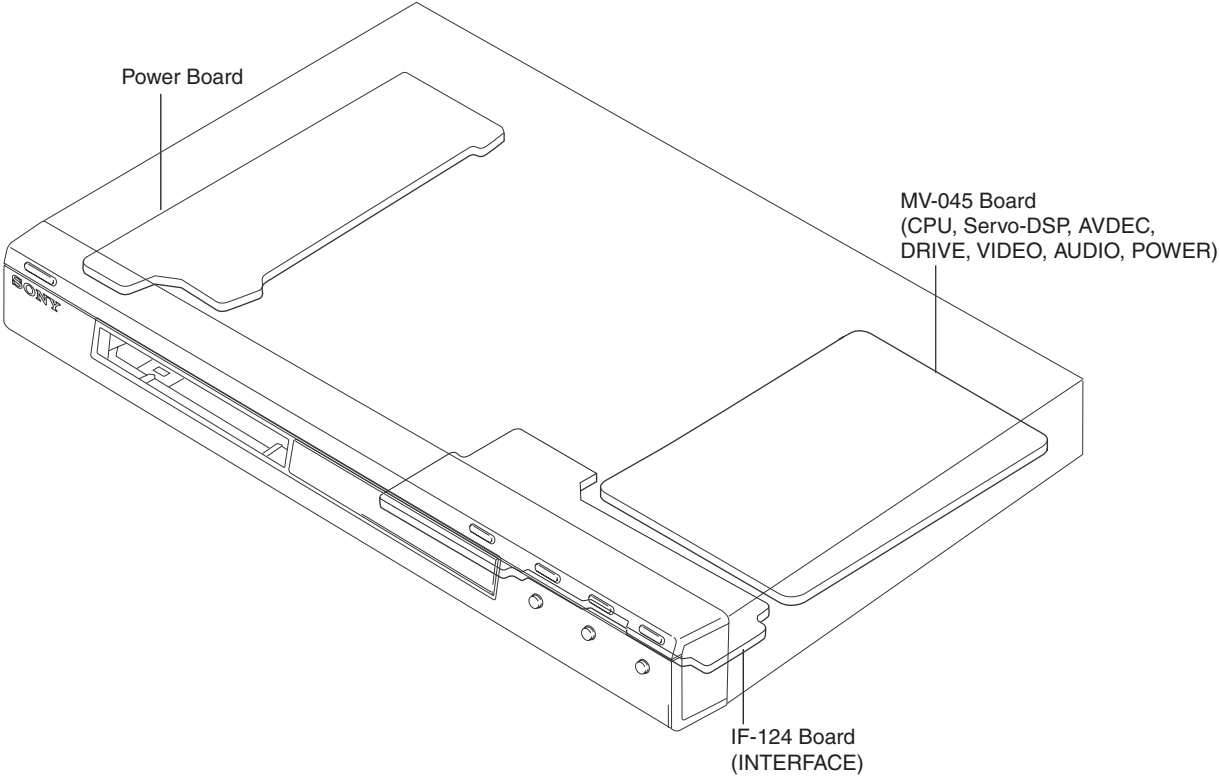

**SECTION 3  
BLOCK DIAGRAMS**

**3-1. OVERALL BLOCK DIAGRAM**

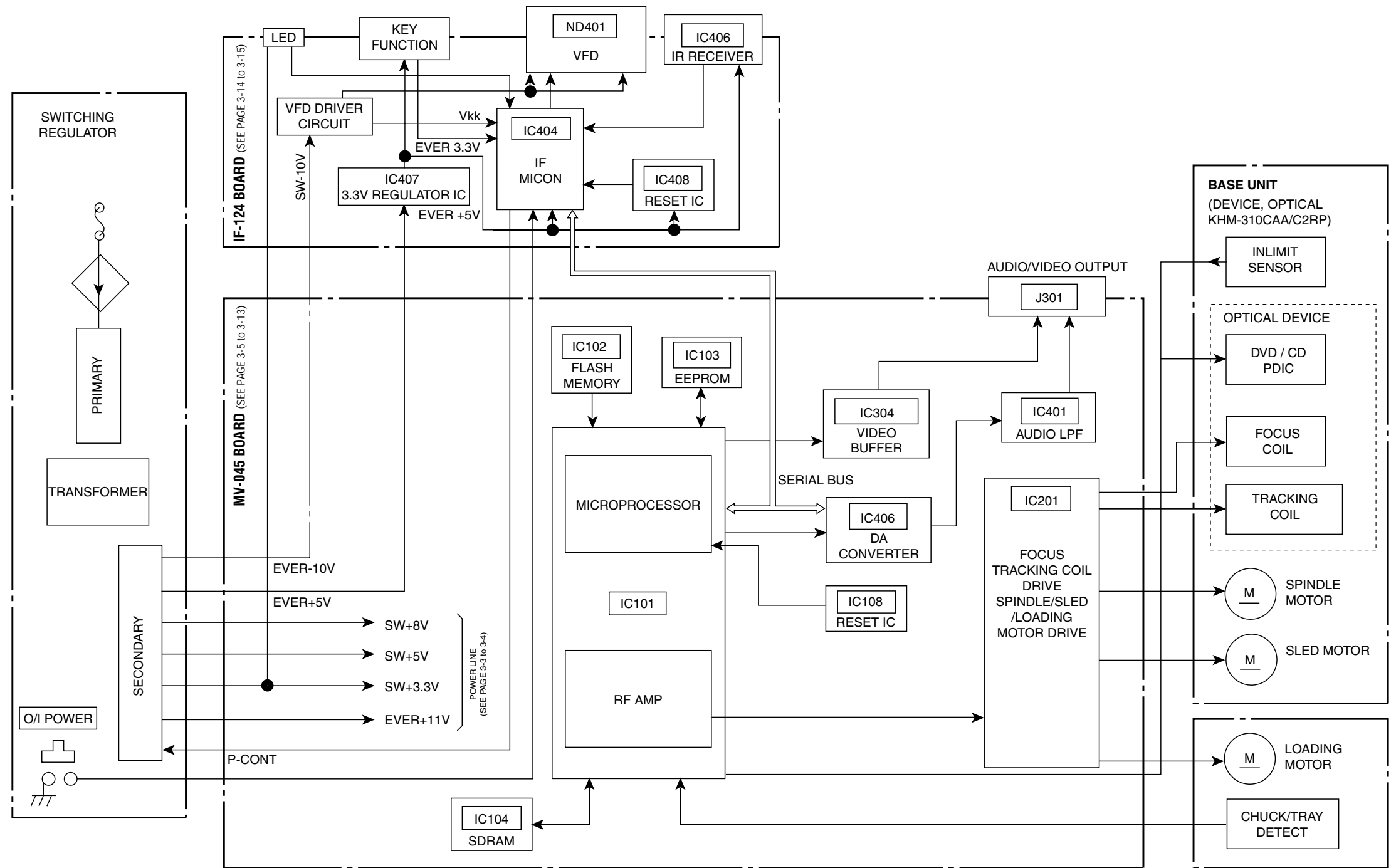

- Abbreviation
- MY :Malaysia model
- CND : Canadian Model
- MX : Mexican Model
- PX : PX Model
- E : Latin America Model
- ME5 : IND, PAK, MAR Model
- EA : Saudi Arabia Model
- IR : Iran Model
- ME2 : Middle East
- AUS : Australia/NZ Model
- HK : Hong Kong Model
- SP : Singapore Model
- TW : Taiwan Model
- KR : Korean Model

**Notes:**

MV-045 mounted PWB must be replaced if IC103 (EEPROM IC) is damaged or not functioning.

The old MV-045 mounted PWB must be completely disposed.

3-2. POWER LINE BLOCK DIAGRAM

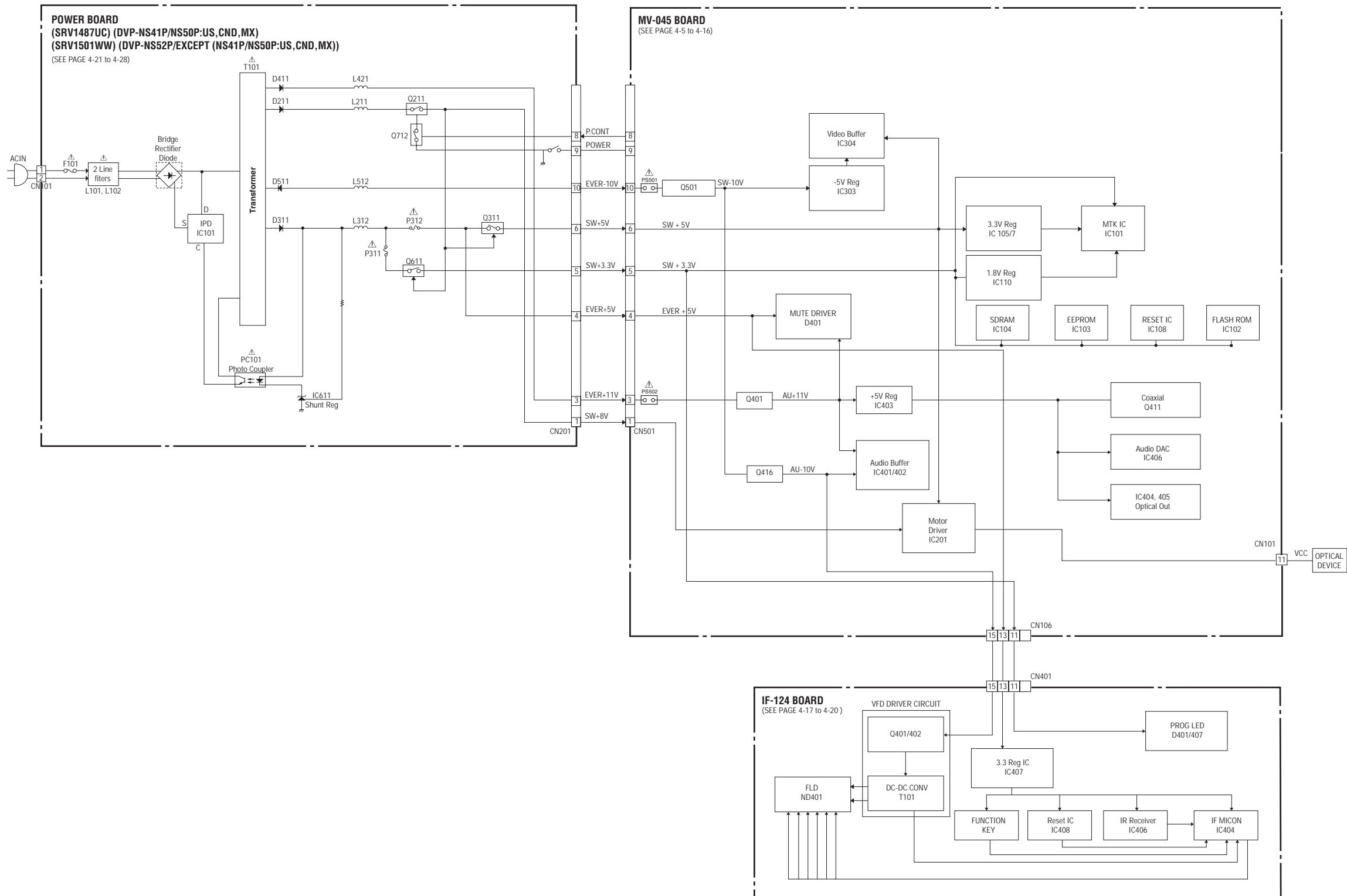

The components identified by mark  $\Delta$  or dotted line with mark  $\Delta$  are critical for safety. Replace only with part number specified.

Les composants identifiés par une marque  $\Delta$  sont critiques pour la sécurité. Ne les remplacer que par une pièce portant le numéro spécifié.

3-3. SYSTEM CONTROL/SIGNAL PROCESSOR BLOCK DIAGRAM

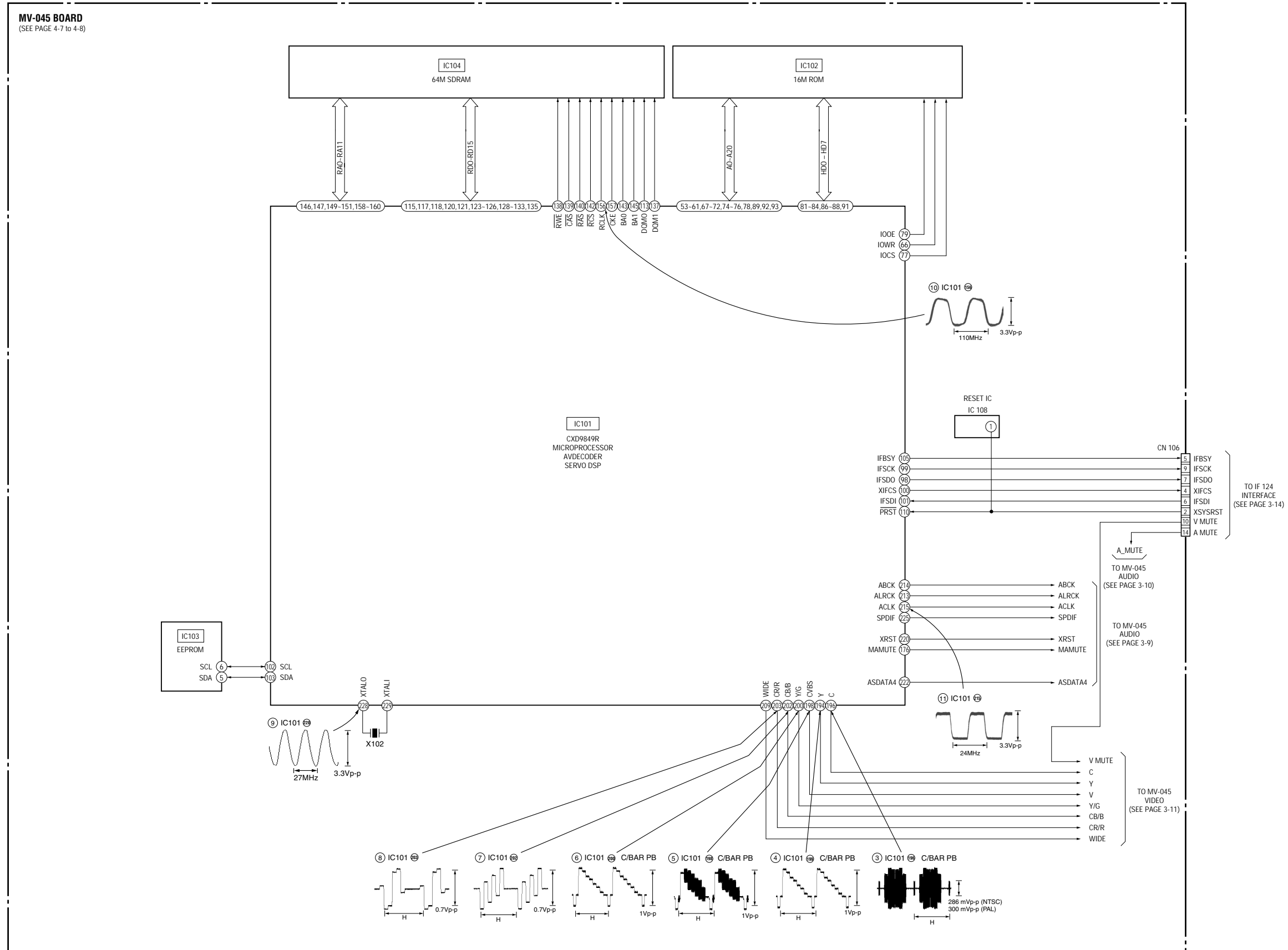

3-4. RF/SERVO BLOCK DIAGRAM

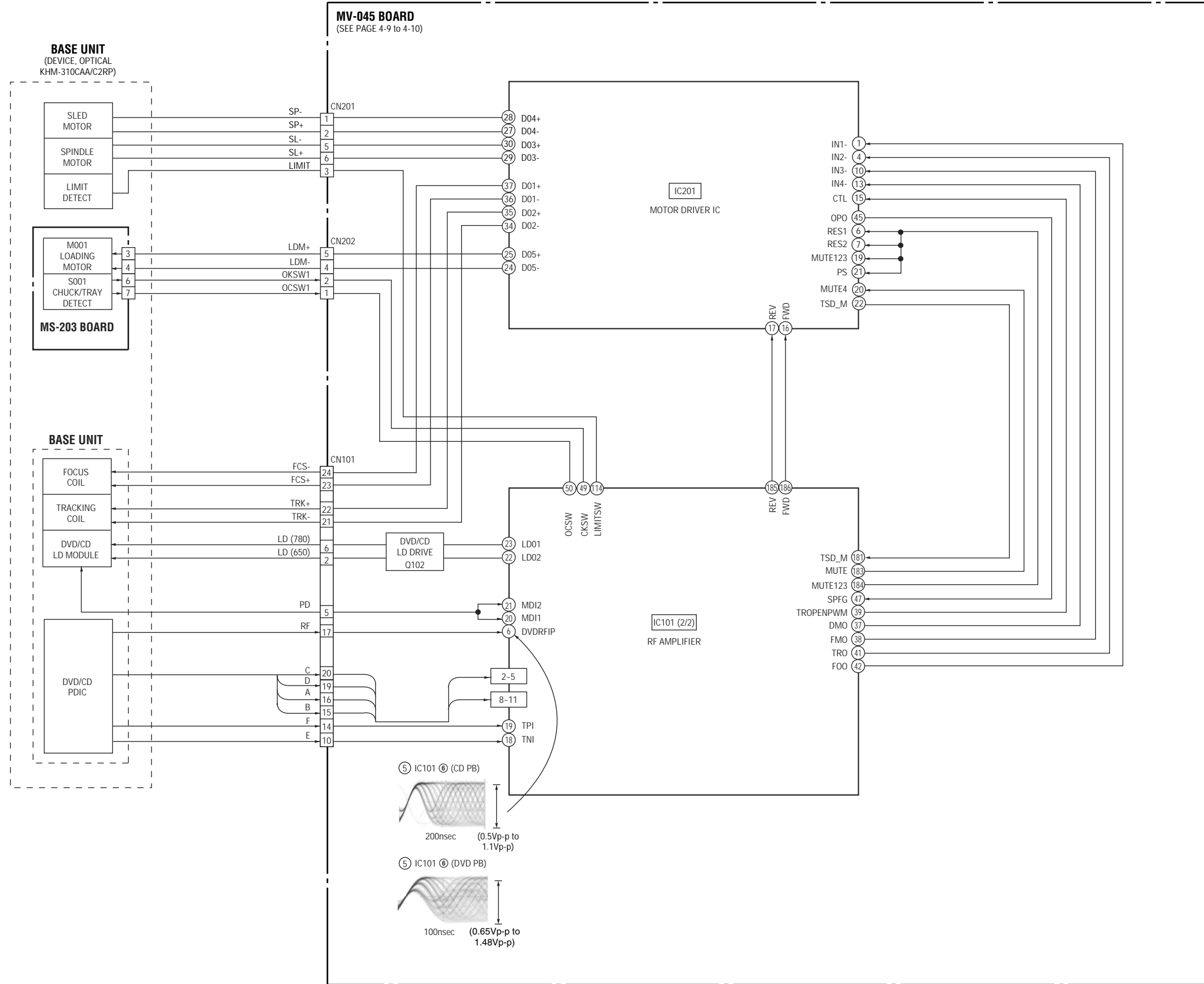

3-5. AUDIO BLOCK DIAGRAM

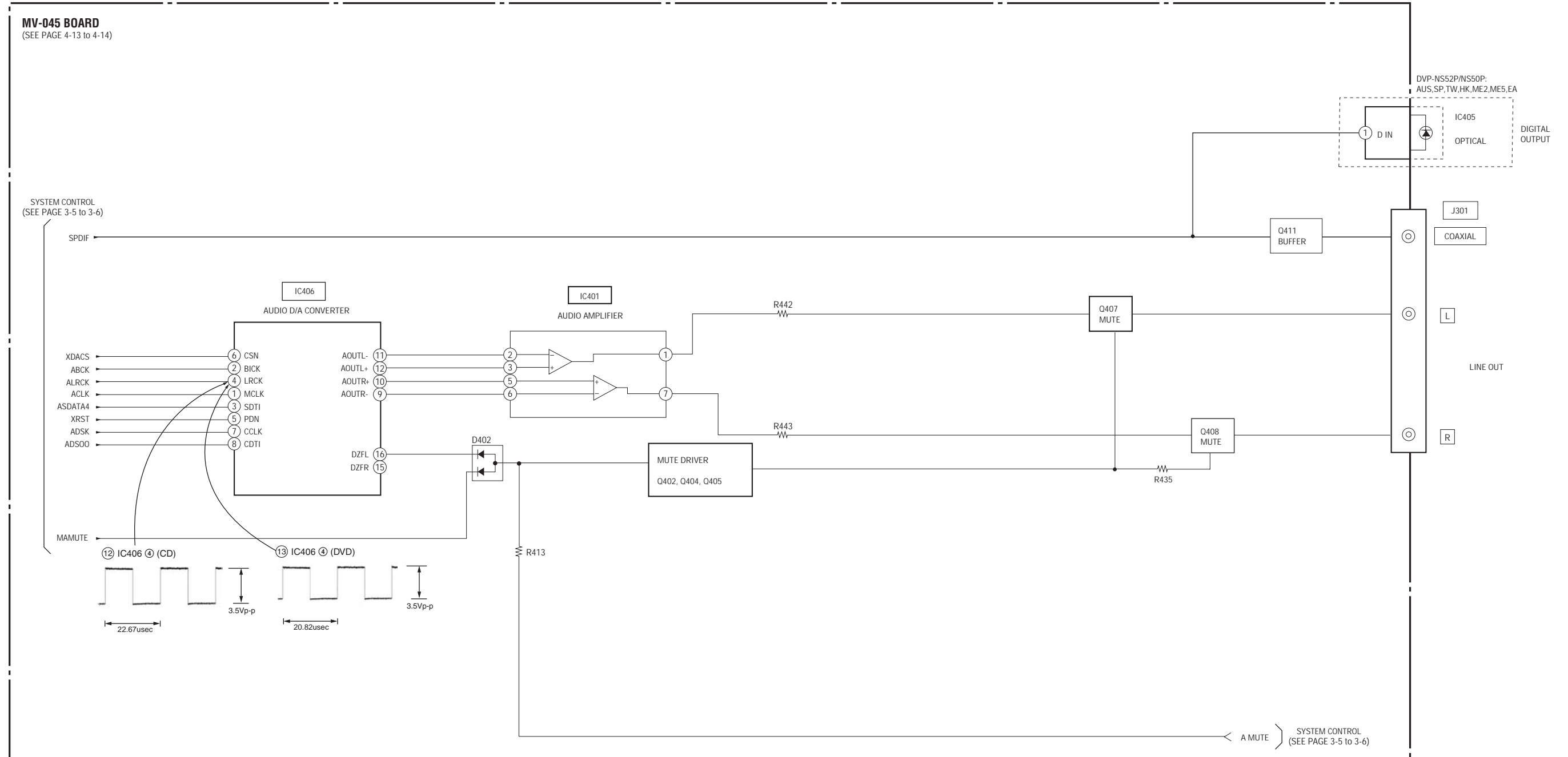

3-6. VIDEO BLOCK DIAGRAM

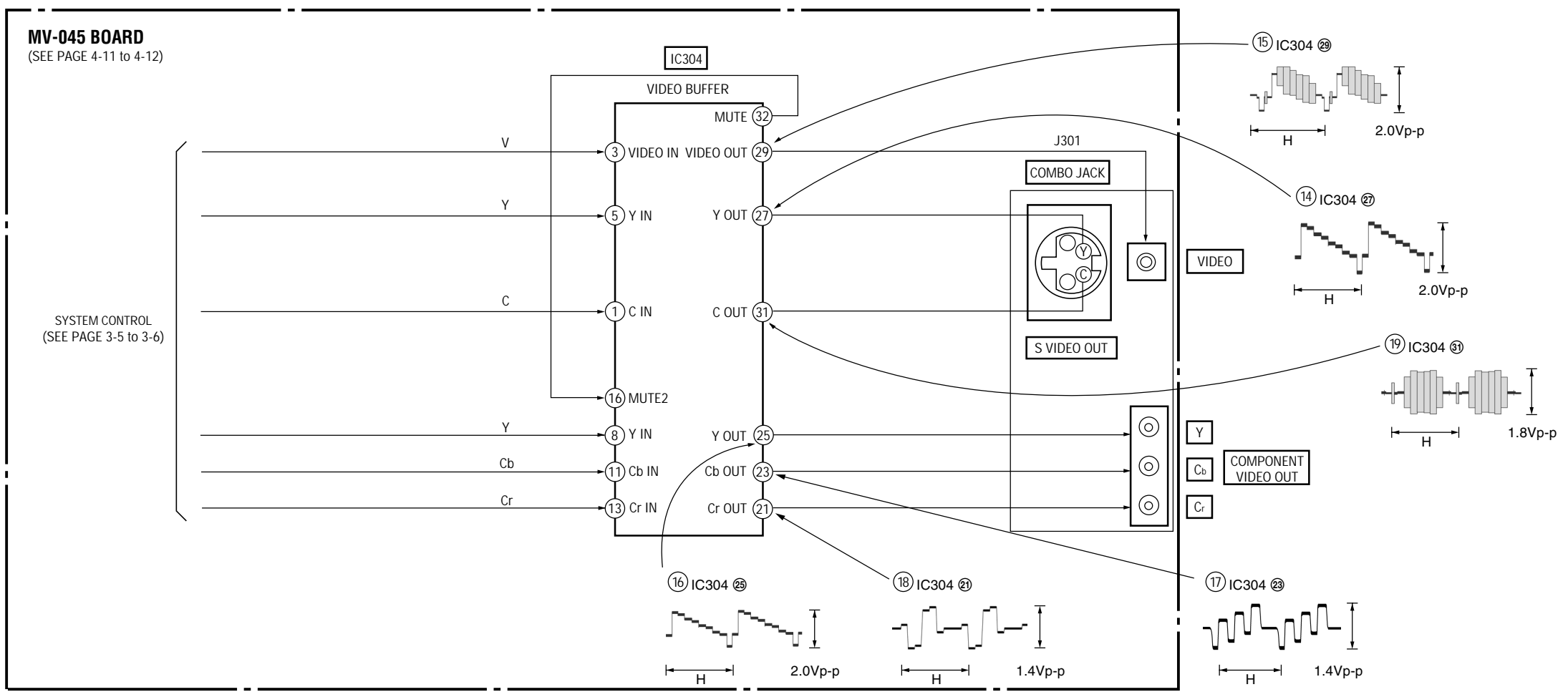



3-7. INTERFACE CONTROL BLOCK DIAGRAM

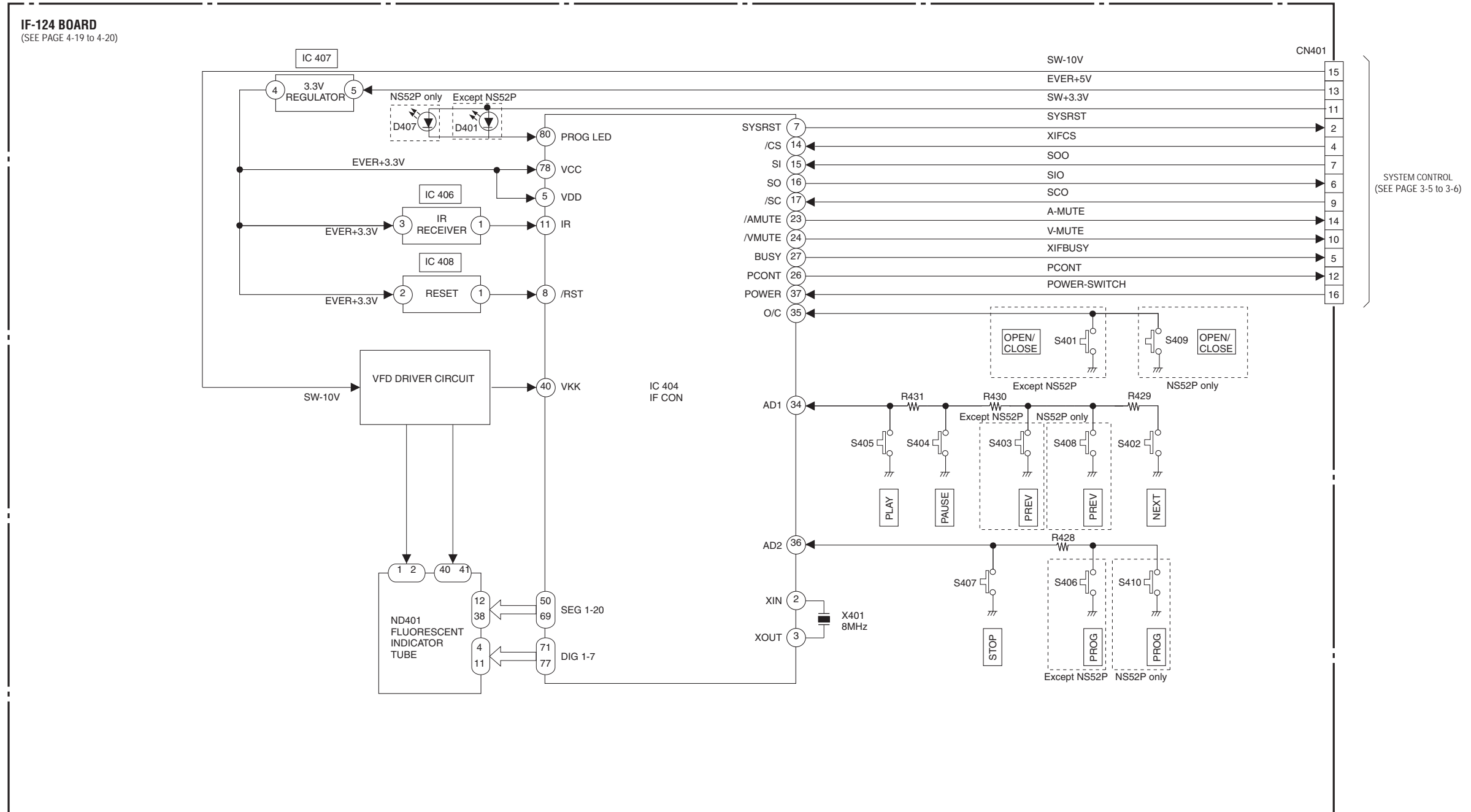

**SECTION 4  
PRINTED WIRING BOARDS AND SCHEMATIC DIAGRAMS**

**4-1. FRAME SCHEMATIC DIAGRAM**

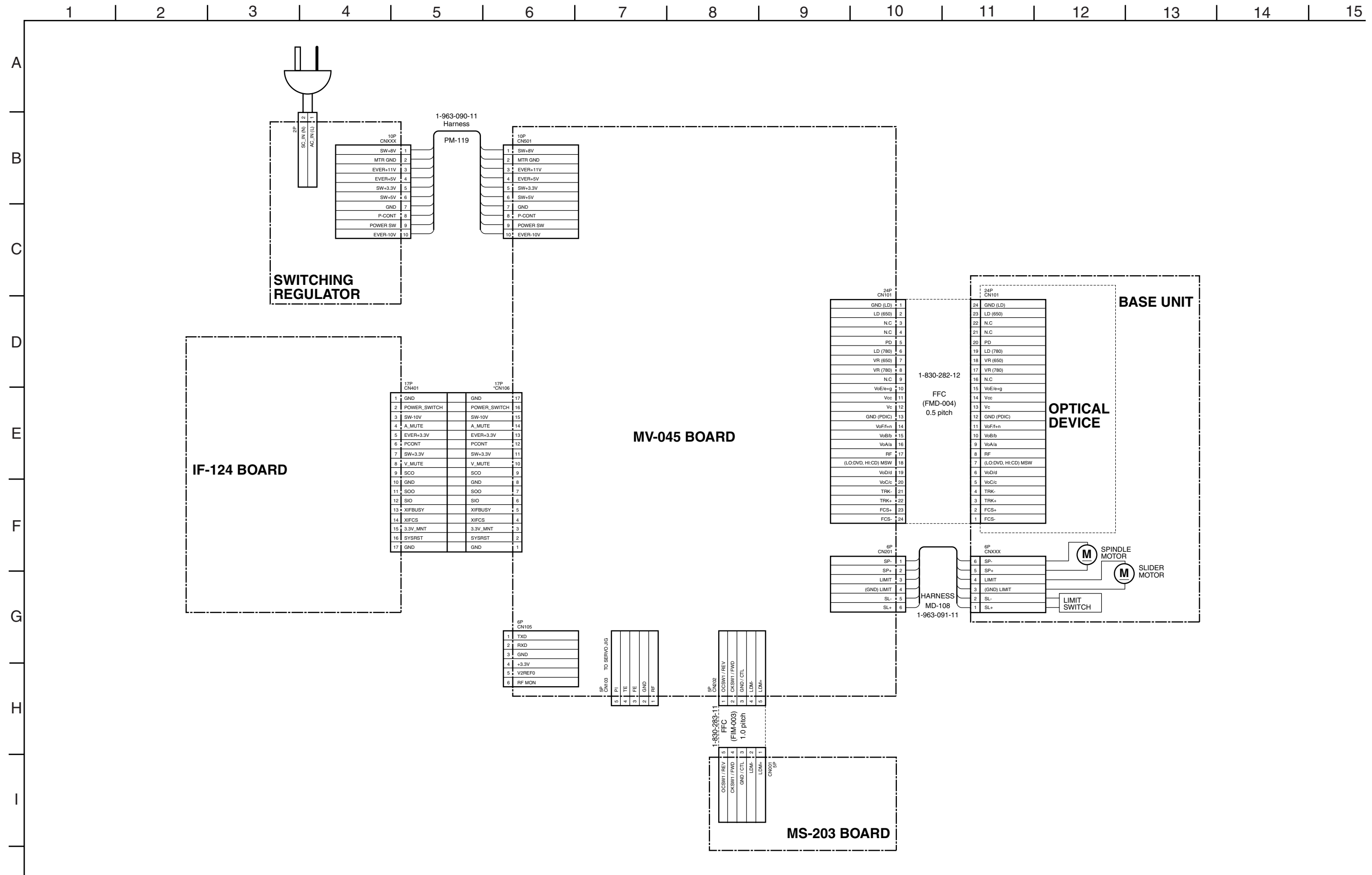

### 4-2. PRINTED WIRING BOARDS AND SCHEMATIC DIAGRAMS

**THIS NOTE IS COMMON FOR WIRING BOARDS AND SCHEMATIC DIAGRAMS.**  
 (In addition to this, the necessary note is printed in each block)

**For printed wiring boards:**

- — : indicates a lead wire mounted on the component side.
- — : indicates a lead wire mounted on the printed side.
- : Through hole.
- : Pattern from the side which enables seeing. (The other layers' patterns are not indicated.)

**Caution:**  
 Pattern face side: Parts on the pattern face side seen from (Side A) the pattern face are indicated.  
 Parts face side: Parts on the parts face side seen from (Side B) the parts face are indicated.

- Abbreviation
- US : USA Model
- CND : Canadian Model
- MX : Mexican Model
- PX : PX Model
- E : Latin America Model
- ME5 : IND, PAK, MAR Model
- EA : Saudi Arabia Model
- IR : Iran Model
- ME2 : Middle East
- AUS : Oceania Model
- HK : Hong Kong Model
- SP : GA Model
- TW : Taiwan Model
- KR : Korean Model
- IN : India

**For schematic diagrams:**

- All capacitors are in  $\mu\text{F}$  unless otherwise noted.  $\text{pF}$  :  $\mu\text{F}$ . 50V or less are not indicated except for electrolytics and tantalums.
- All resistors are in ohms, 1/4W (Chip resistors : 1/10W) un-less otherwise specified.  $\text{k}\Omega = 1000\Omega$ ,  $\text{M}\Omega = 1000\text{k}\Omega$ .
- Caution when replacing chip parts. New parts must be attached after removal of chip. Be careful not to heat the minus side of tantalum capacitor, because it is damaged by the heat.
- All variable and adjustable resistors have characteristic curve B, unless otherwise noted.
- □ : non flammable resistor.
- □ : fusible resistor.
- □ : panel designation.
- $\Delta$  : internal component.
- □ : adjustment for repair.
- Circled numbers refer to waveforms.
- Voltages are dc between measurement point.
- Readings are taken with a color-bar signal on DVD reference disc and when playing CD reference disc.
- Readings are taken with a digital multimeter (DC 10M $\Omega$ ).
- Voltage variations may be noted due to normal production tolerances.

**Note:**  
 The components identified by mark  $\Delta$  or dotted line with mark  $\Delta$  are critical for safety. Replace only with part number specified.

**Note:**  
 Les composants identifiés par une marque  $\Delta$  sont critiques pour la sécurité. Ne les remplacer que par une pièce portant le numéro spécifié.

When indicating parts by reference number, please include the board name.

### 4-3. WAVEFORM

#### MV-045 BOARD

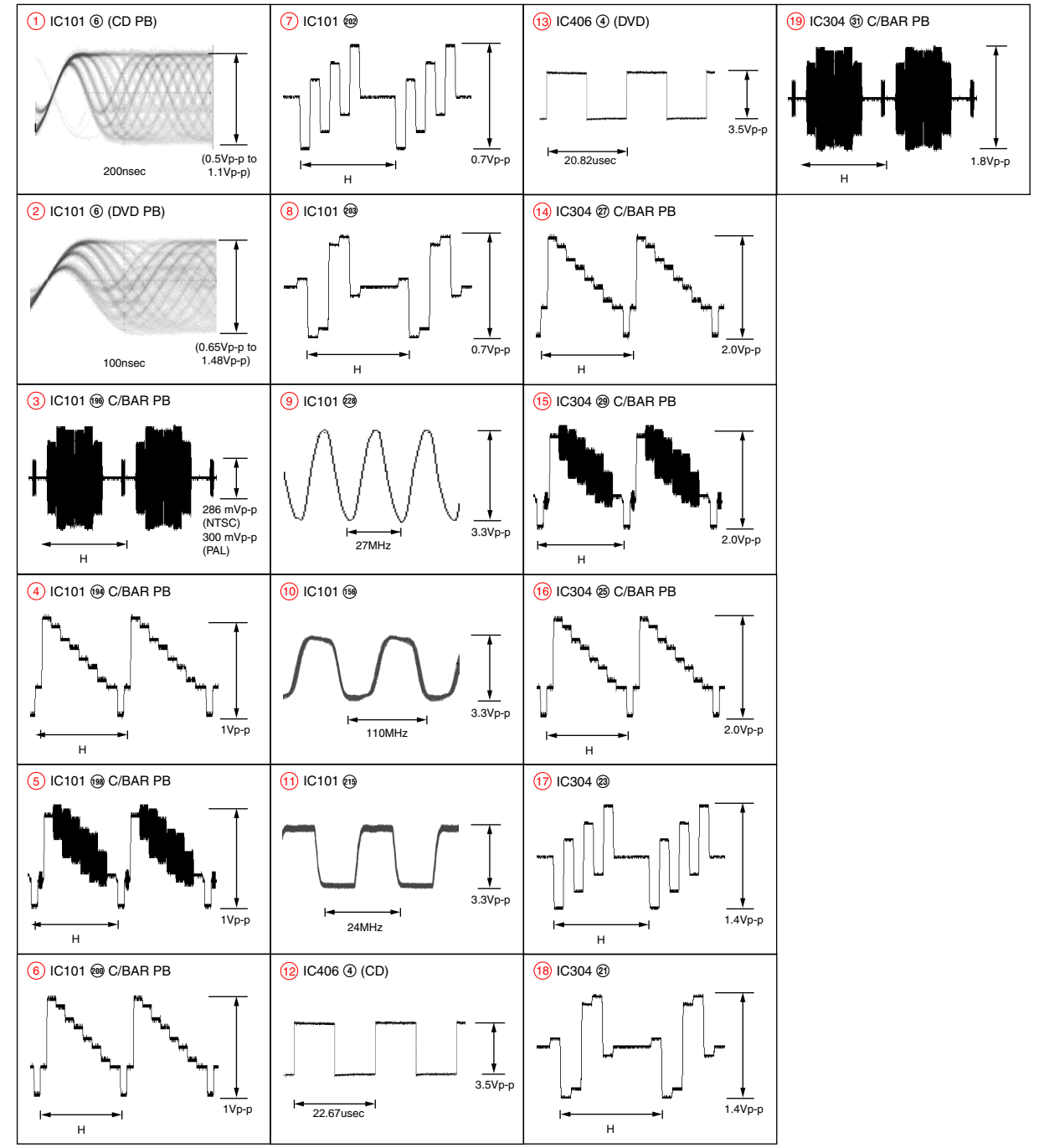

MV-045 (CPU, Servo-DSP, AVDEC, DRIVE, VIDEO, AUDIO, POWER) PRINTED WIRING BOARD

•  : Uses unleaded solder.

MV-045 BOARD SIDE A

MV-045 BOARD SIDE B

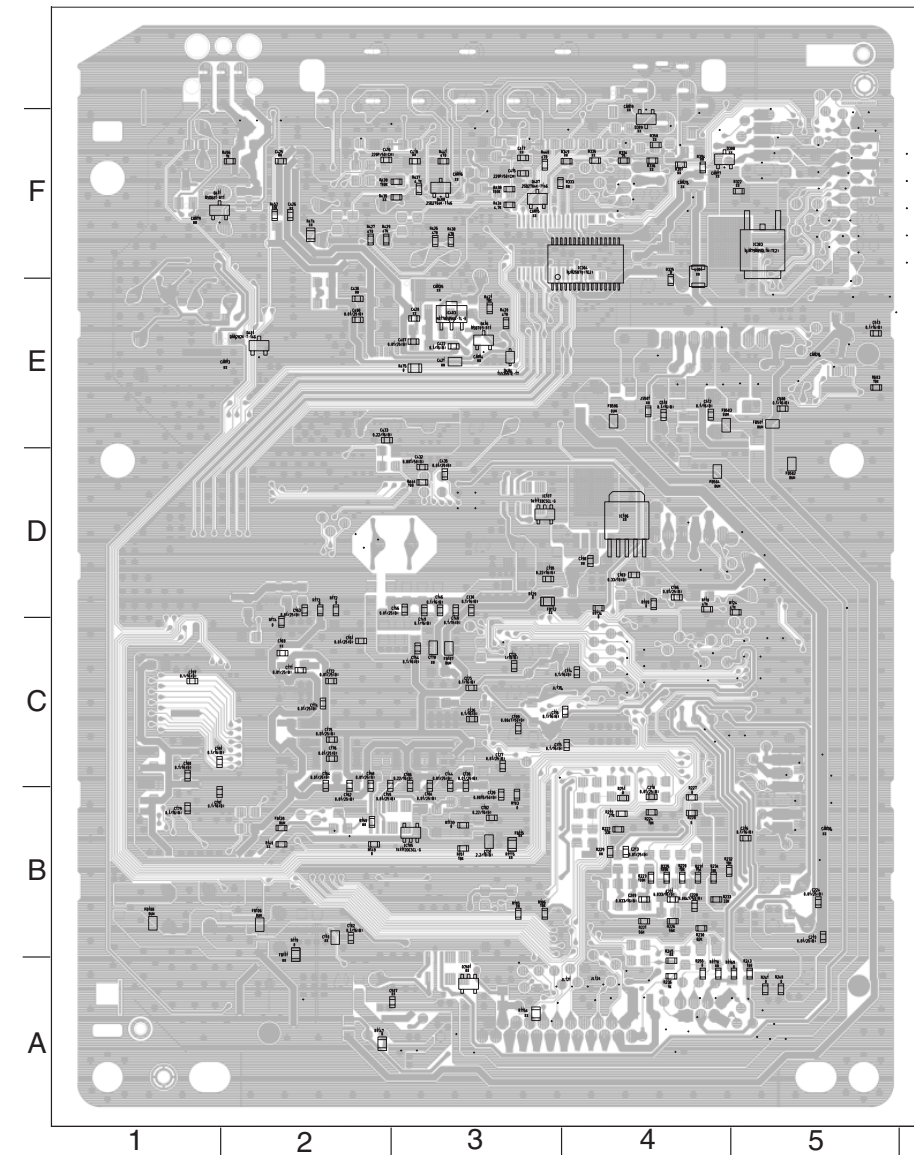
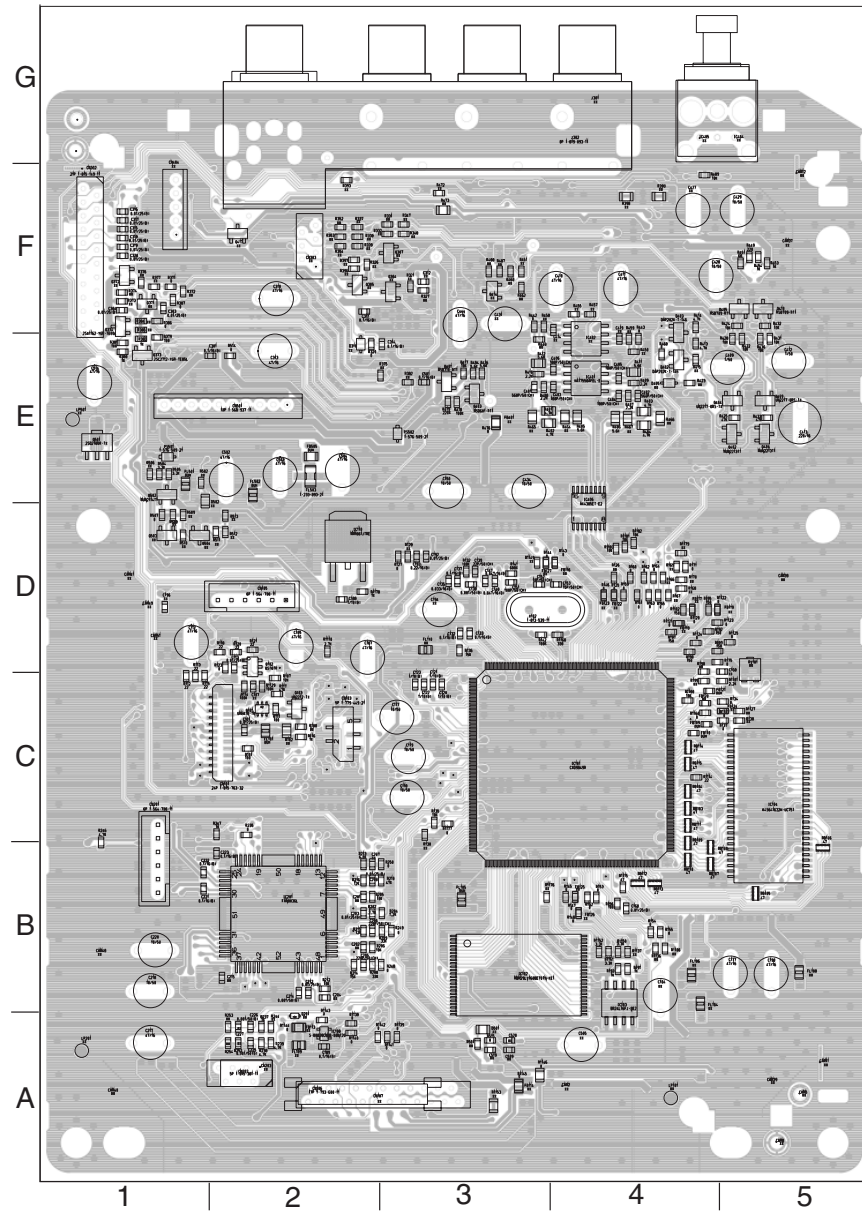

MV-045 BOARD

SIDE A		SIDE B	
IC101	C-4	IC105	B-3
IC102	B-3	IC106	D-4
IC103	B-4	IC107	D-3
IC104	C-5	IC303	F-5
IC108	A-2	IC304	F-4
IC110	D-2	IC403	E-3
IC201	B-2	IC501	A-3
IC401	E-4		
IC402	E-4	Q407	F-3
IC404	G-5	Q408	F-3
IC405	G-4	Q411	F-1
IC406	E-4	Q416	E-3
Q101	C-4	D308	F-4
Q102	D-2	D309	F-4
Q103	C-4	D401	E2
Q304	F-3	D404	E-3
Q305	F-2		
Q307	F-4		
Q371	F-1		
Q372	F-1		
Q373	E-1		
Q374	F-1		
Q401	E-3		
Q402	E-5		
Q403	E-3		
Q404	E-4		
Q405	F-4		
Q406	E-5		
Q409	E-5		
Q410	F-5		
Q414	F-3		
Q417	F-2		
Q501	E-1		
Q502	E-1		
Q503	D-1		
Q504	D-1		
D201	A-2		
D310	E-2		
D501	A-3		
D402	E-4		
D403	F-4		
D405	E-4		

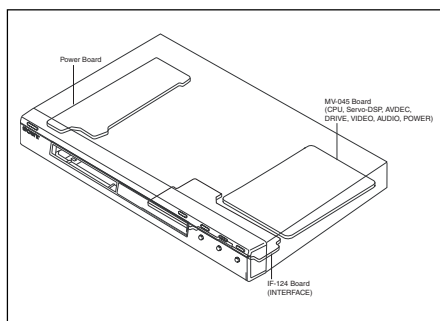

For printed wiring board

There are a few cases that the part printed on this diagram isn't mounted in this model.

For Schematic Diagram

- Refer to page 4-5 for printed wiring board of MV-045 board.
- Refer to page 4-4 for waveform

1 | 2 | 3 | 4 | 5 | 6 | 7 | 8 | 9 | 10 | 11 | 12 | 13 | 14 | 15

A  
B  
C  
D  
E  
F  
G  
H  
I  
J

MV-045 BOARD (1/5)  
CPU, Servo-DSP, AVDEC  
-REF.NO.:1000 SERIES-  
XX MARK:NO MOUNT  
  
NO MARK:REC/PB MODE

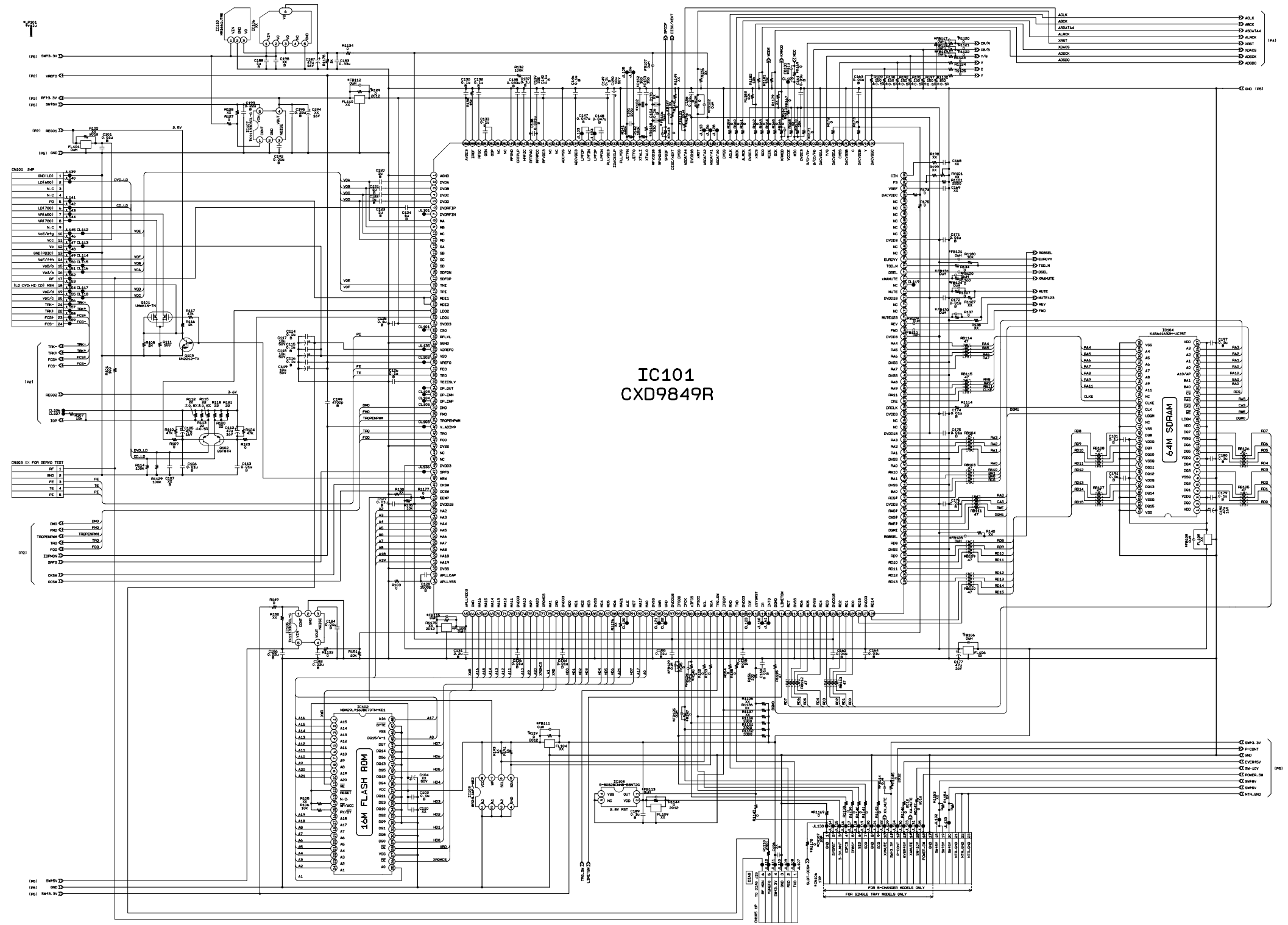



**For Schematic Diagram**

- Refer to page 4-5 for printed wiring board of MV-045 board.
- Refer to page 4-4 for waveform

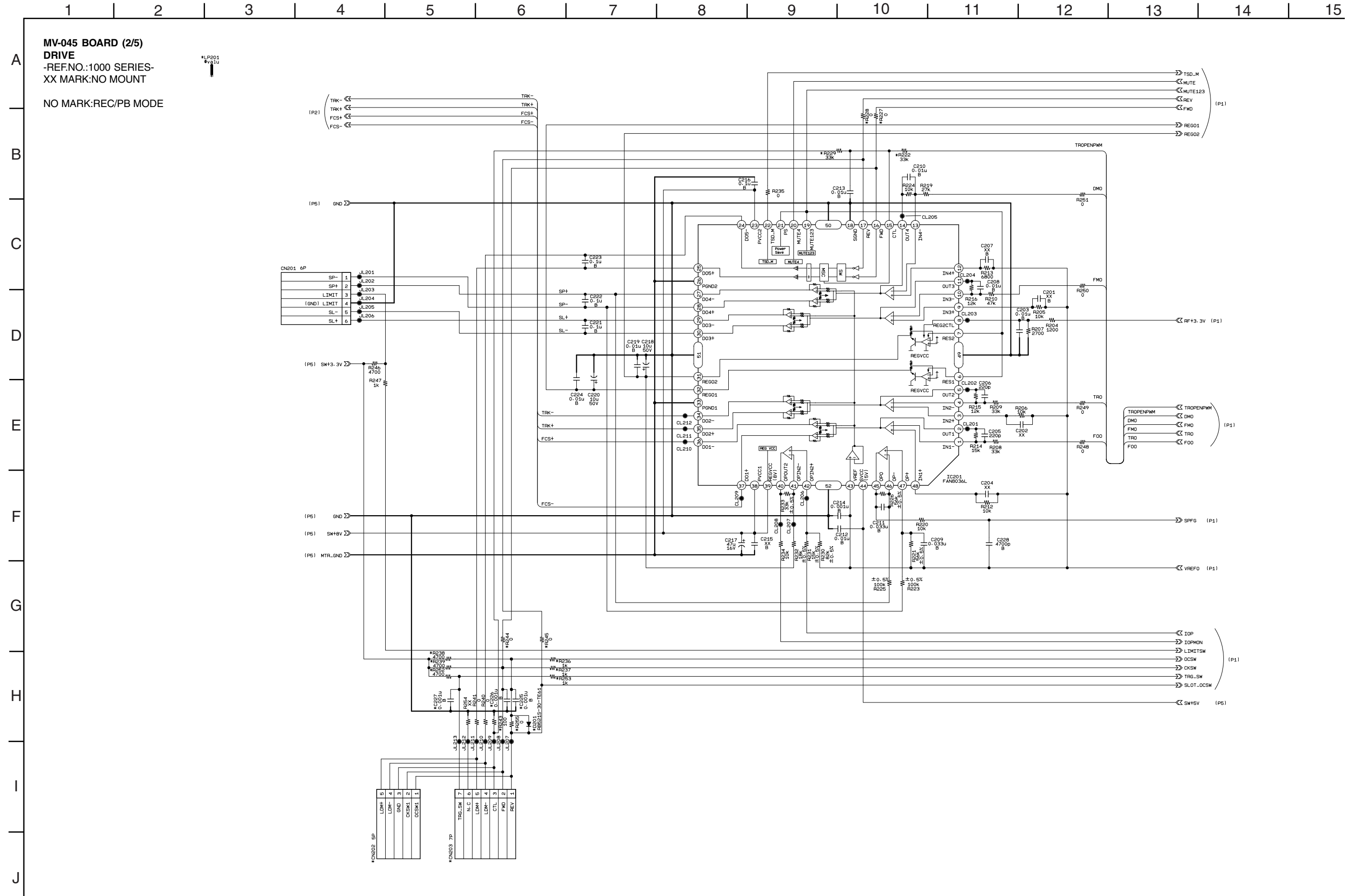

**For Schematic Diagram**

- Refer to page 4-5 for printed wiring board of MV-045 board.
- Refer to page 4-4 for waveform

1 2 3 4 5 6 7 8 9 10 11 12 13 14 15

**MV-045 BOARD (3/5)**  
**VIDEO**  
 -REF.NO.:1000 SERIES-  
 XX MARK:NO MOUNT  
 NO MARK:REC/PB MODE

A  
B  
C  
D  
E  
F  
G  
H  
I  
J

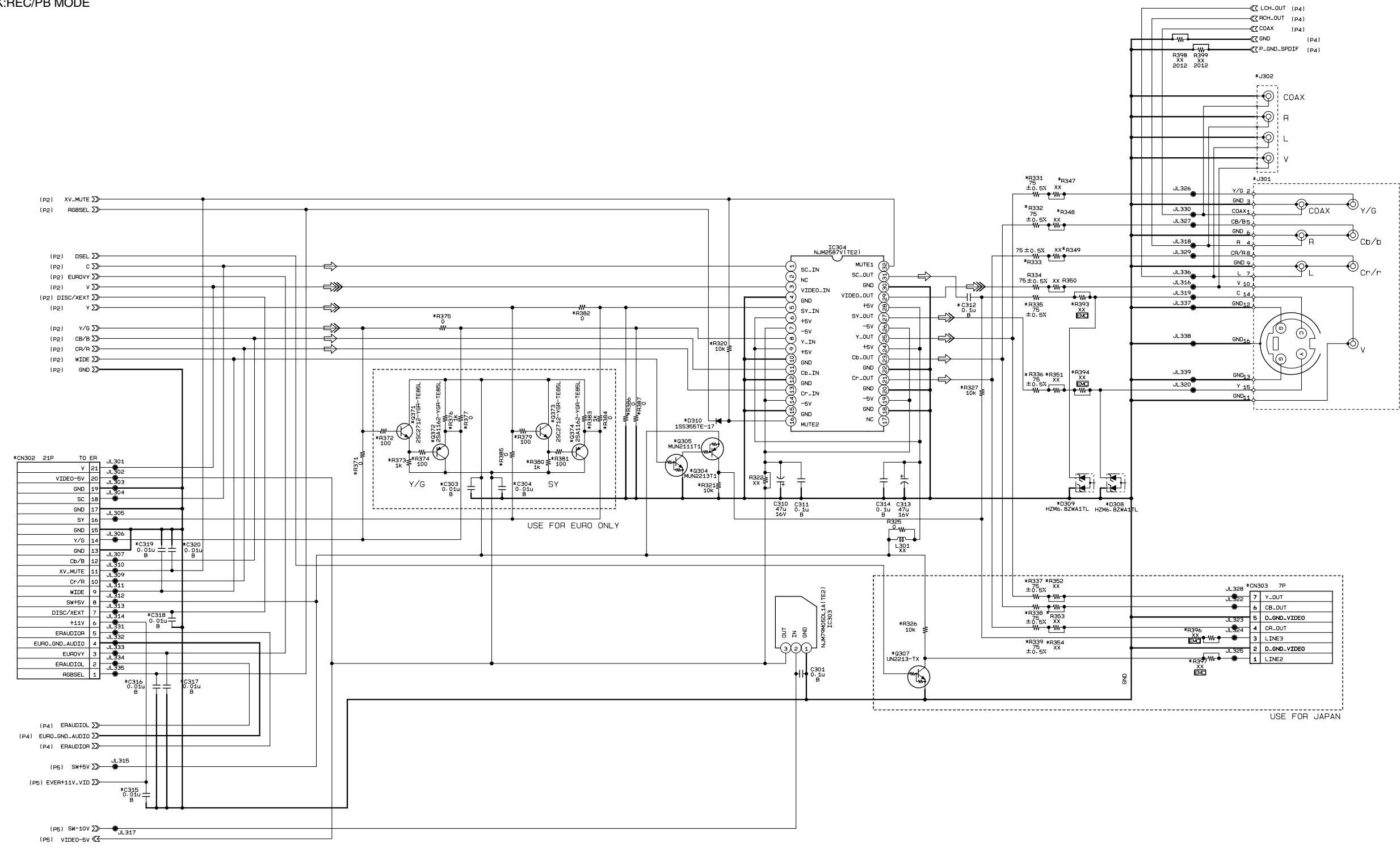

**SIGNAL PATH**

	VIDEO SIGNAL			AUDIO SIGNAL
	CHROMA	Y	Y/CHROMA	
PB	→	⇒	⇒⇒	⇒⇒⇒

**For Schematic Diagram**

- Refer to page 4-5 for printed wiring board of MV-045 board.
- Refer to page 4-4 for waveform

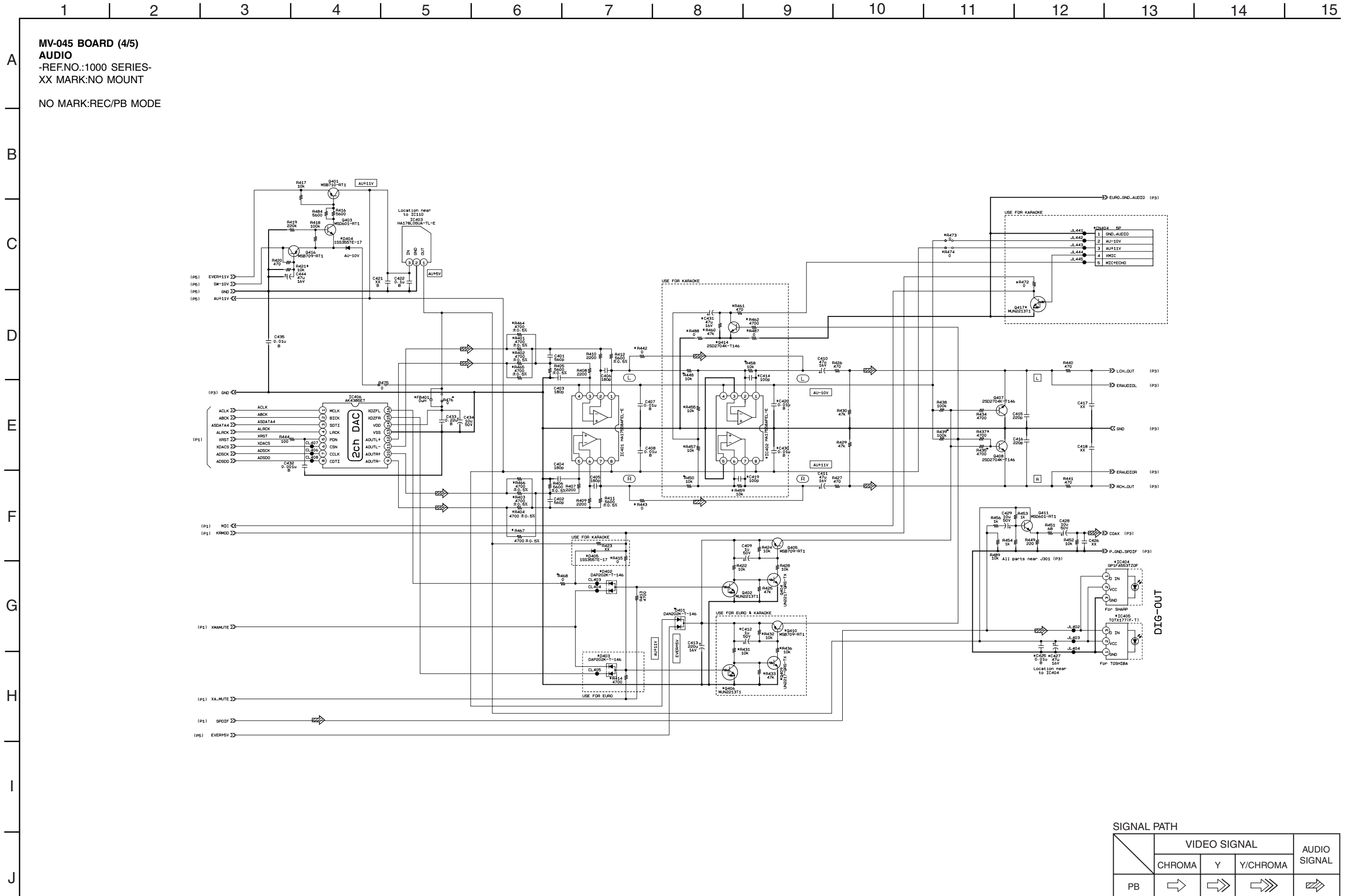



**For Schematic Diagram**

- Refer to page 4-5 for printed wiring board of MV-045 board.
- Refer to page 4-4 for waveform

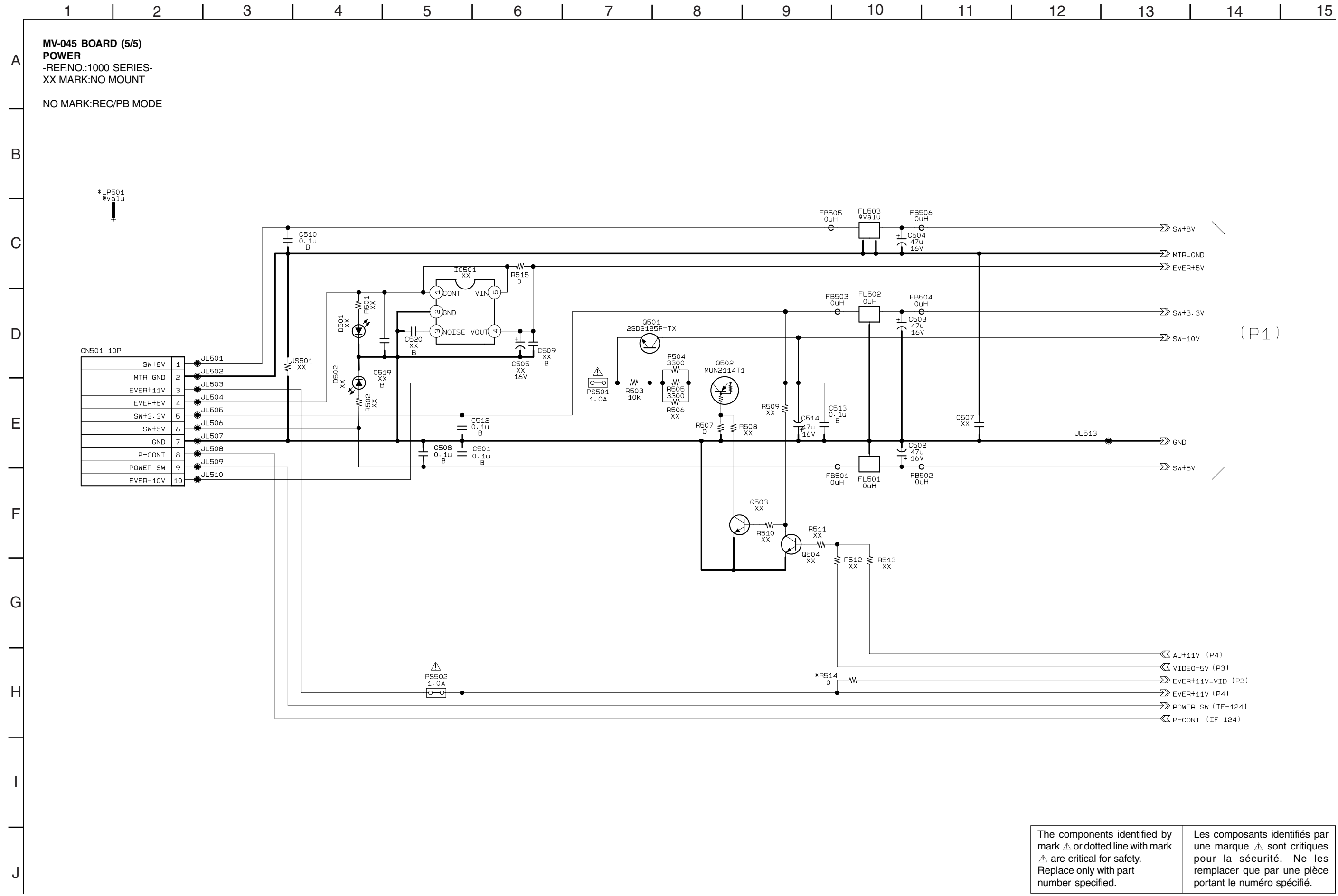

<p>The components identified by mark <math>\triangle</math> or dotted line with mark <math>\triangle</math> are critical for safety. Replace only with part number specified.</p>	<p>Les composants identifiés par une marque <math>\triangle</math> sont critiques pour la sécurité. Ne les remplacer que par une pièce portant le numéro spécifié.</p>
---	--

**IF-124 (INTERFACE) PRINTED WIRING BOARD**

•  : Uses unleaded solder.

**IF-124 BOARD SIDE A**

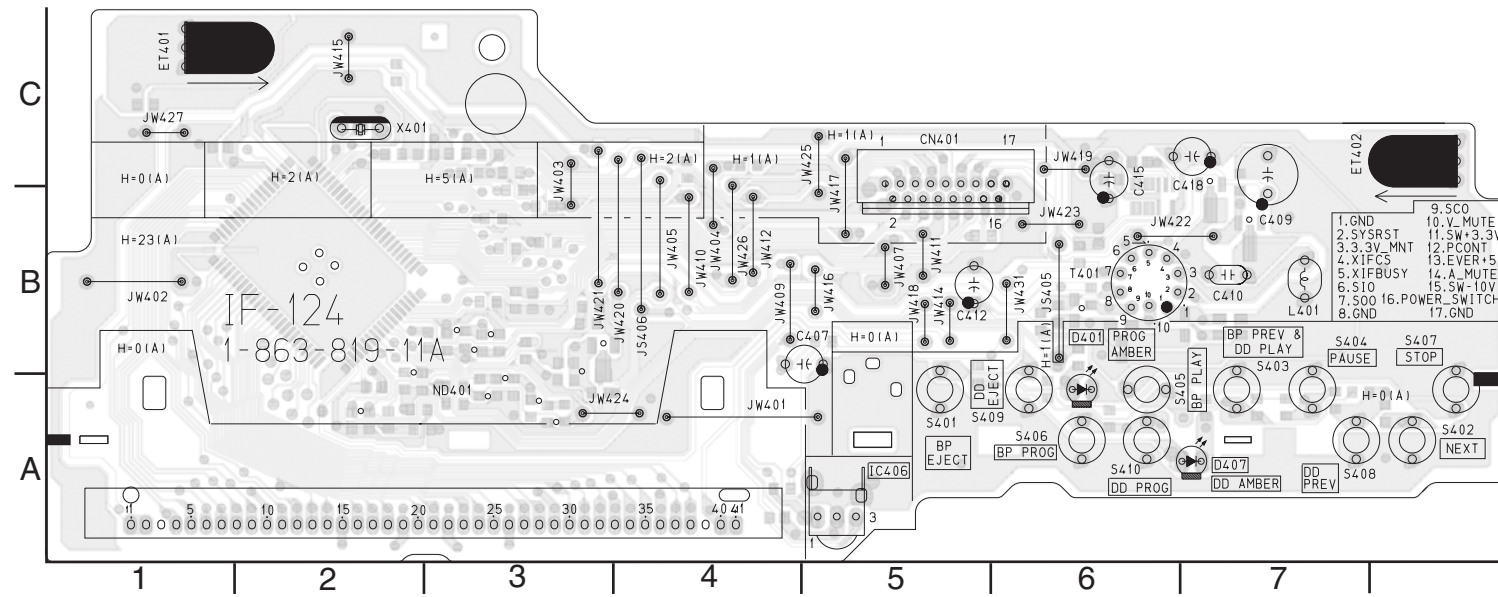

**For printed wiring board**

There are a few cases that the part printed on this diagram isn't mounted in this model.

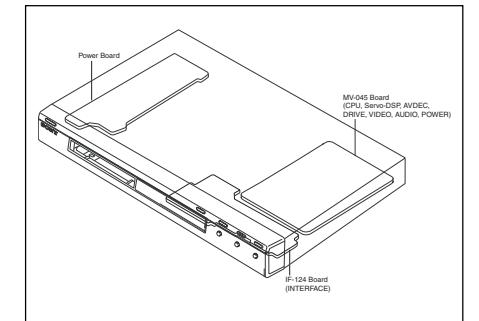

**IF-124 BOARD**

**SIDE A**

- IC406 A-5
- D401 B-6
- D407 A-7

**SIDE B**

- IC404 B-7
- IC407 B-2
- IC408 B-5
- Q401 B-2
- Q402 B-2
- D402 B-3
- D403 B-2
- D404 B-2
- D405 B-2
- D406 B-3

**IF-124 BOARD SIDE B**

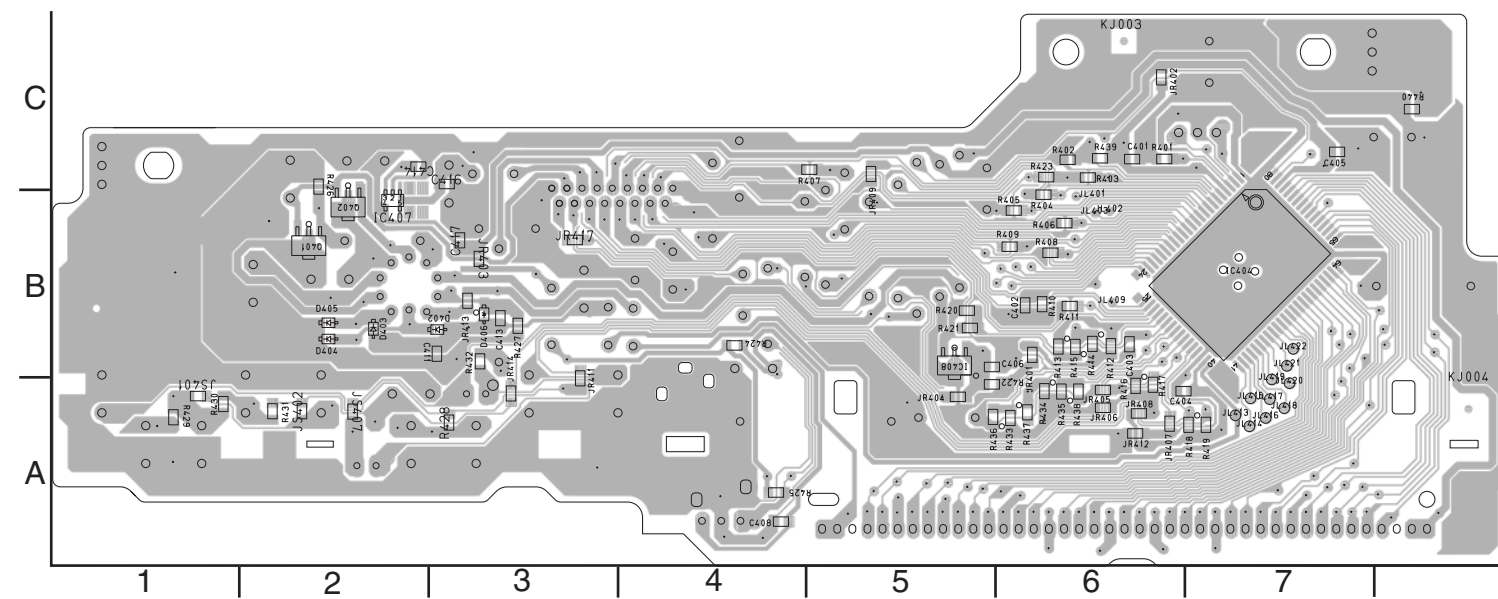

For Schematic Diagram

• Refer to page 4-17 for printed wiring board of IF-124 board.

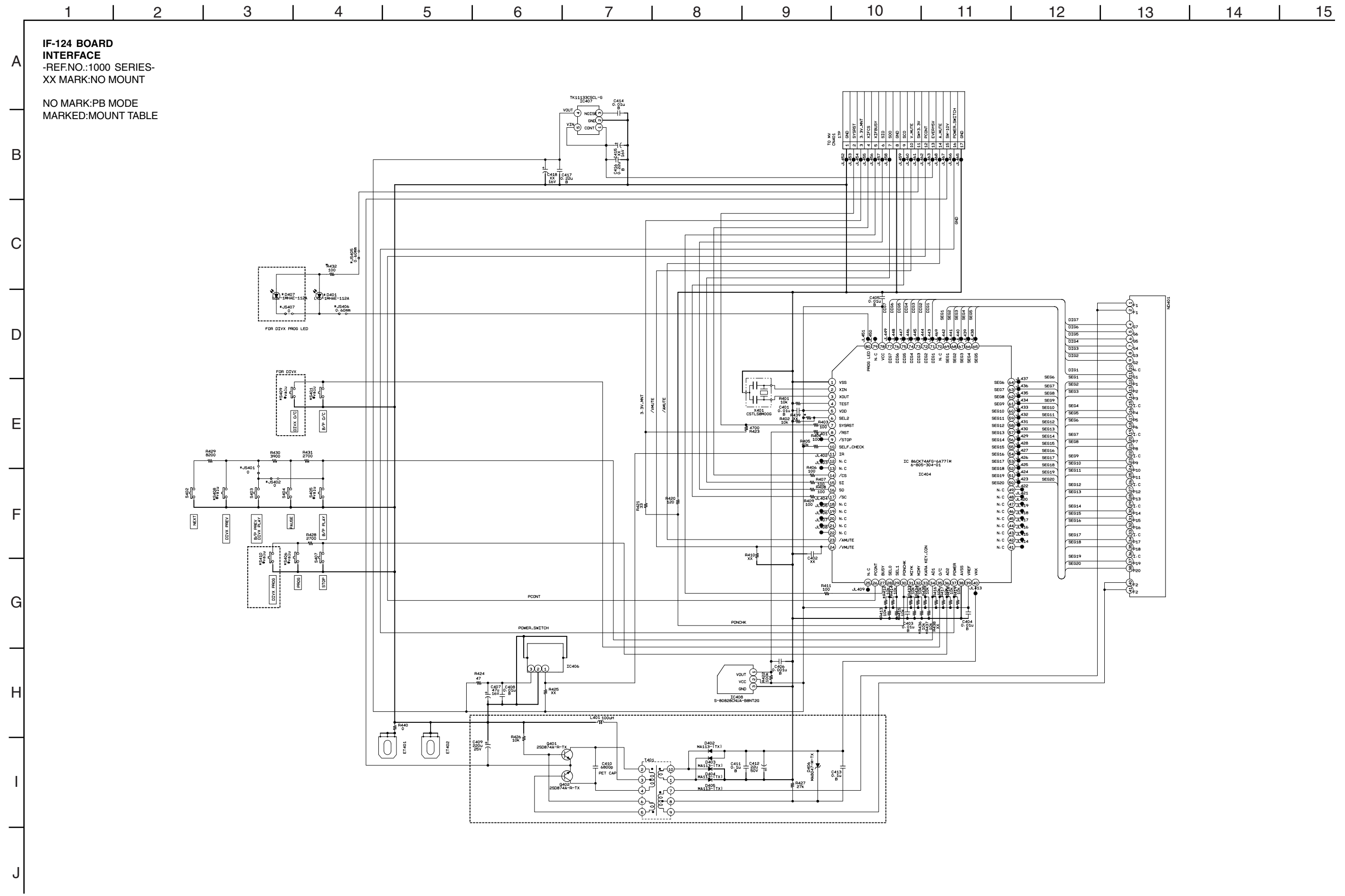

**POWER BLOCK (SRV1487UC) PRINTED WIRING BOARD**

•  : Uses unleaded solder.

**POWER BOARD (SRV1487UC) (SIDE A)**  
(NS41P/NS50P: US,CND,MX)

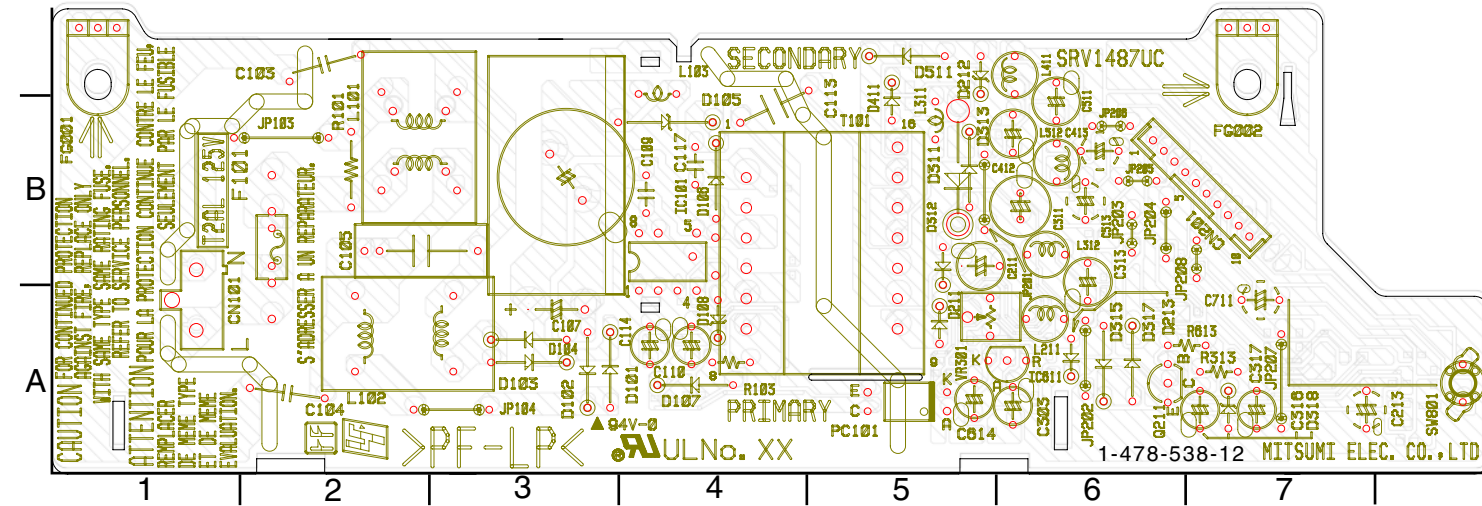

**For printed wiring board**

There are a few cases that the part printed on this diagram isn't mounted in this model.

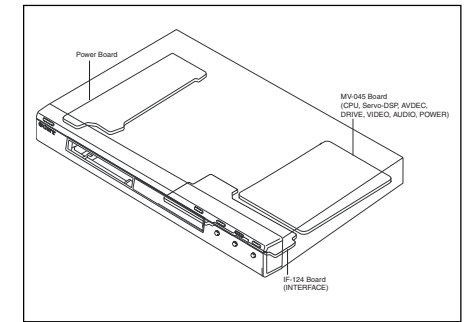

**POWERBOARD (SRV1487UC)**

**SIDE A**

- IC101 B-4
- IC611 A-6
- Q211 A-6
- D101 A-4
- D102 A-3
- D103 A-3
- D104 A-3
- D105 B-4
- D106 B-4
- D107 A-4
- D108 A-4
- D211 A-5
- D212 C-5
- D213 A-6
- D311 B-5
- D312 B-5
- D313 B-5
- D315 A-6
- D317 A-6
- D318 A-7
- D411 B-5
- D511 C-5

**SIDE B**

- Q311 A-1
- Q611 A-2
- Q712 A-1

**POWER BOARD (SRV1487UC) (SIDE B)**  
(NS41P/NS50P: US,CND,MX)

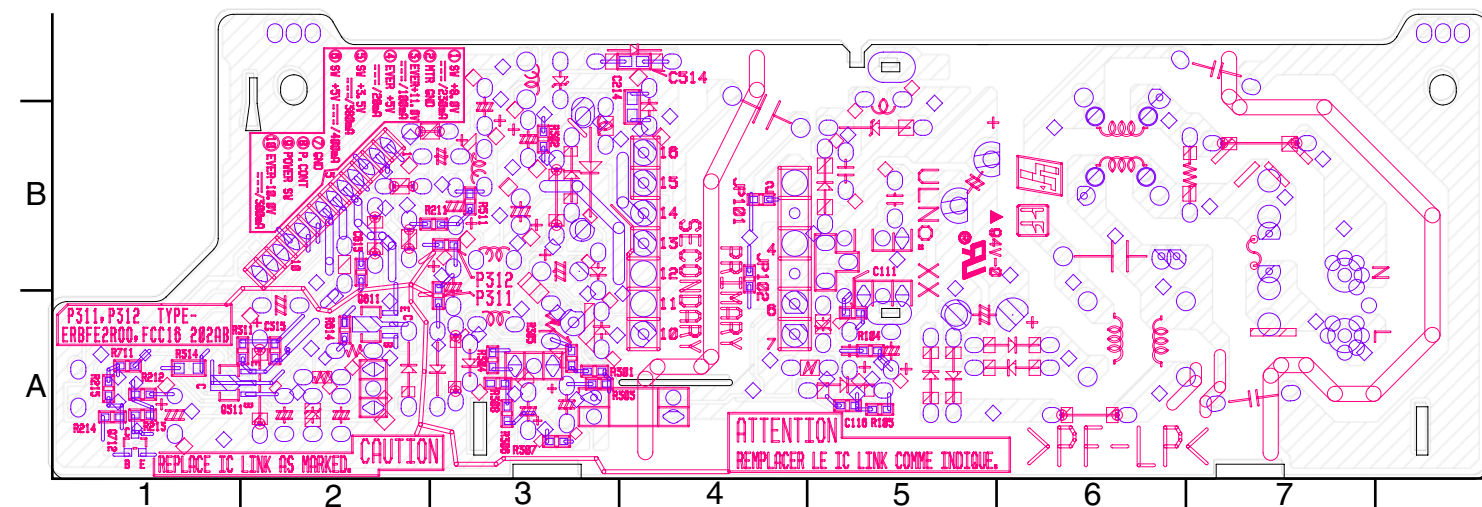

**POWER BOARD**  
**POWER BLOCK (SRV1487UC)**



**For Schematic Diagram**

• Refer to page 4-21 for printed wiring board of Power Board.

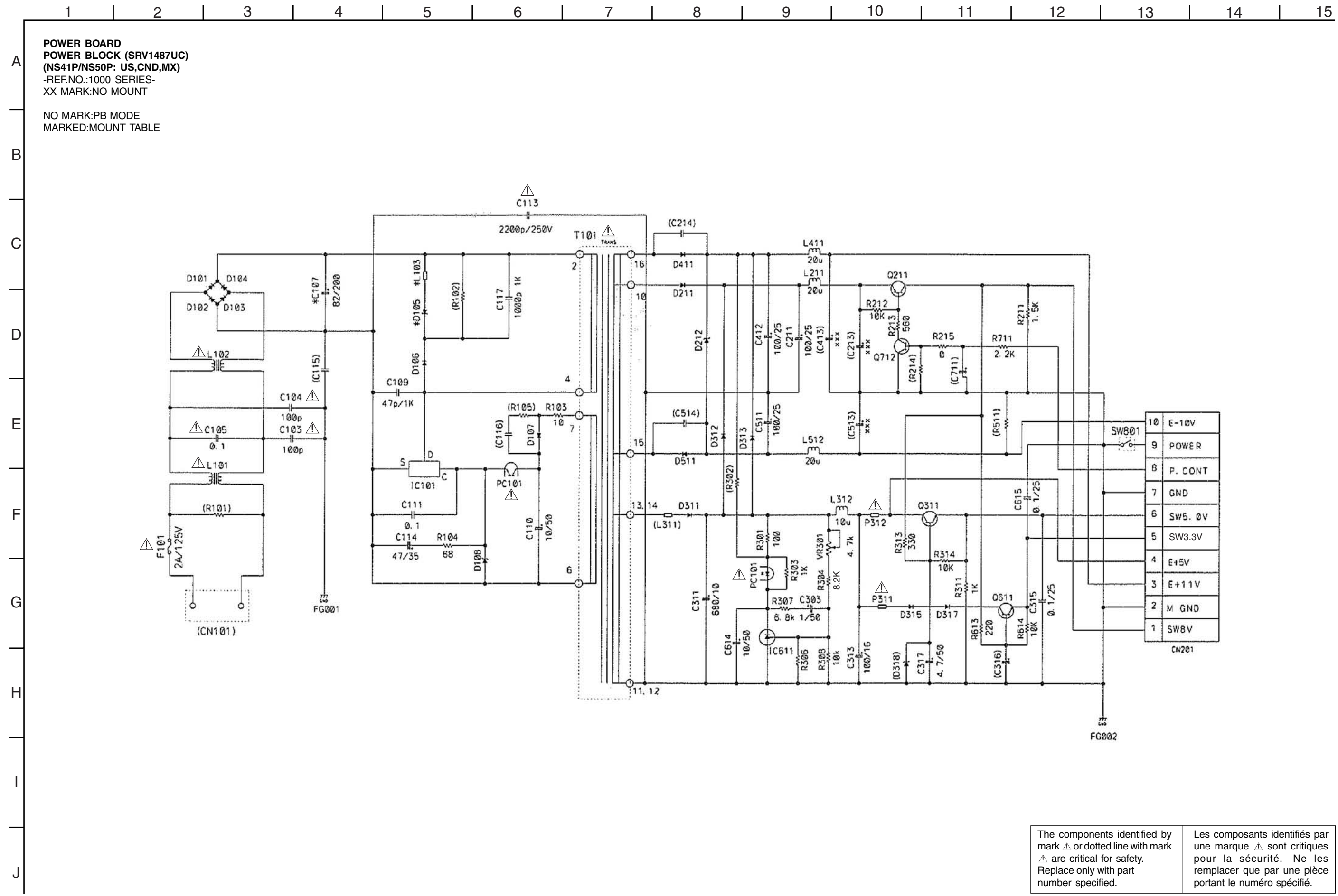

The components identified by mark  $\Delta$  or dotted line with mark  $\Delta$  are critical for safety. Replace only with part number specified.

Les composants identifiés par une marque  $\Delta$  sont critiques pour la sécurité. Ne les remplacer que par une pièce portant le numéro spécifié.

**POWER BLOCK (SRV1501WW) PRINTED WIRING BOARD**

•  : Uses unleaded solder.

**POWER BOARD (SRV1501WW) (SIDE A)  
(EXCEPT NS41P/NS50P: US,CND,MX)**

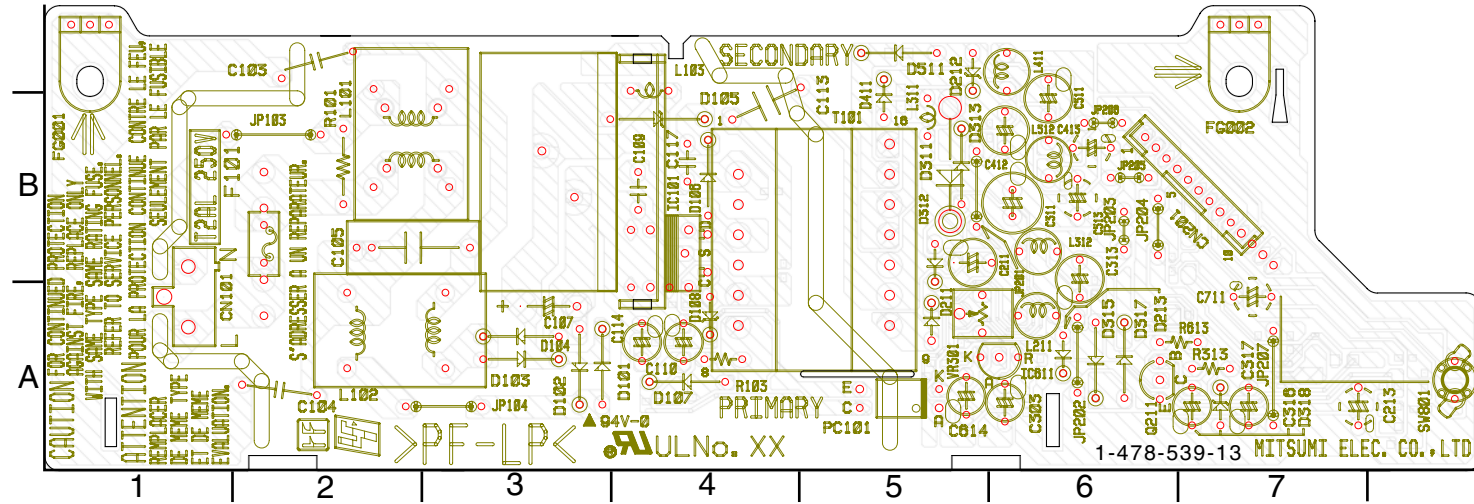

For printed wiring board

There are a few cases that the part printed on this diagram isn't mounted in this model.

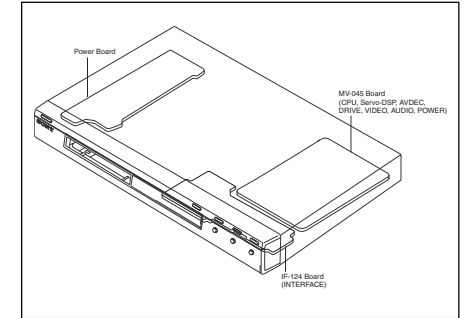

**POWERBOARD  
(SRV1501WW)**

**SIDE A**

- IC101 B-4
- IC611 A-6
- Q211 A-6
- D101 A-4
- D102 A-3
- D103 A-3
- D104 A-3
- D105 B-4
- D106 B-4
- D107 A-4
- D108 A-4
- D211 A-5
- D212 C-5
- D213 A-6
- D311 B-5
- D312 B-5
- D313 B-5
- D315 A-6
- D317 A-6
- D318 A-7
- D411 B-5
- D511 C-5

**SIDE B**

- Q311 A-1
- Q611 A-2
- Q712 A-1

**POWER BOARD (SRV1501WW) (SIDE B)  
(EXCEPT NS41P/NS50P: US,CND,MX)**

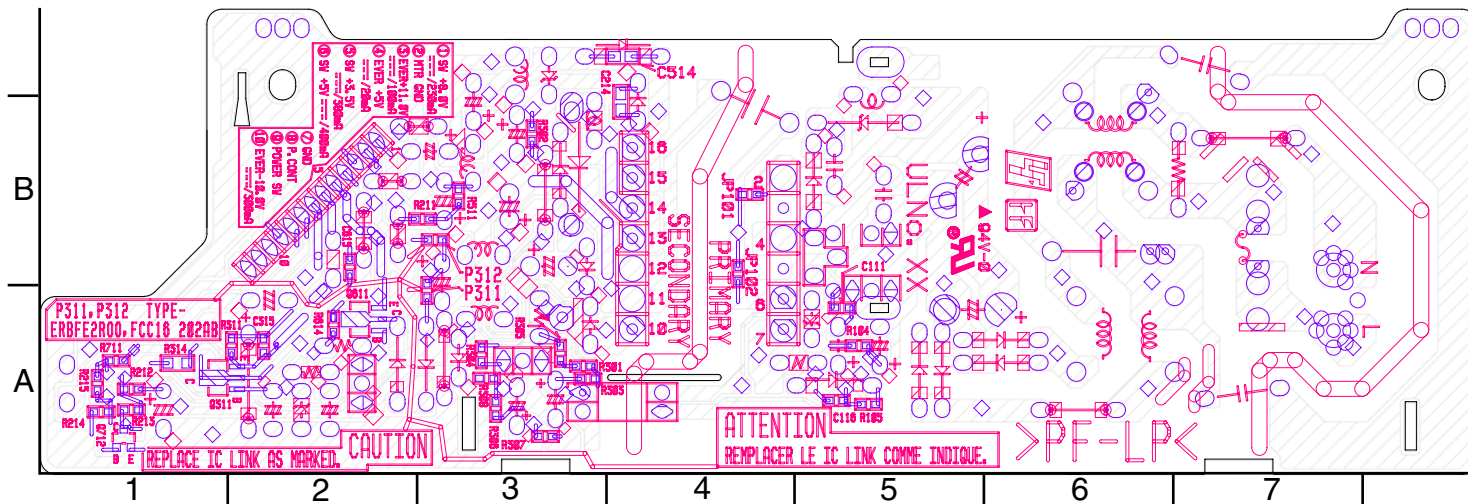

**For Schematic Diagram**

• Refer to page 4-25 for printed wiring board of Power Board.

1 | 2 | 3 | 4 | 5 | 6 | 7 | 8 | 9 | 10 | 11 | 12 | 13 | 14 | 15

**POWER BOARD**  
**POWER BLOCK (SRV1501WW)**  
**(NS52P/EXCEPT (NS41P/NS50P: US,CND,MX))**  
 -REF.NO.:1000 SERIES-  
 XX MARK:NO MOUNT  
  
 NO MARK:PB MODE  
 MARKED:MOUNT TABLE

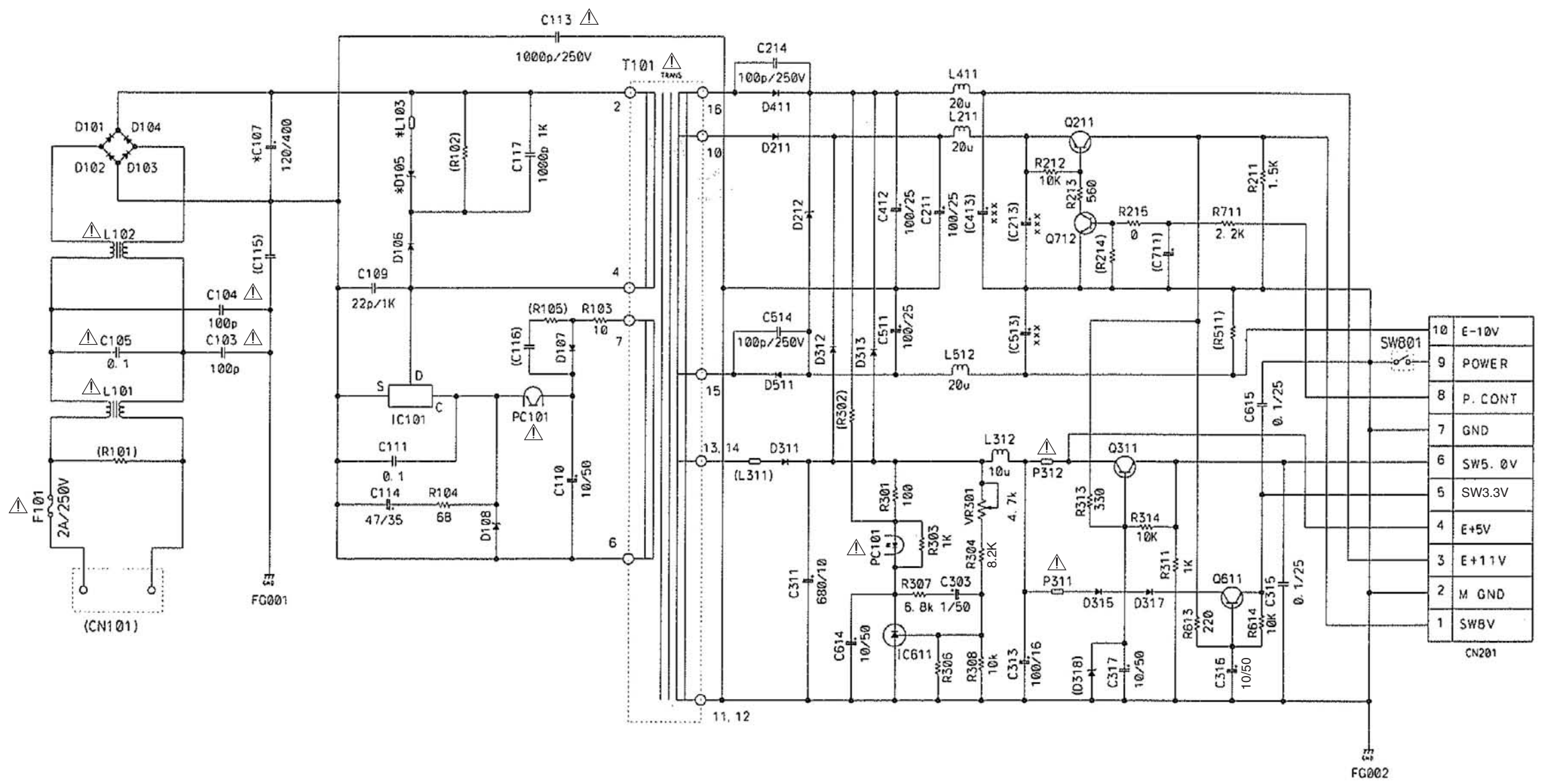

The components identified by mark $\Delta$ or dotted line with mark $\Delta$ are critical for safety. Replace only with part number specified.	Les composants identifiés par une marque $\Delta$ sont critiques pour la sécurité. Ne les remplacer que par une pièce portant le numéro spécifié.
--	---



## SECTION 5 IC PIN FUNCTION DESCRIPTION

### 5-1. SYSTEM CONTROL PIN FUNCTION (MV-045 BOARD IC101)

Pin No.	Pin name	Type	Function
1	AGND		Ground pin for analog circuitry
2	DVDA	Analog Input	AC coupled input path A
3	DVDB	Analog Input	AC coupled input path B
4	DVDC	Analog Input	AC coupled input path C
5	DVDD	Analog Input	AC coupled input path D
6	DVDRFIP	Analog Input	AC coupled DVD RF signal input RFIP
7	DVDRFIN	Analog Input	AC coupled DVD RF signal input RFIN
8	MA	Analog Input	DC coupled main-beam RF signal input A
9	MB	Analog Input	DC coupled main-beam RF signal input B
10	MC	Analog Input	DC coupled main-beam RF signal input C
11	MD	Analog Input	DC coupled main-beam RF signal input D
12	SA	Analog Input	DC coupled sub-beam RF signal input A
13	SB	Analog Input	DC coupled sub-beam RF signal input B
14	SC	Analog Input	DC coupled sub-beam RF signal input C
15	SD	Analog Input	DC coupled sub-beam RF signal input D
16	SDFON	Analog Input	CD focusing error negative input
17	SDFOP	Analog Input	CD focusing error positive input
18	TNI	Analog Input	3 beam satellite PD signal negative input
19	TPI	Analog Input	3 beam satellite PD signal positive input
20	MDI1	Analog Input	Laser power monitor input
21	MDI2	Analog Input	Laser power monitor input
22	LDO2	Analog Output	Laser driver output
23	LDO1	Analog Output	Laser driver output
24	SVDD3	Power	Analog 3.3V power
25	CSO	Analog Output	Central servo
26	RFLVL	Analog Output	RFRP low pass output
27	SGND	Ground	Ground pin for analog circuitry
28	V2REFO	Analog Output	Reference voltage 2.8V
29	V20	Analog Output	Reference voltage 2.0V
30	VREFO	Analog Output	Reference voltage 1.4V
31	FEO	Analog Output	Focus error monitor output
32	TEO	Analog Output	Tracking error monitor output
33	TEZISLV	Analog Output	TE Slicing Level
34	OP_OUT	Analog Output	OP amp output
35	OP_INN	Analog Input	OP amp negative input
36	OP_INP	Analog Input	OP amp positive input
37	DMO	Analog Output	Disc motor control output. PWM output
38	FMO	Analog Output	Feed motor control. PWM output
39	TROPENPWM	Analog Output	Tray PWM output/Tray open output
40	IOPMON	Analog Input	General A/D input -> IOP Monitor
41	TRO	Analog Output	PDM output of tracking servo compensator
42	FOO	Analog Output	PDM output of focus servo compensator
43	USB_VSS	Ground	Ground pin for USB
44	NC		Not used
45	NC		Not used
46	USB_VDD3	Power Input LVTTTL	3.3V power pin for USB
47	SPFG	3.3 V, SMT,PU	General A/D input -> Iop Monitor
48	MSW	Analog Output	Laser Mode SW(H:DVD, L:CD)
49	CKSW	Analog Input	Disc chucking SW sensor



# DVP-NS50P/NS41P/NS52P

Pin No.	Pin name	Type	Function
50	OCSW	Input	Servo GPIO 1
51	EEWP	Output	EEPROM write Protect Control
52	DVDD18	Power	1.8V power pin for internal digital circuitry
53	HA2	Output PU	Host address bit2
54	HA3	Output PU	Host address bit3
55	HA4	Output PU	Host address bit4
56	HA5	Output PU	Host address bit5
57	HA6	Output PU	Host address bit6
58	HA7	Output PU	Host address bit7
59	HA8	Output PU	Host address bit8
60	HA18	Output SMT	Host address bit18
61	HA19	Output SMT	Host address bit19
62	DVSS	Ground	Ground pin for internal digital circuitry
63	APLLCAP	Analog Input	APLL External Capacitance connection
64	APLLVSS	Ground	Ground pin for audio clock circuitry
65	APLLVDD3	Power	3.3V power for audio clock circuitry
66	xWR	Output SMT	Write enable, active Low
67	HA16	Output	Host address bit16
68	HA15	Output PU	Host address bit15
69	HA14	Output PU	Host address bit14
70	HA13	Output PU	Host address bit13
71	HA12	Output PU	Host address bit12
72	HA11	Output PU	Host address bit11
73	DVDD3	Power	3.3V power pin for internal digital circuitry
74	HA10	Output PU	Host address bit10
75	HA9	Output PU	Host address bit9
76	HA20	Output SMT	Host address bit20
77	xROMCS	Output PU, SMT	Chip select, active Low
78	HA1	Output PU	Host address bit1
79	xRD	Output SMT	Read enable, active Low
80	DVDD3	Power	3.3V power pin for internal digital circuitry
81	HD0	Output	Host data bit0
82	HD1	Output	Host data bit1
83	HD2	Output	Host data bit2
84	HD3	Output	Host data bit3
85	DVSS	Ground	Ground pin for internal digital circuitry
86	HD4	Output	Host data bit4
87	HD5	Output	Host data bit5
88	HD6	Output	Host data bit6
89	HA21	Output SMT	Host data bit21
90	ALE	Output PU,SMT	Address latch enable
91	HD7	Output	Host data bit7
92	HA17	Output	Host address bit17
93	HA0	Output PU	Host address bit0
94	DVSS	Ground	Ground pin for internal digital circuitry
95	UWR#	Output PU,SMT	8032 write strobe
96	URD#	Output PU,SMT	8032 read strobe
97	DVDD18	Power Output PU,SMT	1.8V power pin for internal digital circuitry
98	IFSDO	Default High Output PU,SMT	Ext. CPU Serial data output (H/W method)
99	IFCK	Default High Output PU,SMT	Ext. CPU Serial clock (H/W method)
100	xIFCS	Default High	Chip select for Ext.CPU (Low Active, H/W method)

Pin No.	Pin name	Type	Function
101	IFSDI	Input SMT Output PU,SMT	Ext. CPV Serial data Input
102	SCL	Default High Output PU,SMT	IIC clock pin
103	SDA	Default High Output PU,SMT	IIC data pin
104	TRG_SW	Default High	Not Used
105	IFBSY	Int PU,SMT	Ext. CPU Ready/Busy interrupt signal (H: Busy, L: Ready)
106	RXD	Input PU,SMT Output PU,SMT	Hardwired RS232C RXD
107	TXD	Default High	Hardwired RS232C TXD
108	DVDD3	Power	3.3V power pin for internal digital circuitry
109	ICE	Output PU,SMT	Ice mode enable
110	xSYSRST	Input PU,SMT	MT1389 reset input, active Low
111	IR	Input SMT	IR control signal input
112	INT0#	Input PU,SMT	8032 external interrupt 0 (for ICE)
113	DQM0	Output Output Default	Mask for DRAM input/output byte 0
114	LIMIT SW	Low	Inlimit SW sensor input signal
115	RD7	Output	DRAM data bit7
116	DVSS	Ground	Ground pin for internal digital circuitry
117	RD6	Output	DRAM data bit6
118	RD5	Output	DRAM data bit5
119	DVSS	Ground	Ground pin for internal digital circuitry
120	RD4	Output	DRAM data bit4
121	RD3	Output	DRAM data bit3
122	DVDD18	Power	1.8V power pin for internal digital circuitry
123	RD2	Output	DRAM data bit2
124	RD1	Output	DRAM data bit1
125	RD0	Output	DRAM data bit0
126	RD15	Output	DRAM data bit15
127	DVDD3	Power	3.3V power pin for internal digital circuitry
128	RD14	Output	DRAM data bit14
129	RD13	Output	DRAM data bit13
130	RD12	Output	DRAM data bit12
131	RD11	Output	DRAM data bit11
132	RD10	Output	DRAM data bit10
133	RD9	Output	DRAM data bit9
134	DVSS	Ground	Ground pin for internal circuitry
135	RD8	Output Output Default	DRAM data bit8
136	RGBSEL	Low	RGB select signal select output signal (H:RGB Disable, L:RGB)
137	DQM1	Output	Mask for DRAM input/output byte 1
138	RWE#	Output	DRAM write enable
139	CAS#	Output	DRAM column address strobe
140	RAS#	Output	DRAM row address strobe
141	DVDD3	Power	3.3V power pin for internal digital circuitry
142	RCS#	Output	DRAM chip select
143	BA0	Output	DRAM bank address 0
144	DVSS	Ground	Ground pin for internal digital circuitry
145	BA1	Output	DRAM bank address 1
146	RA10	Output	DRAM address bit10
147	RA0	Output	DRAM address bit0
148	DVSS	Ground	Ground pin for internal digital circuitry
149	RA1	Output	DRAM address bit1

# DVP-NS50P/NS41P/NS52P

Pin No.	Pin name	Type	Function
150	RA2	Output	DRAM address bit2
151	RA3	Output	DRAM address bit3
152	DVDD18	Power	1.8V power pin for internal digital circuitry
153	NC		Not Used
154	NC		Not Used
155	DVDD3	Power	3.3V power pin for internal digital circuitry
156	DRCLK	Output	DRAM clock
157	CKE	Output	DRAM clock enable
158	RA11	Output PD	DRAM address bit11
159	RA9	Output	DRAM address bit9
160	RA8	Output	DRAM address bit8
161	DVSS	Ground	Ground pin for internal digital circuitry
162	RA7	Output	DRAM address bit7
163	DVSS	Ground	Ground pin for internal digital circuitry
164	RA6	Output	DRAM address bit6
165	RA5	Output	DRAM address bit5
166	RA4	Output	DRAM address bit4
167	DVDD3	Power	3.3V power pin for internal digital circuitry
168	FWD	Output PD	Roading control signal (Forward)
169	REV	Output PU	Roading control signal (Reverse)
170	MUTE123	Output PD	Servo driver MUTE signal
171	NC		Not Used
172	NC		Not Used
173	DVDD18	Power Output Default	1.8V power pin for internal digital circuitry
174	MUTE	Output PD	Servo driver MUTE signal
175	NC		Not Used
176	XMAMUTE	Default LOW	Main Audio Mute Signal (H: Unmute, L: Mute)
177	DSEL	Output	Interlace/Prog select output signal (H: 480i, L:480P)
178	TSD_M	Input PU	SERVO GPIO 3
179	EUROVY	Output PU	CVBS/S terminal select output signal (H: CBVS, L: S-Terminal)
180	NC		Not Used
181	NC		Not Used
182	DVDD3	Power	3.3V power pin for internal digital circuitry
183	NC		Not Used
184	NC		Not Used
185	NC		Not Used
186	NC		Not Used
187	NC		Not Used
188	NC		Not Used
189	DACVDDC	Power	3.3V power for Video DAC circuitry
190	VREF	Analog Input	Bandgap Ref Voltage (No connect)
191	FS	Analog Input	Full Scale Adjustment
192	CIN	Output	Video data output bit0 (No connect)
193	DACVSSC	Ground	Ground pin for Video DAC circuitry
194	Y	Output	Analog Y output
195	DACVDDB	Power	3.3V power for Video DAC circuitry
196	C	Output	Analog chroma output
197	DACVSSB	Ground	Ground pin for Video DAC circuitry
198	CVBS	Output	Analog composit output
199	DACVDDA	Power	3.3V power for Video DAC circuitry
200	Y/G	Output	Green signal or Y signal output
201	DACVSSA	Ground	Ground pin for Video DAC circuitry
202	B/Cb/Pb	Output	Blue signal or Cb signal output

Pin No.	Pin name	Type	Function
203	R/Cr/Pr	Output	Red signal or Cr signal output
204	DVDD3	Power	3.3V power pin for Video DAC digital circuitry
205	MIC	Input SMT	Karaoke Microphone detect signal
206	VOICE	Output SMT	Karaoke voice function (not used)
207	KRMOD	Output SMT Output Default	Karaoke Mode Status Output (H: Normal, L: Karaoke)
208	SCK	Output	ADAC Serial Clock
209	WIDE	Output Output Default	Video aspect ratio control SW
210	SDO	Output	ADAC Serial data output
211	xSCS	Output	ADAC CS (Chip select) output
212	DVDD3	Power	3.3V power pin for internal digital circuitry
213	ALRCK	Output PD,SMT	Audio left/right channel clock (ADAC LRCK output)
214	ABCK	Output	Audio Bit Clock output (ADAC BCK output)
215	ACLK	Output	Master clock output for Audio DAC (ADAC CLK Master clock output)
216	DVSS	Ground	Ground pin for internal digital circuitry
217	ASDATA0	Output	Not used
218	ASDATA1	Output	Not used
219	ASDATA2	Output	Not used
220	xRST	Default Low	Reset output signal for ADAC (Low Active)
221	DVDD18	Power	1.8V power pin for internal digital circuitry
222	ASDATA4	Output PD,SMT	Audio serial data
223	DVSS	Ground	Ground pin for internal digital circuitry
224	Disc/xEXT	Input	Video aspect ratio control for Euro connection (H: 16:9, L: 4:3)
225	SPDIF	Output	SPDIF output
226	RFGND18	Ground	Ground pin for internal analog circuitry
227	RFVDD18	Power	1.8V power pin for internal analog circuitry
228	XTALO	Output	27M crystal output
229	XTALI	Input	27M crystal input
230	JITFO	Analog Output	The output terminal of RF jitter
231	JITFN	Analog Input	The input terminal of RF jitter
232	PLLVSS	Ground	Ground pin for data PLL and related analog circuitry
233	IDACEXP	Analog Output	Data PLL DAC Low-pass filter
234	PLLVDD3	Power	3.3V power pin for data PLL and related analog circuitry
235	LPFON	Analog Output	The negative output terminal of loop filter amplifier
236	LPFIP	Analog Input	The positive input terminal of loop filter amplifier
237	LPFIN	Analog Input	The negative input of loop filter amplifier
238	LPFOP	Analog Output	The positive output of loop filter amplifier
239	ADCVDD3	Power	Power pin for ADC circuitry
240	NC		Not Used
241	ADCVSS	Ground	Ground pin for ADC circuitry
242	NC		Not Used
243	NC		Not Used
244	RFVDD3	Power	3.3V power pin for RF digital circuitry
245	RFRPDC	Analog Output	RF ripple detect output
246	RFRPAC	Analog Input	RF ripple detect input (through AC-coupling)
247	HRFZC	Analog Input	High frequency RF ripple zero crossing capacitor connecting
248	CRTPLP	Analog Output	Defect level filter capacitor connecting
249	RFGND	Ground	Ground pin for RF digital circuitry
250	NC		Not used
251	NC		Not used
252	OSP	Analog Output	RF Offset cancellation capacitor connecting
253	OSN	Analog Output	RF Offset cancellation capacitor connecting
254	RFGC	Analog Output	RF AGC loop capacitor connecting for DVD-ROM

**DVP-NS50P/NS41P/NS52P**

<b>Pin No.</b>	<b>Pin name</b>	<b>Type</b>	<b>Function</b>
255	IREF	Analog Input	Input reference current input
256	AVDD3	Power	3.3V power pin for analog circuitry

## SECTION 6 TEST MODE

### 6-1. EXECUTING IOP MEASUREMENT

In order to execute IOP measurement, the following standard procedures must be followed.

- (1) In standby mode, press **[TOP MENU]**, **[CLEAR]**, **[POWER]** to enter Remocon Diagnosis Mode.

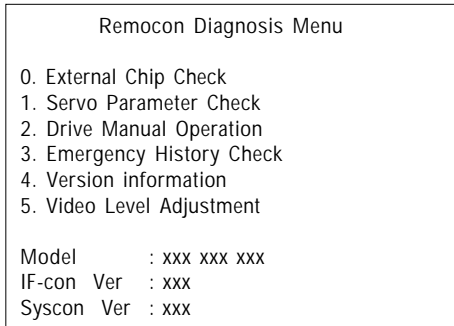

- (2) Select "2. Drive Manual Operation" by pressing the **[2]** key on the remote commander. The screen will appear as below.

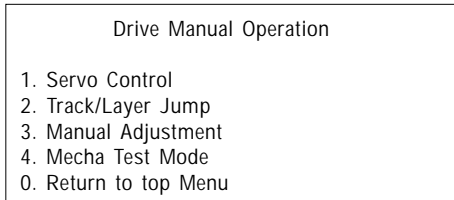

- (3) Select "3. Manual Adjustment" by pressing the **[3]** key on the remote commander. The screen will appear as below.

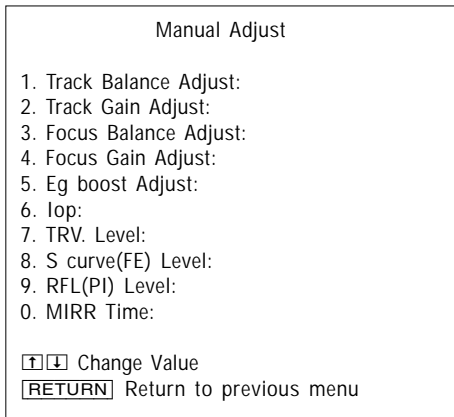

- (4) Select Iop by pressing **[6]** key on the remote commander.

- (5) Wait until a hexadecimal number appear.

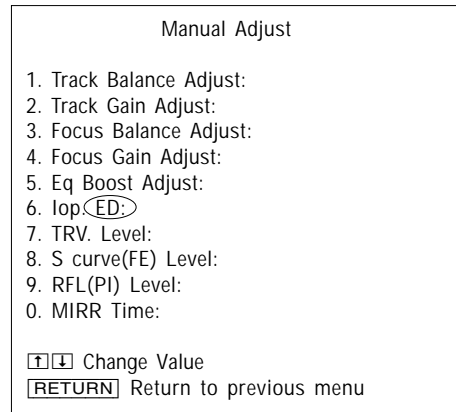

- (6) Convert data from hexadecimal to decimal.

- (7) Use the following formula to calculate IOP in mA  
 $IOP (mA) = IOP (decimal) \times 0.622678$ .

- (8) Press **[RETURN]** to return back to previous menu.

- (9) Press **[0]** to return to Top Menu and power OFF the DVD Player.

### 6-2. EMERGENCY HISTORY CHECK

Information of Emergency History.

- (1) In standby mode, press **[TOP MENU]**, **[CLEAR]**, **[POWER]** to enter Remocon Diagnosis Mode.

- (2) Select "3. Emergency History".

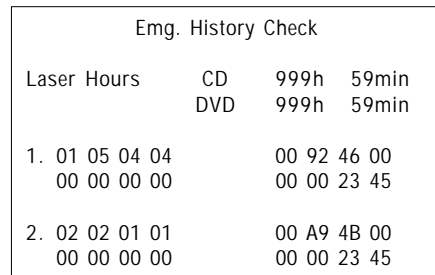

**[Next]** Next Page **[Prev]** Prev Page

- (3) Laser Hours  
 DVD Laser ON time. (Total ON time)  
 CD Laser ON time. (Total ON time)

- (4) Emergency History  
 The history information from last "1" to "10" can be scrolled with **[NEXT]** key or **[PREV]** key.

- (5) Error code

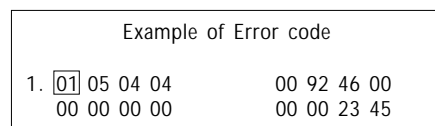

- (6) Error code list  
 01: Communication error (No reply from syscon)  
 02: Syscon hung up  
 03: Power OFF request when syscon hung up  
 19: Thermal shutdown  
 24: MoveSledHome error  
 25: Mecha move error (5 Changer)  
 26: Mecha move stack error  
 30: DC Motor adjustment error  
 31: DPD offset adjustment error  
 32: TE Balance adjustment error  
 33: TE Sensor adjustment error  
 34: TE loop gain adjustment error  
 35: FE loop gain adjustment error  
 36: Bad jitter after adjustment  
 40: Focus NG  
 42: Focus Layer Jump NG  
 52: Open kick spindle error  
 51: Spindle stop error  
 60: Focus on error  
 61: Seek fail error  
 62: read Qdata/ID error  
 70: Lead In Data Read Fail  
 71: TOC read time out (CD)  
 80: Can't Buffering  
 81: Unknown media type

- (7) Error code parameters

Example of Error code			
1.	01	05 04 04	00 92 46 00
		00 00 00 00	00 00 23 45

This is the detailed contents of error information

- (8) Laser hours at error happend.

Example of Error code			
1.	01	05 04 04	00 92 46 00
		00 00 00 00	00 00 23 45

This is Laser hours when an error happened.

- (9) How to Clear laser hours  
 Press **[DISPLAY]**, **[CLEAR]** keys in this order.  
 Both CD and DVD data are cleared.

Emg. History Check			
Laser Hours	CD	999h	59min
	DVD	999h	59min
1.	01 05 04 04	00 92 46 00	
	00 00 00 00	00 00 23 45	
2.	02 02 01 01	00 A9 4B 00	
	00 00 00 00	00 00 23 45	
<b>[Next]</b> Next Page <b>[Prev]</b> Prev Page			
<b>[0]</b> Return to Top Menu			

- (10) How to Clearing Emergency code  
 Press **[TOPMENU]**, **[CLEAR]** keys in this order.  
 All emergency code are cleared.

Emg. History Check			
Laser Hours	CD	999h	59min
	DVD	999h	59min
1.	00 00 00 00	00 00 00 00	
	00 00 00 00	00 00 00 00	
2.	00 00 00 00	00 00 00 00	
	00 00 00 00	00 00 00 00	
<b>[Next]</b> Next Page <b>[Prev]</b> Prev Page			

- (11) Press **[0]** key, return to TOP MENU.

### 6-3. INITIALIZING SETUP DATA

How to initializing setup data.

- (1) In standby mode, press **[TOP MENU]**, **[CLEAR]**, **[POWER]** to enter Remocon Diagnosis Mode.

- (2) Select "3. Emergency History".

Emg. History Check			
Laser Hours	CD	999h	59min
	DVD	999h	59min
1.	01 05 04 04	00 92 46 00	
	00 00 00 00	00 00 23 45	
2.	02 02 01 01	00 A9 4B 00	
	00 00 00 00	00 00 23 45	
<b>[Next]</b> Next Page <b>[Prev]</b> Prev Page			

- (3) Initializing setup data  
 Press **[MENU]**, **[CLEAR]** keys in this order.  
 The data have been initialized when "Initialize setup data..." message is displayed.

Emg. History Check			
Laser Hours	CD	999h	59min
	DVD	999h	59min
Initialize setup data ...			
<b>[Next]</b> Next Page <b>[Prev]</b> Prev Page			

- (4) The Emergency history display screen will be restored soon.

Emg. History Check			
Laser Hours	CD	999h	59min
	DVD	999h	59min
1. 01 05 04 04		00 92 46 00	
00 00 00 00		00 00 23 45	
2. 02 02 01 01		00 A9 4B 00	
00 00 00 00		00 00 23 45	

[Next] Next Page [Prev] Prev Page

- (12) Press **0** key, return to TOP MENU.

## 6-4. VERSION INFORMATION

Information of firmware version.

- (1) In standby mode, press **TOP MENU**, **CLEAR**, **POWER** to enter Remocon Diagnosis Mode.
- (2) Select "4. Version Information".

Version information	
Firm (Main)	: Ver. xxxxx
Firm (Sub)	: xxxxx
RISC	: xxxxx
8032	: xxxxx
Audio DSP	: xxxxx
Servo DSP	: xxxxx

**0** Return to Top Menu

- (3) Press **0** key, return to TOP MENU.

## 6-5. IF CON SELF DIAGNOSTIC FUNCTION

### 1. IF-124 BOARD (IF CON) TEXT MODE

The IF-124 board (IF CON) test mode is the IF CON self-diagnosis mode. The IF CON can diagnose the functions of the IF-124 board that the IF CON controls. Normally, the IF CON makes a serial communication with the SYSTEM CONTROL and operates following the commands from the SYSTEM CONTROL, but in the Test mode, the IF CON operates independently from the SYSTEM CONTROL.

In the test mode, the following functions can be checked.

1. Button function
2. Remote commander receiving function
3. SYSTEM CONTROL-IF CON serial communication
4. Fluorescent display tube lighting check
  - Grid check
  - Anode check
5. LED control function

In the test mode, the main unit operates same as usual, except voltage monitoring, communication, display of fluorescent display tube, and LED control.

1. The routine that monitors +3.3V (PCONT) of MV-045 board is not provided.
2. The monitoring timer for serial communication with the SYSTEM CONTROL is not provided. The main unit is not placed in the Standby mode, even if the communication with SYSTEM CONTROL is normal.
3. Display of fluorescent display tube.  
(Normally, display is mode following the commands from SYSTEM CONTROL).
4. LED control.  
(Normally, control is mode made following the commands from SYSTEM CONTROL).

### 2. OPERATION OF SELF CHECK MODE

The Self Check mode is the function to conduct the basic test to the FL display and DVD panel section.

#### 2-1. Self Check Mode Transition Processing

At the AC Power ON after reset of IF CON is released, while pressing with the MV-045 board are not connected to the IF-124 board, or while pressing the **■** key on the main unit with the IF CON in STANDBY mode, enter **RETURN** → **DISPLAY** (or **SETUP**) on the remote commander, and the main unit transits to the Self Check Mode.



**2-2. Operation of Auto Self Check**

When the Self Check mode becomes active at the AC Power ON or by key input, the test display of the following steps (1) to (4) is repeated.

(1) FLD and LED all ON (for 10 seconds)

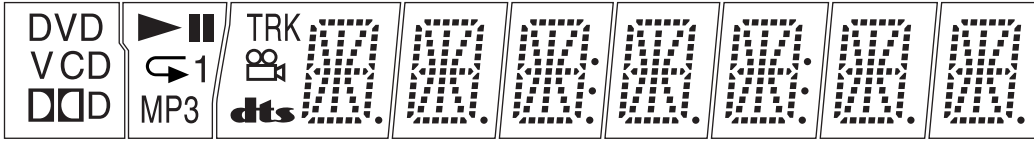

(2) MODEL display (for 1 seconds) (NS41P/NS50P)

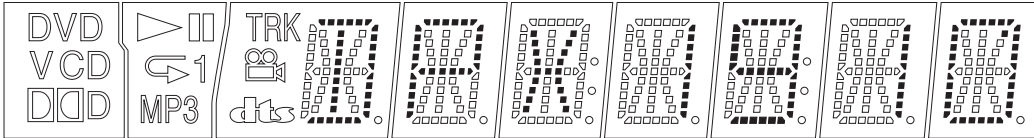

MODEL display (for 1 seconds) (NS52P only)

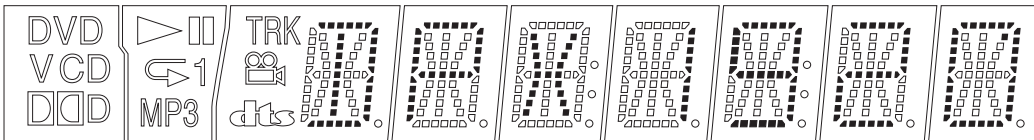

(3) Version display (for 1 seconds)

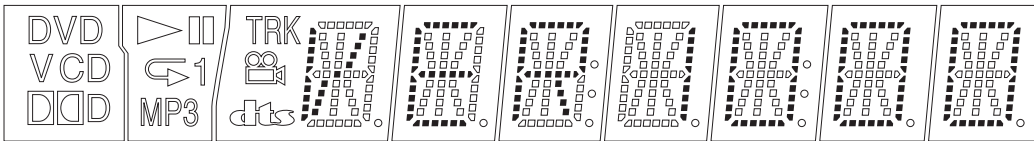

(4) ROM creation date display (for 1 seconds)

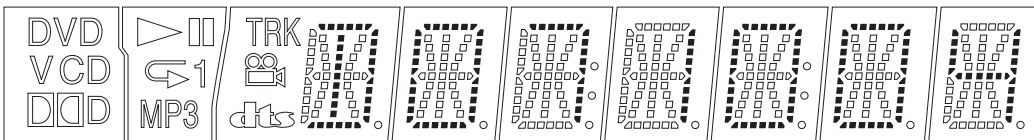



**2-3. Each Self Check Function**

Each Self Check function tests the FLD display, LED display, and key input.

Input Voltage [V]	IC404: Pin No. (Signal)			
	PIN ④ (AD1)	PIN ⑤ (O/C)	PIN ⑥ (STOP)	PIN ⑦
0 - 0.20	PLAY	OPEN/CLOSE	STOP	POWER
0.60 - 0.82	PAUSE	-	PROGRESSIVE	-
1.16 - 1.47	PREVIOUS	-	-	-
1.80 - 2.12	NEXT	-	-	-
2.48 - 2.70	-	-	-	-

**2-3-1. FLD and LED All ON**

**2-3-1-1. Transition Keys in Self Check Mode**

-  key and  key on the main unit
-  key on the remote commander

**2-3-1-2. Operation and display**

In this mode, all LEDs and all segments of FLD turn ON.

- Example of FLD all ON

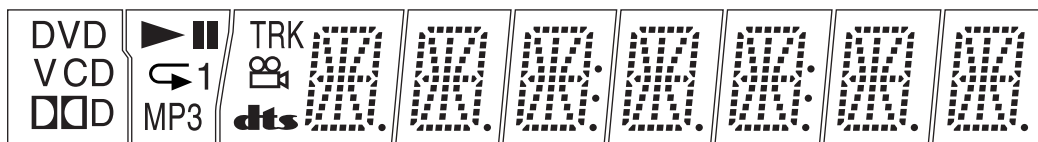

**2-3-2. Main Unit Key Name Display and Key Code Display**

**2-3-2-1. Transition Keys in Self Check Mode**

- Keys on the main unit except keys transited in Self Check Mode

**2-3-2-2. Operation and Display**

When a key on the main unit is pressed in the Self Check mode, the name of that key is displayed on the FLD. Also, the key name display and the key code display can be switched with the **DISPLAY** key on the remote commander, "NOTHING" is displayed when nothing is entered. Also, DVD, V, CD segments turn on when a communication error occurred.

- FLD display (at input of  key on the main unit)

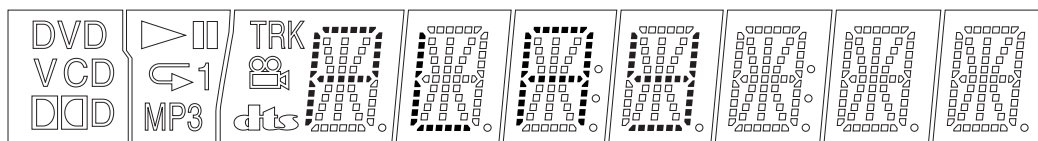

- Key code display  
(at input of  key, key code: 0Ah)

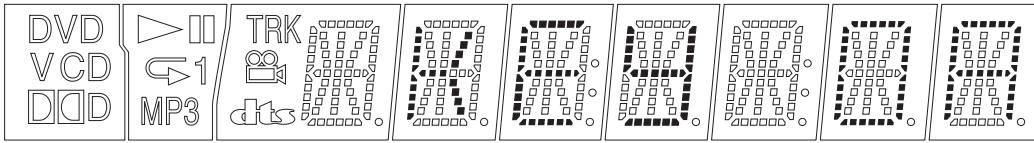

- At input of faulty voltage

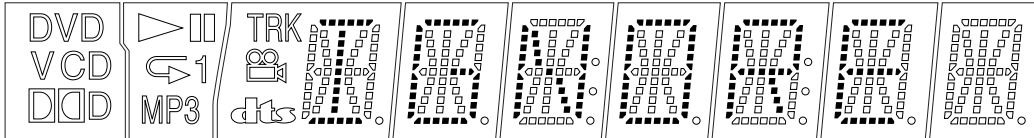

- When key is pressed double

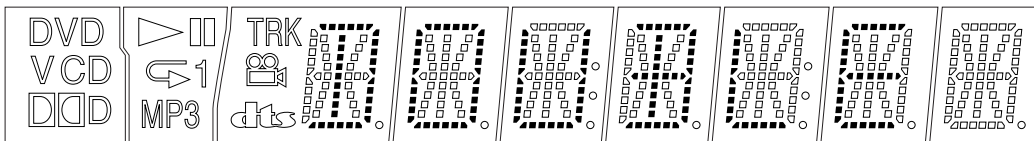

### 2-3-3. Remote Commander Key Name Display and Key Code Display

#### 2-3-3-1. Transition Keys in Self Check Mode

- Remote commander keys except keys transitioned in Self Check Mode

#### 2-3-3-2. Operation and Display

When a key on the remote commander is pressed in the Self Check Mode, the name of that key is displayed on the FLD. Also, the key name display and the key code display can be switched with the **[DISPLAY]** key on the remote commander. "NOTHING" is displayed when nothing is entered. Also, VIDEO CD, DVD, and CD segments turn on when a communication error occurred.

- Remote commander key name display (at input of  key)

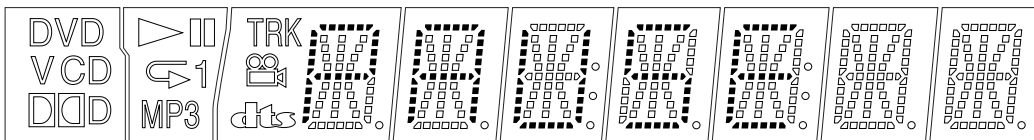

- Remote commander key code display (at input of  key, key code:39h)

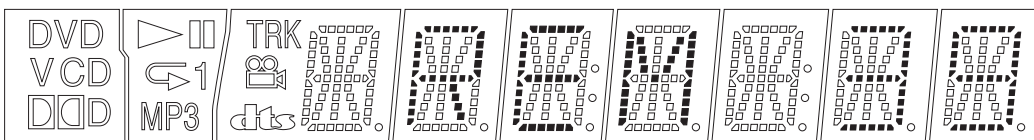

### 2-3-4. Communication Monitoring Display

The communication state is monitored and displayed while the key name on the main unit and the remote commander is displayed. When the communication to the System Controller failed, VIDEO CD, DVD, and CD segments turn on.

- Communication error display (at no input of key and remote commander)

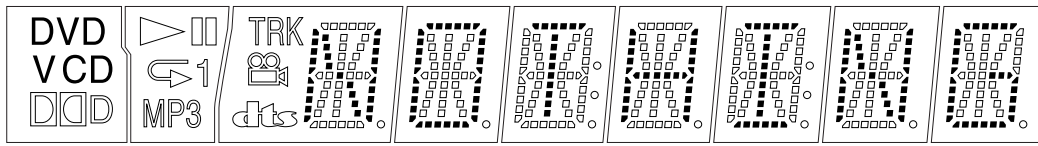

- Communication error display (at code display without input of the remote commander)

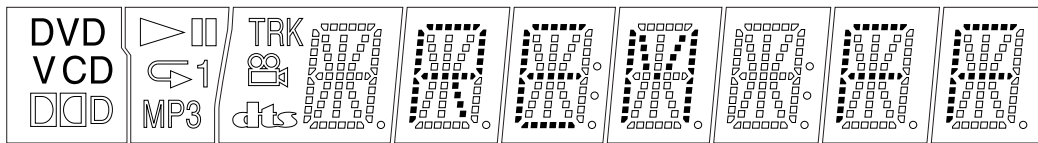

### 2-3-5. FLD Anode Test Display and SHUTTLE Click Operation Test

#### 2-3-5-1. Transition Keys in Self Check Mode

- key on the remote commander
- SHUTTLE on the remote commander during Anode Test display (This unit does not provide JOG/SHUTTLE, and therefore use another DVD remote commander having the JOG/SHUTTLE)

#### 2-3-5-2. Operation and Display

The Self Check Mode transits to this mode when key is entered. This tests whether each segment turns on individually. Only the first segment of each grid of FLD turns on, and each time the SHUTTLE is entered, the segment of each grid switched in order. When SHUTTLE input is clockwise, the segment switches in 1 - 2 - 3 direction, or counterclockwise it switches in 3 - 2 - 1 direction.

- Display at the start of Anode Test

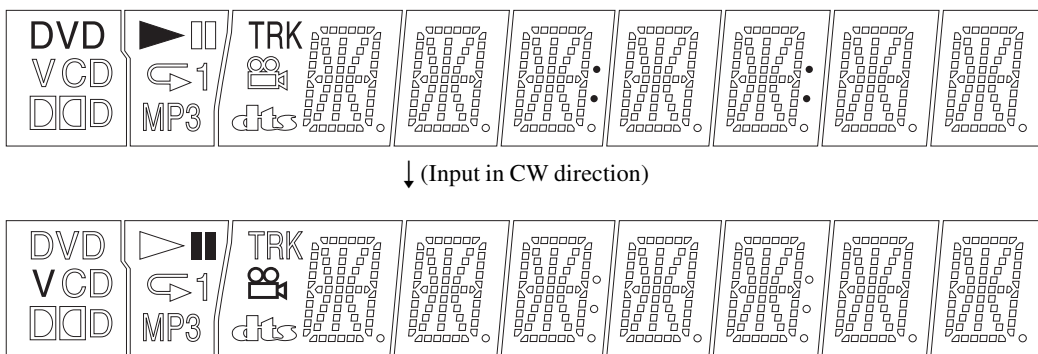

**2-3-6. FLD Grid Test Display and SHUTTLE Click Operation Test**

**2-3-6-1. Transition Keys in Self Check Mode**

- key on the remote commander
- SHUTTLE on the remote commander during Grid Test display  
(This unit does not provide JOG/SHUTTLE, and therefore use another DVD remote commander having the JOG/SHUTTLE)

**2-3-6-2. Operation and Display**

The Self Check Mode transits to this mode when key is entered. This tests whether each grid turns on individually. The first grid only of FLD turns on and other grid turn off. Each time the SHUTTLE is entered, the grid is switched in order. When SHUTTLE input is clockwise, the grid switched in 1 - 2 - 3 direction, or counterclockwise it switches in 3 - 2 - 1 direction.

• **Display at the start of Grid Test**

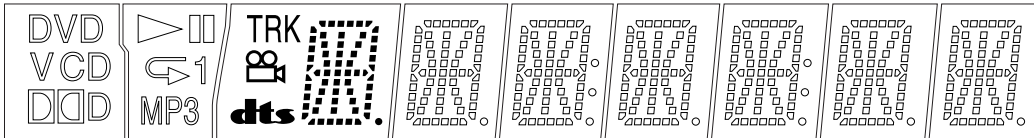

↓ (Input in CW direction)

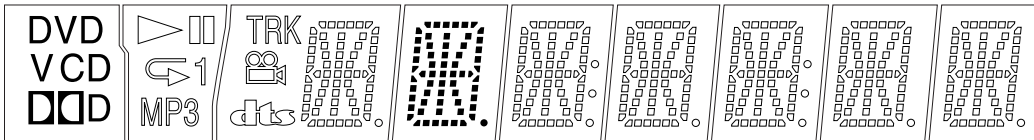

**2-3-7. LED Test Display**

**2-3-7-1. Transition Keys in Self Check Mode**

- key on the remote commander
- SHUTTLE on the remote commander during Grid Test display  
(This model does not provide JOG/SHUTTLE, and therefore use another DVD remote commander having the JOG/SHUTTLE)

**2-3-7-2. Operation and Display**

LED is switched in order by the input JOG/SHUTTLE on the remote commander. Also, LED ON/OFF is switched by the input of same key as the function that turns on the LED concerned.

• **FLD display during LED Test**

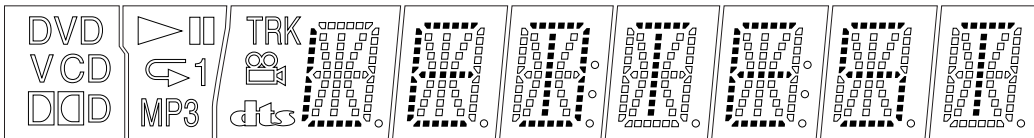

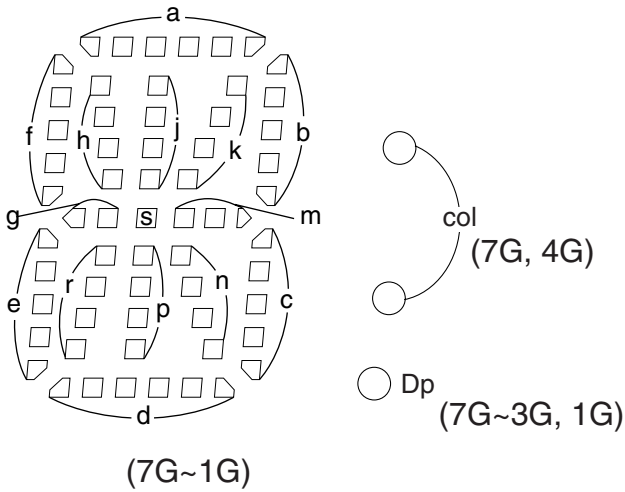
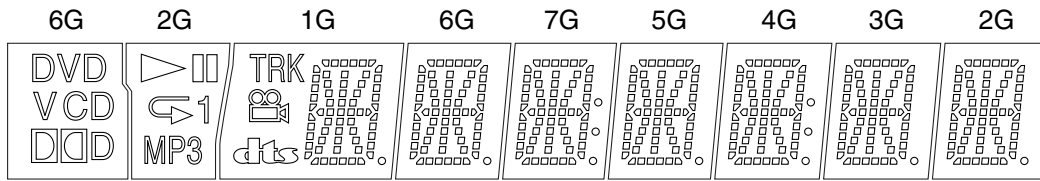

ANODE CONNECTION

	7G	6G	5G	4G	3G	2G	1G
P1	col	DVD	-	col	-	▶	TRK
P2	-	V	-	-	-	⏸	📹
P3	-	CD	-	-	-	↶	dts
P4	-	DDD	-	-	-	1	-
P5	Dp	Dp	Dp	Dp	Dp	MP3	Dp
P6	a	a	a	a	a	a	a
P7	k	k	k	k	k	k	k
P8	j	j	j	j	j	j	j
P9	h	h	h	h	h	h	h
P10	b	b	b	b	b	b	b
P11	f	f	f	f	f	f	f
P12	m	m	m	m	m	m	m
P13	s	s	s	s	s	s	s
P14	g	g	g	g	g	g	g
P15	c	c	c	c	c	c	c
P16	d	d	d	d	d	d	d
P17	r	r	r	r	r	r	r
P18	p	p	p	p	p	p	p
P19	n	n	n	n	n	n	n
P20	e	e	e	e	e	e	e

MEMO

## SECTION 7 ELECTRICAL ADJUSTMENT

This section describes procedures and instructions necessary for adjusting electrical circuits in this unit.

### Instruments required:

- 1) Color monitor TV
- 2) Oscilloscope 1 or 2 phenomena, band width over 100 MHz, with delay mode
- 3) Frequency counter (over 8 digits)
- 4) Digital multimeter
- 5) Standard commander (RMT-175A and RMT-175P)
- 6) DVD reference disc  
HLX-501 (J-6090-071-A) (dual layer) (NTSC)  
HLX-503 (J-6090-069-A) (single layer) (NTSC)  
HLX-504 (J-6090-088-A) (single layer) (NTSC)  
HLX-505 (J-6090-089-A) (dual layer) (NTSC)
- 7) SACD reference disc  
HLXA-509 (J-6090-090-A)

### 7-1. POWER SUPPLY OUTPUT VOLTAGE CHECK

Mode	Except standby
Instrument	Digital multimeter
EVER +5 V Check	
Test point	CN201 pin ④
Specification	$5.0 \pm 0.3$ Vdc
SW +3.3 V Check	
Test point	CN201 pin ⑤
Specification	$3.35 \pm 0.2$ Vdc
SW+5 V Check	
Test point	CN201 pin ⑥
Specification	$5.0 \pm \begin{matrix} +0.3 \\ -0.2 \end{matrix}$ Vdc
SW +8 V Check	
Test point	CN201 pin ①
Specification	$8.0 \pm 0.5$ Vdc
EVER +11 V Check	
Test point	CN201 pin ③
Specification	$11.0 \pm \begin{matrix} +1.0 \\ -0.5 \end{matrix}$ Vdc
EVER -10 V Check	
Test point	CN201 pin ⑩
Specification	$-10.0 \pm \begin{matrix} +0.5 \\ -1.0 \end{matrix}$ Vdc

#### Checking method:

- 1) Confirm that each voltage satisfies the specification.

#### Caution!

Please do not touch any electrical parts at primary circuit to avoid electrical shock.



**7-2. ADJUSTMENT OF VIDEO SYSTEM**

**1. Checking Video Level**

**<Purpose>**

Checking Video Level the NTSC/PAL standard, and if not correct, the brightness will be too large or small.

Mode	HLX-504 play back
Signal	Color bars 100%
Test point	LINE OUT (VIDEO) connector (75 Ω terminated)
Instrument	Oscilloscope
Specification	$1.0 \pm 0.08$ Vp-p

**Adjusting method:**

- 1) In the Video Signal menu “1” Color Bar 100% play back.
- 2) Confirm that the Video Level is  $1.0 \pm 0.08$  Vp-p.

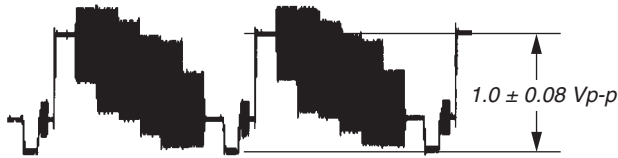

Fig. 7-1.

**2. Checking Progressive Video Output Level**

**<Purpose>**

Check progressive video output level. If it is incorrect, correct brightness will not be attained when connected to, for instance, projector.

Mode	HLX-504 play back
Signal	Color bars 100%
Test point	COMPONENT VIDEO OUT (Y) connector (75 Ω terminated)
Instrument	Oscilloscope
Specification	$1.0 \pm 0.08$ Vp-p

**Adjusting method:**

- 1) In the Video Signal menu “1” Color Bar 100% play back.
- 2) Confirm that the Y level is  $1.0 \pm 0.08$  Vp-p.



Fig. 7-2.

**3. Checking S Video Output S-Y**

**<Purpose>**

Check S-terminal video output. If it is incorrect, pictures will not be displayed correctly in spite of connection to the TV with a S-terminal cable.

Mode	HLX-504 play back
Signal	Color bars 100%
Test point	S VIDEO OUT (S-Y) connector (75 Ω terminated)
Instrument	Oscilloscope
Specification	$1.0 \pm 0.08$ Vp-p

**Checking method:**

- 1) In the Video Signal menu “1” Color Bar 100% play back.
- 2) Confirm that the S-Y level is  $1.0 \pm 0.08$  Vp-p.

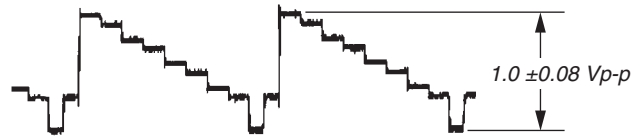

Fig. 7-3.

**4. Checking S Video Output S-C**

**<Purpose>**

This checks whether the S-C satisfies the NTSC/PAL standard. If it is not correct, the colors will be too dark or light.

Mode	HLX-504 play back
Signal	Color bars 100%
Test point	S VIDEO OUT (S-C) connector (75 Ω terminated)
Instrument	Oscilloscope
Specification	A = $286 \pm 30$ mVp-p (NTSC) A = $300 \pm 100$ mVp-p (PAL)

**Checking method:**

- 1) In the Video Signal menu “1” Color Bar 100% play back.
- 2) Confirm that the S-C burst is “A”.

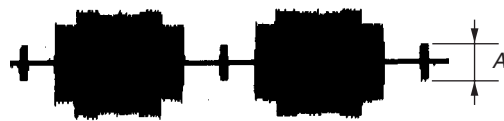

Fig. 7-4.

### 5. Checking Component Video Output Y

**<Purpose>**

This checks component video output Y. If it is incorrect, correct brightness will not be attained when connected to, for instance, projector.

Mode	HLX-504 play back
Signal	Color bars
Test point	COMPONENT VIDEO OUT (Y) connector, (75 Ω terminated)
Instrument	Oscilloscope
Specification	$1.0 \pm 0.08$ Vp-p

**Checking method:**

- 1) In the Video Signal menu “1” Color Bar 100% play back.
- 2) Confirm that the Y level is  $1.0 \pm 0.08$  Vp-p.



Fig. 7-5.

### 7. Checking Component Video Output R-Y

**<Purpose>**

This checks component video output R-Y. If it is incorrect, correct colors will not be displayed when connected to, for instance, projector.

Mode	HLX-504 play back
Signal	Color bars
Test point	COMPONENT VIDEO OUT (Pr) connector (75 Ω terminated)
Instrument	Oscilloscope
Specification	$B = 700 \pm 70$ mVp-p

**Checking method:**

- 1) In the Video Signal menu “1” Color Bar 100% play back.
- 2) Confirm that the R-Y level is B.



Fig. 7-7.

### 6. Checking Component Video Output B-Y

**<Purpose>**

This checks component video output B-Y. If it is incorrect, correct colors will not be displayed when connected to, for instance, projector.

Mode	HLX-504 play back
Signal	Color bars
Test point	COMPONENT VIDEO OUT (P <sub>B</sub> ) connector (75 Ω terminated)
Instrument	Oscilloscope
Specification	$A = 700 \pm 70$ mVp-p

**Checking method:**

- 1) In the Video Signal menu “1” Color Bar 100% play back.
- 2) Confirm that the B-Y level is A.

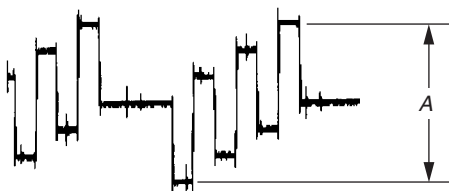

Fig. 7-6.

MEMO



# DVP-NS50P/NS41P/NS52P

Ref. No.	Part No.	Description	Remark
1	3-088-344-33	CASE, UPPER	(BLACK)
1	2-583-730-11	CASE, UPPER	(SILVER)
2	3-070-883-31	SCREW, TAPPING	(BLACK)
2	3-070-883-41	SCREW, TAPPING	(SILVER)
3	3-077-331-11	+BV3 (3-CR)	
4	3-077-331-21	+BV3 (3-CR)	
5	2-188-091-01	COVER,TRAY (NS41P/NS50P:US,CND,PX,AUS(BLACK),EA(BLACK))	
5	2-188-091-11	COVER,TRAY (NS50P:MX,E,ME,EA(SILVER), IN,MY,IR,AUS(SILVER),HK,SP,TW,KR)	
5	2-342-142-02	COVER,TRAY (NS52P)	
6	3-088-489-01	INSULATOR, PS	
△7	1-828-450-11	POWER-SUPPLY CORD (NS50P:ME,SP,IR, EA,E,PX,VN,IN,MY/NS52P:ME2,SP)	
△7	1-828-454-11	POWER-SUPPLY CORD (NS50P:HK)	
△7	1-828-451-11	POWER-SUPPLY CORD (NS41P/NS50P:US,CND,MX)	
△7	1-828-871-11	POWER-SUPPLY CORD (NS50P:KR/NS52P:KR)	
△7	1-828-452-11	POWER-SUPPLY CORD (NS50P:AUS/NS52P:AUS)	
△7	1-828-845-11	POWER-SUPPLY CORD (NS50P:TW/NS52P:TW)	
8	3-071-119-91	COVER BATTERY	
9	1-479-179-11	REMOTE COMMANDER (RMT-D175A) (NS41P/NS50P:US,CND,KR,TW,PX,MX,E/ NS52P:KR,TW)	
9	1-479-179-21	REMOTE COMMANDER (RMT-D175P) (NS50P:AUS,ME,SP,EA,HK,IR,VN, IN,MY/ NS52P:AUS,ME2,SP)	
10	X-2023-827-1	PANEL ASSY, FRONT (NS50P:US,CND)(BLACK)	
10	X-2023-828-1	PANEL ASSY, FRONT(NS50P:US,CND,PX) (SILVER)	
10	X-2048-747-1	PANEL ASSY, FRONT (NS50P:MX,E,ME,IR, AUS,HK,SP,TW,EA,KR,IN,MY) (SILVER)	
10	X-2048-754-2	PANEL ASSY, FRONT (NS50P:VN)(BLACK)	
10	X-2048-746-2	PANEL ASSY, FRONT (NS50P:EA,AUS)(BLACK)	
10	X-2048-752-1	PANEL ASSY, FRONT (NS41P) (SILVER)	
10	X-2024-684-1	PANEL ASSY, FRONT (NS52P) (SILVER)	
12	A-1116-423-A	MV-045(1914SM-MX2) COMPLETE (NS50P:MX)	
12	A-1112-982-A	MV-045(1914SZ-VN3) COMPLETE (NS50P:VN)	
12	A-1097-432-A	MV-045(1910-U2) COMPLETE (NS41P/NS50P:US,CND,PX)	
12	A-1097-472-A	MV-045 (1914-E32)COMPLETE (NS50P:E)	
12	A-1097-476-A	MV-045 (1914-AU2)COMPLETE (NS50P:AUS)	
12	A-1097-479-A	MV-045 (1914-EA4)COMPLETE(NS50P:EA,IR,ME2)	
12	A-1097-481-A	MV-045 (1914-SP6)COMPLETE (NS50P:HK,KR,TW,SP,MY)	
12	A-1097-485-A	MV-045 (1914-ME5)COMPLETE (NS50P:ME5,IN)	
12	A-1097-546-A	MV-045 (1925-SP6)COMPLETE (NS52P:SP,KR,TW)	
12	A-1097-550-A	MV-045 (1925-ME2)COMPLETE (NS52P:ME2)	
12	A-1097-552-A	MV-045 (1925-AU2)COMPLETE (NS52P:AUS)	
13	1-830-282-12	FLEXIBLE FLAT CABLE (FMD-004)	
14	1-830-283-11	FLEXIBLE FLAT CABLE (FMS-003)	
△15	1-478-538-12	POWER SUPPLY BLOCK (NS41P/NS50P:US,CND,MX)	
△15	1-478-539-13	POWER SUPPLY BLOCK (EXCEPT NS41P/NS50P:US,CND,MX)	
16	3-071-200-11	TAPE (BU) (NS41P/NS50P:US,CND,PX)	

**Note :**  
The components identified by mark △ or dotted line with mark △ are critical for safety.  
Replace only with part number specified.

**Note :**  
Les composants identifiés par une marque △ sont critiques pour la sécurité.  
Ne les remplacer que par une pièce portant le numéro spécifié.

**8-1-2. MECHANISM DECK ASSEMBLY**

ns : not supplied

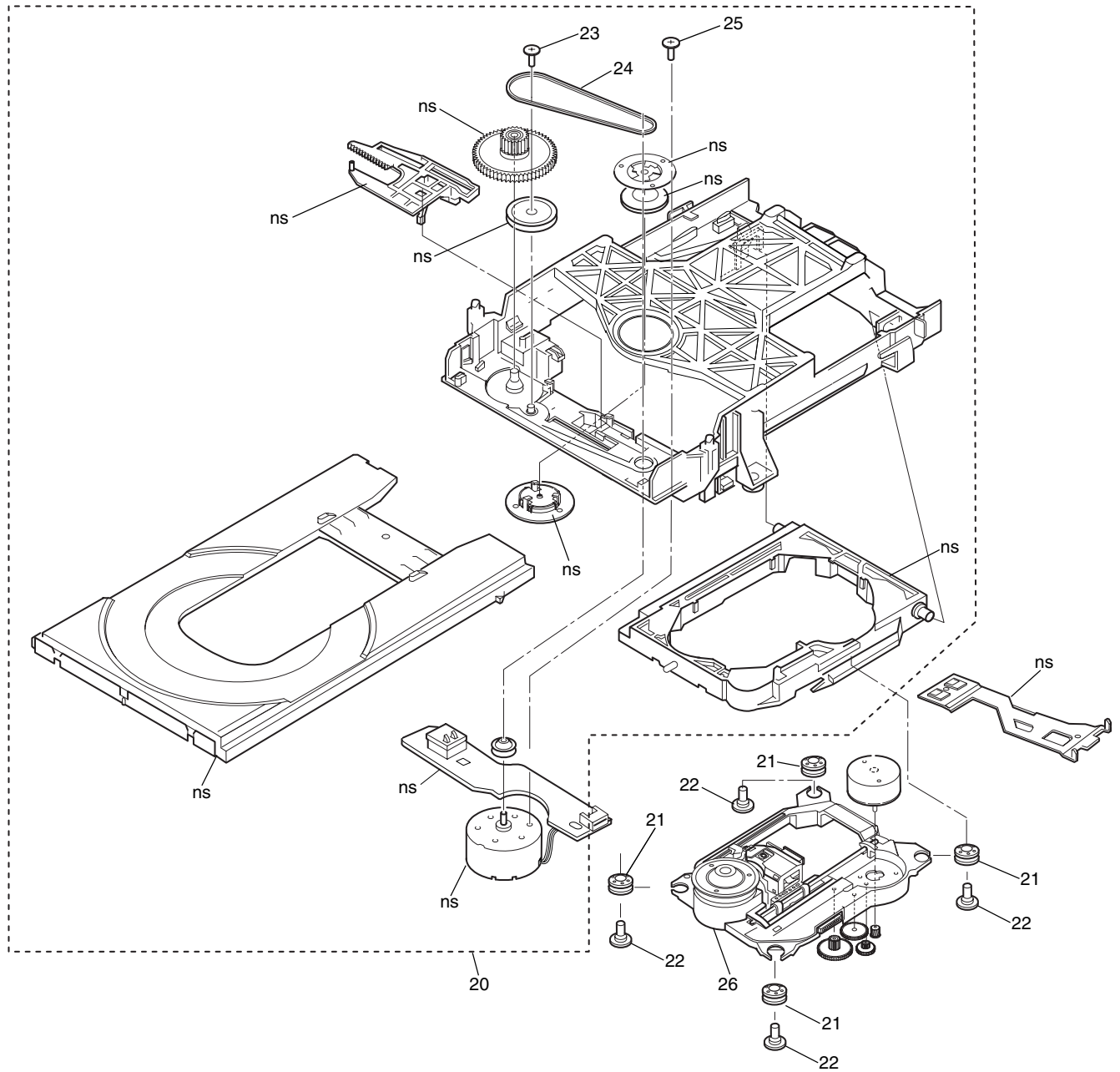

Ref. No.	Part No.	Description	Remark
20	A-6071-669-A	LOADING ASSY (M)	
21	3-088-372-01	INSULATOR	
22	3-087-599-01	INSULATOR SCREW	
23	4-674-137-11	SCREW (PTP2x5)	
24	3-088-371-01	BELT	
25	4-974-725-11	SCREW (M1.7x2.5), P	
26	8-820-290-02	DEVICE, OPTICAL KHM-310CAA/C2RP	

**IF-124**

**8-2. ELECTRICAL PARTS LIST**

**NOTE:**

- Due to standardization, replacements in the parts list may be different from the parts specified in the diagrams or the components used on the set.
- -XX and -X mean standardized parts, so they may have some difference from the original one.
- **RESISTORS**  
All resistors are in ohms.  
METAL: Metal-film resistor.  
METAL OXIDE: Metal oxide-film resistor.  
F: nonflammable
- Not all of the parts for POWER BLOCK (HS12S2U) are listed.
- Items marked "\*" are not stocked since they are seldom required for routine service.  
Some delay should be anticipated when ordering these items.

- **SEMICONDUCTORS**  
In each case, u:  $\mu$ , for example:  
uA. . :  $\mu$ A. . uPA. . :  $\mu$ PA. .  
uPB. . :  $\mu$ PB. . uPC. . :  $\mu$ PC. .  
uPD. . :  $\mu$ PD. .
- **CAPACITORS**  
uF:  $\mu$ F
- **COILS**  
uH:  $\mu$ H
- **Abbreviation**  
MY : Malaysia Model  
CND : Canadian Model  
MX : Mexican Model  
PX : PX Model  
E : Latin America Model  
ME5 : IND, PAK, MAR Model  
EA : Saudi Arabia Model  
IN : India

- IR : Iran Model
- ME2 : Middle East
- AUS : Australia/NZ Model
- HK : Hong Kong Model
- SP : Singapore Model
- TW : Taiwan Model
- KR : Korean Model

The components identified by mark  $\Delta$  or dotted line with mark  $\Delta$  are critical for safety. Replace only with part number specified.

Les composants identifiés par une marque  $\Delta$  sont critiques pour la sécurité. Ne les remplacer que par une pièce portant le numéro spécifié.

When indicating parts by reference number, please include the board.

Ref. No.	Part No.	Description	Remark	Ref. No.	Part No.	Description	Remark
		IF-124 BOARD *****		IC407	6-702-302-01	IC TK1133CSCL-G	
				IC408	6-704-114-01	IC S-80828CNUA-B8NT2G	
		<CAPACITOR>				<CONDUCTOR CHIP>	
C401	1-163-021-91	CERAMIC CHIP	0.01UF 10.00% 50V	JR401	1-216-295-91	SHORT CHIP	0
C403	1-163-021-91	CERAMIC CHIP	0.01UF 10.00% 50V	JR402	1-216-295-91	SHORT CHIP	0
C404	1-163-021-91	CERAMIC CHIP	0.01UF 10.00% 50V	JR403	1-216-295-91	SHORT CHIP	0
C405	1-163-021-91	CERAMIC CHIP	0.01UF 10.00% 50V	JR404	1-216-295-91	SHORT CHIP	0
C406	1-163-009-91	CERAMIC CHIP	0.001UF 10.00% 50V	JR405	1-216-295-91	SHORT CHIP	0
C407	1-126-947-11	ELECT	47UF 20.00% 35V	JR406	1-216-295-91	SHORT CHIP	0
C408	1-163-021-91	CERAMIC CHIP	0.01UF 10.00% 50V	JR407	1-216-295-91	SHORT CHIP	0
C409	1-104-666-11	ELECT	220UF 20.00% 25V	JR408	1-216-295-91	SHORT CHIP	0
C410	1-130-481-00	MYLAR	0.0068UF 5.00% 50V	JR409	1-216-295-91	SHORT CHIP	0
C411	1-115-339-11	CERAMIC CHIP	0.1UF 10.00% 50V	JR411	1-216-295-91	SHORT CHIP	0
C412	1-126-965-91	ELECT	22UF 20.00% 50V	JR412	1-216-295-91	SHORT CHIP	0
C413	1-115-339-11	CERAMIC CHIP	0.1UF 10.00% 50V	JR413	1-216-295-91	SHORT CHIP	0
C414	1-163-021-91	CERAMIC CHIP	0.01UF 10.00% 50V	JR414	1-216-295-91	SHORT CHIP	0
C416	1-164-489-11	CERAMIC CHIP	0.22UF 10.00% 16V	JR417	1-216-295-91	SHORT CHIP	0
C417	1-164-489-11	CERAMIC CHIP	0.22UF 10.00% 16V	JS401	1-216-295-91	SHORT CHIP	0 (EXCEPT NS52P)
		<DIODE>		JS402	1-216-295-91	SHORT CHIP	0 (NS52P)
D401	6-501-147-01	DIODE LTL-1MHAЕ-112A (EXCEPT NS52P)		JS407	1-216-295-91	SHORT CHIP	0 (NS52P)
D402	8-719-041-97	DIODE MA113-(TX)				<INDUCTOR>	
D403	8-719-041-97	DIODE MA113-(TX)		L401	1-408-982-11	INDUCTOR	100UH
D404	8-719-041-97	DIODE MA113-(TX)				<FLUORESCENT>	
D405	8-719-041-97	DIODE MA113-(TX)		ND401	1-519-795-11	VACUUM FLUORESCENT DISPLAY	
D406	8-719-422-32	DIODE MA8047-M-TX				<TRANSISTOR>	
D407	6-501-147-01	DIODE LTL-1MHAЕ-112A (NS52P)		Q401	8-729-106-68	TRANSISTOR 2SD874A-R-TX	
		<TERMINAL>		Q402	8-729-106-68	TRANSISTOR 2SD874A-R-TX	
* ET401	1-537-738-21	TERMINAL, EARTH				<RESISTOR>	
* ET402	1-537-738-21	TERMINAL, EARTH		R401	1-216-073-91	RES-CHIP	10K 5% 1/10W
		<IC>		R402	1-216-073-91	RES-CHIP	10K 5% 1/10W
IC404	6-805-304-01	IC 86CK74AFG-6A77 (M)					
IC406	6-705-738-01	IC RPM7240-H13					





## MV-045

Ref. No.	Part No.	Description	Remark			Ref. No.	Part No.	Description	Remark		
C118	1-126-964-11	ELECT	10UF	20.00%	50V	C193	1-127-715-91	CERAMIC CHIP	0.22UF	10%	16V
C119	1-126-964-11	ELECT	10UF	20.00%	50V	C195	1-127-715-91	CERAMIC CHIP	0.22UF	10%	16V
C120	1-165-908-11	CERAMIC CHIP	1UF	10%	10V	C197	1-107-826-11	CERAMIC CHIP	0.1UF	10.00%	16V
C121	1-165-908-11	CERAMIC CHIP	1UF	10%	10V	C199	1-162-968-11	CERAMIC CHIP	0.0047UF	10.00%	50V
C122	1-165-908-11	CERAMIC CHIP	1UF	10%	10V	C203	1-162-970-11	CERAMIC CHIP	0.01UF	10.00%	25V
C123	1-165-908-11	CERAMIC CHIP	1UF	10%	10V	C205	1-164-230-11	CERAMIC CHIP	220PF	5.00%	50V
C124	1-165-908-11	CERAMIC CHIP	1UF	10%	10V	C206	1-164-230-11	CERAMIC CHIP	220PF	5.00%	50V
C125	1-107-826-11	CERAMIC CHIP	0.1UF	10.00%	16V	C208	1-162-970-11	CERAMIC CHIP	0.01UF	10.00%	25V
C126	1-107-826-11	CERAMIC CHIP	0.1UF	10.00%	16V	C209	1-164-677-11	CERAMIC CHIP	0.033UF	10.00%	16V
C127	1-162-970-11	CERAMIC CHIP	0.01UF	10.00%	25V	C210	1-162-970-11	CERAMIC CHIP	0.01UF	10.00%	25V
C128	1-162-965-11	CERAMIC CHIP	0.0015UF	10.00%	50V	C211	1-164-677-11	CERAMIC CHIP	0.033UF	10.00%	16V
C130	1-107-826-11	CERAMIC CHIP	0.1UF	10.00%	16V	C212	1-162-970-11	CERAMIC CHIP	0.01UF	10.00%	25V
C131	1-125-889-91	CERAMIC CHIP	2.2UF	10%	10V	C213	1-162-970-11	CERAMIC CHIP	0.01UF	10.00%	25V
C132	1-107-826-11	CERAMIC CHIP	0.1UF	10.00%	16V	C214	1-162-964-11	CERAMIC CHIP	0.001UF	10.00%	50V
C133	1-107-826-11	CERAMIC CHIP	0.1UF	10.00%	16V	C216	1-107-826-11	CERAMIC CHIP	0.1UF	10.00%	16V
C135	1-164-677-11	CERAMIC CHIP	0.033UF	10.00%	16V	C217	1-126-947-11	ELECT	47UF	20.00%	35V
C136	1-162-970-11	CERAMIC CHIP	0.01UF	10.00%	25V	C218	1-126-964-11	ELECT	10UF	20.00%	50V
C137	1-107-826-11	CERAMIC CHIP	0.1UF	10.00%	16V	C219	1-162-970-11	CERAMIC CHIP	0.01UF	10.00%	25V
C138	1-162-964-11	CERAMIC CHIP	0.001UF	10.00%	50V	C220	1-126-964-11	ELECT	10UF	20.00%	50V
C139	1-162-919-11	CERAMIC CHIP	22PF	5.00%	50V	C221	1-107-826-11	CERAMIC CHIP	0.1UF	10.00%	16V
C140	1-107-826-11	CERAMIC CHIP	0.1UF	10.00%	16V	C222	1-107-826-11	CERAMIC CHIP	0.1UF	10.00%	16V
C144	1-162-970-11	CERAMIC CHIP	0.01UF	10.00%	25V	C223	1-107-826-11	CERAMIC CHIP	0.1UF	10.00%	16V
C146	1-107-826-11	CERAMIC CHIP	0.1UF	10.00%	16V	C224	1-162-970-11	CERAMIC CHIP	0.01UF	10.00%	25V
C147	1-165-176-11	CERAMIC CHIP	0.047UF	10.00%	16V	C225	1-162-964-11	CERAMIC CHIP	0.001UF	10.00%	50V
C148	1-165-176-11	CERAMIC CHIP	0.047UF	10.00%	16V	C226	1-162-964-11	CERAMIC CHIP	0.001UF	10.00%	50V
C149	1-107-826-11	CERAMIC CHIP	0.1UF	10.00%	16V	C228	1-162-968-11	CERAMIC CHIP	0.0047UF	10.00%	50V
C150	1-126-964-11	ELECT	10UF	20.00%	50V	C301	1-107-826-11	CERAMIC CHIP	0.1UF	10.00%	16V
C151	1-162-927-11	CERAMIC CHIP	100PF	5.00%	50V	C310	1-126-786-11	ELECT	47UF	20.00%	16V
C152	1-162-915-11	CERAMIC CHIP (NS50P:US,CND,PX,MX,E/NS41P)	10PF	0.50PF	50V	C311	1-107-826-11	CERAMIC CHIP	0.1UF	10.00%	16V
C153	1-162-917-11	CERAMIC CHIP (NS50P:US,CND,PX,MX,E/NS41P)	15PF	5.00%	50V	C312	1-107-826-11	CERAMIC CHIP	0.1UF	10.00%	16V
C154	1-107-826-11	CERAMIC CHIP	0.1UF	10.00%	16V	C313	1-126-786-11	ELECT	47UF	20.00%	16V
C155	1-162-970-11	CERAMIC CHIP	0.01UF	10.00%	25V	C314	1-107-826-11	CERAMIC CHIP	0.1UF	10.00%	16V
C156	1-162-970-11	CERAMIC CHIP	0.01UF	10.00%	25V	C401	1-164-739-11	CERAMIC CHIP	560PF	5.00%	50V
C158	1-162-970-11	CERAMIC CHIP	0.01UF	10.00%	25V	C402	1-164-739-11	CERAMIC CHIP	560PF	5.00%	50V
C160	1-162-970-11	CERAMIC CHIP	0.01UF	10.00%	25V	C403	1-164-218-11	CERAMIC CHIP	180PF	5.00%	50V
C161	1-162-970-11	CERAMIC CHIP	0.01UF	10.00%	25V	C404	1-164-218-11	CERAMIC CHIP	180PF	5.00%	50V
C162	1-162-970-11	CERAMIC CHIP	0.01UF	10.00%	25V	C405	1-164-218-11	CERAMIC CHIP	180PF	5.00%	50V
C163	1-162-970-11	CERAMIC CHIP	0.01UF	10.00%	25V	C406	1-164-218-11	CERAMIC CHIP	180PF	5.00%	50V
C164	1-162-970-11	CERAMIC CHIP	0.01UF	10.00%	25V	C407	1-162-970-11	CERAMIC CHIP	0.01UF	10.00%	25V
C171	1-162-970-11	CERAMIC CHIP	0.01UF	10.00%	25V	C408	1-162-970-11	CERAMIC CHIP	0.01UF	10.00%	25V
C172	1-162-970-11	CERAMIC CHIP	0.01UF	10.00%	25V	C409	1-126-960-11	ELECT	1UF	20.00%	50V
C174	1-162-970-11	CERAMIC CHIP	0.01UF	10.00%	25V	C410	1-126-947-11	ELECT	47UF	20.00%	35V
C175	1-162-970-11	CERAMIC CHIP	0.01UF	10.00%	25V	C411	1-126-947-11	ELECT	47UF	20.00%	35V
C176	1-162-970-11	CERAMIC CHIP	0.01UF	10.00%	25V	C413	1-126-934-11	ELECT	220UF	20.00%	16V
C177	1-126-947-11	ELECT	47UF	20.00%	35V	C415	1-164-230-11	CERAMIC CHIP	220PF	5.00%	50V
C179	1-107-826-11	CERAMIC CHIP	0.1UF	10.00%	16V	C416	1-164-230-11	CERAMIC CHIP	220PF	5.00%	50V
C180	1-107-826-11	CERAMIC CHIP	0.1UF	10.00%	16V	C422	1-107-826-11	CERAMIC CHIP	0.1UF	10.00%	16V
C181	1-107-826-11	CERAMIC CHIP	0.1UF	10.00%	16V	C425	1-162-970-11	CERAMIC CHIP EXCEPT (NS50P:US,CND,PX,MX,E/NS41P)	0.01UF	10.00%	25V
C182	1-127-715-91	CERAMIC CHIP	0.22UF	10%	16V	C427	1-126-947-11	ELECT EXCEPT (NS50P:US,CND,PX,MX,E/NS41P)	47UF	20.00%	35V
C183	1-128-934-91	CERAMIC CHIP	0.33UF	20%	10V	C428	1-126-964-11	ELECT	10UF	20.00%	50V
C184	1-162-970-11	CERAMIC CHIP	0.01UF	10.00%	25V	C429	1-126-964-11	ELECT	10UF	20.00%	50V
C186	1-127-715-91	CERAMIC CHIP	0.22UF	10%	16V	C432	1-162-964-11	CERAMIC CHIP	0.001UF	10.00%	50V
C187	1-126-947-11	ELECT	47UF	20.00%	35V	C433	1-127-715-91	CERAMIC CHIP	0.22UF	10%	16V
C188	1-165-908-11	CERAMIC CHIP	1UF	10%	10V	C434	1-126-964-11	ELECT	10UF	20.00%	50V
C189	1-107-826-11	CERAMIC CHIP	0.1UF	10.00%	16V	C435	1-162-970-11	CERAMIC CHIP	0.01UF	10.00%	25V
C190	1-126-947-11	ELECT	47UF	20.00%	35V	C444	1-126-947-11	ELECT	47UF	20.00%	35V
C191	1-107-826-11	CERAMIC CHIP	0.1UF	10.00%	16V	C501	1-107-826-11	CERAMIC CHIP	0.1UF	10.00%	16V
C192	1-162-970-11	CERAMIC CHIP	0.01UF	10.00%	25V						

Ref. No.	Part No.	Description	Remark	Ref. No.	Part No.	Description	Remark
C502	1-126-786-11	ELECT	47UF 20.00% 16V	FL501	1-234-177-21	FERRITE	0UH
C503	1-126-786-11	ELECT	47UF 20.00% 16V	FL502	1-234-177-21	FERRITE	0UH
C504	1-126-786-11	ELECT	47UF 20.00% 16V	FL503	1-233-893-21	FILTER, CHIP	EMI
C508	1-107-826-11	CERAMIC CHIP	0.1UF 10.00% 16V	IC101	6-707-535-01	<IC> IC CXD9849R	
C510	1-107-826-11	CERAMIC CHIP	0.1UF 10.00% 16V	IC102	6-806-128-01	IC MR27V1602F-2T8TN (NS41P/NS50P:US,CND,PX,MX)	
C512	1-107-826-11	CERAMIC CHIP	0.1UF 10.00% 16V	IC102	6-805-903-01	IC S99-50068E-9GPD1900U (NS50P:E)	
C513	1-107-826-11	CERAMIC CHIP	0.1UF 10.00% 16V	IC102	6-805-904-01	IC S99-50068E-9GPD1900A (NS50P:HK,SP,TW,KR/NS52P:SP,TW,KR)	
C514	1-126-786-11	ELECT	47UF 20.00% 16V	IC102	6-805-909-01	IC MX26LV160BTC-70G-9GPD1900E (NS50P:AUS,ME,EA,IR/NS52P:ME,AUS)	
		<CONNECTOR>		IC103		(NOTE: SEE PAGE 8-5)	
CN101	1-815-763-32	CONNECTOR, FFC/FPC 24P		IC104	6-707-897-01	IC EDS6416AHTA-75-E	
* CN105	1-564-708-11	PIN, CONNECTOR (SMALL TYPE) 6P		IC105	6-702-302-01	IC TK11133CSCL-G	
* CN201	1-564-708-11	PIN, CONNECTOR (SMALL TYPE) 6P		IC107	6-702-302-01	IC TK11133CSCL-G	
CN202	1-815-381-11	CONNECTOR, FPC/FPC 5P		IC108	6-703-224-01	IC S-80828CANNB-B8NT2G	
* CN501	1-568-937-11	PIN, CONNECTOR 10P		IC110	6-707-739-01	IC MM1661JTRT	
		<DIODE>		IC201	6-704-524-01	IC FAN8036L	
D308	8-719-071-15	DIODE HZM6.8ZWA1TL		IC303	8-759-662-86	IC NJM79M05DL1A(TE2)	
D309	8-719-071-15	DIODE HZM6.8ZWA1TL		IC303	8-759-667-17	IC L79M05TLL-SONY-TL-E	
D401	8-719-050-38	DIODE M1MA152WK-T1		IC304	6-706-453-01	IC NJM2587V(TE2)	
D402	8-719-050-37	DIODE M1MA152WA-T1		IC401	6-707-187-01	IC HA17558AFEL-E	
D404	8-719-404-50	DIODE MA111-TX		IC403	6-706-025-01	IC HA178L05UA-TL-E	
		<FERRITE>		IC405	6-600-430-01	IC TOTX177(F,T) EXCEPT (NS50P:US,CND,PX,MX,E/NS41P)	
* FB106	1-469-670-21	FERRITE	0UH (NS50P:US,CND,PX/NS41P)	IC406	6-707-490-01	IC AK4385ET-E2	
FB106	1-469-324-21	FERRITE	0UH			<IC LINK>	
		EXCEPT (NS50P:US,CND,PX/NS41P)		△PS501	1-576-509-21	IC LINK	1A 50V
FB107	1-469-324-21	FERRITE	0UH	△PS502	1-576-509-21	IC LINK	1A 50V
* FB108	1-469-670-21	FERRITE	0UH (NS50P:US,CND,PX/NS41P)			<TRANSISTOR>	
FB108	1-469-324-21	FERRITE	0UH				
		EXCEPT (NS50P:US,CND,PX/NS41P)		Q101	6-550-008-01	TRANSISTOR UM6K1N-TN	
FB109	1-414-760-21	FERRITE	0UH	Q102	6-550-653-01	TRANSISTOR QST8TR	
FB110	1-414-760-21	FERRITE	0UH	Q103	8-729-424-59	TRANSISTOR UN2212-TX	
* FB111	1-469-670-21	FERRITE	0UH (NS50P:US,CND,PX/NS41P)	Q304	8-729-024-89	TRANSISTOR MUN2213T1	
* FB112	1-469-670-21	FERRITE	0UH (NS50P:US,CND,PX/NS41P)	Q305	8-729-024-83	TRANSISTOR MUN2111T1	
* FB113	1-469-670-21	FERRITE	0UH (NS50P:US,CND,PX/NS41P)	Q401	8-729-010-08	TRANSISTOR MSB710-RT1	
* FB114	1-469-670-21	FERRITE	0UH (NS50P:US,CND,PX/NS41P)	Q402	8-729-024-89	TRANSISTOR MUN2213T1	
* FB115	1-469-670-21	FERRITE	0UH (NS50P:US,CND,PX/NS41P)	Q403	8-729-010-25	TRANSISTOR MSD601-RT1	
FB116	1-469-118-21	FERRITE	0UH (NS50P:US,CND,PX/NS41P)	Q404	8-729-424-70	TRANSISTOR UN2217-QRS-TX	
FB117	1-469-118-21	FERRITE	0UH (NS50P:US,CND,PX/NS41P)	Q405	8-729-010-05	TRANSISTOR MSB709-RT1	
FB118	1-469-118-21	FERRITE	0UH (NS50P:US,CND,PX/NS41P)	Q407	6-550-137-01	TRANSISTOR2SD1938(F)-ST(TX),SO	
FB119	1-469-118-21	FERRITE	0UH (NS50P:US,CND,PX/NS41P)	Q407	6-551-287-01	TRANSISTOR 2SD2704K-T146	
FB122	1-469-128-21	FERRITE	0UH (NS50P:US,CND,PX/NS41P)	Q408	6-550-137-01	TRANSISTOR2SD1938(F)-ST(TX),SO	
FB123	1-414-226-21	FERRITE	0UH (NS50P:US,CND,PX/NS41P)	Q408	6-551-287-01	TRANSISTOR 2SD2704K-T146	
FB124	1-469-128-21	FERRITE	0UH (NS50P:US,CND,PX/NS41P)	Q411	8-729-010-25	TRANSISTOR MSD601-RT1	
FB125	1-414-226-21	FERRITE	0UH (NS50P:US,CND,PX/NS41P)	Q416	8-729-010-05	TRANSISTOR MSB709-RT1	
FB126	1-469-128-21	FERRITE	0UH (NS50P:US,CND,PX/NS41P)	Q501	8-729-014-90	TRANSISTOR 2SD2185R-TX	
* FB401	1-469-670-21	FERRITE	0UH (NS50P:US,CND,PX,MX,E/NS41P)	Q502	8-729-024-86	TRANSISTOR MUN2114T1	
FB501	1-469-324-21	FERRITE	0UH	Q502	8-729-424-24	TRANSISTOR UN2114-TX	
FB502	1-469-324-21	FERRITE	0UH				
FB503	1-469-324-21	FERRITE	0UH				
FB504	1-469-324-21	FERRITE	0UH				
FB505	1-469-324-21	FERRITE	0UH				
FB506	1-469-324-21	FERRITE	0UH				
FL101	1-234-177-21	FERRITE	0UH				
FL105	1-234-177-21	FERRITE	0UH				
		EXCEPT (NS50P:US,CND,PX/NS41P)					

**Note :**  
The components identified by mark △ or dotted line with mark △ are critical for safety. Replace only with part number specified.

MV-045

Ref. No.	Part No.	Description	Remark	Ref. No.	Part No.	Description	Remark
		<RESISTOR>		R175	1-216-864-11	SHORT CHIP	0
R101	1-216-809-11	METAL CHIP	100 5% 1/10W	R189	1-218-827-11	METAL CHIP	150 0.5% 1/10W
R103	1-216-864-11	SHORT CHIP	0	R190	1-218-827-11	METAL CHIP	150 0.5% 1/10W
R106	1-216-833-11	METAL CHIP	10K 5% 1/10W	R191	1-216-821-11	METAL CHIP	1K 5% 1/10W
R107	1-216-833-11	METAL CHIP	10K 5% 1/10W	R192	1-218-827-11	METAL CHIP	150 0.5% 1/10W
R108	1-216-857-11	METAL CHIP	1M 5% 1/10W	R193	1-216-821-11	METAL CHIP	1K 5% 1/10W
R109	1-216-864-11	SHORT CHIP	0	R195	1-218-827-11	METAL CHIP	150 0.5% 1/10W
R110	1-216-841-11	METAL CHIP	47K 5% 1/10W	R197	1-218-827-11	METAL CHIP	150 0.5% 1/10W
R111	1-216-809-11	METAL CHIP	100 5% 1/10W	R204	1-216-822-11	METAL CHIP	1.2K 5% 1/10W
R112	1-211-977-11	METAL CHIP	22 0.5% 1/10W	R205	1-216-833-11	METAL CHIP	10K 5% 1/10W
R113	1-211-977-11	METAL CHIP	22 0.5% 1/10W	R206	1-216-833-11	METAL CHIP	10K 5% 1/10W
R114	1-216-845-11	METAL CHIP	100K 5% 1/10W	R207	1-216-826-11	METAL CHIP	2.7K 5% 1/10W
R115	1-211-977-11	METAL CHIP	22 0.5% 1/10W	R208	1-216-839-11	METAL CHIP	33K 5% 1/10W
R116	1-216-821-11	METAL CHIP	1K 5% 1/10W	R209	1-216-839-11	METAL CHIP	33K 5% 1/10W
R117	1-216-841-11	METAL CHIP	47K 5% 1/10W	R210	1-216-841-11	METAL CHIP	47K 5% 1/10W
R118	1-216-801-11	METAL CHIP	22 5% 1/10W	R212	1-216-833-11	METAL CHIP	10K 5% 1/10W
R119	1-216-295-91	SHORT CHIP	0	R213	1-218-867-11	METAL CHIP	6.8K 0.5% 1/10W
		EXCEPT (NS50P:US,CND.PX/NS41P)		R214	1-216-835-11	METAL CHIP	15K 5% 1/10W
R120	1-216-801-11	METAL CHIP	22 5% 1/10W	R215	1-216-834-11	METAL CHIP	12K 5% 1/10W
R121	1-216-801-11	METAL CHIP	22 5% 1/10W	R216	1-216-834-11	METAL CHIP	12K 5% 1/10W
R123	1-216-864-11	SHORT CHIP	0	R219	1-216-838-11	METAL CHIP	27K 5% 1/10W
R124	1-216-841-11	METAL CHIP	47K 5% 1/10W	R220	1-216-833-11	METAL CHIP	10K 5% 1/10W
R125	1-216-864-11	SHORT CHIP	0	R221	1-218-889-11	METAL CHIP	56K 0.5% 1/10W
		EXCEPT (NS50P:US,CND.PX/NS41P)		R222	1-216-839-11	METAL CHIP	33K 5% 1/10W
R127	1-216-864-11	SHORT CHIP	0	R223	1-218-895-11	METAL CHIP	100K 0.5% 1/10W
R129	1-216-295-91	SHORT CHIP	0	R224	1-216-833-11	METAL CHIP	10K 5% 1/10W
		EXCEPT (NS50P:US,CND.PX/NS41P)		R225	1-218-895-11	METAL CHIP	100K 0.5% 1/10W
R132	1-216-845-11	METAL CHIP	100K 5% 1/10W	R226	1-218-889-11	METAL CHIP	56K 0.5% 1/10W
R134	1-216-864-11	SHORT CHIP	0	R227	1-216-864-11	SHORT CHIP	0
R135	1-216-833-11	METAL CHIP	10K 5% 1/10W	R228	1-216-864-11	SHORT CHIP	0
R136	1-216-835-11	METAL CHIP	15K 5% 1/10W	R230	1-218-893-11	METAL CHIP	82K 0.5% 1/10W
R137	1-216-864-11	SHORT CHIP	0	R231	1-218-875-11	METAL CHIP	15K 0.5% 1/10W
R141	1-216-855-11	METAL CHIP	680K 5% 1/10W	R232	1-218-877-11	METAL CHIP	18K 0.5% 1/10W
R142	1-216-845-11	METAL CHIP	100K 5% 1/10W	R233	1-218-883-11	METAL CHIP	33K 0.5% 1/10W
R143	1-216-864-11	SHORT CHIP	0	R234	1-216-833-11	METAL CHIP	10K 5% 1/10W
		EXCEPT (NS50P:US,CND.PX/NS41P)		R235	1-216-864-11	SHORT CHIP	0
R145	1-216-864-11	SHORT CHIP	0	R236	1-216-821-11	METAL CHIP	1K 5% 1/10W
R146	1-216-864-11	SHORT CHIP	0	R237	1-216-821-11	METAL CHIP	1K 5% 1/10W
		EXCEPT (NS50P:US,CND.PX/NS41P)		R238	1-216-829-11	METAL CHIP	4.7K 5% 1/10W
R147	1-216-864-11	SHORT CHIP	0	R239	1-216-829-11	METAL CHIP	4.7K 5% 1/10W
		EXCEPT (NS50P:US,CND.PX/NS41P)		R240	1-216-864-11	SHORT CHIP	0
R148	1-216-864-11	SHORT CHIP	0	R241	1-216-864-11	SHORT CHIP	0
		EXCEPT (NS50P:US,CND.PX/NS41P)		R243	1-216-809-11	METAL CHIP	100 5% 1/10W
R149	1-216-864-11	SHORT CHIP	0	R246	1-216-829-11	METAL CHIP	4.7K 5% 1/10W
R151	1-216-833-11	METAL CHIP	10K 5% 1/10W	R247	1-216-821-11	METAL CHIP	1K 5% 1/10W
R152	1-216-864-11	SHORT CHIP	0	R248	1-216-864-11	SHORT CHIP	0
R153	1-216-864-11	SHORT CHIP	0	R249	1-216-864-11	SHORT CHIP	0
R154	1-216-864-11	SHORT CHIP	0	R250	1-216-864-11	SHORT CHIP	0
R155	1-216-864-11	SHORT CHIP	0	R251	1-216-864-11	SHORT CHIP	0
R156	1-216-809-11	METAL CHIP	100 5% 1/10W	R255	1-216-864-11	SHORT CHIP	0
R159	1-216-864-11	SHORT CHIP	0	R320	1-216-864-11	SHORT CHIP	0
R160	1-216-864-11	SHORT CHIP	0	R321	1-216-833-11	METAL CHIP	10K 5% 1/10W
R161	1-216-864-11	SHORT CHIP	0	R325	1-216-864-11	SHORT CHIP	0
R162	1-216-864-11	SHORT CHIP	0	R327	1-216-833-11	METAL CHIP	10K 5% 1/10W
R163	1-216-864-11	SHORT CHIP	0	R331	1-211-990-11	METAL CHIP	75 0.5% 1/10W
R164	1-216-864-11	SHORT CHIP	0	R332	1-211-990-11	METAL CHIP	75 0.5% 1/10W
R165	1-216-864-11	SHORT CHIP	0	R333	1-211-990-11	METAL CHIP	75 0.5% 1/10W
R171	1-216-864-11	SHORT CHIP	0	R334	1-211-990-11	METAL CHIP	75 0.5% 1/10W
R172	1-216-864-11	SHORT CHIP	0	R335	1-211-990-11	METAL CHIP	75 0.5% 1/10W
R173	1-216-864-11	SHORT CHIP	0	R336	1-211-990-11	METAL CHIP	75 0.5% 1/10W
R174	1-216-864-11	SHORT CHIP	0				

Ref. No.	Part No.	Description	Remark			Ref. No.	Part No.	Description	Remark		
R375	1-216-864-11	SHORT CHIP	0			R1115	1-216-805-11	METAL CHIP	47	5%	1/10W
R382	1-216-864-11	SHORT CHIP	0			R1120	1-216-864-11	SHORT CHIP	0		
R401	1-208-798-11	METAL CHIP	4.7K	0.5%	1/10W			EXCEPT (NS50P:US,CND,PX/NS41P)			
						R1121	1-216-864-11	SHORT CHIP	0		
R402	1-208-798-11	METAL CHIP	4.7K	0.5%	1/10W			EXCEPT (NS50P:US,CND,PX/NS41P)			
R403	1-208-798-11	METAL CHIP	4.7K	0.5%	1/10W	R1122	1-216-864-11	SHORT CHIP	0		
R404	1-208-798-11	METAL CHIP	4.7K	0.5%	1/10W			EXCEPT (NS50P:US,CND,PX/NS41P)			
R405	1-208-800-11	METAL CHIP	5.6K	0.5%	1/10W	R1123	1-216-864-11	SHORT CHIP	0		
R406	1-208-800-11	METAL CHIP	5.6K	0.5%	1/10W						
						R1124	1-216-864-11	SHORT CHIP	0		
R407	1-216-825-11	METAL CHIP	2.2K	5%	1/10W	R1125	1-216-864-11	SHORT CHIP	0		
R408	1-216-825-11	METAL CHIP	2.2K	5%	1/10W	R1129	1-216-845-11	METAL CHIP	100K	5%	1/10W
R409	1-216-825-11	METAL CHIP	2.2K	5%	1/10W	R1133	1-216-864-11	SHORT CHIP	0		
R410	1-216-825-11	METAL CHIP	2.2K	5%	1/10W	R1134	1-216-864-11	SHORT CHIP	0		
R411	1-208-800-11	METAL CHIP	5.6K	0.5%	1/10W						
						R1138	1-216-864-11	SHORT CHIP	0		
R412	1-208-800-11	METAL CHIP	5.6K	0.5%	1/10W	R1139	1-216-864-11	SHORT CHIP	0		
R413	1-216-829-11	METAL CHIP	4.7K	5%	1/10W	R1140	1-216-864-11	SHORT CHIP	0		
R416	1-216-830-11	METAL CHIP	5.6K	5%	1/10W	R1141	1-216-864-11	SHORT CHIP	0		
R417	1-216-833-11	METAL CHIP	10K	5%	1/10W	R1142	1-216-864-11	SHORT CHIP	0		
R418	1-216-845-11	METAL CHIP	100K	5%	1/10W						
						R1143	1-216-864-11	SHORT CHIP	0		
R419	1-216-849-11	METAL CHIP	220K	5%	1/10W	R1144	1-216-295-91	SHORT CHIP	0		
R420	1-216-817-11	METAL CHIP	470	5%	1/10W			EXCEPT (NS50P:US,CND,PX/NS41P)			
R421	1-216-833-11	METAL CHIP	10K	5%	1/10W	R1145	1-216-295-91	SHORT CHIP	0		
R422	1-216-833-11	METAL CHIP	10K	5%	1/10W			EXCEPT (NS50P:US,CND,PX/NS41P)			
R424	1-216-833-11	METAL CHIP	10K	5%	1/10W	R1146	1-216-295-91	SHORT CHIP	0		
						R1147	1-216-295-91	SHORT CHIP	0		
R425	1-216-841-11	METAL CHIP	47K	5%	1/10W						
R426	1-216-817-11	METAL CHIP	470	5%	1/10W	R1150	1-216-827-11	METAL CHIP	3.3K	5%	1/10W
R427	1-216-817-11	METAL CHIP	470	5%	1/10W	R1151	1-216-827-11	METAL CHIP	3.3K	5%	1/10W
R428	1-216-833-11	METAL CHIP	10K	5%	1/10W	R1152	1-216-827-11	METAL CHIP	3.3K	5%	1/10W
R429	1-216-841-11	METAL CHIP	47K	5%	1/10W	R1160	1-216-864-11	SHORT CHIP	0		
						R1168	1-216-815-11	METAL CHIP	330	5%	1/10W
R430	1-216-841-11	METAL CHIP	47K	5%	1/10W			(NS50P:US,CND,PX,MX,E/NS41P)			
R434	1-216-829-11	METAL CHIP	4.7K	5%	1/10W						
R435	1-216-829-11	METAL CHIP	4.7K	5%	1/10W	R1168	1-216-819-11	METAL CHIP	680	5%	1/10W
R438	1-216-845-11	METAL CHIP	100K	5%	1/10W			EXCEPT (NS50P:US,CND,PX,MX,E/NS41P)			
R440	1-216-817-11	METAL CHIP	470	5%	1/10W	R1169	1-216-864-11	SHORT CHIP	0		
						R1177	1-216-864-11	SHORT CHIP	0		
R441	1-216-817-11	METAL CHIP	470	5%	1/10W	R1178	1-216-821-11	METAL CHIP	1K	5%	1/10W
R442	1-216-864-11	SHORT CHIP	0			R1180	1-216-833-11	METAL CHIP	10K	5%	1/10W
R443	1-216-864-11	SHORT CHIP	0								
R444	1-216-809-11	METAL CHIP	100	5%	1/10W	R1181	1-216-833-11	METAL CHIP	10K	5%	1/10W
R449	1-216-813-11	METAL CHIP	220	5%	1/10W	R1182	1-216-833-11	METAL CHIP	10K	5%	1/10W
						R1183	1-216-833-11	METAL CHIP	10K	5%	1/10W
R451	1-216-807-11	METAL CHIP	68	5%	1/10W	RB103	1-234-371-21	RES, NETWORK 47	(1005X4)		
R452	1-216-833-11	METAL CHIP	10K	5%	1/10W	RB104	1-234-371-21	RES, NETWORK 47	(1005X4)		
R453	1-216-821-11	METAL CHIP	1K	5%	1/10W						
R454	1-216-821-11	METAL CHIP	1K	5%	1/10W	RB105	1-234-371-21	RES, NETWORK 47	(1005X4)		
R456	1-216-821-11	METAL CHIP	1K	5%	1/10W	RB106	1-234-371-21	RES, NETWORK 47	(1005X4)		
						RB107	1-234-371-21	RES, NETWORK 47	(1005X4)		
R468	1-216-864-11	SHORT CHIP	0			RB108	1-234-371-21	RES, NETWORK 47	(1005X4)		
R475	1-216-295-91	SHORT CHIP	0			RB109	1-234-371-21	RES, NETWORK 47	(1005X4)		
R476	1-216-295-91	SHORT CHIP	0								
						RB110	1-234-371-21	RES, NETWORK 47	(1005X4)		
R484	1-216-830-11	METAL CHIP	5.6K	5%	1/10W	RB111	1-234-371-21	RES, NETWORK 47	(1005X4)		
R489	1-216-833-11	METAL CHIP	10K	5%	1/10W	RB112	1-234-371-21	RES, NETWORK 47	(1005X4)		
						RB113	1-234-371-21	RES, NETWORK 47	(1005X4)		
R503	1-216-833-11	METAL CHIP	10K	5%	1/10W	RB114	1-234-371-21	RES, NETWORK 47	(1005X4)		
R504	1-216-827-11	METAL CHIP	3.3K	5%	1/10W						
R505	1-216-827-11	METAL CHIP	3.3K	5%	1/10W	RB115	1-234-371-21	RES, NETWORK 47	(1005X4)		
R507	1-216-864-11	SHORT CHIP	0								
R515	1-216-864-11	SHORT CHIP	0								
								<CRYSTAL>			
R1101	1-218-855-11	METAL CHIP	2.2K	0.5%	1/10W						
R1102	1-218-827-11	METAL CHIP	150	0.5%	1/10W	X102	1-813-539-11	QUARTZ CRYSTAL UNIT			
R1107	1-216-864-11	SHORT CHIP	0					(NS50P:US,CND,PX,MX,E/NS41P)			
						X102	1-813-219-31	QUARTZ CRYSTAL UNIT			
R1110	1-216-826-11	METAL CHIP	2.7K	5%	1/10W			EXCEPT (NS50P:US,CND,PX,MX,E/NS41P)			
R1114	1-216-801-11	METAL CHIP	22	5%	1/10W						

**POWER BLOCK (SRV1487UC)**

**POWER BLOCK (SRV1501WW)**

Ref. No. Part No. Description Remark

△ 1-478-538-12 POWER BLOCK (SRV1487UC)  
(NS41P/NS50P:US,CND,MX)  
\*\*\*\*\*

△ 1-478-539-13 POWER BLOCK (SRV1501WW)  
(EXCEPT (NS41P/NS50P:US,CND,MX)  
\*\*\*\*\*

<ACCESSORIES>  
1-751-271-71 CORD, CONNECTION (AV)  
2-581-693-11 MANUAL, INSTRUCTION (ENGLISH) (NS50P:US,CND,PX)  
  
2-581-693-21 MANUAL, INSTRUCTION (FRENCH) (NS50P:CND)  
2-581-693-31 MANUAL, INSTRUCTION (SPANISH) (NS50P:E)  
2-581-693-41 MANUAL, INSTRUCTION (SPANISH) (NS50P:MX)  
  
2-581-693-52 MANUAL, INSTRUCTION (ENGLISH) (NS41P)  
2-581-693-61 MANUAL, INSTRUCTION (FRENCH) (NS41P:CND)  
2-581-693-41 MANUAL, INSTRUCTION (SPANISH) (NS50P:MX)  
  
2-581-472-12 MANUAL, INSTRUCTION (ENGLISH)  
(NS50P:EA,AUS,HK,SP,TW,ME5,ME2,IR,IN,MY)  
2-581-472-22 MANUAL, INSTRUCTION (CHINESE TRADITIONAL)  
(NS50P:HK,MY)  
2-581-472-31 MANUAL, INSTRUCTION (CHINESE TRADITIONAL)  
(NS50P:TW)  
2-581-472-41 MANUAL, INSTRUCTION (KOREAN) (NS50P:KR)  
2-581-472-51 MANUAL, INSTRUCTION (ARABIC) (NS50P:ME2,EA)  
  
2-581-472-61 MANUAL, INSTRUCTION (PERSIAN) (NS50P:IR)  
2-581-472-71 MANUAL, INSTRUCTION (FRENCH) (NS50P:ME5)  
2-581-472-81 MANUAL, INSTRUCTION (THAI) (NS50P:SP)  
2-581-859-11 MANUAL, INSTRUCTION (ENGLISH)  
(NS52P:ME2,TW,SP,AUS)  
2-581-859-21 MANUAL, INSTRUCTION (ARABIC) (NS52P:ME2)  
  
2-581-859-31 MANUAL, INSTRUCTION (CHINESE TRADITIONAL)  
(NS52P:TW)  
2-581-859-41 MANUAL, INSTRUCTION (KOREAN) (NS52P:KR)  
2-581-859-51 MANUAL, INSTRUCTION (PERSIAN)(NS52P:ME2)  
2-581-859-61 MANUAL, INSTRUCTION (THAI) (NS52P:SP)  
1-479-179-11 REMOTE COMMANDER (RMT-D175A)  
(NS41P/NS50P:US,CND,KR,TW,PX,MX,E/NS52P:KR,TW)  
  
1-479-179-21 REMOTE COMMANDER (RMT-D175P)  
(NS50P:AUS,ME2,SP,EA,HK,IR,ME5/NS52P:AUS,ME2,SP)  
1-569-008-22 ADAPTOR, CONVERSION 2P (NS50P:PX,E)

Ref. No. Part No. Description Remark

**Note :**  
The components identified by mark △ or dotted line with mark △ are critical for safety. Replace only with part number specified.

