

SERVICE MANUAL

M-4 STEREO POWER AMPLIFIER

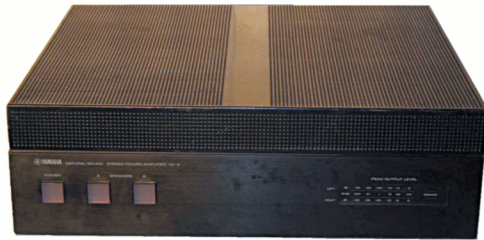

SINCE 1887  **YAMAHA**
YAMAHA CORPORATION
NIPPON GAKKI CO., LTD. HAMAMATSU, JAPAN

■CONTENTS

PACKAGE INSTRUCTION	2
PANEL OPERATION	3
DISASSEMBLY PROCEDURES	6
ADJUSTMENT/ADJUSTING POINTS	8
BLOCK DIAGRAM	10
CIRCUIT DIAGRAM (WIRING)	11
SCHEMATIC DIAGRAM	12
SPECIFICATIONS	13
EXPLODED VIEW	14
PARTS LIST	15

■PACKAGE INSTRUCTION

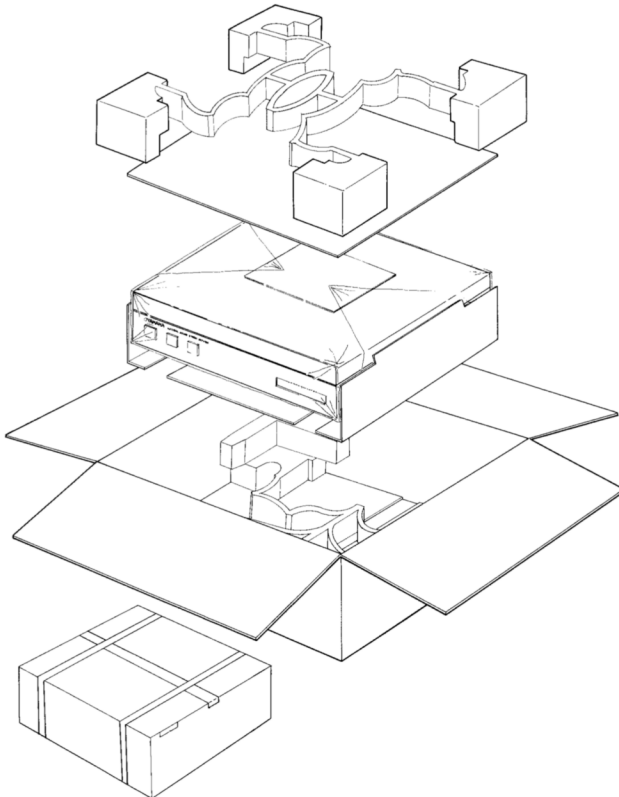

■ PANEL OPERATION

FRONT PANEL

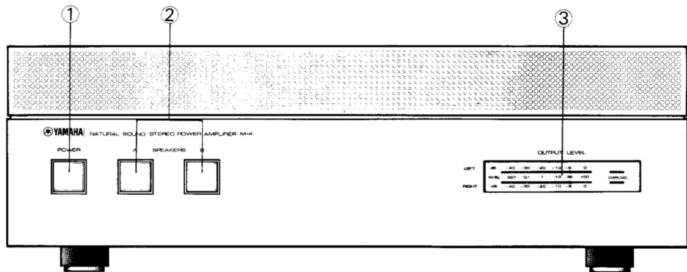

- ① POWER(Switch)
- ② SPEAKERS A , B
- ③ OUTPUT LEVEL(Indicators)

REAR PANEL

U.S.A & Canadian Model

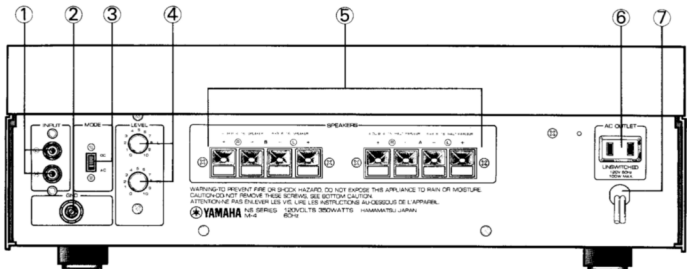

- ① INPUT(Pin Jack)
- ② GND Terminal
- ③ MODE Switch(DC and AC)
- ④ LEVEL(Input Level Control)
- ⑤ SPEAKERS(SP Output)
- ⑥ AC OUTLET
- ⑦ AC Cord

Australian Model

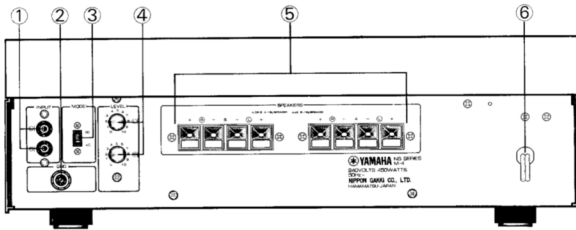

- ① INPUT (Pin Jack)
- ② GND Terminal
- ③ MODE Switch (DC and AC)
- ④ LEVEL (Input Level Control)
- ⑤ SPEAKERS (SP Output)
- ⑥ AC Cord

British Model

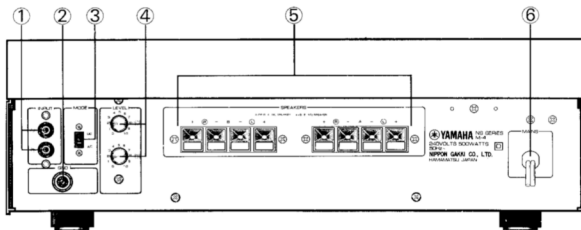

- ① INPUT (Pin Jack)
- ② GND Terminal
- ③ MODE Switch (DC and AC)
- ④ LEVEL (Input Level Control)
- ⑤ SPEAKERS (SP Output)
- ⑥ AC Cord

General Model

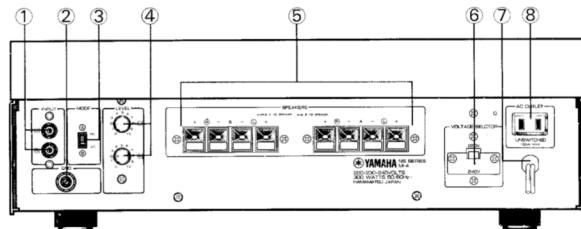

- ① INPUT (Pin Jack)
- ② GND Terminal
- ③ MODE Switch (DC and AC)
- ④ LEVEL (Input Level Control)
- ⑤ SPEAKERS (SP Output)
- ⑥ VOLTAGE SELECTOR (220V and 240V)
- ⑦ AC Cord
- ⑧ AC OUTLET

European Model

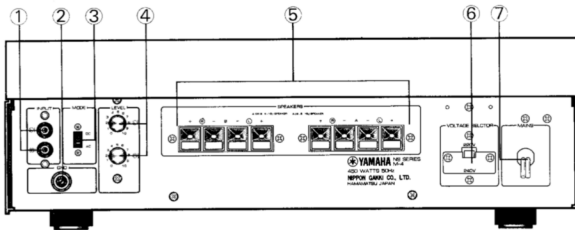

- ① INPUT(Pin Jack)
- ② GND Terminal
- ③ MODE Switch (DC and AC)
- ④ LEVEL(Input Level Control)
- ⑤ SPEAKERS(SP Output)
- ⑥ VOLTAGE SELECTOR (220V and 240V)
- ⑦ AC Cord

Noth European Model

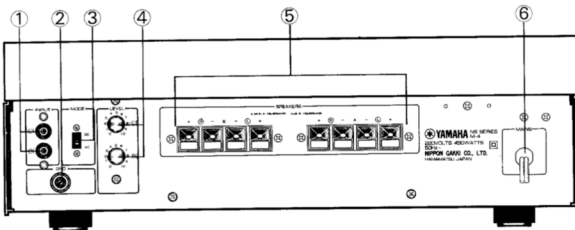

- ① INPUT(Pin Jack)
- ② GND Terminal
- ③ MODE Switch (DC and AC)
- ④ LEVEL(Input Level Control)
- ⑤ SPEAKERS(SP Output)
- ⑥ AC Cord

DISASSEMBLY PROCEDURES

1. Top Cover Removal

Remove screws (1) to (4) in photo 1, remove the top cover.

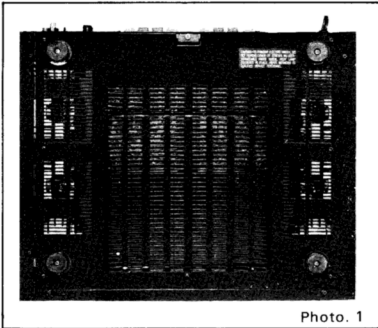

2. Bottom Cover Removal

Turn the model over so that the bottom cover is facing up, remove screws (5) to (11).

3. Front Panel Removal

- 1) Remove the top and bottom cover. (Refer to steps 1, 2)
- 2) Remove screws (12) and (13) in photo 1 and screws (1) and (2) in photo 2, slide the front panel gently toward you and remove.
* Be careful not to cut the lead wires which are attached to the pilot lamps of Power and Speakers A, B.
- 3) Pull the lead wires which are connected to Power and Speakers A, B Switch, gently from the holders behind the switches.

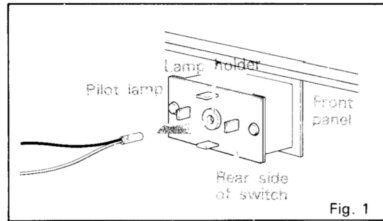
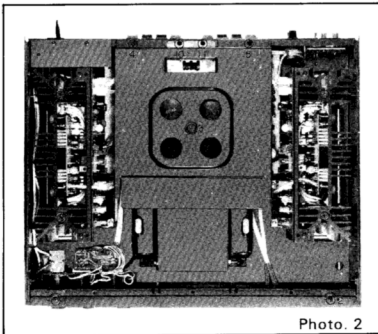

4. Side Panel Removal

- 1) Remove the top and bottom cover. (Refer to step 1 and 2)
- 2) Remove screws (14) to (17) in photo 1 and screws (1) to (4) in photo 3, side panel can be removed.

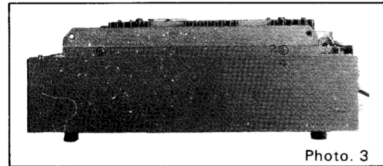

5. Rear Panel Removal

- 1) Remove the top and bottom cover (Refer to steps 1 and 2), pull the Level knob.
- 2) Remove the side panel. (Refer to step 4)
- 3) Remove screws (3) to (5), (10) and (11) in photo 2, remove the shield case.
- 4) Remove screws (1) to (4) in photo 4.
- 5) Remove screws (1) to (11) in photo 5 and plastic rivets (A) and (B).
- 6) Detach the wires which are attached to the AC Outlet, rear panel can be removed.
* When removing the plastic rivet, pinch it with a long nose plier softly, pull it toward you.

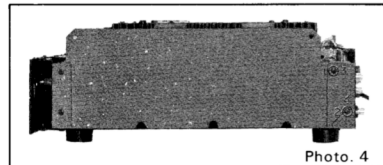

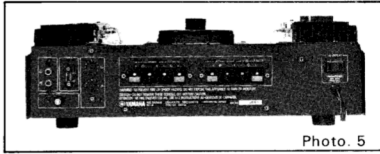

Photo. 5

6. Pre-Drive and Drive Printed Circuit Boards Removal

- 1) Remove screws (6) to (9) in photo 2, disconnect the connectors and remove the Pre-drive and Drive printed circuit boards with the heat sink.
- 2) Remove screws (1) to (4) in photo 6, plastic rivets (A) to (C) and connectors, Pre-drive printed circuit board can be removed.
- 3) Remove screws (1) to (8) in photo 7 and pull the power transistors and remove screws (1) and (2) in photo 8, Drive printed circuit board can be removed.

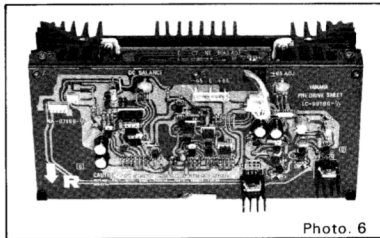

Photo. 6

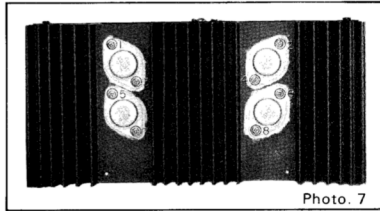

Photo. 7

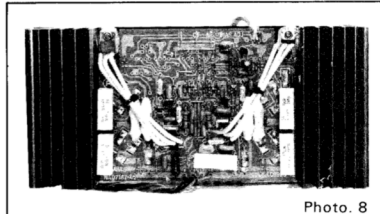

Photo. 8

7. Power Printed Circuit Board and Power Transformer Removal

- 1) Remove the top cover. (Refer to step 1)
- 2) Remove the shield case. (Refer to step 5's (5))
- 3) Remove screws (1) to (5) in photo 9, disconnect connectors and wires from the transformer, power printed circuit board can be removed.
- 4) Remove screws (8) to (11) in photo 9, power transformer can be removed.

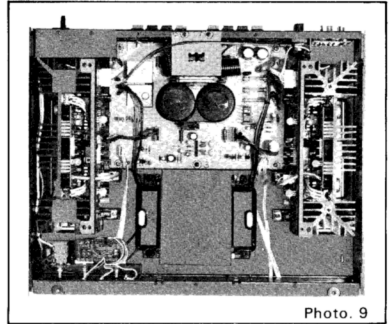

Photo. 9

8. Indicator Printed Circuit Board Removal

- 1) Remove the front panel. (Refer to step 3)
- 2) Remove screws (1) to (4) in photo 10, Indicator printed circuit board can be removed.

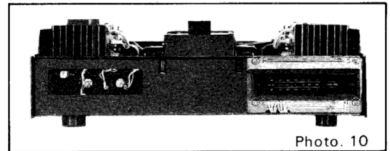
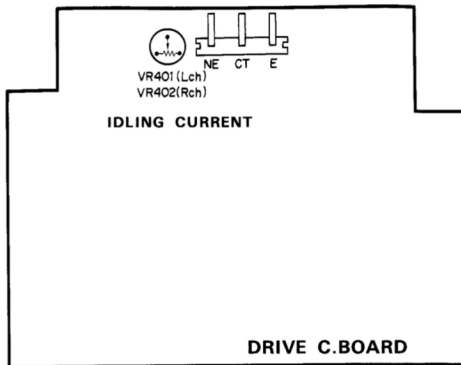

Photo. 10

■ ADJUSTMENT

STEP	ADJUSTMENT ITEMS	ADJUSTMENT	INSTRUMENT	TERMINALS/ TEST POINTS	RATING OR STANDARD
1	POWER SUPPLY VOLTAGE	PRE-DRIVE P.C.B. VR203(L), VR204(R)	Digital multi meter	PRE-DRIVE P.C.B. +65 - E	65 ± 0.5V
2	IDLING CURRENT	DRIVE P.C.B. VR401 (Lch.) VR402 (Rch.)	- do. -	DRIVE P.C.B. CT (-), NE (+)	15 ± 2mV NO LOAD
3	DC OFFSET	PRE-DRIVE P.C.B. VR201 (Lch.) VR202 (Rch.)	- do. -	DRIVE P.C.B. CT NE	0 ± 10mV NO LOAD
4	LEVEL INDICATOR	POWER P.C.B. VR601 (Lch.) VR602 (Rch.)	Audio frequency generator VTVM	Speaker output 8Ω Load	at 31.7 dBm, the indicator lights up. at 30.7 dBm goes off.
5	OVERLOAD INDICATOR	- do. -	Audio frequency generator VTVM	Speaker output 8Ω Load	at 2% THD the indicator lights up. at 0.1%, goes off.

■ ADJUSTING POINTS



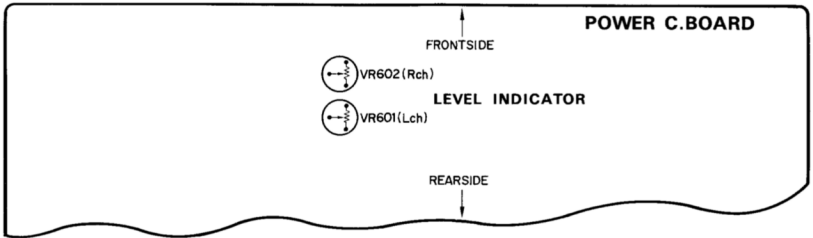
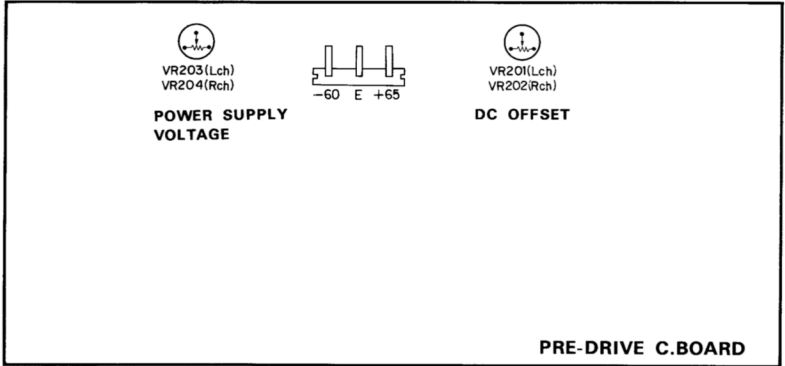

■ BLOCK DIAGRAM

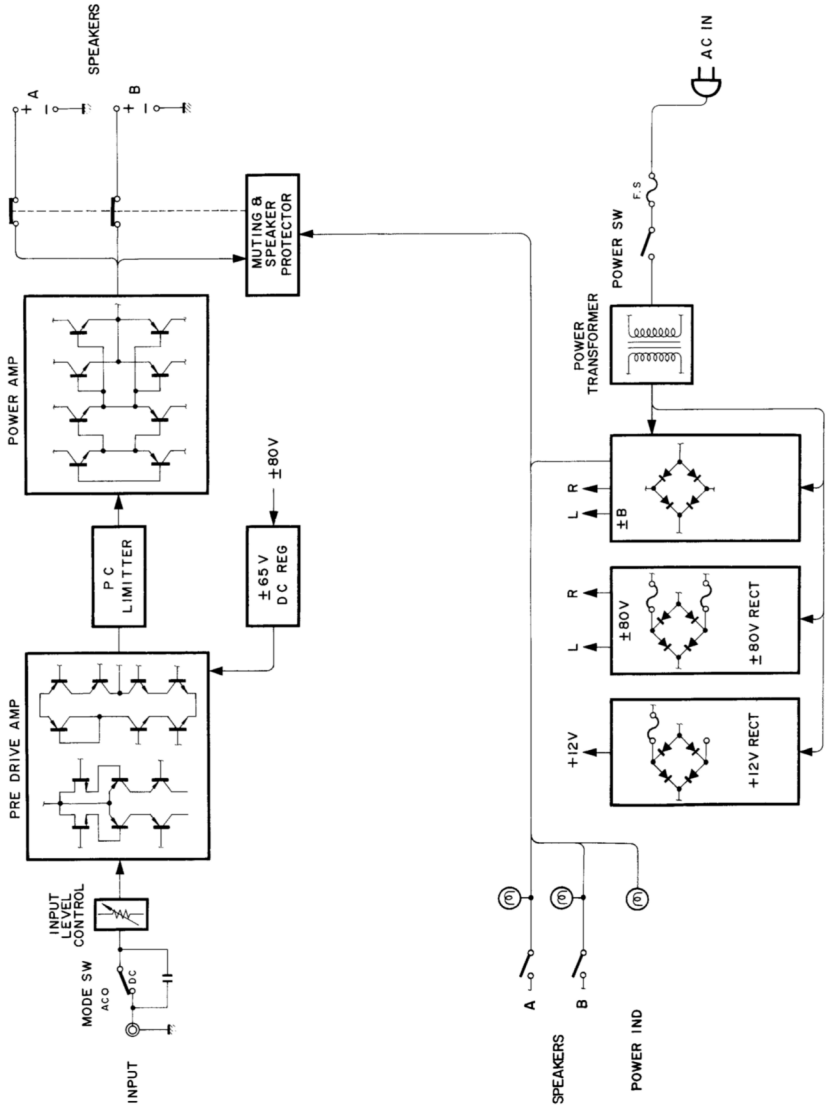

CIRCUIT DIAGRAM (WIRING)

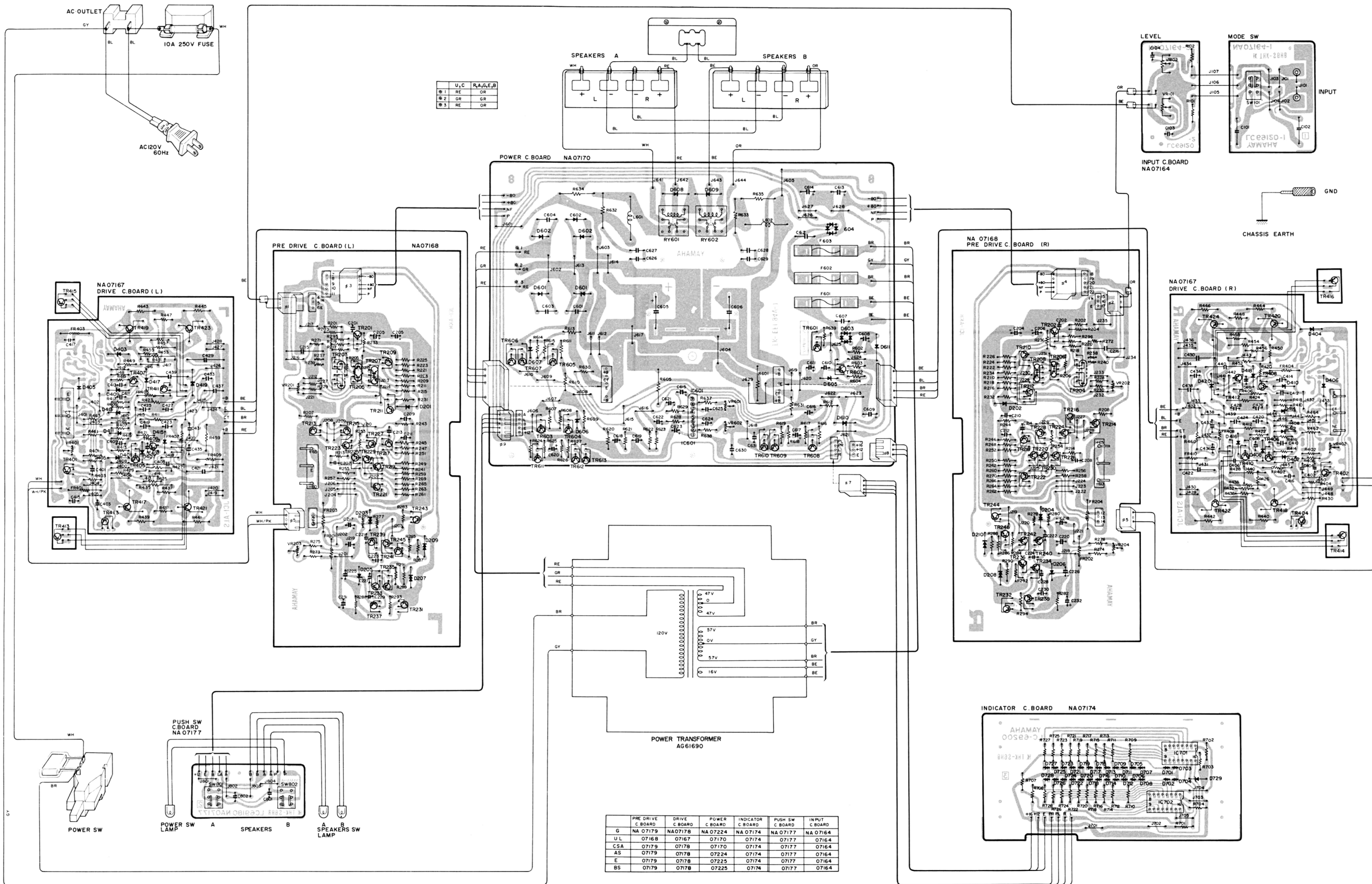

PRE DRIVE C BOARD	DRIVE C BOARD	POWER C BOARD	INDICATOR C BOARD	PUSH SW C BOARD	INPUT C BOARD
G NA 07179	NA07178	NA 07224	NA 07174	NA 07177	NA 07164
U L	07168	07170	07174	07177	07164
CSA	07179	07178	07174	07177	07164
AS	07179	07178	07224	07174	07177
E	07179	07178	07225	07174	07177
BS	07179	07178	07225	07174	07177

SCHEMATIC DIAGRAM

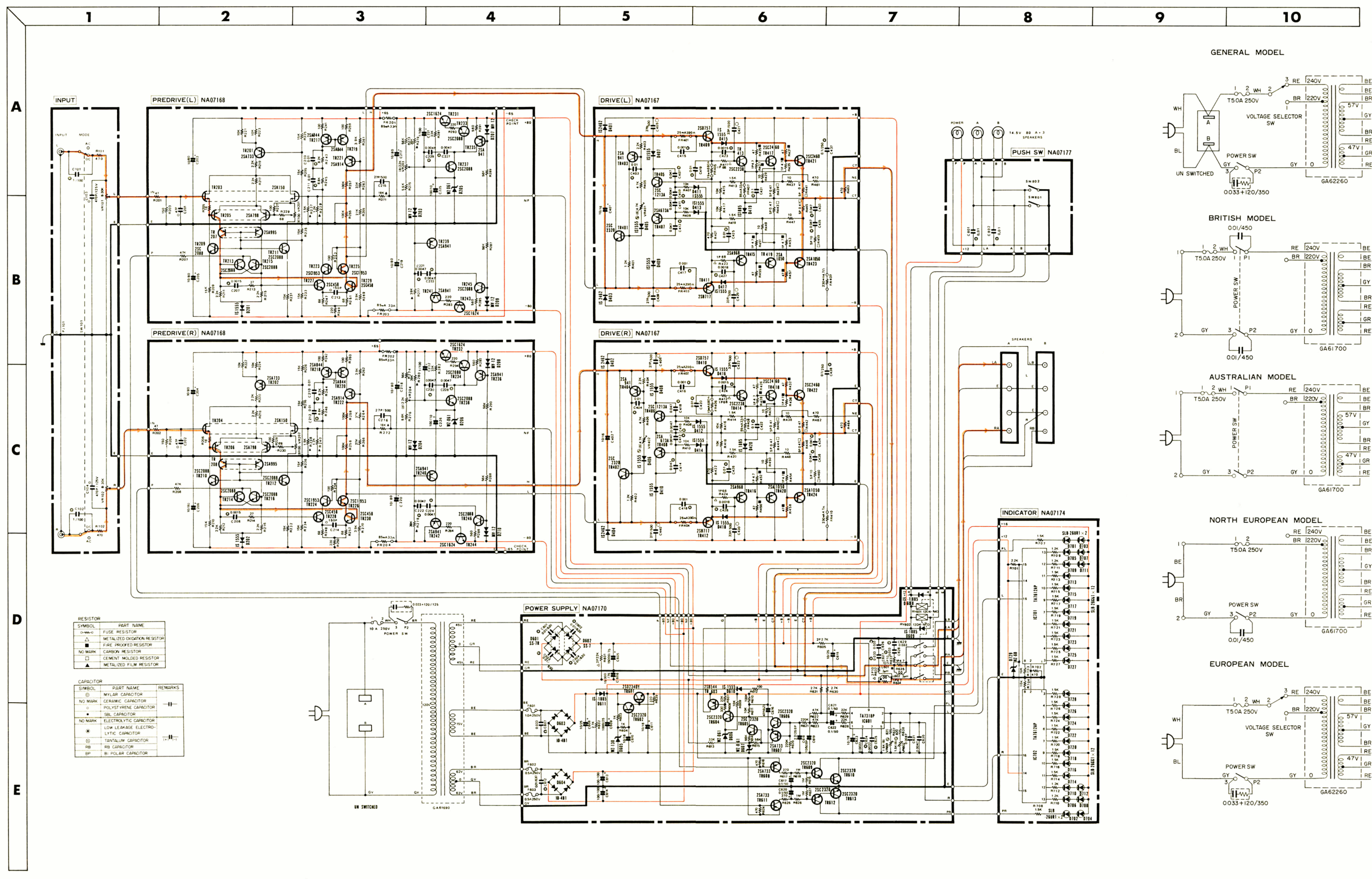

RESISTOR	
SYMBOL	PART NAME
	FUSE RESISTOR
	METALIZED OXIDATION RESISTOR
	FINE TUNING RESISTOR
	CARBON RESISTOR
	CEMENT MOLDED RESISTOR
	METALIZED FILM RESISTOR

CAPACITOR		
SYMBOL	PART NAME	REMARKS
	MILAR CAPACITOR	
	CERAMIC CAPACITOR	
	POLYSTYRENE CAPACITOR	
	SEL. CAPACITOR	
	ELECTROLYTIC CAPACITOR	
	LOW LEAKAGE ELECTROLYTIC CAPACITOR	
	TANTALUM CAPACITOR	
	RB CAPACITOR	
	BI-POLAR CAPACITOR	

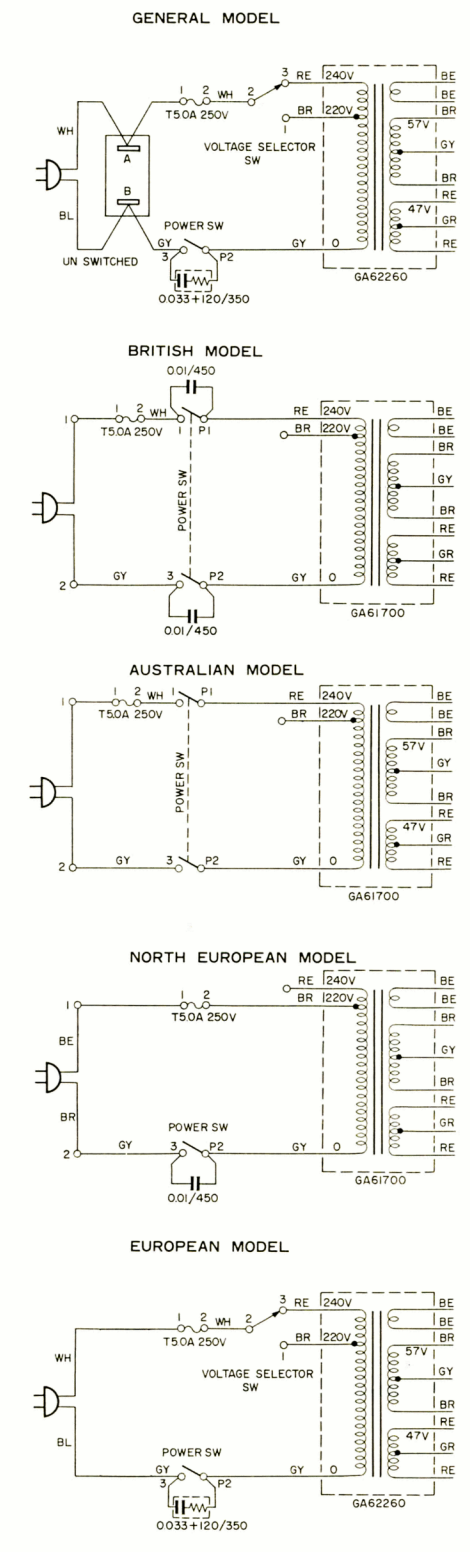

SPECIFICATIONS

Rated Output Power

120W + 120W (8Ω, 20Hz~20kHz
0.005% T-H-D) *U,C,R,E)
170W + 170W (4Ω, 20Hz~20kHz
0.01% T-H-D) (U,C,R,E)
100W + 100W (8Ω, 20Hz~20kHz
0.005% T-H-D) (G,B,A)

Power Band Width

10Hz~100kHz
(8Ω, 50W, 0.02% T-H-D)
(U,C,R,E)
(8Ω, 60W, 0.02% T-H-D)
(G,B,A)

Damping Factor

200 or less (8Ω, 1kHz)
100 or less (4Ω, 1kHz)

Input Sensitivity/Impedance

0dBv/25kΩ

Frequency Response

MODE "DC"

10Hz : 0dB (8Ω, 60W) (U,C,R,E)
(8Ω, 50W) (G,B,A)

1kHz : 0dB

100kHz : -0.7 ± 0.5 dB

MODE "AC"

10Hz : -1.5 ± 0.5 dB (8Ω, 60W) (U,C,R,E)
(8Ω, 50W) (G,B,A)

1kHz : 0dB

100kHz : -0.7 ± 0.5 dB

Signal-to-Noise Ratio

120dB (IHF-A Network, R_L=8Ω,
Input VR min.)

Residual Noise

32μV (8Ω, IHF-A Network,
Input VR min.)

Harmonic

0.004% or less
(8Ω, 10Hz~20Hz, 50W)
(G,B,A)
0.018% or less
(8Ω, 100kHz, 60W) (U,C,R,E)
(8Ω, 100kHz, 50W) (G,B,A)

IM Distortion (EIAJ, IHF, DIN)

0.002% or less
(8Ω, 50Hz: 7kHz=4:1, 60W)
(U,C,R,E)
(8Ω, 50Hz: 7kHz=4:1, 50W)
(G,B,A)

Channel Separation (L → R, R →L)

90dB (8Ω, 1kHz, 60W) (U,C,R,E)
(8Ω, 1kHz, 50W) (G,B,A)

Filter Characteristics

6.4Hz, -6dB/oct (Low Cut Filter)

Peak Indicator

Indicator Point : 100W (8Ω, 1kHz)
Indicator Level : 0dB~45dB (-5dB step)
Attack Time : 100μ sec.
Release Time : 1.2 sec. (-45dB ~ 0dB)

Over Drive Indicator

Indicator Level : 1% Distortion
(8Ω, 10Hz~20kHz)

Number of Semiconductors Used

77 (Transistors)
4 (Dual Transistors)
3 (ICs)
2 (Dual FETs)
32 (Diodes), 2 (Dual Diodes)
2 (Bridged Diodes)
6 (Zener Diodes)
24 (Green LEDs)
4 (Red LEDs)

Rated Voltage

U, C : 120V AC, 60Hz
R : 110/120V, 220/240V AC,
50/60Hz
G : 220V AC, 50Hz
B, A : 240V AC

Rated Power

Consumption

U : 350W
C : 580W, 750VA
R : 300W
E,G,A : 450W
B : 500W

AC Outlet

100W Unswitched x 1
(U, C, R only)

Dimensions

W:435, H:145.5, D:374.5 mm
(17-1/8") (5-3/4") (14-3/4")

Weight

18.5kg (40.8 lbs) (C,R,A,E,G,B)
18.6kg (41.0 lbs) (U)

Specifications subject to change without notice.

U : U.S.A. C : CANADIAN, R : REGULAR
E : EUROPEAN, G : GENERAL, A : AUSTRALIAN
B : BRITISH

EXPLODED VIEW

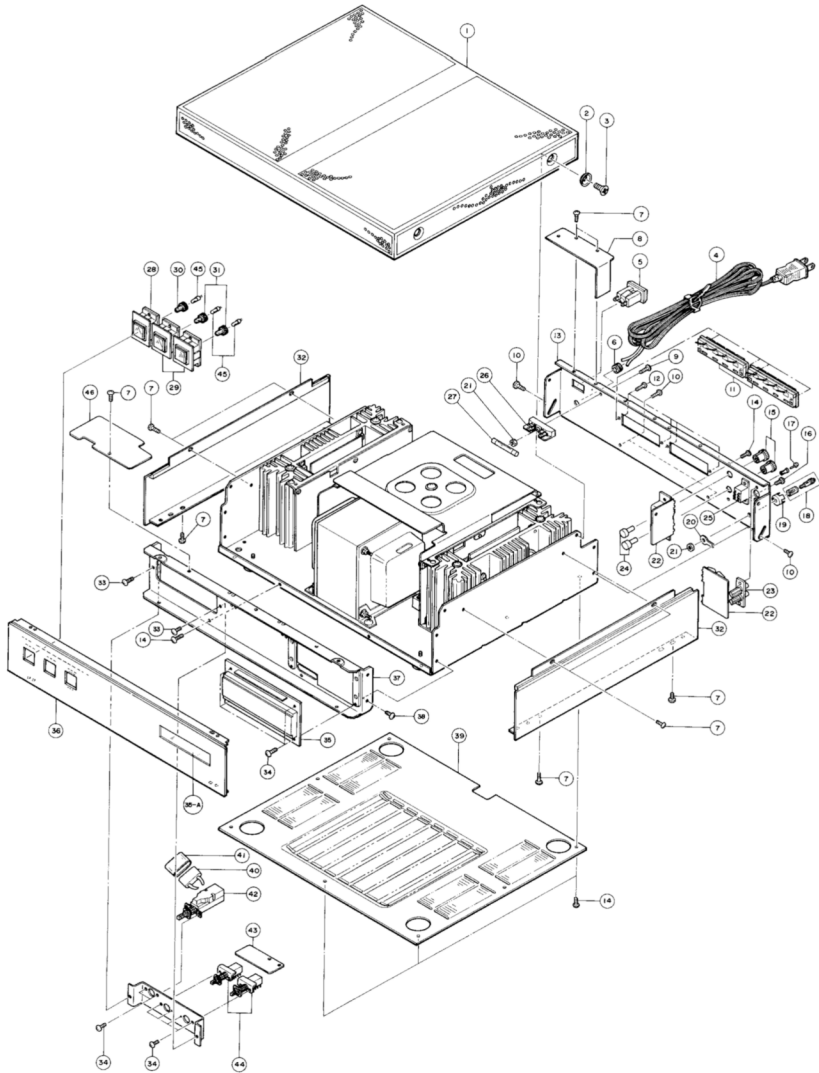

PARTS LIST

※New Parts

Ref. No.	Part No.	Description	(部 品 名)	Markets	Remarks
1	32 00 00 NB 08 71 40	Top Cover Unit	トップカバー	C,R,A,E,G,B	
	32 00 00 NB 08 84 30	-do.-	〃	U	
2	32 00 00 CB 08 74 40	Washer	ワッシャー		
3	42 00 00 EB 35 01 00	Flat Head Screw(5×10) FCM3-B \sharp	鉄皿小ネジ		
4	42 00 00 MG 00 04 60	AC Cord VM0077 6A class II	電源コード	E, G	
	42 00 00 MG 00 07 80	-do.- Black 2m, 6A, 250V	〃	R	
	42 00 00 MG 00 08 50	-do.- A4, 7.5A 240V	〃	A	
	42 00 00 MG 00 08 90	-do.- Black 2m BA, 125V	〃	U, C	
	42 00 00 MG 07 28 90	Use to BS AC Cord Ass'y	BS用電源コードAss'y	B	
5	42 00 00 LB 20 07 10	AC Outlet Si-6432	ACアウトレットパネ式	R, U, C	
6	42 00 00 CB 06 86 30	Cord Stopper SR-3P-4	コードストッパー	A	
	42 00 00 CB 07 27 50	-do.- SR-4N-4	〃	R,U,E,G,C,B	
7	42 00 00 E \sharp 33 00 80	Bind Head Tapping Screw(3×8) FCM3-B \sharp	鉄バインドタッピングネジ		
8	32 00 00 AA 09 38 60	Fuse Cover	ヒューズカバー		
9	42 00 00 ED 33 00 80	Bind Head Screw(3×8) FCM3-B \sharp	鉄バインド小ネジ		
10	42 00 00 EN 34 00 10	Bind Head Bonding Tapping Screw(3×8)	鉄バインドボンディングタッピングネジ		FCM3-B \sharp
11	42 00 00 LA 00 18 80	4P Push Terminal XQ-2754	4Pプッシュターミナル		
12	42 00 00 E \sharp 33 00 80	Bind Head Tapping Screw(3×8) FCM3-B \sharp	鉄バインドタッピングネジ		
13	32 00 00 AA 09 36 00	Rear Panel	リアパネル	R	
	32 00 00 AA 09 36 10	-do.-	〃	C	
	32 00 00 AA 09 48 10	-do.-	〃	A	
	32 00 00 AA 09 36 20	-do.-	〃	E	
	32 00 00 AA 09 36 30	-do.-	〃	B	
	32 00 00 AA 09 48 40	-do.-	〃	G	
	32 00 00 AA 09 63 80	-do.-	〃	U	
14	42 00 00 E \sharp 33 00 80	Bind Head Tapping Screw(3×8) FCM3-B \sharp	鉄バインドタッピングネジ		
15	32 00 00 BA 06 66 10	VR Knob	VRノブ		
16	42 00 00 EC 32 60 40	Tnuss Head Screw(2.6×4) FCM3-B \sharp	鉄トラス小ネジ		
17	42 00 00 CB 06 88 80	Plastic Rivet	プラスチックリベット		
18	32 00 00 NB 08 14 80	Terminal Unit	ターミナルユニット		
19	32 00 00 CB 07 81 70	Saucer	受皿		
20	42 00 00 LA 00 02 80	Earth Lug	アースラグ		
21	42 00 00 EV 10 33 00	Hexagonal nut(M3) FCM3-B \sharp	六角ナット		
22	32 00 00 NA 07 16 40	Input Circuit Board	入力シート		
23	42 00 00 LB 20 08 30	Pin-Jack(2P)	2P入力ピンジャック		
24	42 00 00 HS 41 08 40	Variable Resistor B-30K ϕ 16 ℓ =25	ポリウム B-30K		
25	42 00 00 KA 40 03 50	Slide Switch 4021-0111	スライド SW	R, E	
26	42 00 00 LB 20 12 10	Fuse Holder 1PFH	ヒューズホルダー	R, A	
	42 00 00 LB 20 13 40	-do.- -do.- 15A	〃	U, C	
	42 00 00 LB 20 14 70	-do.- 1PM	〃	E, G, B	
27	42 00 00 KB 00 04 00	Fuse 5.0AT 250V	ヒューズ	R, A	
	42 00 00 KB 00 07 80	-do.- 5.0AT 250V	〃	E, G, B	
	42 00 00 KB 00 13 90	-do.- 10A 250V	〃	U, C	
	42 00 00 KB 00 14 90	-do.- 10A 250V	〃	R	
28	32 00 00 NB 08 58 00	Push Botton Ass'y(Green) #8580	プッシュボタン Ass'y		

Ref. No.	Part No.	Description	(部 品 名)	Markets	Remarks
29	32 00 00 NB 08 58 10	Push Botton Ass'y(Orange)	ブッシュボタンAss'y		
30	42 00 00 CB 08 41 70	Lamp Cap (Orange)	ランプキャップ		
31	42 00 00 CB 08 41 80	-do.- (Green)	#		
32	32 00 00 BA 07 37 20	Side Panel	サイドパネル		
33	42 00 00 EN 33 00 10	Bind Head Tapping Screw Type II(3×8)	鉄バインドタッピングネジ 2種ミソ		FCM3-B#
34	42 00 00 E1 03 01 00	Bind Head Tapping Screw Type II(3×10)	#		ZMC2-Y
35	32 00 00 NA 07 17 40	Indicator Circuit Board	インジケータシート		
* 35-A	32 00 00 CB 08 85 60	LED Cover	LEDカバー		
36	32 00 00 NB 08 84 40	Panel Unit	パネルユニット		
* 37	32 00 00 AA 09 48 60	Sab Chassis	サブシャーシ		
38	42 00 00 EN 34 00 10	Bind Head Bonding Tapping Screw (3×8)	鉄バインドボンディング タッピングネジ		FCM3-B#
39	32 00 00 AA 09 35 70	Bottom Cover	ボトムカバー		
40	42 00 00 FZ 00 01 10	Spark Killer Capacitor 120V,AC 0.033+120	スパークキラーコン	U	
	42 00 00 FZ 00 05 40	-do.- DC500V/AC350V 0.033+120	#	R, E	
	42 00 00 FZ 00 11 20	-do.- 125V,AC 0.033+120	#	C	
* 42	42 00 00 FZ 00 15 60	-do.- ECNC-4A 450V AC0.01	#	G, B	
41	42 00 00 CB 07 21 90	Cover For Capacitor 820826	コンデンサーカバー	R, U, E	
	42 00 00 CB 08 19 40	-do.- SB-0632E-A	#	C	
* 42	42 00 00 CB 08 86 90	-do.- SB-0866	#	G, B	
42	42 00 00 KA 80 04 90	Push Switch SDG1P 125V 15A	ブッシュSW	R, E	
	42 00 00 KA 80 05 00	-do.-	#	U	
	42 00 00 KA 80 05 10	-do.- SDG5PE 18mm	#	A, G, B	
	42 00 00 KA 80 10 30	-do.- SDG5PE TV-5 18mm	#	C	
43	32 00 00 NA 07 17 70	Push SW Circuit Board	ブッシュSWシート		
44	42 00 00 KA 80 04 80	Push SW SUF22	ブッシュSW		
45	42 00 00 JB 00 06 80	Lamp 14.5V 80mA	パイロットランプリード式		
* 46	32 00 00 CA 06 84 50	SW Cover	SWカバー		

EXPLODED VIEW

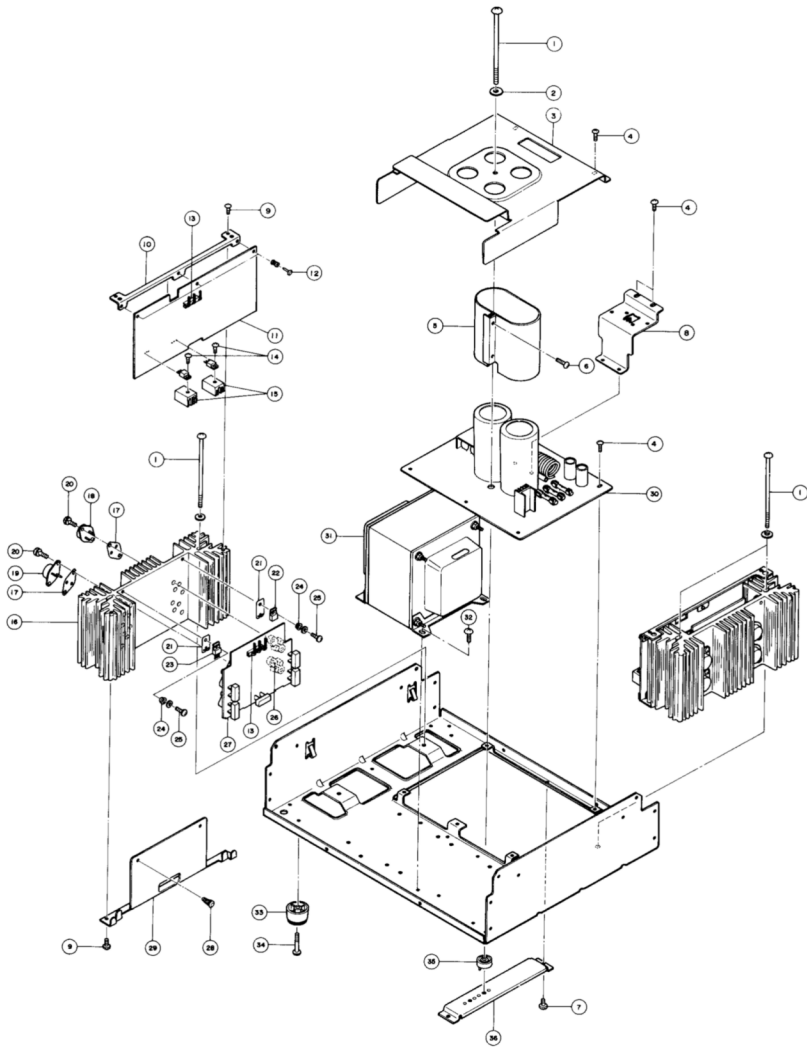

■ PARTS LIST

※ New Parts

Ref. No.	Part No.	Description	(部 品 名)	Markets	Remarks
1	32 00 00 AA 09 38 70	Extension Screw	延長ネジ		
2	32 00 00 CB 08 74 40	Washer	ワッシャー		
3	32 00 00 AA 09 36 50	Shield Plate	センターシールド		
4	42 00 00 Ei 33 00 80	Bind Head Tapping Screw(3×8) FCM3-B#	鉄バンドタッピングネジ		
5	32 00 00 AA 09 48 20	Band For Electrolytic Capacitor	ケミコンバンド		
6	42 00 00 ED 33 01 20	Bind Head Screw(3×12) FCM3-B#	鉄バンド小ネジ		
7	42 00 00 Ei 04 00 80	Bind Head Tapping Screw(4×8) Type II	鉄バンドタッピングネジ		ZMC2-Y
8	32 00 00 BB 06 74 40	Plate For Earth	アース板		
9	42 00 00 Ei 33 00 60	Bind Head Tapping Screw Type II(3×6)	鉄バンドタッピングネジ 2種ミソ		FCM3-B#
10	32 00 00 AA 09 36 80	Holder For Drive Circuit Board (B)	Dシートホルダー(B)		
11	32 00 00 NA 07 16 80	Pre-Drive Circuit Board	ブリドライブシート	U	
	32 00 00 NA 07 17 90	—do.—	〃	R,A,E,G,C,B	
12	42 00 00 CB 06 88 80	Plastic Rivet	プラスチックリベット		
13	42 00 00 LA 00 24 20	Lapping Pin L Type 3P, P=10	L型ラッピング端子板		
14	42 00 00 ED 03 00 60	Bind Head Screw (3×6)	鉄バンド小ネジ		
15	42 00 00 BA 07 28 30	Heat Sink	放熱器		
16	32 00 00 BA 07 37 30	Heat Sink	放熱板		
17	42 00 00 i L 00 02 30	Insulator AC201	マイカベース		
18	42 00 00 i A 10 50 00	Transistor 2SA1050	トランジスター		
19	42 00 00 i C 24 60 00	—do.—	〃		
20	42 00 00 FA 02 60 80	Pan Head Sems Type Screw(2.6×8)	セムスナベ小ネジ		
21	42 00 00 i L 00 02 70	Insulator AC229	マイカベース		
22	42 00 00 i A 09 68 00	Transistor 2SA968(0,Y)	トランジスター		
23	42 00 00 i C 22 38 00	—do.—	〃		
24	32 00 00 CB 07 28 80	Bush	絶縁ブッシュ		
25	42 00 00 EK 01 00 20	Pan Sems Type Screw(2.6×8)	セムスナベ小ネジ		ZMC2-Y
26	42 00 00 LB 60 26 70	TR Socket	トランジスターソケット	U	
27	32 00 00 NA 07 16 70	Drive Circuit Board	ドライブシート	R,A,E,G,C,B	
	32 00 00 NA 07 17 80	—do.—	〃		
28	32 00 00 CB 08 17 00	Clip	クリップ		
29	32 00 00 AA 09 36 70	Holder For Drive Circuit Board	Dシートホルダー(A)		
30	32 00 00 NA 07 17 00	Power Supply Circuit Board	電源シート	U, C	
	32 00 00 NA 07 22 40	—do.—	〃	R, A	
	32 00 00 NA 07 22 50	—do.—	〃	E, G, B	
31	42 00 00 GA 61 69 00	Power Transformer	電源トランス	U	
	42 00 00 GA 61 70 00	—do.—	〃	A, B	
	42 00 00 GA 62 26 00	—do.—	〃	E	
	42 00 00 GA 62 35 00	—do.—	〃	C	
	42 00 00 GA 62 36 00	—do.—	〃	R	
	42 00 00 GA 62 40 00	—do.—	〃	G	
32	42 00 00 ED 35 00 80	Bind Head Screw(5×8) FCM3-B#	鉄バンド小ネジ		
33	42 00 00 CB 08 77 40	Leg	脚		
34	42 00 00 Ei 04 02 00	Bind Head Tapping Screw(4×20) ZMC2-Y	鉄バンドタッピングネジ		
35	32 00 00 CB 08 73 70	Spacer	スペーサー		
36	32 00 00 AA 09 36 90	M-Circuit Board Stay	Mシートステイ		

Ref. No.	Part No.	Description	(部 品 名)	Markets	Remarks
	32 00 00 NA 07 17 00	Power Supply Circuit Board.	電源シート	U.C	
C601 C604	42 00 00 FZ 00 06 50	Mylar Capacitor 0.01 μ F, 630V(M)	マイラコン		
C605 C606	42 00 00 FZ 00 13 80	Electrolytic Capacitor Vert 15000 μ F, 75V	ケミコンタテ型		
C607	42 00 00 FA 41 43 30	Mylar Capacitor 0.033 μ F, 50V(K)	マイラコン		
C608	42 00 00 FJ 24 71 00	Electrolytic Capacitor Vert 10 μ F, 25V	ケミコンタテ型		
C609	42 00 00 FJ 24 91 00	-do.- 1000 μ F, 25V	〃		
C610 C611	42 00 00 FJ 23 71 00	-do.- 10 μ F, 16V	〃		
C612	42 00 00 FZ 00 06 50	Mylar Capacitor 0.01 μ F, 630V(M)	マイラコン		
C613 C614	42 00 00 FJ 29 81 00	Electrolytic Capacitor Vert 100 μ F, 100V	ケミコンタテ型		
C615	42 00 00 FJ 24 81 00	-do.- 100 μ F, 25V	〃		
C616	42 00 00 FM 39 74 70	-do.- 47 μ F, 16V	〃		
C617	42 00 00 FM 42 51 00	-do.- 0.1 μ F, 50V	〃		
C618	42 00 00 FM 22 62 20	B.P Capacitor 2.2 μ F, 25V	バイポーラコン		
C619	42 00 00 FM 11 71 00	-do.- 10 μ F, 50V	〃		
C620	42 00 00 FM 42 51 00	Electrolytic Capacitor Vert 0.1 μ F, 50V	ケミコンタテ型		
C621	42 00 00 FM 42 56 80	-do.- 0.68 μ F 50V	〃		
C622	42 00 00	-do.-	〃		
C623	42 00 00 FJ 23 71 00	-do.- 10 μ F, 16V	〃		
C624 C625	42 00 00 FA 41 33 90	Mylar Capacitor 0.0047 μ F, 50V(K)	マイラコン		
C626 C628	42 00 00 FA 41 43 30	-do.- 0.033 μ F, 50V(K)	〃		
C630 C631	42 00 00 FG 11 34 70	Ceramic Capacitor 0.0047 μ F, 50V(K)	セラコン		
L601 L602	42 00 00 GD 90 01 90	Coil 3 μ H	空芯コイル		
R601	42 00 00 HL 52 72 20	Metal Oxide Film Resistor 2P 22K Ω	酸化抵抗		
R602	42 00 00 HK 15 62 70	Carbon Resistor, FCR25(J) 2.7K Ω	カーボン抵抗		
R603 R604	42 00 00 HK 15 61 00	-do.- 1K Ω	〃		
R605	42 00 00 HL 32 62 70	Metal Oxide Film Resistor 2P 2.7K Ω	酸化抵抗		
R607	42 00 00 HK 15 72 20	Carbon Resistor, FCR25(J) 22K Ω	カーボン抵抗		
R608	42 00 00 HK 15 53 30	-do.- 330 Ω	〃		
R609	42 00 00 HK 15 71 00	-do.- 10K Ω	〃		
R610	42 00 00 HK 15 81 00	-do.- 100K Ω	〃		
R611	42 00 00 HK 15 71 00	-do.- 10K Ω	〃		
R612	42 00 00 HK 15 51 00	-do.- 100 Ω	〃		
R613	42 00 00 HK 15 73 30	-do.- 33K Ω	〃		
R614 R615	42 00 00 HK 15 75 60	-do.- 56K Ω	〃		
R616	42 00 00 HK 15 54 70	-do.- 470 Ω	〃		
R617	42 00 00 HK 15 52 70	-do.- 270 Ω	〃		
R618	42 00 00 HK 15 91 00	-do.- 1M Ω	〃		
R619	42 00 00 HK 15 91 00	-do.- 1M Ω	〃		
R620 R621	42 00 00 HK 15 82 20	-do.- 220K Ω	〃		
R622 R623	42 00 00 HK 15 74 70	-do.- 47K Ω	〃		
R624	42 00 00 HK 15 54 70	-do.- 470 Ω	〃		
R625	42 00 00 HK 15 52 70	-do.- 270 Ω	〃		
R626 R627	42 00 00 HK 15 91 00	-do.- 1M Ω	〃		
R628 R629	42 00 00 HK 15 72 20	-do.- 22K Ω	〃		
R630 R631	42 00 00 HK 15 62 70	-do.- 2.7K Ω	〃		

Ref. No.	Part No.	Description	(部 品 名)	Markets	Remarks
R632 R633	42 00 00 HL 32:41:00	Metal Oxide Film Resistor 2P 10Ω	酸化抵抗		
R634 R635	42 00 00 HZ 00:07:10	Fire Proof Resistor 1P 4.7Ω	不燃性抵抗		
R637 R638	42 00 00 HK 15:58:20	Carbon Resistor FCR25(J) 820Ω	カーボン抵抗		
R639	42 00 00 HK 15:53:30	-do.- 330Ω	"		
VR601 VR602	42 00 00 HT 41:03:00	Semi VR SR-19R 1.5K(B)	ソリッドVR		
TR601	42 00 00 i D 02:34:30	Transistor 2SD234(O.Y)	トランジスター		
TR602	42 00 00 i C 23:20:10	-do.- 2SC2320(E.F)	"		
TR603	42 00 00 i B 05:44:00	-do.- 2SB544	"		
TR604 TR606	42 00 00 i C 23:20:10	-do.- 2SC2320(E.F)	"		
TR607 TR608	42 00 00 i A 07:33:40	-do.- 2SA733(Q.P)	"		
TR609 TR610	42 00 00 i C 23:20:10	-do.- 2SC2320(E.F)	"		
TR611	42 00 00 i A 07:33:40	-do.- 2SA733(Q.P)	"		
TR612 TR613	42 00 00 i C 23:20:10	-do.- 2SC2320(E.F)	"		
D601	42 00 00 i H 00:04:40	Diode SS-7R	ダイオード		
D602	42 00 00 i H 00:04:30	-do.- SS-7	"		
D603 D604	42 00 00 i H 00:04:70	-do.- 1D-4B1	"		
D605	42 00 00 F 00:03:50	Zener Diode WZ-130	ツェナーダイオード		
D606 D607	42 00 00 i F 00:03:20	-do.- WZ-061	"		
D608 D609	42 00 00 i H 00:02:40	Diode 1S-1885	ダイオード		
D610	42 00 00 i F 00:00:40	-do.- 1S-1555	"		
D611	42 00 00 i H 00:02:40	-do.- 1S-1885	"		
IC601	42 00 00 i G 03:07:00	IC TA7318P	I C		
F601	42 00 00 KB 00:02:10	Fuse 1AT 125V	ヒューズ	R, A	
F602 F603	42 00 00 KB 00:02:00	-do.- 0.5AT 125V	"	R, A	
F601	42 00 00 KB 00:07:30	Fuse S 1AT 250V	ヒューズS	E, G, B	
F602 F603	42 00 00 KB 00:07:10	-do.- 500mA 250V	"	E, G, B	
F601	42 00 00 KB 00:10:20	Fuse UL SS-2,1A 250V	ヒューズUL	U, C	
F602 F603	42 00 00 KB 00:10:10	-do.- 0.5A 250V	"	U, C	
RY601 RY602	42 00 00 KC 00:06:60	Relay MS 12D4-MO 12V	リレー		
	42 00 00 MZ 07:42:00	Power Conneter Ass'y	電源コネクタ Ass'y		
	42 00 00 BB 00:44:30	Contact SHF-001T-08CS	コンタクト		
	42 00 00 LB 50:02:40	Housing H5P-SHF	ハウジング		
	32 00 00 M 06:77:10	Ribbon Wire(Orange) UL2488 4P	リボンワイヤー		
	32 00 00 BA 06:77:80	Heat Sink SE-55 A=36	放熱板		
	32 00 00 BB 06:74:40	Plate For Earth #6744	アース板		
	32 00 00 AA 09:48:20	Band For Electrolytic Capacitor #9482	ケミコンバンド		
	32 00 00 LA 00:05:30	Eyelet VF	羽付ハトメナカダチ		
	32 00 00 LB 20:09:00	Fuse Holder Pin YSH402P	ヒューズホルダーピン	R, U, A, C	
	32 00 00 LB 20:10:60	-do.- YSH403T	"	E, G, B	
	32 00 00 LB 30:07:30	Post Top With Base B3P-SHF-1AA	ベース付ポストトップ型		
	32 00 00 LB 40:05:10	Flection Lock Wafer 5142-04A	フリクションロックウエハー		
	32 00 00 LB 40:05:70	Post Top With Base B4P-SHF-1AA	ベース付ポストトップ型		
	32 00 00 LB 50:02:50	-do.- B5P-SHF-1AA	"		
	42 00 00 ED 03:00:80	Bind Head Screw(3×8) ZMC2-Y	鉄バインド小ネジ		
	42 00 00 ED 03:31:20	-do.- (3×12) FCM3-Bf	"		

Ref. No.	Part No.	Description	(部 品 名)	Markets	Remarks
	32 00 00 NA 07 16 70	Drive Circuit Board	ドライブシート	U	
C401 C402	42 00 00 F J 23 71 00	Electrolytic Capacitor 10 μ F 16V	ケミコンタテ型		
C403 C404	42 00 00 F A 41 41 00	Mylar Capacitor 0.01 μ F 50V(K)	マイラーコン		
C405 C406	42 00 00 F F 07 14 70	Polystyrene Capacitor 47PF 500V(K)	スチコン		
C407 C408	42 00 00 F A 41 44 70	Mylar Capacitor 0.047 μ F	マイラーコン		
C409 C412	42 00 00 F A 41 34 70	-do.- 0.0047 μ F	〃		
C413 C414	42 00 00 F A 41 44 70	-do.- 0.047 μ F	〃		
C415 C418	42 00 00 F A 41 31 00	-do.- 0.001 μ F 50V(K)	〃		
C419 C420	42 00 00 F A 41 41 00	-do.- 0.01 μ F	〃		
C421 C422	42 00 00 F F 07 13 30	Polystyrene Capacitor 33PF 500V(K)	スチコン		
C423 C424	42 00 00 F A 41 31 50	Mylar Capacitor 0.0015 μ F 50V(K)	マイラーコン		
C425 C426	42 00 00 F A 41 41 00	-do.- 0.01 μ F	〃		
C427 C428	42 00 00 F A 41 31 80	-do.- 0.0018 μ F	〃		
C429 C430	42 00 00 F F 07 13 30	Polystyrene Capacitor 33PF 500V(K)	スチコン		
C431 C432	42 00 00 F A 11 51 00	Mylar Capacitor 0.1 μ F	マイラーコン		
C433 C436	42 00 00 F A 41 44 70	-do.- 0.047 μ F	〃		
C437 C438	42 00 00 F Z 00 06 80	MM Capacitor 0.1 μ F 250V	MMコン		
C439 C440	42 00 00 F F 07 14 70	Polystyrene Capacitor 47PF 500V(K)	スチコン		
R401 R402	42 00 00 H K 15 61 20	Carbon Resistor FCR(J) 1.2K Ω	カーボン抵抗		
R403 R404	42 00 00 H K 15 62 20	-do.- 2.2K Ω	〃		
R405 R406	42 00 00 H K 15 64 70	-do.- 4.7K Ω	〃		
R407 R410	42 00 00 H K 15 71 00	-do.- 10K Ω	〃		
R411 R412	42 00 00 H L 31 46 80	Metal Oxide Film Resistor 1P 68 Ω	酸化抵抗		
R413 R414	42 00 00 H K 15 61 50	Carbon Resistor FCR25(J) 1.5K Ω	カーボン抵抗		
R415 R418	42 00 00 H K 15 71 00	-do.- 10K Ω	〃		
R419 R420	42 00 00 H K 15 61 50	-do.- 1.5K Ω	〃		
R421 R422	42 00 00 H K 15 54 70	-do.- 470 Ω	〃		
R423 R424	42 00 00 H L 31 46 80	Metal Oxide Film Resistor 1P 68 Ω	酸化抵抗		
R425 R426	42 00 00 H V 35 44 70	Fire Proof Carbon Resistor 1/4P 47 Ω	不燃性抵抗		
R427 R428	42 00 00 H Z 00 07 10	-do.- 1P 4.7 Ω	〃		
R429 R430	42 00 00 H K 15 41 00	Carbon Resistor FCR25(J) 10 Ω	カーボン抵抗		
R431 R432	42 00 00 H V 35 44 70	Fire Proof Carbon Resistor 1/4P 4.7 Ω	不燃性抵抗		
R435 R436	42 00 00 H Z 00 07 10	-do.- 1P 4.7 Ω	〃		
R437 R438	42 00 00 H K 15 41 00	Carbon Resistor FCR25(J) 10 Ω	カーボン抵抗		
R439 R440	42 00 00 H M 85 24 70	Cement Molded Resistor 5P 0.47 Ω	セメント抵抗無誘導		
R447 R450	42 00 00 H K 15 41 00	Carbon Resistor FCR25(J) 10 Ω	カーボン抵抗		
R451 R454	42 00 00 H Z 00 07 10	Fire Proof Resistor 1P 4.6 Ω	不燃性抵抗		
R455 R458	42 00 00 H V 35 44 70	Fire Proof Carbon Resistor 1/4P 47 Ω	不燃性カーボン抵抗		
R459 R460	42 00 00 H M 85 41 00	Cement Molded Resistor 5P 10 Ω	セメント抵抗無誘導		
R461 R464	42 00 00 H K 15 54 70	Carbon Resistor FCR25(J) 470 Ω	カーボン抵抗		
VR41 VR42	42 00 00 H T 41 01 50	Semi Variable Resistor SCR29R 4.7K(B)	ソリッド半固定 VR		
FR401 FR404	42 00 00 H W 19 53 90	Fuse Resistor 390 Ω 25mA	ヒューズ抵抗	R,A,E,G,C,B	
FR401 FR404	42 00 00 H W 29 53 90	-do.-	〃	U	
FR405 FR408	42 00 00 H W 19 56 80	-do.- 680 Ω 19mA	〃	R,A,E,G,C,B	
FR405 FR408	42 00 00 H W 29 56 80	-do.-	〃	U	

Ref. No.	Part No.	Description	(部 品 名)	Markets	Remarks
FR407 FR408	42:00:00:HW:19:43:30	Fuse Resistor 33Ω 85mA	ヒューズ抵抗	R,A,E,G,C,B	
FR407 FR408	42:00:00:HW:29:43:30	-do.-	〃	U	
FR409 FR410	42:00:00:HW:19:34:70	-do.- 4.7Ω 230mA	〃	R,A,E,G,C,B	
FR409 FR410	42:00:00:HW:29:34:70	-do.-	〃	U	
* TR401 TR402	42:00:00: C:23:20:10	Transistor 2SC2320(E,F)	トランジスター		
TR403 TR404	42:00:00: A:09:41:00	-do.- 2SA941(GR, BL)	〃		
TR405 TR406	42:00:00: C:12:13:10	-do.- 2SC1213A(C,D)	〃		
TR407 TR408	42:00:00: A:06:73:10	-do.- 2SA673A(C, D)	〃		
* TR409 TR410	42:00:00: D:07:57:00	-do.- 2SD757(C, D)	〃		
* TR411 TR412	42:00:00: B:07:17:00	-do.- 2SB717(C, D)	〃		
TR413 TR414	42:00:00: C:22:38:00	-do.- 2SC2238(O, Y)	〃		
TR415 TR416	42:00:00: A:09:68:00	-do.- 2SA968(O, Y)	〃		
D401 D402 D403 D404 D405 D406 D407 D408 D409 D410 D411 D412	42:00:00: F:00:07:50	Diode 1S-2462	ダイオード		
	42:00:00: F:00:00:40	-do.- 1S-1555	〃		
	42:00:00: H:00:02:40	-do.- 1S-1885	〃		
* 32:00:00:MZ:07:41:90	Drive Connector Ass'y		ドライブコネクタ Ass'y		
32:00:00:BB:00:44:30	Contact SHF-001T-08CS		コンタクト		
32:00:00:LB:10:02:70	Connector Terminal 2478-T		コネクタコネク ターミナル通線状		
32:00:00:LB:30:07:20	Housing H3P-SHF		ハウジング		
32:00:00:LB:40:04:10	Connector Housing 4P 5065-04		4Pコネクタコ ンハウジング組立付		
32:00:00:Mi:06:71:10	Ribbon Wire (Orange) 2P UL2468		リボンワイヤー		
32:00:00:LA:00:24:20	L Type Wrapping Terminal Plate 3P, P=10		L型ラッピング端子板		
32:00:00:LA:00:28:70	Eyelet For Power Transistor		パワーTR用ハトメ		
32:00:00:BB:06:62:50	Transistor Pusher		TRプッシャー		
32:00:00:NA:07:16:80	Pre Drive Circuit Board		プリドライブシート	U	
C201 C202	42:00:00:FD:15:14:70	Polystyrene Capacitor Vert 47PF 50V(J)	ステコン		
C203 C204	42:00:00:FJ:28:71:00	Electrolytic Capacitor Vert 10μF 80V	ケミコンタテ型		
C207 C208	42:00:00:FA:45:31:50	Mylar Capacitor 0.0015μF 50V(J)	マイラーコン		
C209 C210	42:00:00:FA:41:41:00	-do.- 0.01μF 50V(K)	〃		
C213 C214	42:00:00:FD:15:21:50	Polystyrene Capacitor Vert 150PF 50V(J)	ステコン		
C215 C216	42:00:00:FF:07:12:70	-do.- 27PF 500V(K)	〃		
C217 C220	42:00:00:FJ:28:71:00	Electrolytic Capacitor Vert 10μF 80V	ケミコン		
C221 C224	42:00:00:FA:41:34:70	Mylar Capacitor 0.0047μF 50V(K)	マイラーコン		
C225 C226	42:00:00:FJ:22:81:00	Electrolytic Capacitor Vert 100μF 10V	ケミコン		
C227 C230	42:00:00:FA:41:34:70	Mylar Capacitor 0.0047μF 50V(K)	マイラーコン		
C231 C232	42:00:00:FJ:19:61:00	Electrolytic Capacitor Vert 1μF 100V	ケミコン		
R201 R202	42:00:00:HK:15:44:70	Carbon Resistor FCR25(J) 47Ω	カーボン抵抗		
R203 R204	42:00:00:HK:15:81:50	-do.- 150KΩ	〃		
R205 R206	42:00:00:HK:15:41:80	-do.- 18Ω	〃		
R207 R208	42:00:00:HK:15:74:70	-do.- 47KΩ	〃		
R209 R210	42:00:00:HK:15:71:50	-do.- 15KΩ	〃		
R211 R212	42:00:00:HK:15:62:20	-do.- 2.2KΩ	〃		
R213 R214	42:00:00:HK:15:43:90	-do.- 39Ω	〃		

Ref. No.	Part No.	Description	(部 品 名)	Markets	Remarks
R215 R216	42 00 00 HK 15 62 20	Carbon Resistor FCR25(J) 2.2K Ω	カーボン抵抗		
R221	42 00 00 HK 15 71 00	-do.- 10K Ω	//		
R225 R226	42 00 00 HK 15 71 50	-do.- 15K Ω	//		
R229 R235	42 00 00 HK 15 46 80	-do.- 68 Ω	//		
R231 R236	42 00 00 HK 15 71 50	-do.- 15K Ω	//		
R237 R238	42 00 00 HU 07 61 50	Metal Film Resistor RE35 1.5K Ω	金属被膜		
R239 R240	42 00 00 HU 07 61 20	-do.- 1.2K Ω	//		
R241 R242	42 00 00 HK 15 51 00	Carbon Resistor FCR25(J) 100 Ω	カーボン抵抗		
R243 R244	42 00 00 HK 15 68 20	-do.- 8.2K Ω	//		
R245 R246	42 00 00 HK 15 66 80	-do.- 6.8K Ω	//		
R247 R248 R252	42 00 00 HK 15 46 80	-do.- 68 Ω	//		
R249 R250	42 00 00 HK 15 52 20	-do.- 200 Ω	//		
R253 R254	42 00 00 HK 15 51 00	-do.- 100 Ω	//		
R256 R258	42 00 00 HK 15 81 00	-do.- 100K Ω	//		
R259 R260	42 00 00 HK 15 51 00	-do.- 100 Ω	//		
R261 R262	42 00 00 HK 15 63 90	-do.- 3.9K Ω	//		
R263 R264	42 00 00 HK 15 73 30	-do.- 33K Ω	//		
R265 R266	42 00 00 HK 15 72 70	-do.- 27K Ω	//		
R269 R270	42 00 00 HK 15 63 90	-do.- 3.9K Ω	//		
R271 R272	42 00 00 HU 47 71 80	Metal Film Resistor RE50 18K Ω	金属被膜		
R273 R274	42 00 00 HK 15 75 60	Carbon Resistor FCR25(J) 56K Ω	カーボン抵抗		
R275 R276	42 00 00 HK 15 65 60	-do.- 5.6K Ω	//		
R277 R280	42 00 00 HU 07 73 90	Metal Film Resistor RE35 39K Ω	金属被膜		
R281 R282	42 00 00 HK 15 73 30	Carbon Resistor FCR25(J) 33K Ω	カーボン抵抗		
R283 R284	42 00 00 HK 15 52 20	-do.- 220 Ω	//		
R287 R290	42 00 00 HK 15 75 60	-do.- 56K Ω	//		
R291 R292	42 00 00 HK 15 55 60	-do.- 560 Ω	//		
R293 R294	42 00 00 HK 15 52 20	-do.- 220 Ω	//		
R295 R296	42 00 00 HK 15 71 50	-do.- 15K Ω	//		
VR201 VR202	42 00 00 HT 41 02 90	Variable Resistor SR29R 100(B)	ソリッドVR		
VR203 VR204	42 00 00 HT 41 01 60	-do.- 2.2K(B)	//		
FR201 FR204	42 00 00 HW 19 43 30	Fuse Resistor 33 Ω 85mA	ヒューズ抵抗	R,A,E,G,C,B	
FR201 FR204	42 00 00 HW 29 43 30	-do.- 33 Ω 85mA	//	U	
TR201 TR202	42 00 00 i A 07 33 40	Transistor 2SA733(Q,P)	トランジスタ		
TR203 TR204	42 00 00 i E 10 14 00	Deul FET 2SK150(G,R)	F E T		
TR205 TR206	42 00 00 i A 07 98 00	Transistor 2SA798(G,H)	トランジスタ		
TR207 TR208	42 00 00 i A 09 95 00	-do.- 2SA995(F,G,H)	//		
TR209 TR216	42 00 00 i C 20 88 00	-do.- 2SC2088(GR,BL,V)	//		
TR217 TR220	42 00 00 i A 08 44 00	-do.- 2SA844(C,D,E)	//		
TR221 TR222	42 00 00 i A 09 14 50	-do.- 2SA914(Q,R,S,T)	//		
TR223 TR226	42 00 00 i C 19 53 50	-do.- 2SC1953(Q,R,S,T)	//		
TR227 TR230	42 00 00 i C 04 58 30	-do.- 2SC458(C,D)	//		
TR231 TR232	42 00 00 i C 16 24 00	-do.- 2SC1624(O,Y)	//		
TR233 TR236	42 00 00 i C 20 88 00	-do.- 2SC2088(GR,BL,V)	//		
TR235 TR236	42 00 00 i A 09 41 00	-do.- 2SA941(GR,BL)	//		

Ref. No.	Part No.	Description	(部 品 名)	Markets	Remarks
TR239 TR242	42:00:00;A:09:41:00	Transistor 2SA941(GR,BL)	トランジスター		
TR243 TR244	42:00:00;C:16:24:00	-do.- 2SC1624(O,Y)	〃		
D201 D202	42:00:00;F:00:00:40	Diode 1S-1555	ダイオード		
D203 D204	42:00:00;F:00:07:90	Naristor MV-12	バリスタ		
D205 D206	42:00:00;F:00:03:20	Zener Diode WZ-061	ツェナーダイオード		
	42:00:00;BA:07:28:30	Heat Sink #07283	放熱板		
	42:00:00;ED:03:00:60	Bind Head Screw(3×6) ZMC2-Y	鉄バンド小ネジ		
	42:00:00;LA:00:24:20	L Type Lapping Plate 3P P=10	L型ラッピング端子板		
	42:00:00;LB:30:07:30	Post Top With Base B3P-SHF-1AA	3Pベース付ポストトップ型		
	42:00:00;LB:50:02:50	-do.- B5P-SHF-1AA	5Pベース付ポストトップ型		
	32:00:00;NA:07:17:40	Indicator Circuit Board			
R701	42:00:00;HK:15:62:20	Carbon Resistor FCR-25(J) 2.2KΩ	カーボン抵抗		
R702	42:00:00;HK:15:54:70	-do.- 470Ω	〃		
R703 R704	42:00:00;HK:15:71:00	-do.- 10KΩ	〃		
R707 R708	42:00:00;HK:15:61:50	-do.- 1.5KΩ	〃		
R709 R712	42:00:00;HK:15:61:20	-do.- 1.2KΩ	〃		
R713 R728	42:00:00;HK:15:61:50	-do.- 1.5KΩ	〃		
* D701	42:00:00;F:00:12:80	LED SLB-26UR1	LED		
* D704 D706 D728	42:00:00;F:00:12:90	LED SLB-26GG1	〃		
D729	42:00:00;F:00:10:70	Zener Diode HZ-6B	ツェナーダイオード		
* IC701 IC702	42:00:00;G:03:06:00	IC TA7612AP	IC		
* 32:00:00;MZ:07:42:10	Indicator Connector Ass'y	インジケータークネクタ-Ass'y			
42:00:00;BB:00:44:30	Contact SHF-001T-08CS	コンタクト			
42:00:00;LB:30:07:20	Housing H3P-SHF	ハウジング			
* 42:00:00;LB:40:05:60	-do.- H4P-SHF	〃			
* 42:00:00;Mi:06:74:40	Ribbon Wire(Orange) UL2468 3P	リボンワイヤー			
* 42:00:00;Mi:06:77:40	-do.- 4P	〃			
* 42:00:00;CB:08:85:70	LED Holder #8857	LEDホルダー			
* 42:00:00;BA:07:45:00	LED Plate #7450	LEDプレート			
42:00:00;EN:03:00:20	Bind Head Tapping Screw Type I(3×8) ZMC2-Y	鉄バンドタッピングネジ 2種ミソ			