

API Model 1608 Recording Console Operator's Manual



Important Safety Instructions

1. Please read these instructions
2. Keep this Manual in a safe place
3. Do not use this console near water
4. Clean only with a dry cloth
5. Do not block any ventilation openings
6. Do not install near any heat sources such as radiators, heat registers, stoves, or other devices (including the power supply) that produce heat
7. Do not defeat the safety purpose of the polarized or grounding type AC plug
8. Protect both the AC power cord to the power supply and the DC cable between the supply and the console from being walked on or pinched
9. Use only attachments/accessories specified by the manufacturer
10. Unplug this device during lightning storms or when unused for long periods of time
11. Refer all service to qualified personnel

ATTENTION: Exposure to extremely high noise levels may cause permanent hearing loss or damage. Individuals vary considerably in susceptibility to noise-induced hearing loss, but nearly everyone will lose some hearing if exposed to sufficiently intense noise (or even music) for a period of time. Be safe.

WARNING – To reduce the risk of fire or electric shock, do not expose this apparatus to rain or moisture.

This page left blank.

Introduction

Thank you for choosing API's 1608 analog mixing console. Whether you are a newcomer to API or are already a part of the nearly 40-year tradition of API excellence, we appreciate your purchase.

The 1608 small format recording console is based on the designs of the original API 1604 built in the 70's and early 80's. The success of the 1604 and the continued demand for a small footprint, high quality console has produced the 1608.

API takes great pride - and great care - in the hand assembly of all our professional audio products. Above all, we appreciate our loyal users - those who create, track, mix, engineer, master, and produce - who have made the Company what it is today.

Table of Contents

- 1.0 Overview**
- 2.0 548B Channel Module**
 - 2.1 440B Fader Module
 - 2.2 Mute/Solo Section
 - 2.3 Preamp Section
 - 2.4 Echo/Auxiliary Sends
 - 2.5 Routing and Output Section
 - 2.6 550A Equalizer
 - 2.7 560 Equalizer
 - 2.8 548B Connections
- 3.0 E1608 Echo Send/Return Module**
 - 3.1 Echo Send Section
 - 3.2 Echo Return Section
 - 3.3 Echo Return 500 Slots
 - 3.4 E1608 Connections
- 4.0 168B Summing Bus Sub-master Module**
 - 4.1 Summing Bus Sub-masters
 - 4.2 168B Connections
- 5.0 268B Program Bus Output Master and Monitor Output Module**
 - 5.1 Program Bus Output Masters
 - 5.2 440B Stereo Master Fader Module
 - 5.3 Monitor Output Controls
 - 5.4 268B Connections
- 6.0 845B Control Room Monitor Module**
 - 6.1 Control Room Monitor Controls
 - 6.2 Control Room Monitor Source Selectors
 - 6.3 845B Connections
- 7.0 840B Central Facilities Module**
 - 7.1 Headphone Amplifier
 - 7.2 Talkback
 - 7.3 Mute Group
 - 7.4 Aux Pre = Mute
 - 7.5 Solo Master
 - 7.6 Channel Meter Control
 - 7.7 Peak Threshold
 - 7.8 Oscillator
 - 7.9 840B Connections
 - 7.10 Headphone Jack
- 8.0 Meter Bridge**
 - 8.1 Channel/Bus Meters
 - 8.2 Left and Right Program Meters
 - 8.3 Echo Send/Return Meters
 - 8.4 Power Supply Voltage Indicators
 - 8.5 Talkback Microphone

9.0 Rear Panel

- 9.1 548B Channel Module Connections
- 9.2 E1608 Echo Send/Return Connections
 - 9.2.1 Echo Sends
 - 9.2.2 Echo Returns
 - 9.2.3 Echo Return 500 Slots
- 9.3 168B Summing Bus Sub-master (ACA) Connections
 - 9.3.1 Summing Bus Sub-master Outputs
 - 9.3.2 Program Bus Mix Inputs
- 9.4 268B Program Bus/Master Output Connections
- 9.5 268B Control Room Monitor Output Connections
- 9.6 845B 6-Track Playback Input Connections
- 9.7 840B Ancillary Connections
 - 9.7.1 Talkback Remote Port and Oscillator Output
 - 9.7.2 Stereo Headphone Output
- 9.8 Expander Port
- 9.9 PSU Connection

10.0 Application Guide

- 10.1 Multitrack Recording
- 10.2 Multichannel Mixing
- 10.3 DAW Hybrid
- 10.4 E1608 Echo Send Applications
- 10.5 E1608 Echo Return Applications
- 10.6 168B Summing Bus and Sub-master Applications
- 10.7 Echo Return 500 Slot Applications
- 10.8 Rear Panel DB25 Connection Diagrams

1.0 Overview



Building on API's rich heritage of extremely high quality recording consoles, we are proud to introduce the new Model 1608, a full featured small format recording console based on the vintage API 1604 console, which has held its demand and value for over three decades.

The 1608 gives all of the advantages of the 1604 Vintage Consoles while adding new, modern features valuable to today's Engineers, Producers and Musicians.

Features

- 16 Input Channels each with Mic Pre and Equalizer
- Accepts up to eight API 500 Series Modules
- 8 Main Buses
- 8 Auxiliary Buses
- 1 Stereo Bus
- 8 Echo Returns with main and stereo bus assign
- Full Center Section Control
- Analog Metering
- 5.1 Center Section Monitoring
- Comprehensive Rear Patch Connections

The 1608 is built to the same exacting API build standards as our Vision consoles, Legacy consoles, and modular products.

The standard fit of a 1608 Console is:

- 16 548B Inputs with Mic/Line and Direct Output
- 12 550A Equalizers
- 4 560 Equalizers
- 8 Echo Returns
- 1 Complete Central Facilities Section
- 16 Manual Faders
- 1 Stereo Fader

2.0 548B Channel Module

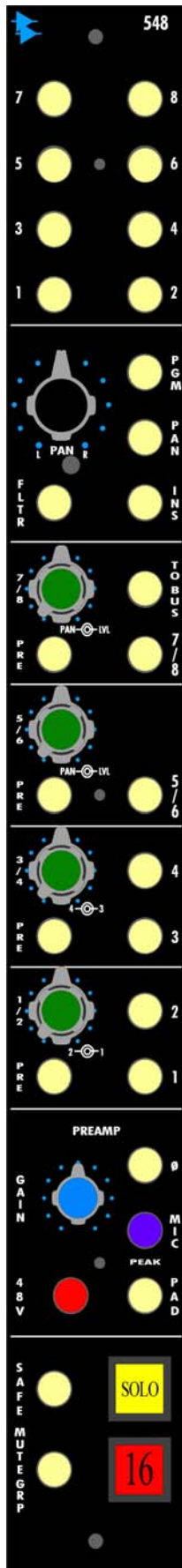

The 548B Channel module provides a single audio path for bringing signals into the console for mixing and/or routing to external destinations. Together with the 440B Fader, it provides a comprehensive audio path for a variety of applications:

- Microphone/instrument/line preamplifier
- Equalizer
- High-pass filter
- Balanced insert
- Eight (8) Echo/Auxiliary Sends
- Fully featured mute and solo section
- Pan-pot
- Direct Output
- Program and Summing Bus assignments

All eight echo/aux sends can be routed either pre or post-fader. Echo/aux Sends 7/8 can be routed to feed the Summing Buses.

The basic signal flow through the 548B Channel module is as follows:

input preamplifier -> equalizer -> insert -> fader/mute -> output routing

2.1 440B Fader Module

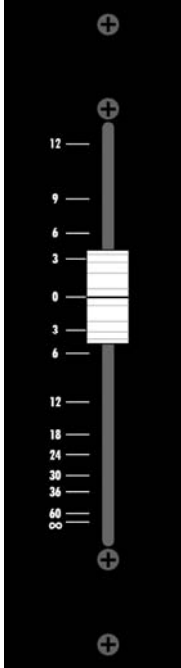

The 440B Mono Fader is the primary output level control for the channel. The channel Fader controls the output to the:

- Direct Output
- Summing Buses
- Program Bus
- Post-fader Echo/Auxiliary Sends
- When the Fader is set to 0dB, the level is at unity gain

Each 440B Mono Fader module contains eight mono Alps 100mm faders and supports the eight channel modules mounted above it

2.2 Mute/Solo Section

The 548B Channel module provides a comprehensive set of solo and mute controls including:

- Channel on/off switch
- AFL, PFL, and SIP Solo functions
- Solo Safe
- Mute Group assignment

The controls for the 548B Mute and Solo function as follows:

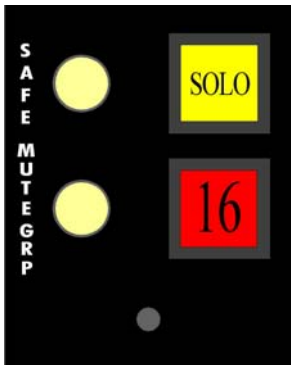

SOLO: Activates the selected solo function

- The following solo functions may be selected via the 845B Central Facilities Module:
 - Pre-fader Listen (PFL): Non-destructive, mono
 - After Fader Listen (AFL): Non-destructive, mono/stereo
 - Solo-In-Place (SIP): Destructive, panned, post-fader
- Illuminates in yellow when engaged

NOTE: PFL is the default solo mode.

NOTE: Channels and Echo Returns must be assigned to the Program Bus for Solo-In-Place for their mutes to activate when other channels or Echo Returns are soloed.

SAFE: Activates the Solo Safe mode for that channel

- The SAFE button protects that channel from being muted when the Solo-In-Place function is active and another channel or an Echo Return is soloed.
- Illuminates when engaged

MUTE: Cuts the primary audio output

- The MUTE button is the on/off switch for the primary channel output and is located post-fader in the signal flow
- The MUTE button is the numbered button located just above each fader
- Illuminates in red when engaged

MUTE GRP (Mute Group): Assigns the channel to the master Mute Group

- All channels assigned to the master Mute Group will mute when the MUTE GROUP button on the 845B Central Facilities Module is pressed
- Illuminates when engaged

NOTE: If the channel MUTE GRP button and the AUX PRE=MTE button on the 845B Central Facilities Module are engaged, all pre-fader Echo/Auxiliary Sends will be muted when the master MUTE GROUP button is engaged.

2.3 Preamp Section

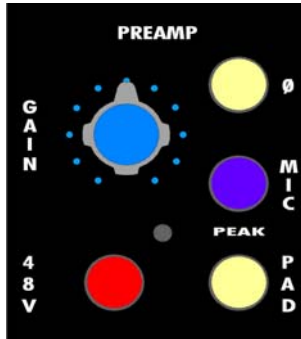

The Preamp section of the 548B provides three audio input options:

- Line Input
- Microphone Input
- Instrument Input

A Peak Indicator is located at the output of the Preamp. The MIC button serves as the Peak Indicator and turns red when peaks cross the threshold set on the 840B Central Facilities Module.

Note: *The Peak Indication LED functions in MIC, LINE or INSTRUMENT mode.*

Line Input: Accepts balanced, low-impedance, line-level signals from the LINE INPUT connector.

The Line Input has the following features:

- -6 dB Pad
- Peak Indicator
- Polarity Inverter (phase reverse)

Note: Line Input is the default channel input.

Microphone Input: Accepts balanced, low-impedance, microphone-level signals from the MIC INPUT connector. It's the classic API 212L microphone preamplifier with the following features:

- +65dB of gain
- -20 dB Pad
- Peak Indicator
- Polarity Inverter (phase reverse)
- 48v Phantom Power

Note: The MIC button must be engaged to use this input.

Note: The signal from the Microphone Input is replaced with the signal from the Instrument Input when a 1/4" plug is inserted in the Instrument Input jack.

Instrument Input: Accepts unbalanced, high-impedance, instrument-level signals from the 1/4" INSTRUMENT INPUT connector. The Instrument Input reduces the need for separate Direct Injection (DI) boxes and has the following features:

- +45dB of gain
- Peak Indicator

Note: The MIC button must be engaged to use this input.

Note: The Instrument Input jack is a switching jack. The signal from the Microphone Input is replaced with the signal from the Instrument Input whenever a 1/4" plug is inserted in the Instrument Input jack.

Note: The Pad and Polarity Inverter (Phase Reverse) do not apply to the Instrument Input. If these functions are needed, the use of an external Direct Injection (DI) box connected to the Microphone Input is suggested.

The controls for the 548B Preamp section function as follows:

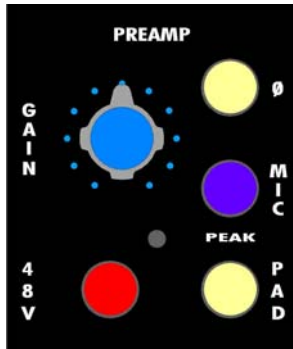

No Buttons Engaged: Line Input selected

- MIC: Selects the Microphone Preamp as the input for the channel
- The MIC button must be engaged for the Instrument Input to be used
 - Illuminates in blue when engaged
 - The MIC button provides a peak Indicator by turning red whenever the peak threshold is crossed

Note: The signal from the Microphone Input is replaced when a 1/4" plug is inserted in the Instrument Input jack.

GAIN: Provides up to +65dB of gain for the Microphone and +45dB for the Instrument Inputs

Line Input: The gain control does **not** affect the Line input

48V: Provides 48 Volt Phantom Power to the MIC INPUT XLR connector on the rear panel

- Illuminates in red when engaged

PAD: Inserts a -20 Pad for the Microphone or a -6dB pad for Line inputs

- Illuminates when engage

φ: Inserts a Polarity Inverter (Phase Reverse) for the Microphone and Line inputs

- Illuminates when engaged

2.4 Echo/Auxiliary Sends

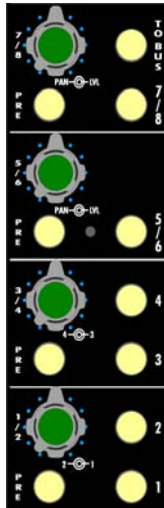

The 548B Channel module provides eight fully functional echo/auxiliary sends, four mono (Sends 1-4) and two stereo (Sends 5/6 and 7/8). Accordingly, the 1608 is equipped with eight balanced Auxiliary Buses and outputs.

- Each mono Echo/Auxiliary Send has an individual level control and an on/off switch
- Each stereo Echo/Auxiliary Send has a stereo level control, a pan-pot, and an on/off switch
- Sends 7 and 8 can be routed to feed the 1-4 Summing Buses only in addition to their Auxiliary Buses

The controls for the 548B mono Echo/Auxiliary Sends 1-4 function as follows:

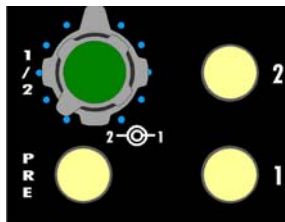

1 and 2 Level: Individual level controls for Sends 1 and 2

1/2 PRE: Routes the pre-fader signal to Sends 1 and 2

- Sends 1 and 2 are fed post-fader when the PRE button is not engaged
- Illuminates when engaged

1 and 2 (buttons): Individual on/off switches for Sends 1 and 2

- Illuminates when engaged

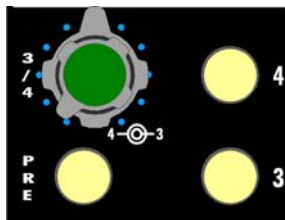

3/4 Level: Individual level controls for Sends 3 and 4

3/4 PRE: Routes the pre-fader signal to Sends 3 and 4

- Sends 3 and 4 are fed post-fader when the PRE button is not engaged
- Illuminates when engaged

3 and 4 (buttons): Individual on/off switches for Sends 3 and 4

- Illuminates when engaged

The controls for the 548B stereo Echo/Auxiliary Sends 5/6 and 7/8 function as follows:

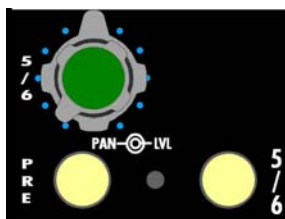

5/6 LVL: Stereo level control for Sends 5 and 6

5/6 PAN: Pan-pot for Sends 5 and 6

5/6 PRE: Routes the pre-fader signal to Sends 5 and 6

- Sends 5 and 6 are fed post-fader when the PRE button is not engaged
- Illuminates when engaged

5/6 (button): On/off switch for Sends 5 and 6

- Illuminates when engaged

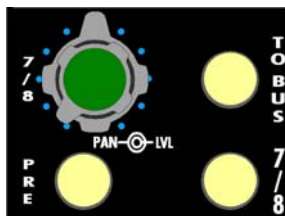

7/8 LVL: Stereo level control for Sends 7 and 8

7/8 PAN: Pan-pot for Sends 7 and 8

7/8 PRE: Routes the pre-fader signal to Sends 7 and 8

- Sends 7 and 8 are fed post-fader when the PRE button is not engaged
- Illuminates when engaged

7/8 (button): On/off switch for Sends 7 and 8

- Illuminates when engaged

TO BUS: Routes the output of stereo Send 7 and 8 directly to the Summing Bus 1-4 assignment section. When TO BUS is engaged the send functions as follows:

- Auxiliary Buses 7 and 8 are fed in addition to the Summing Bus 1-4 assignment section
- Auxiliary Sends 7 and 8 cannot access the Program Bus from the channel module
- The 7/8 on/off button is bypassed for the feed to the Summing Busses, but is still active for the feed to Auxiliary Buses 7 and 8
- The 7/8 PRE button may be used
- The 7/8 stereo level control and pan-pot are active
- The channel output pan-pot is bypassed for Summing Bus assignments from Send 7/8
- Illuminates when engaged

2.5 Routing and Output Section

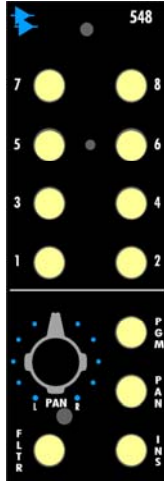

The routing and output section of the 548B Channel module provides a comprehensive set of routing and output functions including:

- Insert
- High-pass filter
- Switchable panning
- Bus assignments
- Direct Output

The output section provides three simultaneous audio output options:

- Direct Output: Direct balanced line output
- Summing Buses: Any of eight summing buses (ACA)
- Program Bus: The Left and Right stereo Program Bus (PGM)

Direct Output: The Direct Output feeds the channel output signal to the DIRECT OUTPUT on the rear panel. The Direct Output has the following features:

- The Direct Output is fed post-fader
- The Direct Output is always active except when the channel MUTE is engaged
- Balanced, line-level output at the DIRECT OUTPUT XLR connector

Summing Buses: The channel output may be assigned to one or more of the eight Summing Buses or Active Combining Amplifiers (ACA). Some possible applications of the Summing Buses include:

- Multitrack channel assignments
- Multitrack summing
- 5.1 mixing
- Additional channel outputs
- Additional echo/auxiliary sends
- Sub-grouping

The summing buses (ACA) include the following features:

- Individual Summing Bus assignments from the 548B modules
- Switchable Odd/Even Summing Bus panning on the 548B modules
- Routing from Echo/Auxiliary Sends 7 and 8 on the 548B modules
- Individual on/off, calibration, trim, solo, and Program Bus assignment controls on the 168B module
- Balanced, line-level outputs at the BUS OUTPUT 1-8 (ACA OUTPUT) sub-D connector

Program Bus: The channel output can be routed to the Program Bus (also ACA) for stereo mixing and for the Left and Right channels of a 5.1 mix. The Program Bus includes the following features:

- Program Bus assignment from the 548B modules
- Program Bus Insert via the 268B module and rear panel connections
- 440B Stereo Master Fader
- Individual Left and Right program channel on/off, calibration, and trim controls
- Balanced, line-level outputs via the LEFT and RIGHT PROGRAM OUTPUT XLR connectors

The controls for the 548B Routing and Output section function as follows:

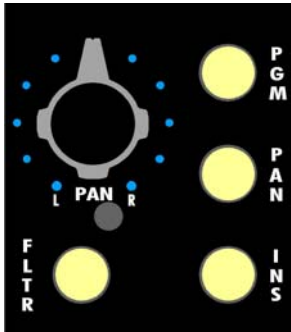

PAN (pan-pot): Provides continuous panning control

- Stereo panning between the Left and Right Program Buses
- Odd and Even panning between Summing Buses (when engaged)

PAN (button): Activates Odd/Even panning between the assigned Summing Buses

- The PAN button must be engaged to enable summing bus panning
- The PAN button only applies to summing bus panning and does not affect Program Bus Left/Right panning
- Illuminates when engaged

PGM (Program): Assigns the channel output to the Program Bus

- The Program Bus is fed post the channel pan-pot
- Illuminates when engaged

FLTR (Filter): Activates the channel output high-pass Filter

- -3 dB at 50Hz
- 6 dB/octave slope
- Illuminates when engaged
- The channel output Filter is located post the Fader wiper and pre the Fader amplifier

Note: An additional band-pass filter is available on channels equipped with 550A Equalizers.

INS (Insert): Activates the channel Insert Return

- The Insert Send is fed pre-fader from the output of the Equalizer
- The Insert Send is always active
- The Insert Send is a balanced, line-level signal routed to the INSERT SEND (EQUALIZER OUTPUT) 1/4" tip-ring-sleeve jack on the rear panel
- The Insert Return accepts a balanced, line-level signal from the INSERT RETURN (FADER INPUT) 1/4" tip-ring-sleeve jack on the rear panel
- The Insert Return is located post-EQ and pre-fader
- The Insert Return is active only when the INS button is engaged
- Illuminates when engaged

Trim-pot: The trim-pot below the channel pan-pot calibrates the FADER IN to the DIRECT OUTPUT stage so the path is exactly at unity gain with the channel fader set to 0dB.

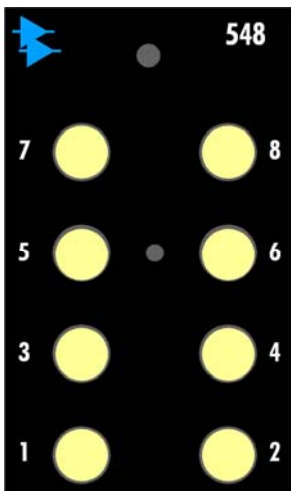

Summing Bus (ACA) Assignment 1-8: Assigns the channel output to one or more of the eight Summing Buses (Active Combining Amplifiers).

- Assignments to the Summing Buses can be made on an individual basis
- Summing Buses are fed post-fader or post the channel pan-pot when it's engaged
- Summing Bus assignments are only active when engaged
- Switchable Odd/Even Summing Bus panning
- The Summing Buses 1-4 can be fed pre or post fader from Echo/Auxiliary Sends 7 and 8

2.6 550A Discrete 3-Band Equalizer

The legendary API 550A Equalizer is installed on channels 1-12 in the standard 1608 configuration.



Features

- 3 bands of classic API equalization
- Each band offers 7 API selected frequency centers
- Reciprocal and repeatable filtering
- maximum 12 dB of boost/cut per band
- EQ Band 1 and 3 offer shelf/peak switching
- "Proportional Q" narrows filter Q at extremes
- Traditional API fully discrete circuit design
- High headroom +30 dB clip level

Few equalizers enjoy the respect and admiration of the coveted API 550A. Designed by the now legendary Saul Walker in the late 60's, the discrete 550A was first used as a modular OEM equalizer. As the industry rapidly embraced the sonic quality of the 550A, it quickly found its way into many custom console designs of the era. Many of these consoles are still in use today.

Forty years later, the 550A remains the standard against which other EQs are measured, and it has played a major role in the recording industry for decades. Still copied but never duplicated, the 550A became API's standard channel module EQ when the company began manufacturing consoles in 1971. With virtually all existing units spoken for, popular demand for this EQ resulted in API resuming production in 2004.

The 550A provides reciprocal equalization at 15 points in 5 steps of boost to a maximum of 12dB of gain at each point. The fifteen equalization points are divided into three overlapping ranges. The high and low frequency ranges are individually selectable as either peaking or shelving, and a band-pass filter may be inserted independently of all other selected equalization settings. Frequency ranges and boost/cut are selected by three dual-concentric switches, and a pushbutton "in" switch allows the EQ to be silently introduced to the signal path. A small toggle switch is used to insert the band-pass filter into the 550A.

The combination of Walker's incomparable 2520 op amp, and his "Proportional Q" circuitry gives the 550A user an uncomplicated way to generate acoustically superior equalization.

With the long-awaited reissue of this unit, an EQ that has had such a part in the history of recording is continuing to make history in today's music.

WARNING – WARNING – WARNING – WARNING – WARNING

The use of NON-VPR Alliance approved 500 series modules in the 1608 is vehemently discouraged, and may cause operational difficulties with the console. Improper operation, excessive current draw and poor module fit are all potential issues with these devices.

For the most recent list of VPR Alliance approved modules, please visit www.apiaudio.com.

API reserves the right to deny warranty claims when non-VPR Alliance 500 series modules are used.

2.7 560 Discrete 10-Band Graphic Equalizer

The classic API 560 Equalizer is installed on channels 13-16 in the standard 1608 configuration.

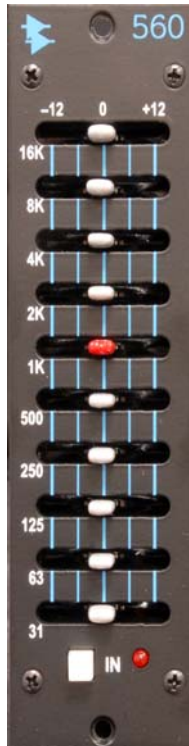

Features

- 10 bands of API proprietary equalization
- Familiar graphics operation on one octave centers
- 12 dB of boost/cut per band
- "Proportional Q" narrows filter Q at extremes
- Additional resolution within the ± 4 region
- Center detent for reliable reset
- Silent bypass button
- Re-issue of the 1969 API 560 EQ

Originally conceived for use in API Consoles of the 60's and 70's, the API 560 is a unique device designed to accomplish tasks that no other EQ can. It delivers that "one-of-a-kind" API sound, precision easy set filtering, and high headroom in a very small package. Extremely fast to set and reset using accurate zero detents, the curve shaping potential of the 560 is unmatched. At home both in field recording and the studio environment, this "new-old" 560 is true to the original 560 with improved resolution in the critical area of ± 4 dB. Incorporating API's exclusive circuitry and proprietary components (such as the legendary 2520 op-amp), the 560 artfully blends the past with present—layout with function.

The API 560 was created to fit all applications for the professional engineer. For most of the 70's and 80's, every remote recording console that API manufactured used this versatile graphic EQ. It is also ideal for studio and live sound applications, where a professional result is required. The current 560 design has been taken from the original blue prints and spec control drawings from the API archives.

The large number of available EQ bands make the 560 an ideal companion to parametric EQ, as well as ideal for signal sweetening and room tuning. Not lacking in features, the 560 makes use of API's unique "Proportional Q" design introduced by API in the 60's, intuitively widening the filter bandwidth at lower boost/cut levels and narrowing it at higher settings. In addition, boost and cut characteristics are identical, so previous actions can be undone.

The extraordinary headroom made possible with API's proprietary 2520 op-amp offers predictable and wonderful "analog" performance under duress. With a wider range of 500 mounting options, the 560 is a valuable asset to your performance-critical applications.

The 560 Graphic Equalizer exhibits the reliability, long life, and uniformity which are characteristic of API products.

WARNING – WARNING – WARNING – WARNING – WARNING

The use of NON-VPR Alliance approved 500 series modules in the 1608 is vehemently discouraged, and may cause operational difficulties with the console. Improper operation, excessive current draw and poor module fit are all potential issues with these devices.

For the most recent list of VPR Alliance approved modules, please visit www.apiaudio.com.

API reserves the right to deny warranty claims when non-VPR Alliance 500 series modules are used.

2.7 548B Connections

The rear panel connections for the 548B Channel module are as follows:

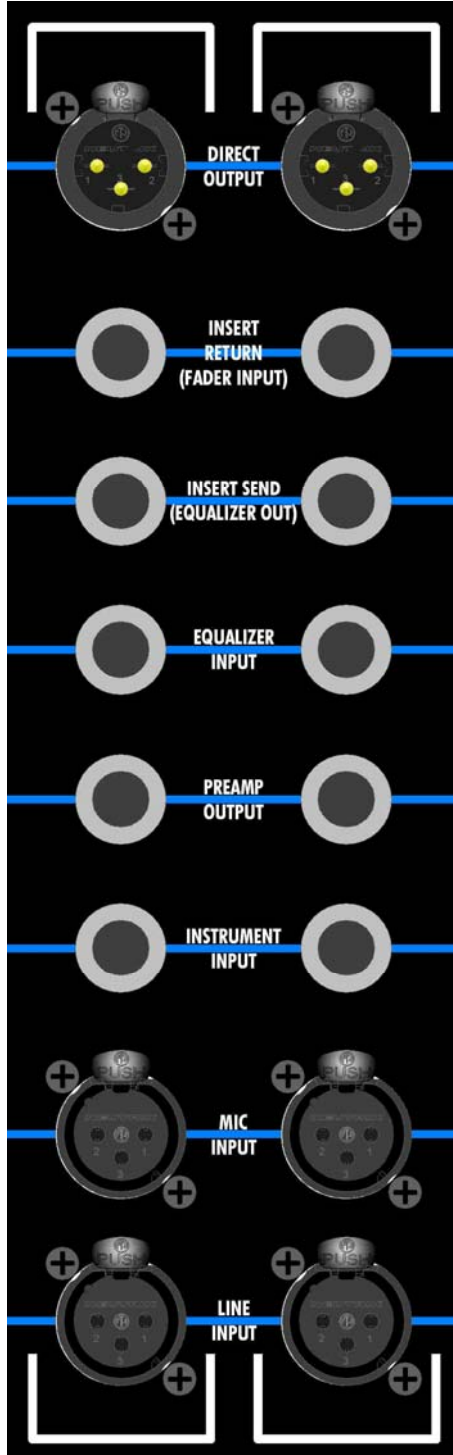

DIRECT OUTPUT:

- Balanced, Line-level
- Male XLR

INSERT RETURN (FADER INPUT):

- Balanced, Line-level
- 1/4" tip-ring-sleeve switching jack
- Replaces the EQ Out signal when a jack is inserted and the INS button is engaged

INSERT SEND (EQUALIZER OUT):

- Balanced, Line-level
- 1/4" tip-ring-sleeve switching jack
- The feed to the Insert Return (Fader Input) is defeated when a jack is inserted

EQUALIZER INPUT:

- Balanced, Line-level
- 1/4" tip-ring-sleeve switching jack
- The Preamp Output signal is replaced with this signal when a jack is inserted

PREAMP OUTPUT:

- Balanced, Line-level
- 1/4" tip-ring-sleeve jack
- Half-normalled to feed the Equalizer Input

INSTRUMENT INPUT:

- Unbalanced, High-impedance
- Instrument-level
- 1/4" tip-sleeve switching jack
- The Microphone Input signal is replaced with this signal when a jack is inserted

MIC INPUT:

- Balanced, Low-impedance
- Microphone-level
- Female XLR connector

LINE INPUT:

- Balanced, Low-impedance
- Line-level
- Female XLR connector

3.0 E1608 Echo Send/Return Module

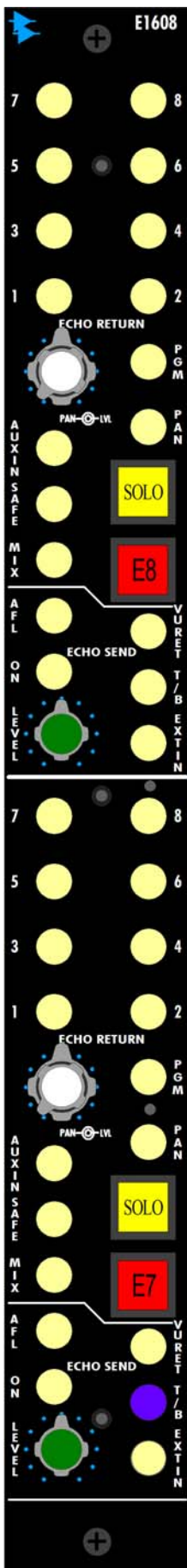

The E1608 Echo Send/Return module serves multiple functions and contributes greatly to the extensive flexibility of the 1608. Some possible applications of the Echo Send/return module include:

- Echo returns from reverbs and effect units
- Additional line-level inputs during tracking or mixing
- Audio sub-grouping
- Echo send masters
- Cue and foldback send masters
- Mix minus matrixes
- Parallel processing

The E1608 Echo Send/Return module has two primary sections:

- Echo Send
- Echo Return

3.1 Echo Send Section

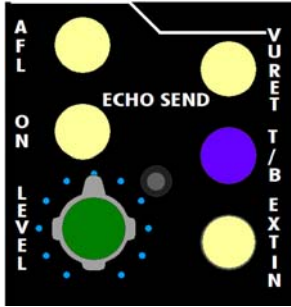

The E1608 ECHO SEND section primarily functions as an echo send master. It can also provide grouping functions when used with the echo sends, external inputs, and the Echo Return section.

It is possible to combine an external audio input with the Echo Bus at the input of the Echo Send section.

The Echo Send section has the following features:

- Flexible input sources (including a combined external input)
- On/off switch
- Level control
- Solo (AFL only)
- Talkback insertion for cue/foldback sends (headphone sends)
- Routing to the Echo Return section
- Balanced, line-level output at the ECHO SENDS OUTPUT 1-8 sub-D connector

The Echo Send section can be fed from two simultaneous sources:

- Auxiliary Bus: The output of its corresponding Echo Sum Bus

and/or

- External Input: ECHO SEND EXTERNAL INPUT 1/4" tip-ring-sleeve jack

Echo Send Master: The Echo Send Master is the master control level for its corresponding Echo Send Bus.

External Audio Input: In addition to the normal feed from its corresponding Echo Sum Bus, the Echo Send can accept a balanced, line-level input from the corresponding ECHO SEND EXTERNAL INPUT 1/4" tip-ring-sleeve jack on the rear panel. This signal is added to the output from the corresponding Echo Sum Bus when the EXT IN button is engaged.

IMPORTANT NOTE: When the EXT IN button is engaged, the external input is *combined* with the output from the corresponding Echo Sum Bus and is fed to the input of the Echo Send section.

Regardless of the input source, the balanced, line-level output of the Echo Send is fed to the ECHO SENDS OUTPUT 1-8 sub-D connector on the rear panel for connection to effects devices, cue/foldback systems, and so on. This output is active whenever the corresponding Echo Send is turned on.

The output of the Echo Send can be selected as the input to its corresponding Echo Return section for additional routing to the Program or Summing Buses. This is done by engaging the MIX button in the Echo Return section. This can be very useful for creating sub-groups, mix minus cue feeds, and other applications.

The output of the Echo Send is also fed to its corresponding meter in the Meter Bridge (E1-E8). The output of the Echo Return section can be sent to the meter instead by engaging the VU RET button.

The controls for E1608 Echo Send section function as follows:

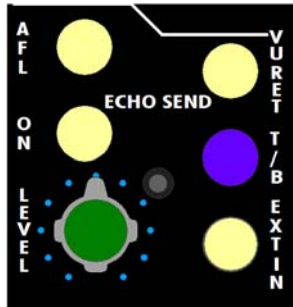

AFL: Activates an AFL solo

- Illuminates when engaged

ON: On/off switch for the Echo Send

- Illuminates in green when engaged

LEVEL: Controls the output level of the Echo Send

VU RET (Return): Routes the output of the Echo Return section to the meter in place of the output from the Echo Send.

- Illuminates when engaged

T/B (Talkback): Allows the Talkback microphone to feed the Echo Send when the Talkback microphone is activated

- Illuminates in blue when engaged

EXT IN (External): Mixes the ECHO SEND EXTERNAL INPUT from the rear panel with the output from the corresponding auxiliary bus at the input of the Echo Send

- Illuminates when engaged

NOTE: There are two trim-pots on the odd number Echo Send/Return sections. These are not labeled, but trim the calibration for respective Echo Sends.

3.2 Echo Return Section

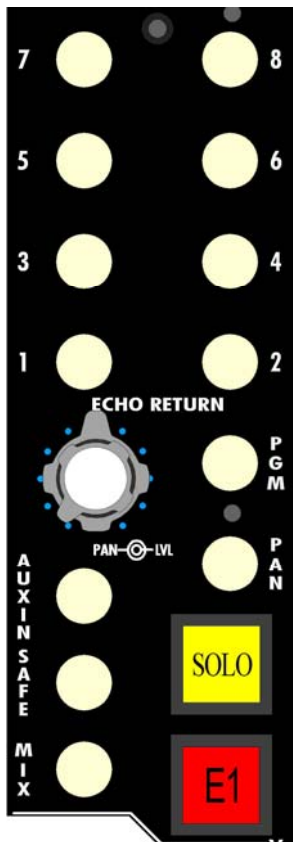

The E1608 ECHO RETURN section is an independent audio channel with multiple input options, complete level, muting, and panning controls, full solo capabilities, and full routing to the Program and Summing Buses. Some possible Echo Return applications include:

- Return path for external devices (multitracks, reverb/effects units, etc.)
- Input path for tracking, overdubs, and virtual instruments
- Audio Sub-grouping (when used with the Echo Send section)
- 5.1 mixing

The Echo Return section has the following features:

- Multiple input sources (including a switchable auxiliary external input)
- On/off switch
- Level control
- Switchable pan-pot
- Solo (PFL, AFL, SIP)
- Solo Safe
- Patchable 500 Slot for 500 Series modules
- Routing from the Echo Send section
- Output assignments to the Program and Summing Buses (ACA)

The Echo Return section can be fed from one of three sources:

- Echo Returns Input: ECHO RETURNS INPUT 1-8 sub-D connector
- Echo Return Auxiliary Input: ECHO RETURNS AUX INPUT 1-8 1/4" tip-ring-sleeve jack
- Echo Send Output: The output of the Echo Send section

Echo Returns Input: Accepts the balanced, line-level input from the ECHO RETURNS INPUT 1-8 sub-D connector on the rear panel.

- The Echo Returns connector is the default input for the Echo Return
- Echo Return 500 Slots are normalled between the Echo Returns Input connector and the input to the Echo Return module
 - The signal from the Echo Return Input connector is fed through the corresponding Echo Return 500 Slot before being fed to the Echo Return module input.
 - If engaged, a module mounted in the slot will process the audio before it arrives at the Echo Return module
 - If a slot is empty, the signal will loop through the slot to feed the corresponding Echo Return input when a Bypass Card is inserted into the card edge connector of the corresponding slot. *(These cards are supplied by API when the console is delivered without 500 modules in any 500 slot)*
 - The modules in the Echo Return 500 Slots may be used elsewhere by using the ECHO RETURN 500 SLOT INPUT and OUTPUT patch points on the rear panel
 - Inserting a plug into the ECHO RETURN 500 SLOT INPUT jack will defeat the signal from the Echo Return Input connector, but the output of the slot is still sent to the Echo Return module
 - The Echo Return 500 Slot may be bypassed by using the Echo Return Auxiliary Input

Note: Please refer to section 3.3 Echo Return 500 Slots for further information.

Echo Returns Auxiliary Input: Accepts the balanced, line-level input from the ECHO RETURNS AUX INPUT 1/4" connector on the rear panel. The Echo Return Aux Input signal will replace the Echo Return and Echo Send (MIX) signals when the AUX IN button is engaged.

Echo Send Output: Routes the output of the Echo Send section to the input of the Echo Return section. The Echo Send output will replace the Echo Return signal when the MIX button is engaged.

The Echo Return section provides two simultaneous audio output options:

- Summing Buses: Any of eight Summing Buses (ACA)
- Program Bus: The Left and Right Program Bus (PGM).

Summing Buses: The channel output may be assigned to one or more of the eight Summing Buses or Active Combining Amplifiers (ACA).

Program Bus: The channel output can be routed to the Program Bus (also ACA) for stereo mixing and for the Left and Right channels of a 5.1 mix.

The controls for the E1608 Echo Return output section function as follows:

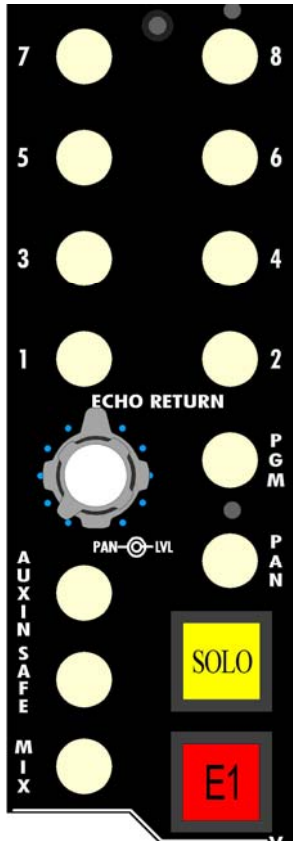

Summing Bus (ACA) Assignment 1-8: Assigns the Echo Return output to one or more of the eight Summing Buses (Active Combining Amplifiers)

- Assignments to the Summing Buses can be made on an individual basis
- Summing Buses are fed post the Echo Return level control or post the Echo Return pan-pot when it's engaged
- Summing Bus assignments are only active when engaged
- Switchable Odd/Even Summing Bus panning
- The Summing Bus assignment buttons illuminate when engaged

LVL (Level): Controls the output level of the Echo Return

PAN (pan-pot): Provides continuous panning control

- Stereo panning between the Left and Right Program Buses (when engaged)
- Odd and Even panning between Summing Buses (when engaged)

PAN (button): Activates Left/Right panning between the Program Buses and Odd/Even panning between the assigned Summing Buses

- The PAN button must be engaged to enable Summing *and* Program Bus panning
- Illuminates when engaged

Important Note: Unlike the pan-pot in the 548B Channel module, the PAN button must be engaged to enable Left/Right Program Bus panning.

PGM (Program): Assigns the Echo Return output to the Program Bus

- The Program Bus is fed post the Echo Return pan-pot
- Illuminates when engaged

SOLO: Activates the selected solo function for that Echo Return

- The following solo functions may be selected via the 845B Central Facilities Module:
 - *Solo(PFL):* Non-destructive, mono, pre-fader listen (PFL). This is the default solo mode.
 - *After Fader Listen (AFL):* Non-destructive, mono, after-fader listen
 - *Solo-In-Place (SIP):* Destructive, panned, after-fader listen
- Illuminates in yellow when engaged

NOTE: PFL is the default solo mode.

NOTE: Channels and Echo Returns must be assigned to the Program Bus for Solo-In-Place for their mutes to activate when other channels or Echo Returns are soloed.

SAFE: Activates the Solo Safe mode for that Echo Return

- The SAFE button protects that Echo Return from being muted when the Solo-In-Place function is active and another channel or Echo Return is soloed.
- Illuminates when engaged

MUTE: Cuts the audio output from that Echo Return

- The MUTE button is the on/off switch for the Echo Return output and is located post level control in the signal flow
- The MUTE button is the button with an "E" and a number (1-8) located in the Echo Return section
- Illuminates in red when engaged

AUX IN: Selects the Echo Return Auxiliary Input as the input for the Echo Return

- Illuminates when engaged

NOTE: The signals from the Echo Return Input and Echo Send Output (MIX) are defeated when the AUX IN button is engaged.

MIX: Selects the Echo Send output as the input for the Echo Return

- Illuminates when engaged

NOTE: The signal from the Echo Return Input is defeated when the MIX button is engaged.

3.3 Echo Return 500 Slots

The console is equipped with eight Echo Return 500 Slots. These 500 Slots are built to power and interface any API 500 Series module:

- 512C Preamplifier
- 525 Compressor
- 550A 3-Band EQ
- 550B 4-Band EQ
- 560 Graphic EQ

Some possible applications of the 500 Slots include:

- Extra microphone/instrument inputs (when equipped with a 512C Preamp)
- Extra signal processing for the Echo Return inputs
- Patchable signal processing for use in the channel Inserts and patch points
- Patchable signal processing for use in the Program Bus Inserts
- Patchable signal processing for use anywhere else (internally, externally, etc.)

When equipped with a 512C Preamp, the 500 Slot and Echo Return combine to form a powerful input module capable of routing a microphone, instrument, or line input to the Program and/or Summing Buses with full assignment, panning, and solo functions. This can greatly expand the capabilities of the console for almost all applications.

When equipped with a 512C Preamp, an API EQ, and a 525 Compressor, three 500 Slots can be used to create a single high-quality signal path for direct feed to the multitrack recorder or DAW.

As indicated by these examples, the 500 Slots can be custom configured to add versatility and maximize performance.

The features of the 500 Slots are as follows:

- All eight 500 Slots are empty in the standard 1608 configuration and equipped with Bypass Cards
- 500 Slots can deliver 48v phantom power to the Echo Return Input connector if equipped with a 512C Preamp
- The slots are normalled between the Echo Returns Input connector and the inputs to the Echo Return modules
- If engaged, the module mounted in a slot will process the audio before it arrives at the Echo Return module input
- If a slot is empty, the signal will loop through the slot to feed the corresponding Echo Return module input
- The modules in the Echo Return 500 Slots may be used elsewhere by using the ECHO RETURN 500 SLOT INPUT and OUTPUT patch points on the rear panel
- Inserting a plug into the ECHO RETURN 500 SLOT INPUT jack will defeat the signal from the Echo Return Input connector, but the output of the slot is still sent to the Echo Return module
- The 500 Slot may be bypassed by using the Echo Return Auxiliary Input

3.4 E1608 Connections

The rear panel connections for the E1608 Echo Send/Return module are as follows:

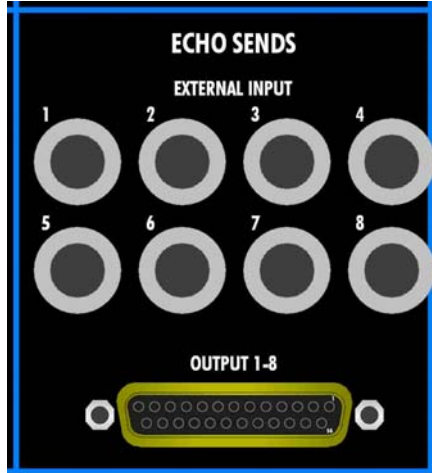

ECHO SENDS EXTERNAL INPUT 1-8:

- Balanced, Line-level
- 1/4" tip-ring-sleeve jack

ECHO SENDS OUTPUT 1-8:

- Balanced, Line-level
- Female 25-Pin Sub-D connector

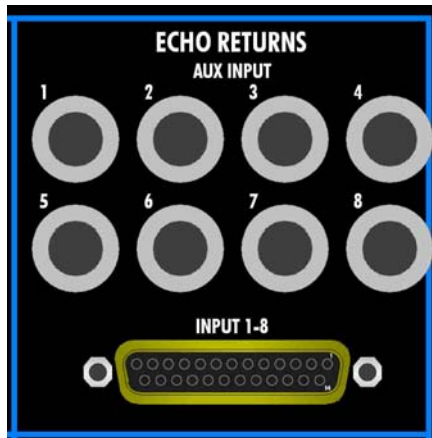

ECHO RETURNS AUX INPUT 1-8:

- Balanced, Line-level
- 1/4" tip-ring-sleeve jack

ECHO RETURNS INPUT 1-8:

- Balanced, Line-level
- Female 25-Pin Sub-D connector

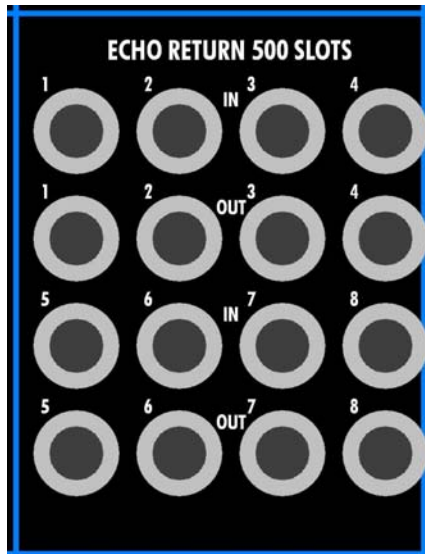

ECHO RETURNS 500 SLOTS IN 1-8:

- Balanced, Line-level
- 1/4" tip-ring-sleeve switching jack
- The signal from the Reverb Return Input connector is replaced with this signal when a jack is inserted

ECHO RETURNS 500 SLOTS OUT 1-8:

- Balanced, Line-level
- 1/4" tip-ring-sleeve jack
- Also normalled to feed the Echo Return module input

4.0 168B Summing Bus Sub-master Module

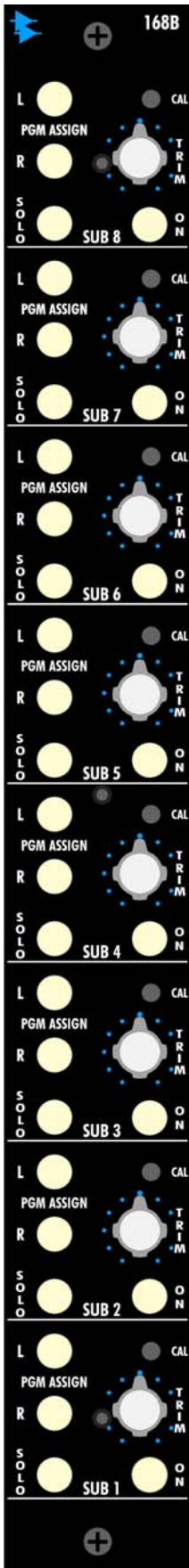

The 168B Summing Bus Sub-master Module provides control and routing for the eight Summing Buses, also known as Active Combining Amplifiers (ACA). The following is provided for each Summing Bus (ACA):

- On/off switch
- Solo (PFL and AFL only)
- Trim control
- ACA calibration
- Individual Left and Right Program Bus assignments
- Balanced, line-level outputs

4.1 Summing Bus Sub-masters

The Summing Bus Sub-masters (labeled SUB 1-8) are the final stage before the Summing Bus outputs are fed to the BUS OUTPUT 1-8 (ACA OUTPUT) sub-D connector on the rear panel. The output of the Summing Bus Sub-masters (SUB 1-8) can also be routed to the Program Bus via individual Left and Right assignment buttons.

The controls for each 168B Summing Bus Sub-master (SUB 1-8) function as follows:

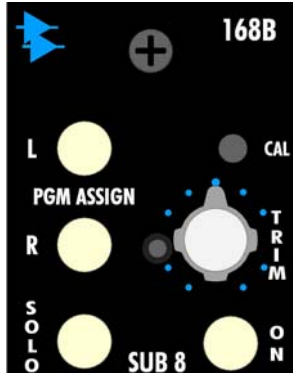

L and R PGM ASSIGN: Individual assignment of the Summing Bus (ACA) output to the Left and Right Program Buses

- The Left and Right Program Bus Assignment switches are actually fed from the PGM BUS MIX INPUT jacks on the rear panel
 - These jacks are normalled to the output of the Summing Buses (ACA), but break that connection when a jack is inserted
 - The normal or inserted signal present at the PGM BUS MIX INPUT jack feeds the Left and Right Program (PGM) Bus Assignment switches
- Illuminates when engaged

NOTE: Sub-masters assigned to the Program Bus will mute if the console is in Solo-In-Place and a channel or Echo Return is soloed.

SOLO: Activates the PFL or AFL Solo function

- Illuminates when engaged

ON: On/off switch for the Summing Bus Sub-master (SUB 1-8)

- Illuminates in when engaged
- Provides max kill in "off" position with TRIM fully clockwise (this is the calibrated position of the Send)

TRIM: Serves as a 0dB to -84dB trim control for the Bus Out application or 0dB to -30dB trim control for Return to Program Bus

- Cut only (calibrate level to infinite cut)

CAL (trim-pot): The trim-pot calibrates the output of the Active Combining Amplifier

4.2 168B Connections

The rear panel connections for the 168B Summing Bus Sub-master module are as follows:

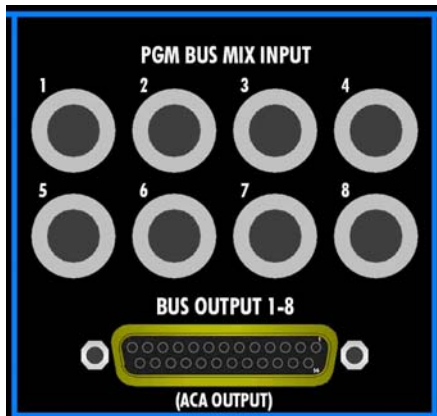

PGM BUS MIX INPUT:

- Balanced, Line-level
- 1/4" tip-ring-sleeve jack
- Replaces the Summing Bus output signal at the Left and Right Program Assignment switches when a jack is inserted

BUS OUTPUT 1-8 (ACA OUTPUT):

- Balanced, Line-level
- Female 25-Pin Sub-D connector

5.0 268B Program Bus Output Masters and Monitor Output Module

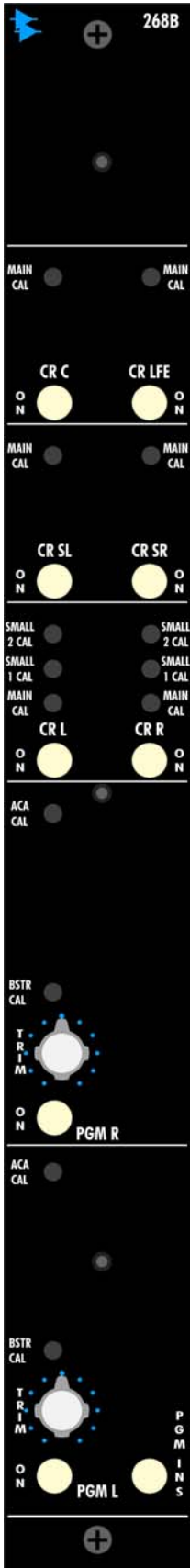

The 268B Program Bus Output Masters and Monitor Output module provides three functions:

- Program Bus Output controls
- Monitor Output controls
- Program Insert Control

5.1 Program Bus Output Masters

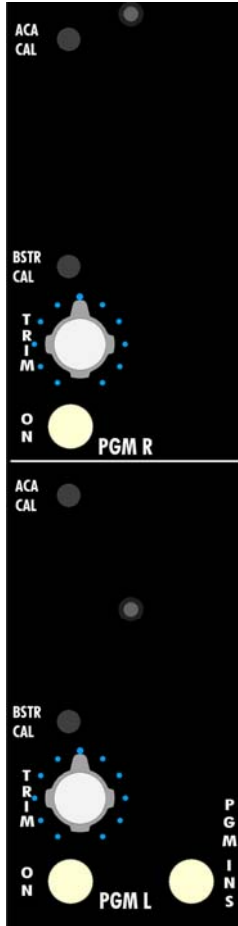

Together with the 440B Stereo Master Fader, the Program Bus Output Master section of the 268B provides a fully featured stereo master channel. Features of this master channel include:

- On/off switch
- Trim control
- ACA calibration
- Output Booster calibration
- Switchable balanced insert
- Balanced, line-level outputs

The Program Bus Insert Send ACA jacks are the pre-fader Outputs of the Program Summing Buses. They normally feed the top of the fader and are half-normalled to the Program Bus Insert Return jacks. The Program Insert jacks feed the Master Fader and Program Bus Outputs by engaging the Program Bus Insert switch. The Program Summing Bus outputs will feed the Program Master fader unless the Program Insert button is engaged. This allows insertion of external processing equipment pre Program Fader.

The controls for the 268B Left and Right Program Bus Output Masters (PGM L and PGM R) function as follows:

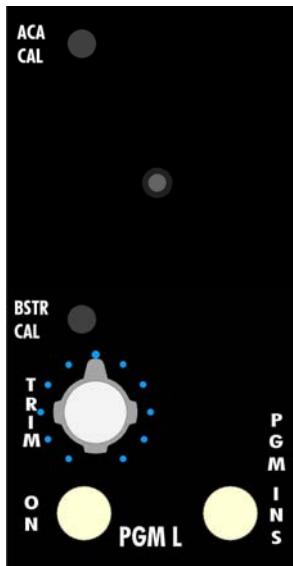

ACA CAL (trim-pot): The trim-pot calibrates the output of the Active Combining Amplifier

BSTR CAL (trim-pot): The trim-pot calibrates the output booster

TRIM: Controls the output level of the Program Bus (ACA)

- -5.5dB to +1.5dB

ON: On/off switch for the Program Bus Output Master

PRG INS (Program Insert): Activates the Left and Right Program Insert Return

- The Program Insert Send is fed pre-fader from the output of the Program ACA
- The Program Insert Send is always active
- The Program Insert Send is a balanced, line-level signal routed to the PROGRAM BUS INSERT SEND (ACA OUTPUT) 1/4" tip-ring-sleeve jack on the rear panel
- The Program Insert Return accepts a balanced, line-level signal from the PROGRAM BUS INSERT RETURN (FADER INPUT) 1/4" tip-ring-sleeve jack on the rear panel
- The Program Insert Return is located post-ACA and pre-fader
- The Program Insert Return is active only when the INS button is engaged

5.2 440B Stereo Master Fader Module

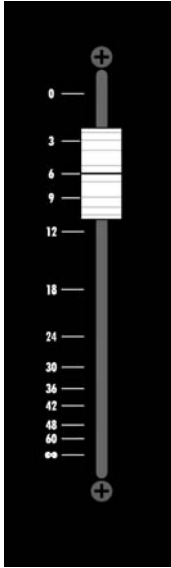

The 440B Stereo Master Fader feeds the Left and Right Program Outputs of the console. It is the main stereo output and provides the Left and Right outputs for 5.1 mixing.

- At 0VU the fader is at unity gain

5.3 Monitor Output Controls

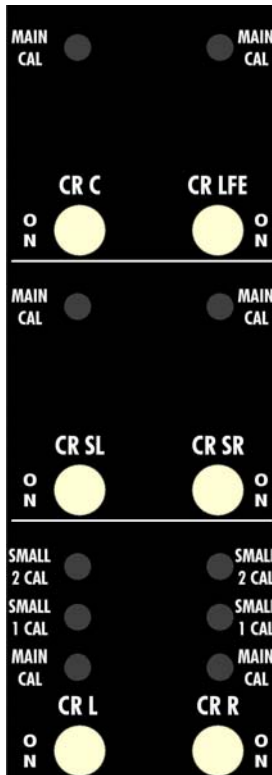

The 268B Monitor Output section supports one set of main 5.1 monitors and two sets of stereo monitors. The Monitor Output section provides on/off switching and calibration for a 5.1 (Left, Right, Center, Left Surround, Right Surround, and LFE) main monitor system (MAIN) and the two stereo nearfield monitor systems (SMALL 1 and 2). The Monitor Output section has the following features:

- On/off switch for all six Monitor Outputs
- 5.1 Main monitor trim control
- Stereo Small 1 trim control
- Stereo Small 2 trim control
- Balanced, line-level outputs

The Monitor Output section is the final stage before the selected monitor output is fed to the Control Room Output connectors on the rear panel. There are a set of controls for each of the six individual Monitor Outputs that support the 5.1 and stereo monitor systems:

- CR L: Control Room Left
- CR R: Control Room Right
- CR SL: Control Room Left Surround
- CR SR: Control Room Right Surround
- CR C: Control Room Center
- CR LFE: Control Room LFE (subwoofer)

The controls for each 268B Monitor Output function as follows:

ON: On/off switch for the Monitor Output

MAIN CAL (trim-pot): The trim-pot calibrates the corresponding Main Monitor Output level

SMALL 1 CAL (trim-pot): The trim-pot calibrates the corresponding Small 1 Monitor Output level (CR L and CR R only)

SMALL 2 CAL (trim-pot): The trim-pot calibrates the corresponding Small 2 Monitor Output level (CR L and CR R only)

5.4 268B Connections

The rear panel connections for the 268B Program Bus Output Master and Monitor Output module are as follows:

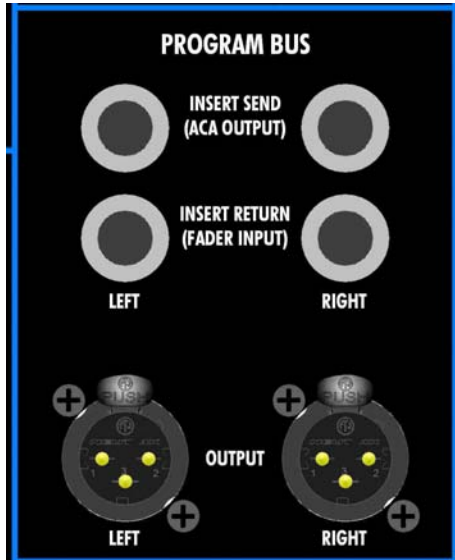

PROGRAM BUS INSERT SEND (ACA OUTPUT):

- Balanced, Line-level
- 1/4" tip-ring-sleeve jack
- Half-normalled to Program Insert Return

PROGRAM BUS INSERT RETURN (FADER INPUT):

- Balanced, Line-level
- 1/4" tip-ring-sleeve jack
- Replaces the Program Insert Send signal when a jack is inserted and the PRG INS button is engaged

PROGRAM BUS OUTPUT LEFT and RIGHT:

- Balanced, Line-level
- Male XLR

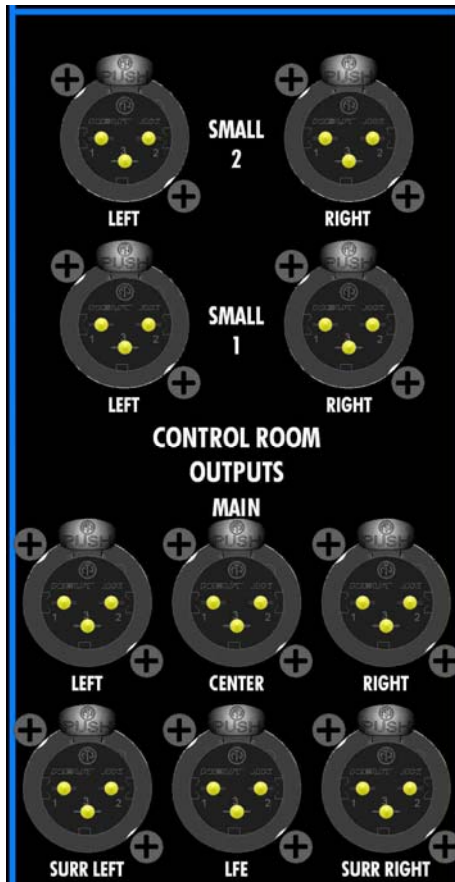

SMALL 2 CONTROL ROOM OUTPUTS LEFT and RIGHT:

- Balanced, Line-level
- Male XLR

SMALL 1 CONTROL ROOM OUTPUTS LEFT and RIGHT:

- Balanced, Line-level
- Male XLR

MAIN CONTROL ROOM OUTPUTS LEFT, CENTER, RIGHT:

- Balanced, Line-level
- Male XLR

MAIN CONTROL ROOM OUTPUTS LEFT SURROUND, CENTER, RIGHT SURROUND:

- Balanced, Line-level
- Male XLR

6.0 845B Control Room Monitor Control Module

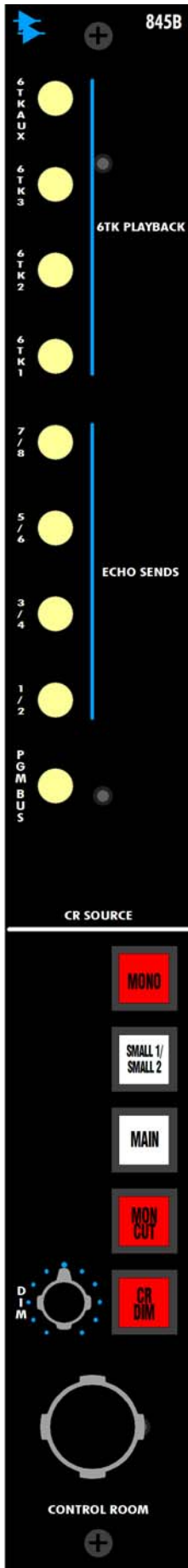

The 845B Control Room Monitor Control module provides two functions:

- Selection and volume control of the Control Room Monitor system
- Selection of the Control Room Monitor input source

6.1 Monitor Control Section

845B Monitor Control section provides a comprehensive set of controls for up to three Control Room Monitor systems. Features include:

- Monitor volume control
- Monitor cut
- Control Room monitor dim with level control
- Monitor system selectors
- Switchable mono summing

The 845B Monitor Control section functions as follows:

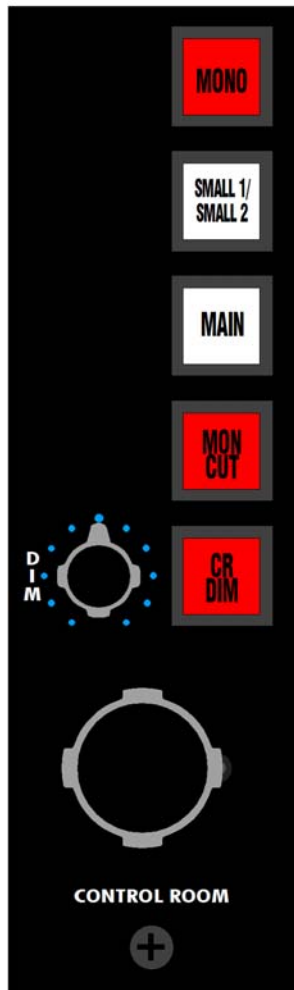

MONO: Sums the Left and Right Control Room Monitor output to mono.

- The MONO button works with all monitor selections
- Illuminates in red when engaged

SMALL1/SMALL2: Selects between the Small 1 and 2 Monitor systems when the MAIN monitor button is disengaged

- Supports two stereo monitor systems
- Routes the Monitor feed to the Small2 when engaged
- Routes the Monitor feed to the Small1 when not engaged
- Only active when the MAIN button is not engaged
- Illuminates in yellow when active
 - Illuminates slightly brighter when engaged

MAIN: Routes the Control Room Monitor feed to the Main monitor outputs

- Supports one stereo or 5.1 monitor systems
- Routes the Control Room Monitor feed to the Small monitor selector when not engaged
- Illuminates in yellow when engaged

MON CUT (Monitor Cut): Cuts the Control Room Monitor feed

- On/off switch for the Control Room Monitor section
- Illuminates in red when engaged

CR DIM (Control Room Dim button): Attenuates the Monitor output by routing the Monitor feed through the DIM attenuation pot

- The CR DIM level is set by the DIM pot
- CR DIM is automatically engaged when:
 - The TO BUS button is engaged on the Oscillator
 - Any of the Talkback buttons (T/B ALL, T/B TO AUX, or SLATE) are engaged
- Illuminates in red when engaged

CONTROL ROOM MONITOR LEVEL: Controls the output level of the Monitor Control section

- Volume control for the selected monitor system
- The largest and most dangerous knob on the console...please use it wisely!

6.2 Monitor Source Selectors

The 845B Monitor Source Selectors (CR SOURCE) provide a choice of nine different sources to feed the Control Room monitors. The selections are divided into three categories:

- Program Bus (PGM BUS)
- Echo Sends
- Six Channel Playback (6 TRK PLAYBACK)

The 845B Monitor Source Selectors function as follows:

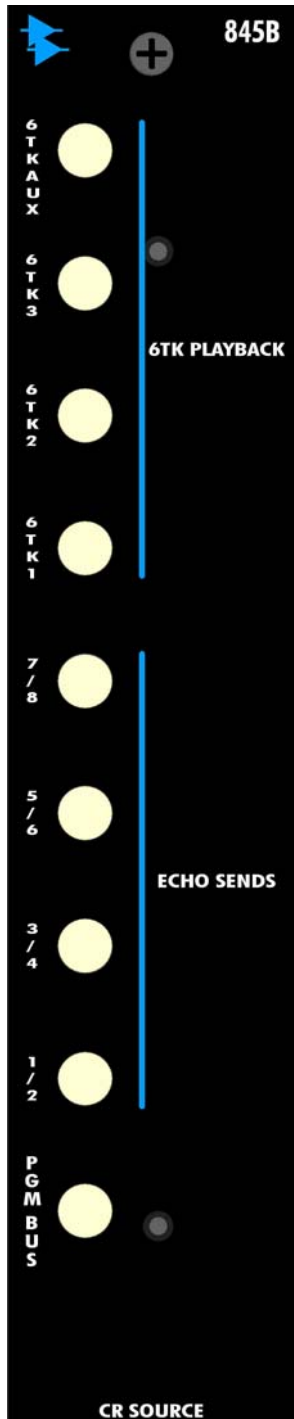

6 TRK PLAYBACK 6TKAUX, 6TK1, 6TK2, 6TK3: Routes the signal from the selected six-track playback source to the Monitor Control section

- The input from the selected external six track playback source connector on the rear panel is fed to the Monitor Control section
- The selected 6-Track Playback button illuminates in red when engaged
- 6 TRK PLAYBACK 6TKAUX is currently inactive and is reserved for future use

ECHO SENDS 1/2, 3/4, 5/6, 7/8: Routes the output of the selected Echo Send to the Monitor Control section

- The Echo Send output is fed to the Monitor Control section
- The selected Echo Send button illuminates when engaged

PGM BUS (Program Bus): Routes the output of the Program Bus Output Masters to the Monitor Control section

- The output from the Program Bus Output Masters are fed to the Monitor Control section post the Stereo Master Fader
- Illuminates when engaged

6.3 845B Connections

The rear panel connections for the 845B Control Room Monitor Control module are as follows:

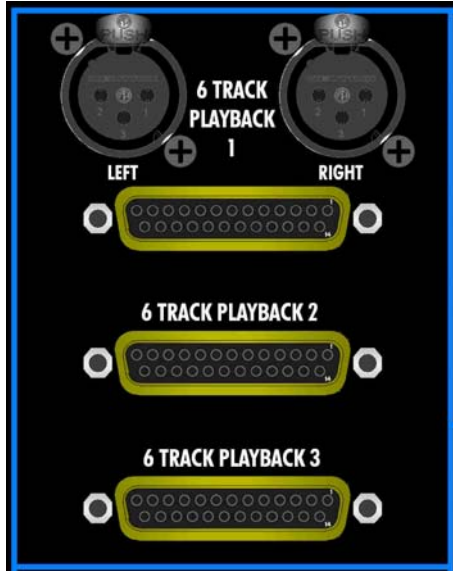

6 TRACK PLAYBACK 1 LEFT and RIGHT Input:

- Balanced, Line-level
- Female XLR connectors
- Left and Right are paralleled with input with Sub-D connector

6 TRACK PLAYBACK INPUTS 1, 2, and 3:

- Left, Center, Right, Left Surround, Right Surround, LFE
- Balanced, Line-level
- Female 25-Pin Sub-D connector
- 6 Track Playback 1 is paralleled with the Left and Right XLR connectors

7.0 840B Central Facilities Module

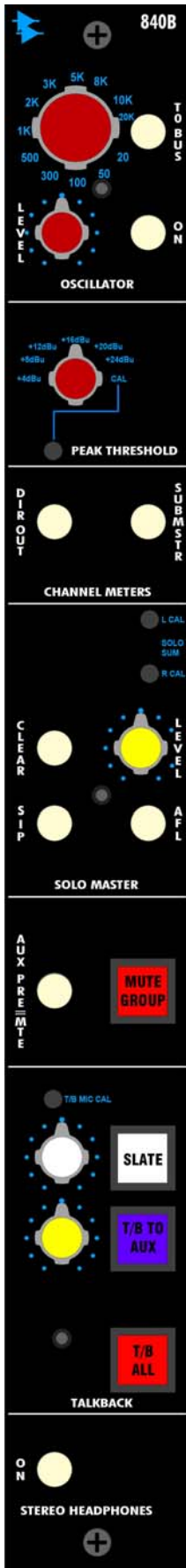

The 840B Central Facilities provides several ancillary console functions. The control sections are included for the following functions:

- Headphone amplifier
- Talkback controls
- Mute Group controls
- Master Solo controls
- Meter control
- Peak indicator controls
- Oscillator

7.1 Stereo Headphone Amplifier

The 840B Stereo Headphone Amplifier is designed for use by the engineer or others in the Control Room. It has the following features:

- On/off switch
- 1/4" stereo headphone jack (located under the armrest)
- Feeds the current Control Room Monitor source from Monitor Control section
 - Volume follows the Monitor Control level
 - Mono summing is available
 - CR DIM is available
 - Not affected by the MON CUT or Monitor System Selectors

The 840B Stereo Headphone Amplifier control functions as follows:



ON: On/off switch for the Stereo Headphone Amplifier

- Illuminates when engaged

7.2 Talkback

The 840B Talkback section provides a complete set of Talkback routing options and controls. It has the following features:

- Talkback to all
- Talkback to auxes only
- Talkback microphone level
- Independent Slate function with level control
- Talkback Microphone in Meter Bridge
- Talkback remote control port

The 840B Talkback controls function as follows:

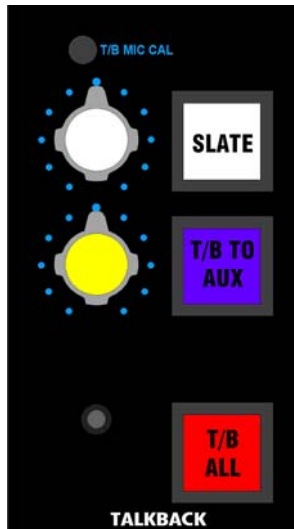

SLATE: Routes Talkback to the Program and Summing Buses

- The Left and Right Program Bus Output Masters must be turned ON with the level up to enable Talkback to feed the Program Buses
- The eight Summing Bus masters (SUB 1-8) must be turned ON with the level up to enable Talkback to feed the Summing Buses
- Independent Level Control
- Momentary Switch
- Automatically engages the CR DIM function when pressed
- Illuminates in red when engaged

Note: The SLATE function does not include a tone or oscillator feed.

SLATE LEVEL: Volume control for the Talkback to the Program and Summing Buses

- Located adjacent to the SLATE button

T/B TO AUX (Talkback to Auxiliaries): Routes Talkback to the enabled Auxiliary Buses

- The E1608 Echo Send T/B button must be engaged to enable Talkback to feed the corresponding Auxiliary Bus
- The Echo Send must be turned ON with the level up to enable Talkback to feed the corresponding Auxiliary Bus
- Momentary switch
- Independent level control
- Automatically engages the CR DIM function when pressed
- Illuminates in yellow when engaged

T/B TO AUX LEVEL: Volume control for the Talkback to the enabled Auxiliary Buses

- Located adjacent to the T/B TO AUX button

T/B ALL (Talkback to All): Activates the SLATE and T/B TO AUX functions

- Routes Talkback to the Program and Summing Buses
- Routes Talkback to the Auxiliary Buses
- Momentary switch
- Automatically engages the CR DIM function when pressed
- Illuminates in yellow when engaged

T/B MIC CAL (trim-pot): Calibrates the Talkback microphone level

7.3 Mute Group

The 840B Mute Group section provides one Mute Group with the following features:

- Control of the Mute switches on assigned 548B Channel modules
- The pre-fader Echo/Auxiliaries of assigned channels may be added to the Mute Group

The 840B Mute Group controls function as follows:

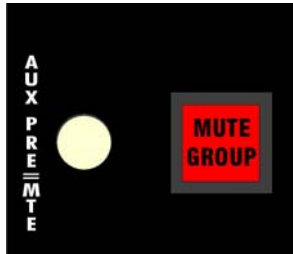

MUTE GROUP: Mutes all channels assigned to the Mute Group

- Assigned channels will be muted when the master MUTE GROUP button is engaged
- Channels may be assigned to the Mute Group on an individual basis by engaging the MUTE GRP button
- Assigned channels may be muted independently of the Mute Group
- Assigned channels may not be independently unmuted when the master MUTE GROUP button is engaged
- Illuminates in red when engaged

7.4 AUX PRE=MUTE (Auxiliary Pre = Mute): Causes Channel Echo Sends in pre-Fader mode to follow the Channel Mute

7.5 Solo Master

The 840B Solo Master section selects the solo function for the Channels and Echo Returns. The following solo functions are provided:

- Pre-fader Listen (PFL)
- After-fader Listen (AFL)
- Solo-In-Place (SIP)

Pre-fader Listen (PFL):

- The Solo Bus is fed pre-fader from the channel or echo return
- Non-destructive
- Mono
- Solo Level Control

After-fader Listen (AFL):

- The Solo Bus is fed post-fader from the channel or echo return
- Non-destructive
- Mono
- Solo Level Control

Solo-In-Place (SIP):

- Destructive (all other channels/returns will mute when the SOLO button is engaged in this mode)
- The soloed channels/returns are monitored via the Program Bus
- Panned
- Post-fader

NOTE: PFL is the default solo mode.

NOTE: Channels and Echo Returns must be assigned to the Program Bus for Solo-In-Place for their mutes to activate when other channels or Echo Returns are soloed.

NOTE: Sub-masters assigned to the Program Bus will mute if the console is in Solo-In-Place and a channel or Echo Return is soloed.

The 840B Solo Master controls function as follows:

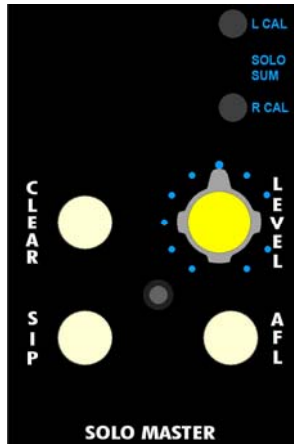

SOLO SUM L and R CAL (trim-pot): Calibrates the level of the Left and Right channel contributions to the PFL and AFL solo bus

LEVEL: Volume control for PFL and AFL solos

No Buttons Engaged: PFL is the active solo function

SIP (Solo-In-Place): Selects the Solo-In-Place solo function

- Illuminates when engaged

AFL (After-Fader Listen): Selects the After-Fader Listen solo function

- Illuminates when engaged

CLEAR: Disengages all engaged channel/echo return SOLO buttons

- Provides a quick and easy method to turn off channel/echo return solos
- Does not clear Echo Send or Summing Bus Master solos
- Momentary switch
- Illuminates as a flashing light when any solo mode is engaged

Note: If Solo Clear is pushed, and the button remains flashing, there is either an Echo Send or a Summing Bus Master solo latched

7.6 Channel Meter Control

The 840B Channel Meter section selects the source for the sixteen Channel Meters in the Meter Bridge. All sixteen Channel Meters can display the following sources:

- Channel Preamp output
- Channel Direct Output

The first eight Channel Meters can also display:

- Summing Bus masters (SUB 1-8) output

The 840B Channel Meter controls function as follows:



No Buttons Engaged: Meters display the output of the channel Preamps

DIR OUT (Direct Output): Meters display the output of the channel Direct Output

- Replaces the channel Preamp output meter feed
- Illuminates in when enaaaed

SUB MSTR (Sub-master): Meters 1-8 display the output of the Summing Bus Sub-masters (SUB 1-8)

- Replaces the channel Preamp output and Direct Output meter feeds for Meters 1-8
- Meters 9-16 will display the channel Preamp output
- Meters 9-16 will display the channel Direct Output if the DIR OUT button is engaged
- Illuminates in when engaged

7.7 Peak Threshold

The 840B Peak Threshold section allows the selection of one of six Peak Thresholds. When the signal in a channel crosses the selected threshold, the MIC button on that channel turns red, indicating a peak has been reached. There is also a selector position and trim-pot for Peak Indicator calibration.

The 840B Peak Threshold controls function as follows:

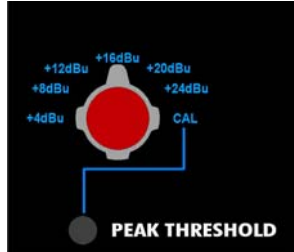

Peak Threshold Selector: Selects the Peak Indicators threshold from the following choices:

- +4dBU
- +8dBU
- +12dBU
- +16dBU
- +20dBU
- +24dBU
- CAL

CAL (trim-pot): Calibrates the Peak Indicator

- CAL must be selected on the Peak Threshold selector

7.8 Oscillator

The 840B Oscillator section provides a full-range sine wave oscillator with the following features:

- Twelve frequency selections from 20Hz to 20kHz
- On/off switch
- Level control
- Assignment to the Program and Summing Buses
- Balanced, line-level output

The 840B Oscillator controls function as follows:

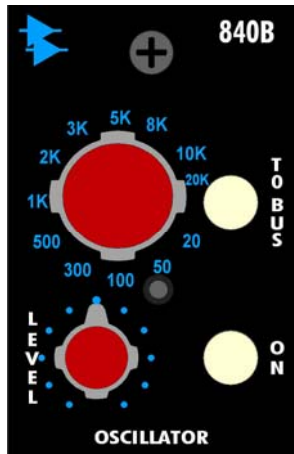

Frequency Selector: Selects the Oscillator frequency from the following choices:

- 20Hz
- 50Hz
- 100Hz
- 300Hz
- 500Hz
- 1kHz
- 2kHz
- 3kHz
- 5kHz
- 8kHz
- 10kHz
- 20 kHz

LEVEL: Controls the output level of the Oscillator

ON: On/off switch for the Oscillator output

- The Oscillator output is fed to the OSCILLATOR output connector on the rear panel
- Illuminates in red when engaged

TO BUS: Routes Oscillator output to the Program and Summing Buses

- The Left and Right Program Bus Output Masters must be turned ON with the level up to enable the Oscillator to feed the Program Buses
- The eight Summing Bus Sub-masters (SUB 1-8) must be turned ON with the level up to enable Oscillator to feed the Summing Buses
- Automatically engages the CR DIM function when engaged
- Illuminates in red when engaged

7.9 840B Connections

The rear panel connections for the 840B Central Facilities module are as follows:

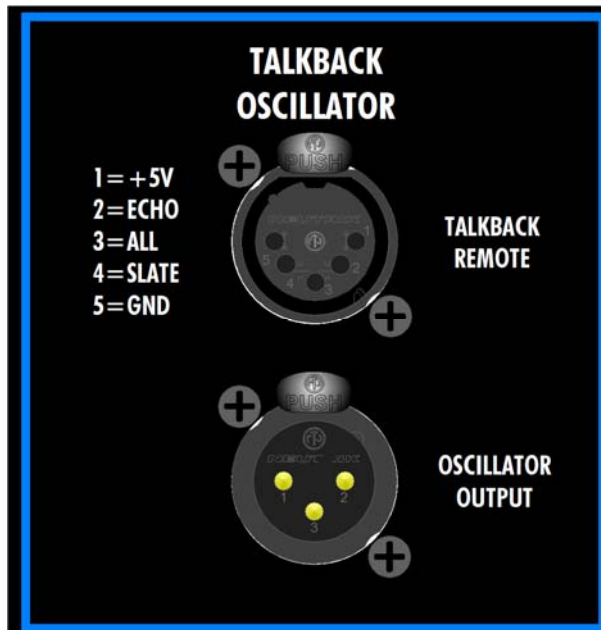

TALKBACK: Talkback Remote Port

- Pin 1 = +5 volts (fused)
- Pin 2 = T/B To Echo
- Pin 3 = T/B to All
- Pin 4 = T/B Slate
- Pin 5 = Ground
- 5-Pin Female XLR connector
- Connect pin5 to pin 2, 3, or 4 through an external momentary switch for remote talkback use

OSCILLATOR: Oscillator Output

- Balanced, Line-level
- Male XLR connector

NOTE: The screened pinout on the rear panel of the 1608 is actually WRONG. The CORRECT pinout is as above.

7.10 STEREO HEADPHONE JACK

STEREO HEADPHONE JACK: (under armrest on Right side of console)

- Headphone amplifier output
- 1/4" tip-ring-sleeve jack

8.0 Meter Bridge

The 1608 Meter Bridge provides illuminated VU Meter display for the following outputs:

- Channel Preamp
- Channel Direct Output
- Summing Bus Sub-master Output
- Left and Right Program Output
- Echo Send Output

The Talkback Microphone and Power Supply Indicators are also mounted in the Meter Bridge.

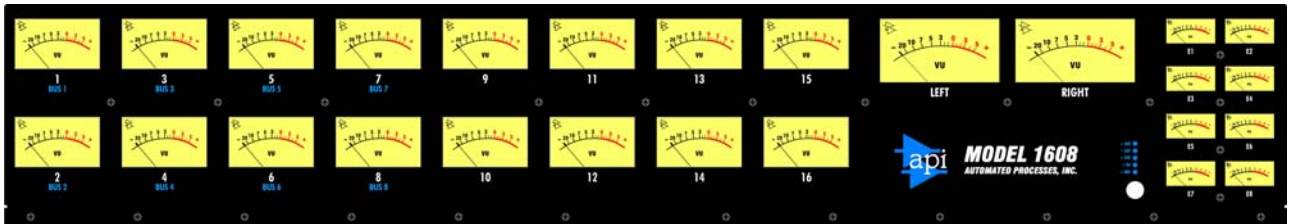

8.1 Channel/Bus Meters

The controls for the Meter Bridge are located in the Channel Meter section on the 840B Central Facilities module. These controls select the sources for the sixteen Channel Meters in the Meter Bridge as follows:

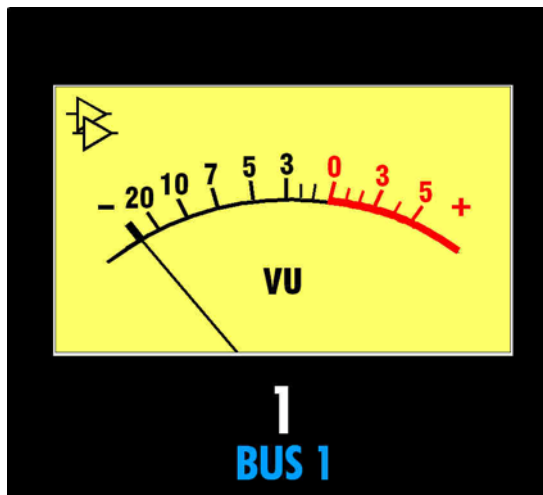

No Buttons Engaged: Meters display the output of the channel Preamps

DIR OUT (Direct Output): Meters display the output of the channel Direct Output

- Replaces the channel Preamp output meter feed

SUB MSTR (Sub-master): Meters 1-8 display the output of the Summing Bus Masters (SUB 1-8)

- Replaces the channel Preamp output and Direct Output meter feeds for Meters 1-8
- Meters 9-16 will display the channel Preamp output
- Meters 9-16 will display the channel Direct Output if the DIR OUT button is engaged

8.2 Left and Right Program Meters

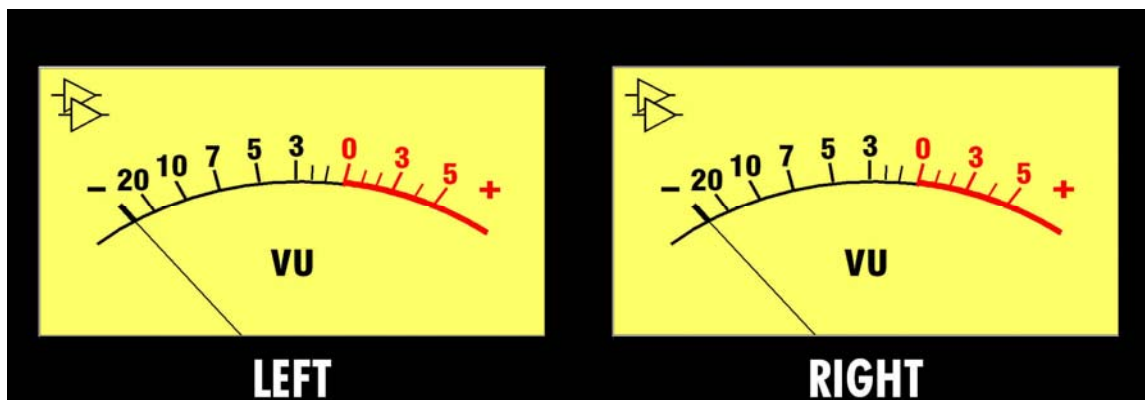

The large LEFT and RIGHT Meters display the stereo Program Master Output (post the Master Fader).

8.3 Echo Send/Return Meters

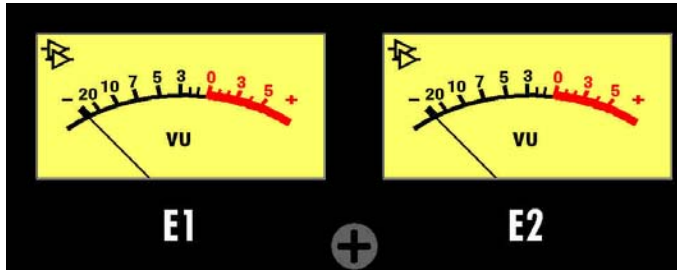

The E1 - E8 Meters display the output of the eight Echo/Auxiliary Send Masters (post the Echo Send Master).

8.4 Power Supply Voltage Indicators



Blue LED indicators are provided for the five power supply voltages:

- +16V
- -16V
- +24V
- +5V
- +48V

The Power Supply Voltage Indicators are located to the left of the E5 and E7 meters.

8.5 Talkback Microphone

The built-in Talkback Microphone is located below the Power Supply Voltage Indicators.



9.0 Rear Panel

9.1 548B Channel Module Connections

The rear panel connections for the 548B Channel module are as follows:

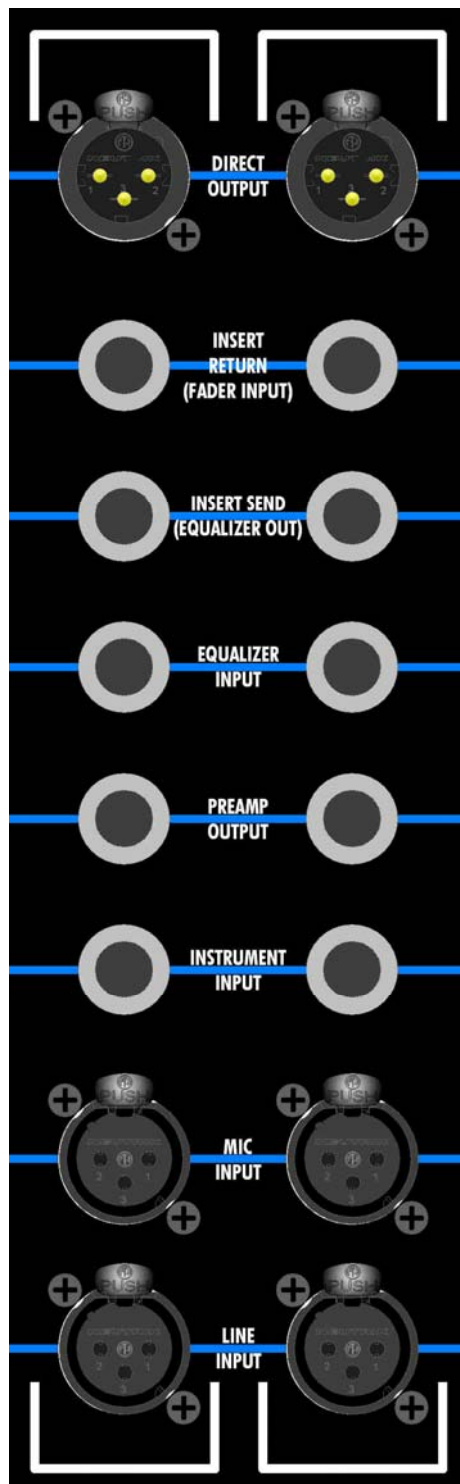

DIRECT OUTPUT:

- Balanced, Line-level
- Male XLR

INSERT RETURN (FADER INPUT):

- Balanced, Line-level
- 1/4" tip-ring-sleeve switching jack
- Replaces the EQ Out signal when a jack is inserted and the INS button is engaged

INSERT SEND (EQUALIZER OUT):

- Balanced, Line-level
- 1/4" tip-ring-sleeve switching jack
- The feed to the Insert Return (Fader Input) is defeated when a jack is inserted

EQUALIZER INPUT:

- Balanced, Line-level
- 1/4" tip-ring-sleeve switching jack
- The Preamp Output signal is replaced with this signal when a jack is inserted

PREAMP OUTPUT:

- Balanced, Line-level
- 1/4" tip-ring-sleeve jack
- Half-normalled to feed the Equalizer Input

INSTRUMENT INPUT:

- Unbalanced, High-impedance
- Instrument-level
- 1/4" tip-sleeve switching jack
- The Microphone Input signal is replaced with this signal when a jack is inserted

MIC INPUT:

- Balanced, Low-impedance
- Microphone-level
- Female XLR connector

LINE INPUT:

- Balanced, Low-impedance
- Line-level
- Female XLR connector

9.2 E1608 Echo Send/Return Connections

The rear panel connections for the E1608 Echo Send/Return module are as follows:

9.2.1 Echo Sends

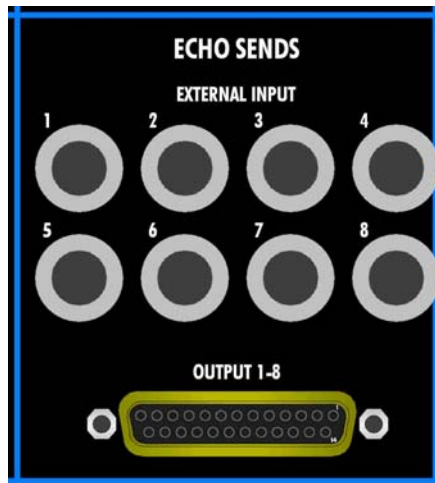

ECHO SENDS EXTERNAL INPUT 1-8:

- Balanced, Line-level
- 1/4" tip-ring-sleeve jack

ECHO SENDS OUTPUT 1-8:

- Output of the Echo/Auxiliary Masters
- Balanced, Line-level
- Female 25-Pin Sub-D connector

9.2.2 Echo Returns

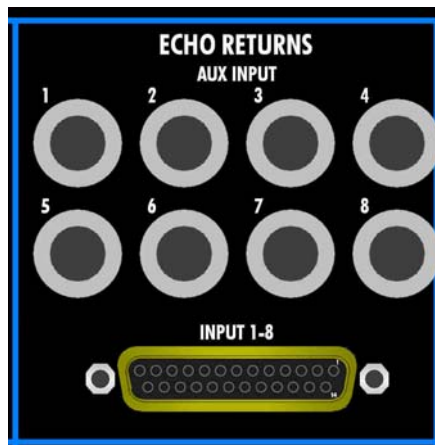

ECHO RETURNS AUX INPUT 1-8:

- Balanced, Line-level
- 1/4" tip-ring-sleeve jack

ECHO RETURNS INPUT 1-8:

- Balanced, Line-level
- Female 25-Pin Sub-D connector

9.2.3 Echo Return 500 Slots

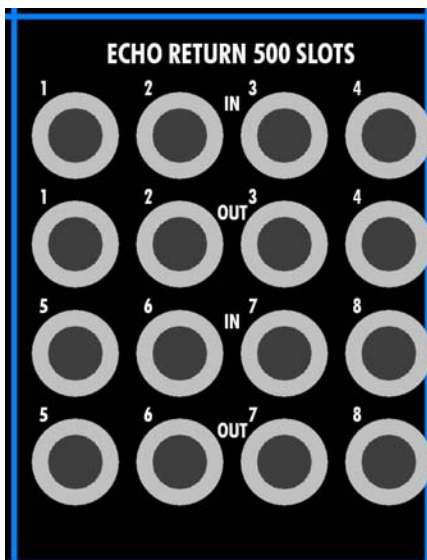

ECHO RETURNS 500 SLOTS IN 1-8:

- Fed from the Reverb Return Input connector
- Balanced, Line-level
- 1/4" tip-ring-sleeve switching jack
- The signal from the Reverb Return Input connector is replaced with this signal when a jack is inserted

ECHO RETURNS 500 SLOTS OUT 1-8:

- Output of the 500 Slot Balanced, Line-level
- 1/4" tip-ring-sleeve jack
- Also normalled to feed the Echo Return module input

9.3 168B Summing Bus Sub-master (ACA) Connections

The rear panel connections for the 168B Summing Bus Sub-master module are as follows:

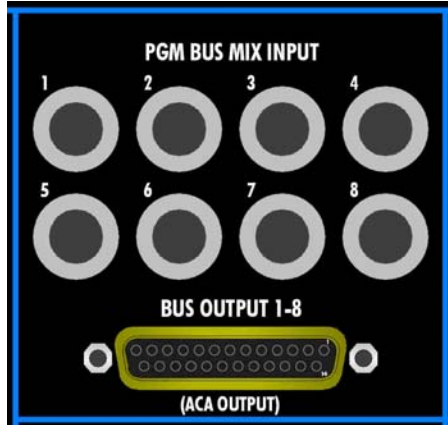

PGM BUS MIX INPUT:

- Feeds the inputs to the Program Bus Assignment switches on the Summing Bus Sub-masters 1-8
- Balanced, Line-level
- 1/4" tip-ring-sleeve jack
- Replaces the Summing Bus output signal at the Left and Right Program Assignment switches when a jack is inserted

BUS OUTPUT 1-8 (ACA OUTPUT):

- Output from the Summing Bus Sub-masters SUB 1-8
- Balanced, Line-level
- Female 25-Pin Sub-D connector

9.4 268B Program Bus/Master Output Connections

The rear panel connections for the 268B Program Bus/Master Outputs are as follows:

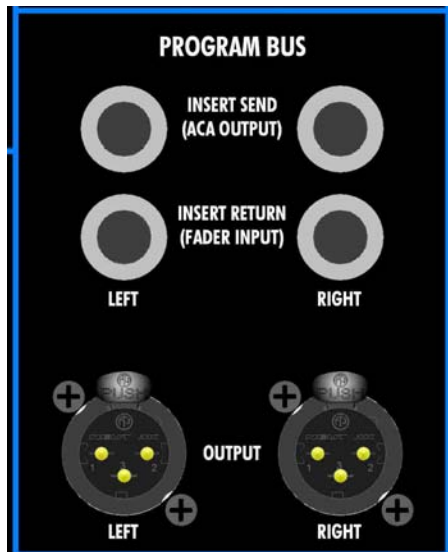

PROGRAM BUS INSERT SEND (ACA OUTPUT):

- Balanced, Line-level
- 1/4" tip-ring-sleeve jack
- Half-normalled to Program Insert Return

PROGRAM BUS INSERT RETURN (FADER INPUT):

- Balanced, Line-level
- 1/4" tip-ring-sleeve jack
- Replaces the Program Insert Send signal when a jack is inserted and the PRG INS button is engaged

PROGRAM BUS OUTPUT LEFT and RIGHT:

- Fed post the Stereo Master Fader
- Balanced, Line-level
- Male XLR

9.5 268B Control Room Monitor Output Connections

The rear panel connections for the 268B Monitor Outputs are as follows:



SMALL 2 CONTROL ROOM OUTPUTS LEFT and RIGHT:

- Balanced, Line-level
- Male XLR

SMALL 1 CONTROL ROOM OUTPUTS LEFT and RIGHT:

- Balanced, Line-level
- Male XLR

MAIN CONTROL ROOM OUTPUTS LEFT, CENTER, RIGHT:

- Balanced, Line-level
- Male XLR

MAIN CONTROL ROOM OUTPUTS LEFT SURROUND, CENTER, RIGHT SURROUND:

- Balanced, Line-level
- Male XLR

9.6 845B 6-Track Playback Input Connections

The rear panel connections for the 845B Control Room Control Monitor module are as follows:

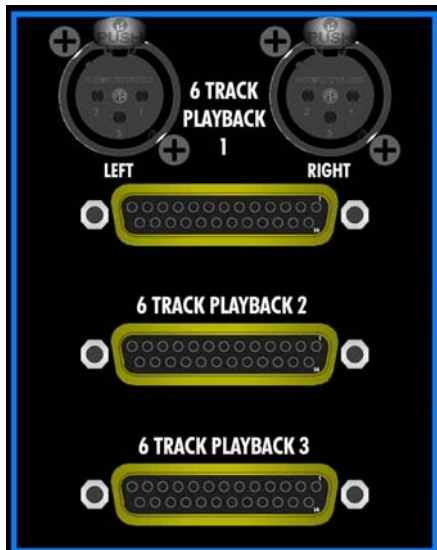

6 TRACK PLAYBACK 1 LEFT and RIGHT Input:

- Balanced, Line-level
- Female XLR connectors
- Left and Right are paralleled with input with Sub-D connector

6 TRACK PLAYBACK INPUTS 1, 2, and 3:

- Left, Center, Right, Left Surround, Right Surround, LFE
- Balanced, Line-level
- Female 25-Pin Sub-D connector
- 6 Track Playback 1 is paralleled with the Left and Right XLR connectors

9.7 840B Ancillary Connections

The rear panel connections for the 840B Central Facilities module are as follows:

9.7.1 Talkback Remote Port and Oscillator Output

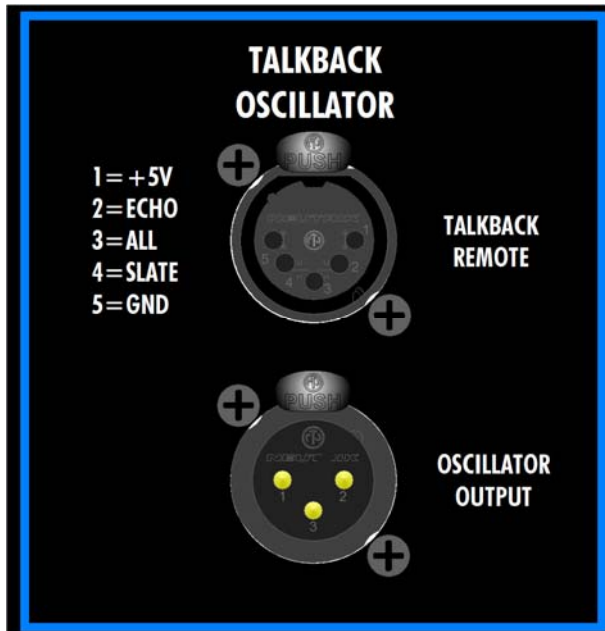

TALKBACK: Talkback Remote Port

- Pin 1 = +5 volts (fused)
- Pin 2 = T/B To Echo
- Pin 3 = T/B to All
- Pin 4 = T/B Slate
- Pin 5 = Ground
- 5-Pin Female XLR connector

OSCILLATOR: Oscillator Output

- Balanced, Line-level
- Male XLR connector

NOTE: The screened pinout on the rear panel of very early 1608's is actually WRONG (serial numbers below 020). The CORRECT pinout is as above.

9.7.2 Stereo Headphone Output

Stereo Headphone Jack: (under armrest on the Right side of the frame)

- Headphone amplifier output
- 1/4" tip-ring-sleeve jack

9.8 Expander Port

The Expander Port is interfaced with a single 90-Pin male Elco connector.

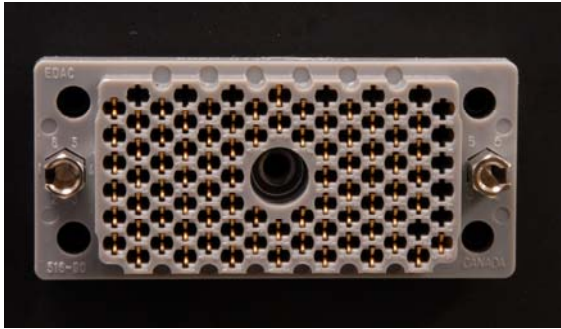

The 1608 is equipped with an Expander Port that allows the connection of a sixteen-channel API 1608 Expander. The Expander Port allows for complete integration of all major console functions:

- Program Bus
- Summing Bus
- Auxiliary Bus
- Mute Group
- Solo Bus
- Solo-In-Place

9.9 Power Supply Unit Connection

The Power Supply Unit connection is interfaced with a single multi-pin mil spec. connector.

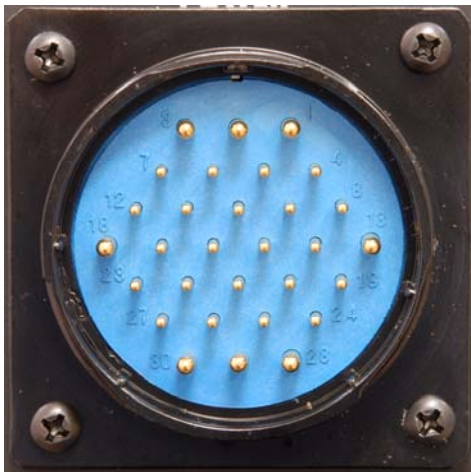

1608 Weights and Dimensions

	Width	Height	Depth	Weight
Standard 16 channel console	37.6 inches	17.9 inches	33.0 inches	228 Lbs.
16 Channel Expander	25.6 inches	17.9 inches	33.0 inches	162 Lbs.
32 Channel Console	50 inches	17.9 inches	33.0 inches	390 Lbs.

10.0 Application Guide

The API 1608 is a highly versatile audio production console and is at home with a wide variety of applications including:

- Multitrack Recording
- Overdubbing
- Mixing
- Broadcasting
- Post
- Live Sound

API realizes the owners of the 1608 are professional users, so this section of the manual is designed to provide quick and easy setups for basic applications.

Note: These setups are intended to be a very basic "Getting Started" guide and should by no means considered to be comprehensive.

10.1 Multitrack Recording

This setup uses the 1608 as an input path to a multitrack recorder or Digital Audio Workstation (DAW):

- 1) Connect the audio sources to be recorded to the channel module inputs as needed
- 2) Select the appropriate channel input for the sources to be recorded (microphone, instrument, or line)
- 3) Connect the following to the inputs of the recorder or DAW as desired:
 - Channel Direct Outputs
 - Summing Bus Sub-master Outputs (if multiple channels need to be summed before the input to the recorder...make assignments as needed)
 - Odd/Even panning is available
- 4) The channel input level and polarity will be set by the Preamp
- 5) Use the onboard filter and EQ as needed
 - Additional signal processors (such as a compressor) may be patched into various places in the channel audio path via the Insert and other connections on the rear panel
- 6) Connect the Direct Outputs or the Summing Bus Outputs to the desired recorder or DAW inputs
 - The Direct Output is always fed by the channel Fader
 - Make the necessary Summing Bus assignments if needed
- 7) The multitrack feed will be controlled by the channel Fader and Mute
 - If the Summing Buses are used, the Summing Bus Sub-masters (SUB 1-8) will provide a final output control before the recorder or DAW
- 8) Unused channels and echo returns can be used to create a mix of the multitrack/DAW returns
 - If a DAW is used, tracks could be sub-grouped as needed before feeding the DAW outputs
- 9) The mix of the multitrack returns and cue/effects sends can be created "in the box" (using the DAW mix and auxiliary buses and outputs)
 - If a DAW is not being used, unused 1608 channels and echo returns can be used to create the needed mixes
- 10) If a stereo mix is created in the DAW, it could be routed back to the console via unused channels, echo returns, an external control room monitor input, or even the Program Bus insert return for further processing, routing, and/or monitoring

Multitrack Recording Scenario #1

The diagram below shows the connections between a 1608 and a Digital Audio Workstation (DAW) with 24 line inputs. The first 16 channels feed the DAW inputs 1-16 via the Channel Direct Outputs. DAW inputs 17-24 are fed from the 1608 Summing Bus Outputs 1-8, providing versatile assignment possibilities. If the Echo Return 500 slots are fitted with 512C Preamplifiers or outboard preamps are fed to the Echo Return inputs, the 1608 can provide 24 independent input channels and output paths to a DAW (or other multitrack recorder).

This scenario requires the engineer to sum the recorded channels to a mix within the DAW and output this mix for monitoring. The diagram below this mix returns to the Program Bus Mix Inputs. The signal from these jacks is routed to the 1608 Program Bus by assigning the corresponding Summing Bus Masters to the Left and Right Program Bus on the 168B module. This allows the DAW mix to feed the Program Bus Inserts and Master Fader.

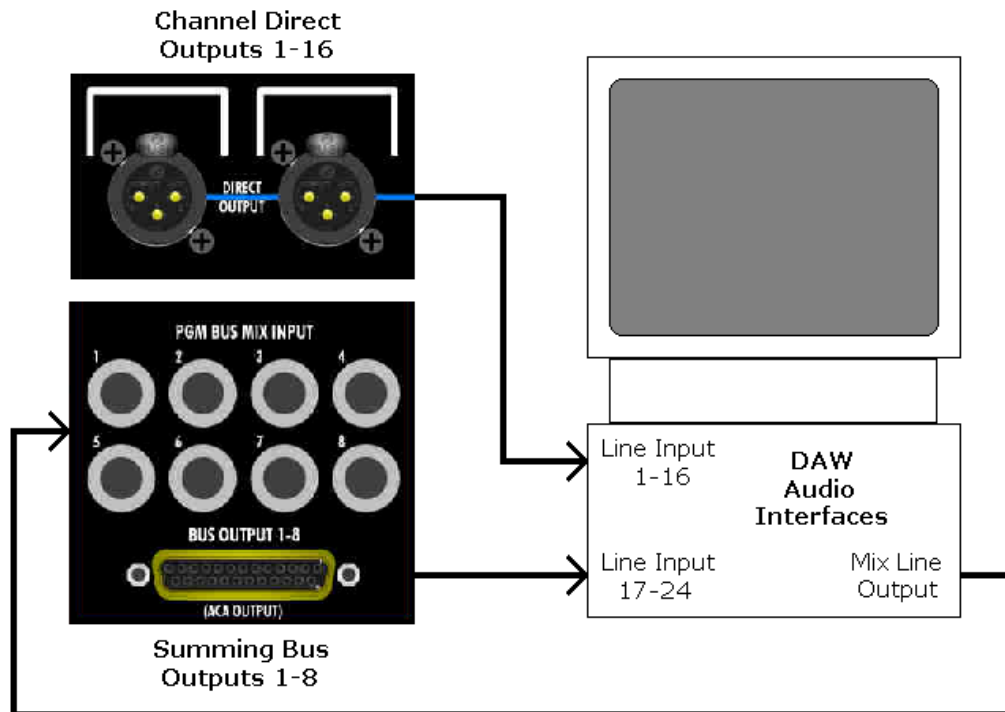

NOTE: This scenario requires the use of a pair of Summing Bus Masters to return the stereo mix to the Program Bus. If used for this purpose, the selected Summing Buses cannot be used as multitrack sends.

Multitrack Recording Scenario #2

The diagram below shows the connections as above, except the mix return from the DAW is routed directly to the 845B Control Room Monitor module for monitoring. In this scenario, the Program Bus Inserts and Master Fader are bypassed.

This scenario requires the engineer to sum the recorded channels to a stereo or 5.1 mix within the DAW and output this mix for monitoring via the 845B Control Room Monitor module.

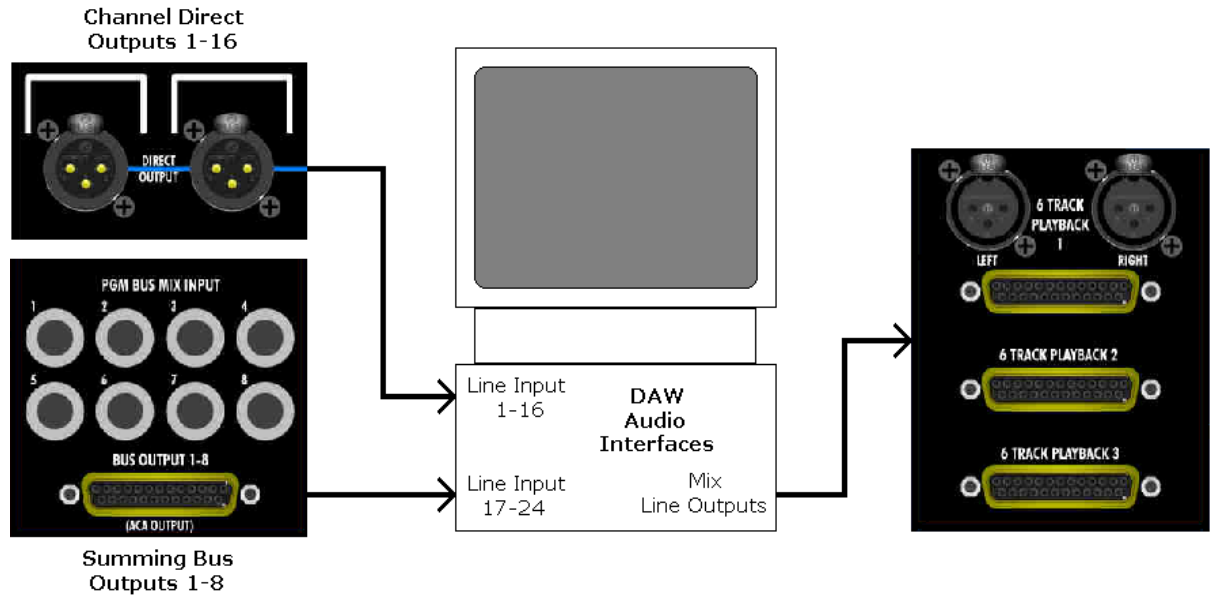

10.2 Multichannel Mixing

This setup uses the 1608 as a return path and mixer from a multitrack recorder, DAW, stage, or other sources. It can be used while tracking, overdubbing, and mixing. If used during tracking or overdubbing, the input to the recorder or DAW might be fed by unused 1608 channels/echo returns or an audio path that's external to the console.

- 1) Connect the returns (outputs) from the recorder, DAW, or other sources to the channel Line Inputs as desired
 - If a DAW is used, tracks could be sub-grouped as needed before feeding the DAW
- 2) Additional mix inputs can be created using:
 - Echo Returns (see below)
 - Echo Send External Input (see below)
 - Program Bus Mix Inputs (see below)
- 3) Select Line Input on the channels connected to multitrack returns (the Line Input is the default channel input, so no buttons need to be engaged)
- 4) Engage the PGM buttons to assign the channels (and other inputs) to the Left and Right Program Buses (stereo mix buses)
- 5) The Summing Buses and/or Echo/Aux sends can be used to create the additional mix outputs needed for multichannel mixing (LCRS, 5.1, 5.1EX, 7.1)
- 6) Use the onboard filter and EQ as needed
 - Additional signal processors (such as a compressor) may be patched into various places in the channel audio path via the Insert and other connections on the rear panel
- 7) The contribution to the mix will be controlled by the channel Fader, Mute, and Pan-pot
- 8) The channel Echo Sends and Auxiliary Buses can be used for:
 - Echo sends to feed effects units
 - Pre-fader cue/foldback sends (for tracking, overdubbing, broadcasting, live events)
 - Sub-group sends
 - Additional output paths for multichannel mixing (LCRS, 5.1, 5.1EX, 7.1)
- 9) Summing Buses can also be used as:
 - Multitrack summing
 - Additional post-fader mono auxiliary sends
 - Audio sub-groups sends
 - Additional mix outputs
 - Additional output paths for multichannel mixing (LCRS, 5.1, 5.1EX, 7.1)
- 10) Summing Buses Output Sub-masters can be used as:
 - Multitrack output masters
 - Additional post-fader mono auxiliary send masters
 - Audio sub-groups masters
 - Additional mix inputs
 - Additional mix output masters
 - Output masters for multichannel mixing (LCRS, 5.1, 5.1EX, 7.1)
- 11) Echo Send modules can be used as:
 - Echo/Auxiliary Bus Masters for feeds to effects units and cue/foldback systems
 - Additional mix inputs
 - Sub-group masters
 - Additional output paths for multichannel mixing (LCRS, 5.1, 5.1EX, 7.1)
- 12) Echo Returns can be used as:
 - Echo Returns for effects units and other devices
 - Additional mix inputs
 - Input channels for tracking and overdubbing
 - Sub-group mix returns
- 13) Unused channels can be used as:
 - Additional mix inputs
 - Input channels for tracking and overdubbing
 - Echo Returns for effects units and other devices
 - Sub-group returns (patching required)
- 14) The Program Bus Inserts can be used for additional processing of the Left and Right mix (such as equalization and/or compression)
- 15) The contribution to Left and Right Program outputs will be controlled by the channel Left and Right Program Output Masters (PGM L and R) and the Stereo Master Fader
- 16) Connect the Left and Right Program outputs (and other outputs if multichannel mixing) to the mix recorder inputs

- 17) The mix of the multitrack returns could be routed back to the console via channels, echo returns, an external control room monitor input, or even the Program Bus insert return for further processing, routing, and/or monitoring

Mixing Scenarios

The diagram below shows the connections between a Digital Audio Workstation (DAW) with 24 line outputs and a 1608 for stereo or surround mixing. The first 16 channels are fed from the DAW outputs 1-16 via the Channel Line Inputs. DAW outputs 17-24 are fed to the 1608 Echo Return Inputs 1-8.

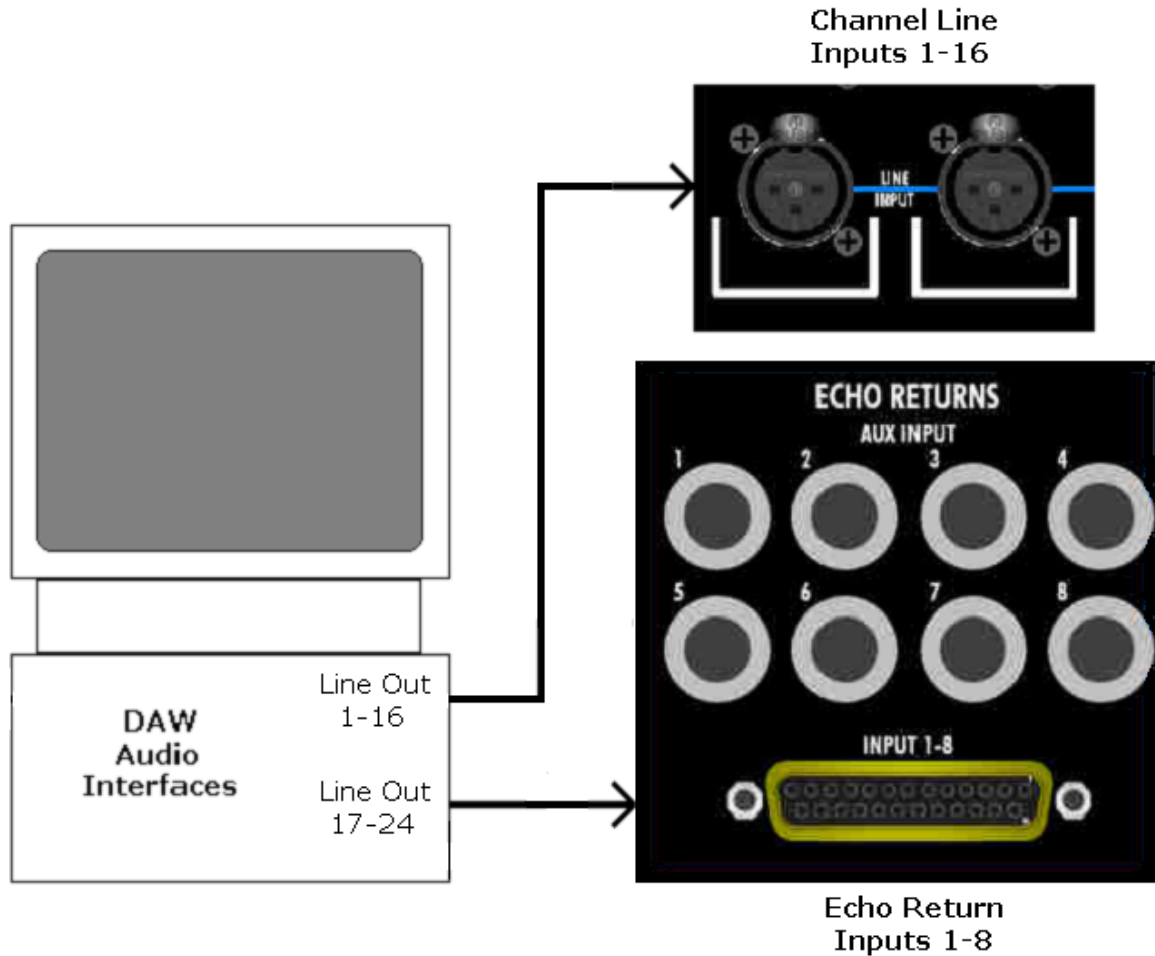

Select the Line input on channels.

For stereo mixing make assignments to the Program Bus.

For surround mixing, use Program and Summing Bus 1-4 assignments to create six mix paths for 5.1 mixing as follows:

Left	Program Bus Left
Right	Program Bus Right
Center	Summing Bus 1
Sub (LFE)	Summing Bus 2
Left Surround	Summing Bus 3
Right Surround	Summing Bus 4

Make Program and Summing Bus assignments as need to route the channels to the appropriate mix bus(es).

Turn ON Aux Sends 7 and 8 and engage the TO BUS button. This will allow Aux Sends 7 and 8 to act as level, mute, and pan controls for contributions to the mix via Summing Buses 1-4

(Center, Sub, Ls, Rs). When the PRE button is engaged, Aux Sends 7 and 8 are fed pre-fader. This provides independent control when a channel is also assigned to the Program Bus. The Echo Returns can be used to return additional channels from the DAW, returns from virtual instruments, returns from outboard effects processors, or any other line-level source. If the Echo Return 500 slots are fitted with the 550A Discrete 3-Band EQ, 550B 4-Band EQ, 560 Graphic EQ and/or 525 Compressors, the audio returning to the Echo Returns can be further processed before contributing to the mix.

Echo Returns are assigned to contribute to the mix in the same manner as with the channels for both stereo and surround mixing. Engage the PAN button to enable the pan-pot.

Outboard Effects Processor Connections

The diagram below shows the connections between a 1608 and outboard effects processors for either mixing scenario above. Returning the outputs of the outboard effects processors to the Echo Returns Auxiliary Inputs allows easy switching of the Echo Return input source between the return of the DAW (main input) and the return from the effects processor (Aux Input) without changing connections on the rear panel.

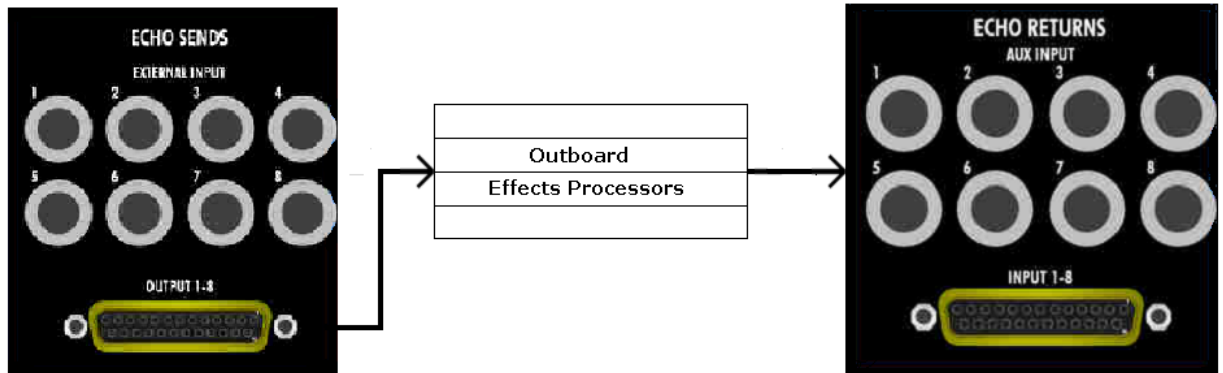

Mix Output Connections

The diagram below shows mix output connected to a DAW (or other mix recorder).

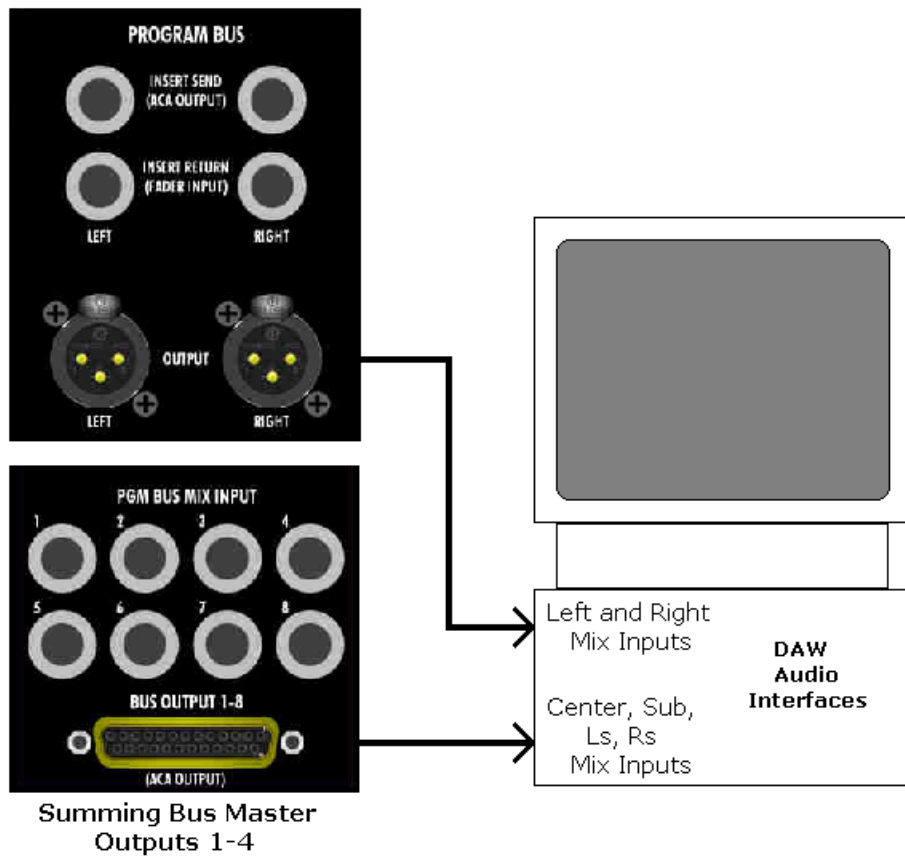

Basic Record and Mix Connections

The diagram below shows the connections between a 1608 and a DAW (or other multitrack recorder) for both recording and mixing without changing connections on the rear panel.

For recording, select the Mic or Instrument input on the 1608 channels and output to the DAW via the Channel Direct Output or Summing Bus assignments. The Echo Returns can be used as additional input channels as needed, feeding the DAW via assignments to the Summing Buses. During recording, a stereo mix can be created in the DAW and monitored as described in the Multitrack Recording scenarios above.

For mixing, select the Line input on the channels and assign them to the Program Bus for stereo mixing and the Program Bus and/or Summing Buses for surround mixing. The Echo Returns can be assigned accordingly and used to return additional channels from the DAW or returns from outboard effects processors.

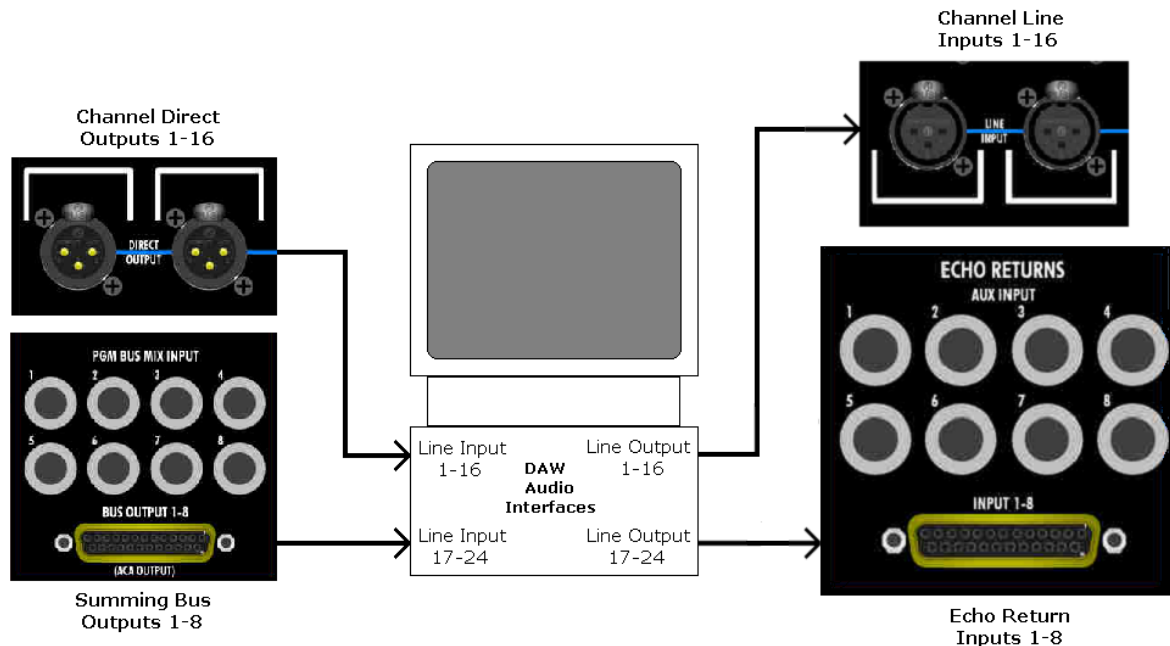

10.3 DAW Hybrid

It is possible to use the 1608 as both the input path to a multitrack recorder or DAW *and* a return path for mixing as well. This is accomplished by interfacing the recorder or DAW within the channel signal flow. This simultaneously provides high-quality input paths for recording and powerful analog mixing capabilities. It is best suited for use with a DAW, but could be used with any multitrack recorder. Possible configurations include:

Preamp Output to DAW Input – DAW Output to Equalizer Input:

- Input Path: Preamp Only
- Return Path: EQ, Insert, Fader, Filter, Panning, Output Assignments, Echo/Aux Sends

Insert Send (EQ Output) to DAW Input – DAW Output to Insert Return (Fader Input):

- Input Path: Preamp and EQ
- Return Path: Fader, Filter, Panning, Output Assignments, Echo/Aux Sends

Additional signal processing can be added at any point in the patching if needed.

Another possible configuration is using the 1608 channels to feed the multitrack recorder or DAW and the Echo Returns as multitrack returns (or vice-versa). This might require sub-grouping the tracks before feeding the DAW outputs.

10.4 E1608 Echo Send Applications

Echo Send Master:

- Turn the Echo Send ON
- Set the level to unity gain
- The Echo Send is fed by the corresponding Auxiliary Bus
- The Echo Send output is fed to the Echo Sends Output connector

Mix Input:

- Connect the output of the desired device (effects unit, recorder, DAW, etc.) to the Echo Send External Input
- Engage the EXT IN
- Turn the Echo Send ON
- Set the Echo Send level to unity gain
- The Echo Send is fed by the External Input *and* the corresponding Auxiliary Bus
 - Do not use the corresponding channel Echo sends if an isolated input is desired
- Press the MIX button on the corresponding Echo Return
- The Echo Send output is fed to the Echo Return and the Echo Sends Output connector
- Assign the Echo Return to the Program Bus and/or Summing Buses as needed
- Engage the PAN button if panning is needed
- Set the Echo Return level as desired

Audio Sub-group Master:

- Use channel Echo sends to feed the channels to be grouped to the desired Auxiliary Buses
 - It might be desirable to de-assign these channels from the Program Bus
- Turn the Echo Send ON
- Set the Echo Send level to unity gain
- The Echo Send is fed by the corresponding Auxiliary Bus
- Press the MIX button on the corresponding Echo Return
- The Echo Send output is fed to the Echo Return and the Echo Sends Output connector
- Assign the Echo Return to the Program Bus and/or Summing Buses as needed
- Engage the PAN button if panning is needed
- Set the Echo Return level as desired

Aux Send Multichannel Mix Output Master (LCRS, 5.1, 5.1EX, 7.1):

- Use the Program Bus for the Left and Right channels
- Select four channel Echo/Aux Sends for use as Center, Left Surround, Right Surround, and LFE channels
 - Using a stereo aux send for the Left and Right Surround channels is suggested
 - Using a mono aux send for the Center and LFE channels is suggested
- Make sure the PRE buttons are not engaged if you want the send to follow the Fader
- Turn the selected channel Aux Sends ON and set the levels to unity gain or as needed
- Use the channel fader to adjust the contribution to the assigned 5.1 mix channels
- Turn ON the selected Echo Send modules
- Set the Echo Send level to unity gain
- The Echo Send module is fed by the corresponding Auxiliary Bus
- The L/R mix outputs are fed to the L/R Program Output connectors
- The Ls, Rs, C, and LFE mix outputs are fed to the Echo Sends Output connector
- Use additional Aux Sends if additional mix outputs are needed

10.5 E1608 Echo Return Applications

Echo Return/Mix Input:

- Connect the output of the desired device (effects unit, recorder, DAW, etc.) to the Echo Return Input or Echo Return Auxiliary Input
- Engage the AUX IN button if desired
- Assign to the Program Bus
- Engage PAN button to engage the Pan-pot if needed
- Set the level and pan as desired

Tracking Input:

- Connect the output of an external preamp or other line-level device to the Echo Return Input or Echo Return Auxiliary Input
 - If an API 512C Preamp is mounted in the corresponding Echo Return 500 Slot, it can be used as a microphone or instrument preamp
- Engage the AUX IN button if desired
- Assign to the desired Summing Bus(es)
- Engage PAN button to engage the Pan-pot if Odd/Even panning is needed
- The Echo Return level will control the output to the Summing Bus
- The Summing Bus feeds Summing Bus Sub-master (SUB 1-8)
- Turn ON the corresponding Sub-master
- Set the sub-master to unity gain or as needed
- Connect the Bus Output connector to the input to the recorder or DAW

Audio Sub-group Return:

- Use channel Echo/Aux sends to feed the channels to be grouped to the desired Auxiliary Buses
 - It might be desirable to de-assign these channels from the Program Bus
- Turn the Echo Send ON
- Set the Echo Send level to unity gain
- The Echo Send is fed by the corresponding Auxiliary Bus
- Press the MIX button on the corresponding Echo Return
- The Echo Send output is fed to the Echo Return and the Echo Sends Output connector
- Assign the Echo Return to the Program Bus and/or Summing Buses as needed
- Engage the PAN button if panning is needed
- Set the Echo Return level as desired

NOTE: Alternately the outputs from the Summing Bus Sub-masters may be patched to the Echo Return Inputs (or Aux Inputs) to feed a sub-group to the Echo Returns.

10.6 168B Summing Bus Sub-master Applications

Multitrack and Audio Sub-group Master:

- Use channel assignment buttons to feed the post-fader signal to the desired Summing Bus(es)
- The audio from all of the channels contributing to a summing bus will be summed at the Sub-master
- Turn ON the corresponding Summing Bus Sub-master
- Set the level to unity gain or as needed
- The sub-master output is fed by the corresponding Bus Output connector
- Connect the Bus Output to the input of the recorder, DAW, or unused input (patching required)

Echo Send Master:

- Use channel assignment buttons to feed the post-fader signal to the desired Summing Bus(es)
- Turn ON the corresponding Summing Bus Sub-master
- Set the level to unity gain
- The Sub-master output is fed by the corresponding Bus Output connector
- Connect the Bus Output to the input of the device to be used

Mix Input:

- Connect the output of the desired device (effects unit, recorder, DAW, etc.) to the Program Bus Mix Input
- This input feeds the input to the Program Bus Assignment switches on the Summing Bus Sub-masters 1-8
- Turn the corresponding Sub-master ON
- Assign to the Program Bus
- Use the TRIM control to set the desired level

Summing Bus Multichannel Mix Outputs (LCRS, 5.1, 5.1EX, 7.1):

- Use the Program Bus for the Left and Right channels
- Select four Summing Buses for use as Center, Left Surround, Right Surround, and LFE channels and make the appropriate assignments
 - The Pan-pot may be engaged for Left and Right Surround panning
- Use the channel fader to adjust the contribution to the assigned 5.1 mix channels
- Turn ON the selected Summing Bus Sub-masters (SUM 1-8)
- Set the levels to unity gain
- The Summing Bus Sub-masters are fed by the corresponding Summing Buses
- The L/R mix outputs are fed to the L/R Program Output connectors
- The Ls, Rs, C, and LFE mix outputs are fed to the Buss Output connector
- Use addition Summing Buses if additional mix outputs are needed
- The Summing Buses and Sub-masters can also be used as additional Left and Right mix outputs

10.7 Echo Return 500 Slot Applications

The console is equipped with eight Echo Return 500 Slots. These 500 Slots are built to power and interface any API 500 Series module:

- 512C Preamplifier
- 525 Compressor
- 550A 3-Band EQ
- 550B 4-Band EQ
- 560 Graphic EQ

Some possible applications of the 500 Slots include:

- Extra microphone/instrument inputs (when equipped with a 512C Preamp)
- Extra signal processing for the Echo Return inputs
- Patchable signal processing for use in the channel Inserts and patch points
- Patchable signal processing for use in the Program Bus Inserts
- Patchable signal processing for use anywhere else (internally, externally, etc.)

When equipped with a 512C Preamp, the 500 Slot and Echo Return combine to form a powerful input module capable of routing a microphone, instrument, or line input to the Program and/or Summing Buses with full assignment, panning, and solo functions. This can greatly expand the capabilities of the console for almost all applications.

When equipped with a 512C Preamp, an API EQ, and a 525 Compressor, three 500 Slots can be used to create a single high-quality signal path for direct feed to the multitrack recorder or DAW.

As indicated by these examples, the 500 Slots can be custom configured to add versatility and maximize performance.

The features of the 500 Slots are as follows:

- All eight 500 Slots are empty in the standard 1608 configuration. If a slot is empty, the signal will loop through the slot to feed the corresponding Echo Return input when a Bypass Card is inserted into the card edge connector of the corresponding slot (*These cards are supplied by API when the console is delivered without 500 modules in any 500 slot*)
- 500 Slots can deliver 48v phantom power to the Echo Return Input connector if equipped with a 512C Preamp
- The slots are normalled between the Echo Returns Input connector and the inputs to the Echo Return modules
- If engaged, the module mounted in a slot will process the audio before it arrives at the Echo Return module input
- If a slot is empty, the signal will loop through the slot to feed the corresponding Echo Return module input
- The modules in the Echo Return 500 Slots may be used elsewhere by using the ECHO RETURN 500 SLOT INPUT and OUTPUT patch points on the rear panel
- Inserting a plug into the ECHO RETURN 500 SLOT INPUT jack will defeat the signal from the Echo Return Input connector, but the output of the slot is still sent to the Echo Return module
- The 500 Slot may be bypassed by using the Echo Return Auxiliary Input

WARNING – WARNING – WARNING – WARNING – WARNING

The use of NON-VPR Alliance approved 500 series modules in the 1608 is vehemently discouraged, and may cause operational difficulties with the console. Improper operation, excessive current draw and poor module fit are all potential issues with these devices.

For the most recent list of VPR Alliance approved modules, please visit www.apiaudio.com.

API reserves the right to deny warranty claims when non-VPR Alliance 500 series modules are used.

10.8 Rear Panel DB25 Wiring Diagrams

The Rear panel DB25 connectors of the 1608 are wired as follows;

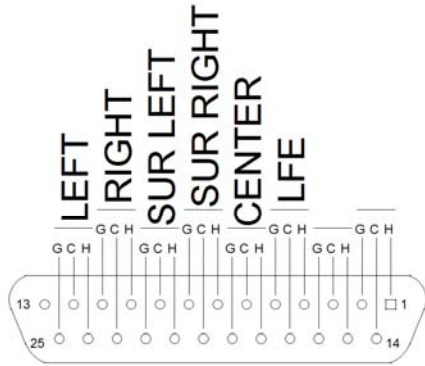

6 TRACK PLAYBACK #1

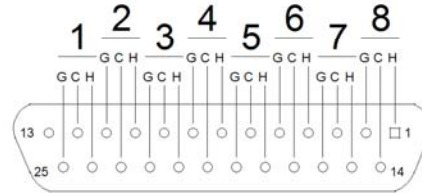

BUS OUTPUTS

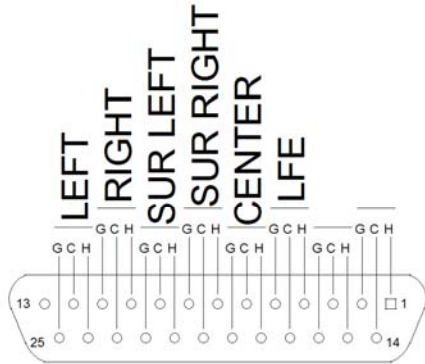

6 TRACK PLAYBACK #2

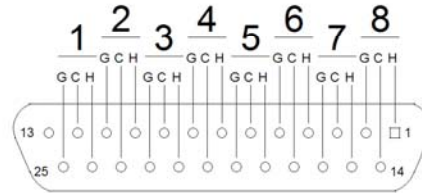

ECHO SEND OUTPUTS

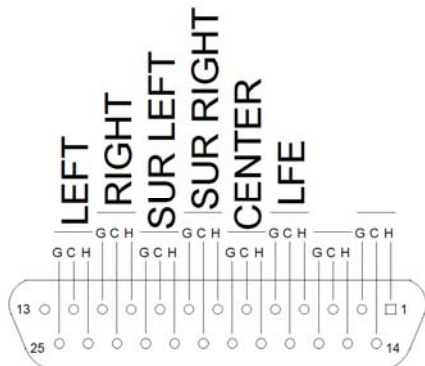

6 TRACK PLAYBACK #3

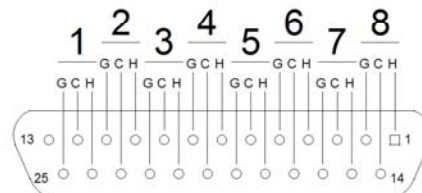

ECHO RETURN INPUTS

API 1608 Limited Warranty

- a. **Warranty Information:** This product carries a one year labor and a five year parts warranty from date of purchase. API (Automated Processes, Incorporated) does not cover claims for damage due to alteration and/or abuse. This warranty is limited to failures during normal use, which are due to defects in material or workmanship. If any defects are found in the materials or workmanship, or if the product fails to function properly during the applicable warranty period, API, at its option, will repair or replace the product.
- b. **PLEASE NOTE:** The design or quality of any non-authorized third party service or vendor is beyond the control of API. Therefore, use of **NON-API VPR Alliance modules in any API product – including consoles** may **VOID this warranty**. Also, service or modification of any API unit except by an authorized API representative may **VOID this warranty**.
- c. API reserves the right to inspect any products that may be the subject of any warranty claims before repair or replacement is carried out. Final determination of warranty coverage lies solely with API.
- d. This warranty is extended to the original purchaser and to anyone who may subsequently purchase this product within the applicable warranty period. Proof of purchase may be required.
- e. To obtain service:
 - a. Call API at 301-776-7879, 8:30 AM to 5 PM Monday through Friday (Eastern Time) to get a Return Authorization (RA). Products returned without an RA number may not be accepted.
 - b. Pack the defective part by wrapping in plastic and cushioning material. Seal securely in an approved shipping container. If you do not have a sufficient shipping container, ask API for advice when calling for the RA number.
 - c. Include a note explaining the problem and conditions of the service request. Include your complete return address (no P.O. Boxes, please)
 - d. Ship the product freight prepaid to:

API
8301 Patuxent Range Road
Jessup, MD 20794

IMPORTANT: Be sure the RA number is plainly written on the shipping carton

- f. This is your sole warranty. API does not authorize any third party, including any dealer or sales representative, to assume liability on behalf of API or to make any warranty for API.
- g. THE WARRANTY GIVEN ON THIS PAGE IS THE SOLE WARRANTY GIVEN BY API AND IS IN LIEU OF ALL OTHER WARRANTIES, EXPRESS AND IMPLIED, INCLUDING THE WARRANTIES OF MERCHANTABILITY AND FITNESS FOR A PARTICULAR PURPOSE. THE WARRANTY GIVEN ON THIS PAGE SHALL BE STRICTLY LIMITED IN DURATION TO FIVE (5) YEARS FROM THE DATE OF THE ORIGINAL PURCHASE FROM API OR AN AUTHORIZED API DEALER. UPON EXPIRATION OF THE APPLICABLE WARRANTY PERIOD API SHALL HAVE NO FURTHER WARRANTY OBLIGATION OF ANY KIND. API SHALL NOT BE LIABLE FOR ANY INCIDENTAL, SPECIAL, OR CONSEQUENTIAL DAMAGES THAT MAY RESULT FROM ANY DEFECT IN THE API PRODUCT OR ANY WARRANTY CLAIM.
- h. This warranty provides specific legal rights and you may have other rights which vary from state to state.

Housekeeping:

This is a great place to write down the serial number of your 1608 console and your purchase information, just in case you need that information someday in the future.

1608 serial Number: _____

Power Supply serial Number: _____

Purchase Date: ____/____/____



API, 8301 Patuxent Range Road, Jessup, MD 20794
Tel: 301-776-7879 www.apiaudio.com

In a constant effort to improve the subtle details of our products, some amount of change is inevitable.
API reserves the right to modify or change any of the features, specifications or performance of its products without notice or obligation.