

dbx

Model 166

**Professional
Dynamics Processor**

ATTENTION

IF YOU BEGIN WITHOUT READING THIS MANUAL, YOUR NEW 166 MAY SEEM TO BE NOT WORKING PROPERLY.

NO AUDIO

If you're not getting any audio out of the 166, check the GATE knob. Is the Threshold off? If not, turn it off (full counterclockwise).

If the Threshold isn't off, the circuit will attenuate the signal 40 dB, which will stop the audio from passing. Note that signals **BELOW** the Gate threshold are gated; signals **ABOVE** the compression threshold are compressed. If it's vice versa, nothing happens. Refer to the manual.

NO COMPRESSION

Did you plug into the Sidechain input? Take it out. Patch in **ONLY** when you have sidechain applications (again, refer to the manual). Also check to make sure the Sidechain Monitor button isn't pushed in.

INSPECTION and INSTALLATION

Your unit was carefully packed at the factory in a protective carton. Nonetheless, be sure to examine the unit and the carton for any signs of damage that may have occurred during shipping. If there is such evidence, don't destroy the carton or packing material, and notify your dealer immediately.

It's a good idea in any case to save the carton and packing should you ever need to ship the unit.

In the event of initial problems, first contact your dealer; your unit was thoroughly inspected and tested at the factory.

In addition to a model 166 and this owner's manual, the carton should contain a warranty/registration card. Please fill it out and send it to us.

The chassis has integral brackets (rack "ears") for mounting into a standard equipment rack (19" or 48.3 cm wide). No special cooling or ventilation is required in any installation; other components may be stacked above or below the unit provided they don't generate excessive heat.

WARNING

**TO PREVENT FIRE OR SHOCK HAZARD,
DO NOT EXPOSE THIS COMPONENT
TO RAIN OR MOISTURE.**

This triangle, which appears on your component, alerts you to the presence of uninsulated dangerous voltage inside the enclosure — voltage that may be sufficient to constitute a risk of shock.



This triangle also appears on your component, and it alerts you to important operating and maintenance instructions in this accompanying literature.

CAUTION
To Reduce Further the Risk of Shock, Do Not Remove the Cover or Back. There Are No User-Serviceable Parts Inside; Refer All Servicing to Qualified Personnel.

"dbx," "OverEasy," and "PeakStop" are all registered trademarks of dbx Professional Products. San Leandro CA.

CONTENTS

Front panel (operation)	2
Rear panel (connections)	2
Typical hookups (plug and cable wiring)	4
Application notes (gating, compression, limiting, sidechain)	7
Block diagram	13
Schematic	14
Warranty and factory service	15

SPECIFICATIONS

Frequency response

20 Hz-20 kHz +0.5 dB

THD (total harmonic distortion)

0.2% at maximum
compression, 1 kHz, 0 dBv

Equivalent input noise

-85 dBv unweighted

Maximum input

+24 dBv

Maximum output

+21 dBv

Input impedance

25 k-ohms differential,
18.5 k-ohms unbalanced
Detector: 6.8 k-ohms, unbalanced

Output impedance

Low, single-ended, for driving 600 ohms or greater

Output gain

-20 to +20 dB

Threshold range

Compressor: -40 to +20 dBv
Gate: +10 to -60 dBv
PeakStop: 0 to +21 dBv

Attack times

Compressor (program-dependent):

15 ms for 10 dB,
5 ms for 20 dB,
3 ms for 30 dB

Gate:

2 ms for 28 dB (70% of return to unity gain)

Release times

Compressor:

8 ms for 1 dB,
80 ms for 10 dB,
400 ms for 50 dB (125 dB/s rate)

Gate, slow: 100 ms for 1 dB

fast: 100 ms for 100 dB

Maximum compression

Greater than 60 dB

Power requirements

90-135 V (120V model),
200-260 V (240V model),
50-60 Hz; 15 W

Dimensions

1-3/4" h x 19" w x 8" d

Notes

- 1) Specifications are subject to change.
- 2) All voltages are rms (root-mean-square).
- 3) 0 dBv is defined as 0.775 V regardless of load impedance. Subtract 2.2 from the dBv figure to convert to dBV (i.e., referred to 1 V). When the load impedance is 600 ohms, this particular dBv is also known as "dBm."
- 4) Noise figures are for 20 Hz-20 kHz.
- 5) Measured in the infinite-compression region of the dbx OverEasy curve, attack time is the time required to reduce the signal by 63% of the level increase above threshold, while release time is the time required to restore gain to 90% of the level decrease below threshold.

REAR, Channel 2 (1 is identical)

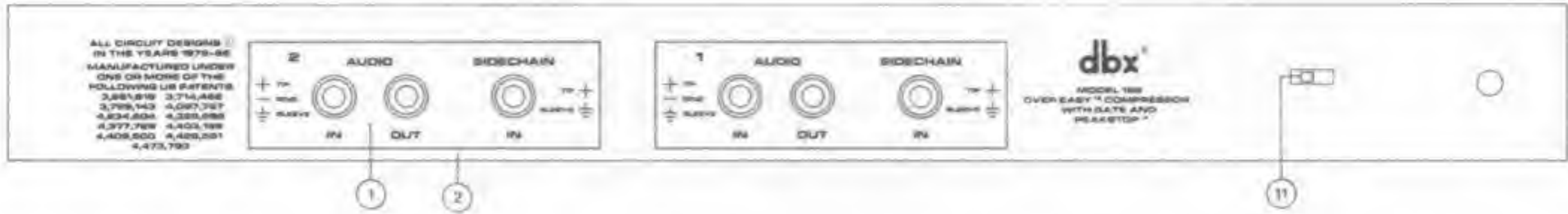

- 1 AUDIO:IN, OUT. These two 3-circuit phone jacks are the Input and Output. As marked, these jacks are the standard tip/plus, ring/minus, and sleeve/ground.
- 2 SIDECHAIN:IN. This jack provides a direct input (optional) to the rms-detector circuitry. It is used for connecting a signal processor for altering the dynamic response of the 166. An example would be an equalizer to make the compression or the gating frequency-sensitive (see Sidechain Monitor, below). This input uses a 2-circuit phone jack: tip is plus, sleeve ground.

FRONT, Channel 1 (2 is identical)

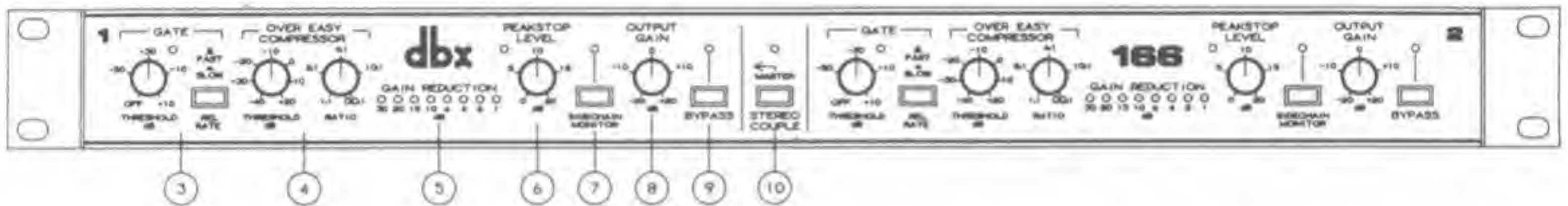

- 3 GATE:THRESHOLD and RELEASE RATE:FAST, SLOW. The 166 gate is a below-threshold attenuator with two release rates. The Threshold knob sets the level below which the 166 gates — attenuates — the signal. The LED lights whenever this takes place. As marked, the threshold ranges from +10 to below -60 dB; Off, of course, inactivates the gate. The amount of attenuation is set at 40 dB.

The RELEASE RATE switch controls how fast the signal gets attenuated. In the Slow position (in), the rate is useful for general-purpose gating of noise behind vocals and acoustic instruments — about 10 dB/s. In the Fast position, the rate is very fast (1000 dB/s), useful for tightening up the sound of percussion (e.g., kick or snare drum) and drying up leakage from other instruments into percussion tracks.

The attack rate of the gate (which controls how fast the signal is restored after being attenuated) is internally set to be very fast — fast enough to allow all of the transient at the beginning of a note to come through.

- 4 OVEREASY COMPRESSOR:THRESHOLD and RATIO. The Threshold knob sets the point at which dbx's well-known Over-Easy circuit begins to compress the dynamic range of the signal. The calibration numbers refer to the middle of the Over-Easy curve (see right); at an Infinity:1 ratio, they denote the point where there's approximately 6 dB of compression. The OverEasy sound is musical and unobtrusive, without the "held-back" feeling of other compressors.

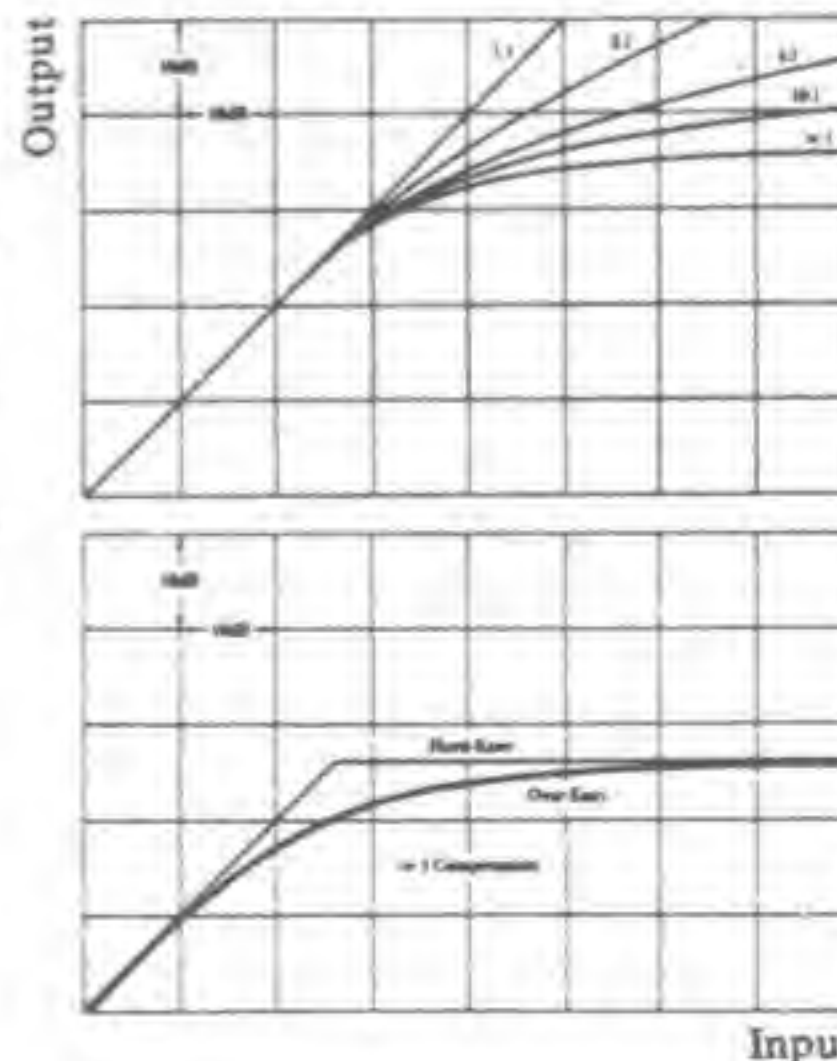

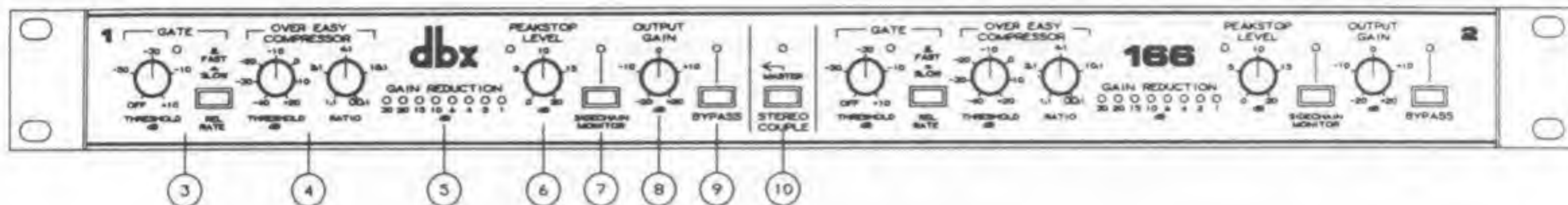

The Ratio knob controls how much the signal will be compressed once it's well above the threshold, in the straight-line section of the OverEasy curve. The ratio is the change in input level divided by the change in output level, e.g., a 4:1 setting means that for a 4-dB increase in input level the output will increase by only 1 dB. At Infinity:1, the output will remain at a constant level irrespective of input dynamics (as long as the input is above threshold) — in other words, full limiting.

- 5 GAIN REDUCTION LEDs. These show how much the signal is being attenuated by the Gate, the Compressor, or both.
- 6 PEAKSTOP LEVEL knob. This sets the maximum peak-output level. The control is calibrated to the rms value of a sine wave just being clipped. The LED lights whenever this clipping — soft at the start, becoming hard as necessary for absolute protection — occurs. See the note on page 9.

This is the last circuit the signal goes through, so it always controls the maximum output regardless of any other control — including Output Gain.

- 7 SIDECHAIN MONITOR switch and LED. Pushing this in connects the Sidechain input directly to the Audio Out, for monitoring the sidechain signal during setup. Be careful not to push this button inadvertently — it affects what you (and everybody else) will hear, or what's going to a console/mixer or tape recorder. Note that PeakStop is in the sidechain signal path when Sidechain Monitor is selected.
- 8 OUTPUT GAIN. This knob controls the overall gain of the 166, from -20 to +20 dB. It is independent of all other controls although, as mentioned, it does come before the PeakStop circuit.
- 9 BYPASS switch and LED. Pushing this in provides a hardwire bypass for the 166, connecting input to output (fully balanced if so wired) even in the absence of ac power.
- 10 STEREO COUPLE switch and LED. Pushing this in turns the 166 from a dual-mono unit with two identical, independent sets of controls into a stereo unit. Except for Sidechain Monitor and Bypass, Channel 2's controls are overridden by Channel 1's in the Stereo Couple mode. Note that the detection circuitry senses the true rms levels of the combined signal, so it is unaffected by phase shifts (or other discrepancies) between the channels. Among other benefits, this enables stereo compression without loss of imaging stability.
- 11 VOLTAGE SWITCH. This must be properly set for your AC voltage, be sure to check before plugging in and powering up. For 220V operation you will need a suitable adaptor plug.

TYPICAL HOOKUPS

All 166 connections are made through the rear phone jacks; our figures in this section show the wiring of plugs and cables to make these connections. Again, tip is plus (or high, or hot), ring is minus (or low), and sleeve is ground or shield (or earth).

Audio inputs and balanced and unbalanced sources

Your unit's two signal inputs are balanced electronically with differential amplifiers. They won't unbalance a balanced source, and they may be used with unbalanced sources as well. Here's a general-purpose diagram:

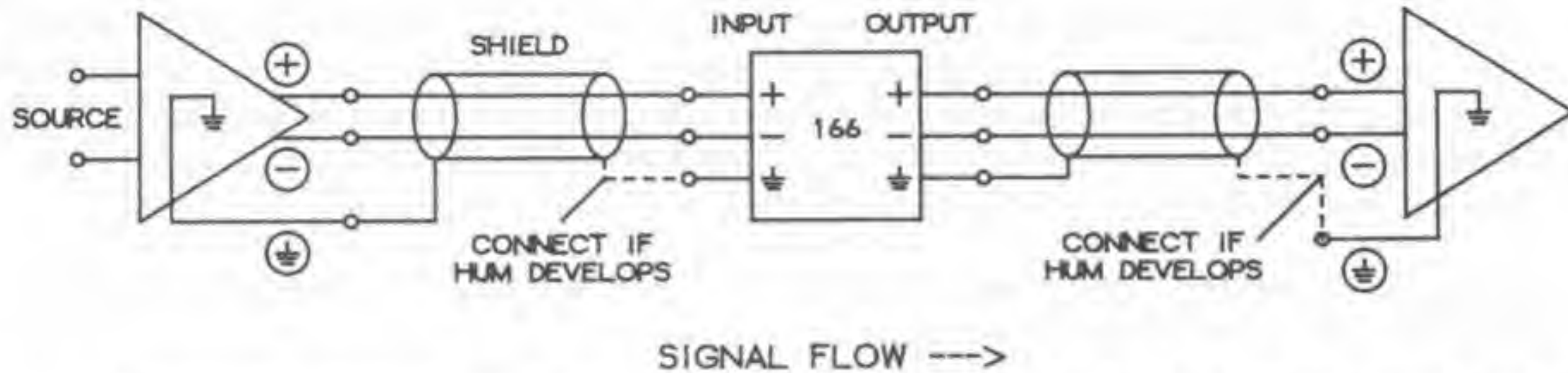

For maximum hum rejection, avoid common grounding at the 166's input and output. The best starting point is to ground the shield of the input cable and the source device (leaving it unconnected to the 166) and to ground the shield of the output cable to the ground of the 166 (leaving it unconnected at the receiving device).

A balanced line is defined as two-conductor shielded cable with each of the two center conductors carrying the signal but of opposite polarity and equal but opposite potential difference from ground. An unbalanced line is a single-conductor shielded cable with the center conductor carrying the signal and the shield at ground potential.

Figure 1 shows the connection of balanced signal sources to either audio input jack. Note that for this connection a 3-circuit phone plug is necessary, as is dual-conductor shielded cable. Sometimes the plug is called a "stereo" phone plug because it's often used for such stereo circuits as headphones.



Figure 1: Balanced sources

Figures 2a and 2b show an unbalanced source connected to these inputs. In 2a, a 3-circuit phone plug is used (and the ring is connected to the shield), while in 2b a 2-circuit ("mono") phone plug is used. Since this plug has a continuous sleeve (where the 3-circuit plug has both sleeve and ring), the plug automatically shorts the sleeve to the ring at the 166 input.

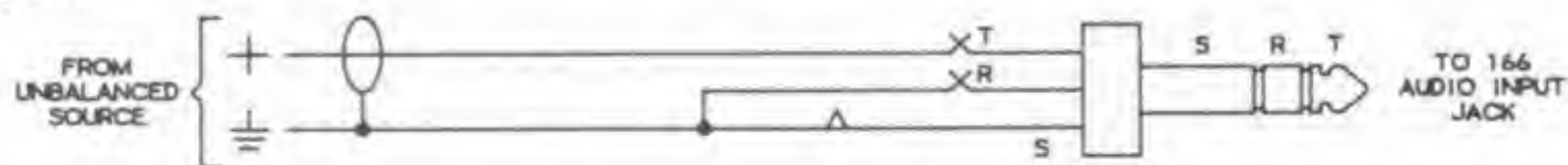

Figure 2a: Unbalanced sources, dual-conductor shielded cable

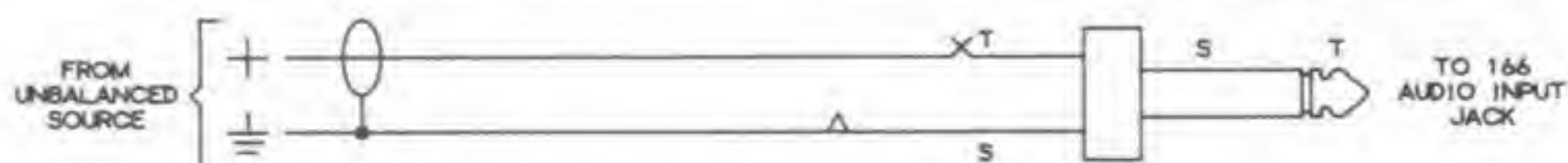

Figure 2b: Same, single-conductor cable

In situations with high radio-frequency interference (RFI) but unbalanced sources, wiring as shown in 3a and 3b may be of use. These call for 2-conductor shielded cable with 3-circuit or 2-circuit plugs and use the shield as only a shield, the ground connection actually being made with one of the center conductors.

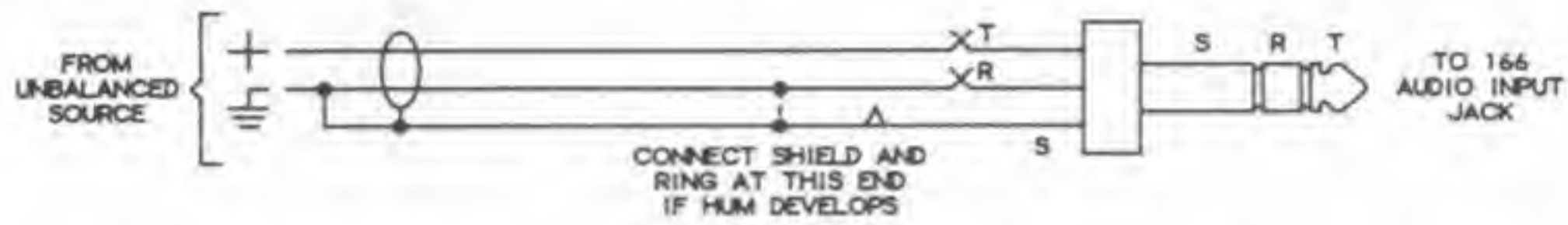

Figure 3a: Unbalanced sources, dual-conductor shielded cable, stereo plug

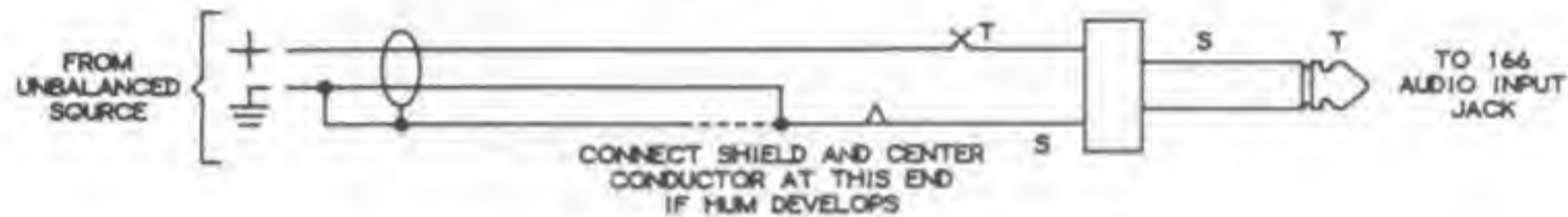

Figure 3b: Same, mono plug

Audio outputs and balanced and unbalanced loads

The two audio outputs are driven by unbalanced single-ended line amplifiers whenever the Bypass switches are not depressed. Able to drive 600-ohm or greater loads to +21 dBv, these stages are suitable for connection to most studio equipment, balanced or not.

Figure 4 shows the balanced connection of the set of output terminals to balanced inputs. Note again that each output has signal tip/ring/sleeve ([+], [-], and ground), like the balanced inputs. The outputs are connected directly to the inputs in Bypass mode, so a balanced input remains balanced at the output when the unit is bypassed. The minus and the ground terminals of each output are internally connected whenever the unit is not bypassed.

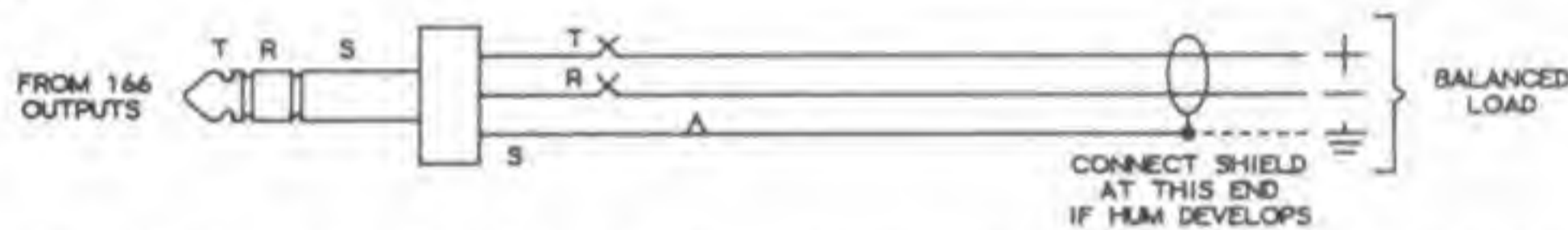

Figure 4: Balanced ins and outs, dual-conductor shielded cable, stereo plug

Figures 5a and b show the output connections for unbalanced loads with 3- and 2-circuit plugs. As with the inputs, a 2-circuit plug (5b) will contact the ring (-) contact in the jack, which is perfectly okay for unbalanced loads; note that in Bypass, this will unbalance balanced sources, because the jack shorts the ring (-) contact to ground.

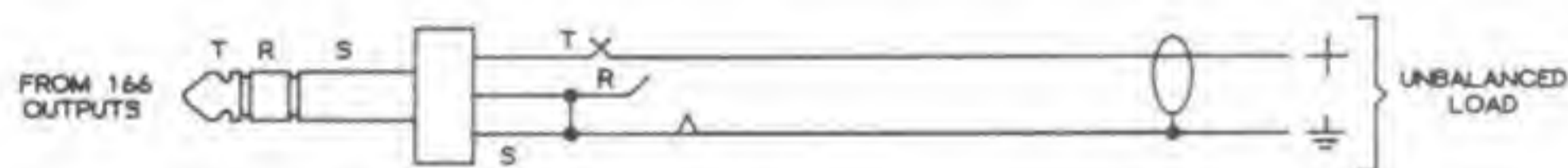

Figure 5a: Unbalanced loads, single-conductor shielded stereo plug

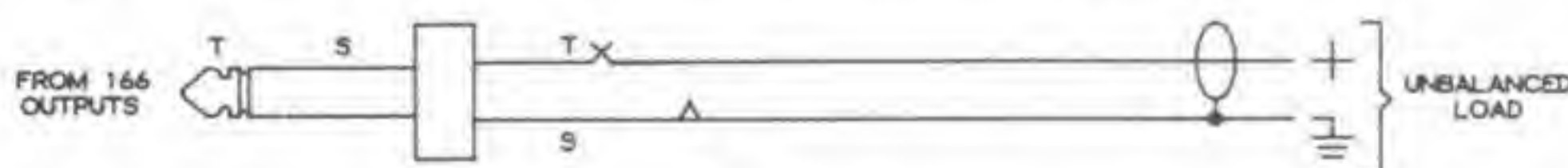

Figure 5b: Same, mono plug

Figures 6a and b show the use of 2-conductor shielded cable and either 3- or 2-circuit plugs with unbalanced loads; like 3a and b, this often is useful for combatting RFI with unbalanced loads.

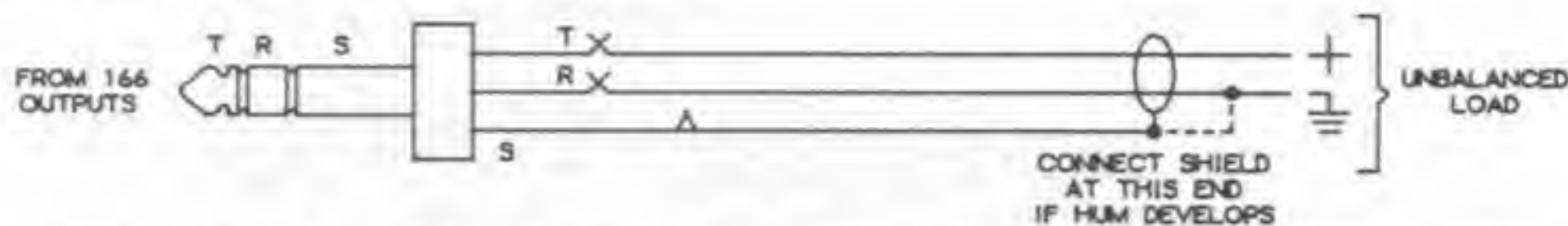

Figure 6a: Unbalanced loads, dual-conductor shielded cable, stereo plug

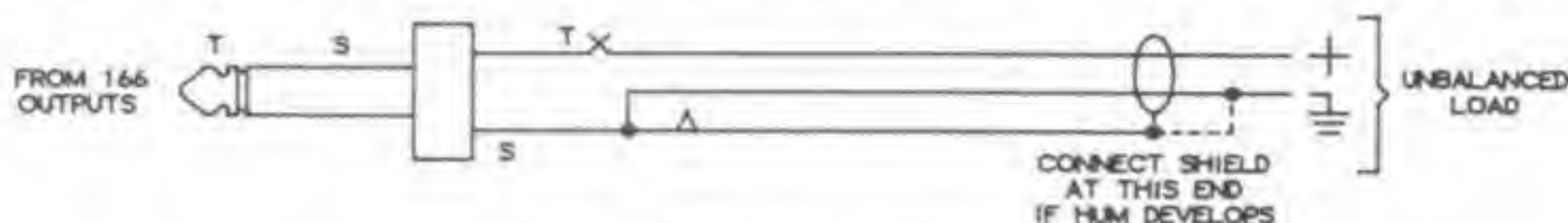

Figure 6b: Same, mono plug

Sidechain hookups

The sidechain inputs are unbalanced. They'll work with balanced and unbalanced sources, but will unbalance a balanced output.

Figure 7a shows the connection of an unbalanced signal source to either sidechain input jack; a 2-circuit plug is used since there are only two connections to make. If a 3-circuit plug is used, either leave the ring unconnected or connect it to the shield.

Figure 7b shows the connection of a balanced source to either sidechain input. Most balanced sources will work without the dotted connection between the (-) output and ground (this is true for "active-balanced" outputs and "ground-referenced" outputs). However, some sources require the dotted connections shown — "transformer-isolated" balanced outputs. We recommend making this connection only if necessary for your installation, because some active balanced and ground-referenced outputs may be damaged by doing so. Note that a 2-circuit plug is used here; follow the instructions above if a 3-circuit plug must be employed.

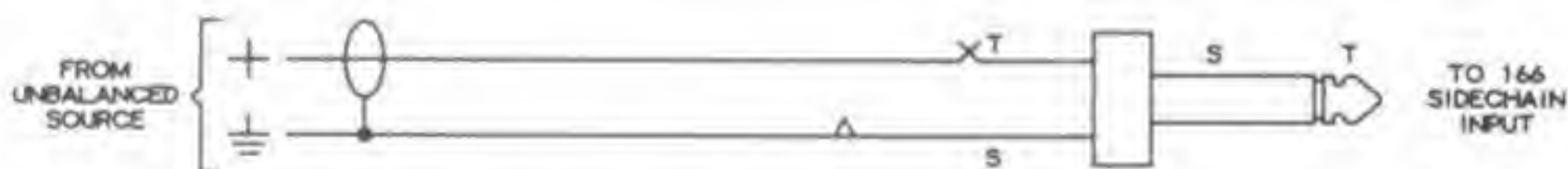

Figure 7a: Unbalanced source

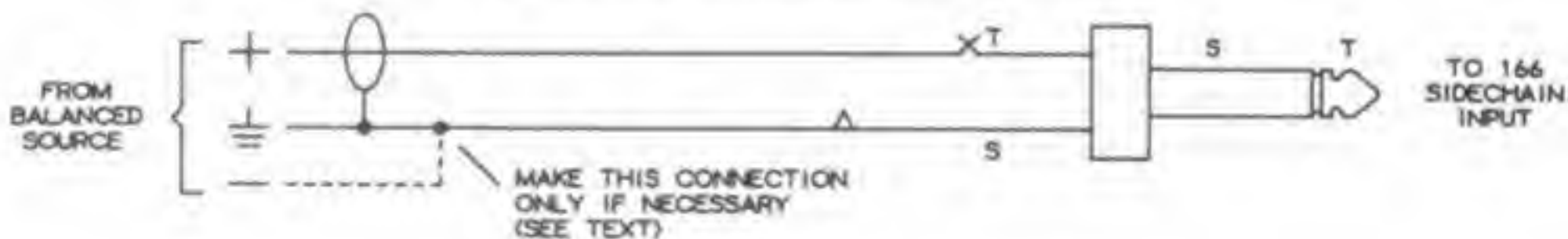

Figure 7b: Balanced source

ABOUT GATING

Noise reduction

The basic purpose of a noise gate is to remove unwanted background sounds in the spaces between desired foreground sounds. Note that there has to be some real distance in level between the unwanted and wanted material — at least a few dB — in order for the 166's gate to "get its foot in the door." If levels are too close (e.g., because of earlier compression, or because the mikes were closer to the unwanted than to the wanted sound), the gating efforts of the 166 will be for naught.

One of the more common uses for a gate is to tighten or "dry up" drum sounds. As with most dynamics processing, it's ideal if there is a separate mike on each drum and cymbal (or group of cymbals) and each is individually gated. Each mike is auditioned separately and the gate threshold adjusted to eliminate the sound of all but the desired drum. (Hint: start with the threshold very low, so all the sounds come through, then increase it until only the desired drum is left.) It's likely that you'll find the Fast release setting best for most drums, while slow usually is better for cymbals and some toms. When things are adjusted correctly, each drum will sound tight, punchy, and dry — detailed and defined.

When you don't have enough mikes (or 166es!) to cover each drum, then group them: snare and center toms, side toms, bass, cymbals. The idea is to get as close as possible to only one mike on at a time so only one sound is picked up, instead of several.

Another common use for a gate is in vocal recording. Especially after compression, the noises picked up by a mike an inch away from a singer's mouth can be very obtrusive. Try the 166 in its slow release mode to gate out these noises. Other applications include keeping live drum tracks from "contaminating" an acoustic-piano track, and general solving of other sorts of leakage problems.

Changing sound quality

There's more to gating than just keeping out unwanted background noises: you can use the 166 gates to change sonic character. This is because gates can be used to reduce or otherwise alter the quality of instrumental ambience and reverb. As the sound decays after an instrument stops, its reverberation level will fall through the 166's Threshold setting, below which it can be made to die out more or less quickly — in any case faster than the natural sound. Experiment with changing the "tail" of the sound; the fast setting will nearly eliminate reverb.

In other situations, a 166 can be used to prevent or reduce leakage among mikes in sound reinforcement or during panel discussions. Simply set the Threshold control below the level of the music or speech. Similarly, in broadcasting, a 166 can be used to clean up noisy feeds (land lines, ENG audio) if it's placed at the output. Wind or air-conditioning noise during a remote interview can be controlled as well: proper 166 gate attenuation can keep noise during pauses from being either loud (obtrusive-sounding) or too soft (peculiar-sounding) — or modulated.

The attack time of the 166 gate is short, so the complete transient at the beginning of a sound comes through. We've already touched on the differences between the Fast and Slow release rates, but never hesitate to experiment to get the best results for a particular situation.

ABOUT COMPRESSION

General

The purpose of a compressor is to reduce the dynamic range of a program and give you control over its dynamics. The 166's Ratio and Threshold controls can produce a wide variety of dynamic-range-reduction effects, from gentle taming of overall dynamics to limiting of peaks to squashing all dynamics.

For example, at low compression ratios, a very low Threshold setting can be used to reduce gently the overall dynamic range of a program. Higher ratios with low thresholds will provide leveling for instruments and vocals. High thresholds generally are used for limiting program levels overall. Ratios of 6:1 and higher effectively prevent outputs levels from much exceeding the threshold (assuming the Output Gain is set to 0).

Note that compression of the entire program (produced by low thresholds) tends to sound less natural at high ratios. Ratios of perhaps 4:1 and lower affect dynamics to a lesser degree, and are often used to tighten up a bass guitar, snare, and vocals. Moderate settings typically are used during mixdowns and for leveling the program in a broadcast.

The 166's OverEasy circuit prevents compression at high ratios from sounding too unnatural. This is because as the signal rises above threshold, the ratio changes gradually, from 1:1 (no compression) to that set by the front-panel knob. You can put this feature to especially good use in those situations when you need protection from excessive peak levels but desire gentle compression on most of the program. By setting the threshold at a moderate level and using a moderately high compression ratio (6:1, 10:1, etc.), you will provide limiting for signals well above threshold and gentle compression (much less than that set) for signals at or below threshold. See the OverEasy curve, p. 2, to understand how this works.

It's always useful to watch the gain-reduction LEDs to see the amount of processing taking place. With practice, a glance will confirm what your ears tell you -- that things are going okay, or that there's a little too much or too little. Your 166 can achieve desirable effects with proper settings derived from experience; when it's used too liberally, the unusual results may be suited to special effects only.

Here are some specific situations.

Variations in mike levels

As the distance between vocalist and microphone changes, signal levels change. Start at 2:1 with a low threshold setting to begin to smooth these out. With OverEasy, ratios up to 10:1 can be used here to good effect.

Variations in instrument levels

To achieve smooth electric-bass sound, start at about 4:1. Strings and horns likewise benefit, and strings will have their "sustain" increased. Note that large amounts of compression are usually more audible in a mixed stereo program; if the separate tracks were compressed before mixing to create the program, compression is much less noticeable.

Raising the signal out of a mix

Since reducing dynamic range can increase the average signal level and meter readings, a single track can be brought up out of a mix by boosting its level slightly and applying compression. It's also possible to separate certain vocals and instruments from an already mixed program by using the sidechain; see p. 10.

Preventing tape saturation

A high threshold (but below tape saturation) and high compression ratio will cause the compressor to reduce gain in a controlled manner before the tape overloads and distorts.

Speaker protection and acoustical distribution

Compression will keep excessive levels from damaging drivers in sound-reinforcement systems. Limiting also enhances intelligibility by letting low-level material be reproduced throughout the house at higher volumes; in a performance, this increases intimacy, as whispers become clear at virtually every seat. Our OverEasy characteristic permits high amounts of compression (e.g., 10:1) to be used without vocalists or musicians feeling choked back — and with high average levels maintained without speaker damage due to heat buildup in the drivers. As a rule, to give the best protection, your 166 should be as close as possible in the signal path to the power amp. For maximum SPLs, large sound-reinforcement systems frequently have a separate compressor on each output of the electronic crossover(s).

Where the 166 will be expected to allow virtually no level change unless an emergency (wildly excessive levels) arises, set the ratio to Infinity:1 and the Threshold to the highest level. OverEasy will never act in the fast, unpleasant manner of a typical "hard-knee" compressor, but it will give a measure of real protection. See the next section, too.

ABOUT LIMITING and SOFT CLIPPING

PeakStop allows you to control the maximum peak levels at the output of the 166 irrespective of any other control. As mentioned, it comes after the compression and other circuitry, including the output gain, so it lets an absolute limit be put on the peak-to-peak excursions of the output. PeakStop works instantaneously; you'll be able to apply moderate amounts of compression and still be independently protected from large transients, other short-term overloads, and broadcast overmodulation.

PeakStop consists of a sophisticated voltage-controlled clipper that produces a minimum of audible distortion. It rounds the corners of a peak rather than cutting it off sharply, as the term "clipping" implies. By making a signal's leading and trailing edges curves instead of sharp corners, it reduces the amount of higher-order, offensive-sounding harmonics that conventional clipping causes. The level at which PeakStop is activated is adjustable from 0 to +20 dBv. Note that small signal excursions above the set value of PeakStop are possible, to allow the rounding to take place. Therefore, for any applications where you must not exceed a given ceiling, set the PeakStop control 1-2 dB below it to be sure.

The PeakStop LED flashes whenever peaks attempt to exceed the PeakStop level and get reduced in amplitude. To disable the function altogether, simply set the control to +20 (which is the maximum output level of the 166 anyway).

In use, the PeakStop function can prevent an amplifier from being driven into hard clipping, where it may lose control over the speaker system. PeakStop is a smooth, well-controlled clipper whose behavior is sonically similar to the gentleness of OverEasy compression; its clipping is much preferable to a power amp's. As noted, control of speaker overexcursion, of broadcast overmodulation, and of harsh electronics clipping are all applications; with PeakStop and OverEasy, you have the best of both worlds: virtually inaudible rms compression and peak protection downstream, at the end.

Normally, the control is set to just under the peak clipping level of the equipment downstream. This way, clipping will be softer and controlled within the 166. The LED should light occasionally, on peaks only; if the LED lights often, of course, reduce the compression threshold and/or increase the ratio, to allow less peak signal level at the output.

SIDCHAIN APPLICATIONS

In all the following situations, it's the Sidechain Monitor function that will save you time and trouble, letting you adjust the preceding processor(s) and instantly confirm that things are (or aren't) going the way you want them to.

General hints

It's possible to separate certain vocals and instruments from a mix by making the compression frequency-sensitive. With an equalizer inserted into the Sidechain input (but not in the audio path), the EQ settings do not shift the timbre or equalize the audio signal; they merely alter the threshold of the compressor as a function of frequency.

In such an arrangement, frequencies that are boosted on the equalizer will be suppressed in the audio signal. The converse may also be used, of course: dipping the equalizer on a particular band prevents any sound with dominant energy in the affected register from compressing so much, because the 166 will detect less need for compression.

For example, if you want to suppress an overly loud bass drum, boost the equalizer's response below about 150 Hz. This will make the compressor reduce gain whenever energy in this region is detected. Furthermore, raising the threshold will cause this to happen only on very loud kicks. To put it generally, a relatively high threshold setting can prevent most sounds from being affected while solo and very loud sounds within that frequency range are held back. (Of course, when compression does occur, the entire program level is affected.) Depending again on the threshold setting, frequencies outside that range will not cause compression.

During the recording of cymbals and toms, a compressor with an EQ in the sidechain path can help prevent tape saturation. The equalizer can be adjusted for a boost peaking at about 5 kHz, causing the cymbal to be compressed on a very loud crash and stopping saturation of the tape at higher frequencies, where there's less headroom. However, gentle tapping with a stick or cymbal brushing will not be held back. And the tom-tom likewise, being a lower-frequency instrument and better-tolerated by the tape, has less need for compression. EQ in the sidechain circuit can make the compressor not as readily triggered by a loud tom-tom beat as by an equally loud cymbal crash.

De-essing

In the absence of a de-esser, small amounts of high-frequency (6-10 kHz) boost in the sidechain path frequently will help in the processing of vocals that may have been brightly equalized beforehand or that suffer from prominent sibilance ("ess" sounds).

Speaker protection

If a single compressor is to be used with a multi-way speaker system (after EQ, before the crossover), you are faced with the problem of keeping the entire system level down below the point of destruction of the most sensitive component. If midranges are frequently blown, for example, the whole system must be run at a lower SPL or additional mids must be added. By the insertion of an equalizer in the sidechain of the 166, it can be made sensitive to the frequencies the midranges handle, permitting the entire PA system to be run at higher average levels and dropped back only when damaging signals are present.

Broadcasting

A preemphasis filter network placed in the sidechain of a 166 processing preemph- sized audio permits higher average signal levels to be run within the headroom limits of the broadcast chain.

Filtering

Narrow-band ("notch") filtering for rumble, feedback, equipment noise (e.g., cameras) may be put in the sidechain to make the compressor less sensitive to such problems.

Anticipatory compression

If you feed the program directly into the sidechain and send the audio signal through a delay before the 166 audio input, the 166 can "anticipate" the need for gain change. With experimentation, the effect can become that of "zero" attack time at a given frequency. Additional delay beyond this "zero" time will then cause the compressor to finish reducing the gain before the leading edge of the loud passage even enters the 166, which will cause the program material preceding the loud passage to be suppressed. The 166 will then begin to recover from compression (it will release, in other words) before the loud passage has dropped back down toward the set threshold. This will cause the output level to surge as the note(s) should be decaying. Such a special effect sounds similar to the dynamic-envelope inversion you may be familiar with from reverse tape playback. See diagram.

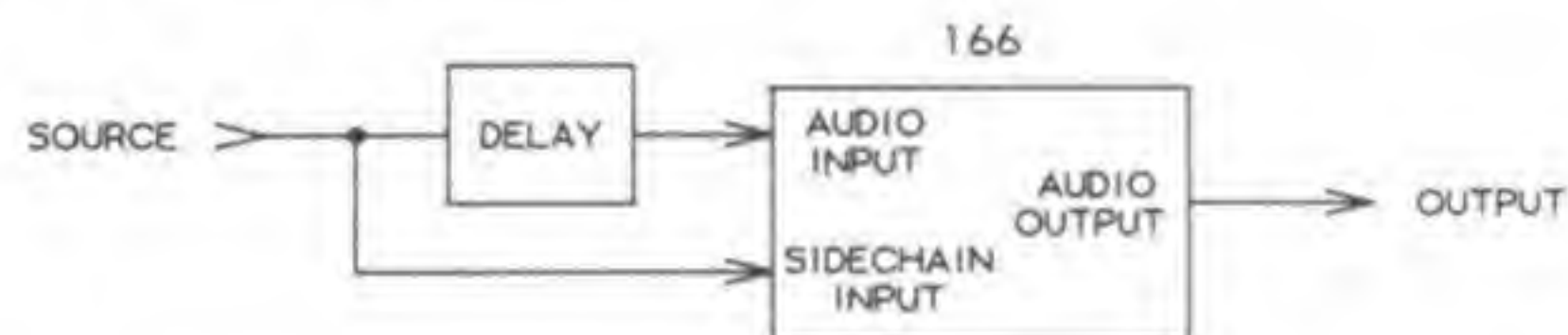

Keyed gating

Controlling the gating of one signal by another permits perfectly in-synch playing and overdubbing among individual instruments or precise sonic augmentation — "fattening" — of a weak solo. An example of the former would be synchronizing bass guitar and drum; an example of the latter would be using the drum signal to key an oscillator which is set at an appropriate frequency to "tune" and "punch up" the drum sound. See diagram. As noted, the Release Rate switch is helpful for determining the sound of the final product.

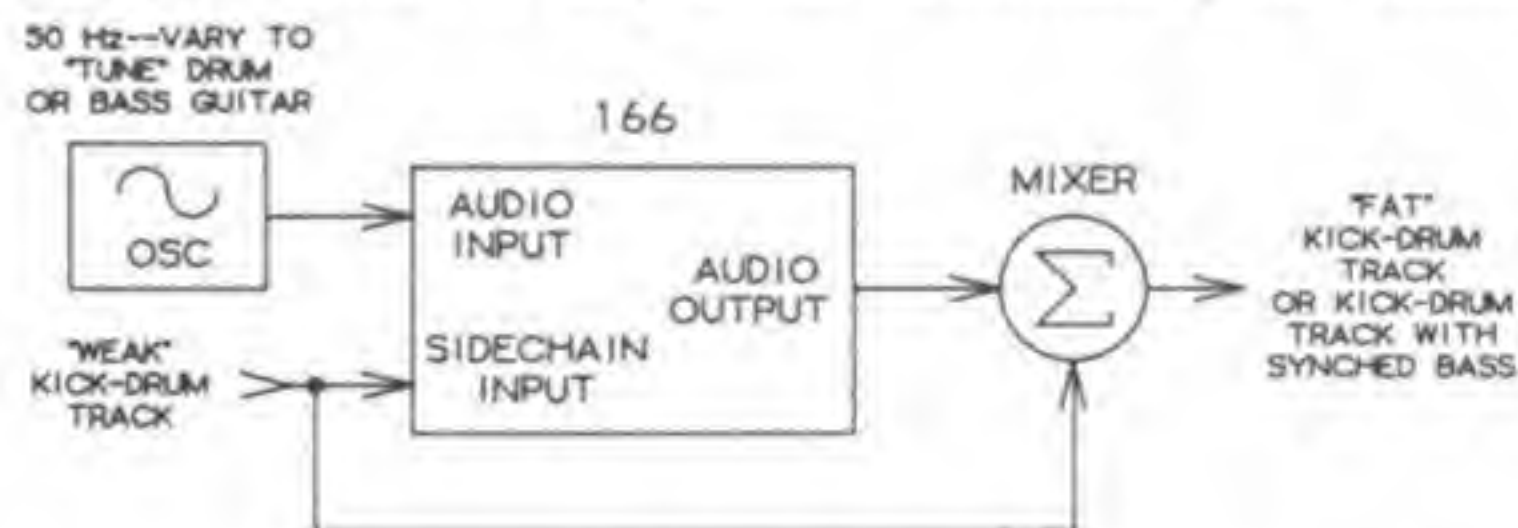

Selective gating

You can also do frequency-sensitive gating, letting you tune the response of the gating action. If you're gating a kick drum, for example, in a track with lots of leakage, you can tune in to the frequency of the kick with an EQ and the gate will respond only to the drum. Again, see diagram below.

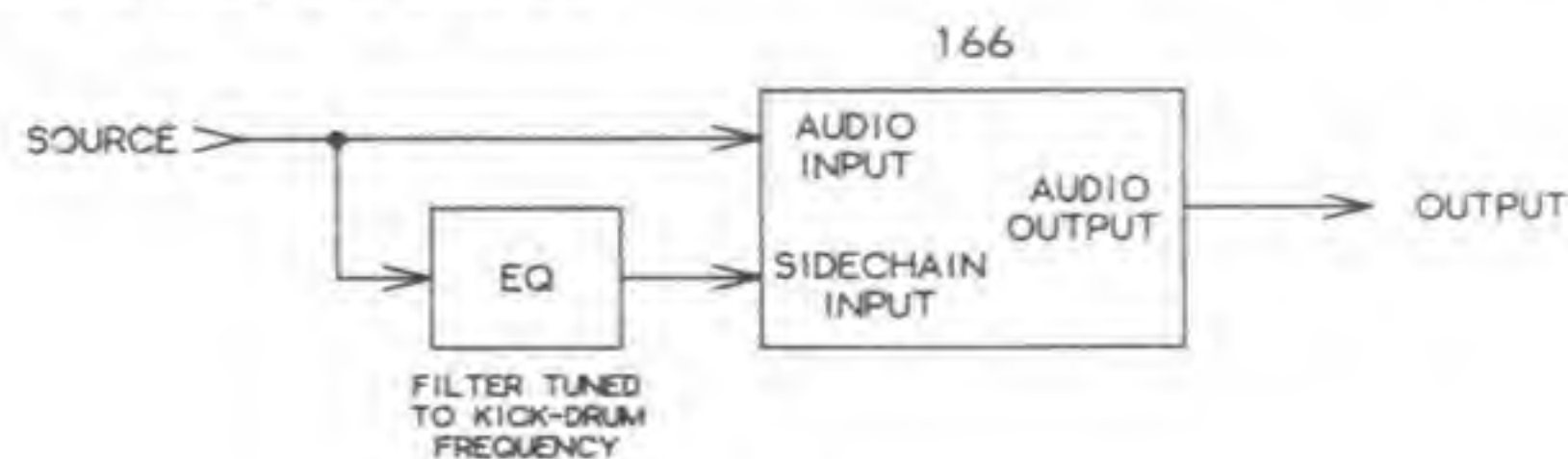

STEREO DYNAMICS PROCESSING

Stereo coupling is useful for all applications where two channels must be compressed and the left/right perspective must remain the same. Examples include the L and R overhead mikes on a drum kit or piano, a stereo submix of a vocal ensemble, the feed from an X-Y or other pair of mikes in a classical recording, a complete stereo mix, etc. All of our earlier comments about compression and gating apply here; the difference is that when the Stereo Couple switch is pushed, the gain changes in the two channels will be identical.

In this mode, the signals at each rms detector are combined (so the true rms sum can be sensed) and controlled. As mentioned, all functions of Channel 1 control both channels except for Sidechain and Bypass.

Use this mode whenever imaging must remain stable.

NOTES

BLOCK DIAGRAM

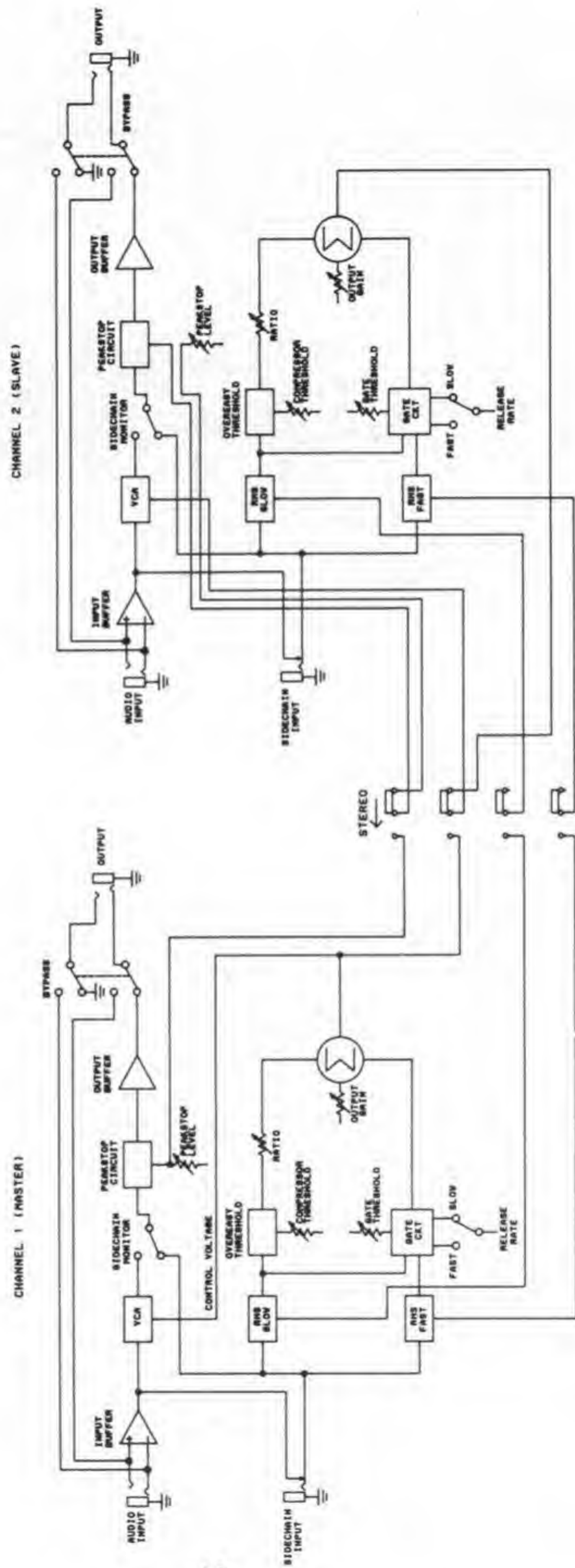

SCHEMATIC

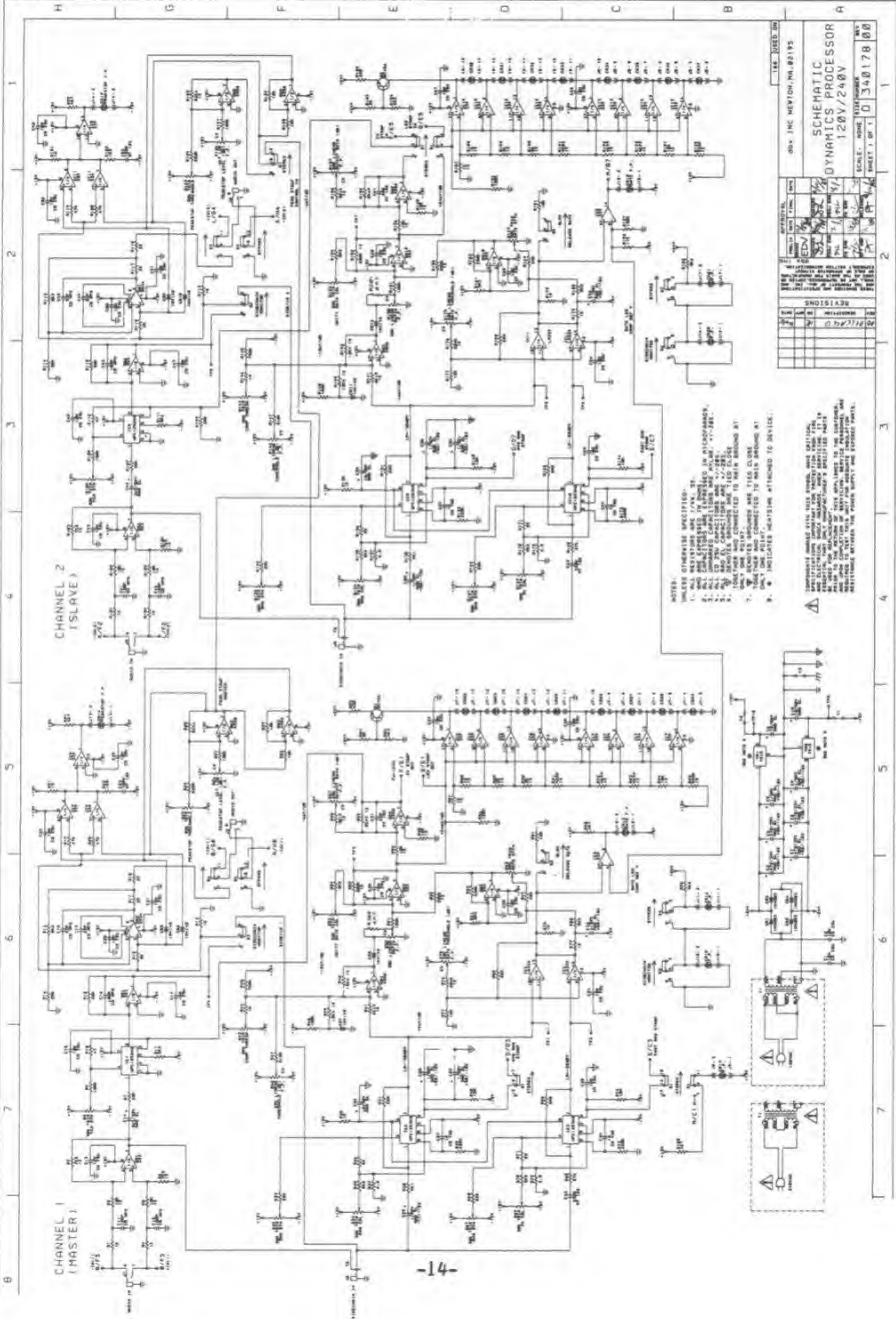

144 USED ON	
REV	DATE
1	10/1/68
2	10/1/68
3	10/1/68
4	10/1/68
5	10/1/68
6	10/1/68
7	10/1/68
8	10/1/68
9	10/1/68
10	10/1/68
11	10/1/68
12	10/1/68
13	10/1/68
14	10/1/68
15	10/1/68
16	10/1/68
17	10/1/68
18	10/1/68
19	10/1/68
20	10/1/68

SCHEMATIC
DYNAMICS PROCESSOR
120V/240V

SCALE: NONE
SHEET 1 OF 1
0340178 00

WARRANTY and FACTORY SERVICE

All dbx products are covered by a limited warranty (warranties for products purchased outside the USA are valid only in the country of purchase and the USA). For details, consult your warranty/registration card or your dealer/distributor.

dbx Customer Service will help you use your new product. For answers to questions and information beyond what's in this manual, write to:

dbx
1525 Alvarado Street
San Leandro, CA 94577
Att: Customer Service

You may call 415/351-3500 between 9:30 and 4:30 Pacific time (USA).
The Facsimile No. is 415/351-0500.

Should problems arise, consult your dealer or distributor. If it becomes necessary to have your equipment serviced at the factory, repack the unit, including a note with a description of the problem, your name, address, and phone, and the date of purchase, and send the unit freight prepaid to the above street address, marking it Attn: Repairs.