

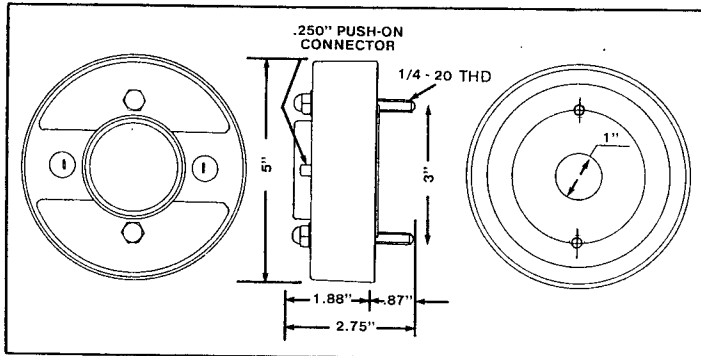

TECHNICAL DATA

RENKUS-HEINZ SSD 1800 COMPRESSION DRIVER



U.S. PAT. NO. 4336425



Description

The Renkus-Heinz Model SSD 1800 high frequency compression driver is capable of delivering very high level sound with superior clarity and reliability. Its patented design successfully eliminates notoriously weak points in conventional drivers, while improving bandwidth, transient response, and distortion. The unique mechanical arrangement also provides for unprecedented ease of service. Diaphragm assemblies can be quickly exchanged in the field by anyone following simple instructions supplied with each driver. Compact, lightweight and reliable, the SSD 1800 driver is an ideal component for any professional speaker system.

ELECTRICAL SPECIFICATIONS:		MECHANICAL SPECIFICATIONS	
¹ Max. Amplifier Power (Cont. Program)	130W w. x-over at 6 kHz	Magnetic Field	1.4 Tesla (14000 Gauss) ±5%
Min. Crossover Slope	100W 1.6kHz	Voice Coil DC Resistance	5 / 12 ohm ±10% (25°C)
12 dB/octave	50W 1 kHz	¹ Nominal AC Impedance	8 / 16 ohm ±15% (25°C)
	15W 0.5kHz	¹ Minimum AC Impedance	7 / 14 ohm ±15% (25°C)
Max. Power Handling	40W (RMS) above 2kHz	Polarity (Pos. Pressure Out)	Plus Voltage To Red Terminal
¹ Power Compression	< 1db, 1W to 40W, 2h	MECHANICAL SPECIFICATIONS	
² Temp. Rise	Coil 99°C (209°F)	Diaphragm Displacement Limit	.71 mm (.028")
	Magnet Ass'bly 4°C (39°F)	Throat Diameter	2.54 cm (1")
¹ Low Freq. Limit	.5 kHz	Overall Dimensions (Mounted)	12.7 cm (5") dia., 4.76 cm (1 7/8") deep
¹ Frequency Response	.5 kHz to 17 kHz	³ Mounting	Two 1/4"-20 THD Studs, 180° on 7.62 cm (3") diameter
Sensitivity (Horn Q = 10)	107 dB (1W, 1m, 2kHz)	Diaphragm Assembly	Model CD 1800-8 / 16 Self Aligning
(1" Plane Wave Tube)	115 dB (1mW, 2kHz)	Material	Special Heat Treated Alu. Alloy
¹ Efficiency (1kHz / 2kHz)	20% / 13.5%	Effective Diameter	4.57 cm (1.8")
¹ Harmonic Distortion	2nd ≤1.5% (4W), ≤3% (10W)	Compliance	High Temp, Silicon Elastomer
	3rd ≤0.3% (4W), (10W)	Terminations	Spade Lugs .63 cm (1/4")
¹ IM-Distortion	+2 ≤1.2% (4W)	Coil Material	Copper Clad, Alu. Ribbon Wire
	+3 ≤1.2% (4W)	Net/Shipping Weight	2Kg (4.4 lbs.) / 2.3Kg (5 lbs.)

- See applicable graphs on other side of page for detail.
- Temperature rise measured after 2 hour power test with 40W of pink noise (bandwidth limited from 2kHz to 20kHz, 2:1 peak to RMS voltage level). Ambient temperature 25°C (77°F).
- Mounting: Standard 1" throat Flange Mount  Screw Mount Adaptor (SSA 108) to 1 1/8" thread mount  Adaptor to 2" throat horn (SSA 210) 

Architects and Engineers Specifications

The high frequency compression driver shall be the Renkus-Heinz Model SSD 1800 or approved equal. When mounted to a suitable horn, the driver shall sustain a minimum of 40 watts RMS input power (pink noise band limited from 2kHz to 20kHz). Efficiency at 2kHz shall be no less than 13.5%. Pressure sensitivity measured with 1 mW RMS input at 2kHz shall be 115 dB SPL when coupled to a 2.54 cm (1") plain wave tube. When coupled to a suitable horn of Q=10, the pressure sensitivity shall be 107 dB SPL at 2kHz (1m, 1 watt input). Frequency response shall be smooth from 500 Hz to 17,000 Hz. Nominal impedance shall be 8 or 16 ohm. 2nd order harmonic distortion shall be less than 1.5% with 4 watt input, 3rd order harmonic distortion shall be less than 0.3% with 4 watt input. The coil-diaphragm assembly shall utilize

special heat treated aluminum, have elastomer suspension and shall be easily field replaceable without requiring special tools and without requiring alignment. The magnet shall be of ceramic material impervious to demagnetization, and shall be capable of sustaining a continuous magnetic field of 14,000 gauss. The driver's throat diameter shall be 2.54 cm (1"). Standard mounting with two 0.63 cm (1/4") studs on 7.63 cm (3") diameter 180° apart shall be provided. All required hardware shall be supplied. For increased reliability, the cast aluminum cover shall be integrally designed to act as a heatsink for the coil-diaphragm assembly. The diameter of the driver shall not exceed 12.75 cm (5"). The depth of the driver shall not exceed 4.76 cm (1 7/8"). The net weight of the driver shall not exceed 2 kg. (4.4 lbs.).

The following Bruel & Kjaer equipment was used: 2010 Analyzer, 1902 Distortion Control, 2305 Recorder, 4440 Gating System, 4133 or 4138 Microphone, 2615 Preamp. The Renkus-Heinz soundroom in conjunction with the above equipment is capable of true anechoic measurements down to 350 Hz. The graphs are reproductions of actual, unretouched measurements, except where indicated.

Measurements on 2.54 cm (1") Diameter Plane Wave Tube

Frequency Response 0.4 w, 4 w, 40 w.

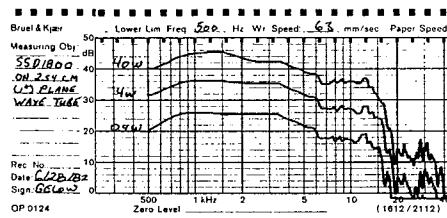

These curves allow accurate prediction of power output with respect to any input. The relatively uniform frequency response up to maximum power rating indicates excellent power linearity and dynamic range. The above plane wave tube curves are also representative of the power response of the driver when coupled to a constant directivity horn.

AC-Impedance of 8 and 16 ohm drivers

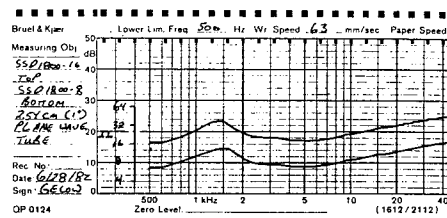

Impedance curves are smooth and show a low Q resonance at 1.4 kHz. Minimum ac-impedance occurs at 5 kHz.

Harmonic Distortion with 4 w input

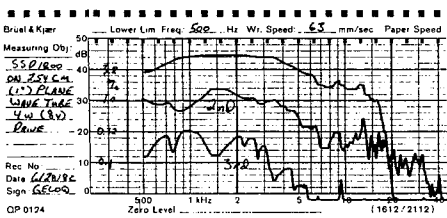

The above curves show 2nd and 3rd harmonic distortion as a function of frequency at two power levels. Note, that both components of harmonic distortion do not increase proportional with input power. This fact, just as the minimal change in frequency response with power is an indication of the drivers ability to reproduce accurately even with very high input power peaks.

Harmonic Distortion with 10 w input

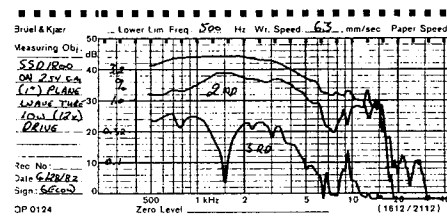

Intermodulation Distortion at 4 w Input

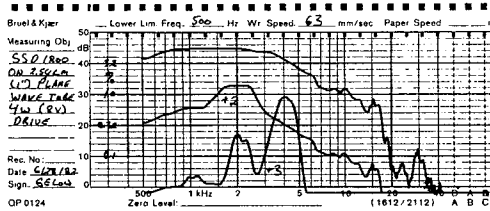

The curves show 2nd ($f_2 + f_1$) and 3rd ($f_2 + 2f_1$) components of a two tone test signal ($f_2 = f_1 + 2kHz$). This measurement gives an opportunity to describe complex, not harmonically related nonlinearities. Intermodulation distortion is musically much more offensive than harmonic distortion and must be small.

Efficiency versus Frequency

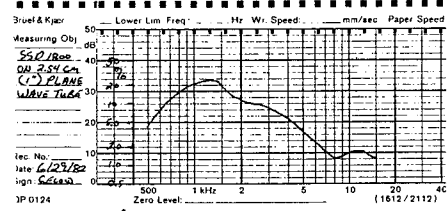

This calculated curve gives the efficiency of the driver under ideal conditions. Maximum efficiency is indicated at the 1.4 kHz resonance. The pronounced drop-off toward higher frequencies is common to all compression drivers.

Measurements on Renkus-Heinz Exponential Horns

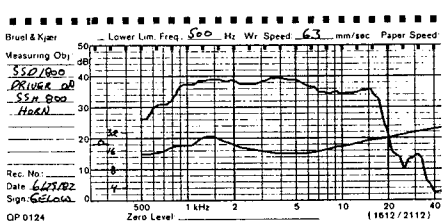
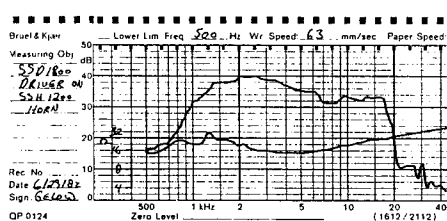

These measurements were made on axis at a distance of 4' from the horn mouth under anechoic conditions. No equalization was provided. The improvement in high frequency response compared to the plane wave tube measurements is due to the horn characteristics. The ac-impedances are measured with the drivers mounted to the horns. Comparisons with the plane wave tube impedance measurements above shows the effect of the horn loading near horn cut-off.

Maximum Ratings

Maximum Power Handling as a Function of Coil Temperature and Displacement Limits.

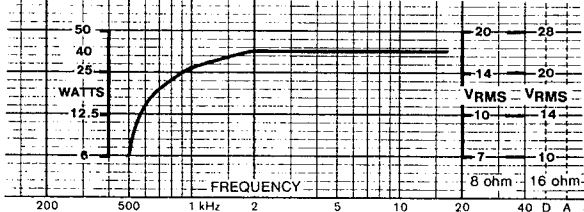

This calculated graph indicates maximum allowable steady state sine wave power input of 40 wRMS above 2 kHz. Maximum voltages for 8 ohm and 16 ohm coils are also indicated. (17 V and 25 V respectively). Below 2 kHz maximum input power is limited by the available diaphragm displacement as shown. This graph indicates clearly that lower crossover frequencies can be used only with reduced input power.

Maximum Rated Amplifier Power as Function of Crossover Frequency

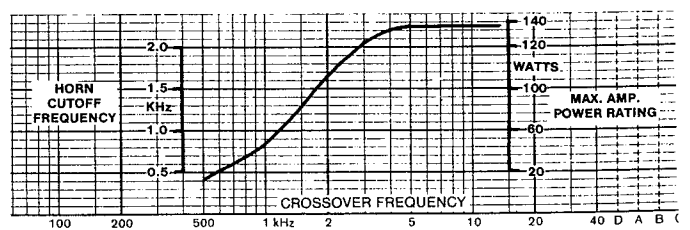

In addition to temperature and displacement limits, this graph takes into account the effects of high pass networks on continuous program power passed through to the driver. The left vertical scale represents horn cut-off frequency. Below this frequency, the horn will not load the diaphragm properly and will distort (see above impedance curves on horns). The horizontal frequency scale represents crossover frequencies. The right vertical scale represents rated amplifier power (RMS into 8 or 16 ohm). Note, that the scale is for amplifiers operated in the linear region with continuous program material (no clipping or heavy compression). The steady state sine wave limit is 40 watts or less as indicated in the graph to the left.

To find minimum crossover frequency from horn cut-off, go right to curve then down. To find maximum amplifier power rating, go up from selected crossover frequency, then right to amplifier scale.