Installation, Programming, and Operation KI-2010A

MRC7611 Media Retrieval Controller



Rauland-Borg Corporation

Issued: 06/25/98

Page 1 of 45

Copyright 1998 by Rauland-Borg Corporation, all rights reserved.

This document contains user's information on technology that is proprietary to Rauland-Borg Corporation. Permitted transmittal, receipt, or possession of this document does not express license or imply any rights to use, sell, design or manufacture this information. No reproduction, publication, or disclosure of this information, in whole or in part, shall be made without prior written authorization from an officer of Rauland-Borg Corporation.

Rauland-Borg Corporation
3450 West Oakton Street
Skokie, Illinois 60076-2958
(847) 679-0900
www.rauland.com

Table of Contents

GENERAL INFORMATION	5
DOCUMENT REVISION HISTORY	6
SOFTWARE AND CODE REVISION HISTORY	6
EQUIPMENT LIST	7
RELATED DOCUMENTS	8
DESIGN AND INSTALLATION	9
DESIGN GUIDELINES.....	9
<i>VCR Compatibility</i>	9
<i>Tip and Ring Interface</i>	10
<i>E&M Interface and Backwards Compatibility</i>	10
MR200 RACK INSTALLATION	11
TELECENTER® IV PLUS	12
LDP (Laser Disk), VCR, and/or CDI Installation	12
TELECENTER® V AND 21: E&M INTERFACE.....	13
LDP (Laser Disk), VCR, and/or CDI Installation	13
TELECENTER® V AND 21: TIP/RING INTERFACE	14
LDP (Laser Disk), VCR, and/or CDI Installation	14
TROUBLESHOOTING.....	15
<i>E&M Interface</i>	15
<i>Tip and Ring Interface</i>	15
MAINTENANCE.....	16
PROGRAMMING	17
GENERAL INFORMATION.....	17
<i>Overview of the TMRC Program</i>	17
<i>File Lists</i>	18
<i>PC Requirements</i>	18
SOFTWARE INSTALLATION.....	18
<i>Installing TMRC for the First Time</i>	18
<i>Uninstalling TMRC</i>	19
<i>Upgrading an Existing Version</i>	19
RUNNING THE TMRC PROGRAM.....	20
<i>Launching the TMRC Application</i>	20
<i>Main Window Description</i>	20
<i>Working in the Stand-Alone Mode</i>	20
<i>Working in the Remote Device Mode</i>	22
<i>Downloading New Firmware to the MRC7611</i>	23
<i>MRC7611 RAM & EPROM Modes</i>	24
MRC7611 PROGRAMMING	25
<i>Version Window</i>	25
<i>Configuration Window</i>	25
Programming a Button: Step by Step	29
Editing Key Text: Step by Step	30
<i>Terminal Emulation Window</i>	32
<i>Using Other Terminal Emulation Programs</i>	33
<i>Monitor Commands</i>	33
TELECENTER® SYSTEM PROGRAMMING.....	36
<i>Telecenter with E & M Interface</i>	36
<i>Telecenter® with Tip/Ring Interface</i>	36
OPERATIONS.....	37

ESTABLISHING/RELINQUISHING PLAYER CONTROL.....	37
<i>Paging the Media Center Operator</i>	38
OPERATING A PLAYER.....	38
<i>VCR (Video Cassette Recorder) Operation</i>	38
<i>Laser-Disk Player Operation</i>	38
Selecting Audio Channels	40
CDI OPERATIONS.....	40
Cursor Operation	41
MEDIA-CENTER TELEPHONE	42
#24 MEDIA-CENTER CONTROL FUNCTION.....	42
<i>To Pre-assign a Player</i>	42
<i>To Terminate a Connection</i>	42
<i>To View the Next Player Extension</i>	43
<i>Using a StarPlus Phone in the Media-Center</i>	43
APPENDIX A	44
ILLUSTRATIONS.....	44
<i>Telecenter® Media-Retrieval Classroom Operating Guide</i>	44

1

General Information

The MRC7611 module is an interface that enables a user to operate a video cassette recorder (VCR), a Laser Disk Video Player, or a Philips CDI player from a remote location via a Telecenter® V, a Telecenter® System 21, or a Telecenter® IV Plus. With this system, all of an institution's video sources can be operated and kept at one secure location. An authorized user simply accesses the video source, selects the appropriate television channel, and then controls the player. The controller may be a simple telephone, a hand-held remote control (MRH7700), or a bar code scanner (RANBARC).

This unit is a direct functional replacement for the MR100. The connector wiring is identical to that of the MR100. It is possible to have MR100 units and MRC7611 units operating side by side in the same system (if they are all E&M interfaced).

The unit is designed to work with most commonly available VCRs. It will support several versions of Pioneer Laser Disk Video Players, including the LD-V2200 and LD-V4400. It will control all Phillips CDI players.

The MRC7611 may connect to the Telecenter® using either E&M (like the MR100) or Tip/Ring connections. The Tip/Ring interface accepts either 12 or 48 volt telephone line voltage. The Tip/Ring interface connects to the SLC ports on the Telecenter® System 21 (either SLC3 or SLC4). **The Tip/Ring interface is not available for use with the Telecenter® IV Plus.**

The memory on the MRC7611 is non-volatile. It has a combination of battery backed RAM and EEPROM storage.

MRC7600 and MRC7611: Important Differences

While the MRC7611 and the MRC7600 are physically identical, both the hardware and software are quite different. The field wiring, however, is identical.

The MRC7611 features field-downloadable software. The program is stored in battery-backed static RAM. The software is downloaded via the TMRC.

Three pieces of software are required when using the MRC7611: a) the downloadable executable code, b) the boot EPROM (U8), and c) the TMRC Set-up program.



Note: the executable code is pre-loaded into static RAM; therefore, upon receipt of the unit, you need only download new software in the case of future upgrades. Upgrade software is available on disk (part MRC7636) or via Rauland's Website (<http://www.rauland.com>).

Note: The TMRC versions 3.2 and higher support both the MRC7600 and the MRC7611.

Note: Configuration files created using TMRC version 2.x can not be read by TMRC version 3.x, and vice-versa.

Document Revision History



This is the initial release of this manual. It is based loosely on information originally found in KI-1981/81A, the *MRC7600 Media Retrieval Controller Installation, Programming, and Operation* manuals. Should we release further editions of this manual, changes will be highlighted here.

Software and Code Revision History



Version 3.2 is the initial release of the downloadable software and boot EPROM. Version 3.2 of the TMRC supports both the MRC7600 and the MRC7611.

Equipment List

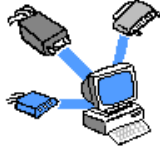

An MRC7611 includes one of each of the following items:

- ✓ MRC7611 PC board assembly
- ✓ IR emitter and cable assembly, 10 Ft., Part No. VP0400
- ✓ Female Connector to attach the field wire leads, Part No. SF0475-08
- ✓ Foam Pad Overlay (for IR emitter), Part No. QP0383
- ✓ Adhesive-backed Foam Cover (for IR Emitter), Part No. QP0384
- ✓ MRC7611 Installation, operation, and programming manual (KI-1981)

Associated Equipment

The **MR200** is a rack-mount chassis that holds up to 6-MRC7611 modules. The chassis installs in a standard 19-inch rack: it takes 3 ½ inches of vertical space and about ten inches of depth, including an inch for the wiring.

The **MRC7636** is a diskette containing downloadable execution software for the MRC7611.

The **MRC7695** is a 20 foot serial data cable that connects the DB9 connector on the MRC7611 to the DB15 connector on the Laser Disk Video Player.

The **MRH7700** is a hand-held remote control that can control both the local TV set and the remote media device (i.e. VCR, Laser Disk Video Player, or CDI player).

The **MRR7800** is an infra-red receiver unit that communicates with the MRC7611 over the telephone line.

The **PS12** regulated 12 VDC, 1 Amp power supply will accommodate up to 10 MRC7611 modules.

The **RANBARC** is a bar code scanner with an integral infra-red transmitter, which can control a remote Laser Disk Video Player.

The **RANLASER** is a Laser Disk Video Player.

The **RANVCR** is a general purpose VCR.

The **TCEM4157** is the E&M adapter module for the Telecenter® V.

The **VC7330** is the E&M adapter module for the Telecenter® IV.

The **TMRC** Graphical User Interface is the installation program for the MRC7611. It may be either purchased (on a floppy disk media) or downloaded from the Rauland-Borg electronic bulletin board system.

Related Documents



The following Telecenter® manuals contain important information for the Media Retrieval Controller:

- ✓ KI-1655 *CPU3 and Media Retrieval Functions*
- ✓ KI-1584 *Telecenter® IV Programming*
- ✓ KI-1692 *Telecenter® V Programming*
- ✓ KI-1768 *Telecenter® System 21 Programming*
- ✓ KI-1845 *MRR7800 Remote Receiver Module*
- ✓ KI-1844 *MRH7700 IR Remote Control*

2

Design and Installation

Design Guidelines

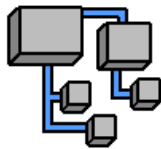

This section highlights the differences between the MR100 and the MRC7611.

- ✓ General Considerations
- ✓ The MRC7611 does not include a Laser Disk serial cable (MRC7695) or an E&M line module. These items must be purchased as necessary (see ‘Associated Equipment’ section).
- ✓ Sometimes the “TMRC attempting to connect....” message box lost text when switched from an invalid Comm port to a valid Comm port. When the disconnect digit (“0”) is pressed in laser disk mode, the red status LED will not turn off immediately. It will turn off after a programmable delay (see Release Timer). Because the Release key (0) is also used for the Chapter command, this timer determines the amount of time the user has to enter the first chapter digit before the MRC7611 disconnects.
- ✓ MRC7611 uses a special non-volatile memory where the VCR device code can only be changed a maximum of 25 times. Thereafter, operation of the unit may become erratic. The LIST command (available from the Terminal window) shows the total number of VCR code “reprogrammings” that have occurred over the life of the unit. The CDI device selection is also included in this count.
- ✓ The Laser Disk serial cable is 20 feet long, and should not be extended. The IR emitter cable is 10 feet long and may be extended to 100 feet (with 22 AWG wire).
- ✓ Media Lines must be contiguous (as with the MR100).

VCR Compatibility

The MRC7600 does not support the Play-Scanning feature (Forward and/or Reverse) on some VCR models. (Standard FAST FORWARD and REWIND

features is not affected.) Before purchasing a VCR, observe the following test procedure (FORWARD and REVERSE scan modes):

1. Press the PLAY button on the unit in question (not on the handheld remote control device).
2. Press the FAST FORWARD button briefly (handheld remote device). **Do not keep the button pressed down.**
 - *The VCR should engage in a continuous forward scan.*
 - *If the scan stops when you take your finger off the button, the unit is not compatible.*
 - Stop the VCR.
3. Repeat steps 1 and 2, pressing the REVERSE button instead.
 - *The VCR should engage in a continuous reverse scan.*
 - *If the scan stops when you take your finger off the button, the unit is **not** compatible.*

The RANVCR (Panasonic AG-1310) is known to support the MRC7600 feature.

Tip and Ring Interface

- ✓ You can mix E&M and Tip/Ring controllers in a Telecenter® V system, but not in a Telecenter® System 21.
- ✓ On Telecenter® System 21 systems with Tip/Ring interface, you must connect the MRC7611 to SLC ports (either SLC3 or SLC4).
- ✓ The Tip/Ring interface is not available for the Telecenter® IV Plus.
- ✓ For the Tip/Ring interface, the initialization and ending tones are provided internally on the MRC7611. These tones are configurable using the TMRC program. **Do not program initialization or ending tones on the Telecenter® head-end.**
- ✓ When using the Tip/Ring interface, you must obtain new Telecenter® firmware. Use Telecenter® V version 500.0 or higher and TD5 version 17.0 or higher. Use Telecenter® System 21 version 3.0 or higher and TD21 version 3.0 or higher.
- ✓ The Tip/Ring interface will work in a crude fashion with non-Telecenter® telephone platforms; however, you will lose the following features: pre-assignment, privacy, single digit connect, and #24 (Media Center) functions.

E&M Interface and Backwards Compatibility

- ✓ The MRC7611 does not provide initialization or ending tones internally for the E&M interface. The Telecenter® head-end must provide these tones.
- ✓ There has been a significant change in the ending tone function for Laser Disk Video Players. On the MR100, the Release digit (“0”) had the side effect of leaving the MR100 in the Numeric mode. It was therefore

necessary to have an asterisk (“*”) initialization tone to bring the unit back into the Command mode.

- ✓ This is not true for the MRC7611. When the MRC7611 receives the Release digit, it stays in the Command mode. In systems that have Laser Disks connected to both MR100 and MRC7611 units, program the “0*” initialization tone for the MR100, but don’t program any initialization tones for the MRC7611. (The MRC7611 interprets the “*” digit as the “Audio Channel 2” command.)
- ✓ The MRC7611 emulates the current MR100 version 8.0 functionality. Specifically, when controlling a VCR, digit 5 is STOP, and digit 0 is release. With earlier versions, digit 5 both STOPS and RELEASEs the VCR, and digit 0 is RELEASE only. If you are mixing MRC7611 and MR100 units in the same site, and the MR100 firmware is version 6.0 or earlier, be sure the school staff knows that they MUST hit 0 to release.

MR200 Rack Installation

Step 1: If the rack holes are not tapped, clip the four supplied Tinnerman nuts, flat side to the front, over the appropriate holes.

Step 2: Install the MR200 chassis in the rack with the supplied mounting hardware: the fiber washers go between the flat washers and the front of the chassis, to protect the chassis’ finish.

Step 3: Remove the “U” shaped locking bar and its two thread-forming screws from the rear of the chassis and set them aside.

Telecenter® IV Plus

Please observe the following procedure during installation (see drawing 1, immediately below; or see Appendix B for a large-format copy):

LDP (Laser Disk), VCR, and/or CDI Installation

1. Replace the standard “U1” hybrid with the VC7330 E&M hybrid for each MRC’s LLM line.
2. Install the MR200 chassis in the video rack within the 20 foot (LDP) or 10 foot (VCR/CDI) available cable range. A regulated 12 VDC, 1.0 Amp power supply (e.g. PS12) is required to power 10 MRCs.
3. Set slide switch “S1” to E&M position. (DIP switch “S4” is not used with E&M applications.)
4. Insert the MRC7611 into its assigned chassis slot.
5. Connect power, Tip, Ring, and a ground wire from MRC7611 common to a CIO or SCC “Z” terminal. **Correct Tip/Ring polarity and a common ground are essential for proper operation.**
6. Connect a straight DB9 cable (Male-Female) from the MRC7611 to your PC, and program the unit per instructions in this manual (see section 3, below).
7. Select from either or both of the next two steps (7a or 7b), depending upon individual system set up; then continue with step 8 for all device configuration.

7a. (for LDPs only) Connect the MRC7695 LDP cable from MRC7611 (DB9) to the LDP (DB15); set the DIP switches on the back of the LDP to provide 4800 baud (see drawing 1, immediately below).

7b. (for VCRs/CDIs only) Plug the IR emitter cable into the jack on the MRC7611. Attach the IR emitter head to the VCR face directly over the sensor. Apply the foam pad overlay and adhesive backed foam cover (both provided).

8. Program the CPU3 (TC4411) as required by the Telecenter® IV Plus manual (KI-1655).
 - On power up, the front panel LED will flash the version number, pause, and then display the sub-version number.

CAUTION:
DO NOT CONNECT TO STANDARD
TELEPHONE PORT - MUST USE E & M.

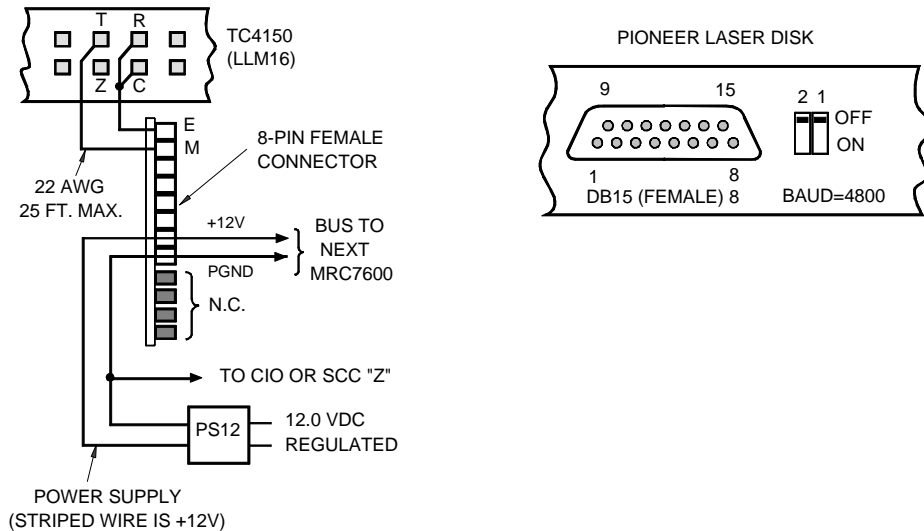

DRAWING 1
IL0545

Telecenter® V and 21: E&M Interface

Please observe the following procedure during installation (see drawing 2, immediately below; or see Appendix B for a large-format copy):

LDP (Laser Disk), VCR, and/or CDI Installation

1. Replace U1 line module with TCEM4157 E&M adapter module (TCV LLM only) or strap the SAC (TC2195) and MSM (TC2150) for E&M (TC21 only).
2. Install the MR200 chassis in the video rack within the 20 foot (LDP) or 10 foot (VCR/CDI) available cable range. A regulated 12 VDC, 1.0 Amp power supply (e.g. PS12) is required to power 10 MRCs.
3. Set slide switch "S1" to E&M position. (DIP switch "S4" does not apply to E&M applications.)
4. Insert the MRC7611 into its assigned chassis slot.
5. Connect power, Tip, Ring, and a ground wire from the MRC7611 common to a CIO or SCC "Z" terminal. Correct Tip/Ring polarity and a common ground are essential for proper operation.
6. Connect a straight DB9 cable (Male-Female) from the MRC7611 to your PC, and program the unit per instructions in this manual (see section 3, below).
7. Select from either or both of the next two steps (7a or 7b), depending upon individual system set up; then continue with step 8 for all device configuration.

7a. (for LDPs only) Connect the MRC7695 LDP cable from MRC7611 (DB9) to the LDP (DB15); set the DIP switches on the back of the LDP to provide 4800 baud (see drawing 3, immediately below).

7b. (for VCRs/CDIs only) Plug the IR emitter cable into the jack on the MRC7611. Attach the IR emitter head to the VCR face directly over the sensor. Apply the foam pad overlay and adhesive backed foam cover (both provided).

8. Program the Telecenter® system as required by the TCV or TC21 programming manual.
 - On power up, the front panel LED will flash the version number, pause, and then display the sub-version number.

CAUTION:
DO NOT CONNECT TO STANDARD
TELEPHONE PORT - MUST USE E & M.

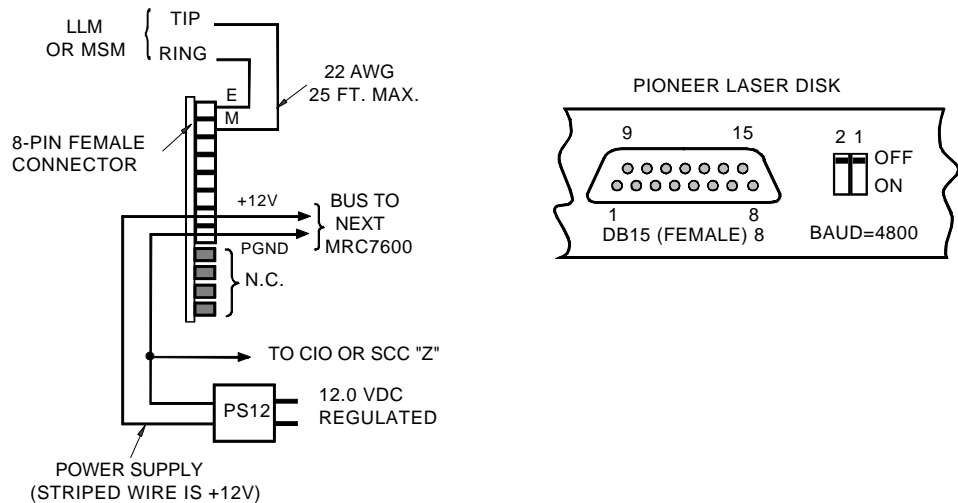

DRAWING 2
IL0546

Telecenter® V and 21: Tip/Ring Interface

Please observe the following procedure during installation (see drawing 3, immediately below; or see Appendix B for a large-format copy):

LDP (Laser Disk), VCR, and/or CDI Installation

1. Use a standard 12 volt LLM port (TCV only) or a standard SLC3 or SLC4 port (TC21 only).
2. Install the MR200 chassis in the video rack within the 20 foot (LDP) or 10 foot (VCR/CDI) available cable range. A regulated 12 VDC, 1.0 Amp power supply (e.g. PS12) is required to power 10 MRCs.
3. Set slide switch “S1” to the T/R position.
4. Set DIP Switch “S4” as follows:
 - Position 1 selects line voltage: up for 48V, down for 12V.
 - Position 2 selects ring voltage: up for TCV (90 VAC) ring, down for TC21 (-12 VDC) ring.
 - Positions 3-6 are unused.
5. Insert the MRC7611 into its assigned chassis slot. Connect power, Tip and Ring. **Correct Tip/Ring polarity are essential for TC21 only.**
6. Connect a straight DB9 cable (Male-Female) from the MRC7611 to your PC, and program the unit per instructions in this manual (see section 3, below).
7. Select from either or both of the next two steps (7a or 7b), depending upon individual system set up; then continue with step 8 for all device configuration.

7a. (for LDPs only) Connect the MRC7695 LDP cable from MRC7611 (DB9) to the LDP (DB15); set the DIP switches on the back of the LDP to provide 4800 baud (see drawing 3, immediately below).

7b. (for VCRs/CDIs only) Plug the IR emitter cable into the jack on the MRC7611. Attach the IR emitter head to the VCR face directly over the sensor. Apply the foam pad overlay and adhesive backed foam cover (both provided).

8. Program the Telecenter® system as required by the TCV or TC21 programming manual.
 - On power up, the front panel LED will flash the version number, pause, and then the sub-version number.

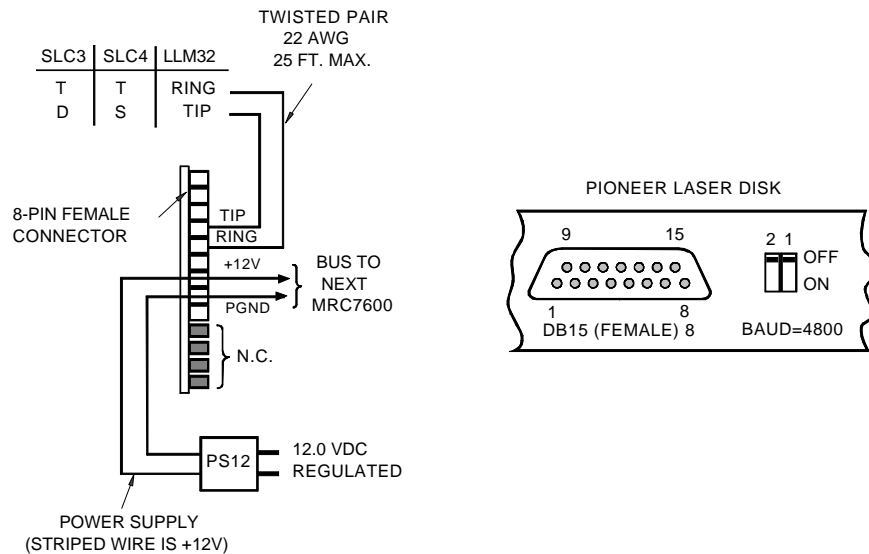

Troubleshooting

If troubleshooting is necessary, keep the following in mind:



Important:

First review the Design Guidelines at the beginning of this section before seeking any remedies or taking any further action.

E&M Interface

Terminals E and M carry signals for both audio and DC logic. The E terminal connects to Telecenter® Ring; while M connects to Telecenter® Tip. The M signal is controlled by the MRC7611. The E signal is controlled by the Telecenter®, but is not used for signaling (.i.e. it is always +12 VDC). By connecting a DC voltmeter between either terminal and ground, you can gain useful troubleshooting information.

The following table gives the nominal levels for the different Telecenter® systems (actual readings may vary by +/- 0.3 VDC). If you do not see these levels, check your programming, wiring, verify that the E&M line module is installed in the LLM and/or the MSM is strapped properly for E&M.

Signal	Systems	VDC	Condition
M to Z	ALL	+12	Idle
	TC4+	+5.7	Active - (Red LED On)
	TC21	+1.7	Active - (Red LED On)
	TC5	+1.5	Active - (Red LED On)
E to Z	All	+12	Always

Tip and Ring Interface

The voltage between the MRC7611 Tip and Ring terminals should be as follows. (These values are true for all Telecenter® systems):

Signal	Systems	VDC	Condition
Tip to Ring	All	+11.5 to +12	Idle
Tip to Ring	All	+5.5 to +7.5	Active (Red LED On)

Maintenance



Replace the battery every 5 years. Use any 3V, 25mm, 250 mAHr lithium coin cell.



Important:

You must download new software to the MRC7611 after replacing the battery.

3

Programming

General Information

The TMRC configuration and diagnostic program allows the installer to make programming changes and troubleshoot the system quickly and efficiently. The user interface is very user-friendly, and most operations can be performed by pointing and clicking with the mouse. The user interface adheres to commonly accepted standards of user interface development.

**Important:**

The TMRC version 3.2 (and higher) support both the MRC7611 and MRC7600.

Overview of the TMRC Program

The TMRC graphical user interface runs on Microsoft Window[®] 95 machines as a 16-bit application. The user interface is structured as a multi-dialog application, and each dialog box has its own context sensitive help. The help engine supports additional tools for searching and printing.

Further, the TMRC program supports both “Standalone” and “Remote Device” modes. Additionally, the configuration can be previewed and printed on a printer connected to a personal computer. A terminal window is provided for diagnostic purposes. The data in the terminal window can be saved to a file for review and future reference.

The TMRC program enables a user to:

- ✓ Download MRC7611 Firmware
- ✓ Create and edit configuration files and then download these files to MRC7611
- ✓ Troubleshoot the system via its terminal window
- ✓ Retrieve system diagnostics and save them to a file
- ✓ Preview and print system configuration

The TMRC configuration program communicates with the MRC7611 via a serial port on the PC. It is necessary that there be one free serial port on the PC to connect with the MRC7611. A straight through RS-232 cable is required for communication between the PC and the MRC7611.

File Lists

The TMRC package contains a single diskette with two files, **install.txt** and **tmrcXXX.exe** (where XXX indicates the version). The two files are located in the root directory of the floppy diskette. The TMRC program is also available for download on the World Wide Web at <http://www.rauland.com>.

PC Requirements

The TMRC software has been developed on a Windows® platform and will run on machines running Microsoft Windows® 95 Operating System or higher. Other system requirements are:

- ✓ 386-25 MHz. or faster desktop or laptop computer
- ✓ 16-Megabyte or greater random access memory (RAM)
- ✓ 5-Megabytes minimum free hard drive space
- ✓ 3-1/2" diskette drive or Internet connectivity to Rauland-Borg Corporation
- ✓ Standard COM port

Using PCs with increased processor speed, greater amounts of RAM, and more free storage space will yield enhanced performance.

Software Installation

Installing TMRC for the First Time

As discussed, the shipped diskettes contain two files: **install.txt**, a text file featuring basic installation instructions and **tmrcXXX.exe** (where XXX is the version), a self extracting executable file.

To install **tmrcXXX.exe** and associated files on your hard drive:

1. Copy **tmrcXXX.exe** to a temporary directory on your hard drive using “File Manager” or “Explorer.” (If no such directory exists, create one.)
2. Once **tmrcXXX.exe** exists, launch it by double clicking the file name or using the “File/Run” command.
 - *All the files needed for installation will be uncompressed and installed under the current directory.*
3. Launch **setup.exe** by double clicking the file name or using the “File/Run” command.

- *The installation wizard will guide you through the remainder of the installation process; if necessary, the wizard will create a target directory.*



Important:

Choose a directory other than the one containing the setup program.

- *The Wizard also creates and installs the group/folder and all necessary icons, including “Readme.txt” and the Uninstall program.*
- *A status indicator tracks installation progress.*
- *Once all files have been successfully copied to the target directory, you may view the installation text file.*

Uninstalling TMRC

The uninstall utility removes all icons and files created by the installation Wizard and reverses any changes made to system files. **It does not destroy the target directory or remove the original, compressed file: tmrcXXX.exe.** Should you wish to upgrade to a later software version (see immediately below), you should manually delete the directory and the compressed file.

To uninstall tmrcXXX.exe and associated files on your hard drive:

1. Locate Uninstall icon in the TMRC group or folder.
2. Double click on the uninstall icon.
 - *Confirm your action.*
 - *All icons and files (except the original compressed file: “tmrcXXX.exe”) will be removed from your hard drive.*
 - *All changes made to system files will be reversed.*



Important Reminder:

The uninstall utility removes all icons and files created by the installation Wizard and reverses any changes made to system files. **It does not destroy the target directory or remove the original, compressed file: tmrcXXX.exe.**

Upgrading an Existing Version

If, at a later date, you wish to upgrade from an earlier software version, you must first uninstall the original version.

To upgrade a software version:

1. Locate Uninstall icon in the TMRC group or folder.
2. Double click on the uninstall icon and complete the uninstall process (see immediately above).

3. Once the earlier version has been successfully uninstalled, follow the “First Time Installation” instructions above to install the later version.

Running the TMRC Program

Launching the TMRC Application

As with other Windows® 3.X applications, you may launch **TMRC** by double-clicking its program icon. On the other hand, Windows® 95 users may launch **TMRC** by double-clicking its program icon or finding and selecting it via the Start/Programs selection (Start/Programs/TMRC).

Main Window Description

The main window offers you the choice of either working in “Stand-alone” or “Remote-device” mode. “Stand-alone” is used when no direct connection to an active MRC7611 is available, while “Remote-device” mode is used **only when your PC is connected to an active MRC7611**. In either mode, the user can choose to open an existing (user-created) file, work with a default file, preview and print the default configuration, and/or view version information.



Important:

If you select “Stand-Alone” mode, the system will ask for the MRC type: MRC7611 or MRC 7600. If you select “Remote-Device” mode, the system will automatically detect the MRC type.

Working in the Stand-Alone Mode

In the stand-alone mode, the user has access to the Version window and the Configuration window. The “version” window will display the TMRC Graphical User Interface version number but will not report the MRC7611 version. The “configuration” window, however, will let the user establish and save a configuration to disk or print it for later use. In either window, user assistance is available via the F1 hot key:

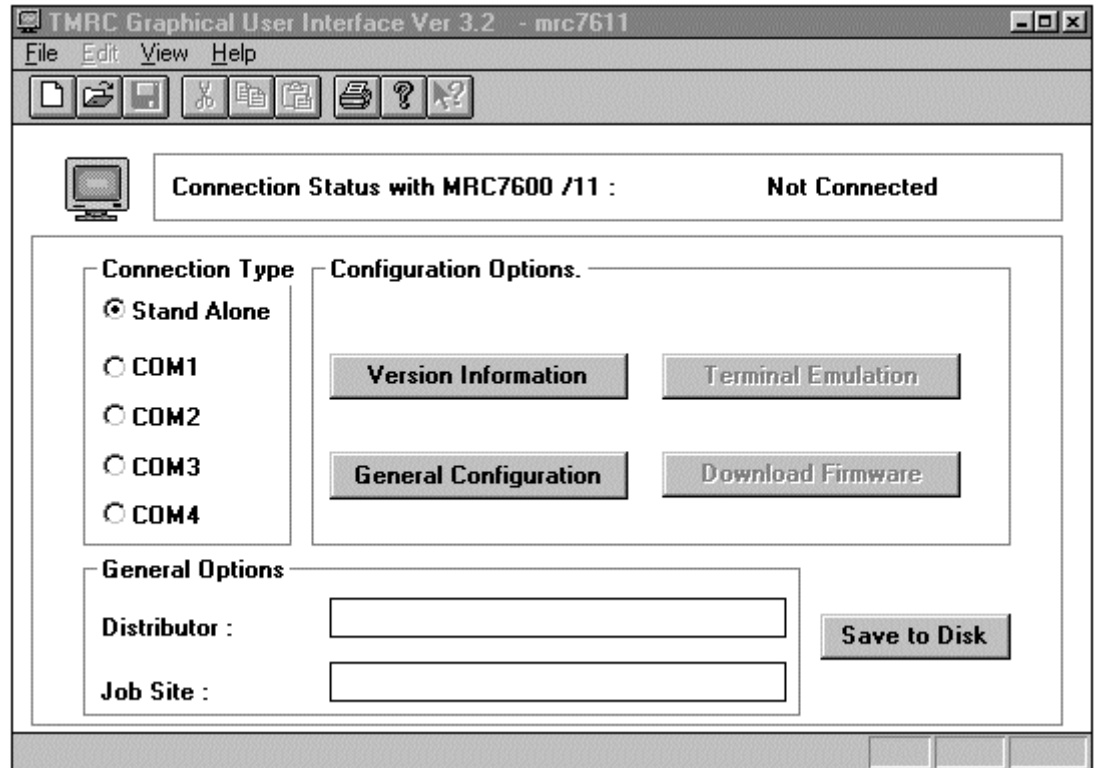

Main Screen: Stand-alone Mode

Keep the following in mind when working in the stand-alone mode:

- ✓ Check the stand-alone button.
 - This enables the Version Information and the General Configuration buttons and also opens a new file that contains the default settings.
- ✓ To open an existing configuration file, select File from the File menu options, click on the File Open icon on the tool bar, or use the hot key combination of <CTRL><O>. (Configuration files created using TMRC version 2.x can not be read by TMRC version 3.x, and vice-versa).
 - A window box will pop up, from which the user will have the option of selecting the file from the default directory or from a different directory.
- ✓ To open the “version” window, left click on the “version” button or tab to it and press Enter after it has been highlighted.
- ✓ To open the “configuration” window, left click on the “configuration” button or tab to it and press Enter after it has been highlighted.
 - After modifying the default or existing configuration, left click on the Save to Disk button.
 - If the file is a new, a file selection dialog box will pop-up, forcing you to select a new file. If you do not enter a new name, any changes will be saved to the open file.

Working in the Remote Device Mode

In the Remote-device mode, the user has access not only to the “version” and “configuration” windows but to the “terminal” and “firmware download” windows as well. As discussed, the “version” window allows you to view both the MRC7611 and the TMRC Graphical User Interface version numbers. The “configuration” window allows you to upload, edit, and download configuration to the MRC7611 or save configuration files to disk for later use or archival purposes. The “terminal” window allows you to perform command line diagnostic operations; while the “firmware download” window allows you to download new firmware to the MRC7611.

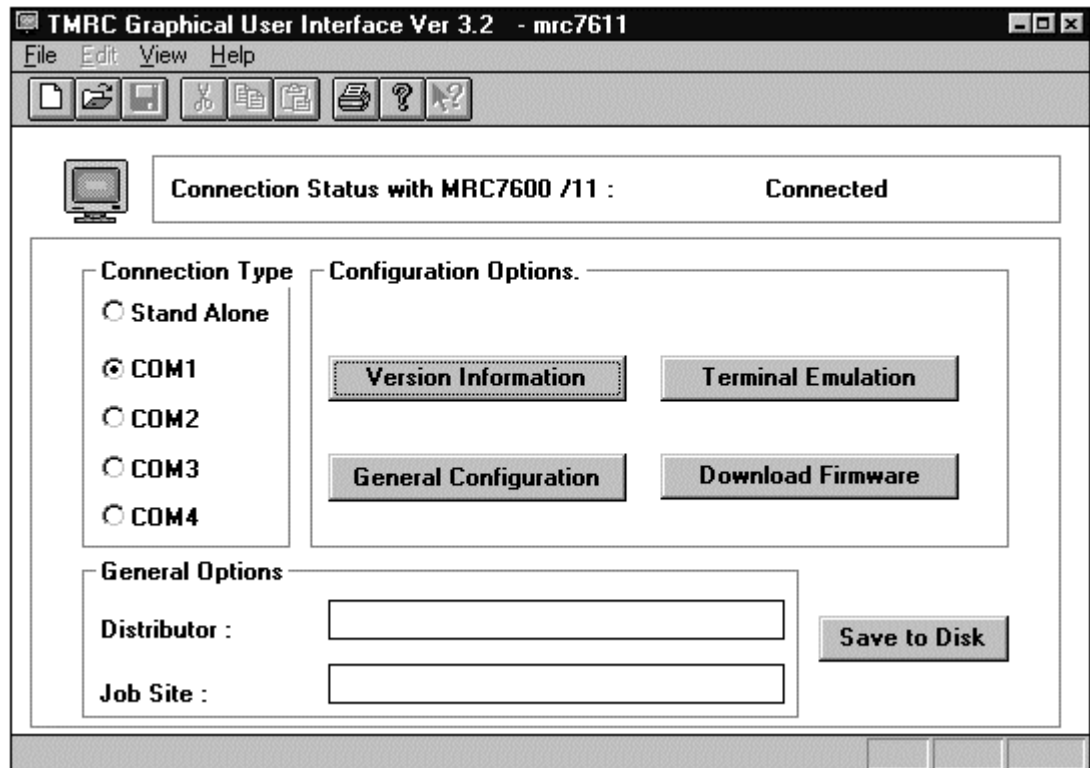

Main Screen: Remote-device Mode

Keep the following in mind when working in the remote-device mode:

- ✓ Use a straight-through DB9 cable to connect the MRC7611 to your PC.
- ✓ Select the “Remote-device” button upon entering the program.
- ✓ Choose a serial port on the PC to use in “Remote-device” mode.
 - *TMRC will attempt to open the port and connect to the Remote Device.*
 - *An error message will appear if the serial port cannot be opened or if the remote device does not respond. If either failure occurs, the program will automatically switch to “stand-alone” mode.*
 - *If the file is a new, a file selection list will pop-up, forcing you to select a new file. If you do not enter a new name, any changes will be saved to the open file.*

- ✓ If you receive a Comm error message, check the serial port setting. Make sure that the MRC7611 is connected to the selected Comm Port and is powered up.
 - *Upon successful connection, the connection status display will change from “Not Connected” to “Connected,” and all the buttons on the main screen will be enabled.*
- ✓ If you receive a “Remote device not responding” message, make sure the remote device is operational and attempt to reconnect. The TMRC will once again attempt to open the port and connect to the Remote device.
- ✓ To open any window, left click on the appropriate button or tab to it and press Enter after it has been highlighted.

Once the TMRC PROGRAM successfully connects with the MRC7611, it automatically verifies connection every 5 seconds. In this interval, the status posted on the main window may be inaccurate (i.e. if the user unplugs the cable connecting the MRC7611 with the PC, it may take the TMRC PROGRAM up to 5 seconds to detect the loss of connection). Likewise, it may take the TMRC PROGRAM up to 5 seconds to detect the presence of the new device upon reconnection.

Downloading New Firmware to the MRC7611

The TMRC and MRC7611 allow you to download firmware to the MRC7611 static RAM. Firmware comes in the form of a "hex" file, which can be obtained either on a shippable high density diskette (MRC7636) or as a downloadable file, from the World Wide Web, at <http://www.rauland.com>. **This feature is not available on the MRC7600.**

After you have obtained a copy of the file and have stored it on the PC you use to run the TMRC, you are ready to download it to your MRC7611. Typically, the download process takes about two minutes.

Step-by-Step

1. Connect to the MRC7611 using the TMRC.
2. Click on Download Firmware, located on the main TMRC menu:



- *The Hex File Download window will appear:*

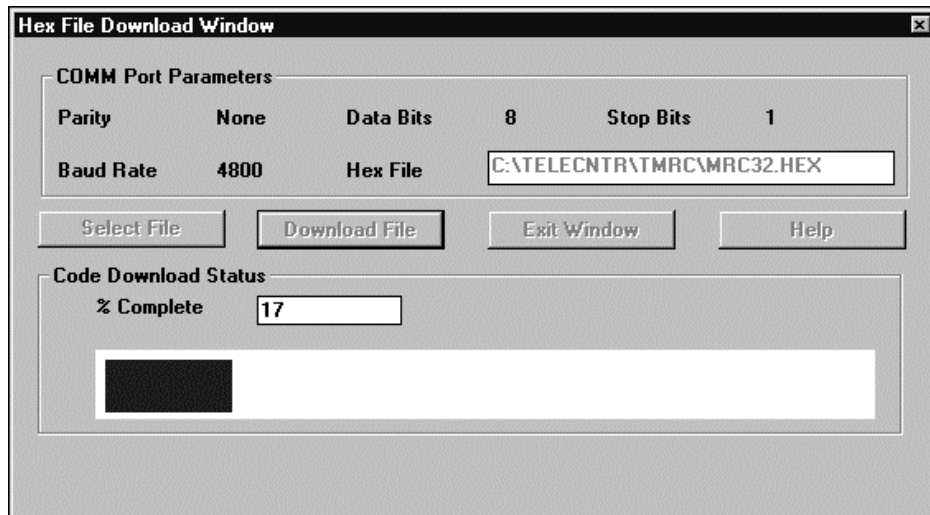

3. Click on Select File.
 - *The Select Code File window will appear.*
4. Find and select the appropriate hex file using the Folders and File Names lists in the Select Code File window.
5. Click on Download File.
 - *A warning window will appear.*
6. Click **OK** to continue.
 - *The downloading process will begin.*
 - *The Code Download Status area at the bottom of the Hex File Download window will show transfer status.*
 - *The LED located on the front of the MRC7611 board will remain lit during the entire download.*
 - *If the download is successful, the Hex File Successfully Downloaded message will pop up and the LED will flash the RAM firmware version number.*
7. Click **OK** to the message.
 - *The Hex Download window will reappear. (Skip to step 9.)*
 - *If the download was incomplete or unsuccessful, the Remote Device Not Responding message will appear and the LED will flash on and off continuously.*
8. Attempt your download again, closely following all of the steps set forth above.
9. Once you have successfully downloaded the firmware, click **Exit** on the **Hex Download** window.
 - *The TMRC main window will reappear.*

MRC7611 RAM & EPROM Modes

The MRC7611 features both RAM and ROM operating modes. As their names suggest, RAM firmware resides in a static RAM chip; while ROM resides in an

EPROM chip. Under normal operating conditions, the MRC7611 will function in RAM mode. If RAM firmware is corrupt, however, the unit will automatically switch to ROM mode.

When the MRC7611 is powered on or reset (reset button), it initially starts executing "boot" ROM code (residing in the EPROM chip). During initialization in the ROM mode, the MRC checks the integrity of firmware located in its RAM chip. If the firmware passes its integrity test, execution switches to the RAM firmware. At that time, the front LED flashes the major and minor RAM firmware version numbers. If the RAM firmware **does not** pass its integrity check, the MRC7611 remains in ROM mode, and the front LED continuously flashes on and off.

In RAM mode, the MRC7611 has the full range of functionality described in this manual. In the ROM mode, however, the MRC7611 has very limited capabilities. It does not, for instance, have the ability to answer calls, to control audio-visual equipment, or to use the TMRC configuration window to change system settings. It will, however, allow a user to download new firmware in coordination with the TMRC. It also will allow a user to operate the TMRC Terminal Window and carry out limited monitor mode commands, such as displaying memory contents and firmware version numbers.

MRC7611 Programming

Version Window

The "version" window displays both the graphical interface and MRC7611 version in "Remote-device" mode and only the graphical interface version in "Stand-alone" mode:

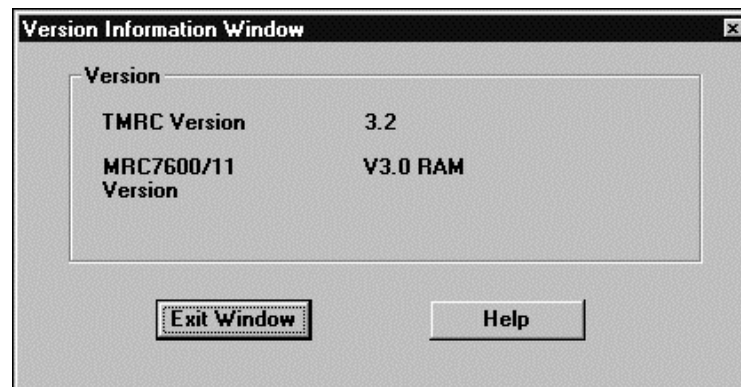

Configuration Window

The "configuration" window" allows a user to configure MRC7611 parameters. It is divided into 5 distinct sections (**Media Selection**, **Timer Settings**,

Line Type, VCR Key Mapping, and Initialization Commands)—and is only available while in RAM mode:

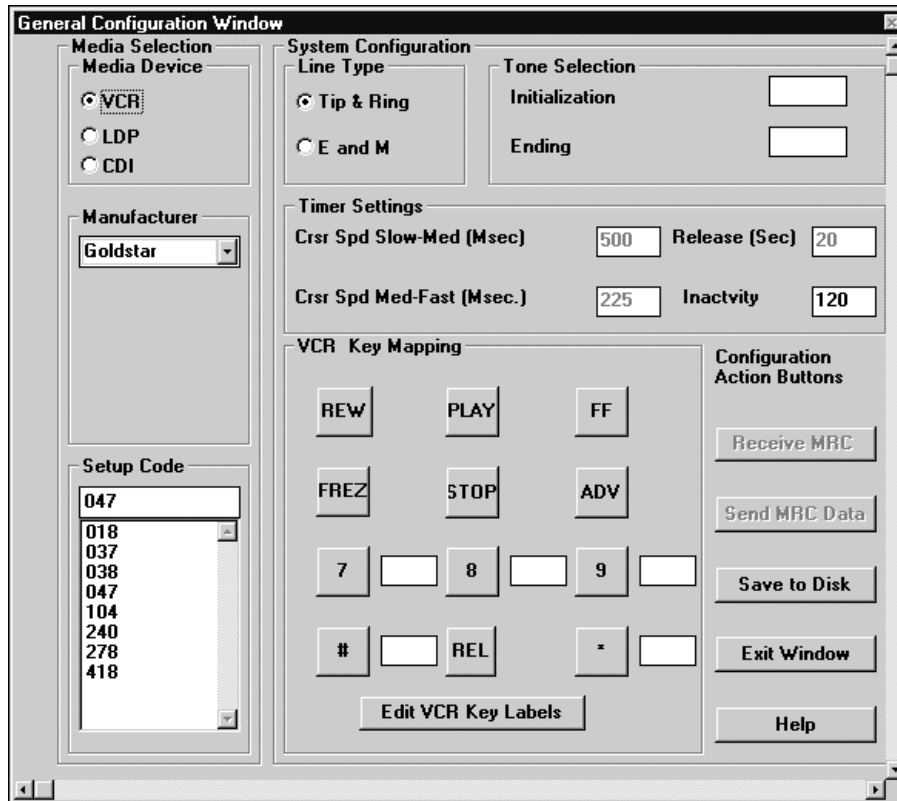

Configuration window: Remote-device Mode.

Media Selection

This section allows the user to select the media device and the setup code necessary to control a media device. A drop-down list box provides all the supported manufacturers. Upon keying in the first letter of the manufacturer name, the list box will scroll to the first item starting with that letter—selecting a manufacturer will list the setup codes supported for that manufacturer. Try each code until you find the right code for your VCR.

If the media device does not require a setup code (a Laser Disk or CDI, for instance), the item will be grayed out. The appropriate timers will become available for modification based on the media selection.

Line Type

This section allows the user to configure some system related parameters, based on the users knowledge of the current setup. The selections are restricted to Interface type (Tip/Ring or E&M).

Timer Settings

Different devices support different timers, as indicated:

Release Timer: the Release Timer is valid in the **Laser Disk Video Player** mode only. After receiving the Release digit (“0”), this timer determines the interval after which the MRC7611 will disconnect if it receives no additional digits. The valid range for the Release timer is 5 to 255 Sec. The default value is 10 seconds. (The VCR and CDI disconnect immediately after receiving the release digit “0.”)

Inactivity Timer: the Inactivity Timer determines the interval after which the MRC7611 automatically disconnects. The timer resets whenever the user enters a new command. The valid range is 1 to 255 Minutes. The default value is 120 minutes. (**Note:** Disconnection causes loss of both the “Privacy” and “Single digit reconnection” features.)

Cursor Speed (Slow—Medium): the (Slow—Medium) Cursor Speed Timer is valid only in CDI mode. It determines the interval the user has to keep the key continuously pressed, to transition from Slow to Medium speed. If this timer is set to 0, the CDI will transition into the medium speed upon start up. The valid range for this timer is 0 to 30,000 Msec. The default value is 500 Msec.

Cursor Speed (Medium—Fast): the (Medium—Fast) Cursor Speed Timer is valid only in CDI mode. It determines the time interval the user has to keep the key continuously pressed for the CDI to transition from the Medium speed to the Fast speed. If this timer is set to 0, the CDI will transition to the Fast speed from the Medium speed instantaneously. The valid range for this timer is 0 to 30000 Msec. The default value is 500 Msec.

VCR Key Mapping

This section of the TMRC window provides two functions. First, the user can directly control a VCR by clicking the appropriate, associated keypad function buttons. Second, the user can program unused telephone keypad buttons to execute user-defined VCR commands. **This feature is not available on the MRC7600.**



Important:

Existing VCR buttons (1-6 and 0) **cannot** be remapped.

Direct Control: direct control of a VCR is provided via the VCR Key-mapping section of the Configuration Window. Use these twelve buttons to verify installation and VCR code selection. A total of twelve buttons populate the window; seven of these are associated with fixed commands, five are user-definable:

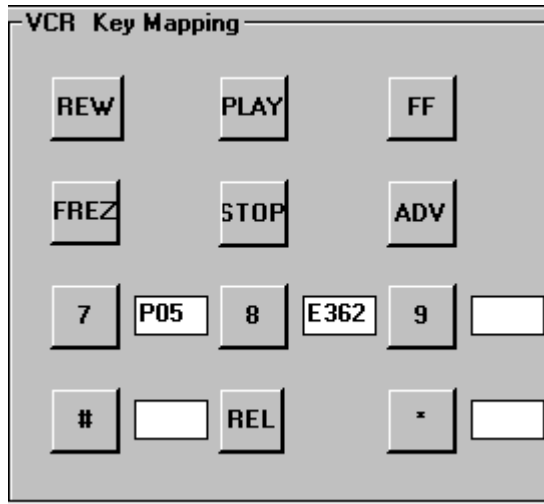

The fixed command buttons and their functions are as follows:

- ✓ **REW**: Rewinds the video tape.
- ✓ **PLAY**: Plays the video tape.
- ✓ **FF**: Fast-forwards the video tape.
- ✓ **FREZ**: Freezes/resumes playing the video tape (toggle switch).
- ✓ **STOP**: Stops the video tape (REW, PLAY, or FF).
- ✓ **ADV**: Plays/pauses the tape (toggle switch).
- ✓ **REL**: Has no effect.

User-defined Commands: a user can assign a command to any of the five remaining buttons using the Edit VCR Key-mapping function. Any of these user-defined buttons can also be used to control a VCR from a standard telephone keypad.

Important:



The MRC7611 may not support all possible VCR functions. You may need to experiment to determine whether a specific command is supported. Contact Technical Support for assistance.

Neither the MRR7800 nor the MRH7700 support user-defined VCR functions.

Defining Command Keys: you can program each of the user-definable buttons to execute either "primary" or "extended" commands. The difference between these command sets is merely the likeliness of their use. That is, primary commands are used more often—typically including such everyday commands as **Play, Stop, Channel Up, Channel Down**, and so forth. On the other hand, extended commands appear less frequently—perhaps including such commands as **On-screen Display, Time Search, and Slow**. A list of primary commands (and associated codes) is offered below. Extended commands (if available) may be obtained only from Rauland-Borg technical support:

Command	Code ("P" plus Suffix)	Command	Code ("P" plus Suffix)
Rewind	P12	Power	P02
Pause	P16	Scan	P23
Fast Forward	P14	Amp	P43
Play	P13	Audio	P44
Stop	P15	Video	P45
Channel Up	P05	1	P24
Channel Down	P06	2	P25
Volume Down	P04	3	P26
Volume Up	P03	4	P30
Recall	P22	5	P31
Display	P47	6	P32
Record	P17	7	P33
Program	P46	8	P34
Mute	P07	9	P35
Light	P53	0	P36
Sleep	P54		

Programming a Button: Step by Step

You must observe the following steps when attempting to program any of the user-definable command buttons:



Important:

Primary Commands require a two-digit "P" code, where the prefix "P" is coupled with any two-digit number between 00 and 54. For example, the code for Rewind would be P12.

Extended Commands require a three-digit "E" code, where the prefix "E" is coupled with any three-digit number issued by the Rauland-Borg technical service department. For example, the on-screen display code for "RANVCR" Panasonic AG1310 would be E362.

1. Use the **Primary** Code list (or call Rauland-Borg technical service for **Extended** commands) to determine the command code that you wish to assign to a particular command button.
2. Open the TMRC General Configuration window.
3. Click on the button you wish to define.

4. Enter the command code into the box provided at the right of the button.



5. Repeat steps 3 and 4 as necessary.
6. Click on the **Send MRC Data** button.



➤ *The data will be sent to the MRC7611.*

7. Repeat as necessary.

Editing Key Text: Step by Step

TMRC allows you to enter a description of each of the user-defined buttons. Descriptions appear adjacent to corresponding buttons in the **VCR Key Mapping Window**. Descriptions are limited to a maximum of 10 alphanumeric characters, may be saved to disk (not download to or uploaded from the MRC7611), and are assigned in the following manner:

1. Click on the **Edit Key Text** button.



➤ *The VCR Key Text window will appear:*

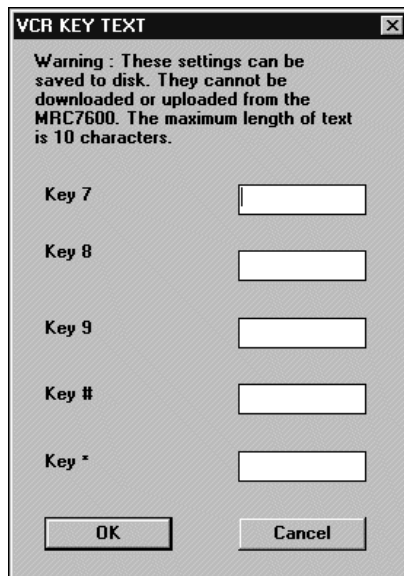

2. Use the mouse to position the cursor in the desired field.
3. Type an alphanumeric description that does not exceed ten characters.

4. Click **OK**.
5. Click **Save to Disk**.

Save to Disk

Caution:



The VCR key descriptions are **not** saved in the MRC7611. When you upload the configuration from the MRC7611, the key descriptions will be blanks. We strongly suggest that you either save the configuration to disk (which will save key descriptions) or simply write these down and keep them with the equipment.

Commands to Initialize or Terminate a Session

The “configuration” window allows the user to select those commands used to control the initialization and the termination of the media device (**Tip/Ring interface only**). Valid entries for these tones are numeric keys 0-9, # and *. When using the E&M interface, the Telecenter® head-end must provide all initialization and ending tones.

Initialization tones: the set of DTMF commands executed by the MRC7611 upon the initial connection to the MRC7611. The user can enter up to 4 tones selections in the edit box. Typically, the tones command a media device to begin playing.

Warning:



Do not use the asterisk “*” as an initialization tone for the Laser Disk Video Player. For further details, see the “Design Considerations” section above.

Ending Tones: similar to the initialization tones, these commands executed by the MRC7611 just after the user ends a session (i.e. releases control) with the device. Typical use would be to stop and rewind a video tape. Up to four DTMF tones can be entered for the ending tones.

Configuration Action Buttons

Save to Disk: the Configuration window lets the user save modifications to disk by left clicking the “Save to Disk” button. If a file has not been opened, the user will be prompted to either open an existing file or select a new file name for storing the configuration. Context sensitive help can be invoked by left clicking on the **Help** button or by pressing the F1 key.

Send/Receive MRC Data: when connected to the MRC7611 via a PC, the user can send the changes made on the PC to the MRC7611 by left clicking the “Send-MRC-Data” button or upload existing configuration in the MRC7611 by left clicking the “Receive-MRC-Data” button.

After downloading the settings to the MRC7611, the MRC7611 automatically resets itself. This takes about 10 seconds, during which no operations will succeed. The front panel LED will flash the version and subversion numbers.

The user can repeatedly download multiple MRC7611 units by simply moving the DB9 cable from unit to unit and clicking the Send button.

To re-transmit the same setup code to the MRC7611, the user must first download a different setup code, then re-program the desired setup code. Otherwise, the MRC7611 will ignore requests to re-send the same set up code.

Terminal Emulation Window.

The Terminal emulation window lets the user perform basic diagnostics on the MRC7611. On double clicking on the terminal emulation window, the user is automatically logged on to the MRC7611. Upon logon, the user can see \$XXXX on the terminal window. If you do not see the \$XXXX, and you are sure that the MRC7611 is physically connected, you must click on the **Logon to MRC** button. This connection will be reattempted.

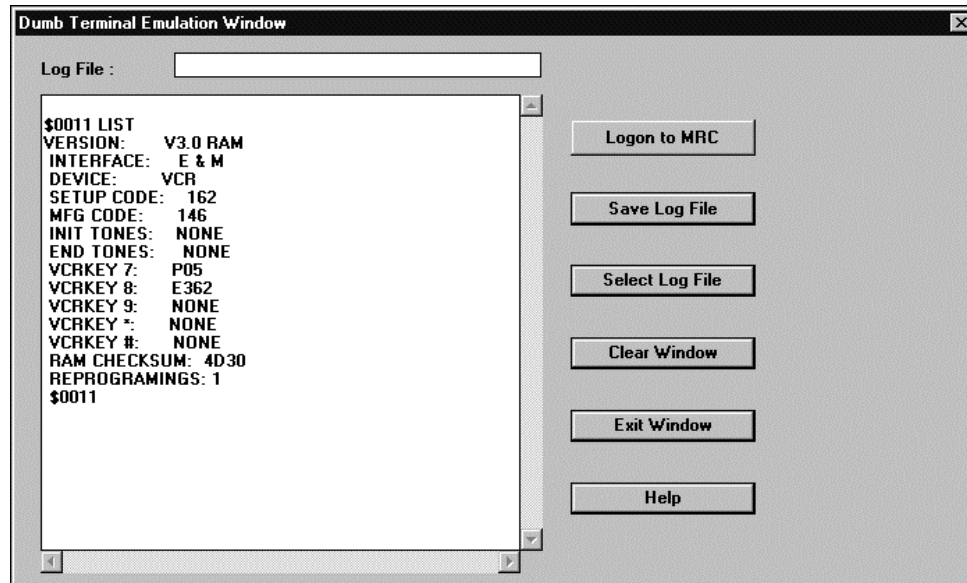

Terminal Emulation Window

In addition to configuring the MRC7611, the user can perform basic diagnostic functions, such as memory dump analysis. Configuration settings can be modified from the terminal window or from the "configuration" window.

Sessions can be stored to a log file for future reference. To do so, the user has to select an existing log file or select a new name, by clicking on the "Select-Log-File" button. If the file does not exist, it is automatically created. When the Save-Log-File button is clicked, the contents in the window are saved to the selected log file. If the user saves the log file prior to selecting a log file name, the user is prompted to select a file before executing the command. The terminal buffer has limitation of 64,000 characters and before the buffer fills up, the user is warned to either clear the buffer before proceeding or save the contents of the buffer into a log file.

The "Clear-Window" button is used to clear the contents of the entire 64k buffer. Upon clicking the Clear Window button, the user is warned that all data will be lost

and advised to save data to a file, if desired. At this point, the user can choose to click OK to clear all the data in the buffer or click Cancel, to save the buffer and clear the data again. The Help button or the F1 key will invoke context sensitive help.

Using Other Terminal Emulation Programs

Any third party terminal emulation program (e.g. ProComm) can be used to communicate with the MRC7611. The proper port settings are 4800 baud, 8 Data bits, 1 Stop bit, no parity checking.

Monitor Commands

The following section describes the monitor commands that can be used for configuration and diagnostic purposes (RAM mode only). The installer typically does all programming from the Configuration window; however, there are a few parameters that are only accessible from the Terminal mode. These must be used with caution, as noted below.

Commands that have arguments (e.g. VCRxxx<Return>) will show the current setting when entered without an argument (e.g. VCR<Return>).

Basic Commands (unless otherwise indicated, all commands are available either in RAM or ROM mode)

- ✓ **Ctrl-A Ctrl-A:** Log into the monitor mode of the MRC7611. If using the TMRC program, this sequence is automated (by the **Login** key). If using a third part communications package, like ProComm, the user has to type the above sequence to enter the monitor mode.
- ✓ **EXIT<RETURN>:** Exit monitor mode.
- ✓ **HELP<RETURN>:** List all the commands that are supported in the monitor mode with their correct usage syntax and a brief description of the command.
- ✓ **INTERx <RETURN> (RAM Mode Only):** Modify and display the interface type. The interface types currently supported are Tip and Ring and E&M. Valid values are 0 for the tip and ring interface and 1 for the E&M interface.
- ✓ **LIST<RETURN>:** List the configuration parameters, including interface type, version information, media device, and setup code.
- ✓ **RESET<RETURN>:** Exit the monitor mode and reset the MRC7611. When the user needs to exit the monitor program without resetting the MRC7611, the EXIT command should be used.
- ✓ **REV <RETURN>:** List the version of the MRC7611 firmware.
- ✓ **STATS<RETURN> (RAM Mode Only):** List some important statistics from the MRC7611. This information needs to be used for diagnostic purposes only.

Memory Commands (all Memory Commands are available in both RAM and ROM modes)

- ✓ **AAAA=<RETURN>**: Display the contents of the memory location having the address AAAA.
- ✓ **DAAAA-BBBB<RETURN>**: Dump the contents of memory locations AAAA to BBBB on the terminal window
- ✓ **U**: Display the contents of the previous memory location.
- ✓ **XY.<RETURN>**: Write value XY to the address being displayed currently.
- ✓ **<SPACEBAR>**: Display the memory contents at the current memory location. Note that the Spacebar command is not followed by a carriage return.

Media Device Selection Functions (all Media Device Commands are available in ROM mode only)

- ✓ **CDIxyz <RETURN>**: Set the media type to be a CDI and set the setup code to be xyz for the CDI device. When programmed successfully, the MRC7611 will generate codes for the make of CDI device that uses the xyz setup code.
- ✓ **LASER0<RETURN>**: Set the media type to be a Pioneer Laser Disk Video Player. When programmed successfully, the MRC7611 will generate codes for the Pioneer Laser Disk Video Player device.
- ✓ **MFGxy <RETURN>**: Set the manufacturer of the media device. This is a two digit number and is translated inside the TMRC program into a meaningful ASCII string.
- ✓ **VCRxyz <RETURN>**: Set the media type to be a VCR and set the setup code to be xyz for the VCR. When programmed successfully, the MRC7611 will generate codes for the VCR device that uses the xyx setup code.

Initialization and Ending Tone Commands—Tip/Ring mode only (all Initialization and Ending Tone Commands are available in RAM mode only)

- ✓ **ENDTONESXXXX<RETURN>**: Set the ending tones to XXXX, where X can be any numeric digit between 0 and 9 or the # or the * key.
- ✓ **INITTONESXXXX<RETURN>**: Set the Initialization tones to XXXX, where X can be any numeric digit between 0 and 9, or the # or the * key.

Timer Commands (all Timer Commands are available in RAM mode only)

- ✓ **BEEPDUReyz <RETURN>**: Set the beep pulse width, in milliseconds. The default value is 250 msec. This command is *not* accessible from the “configuration” window. **Do not change this without consulting the factory.** The beep duration affects the ability of the MRR7800 to detect the MRC7611.
- ✓ **BEEPxy <RETURN>**: Set the beep repeat interval, in seconds. The default value is 5 seconds. This is *not* accessible from the “configuration” window.
- ✓ **INACTIVExyz <RETURN>**: Set the contents of the Inactivity Timer, in minutes. It determines the interval after which the MRC7611 automatically

disconnects. The timer is reset whenever the user enters a new commands. The valid range is 1 to 255 Minutes. The default value is 120 minutes.

- ✓ **MFDELAYwxyz <RETURN>**: Set the CDI medium to fast timer.
- ✓ **RELEASExyz <RETURN>**: Set the Release time, in seconds. Valid only in the **Laser Disk** mode. After receiving the Release digit (“0”), this timer determines the interval after which the MRC7611 disconnects, if no more digits are received. The valid range for the Release timer is 5 to 255 Sec. The default value is 10 seconds.
- ✓ **SMDELAYwxyz <RETURN>**: Set the CDI slow to medium timer value.
- ✓ **TIMER<RETURN>**: Display the values of the important timer settings in the system. The individual timer commands can be used to modify these timer values if need be.
- ✓ **RDELAY<RETURN>**: Controls cursor scrolling for the CDI. Determines how long the MRC waits for next command before it stops scrolling. Default is 225 milliseconds. **Do not change without consulting Rauland-Borg Technical Support Engineering.**
- ✓ **IRDURxyz<RETURN>**: Sets the duration of the IR pulse sent to the VCR. Value xyz is in units of 10 msec. The default value is 4 (40 msec).

VCR Control Commands (all VCR Control Commands are available in RAM mode only; they are not available on the MRC7600.)

- ✓ **VCRKEYn=Pxy<RETURN>**: Assign a VCR primary command to key "n," where n is 7, 8, 9, *, or # and "xy" is a two-digit code. An extended command has the form of **VCRKEYn=Exyz,** where "xyz" is a three-digit code.
- ✓ **VCRKEYn=Exyz<RETURN>**: Assign a VCR extended command to key "n," where n is 7, 8, 9, *, or # and "xyz" is a three-digit code. Extended command codes must be obtained from the Rauland-Borg technical service department.
- ✓ **VCRKEYn=-<RETURN>**: Remove the assignment of a VCR command from key "n."
- ✓ **PLAY<RETURN>**: Command the VCR to play.
- ✓ **STOP<RETURN>**: Command the VCR to stop.
- ✓ **PAUSE<RETURN>**: Command the VCR to pause.
- ✓ **REWIND<RETURN>**: Command the VCR to rewind.
- ✓ **FASTFWRD<RETURN>**: Command the VCR to fast-forward.

Miscellaneous Commands (all Miscellaneous Commands are available in RAM mode only)

- ✓ **CHK<RETURN>**: Calculate the RAM checksum and display the value.

Telecenter[®] System Programming

This section describes basic Telecenter[®] system programming. For a detailed discussion of media retrieval programming, see the respective Telecenter[®] programming manuals.

Programming the Telecenter[®] involves the following basic steps:

- ✓ Programming a group of contiguous lines as class of service type “Media Lines”.
- ✓ Defining a single digit (typically “7”) in the Intercept Editor for the range of Media Lines.
- ✓ Programming desired initialization/ending tones. (LDP initialization tone “0*” is strongly recommended for MR100, but should not be assigned to any MRC7611 Media Lines.)
- ✓ Assigning a “Media Center” line (in the general vicinity of the Media Rack).
- ✓ Programming the classroom (“Staff”) phones for Media Access. (With assigned access, the Staff Phone may dial and connect to a specific media extension. Without assigned access, connection can only be established through optional, pre-assigned single-digit dialing.)

Telecenter with E & M Interface

For E&M applications, the only change has to do with ending tones for Laser Disk Video Players (see next paragraph). The MRC7611 is backward compatible with existing Telecenter[®] E&M media retrieval systems and firmware.

There is a significant change in the ending tone function for Laser Disk Video Players. On the MR100, the Release digit (“0”) had the side affect of leaving the MR100 in the Numeric mode. It was therefore necessary to have an asterisk (“*”) initialization tone to bring the unit back into the Command mode. This is *not* true for the MRC7611. When the MRC7611 receives the Release digit, it stays in the Command mode. In systems that have Laser Disks connected to both MR100 and MRC7611 units, program the “0*” initialization tone for the MR100, but don’t program any initialization tones for the MRC7611.

Telecenter[®] with Tip/Ring Interface

For Telecenter[®] V Tip/Ring applications, the line type must be A:4 with B:3. For TC21 Tip/Ring applications. Program the SCC ports as “Media.” Initialization and ending tones are provided internally on the MRC7611.



Important (Tip/Ring Interface):

Do not program any initialization or ending tones on the Telecenter[®] V or TC21 systems for this application.

4

Operations

This section gives detailed instructions on controlling a video player from a telephone. The two illustrations at the back of this manual summarize these functions.

Establishing/Relinquishing Player Control

The following describes a typical session with a Media Line:



Important:

All Administrative Phones can control Media Lines. If your Dialing Staff Phone is not programmed to access a Media Line directly, call the Media Center to have the desired line assigned to your phone.

1. Tune the television monitor to the channel assigned to the desired video player.
2. Dial the number of the desired player or a single-digit access code if the player is already assigned to your phone.
 - The system will send a short beep when it has given you control of the player, and will continue to beep at five-second intervals. (If someone else already has control, the system will send you a busy signal. If your phone is not authorized to call an Media Line, the system will send you a reorder signal; in this case, call the Media Center to have the line assigned to your phone, then repeat Step 2.)
3. After gaining control, use your telephone's keypad to operate the player (see the next subsection).

In Tip/Ring mode: the Media Line is not activated until you enter a command (unless initialization tones are programmed). If no commands are entered within two minutes, the Media Line auto-releases.

4. To operate the keypad, keep the receiver off-hook. Once the player is running the program and you do not need to send any more control signals for a while, you can hang up.
 - The player will continue running, and its Media Line will remain assigned to you, which means no one else can access it (unless the Media-Center Phone

intervenes with the #24 function). Hanging up frees a Telecenter® link for other functions and lets you receive or make other calls.

- The Inactivity Timer will cause the MRC7611 to auto release after a programmed period of inactivity (typically 120 minutes).
5. To resume sending control signals, call that Media Line back from the same phone, as in Step 2.
 6. To relinquish control of a player, dial 0 and hang up.

Paging the Media Center Operator

If you need to contact the Media Center while connected to a Media Line, simply hook-flash. You will be temporarily disconnected from the Media Line; and the Media Center line will begin ringing (or be connected to its associated speaker). This operation is particularly useful if the wrong program was placed into the media device by the Media Center operator.

To end the connection with the Media Center and return to the player, simply hook-flash again or wait for Media Center telephone to hang up.

If your system does not permit hookflash, hang up as in Step 4, then call the Media Center; you will retain control of the player and be able to dial it back

Operating a Player

The illustrations at the end of this manual identify the functions of the keypads. This section explains those that are not self-evident and gives examples of typical operations.

In general, the keypad commands parallel the layout of a typical remote control.

VCR (Video Cassette Recorder) Operation

This mode uses the first six keys and “0” (the remaining five keys are user-definable; see the **VCR Key Mapping** section above). Some keys can work in combination with others. For example, *Fast Forward (3)* and *Fast Reverse (1)* by themselves advance or rewind the tape rapidly without displaying a picture. Pushing either one while the tape is playing runs the picture rapidly on the screen in a search function.

Laser-Disk Player Operation

There are two LDP modes, “Numeric” and “Command,” and users will quickly discover that the telephone keypad invokes completely different options within each.

The Numeric mode (discussed immediately below) offers the user the ability to enter time, frame or chapter numbers. The Command mode allows the user to

execute single-key instructions, such as “Play” and “Stop.” The illustrations in Appendix A, at the end of this manual, describe the two modes in detail.

Which Laser-Disk Mode Am I In?:

You can tell from the TV picture which function mode you are in. The Numerical mode always shows a blue screen; and if the “Show Numbers” key has been selected, you will see some numbers against this blue screen. In the Command mode, you will typically see a video image. However, “Pause, Blank Screen” (key 5) in the Command mode also shows a blue screen. Pressing “Play” (key 2) will start the disk playing if the “Pause, Blank Screen” function is engaged, but will have no visible effect if you are in the Numerical mode.

Laser Disk Formats

As mentioned, there are two laser disk formats: CAV and CLV. CAV disks are organized by frame and chapter, while CLV disks are organized by chapter and time increments.

Each motion sequence on CAV disks has 30 frames per second of viewing time, and each frame can be shown as a still picture or selected as a starting or stopping point. Some disks have “slides”—individual pictures recorded as a series of single frames on the disk. These have to be stepped through, one by one; pressing *Play* would result in a rapid, confusing succession of images.

CLV disks—typically used for videos or motion pictures—may also contain chapters, but can always be addressed in terms of “time.”

To Select a Chapter

In the Command mode, dial 0–[Chapter Number]–*. For example, to select Chapter 11, dial 011*:

- 0 Go to the numeric mode and interpret the keypad entries as a chapter number.
- 11 Chapter 11.
- * Put the first frame of the chapter on the screen and return to the Command mode.
 - The first frame will appear frozen on the screen; pressing 2 (Play) will cause the laser-disk player to begin running the program from that frame.

To Select a Frame or Time

In the Command mode, dial 8–[Frame Number]–*. For example, to select Frame 41222, dial 841222*:

- 8 Go to the numeric mode and interpret the keypad entries as a frame number.
- 351 Frame 351 (CAV format) or 3:51 (CLV format).
- * Put that frame on the screen and return to the Command mode.

- The first frame will appear frozen on the screen; pressing 2 (Play) will cause the laser-disk player to begin running the program from that frame.

To Select a Stopping Point

The above two procedures select a starting point. To select a point at which the program will automatically halt, use the above formulae but enter # instead of * as the final keystroke. You can select the stopping point either before or after selecting the starting point.

- *The keypad will return to the Command mode, and the last frame that was on the screen will reappear.*



Important:

Some disks have built-in stop marks between chapters. These could stop the program before it hits the stop mark you set in the numeric mode. Pressing Play again will cause the disk to run again until hits your stop mark (or another intervening stop mark on the disk).

Selecting Audio Channels

Some stereo disks are bilingual, using the left audio channel for a narrator in one language (e.g., English) and the right audio channel for a speaker in a second language (e.g., French). Since the Pioneer player's default audio mode is stereo, the result would be hearing the two narrators simultaneously.

Selecting just Channel 1 (7) or just Channel 2 (*) is done with a single keystroke in the function mode. Selecting the combined Channels 1 and 2 is done by pressing 0-#. Once you have selected an audio function, it will remain in effect until you change it.

CDI Operations

The CDI player allows the user to interactively move a cursor across a TV screen and to click on various buttons to control the program. You must use the MRH7700 Hand Held Remote to control the CDI Player. The directional arrows are labeled on the MRH7700. The function definitions are as follows:

Function	MRH7700 Key
Left	←
Up	↑
Right	⇒
Down	↓
Action 1	Stop
Action 2	Run
Release	Quit

Cursor Operation

The cursor scrolls at three speeds across the TV screen. The MRC7611 starts at the slowest rate and then jumps to faster rates after programmable time intervals. From the MRH7700, you simply hold down the arrow button and the cursor scrolls and accelerates across the screen.

Cursor Speed

There are two timers which control the delays in changing from the slowest to the middle speed (called *Cursor Speed Slow-Med*) and from the middle to fastest speed (called *Cursor Speed Med-Fast*). By setting one or both of these to zero, you can time out the delays between speed changes and go directly to a faster speed. Of course, the faster you go, the more difficult it is to stop accurately. The first step taken is always the finest (slowest) step regardless of the timer settings. The default value for both timers is .500 milliseconds.

Action Buttons

The action buttons cause certain actions to occur in the CDI program. Generally, action 1 and action 2 buttons have the same affect, but some programs may make use of both. Consult the users manual for each specific CDI program.

5

Media-Center Telephone

#24 Media-Center Control Function

This function allows a display phone to review and, if necessary, terminate a user's control of a Media Line. (The Media Center phone must be assigned the "Admin" Class of Service.) Dialing #24 will display the first video player's status in the following manner:

VCR 717 = 105

or

VCR 718 = Free

"VCR" indicates the player's line, which may be either a video-tape or a laser-disk player. The first display shows that the player on Media Line 717 is currently assigned to phone line 105. The second display indicates that player 718 is currently available.

To Pre-assign a Player

Enter the Architectural (dialing) Number of the station to which you are assigning the player. The display will then list the new station owner. Unless the Media-Center telephone intervenes, only that owner can call this player, and the player will receive the initializing tones when it is called.

To Terminate a Connection

Press the asterisk (*) key on your dial pad. The display will show that the line is "Free" after sending the ending tones to that line. The status LED will go out. Pressing * when the player is already "Free" will also send the ending tones to it.



Important:

This method works whether or not a user is connected to a Media Line..

To View the Next Player Extension

Press the #. When you have gone through the entire list of player lines, the words *End List* will appear in the display, and the system will ignore any subsequent key entries. To end the review at any point, hang up.

Using a StarPlus Phone in the Media-Center

The #24 function can be performed from any StarPlus Executive Display phone which is programmed with a Telecenter® administrative display button. However, you will lose the ability to connect to the Media Center phone by simply hook flashing (see section 'Paging the Media-Center Operator').

As an alternative, hang up and dial the Media Center. You will retain control of the player and be able to dial it back.

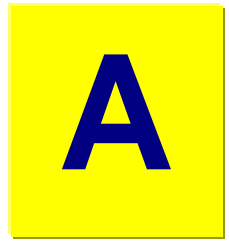

Appendix A

Illustrations

Telecenter® Media-Retrieval Classroom Operating Guide

Accessing and Releasing

1. Tune the television set to the desired channel.
2. Dial the number of the desired player.
3. Wait for a "beep".
4. Use the phone keypad to control the player.

To hang up without releasing a player, make sure you are in the function mode, then hang up.

To resume contact with player, call its number again and wait for a "beep".

5. *To release a player,* press "0" and hang up.

Special Laser Commands

To select a laser-disk frame: 8-[frame no.]-*.

To select a laser-disk chapter: 0-[chpt.no]-*.

VCR Functions

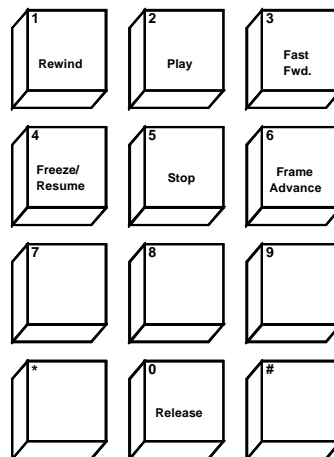

Buttons 7, 8, 9, *, and # are user-definable.

Laser Function Mode

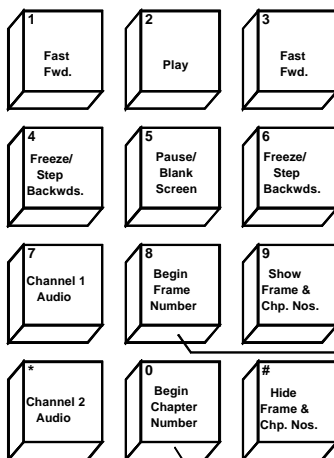

Laser Numeric Mode

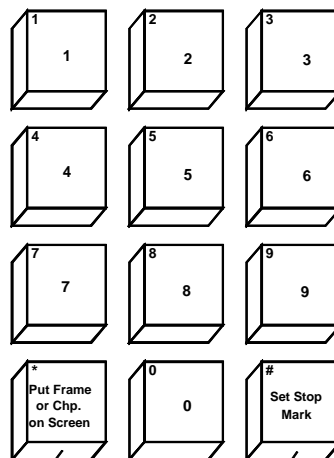

(Go to Numeric Mode)

(Go to Numeric Mode)

(Go to Play Mode)

IL0550

Laser - Disk Function Mode

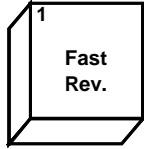

Fast Reverse (1) : Quickly pressing and releasing this causes the player to rapidly scan back about 300 frames (about ten seconds of viewing time). Holding it down causes the player to continuously scan backwards: however, it will continue scanning for a short time after you release this key.

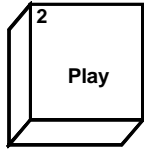

Play (2): Begins playing from the frame currently on the screen (if you previously pressed "Freeze, Blank Screen", pressing "Play" will bring back the picture and begin playing from the point where the program had been "frozen").

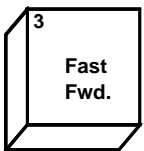

Fast Forward (3): Quickly pressing and releasing this makes the player scan ahead about 300 frames (about ten seconds viewing time). Holding it down makes the player continuously scan, even shortly after you release this key.

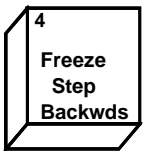

Freeze/Step Backwards (4): This stops any motion and holds a frame on the screen. Pressing it when a frame is already "frozen" on the screen brings the previous frame onto the screen.

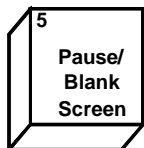

Pause/Blank Screen (5): This freezes a frame but displays a blank blue screen. This is helpful when a presenter wants to halt a program to talk about what has been seen, and not have the audience distracted by the screen. Pressing "Play" or any of the other first six keys causes the player to start from the frame it had frozen.

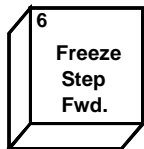

Freeze/Step Forward (6): This stops any motion and holds a frame on the screen. Pressing it when a frame is already "frozen" on the screen brings the next frame onto the screen.

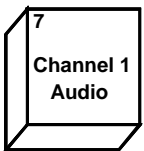

Channel 1 Audio (7): Pressing this selects the audio from the left channel only. Use "0 - #" to restore mixed audio.

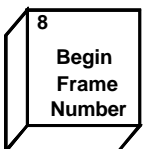

Begin Frame Number (8): This takes you to the numeric mode, where the digits you enter will be used to select a frame.

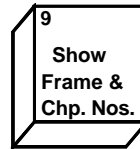

Show Frame and Chapter Numbers (9): This instructs the player to display the numbers on the upper left part of the screen. Of course, this works only for disks encoded with these numbers.

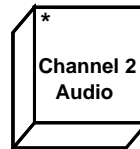

Channel 2 Audio (*): Pressing this selects the audio from the right channel only. Use "0 - #" to restore mixed audio.

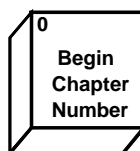

Begin Chapter Number (0): This takes you to the numeric mode, where the digits you enter will be used to select a chapter.

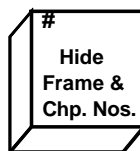

Hide Frame and Chapter Numbers (#): This prevents the numbers from being displayed on the upper left part of the television screen.

Selecting Laser - Disk Frames and Chapters

- ① In the function mode, press "8" to select a frame number or "0" to select a chapter number.
 - ⇒ The player will halt, the screen will be a blue blank, and the system will begin interpreting your keystrokes under the numeric mode.
- ② Type the chapter or frame number.
- ③ (a) *To go to the selected chapter or frame:* Press " * ".
 - ⇒ The frame or chapter will "freeze" on-screen, and the keypad will be in the command mode.
- (b) *To make the selected chapter or frame the "end mark" (stopping point):* Press "#".
 - ⇒ The currently selected frame or chapter will appear "frozen" on the screen, and the end mark will be in the system's memory.

Note:

You cannot select the current frame as an end mark (because the player has already stopped there).