

DRAWING NUMBER
500-055 CCT SHT 1 C

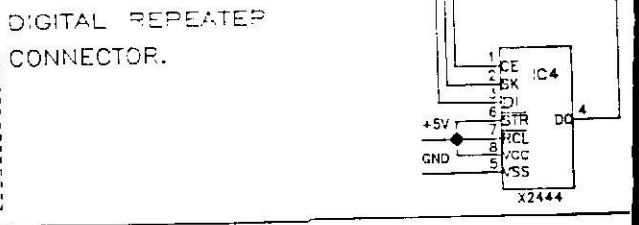
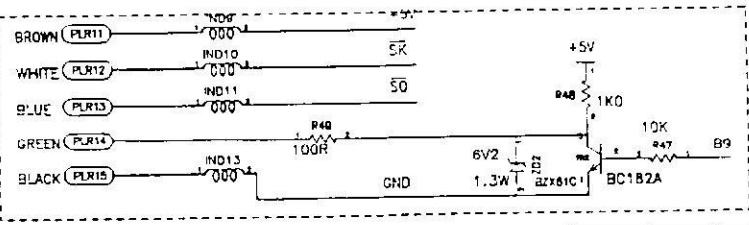
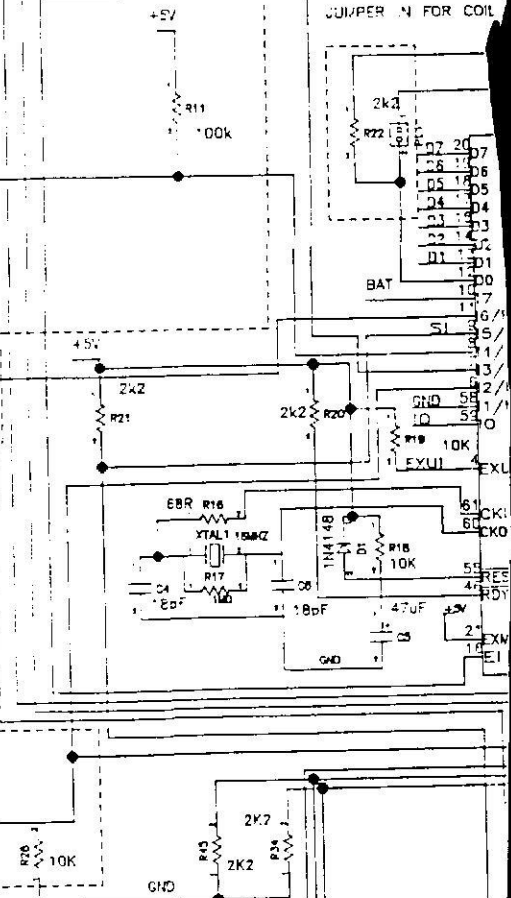
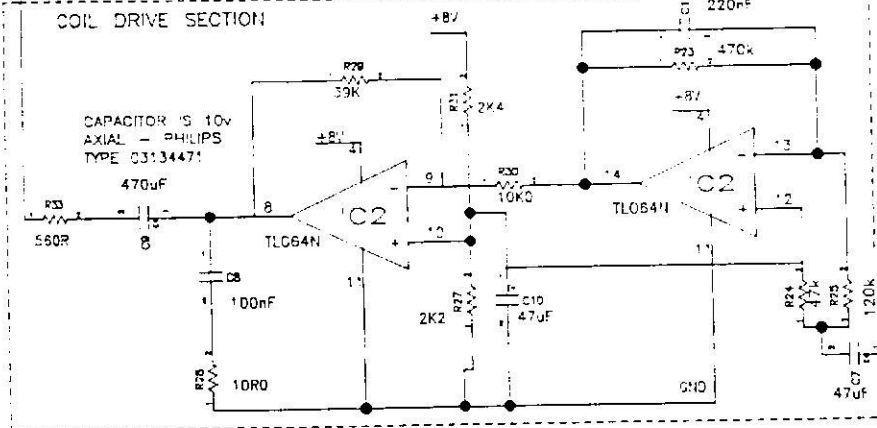
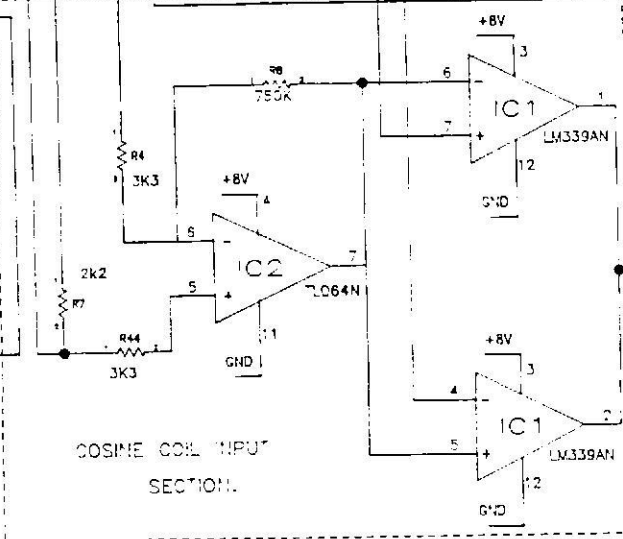
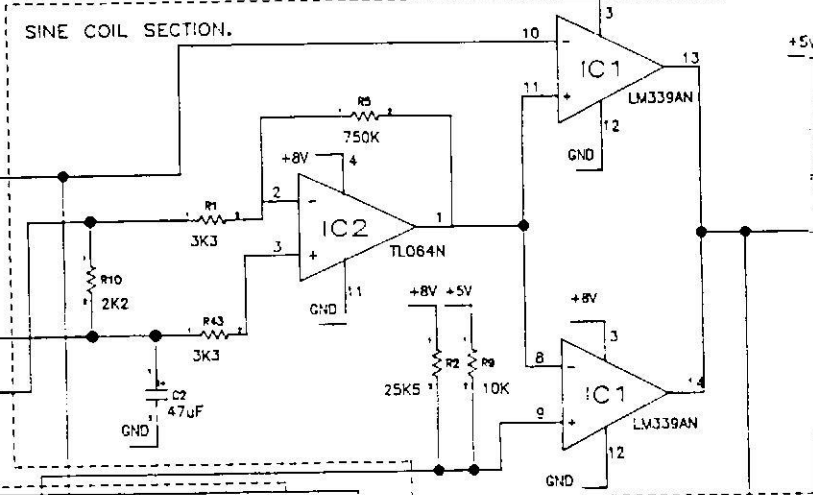
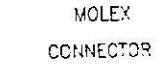
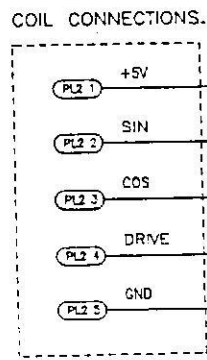
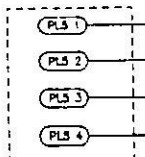

Teleflex
Canada Ltd.

DRAWN	SSC
CHECKED	
ISS A	03-07-1989
ISS B	04-09-1989
ISS C	18-01-1990

X2444

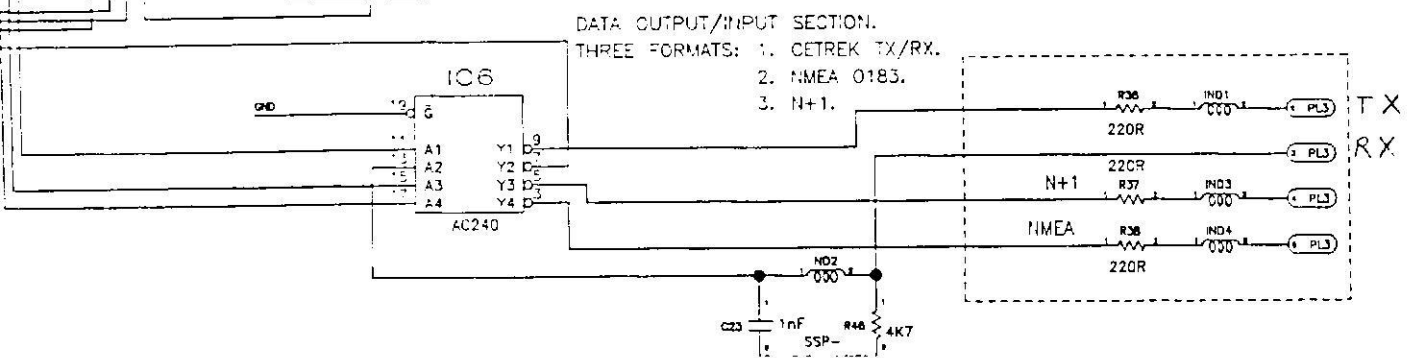
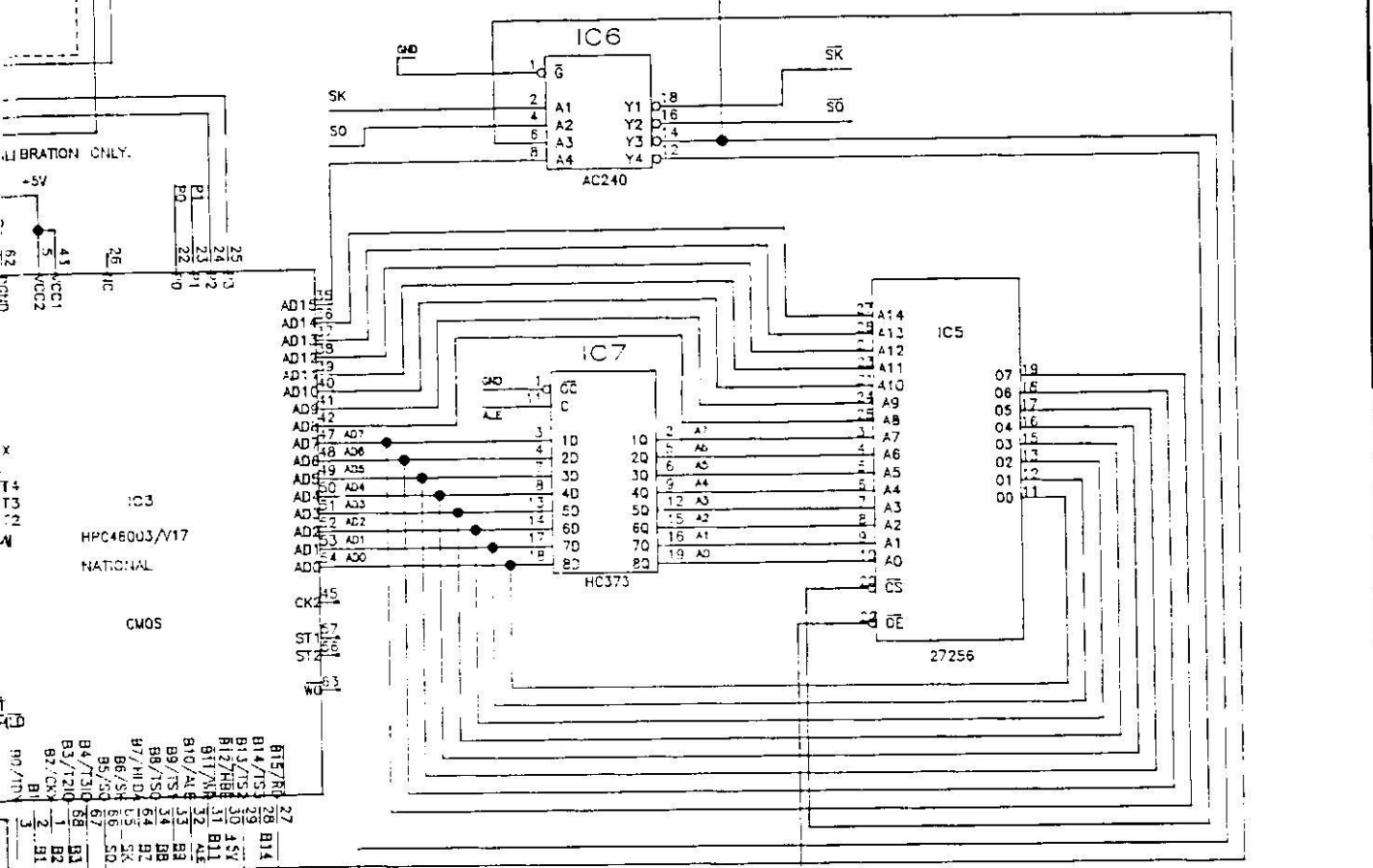
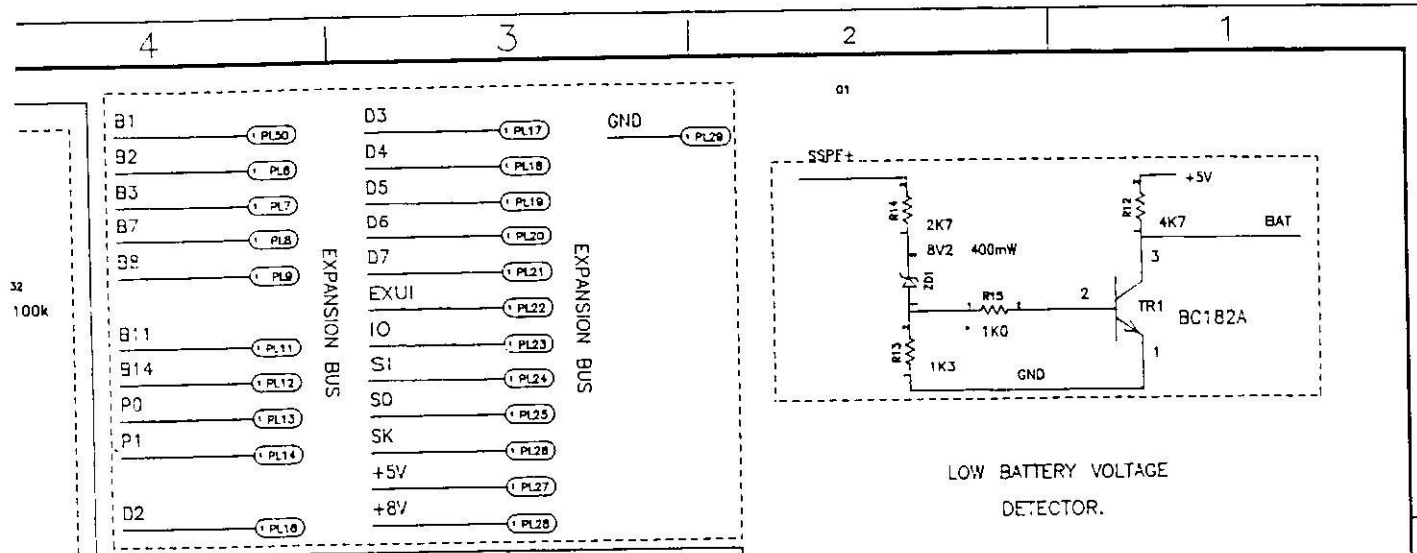

AP2577

C 11-1-1990 CN 0441 CN 0444	TITLE	BASIC DIGITAL PHASE COMPASS - 577.	ISSUE SH 1 C
	DRAWING NUMBER	500-055 CCT	
	CHANGE		

8

7

6

5

DRAWING NUMBER	ISSUE
500-055 CCT SHT 2	C

D

C

B

A

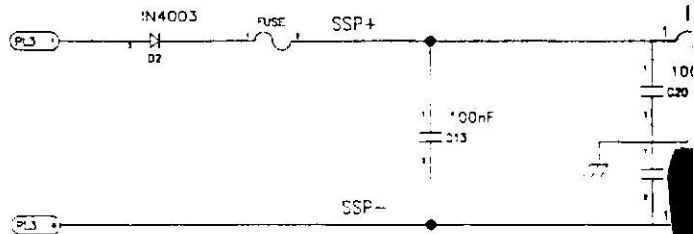

CHASSIS GROUND
ONLY: NOT TO B
G

DECOUPLING CAPACITORS 5V LINE

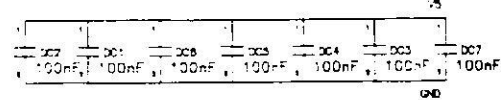

Teleflex
AEROSPACE DIVISION

DRAWN	SSC
CHECKED	(Signature)
ISS A	03-07-1989
ISS B	04-09-1989
ISS C	18-09-1990

8

7

6

5

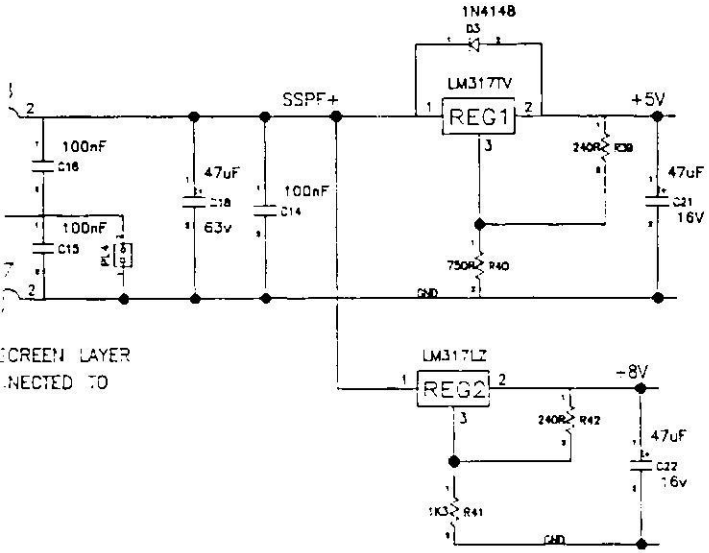

AP2577

CHANGES C 11 - 1-1980 EN 0441 CN 0444	TITLE	BASIC DIGITAL COMPASS DESIGN - 577.
	DRAWING NUMBER	500-055 CCT SHT 2
	ISSUE	C