

Keep an eye on the LVDS input levels

By E.D. Cole, P.E.

Application Engineer, Data Transmission

Introduction to LVDS input levels

Low-voltage differential signaling (LVDS) systems (see Figure 1) run at extremely high data rates. These systems are unusually robust in terms of noise immunity and V_{CC} stability, and provide an easy way to get data between two points very quickly. One of the design parameters for an LVDS system is the level of the signal provided to the input of the LVDS driver. It is important that the high-level and low-level inputs to the LVDS driver be kept balanced (symmetrical) about the threshold voltage where the driver switches the output between states.

Impact of non-symmetrical inputs

It is easy to see the effects of a non-symmetrical input. As shown in Figure 2, the receiver output appears distorted when the inputs are not centered on the V_{THRES} switching level of the driver.

LVDS level specifications

The input levels to a 3.3-V LVDS line driver are specified as $0.0 V_{DC}$ to $0.8 V_{DC}$ for a logic-0 and $2.0 V_{DC}$ to $3.0 V_{DC}$ for a logic-1. Input levels between $0.8 V_{DC}$ and $2.0 V_{DC}$ are undefined, which means that a driver's switching threshold voltage is also undefined, but it is not hard to determine. By applying a clock signal into the system and adjusting the input levels V_{IH} and V_{IL} while monitoring the receiver output for a 50% duty cycle, the data in Figure 3 is obtained. The values of V_{THRES} shown in Figure 3 are calculated from the V_{IH} and V_{IL} input levels. Note that this can be interpreted as the input sensitivity, not just for the

Figure 1. An LVDS system

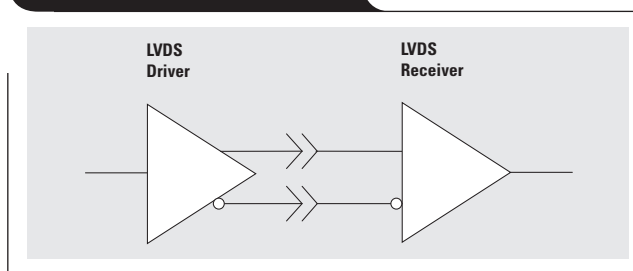

LVDS driver but for the entire LVDS system. The calculated results show a V_{THRES} of approximately $1.35 V_{DC}$ independent of the data (or clock) rate.

Amplitude and offset

Figure 4 shows the driver output when the input levels are not centered on the input threshold. The Channel 1 waveform (approximately 52% duty cycle) is the driver output when $V_{IH} = 2.35 V_{DC}$ and $V_{IL} = 0.35 V$, which is closely centered about the 1.35-V threshold. But note the Channel 2 waveform in Figure 4 (approximately 60% duty cycle). This shows the driver output response to an input with $V_{IH} = 2.5 V_{DC}$ and $V_{IL} = 0.5 V_{DC}$. This is still at a $2.0 V_{PP}$ amplitude but is centered at $1.5 V_{DC}$. The result is a slight "skew" in the output. The duration of a logic-1 has increased by approximately 640 psec at the expense of the duration (or width) of the logic-0.

Continued on next page

Figure 2. Outputs appear distorted when inputs are not symmetrical

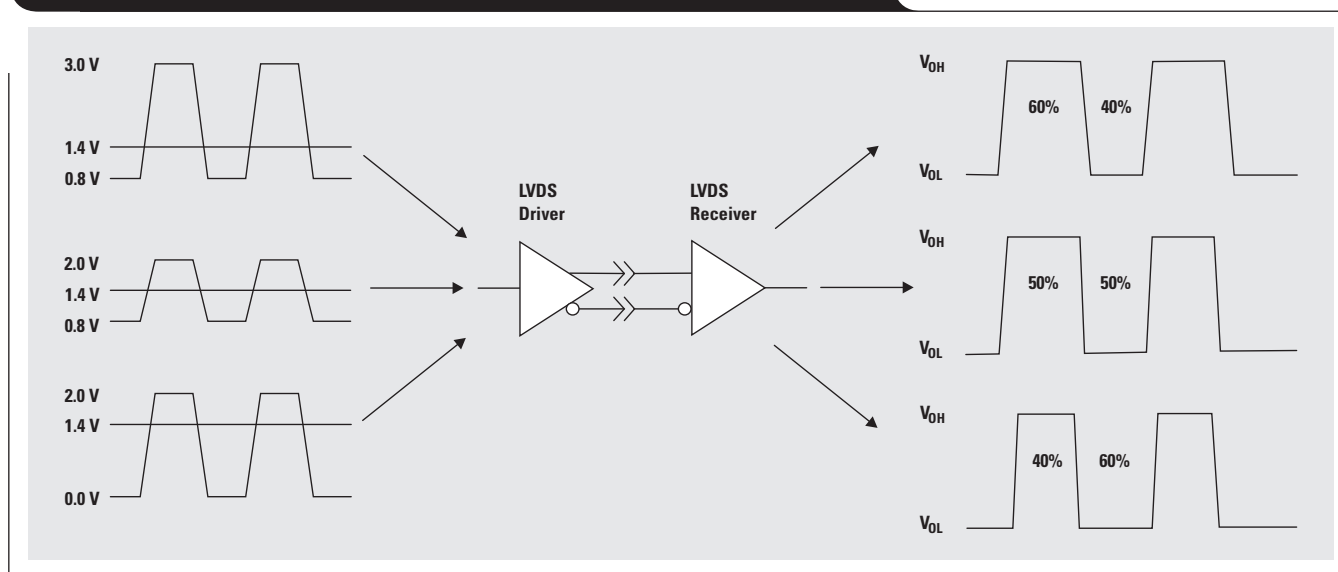

Continued from previous page

When used for clock distribution, this skew is not a problem because the rising and falling edges are clean and stable. High-speed clock signals are rarely perfect square waves with a 50% duty cycle, but when transmitting data (in this example it would become 200 Mbps) this skew could present a problem. At 200 Mbps, each data bit would be 5 nsec wide, but the results in Figure 4 show the Channel 2 waveform with a 0 bit that is 4.36 ns wide (5.0 ns - 0.64 ns) and a 1 that is 5.64 ns wide (5.0 ns + 0.64 ns). The difference between a 0 and 1 would be 1.28 ns, with $V_{IH} = 2.5 V_{DC}$ and $V_{IL} = 0.5 V_{DC}$ —well within the specification.

As long as the inputs are centered about the input threshold, the output will maintain the correct duty cycle and bit width. The reader should think of this as an input amplitude and offset. In Figure 5, Channel 1 is the driver output when the input amplitude is $1.5 V_{DC}$ with an offset of $1.35 V_{DC}$ ($V_{IH} = 2.1 V_{DC}$ and $V_{IL} = 0.6 V_{DC}$). Channel 2 is the driver output after the input amplitude has been

Figure 4. Effects of non-symmetrical inputs on the output waveform

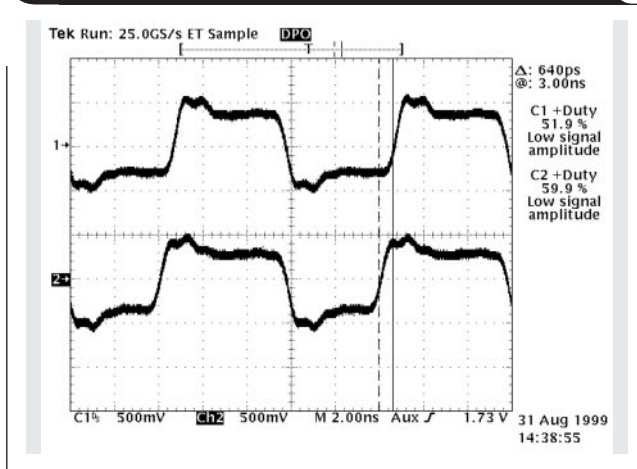

Figure 5. Output response to different amplitude levels but the same offset voltage

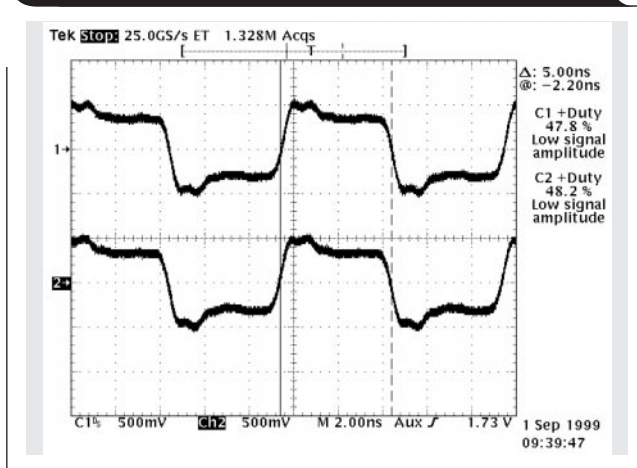
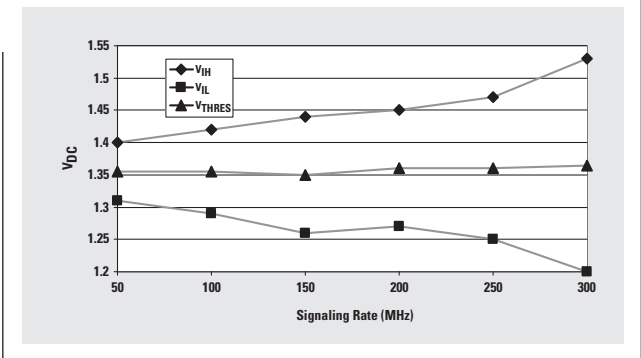

Figure 3. Minimum differential input levels to an LVDS system



reduced to $0.5 V_{DC}$ with no change in the $1.35 V_{DC}$ offset (now $V_{IH} = 1.85 V$ and $V_{IL} = 0.85 V$). There is no noticeable difference in propagation delay (through the driver) or shift in duty cycle out of the driver. These inputs levels do not meet the LVDS specification, but work well.

Why does the duty cycle change?

The answer to this question is shown in Figure 6. In Figure 6(A), the input levels are centered above the threshold, which results in an increase in the positive

Figure 6. Driver output characteristics vs. input levels

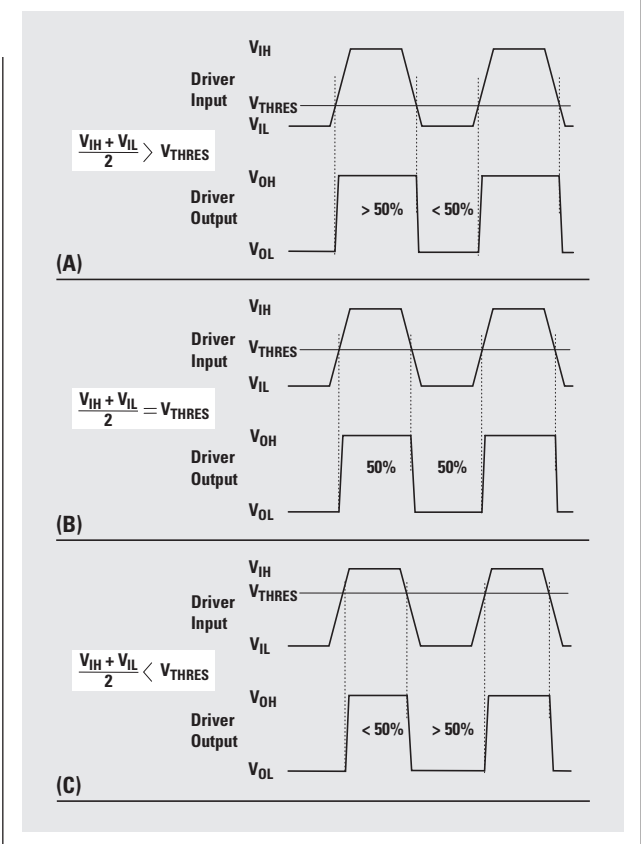

duty cycle. In Figure 6(B), the inputs are centered, which results in a 50%/50% duty cycle. Figure 6(C) shows the input levels centered below the threshold, a condition resulting in a decrease in the positive duty cycle. Figure 6(C) also shows the driver's response to its input signal. This change in duty cycle for NRZ data streams translates into a difference between the width of 0's and 1's.

Threshold adjustment

The threshold cannot be adjusted, but the input levels might be adjustable. The data in Figure 3 shows that even at high signaling rates the input sensitivity to an LVDS driver is approximately 300 mV (and less at slower signaling rates). This means it may be possible to adjust the input signal by installing a resistor divider at the driver input.

The author simulated a 100-MHz clock distribution system with $V_{IH} = 3.5$ V and $V_{IL} = 0.5 V_{DC}$ (amplitude = 3.0 V, offset = $2.0 V_{DC}$) to the driver. To bring the offset voltage down near the driver's threshold voltage, the resistor divider network shown in Figure 7 was installed.

This divider reduces the offset from 2.0 V to 1.4 V, very near the threshold voltage of the driver. It also reduces the input amplitude by 30%, making $V_{IH} = 2.46 V_{DC}$ and $V_{IL} = 0.35 V_{DC}$.

Performance of this modified input was compared to another driver having the standard 50-ohm input termination. The results are shown in Figure 8. Notice that the Channel 1 waveform is very symmetrical with a very good duty cycle. The Channel 2 waveform has an offset voltage of $2.0 V_{DC}$ and produces the increased (57%) positive duty cycle result expected.

Data transmission

What happens when the driver is sending data? A shift in duty cycle is the same as a "skew" in the width of data bits—1's and 0's will not be the same width. This can be seen using eye patterns to view the serial data stream. Figure 8 shows how, using two clock inputs, the resistor divider can be used to center the offset level. By changing these inputs from "clocks" to random data (NRZ formatted) the serial data stream using eye patterns can be viewed. The input levels have not been changed.

Figure 8. Resistor divider input vs. standard input to an input clock

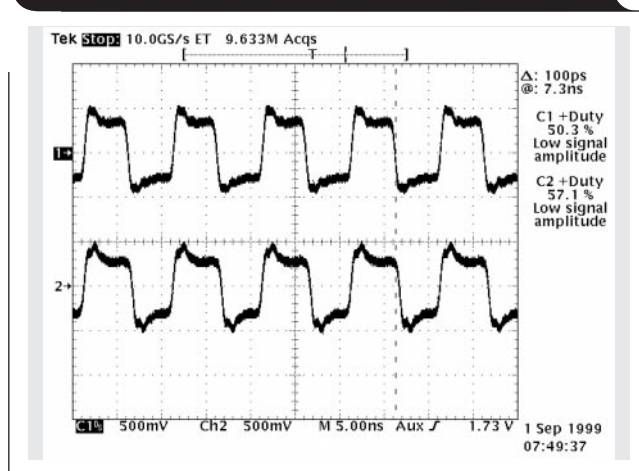
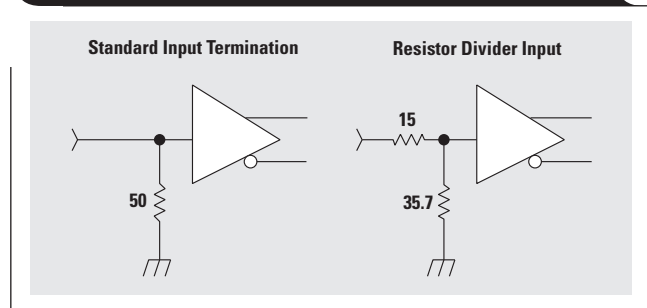

Figure 7. Using a resistor divider to "center" the input levels



The Channel 1 trace contains the eye pattern for the adjusted signal. The divider has aligned the input very near the switching threshold of the LVDS driver, and the output has the familiar "X" at the crossovers indicating the system is switching 1's to 0's and 0's to 1's at the same time. In other words, each bit is the same width.

The Channel 2 trace is the eye pattern for the unadjusted signal. These input levels resulted in the 57% duty cycle waveform shown in Figure 8, and after the format is changed to "data" the corresponding eye pattern shows that the data bits are not the same width. The falling edges are outside the rising edges, so the 1's are wider than the 0's.

Conclusion

In any transmission system, the input levels to the driver are one of many factors that will influence the quality of the signal out of the line receiver. This is true for any line driver, RS-422, LVDS, SCSI, etc. Keep in mind that the distortion evident in the Channel 2 waveform as shown in Figure 9 can be caused by several factors, and in some cases may not even be related to driver input levels. Also, remember that the Channel 2 waveform is the result of input levels ($V_{IH} = 3.5$ V) that are not even within specified limits.

Figure 9. Resistor divider input vs. standard input using eye patterns on serial data

