

THE
METALLURGY OF IRON AND STEEL.

NEW METALLURGICAL SERIES

EDITED BY

W. C. ROBERTS-AUSTEN, C.B., F.R.S.,

Chemist and Assayer of the Royal Mint; Professor of Metallurgy in the Royal College of Science.

In Large 8vo, Handsome Cloth. With Illustrations.

1. INTRODUCTION to the STUDY of METALLURGY.

By the EDITOR. THIRD EDITION, 12s. 6d.

"No English text-book at all approaches this in the COMPLETENESS with which the most modern views on the subject are dealt with. Professor Austen's volume will be INVALUABLE."—*Chemical News*.

2. GOLD (The Metallurgy of). By T. KIRKE ROSE, D.Sc.,

Assoc. R.S.M., F.C.S., Assist.-Assayer of the Royal Mint. 21s.

3. IRON and STEEL (The Metallurgy of). By THOMAS

TURNER, Assoc. R.S.M., F.I.C.

4. COPPER (The Metallurgy of). By THOMAS GIBB, Assoc.

R.S.M.

5. METALLURGICAL MACHINERY: the application of

Engineering to Metallurgical Problems. By HENRY CHARLES JENKINS, Wh.Sc., Assoc. R.S.M., Assoc. M.Inst.C.E., of the Royal Mint.

6. ALLOYS. By the Editor.

* * Other Volumes in Preparation.

LONDON: CHARLES GRIFFIN & CO., LIMITED, EXETER STREET, STRAND.

THE
METALLURGY OF IRON
AND STEEL.

BY

THOMAS TURNER,

ASSOCIATE OF THE ROYAL SCHOOL OF MINES; FELLOW OF THE INSTITUTE OF CHEMISTRY;
DIRECTOR OF TECHNICAL INSTRUCTION TO THE STAFFORDSHIRE
COUNTY COUNCIL.

*BEING ONE OF A SERIES OF TREATISES ON METALLURGY,
WRITTEN BY ASSOCIATES*

OF THE

ROYAL SCHOOL OF MINES.

CARNEGIE INSTITUTE OF TECHNOLOGY

LIBRARY

EDITED BY

Prof. W. C. Roberts-Austen, C.B., F.R.S.

VOL. I.—THE METALLURGY OF IRON.

WITH NUMEROUS ILLUSTRATIONS.

LONDON:

CHARLES GRIFFIN AND COMPANY, LIMITED;
EXETER STREET, STRAND.

1895.

[*All Rights Reserved.*]

P R E F A C E.

THIS book is one of a series of volumes written by Associates of the Royal School of Mines, and edited by Professor Roberts-Austen. It is not a merely elementary text-book on the one hand, or an exhaustive treatise on the other; nor does it cover the syllabus of any examining board. It is primarily intended for persons who are connected with the manufacture of iron and steel, and who may, therefore, be assumed to have already some general knowledge of the subjects discussed. At the same time, it is hoped that, with the growing importance of scientific and technical instruction in a modern liberal education, such a volume as the present may not be without interest to others than those for whom it was specially prepared.

The history of the manufacture of iron and steel is treated more fully than is usual in metallurgical treatises. It was thought that a brief history of the subject would not merely be of considerable educational value, but would assist the student in learning certain metallurgical facts in an interesting manner; and, while showing the steps by which modern achievements have been accomplished, would indicate to the would-be inventor some of the paths which have been already travelled.

The portions dealing with foundry practice and with the reactions of the puddling furnace have been dealt with in greater detail than usual, as the author has paid

special attention to these subjects, and has been frequently asked to publish his researches in a convenient form. A special chapter has also been devoted to the corrosion of iron and steel, as this subject is of great importance in connection with the permanence of modern structures.

Numerous references to original sources of information have been given throughout the volume, since it is of the utmost importance that the student should acquire the habit of obtaining for himself further information on subjects which can necessarily only be very briefly treated in a work which deals with so large a subject.

In these references a method has been adopted, which, it is hoped, will be convenient to general students, who may be assumed, in this instance, to reside chiefly in Yorkshire, South Wales, Cumberland, Staffordshire, the west of Scotland, and other places remote from the libraries of the metropolis or the older universities. It has also been assumed that references should be given primarily to help the student, and not to divert his attention to works or treatises of merely incidental interest.

For these reasons the *Journal of the Iron and Steel Institute* has been taken, as far as possible, as the standard of reference, since this journal not merely holds the leading position in connection with the metallurgy of iron and steel, but is widely circulated, and is to be found in all the leading provincial libraries. In other instances, references have been given to the *Journals of the Society of Chemical Industry*, the *Chemical Society*, and other English publications. From these the student will [be able to find at once either the original paper or an English abstract, with the necessary details from which the original can be traced. References to foreign

journals have been omitted as far as possible, although the author has himself consulted the originals.

The illustrations in this volume are reproduced from various sources. A considerable number are from photographs by the author, others are reproduced, by permission of the Council, from the *Journal of the Iron and Steel Institute*, while some have been borrowed from Phillips-Bauerman's *Metallurgy*, issued by the publishers of this book. Suitable acknowledgment has been made, in most instances, in the text accompanying such illustrations.

The author is indebted to Mr. MacMillan, Lecturer on Metallurgy at Mason College, and to Mr. MacWilliam, Metallurgical Lecturer to the Staffordshire County Council, for their kind assistance in the revision of the proofs.

THOMAS TURNER.

STAFFORD, *May*, 1895.

CONTENTS.

CHAPTER I.—THE EARLY HISTORY OF IRON.

	PAGE		PAGE
Prehistoric iron,	1	Blast furnace practice in 1686,	10
Iron in Egypt and Assyria,	2	Use of coke by Darby,	10
Iron in India, Greece, and Rome,	4	Huntsman's improvements in steel,	11
Early iron-making in Britain,	5	Improved machinery,	12
Introduction of cast iron,	6	Invention of puddling by Cort,	15
Iron working in Scotland,	8	Iron making at the beginning of the 19th century,	16
Growing scarcity of charcoal,	8		
Use of coke by Dud Dudley,	9		

CHAPTER II.—MODERN HISTORY OF IRON.

Invention of hot blast,	20	Development of the blast furnace,	28
Improved shape of blast furnace,	22	Subsidiary improvements in blast furnace practice,	30
Improvements in puddling,	24	Importation of non-phosphoric ores,	31
Manganese in steel melting,	25	Modern American blast furnace practice,	32
Use of blast furnace gases,	26		
Opening of the Cleveland district,	27		
Extended application of wrought iron,	27		

CHAPTER III.—THE AGE OF STEEL.

I. The Bessemer process,	35	II. Siemens' steel,	42
Bessemer's early life and experiments,	35	Early history of Sir W. Siemens,	42
The Bessemer process before the public,	37	The regenerative furnace,	43
Bessemer's difficulties,	38	Steel making in the regenerative furnace,	44
„ success,	39	Siemens' direct process,	44
„ steel boilers,	41	III. The basic process,	45
Steel rails,	41	Thomas and Gilchrist,	46
„ ships,	41		

CHAPTER IV.—CHIEF IRON ORES.

	PAGE		PAGE
What constitutes an iron ore, . . .	49	III. Carbonate ores, . . .	57
Classification of iron ores, . . .	50	(a) Spathic iron ore, . . .	57
I. Magnetites, . . .	51	(b) Impure carbonates, . . .	58
(a) Pure magnetites, . . .	51	1. Clay ironstone, . . .	58
(b) Impure magnetites, . . .	52	2. Cleveland ironstone, . . .	58
1. Franklinite, . . .	52	3. Blackband ironstone, . . .	59
2. Ilmenite, . . .	53	Chemical composition of iron ores, . . .	59
3. Chrome iron ore, . . .	53	Formation of iron ores, . . .	61
II. Ferric oxide or hæmatite, . . .	54	Geological distribution of iron ores, . . .	63
(a) Anhydrous, . . .	54	Phosphorus content and geological age, . . .	65
1. Specular iron ore, . . .	54	Spanish ores, . . .	66
2. Micaceous iron ore, . . .	54	Iron ores of the colonies, . . .	68
3. Kidney ore, . . .	55	Meteoric ores, . . .	69
4. Earthy ore, . . .	55		
(b) Hydrated oxides, . . .	56		
1. Goethite, . . .	56		
2. Limonite, . . .	56		

CHAPTER V.—PREPARATION OF IRON ORES.

Extraction of iron ores, . . .	70	Preparation of finely-divided iron ores, . . .	76
Preparation of ores, . . .	71	Weathering, . . .	77
Sizing, . . .	72	Calcination of iron ores, . . .	78
Concentration of iron ores, . . .	72	Roasting in open heaps, . . .	79
Washing, . . .	72	Calcining in kilns, . . .	80
Magnetic concentration, . . .	73	Roasting between closed walls, . . .	80
,, treatment of other ores, . . .	75	Calcining kilns, . . .	81
		Use of gaseous fuel, . . .	82

CHAPTER VI.—THE BLAST FURNACE.

Selection of site, . . .	85	Lifts or hoists, . . .	99
Arrangement of works, . . .	85	Collection of waste gases, . . .	100
Construction of the blast furnace, . . .	89	Dust catchers, . . .	102
Shape of the blast furnace, . . .	93	Handling of pig iron, . . .	104
Details of construction, . . .	95	Blowing in and out, . . .	105
Furnace hearths, . . .	96	Blast furnace practice in America and in the United Kingdom, . . .	105
Wear of linings, . . .	98	Production of cast iron in Styria, . . .	107
Carbon linings of furnace hearths, . . .	98		

CHAPTER VII.—THE AIR USED IN THE BLAST FURNACE.

	PAGE		PAGE
Blast engines,	110	Temperature of the blast,	125
Theory of the hot blast,	112	Pyrometers,	125
Limit to the advantages of hot blast,	113	Twyers,	128
Methods of heating the blast,	114	Scotch twyer,	128
Gas-fired regenerative stoves,	118	Staffordshire twyer,	129
The Cowper stove,	118	Open twyer,	130
The Whitwell stove,	122	Effect of moisture in the blast,	132

CHAPTER VIII.—REACTIONS OF THE BLAST FURNACE.

Materials employed,	133	Scaffolds,	147
The ascending current in the blast furnace,	134	Reduction of phosphorus,	148
Combustion in the hearth,	134	„ silicon,	149
Upper zone of reduction,	135	„ manganese,	150
Other reactions of carbon monoxide,	137	„ sulphur,	150
Lower zone of reduction,	138	Sulphur and manganese,	151
Hydrogen in the blast furnace,	139	Composition of the waste gases,	152
The descending current in the blast furnace,	140	Utilisation of blast furnace gases,	153
Cyanides in the blast furnace,	141	Recovery of tar and ammonia from blast furnace gases,	154
Reduction in charcoal furnaces,	142	I. (a) Alexander and M ^c Cosh process,	154
Temperatures of the blast furnace,	143	(b) Dempster,	155
Descent of the charge in the blast furnace,	144	(c) Henderson,	155
		II. (a) Neilson,	155
		(b) Addie,	155

CHAPTER IX.—ON THE FUEL USED IN THE BLAST FURNACE.

Blast furnace coke,	157	Thermo-chemical calculations of fuel required,	164
Use of coal in blast furnaces,	158	Duty of fuel used,	166
Anthracite,	159	Low fuel consumption in coke furnaces,	167
Bituminous coal,	159	Carbon transfer,	168
Splint coal,	159	Effect of working conditions,	169
Brown coal,	160	Speed of working and economy,	170
Charcoal,	161	Consumption of fuel in charcoal furnaces,	170
Use of gaseous fuel in the blast furnace,	162	Theoretical minimum fuel consumption,	172
Consumption of fuel in the blast furnace,	163		

CHAPTER X.—SLAGS AND FLUXES OF IRON SMELTING.

	PAGE		PAGE
Appearance of blast-furnace slags,	175	Calculation of furnace charges,	180
Disposal of slag,	175	Alumina in slags,	183
Composition of blast-furnace slag,	177	Ore mixtures and self-fluxing ores in furnace working,	183
Utilisation of slag,	178	Limestone,	185
Paving blocks,	180	Use of lime in the blast furnace,	186
		Smelting of puddling cinder,	188

CHAPTER XI.—THE PROPERTIES OF CAST IRON.

General properties,	189	Distribution of sulphur in cast iron,	202
Carbon in cast iron,	189	Phosphorus in cast iron,	202
Separation of graphite,	191	„ in foundry practice,	203
Carbon in foundry iron,	191	Manganese,	204
Silicon in cast iron,	192	Chromium in cast iron,	205
„ in foundry practice,	195	Vanadium,	207
Economical use of silicon,	196	Reduction of titanium,	208
Condition of silicon in cast iron,	197	Arsenic,	210
Distribution of silicon,	198	Grading of pig iron,	211
Aluminium,	198	„ American pig iron,	213
Sulphur,	200	Special irons,	214
Removal of sulphur by alkalis,	201		

CHAPTER XII.—FOUNDRY PRACTICE.

Foundry mixtures,	217	3. Loam moulds,	227
Special „ „ „ „ „	218	4. Chills,	227
Stirling's toughened cast iron,	218	Moulding sand,	228
Sort mixtures,	221	Effect of size and shape,	229
Remelting,	221	Shrinkage of cast iron,	230
1. The crucible (or pot) furnace,	221	Hardness of cast iron,	232
2. The reverberatory (or air) furnace,	221	„ and strength of cast iron,	233
3. The cupola,	222	Crushing strength,	234
Influence of remelting,	224	Transverse „ „ „ „ „	235
Moulds,	226	Tensile „ „ „ „ „	236
1. Green-sand moulds,	226	Keop's tests for foundry iron,	239
2. Dry-sand moulds,	227	Malleable cast iron,	241

CHAPTER XIII.—WROUGHT IRON.

	PAGE		PAGE
Definition,	244	Fuel,	249
Direct production of wrought iron,	244	Small blast furnaces,	250
I. Hearths,	245	III. Tall blast furnaces,	252
Catalan process,	245	Husgafvel process,	254
American bloomery,	246	IV. Retorts,	256
Reactions,	247	Chenot process,	256
II. Small blast furnaces,	248	Blair process,	257
The Osmund furnace,	248	Adams (or Blair-Adams) process,	258
Small blast furnaces in India,	249	V. Reverberatory furnaces,	260
Ore supply,	249	Siemens' rotating furnace,	260
		Eames' direct process,	261

CHAPTER XIV.—INDIRECT PRODUCTION OF WROUGHT IRON.

Classification of processes,	263	II. Reverberatory furnaces,	271
I. Hearths,	264	(1) Dry puddling,	271
(1) The Styrian open hearth,	264	The refinery,	272
The process,	266	(2) Modern puddling process,	274
Open hearths for wrought iron,	267	Oxidation in puddling,	276
The Franche-Comté process,	268	Best Yorkshire iron,	278
(2) The South Wales process,	269	Manufacture of Russian sheet iron,	279

CHAPTER XV.—THE PUDDLING PROCESS.

Arrangement of the works,	281	Causes of loss,	301
The puddling furnace,	281	Deficiency of cinder,	302
Anderson's puddling furnace,	284	Elimination of phosphorus,	303
Fettling,	285	" sulphur,	304
(1) Fusible,	285	Other elements in puddling,	305
(2) Moderately fusible,	286	Use of lime in "	305
(3) Infusible,	286	Fuel used in the puddling furnace,	306
Pig iron for puddling,	287	The calorific efficiency of the puddling furnace,	307
Preparation of the furnace,	289	Siemens' puddling furnace,	309
Details of working,	290	The Springer furnace,	309
Physic,	292	The Pietzka "	309
Best Staffordshire iron,	292	Mechanical puddling,	310
Reactions of the puddling furnace,	293	1. Mechanical stirrers,	311
Theories of puddling,	295	2. Furnaces, beds rotating vertically,	311
1. The magnetic oxide theory,	295	3. Furnaces, beds rotating horizontally,	313
2. The ferric oxide theory,	296	Bibliography,	313
Varieties of tap cinder,	297		
Constitution and reactions of puddling cinder,	299		

CHAPTER XVI.—FURTHER TREATMENT OF WROUGHT IRON.

	PAGE		PAGE
Production of puddled bars,	315	Effect of repeated reheating of iron,	328
Helves,	315	Sections of finished iron,	329
Squeezers,	316	Imperfections in finished iron,	329
Steam hammers,	317	(a) Rough edges,	329
Reheating puddled iron,	319	(b) Spilly places,	329
Rolls,	321	(c) Blisters,	330
Waste in reheating iron,	324	Rolling steel,	330
1. Crop ends,	324	Physical properties of wrought iron,	330
2. Oxidation,	325		
3. Nature of bottom,	325		
4. Quality,	326		

CHAPTER XVII.—CORROSION OF IRON AND STEEL.

Rusting,	334	Protection of iron and steel,	346
Causes of rust,	335	1. Wood or solid materials,	346
Varieties of rust,	337	2. Coating of magnetic oxide of iron,	346
Relative corrosion of iron and steel,	338	3. Metallic coatings,	347
Galvanic action of iron and steel,	339	(a) Copper,	347
Effects of scale on corrosion,	341	(b) Nickel,	347
Corrosion in the presence of diluted acids,	342	(c) Tin,	347
Removal of rust,	343	(d) Zinc,	348
Action of acids on iron and steel,	343	4. Tar or pitch,	349
		5. Oils, paints, and varnishes,	349
		6. Enamels,	350
		7. Japans,	351

LIST OF ABBREVIATIONS USED IN THE REFERENCES.

For convenience of reference abbreviations have been employed for the title of the Transactions, Journals, or other official publications of the following Societies :—

Abbreviation.	Society.
<i>B. A. Report</i> ,	British Association for the Advancement of Science.
<i>Birm. Phil. Soc.</i> ,	Birmingham Philosophical Society.
<i>Inst. C. E.</i> ,	Institution of Civil Engineers.
<i>Inst. Cleveland Eng.</i> , . .	Institution of Cleveland Engineers.
<i>Inst. Journ.</i> ,	Iron and Steel Institute.
<i>Inst. M. E.</i> ,	Institution of Mechanical Engineers.
<i>Journ. Chem. Soc.</i> , . . .	Chemical Society of London.
<i>J. S. C. I.</i> ,	Society of Chemical Industry.
<i>S. S. Inst.</i> ,	South Staffordshire Institute of Iron and Steel Works Managers.

In the occasional references to other journals the abbreviations used are, as far as possible, those in general use, and do not call for special comment.

THE METALLURGY OF IRON AND STEEL.

CHAPTER I.

THE EARLY HISTORY OF IRON.

Prehistoric Iron.—The flint instruments which have from time to time been discovered in different localities, and which are now preserved in thousands in the museums of this and other countries, afford ample and indisputable evidence of a time when metals were either entirely unknown, or when they were so little known as not to be usefully applied. Among the stone implements so preserved are knives, chisels, arrow-heads, saws, hammers, and numerous other instruments which could have been much more readily made in metal if the workmen had possessed the necessary metallurgical skill. But as primitive man continued his observations he gradually acquired the art of reducing the less refractory metals from their ores, and thus copper, hardened with a small proportion of iron, arsenic, or tin, came to be generally employed for those purposes for which flint had been previously used, and it was probably not until the bronze age had lasted for a considerable period that the use of iron became general.

We can only conjecture as to the period in which iron was first extracted from its ores and applied to the use of man. There is, however, little doubt that it was known and prized in prehistoric times, and, in the case of iron, there are special reasons for care in attempting to fix a date to its first application. That iron rusts in moist air is a fact of everyday observation, and that this process of oxidation gradually proceeds throughout the whole mass of metal is well known. On the other hand, flint is unaltered by atmospheric influences, while bronze is, under favourable conditions, very slowly attacked. If then implements of these substances were buried in the earth, and allowed to remain for a lengthened period, it is quite

possible that the flint would remain practically unaltered, and the bronze be little changed, while the iron would be converted into a brown mass of hydrated oxide, cementing together some pebbles; or even, if the drainage water contained vegetable matter, this cement might itself be washed away, and nothing whatever remain to indicate that iron had been originally there. For this reason, while the presence of metallic iron in some instances may be proof positive that the metal was known at an early period, the absence of the metal would be much less conclusive in proving a negative. It is interesting to note that on the site of the Swiss lake dwellings, which were of prehistoric age, articles of stone, bronze, and iron have been found together, and Sir C. Lyell points out that the stone, bronze, and iron ages are not definite periods in the history of the human race as a whole, but stages in the development of particular tribes or nations.

Frequent references to the use of iron occur in the early books of the Old Testament, the earliest being in Genesis, chap. iv. verse 22, in which Tubal-cain is referred to as "an instructor of every artificer in brass and iron."

Iron in Egypt and Assyria.—The most ancient specimens of brass and iron at present known were obtained by Egyptian and Assyrian explorers, and a number of such articles are preserved in the galleries of the British Museum. Examination of these specimens is sufficient to show that the Egyptians were acquainted with the use of iron 4,000 years ago, and possibly at a still earlier date. The ancient Egyptian artificer used saws, chisels, adzes, drills, and bradawls of bronze, and it was not until a comparatively late period that instruments of iron became common. At the same time, there are specimens of iron extant which are of equal, or even greater, antiquity than the most ancient bronzes known. Thus a small hollow "bronze" cylinder in the British Museum, inscribed with the name and titles of Pepi I., B.C. 3233, is, if contemporary, probably one of the oldest bronze objects extant, and among the oldest Egyptian bronze tools now known is an axe head of about B.C. 1750. But in the same case as the two bronze articles just mentioned is an iron axe head of the date B.C. 1370, and in a case in the same room is to be seen the oldest piece of iron known, and which is believed to date from B.C. 3733. This specimen was found in one of the air passages of the great pyramid at Gizeh; it is a thin flat irregular wedge-shaped piece of iron, not more than 9 inches long, and less than 3 inches broad; its use is doubtful, but if it be of the same date as the pyramid, as there seems reason to believe, this specimen is not only the most ancient example of iron known, but it is even older than the earliest bronze.*

* *Guide to the British Museum*, 1890, pp. 120-123.

It is worthy of notice that many of the earlier "bronzes" consist of copper usually hardened by the addition of cuprous oxide, of iron, or of arsenic, probably introduced by a crude method of working which was accidentally discovered to give the best results, and that the use of tin was of a later date. Thus Pepi's cylinder, above-mentioned, has been found by Berthelot to consist of copper,* while Dr. Gladstone found on analysing tools discovered by Petrie in Egypt and Bliss in Palestine that some of the earliest of these, obtained from Meydum, and dating from 2500 B.C. to 3500 B.C., consisted of copper, while a tool from Lacish of about 1500 B.C. was copper hardened with about 25 per cent. of cuprous oxide. In the latter place, in remains dating from 1400 B.C. to 800 B.C., many objects of bronze occurred, while in the later Israelitish portion these were gradually replaced by iron. It should, however, be recorded as indicating the antiquity of tin, that a rod of bronze containing 9 per cent. of tin was found at Meydum with the specimens, dating from about 3500 B.C.†

Though the earliest examples of iron were thus obtained from Egypt, it was probably in Assyria that this metal was first freely used for the production of tools, weapons, and ornaments. It is known that Tiglath-Pileser used iron weapons for the chase as early as B.C. 1100, but the most complete and beautiful collection of iron instruments from Assyria was brought by Layard from the ruins of Nimroud, and are now in the British Museum. These include fragments of a sword blade, and a considerable portion of a large double-handed saw, 44 inches long and 4½ inches wide, such as is used in country places by sawyers even at the present day. These instruments afford evidence both of the possession of fairly large quantities of iron, and of considerable skill in the processes of iron manufacture. But perhaps even more interesting is a series of specimens of ornamental objects which were produced by casting bronze around a core of iron. Here the artificer was apparently aware that iron was stronger and less fusible, but more perishable, than bronze, and the iron was employed inside to impart strength, while the bronze was used outside to take the required impression and to resist atmospheric influences.‡ The application of two metals combined in this manner indicates a very considerable progress in metallurgical knowledge, and this is still more remarkable when it is remembered that at this period, about 880 B.C., the inhabitants of western and northern Europe used nothing but stone or wooden implements, while the bronze age was only slowly spreading over the southern and central portions of the Continent.§

* *Ann. Chem. et Phys.*, vol. xvii., 1880, p. 507.

† *B. A. Report*, 1893, p. 715. See also Berthelot, *J. S. C. I.*, 1894, p. 1198.

‡ *Guide to the British Museum*, 1890, pp. 130-141. § Percy, p. 874.

Iron in India, Greece, and Rome.—Probably about this time the art of iron-making was carried eastward into India, as the inhabitants of that part of the world were well versed in the manufacture of iron centuries before the Christian era. The famous iron pillar at Kutub, near Delhi, stands 22 feet above the ground, and its weight is estimated to exceed 6 tons. It consists of malleable iron of great purity, and was probably made about A.D. 400, by welding together discs of metal. So great a forging at this period indicates a remarkable skill among the early iron workers of India which has not survived to the present day. The Greeks were also familiar with the uses of iron 600 years before the Christian era, though their shields and weapons were of bronze, and iron was so rare and valuable that sufficient for the production of a ploughshare was bestowed as a prize upon the winner at their annual games. Iron was discovered by Schliemann in the ruins of Mycenæ, which was destroyed B.C. 561, and that the Greeks were familiar with meteoric iron is evident, since *sideros*, which has given the word "sideral" to the English language, has also supplied the French term for the metallurgy of iron.

It was not, however, until the Roman Empire was firmly established that the use of iron became general over civilised Europe. From the writings of Pliny, in the early part of the first century, it is evident that among the Romans iron was freely used in agriculture, war, and for a multitude of other purposes. Pliny's account of the use of iron is very complete, and is interesting, not only from the fact that he mentions the chief localities from whence iron was then obtained, describes the character of the ores, and gives an indication of the method of extraction, but more particularly because of the very evident knowledge which he possessed of the difference between wrought iron and steel. Pliny describes not only the hardening of steel by quenching in water, but also the use of oil for hardening, and he appears to have been quite familiar with the difference of the results obtained in the two cases. At this time also the Roman smiths used iron for hinges, nails, chains, bolts, keys, locks, and similar purposes, while they employed steel for swords, razors, scissors, and edge tools. In fact, so highly did the Romans value the importance of working in iron and steel that they established public forges or shops at various camps and cities throughout the empire.*

For several centuries before the beginning of the Christian era iron had been produced in what is now known as Styria and Carinthia. The product, known as "noric" iron, was famed for its excellent quality, and is referred to in the writings of various classical authors. The iron of Styria is obtained from ore extracted from the Erzberg, or "ore mountain," a bedded deposit

* Scrivenor, *History of the Iron Trade*, pp. 12-18, 28-29.

of enormous size which has been worked for upwards of 2,000 years with but little effect in reducing the supply of ore. This district, in which some very primitive processes are still conducted, is probably the most ancient seat of the manufacture of iron in the civilised world in which the industry still flourishes, and thus Styria furnishes an interesting link connecting the present with the remote past. The records now in existence only go back to the twelfth century, as a fire in 1618 destroyed documents carrying the history back to A.D. 712, but even this date, early as it is, is late in the history of the iron industry of the Erzberg.*

Early Iron-making in Britain.—The ancient Britons were acquainted with the use, and probably also with the production of iron some centuries before the Roman invasion under Julius Caesar, in B.C. 55; for at that time they had swords, spears, scythes, and hooks of iron, while the metal was also used in mining, for agricultural purposes, and for export.

During the Roman occupation of Britain, the manufacture of iron and steel was conducted on a very considerable scale, for a large military forge was erected at Bath, and supplies of iron were obtained from the Forest of Dean, from South Wales, from Yorkshire, and from other parts of the country. The remains of Roman cinders, rich in iron, have been found in many parts of the United Kingdom, particularly in the Forest of Dean. In this locality the cinders had accumulated in such quantities, and were so rich in iron, that it is stated that, in more recent times, for some 300 years this material was smelted in the blast furnace for the extraction of iron. The enormous quantities of such cinders left by the Romans indicate how extensive the manufacture of iron must have become during the Roman occupation. The brown hæmatites of the Northamptonshire district were also worked on a considerable scale during the same period; † while discoveries made by J. Storrie in 1894, on the site of Roman iron forges near Cardiff, seem to show that manganiferous ores were imported in these remote days from Spain for the purpose of steel making.

Little is known regarding the production of iron in this country under the Saxons. The chaotic condition of the government during the centuries immediately succeeding the Roman departure was unfavourable to the progress of the industrial arts, and it was not until the close of the Saxon period that the iron trade began once more to flourish, so that, at the Norman Conquest, Gloucester had a considerable trade in iron, obtained from the Forest of Dean, and was renowned for its forgings. But under the Normans the iron trade again declined, and the metal became a comparatively rare and costly material, so that

* Korb and Turner, *S. S. Inst.*, 1889, p. 4.

† Phillips, *Ore Deposits*, p. 172.

the Scots, in a predatory expedition in the tenth year of the reign of Edward II., "met with no iron worth their notice until they came to Furness, in Lancashire, where they seized all the manufactured iron they could find, and carried it off with the greatest joy, though so heavy of carriage, and preferred it to any other plunder."* While, in the reign of Edward III., the pots, spits, and frying-pans of the royal household were classed among the royal jewels.

The chief seats of the iron trade in England during the Middle Ages were the weald of Kent and Sussex, the Forest of Dean, and Rockingham Forest, in Northamptonshire. The manufacture was also conducted in other localities, though on a smaller scale, and chiefly for local consumption. The Abbey of Flaxley was founded in 1140, and for more than five centuries the iron trade established by the monks of Flaxley appears to have been carried on in almost any part of the Forest of Dean, where the necessary ore and charcoal could be obtained, and where a running stream supplied the power required to produce the blast. Throughout the Northamptonshire district, also, there are still to be found large accumulations of slag, which is dark in colour, heavy, compact, and rich in iron.†

INTRODUCTION OF CAST IRON.

Throughout the long interval between the Norman Conquest and the beginning of the Tudor period, the iron manufacture of these islands was comparatively insignificant; the chief supplies were imported from Germany, and it is to German metallurgists that we look for the dawn of a new era, which was destined not only to largely extend the use of iron and steel, but to give to the world a new kind of iron, which has ever since been of the utmost importance. Hitherto iron had always been produced in some very simple kind of open hearth, or in a very small blast furnace, and it had been reduced directly from the ore in a single operation. The product had been either wrought iron or steel, as the case might be, according to the details of the operation; but cast iron had not been produced, or if it had been accidentally made, its use was unknown. The German *Stückofen*, or small blast furnace, is shown in Fig. 1. Such a furnace was built of masonry, and consisted of two truncated cones placed base to base, while the front of the hearth was made with a thin wall, which was taken down at the end of the operation, so as to permit the removal of the bloom of wrought iron. Such a furnace would have a maximum diameter of about 5 feet, and would not exceed 15 feet in height. But now

* Scrivenor, p. 31.

† Phillips, *Ore Deposits*, pp. 156, 172.

German metallurgists, in their endeavours to save fuel and reduce the cost of manufacture, introduced blast furnaces of gradually increasing size; and by allowing the metal to remain longer in contact with the fuel the iron became carburised, and was obtained in the fluid condition. Previously iron had only been produced in the solid, or, at most, in the pasty form, even at the highest attainable temperatures, and when any large object or intricate form was required, it could only be obtained by laborious forging. But when the production and properties of cast iron were once understood, metallurgists had at their disposal what was practically a new metal, capable of being readily

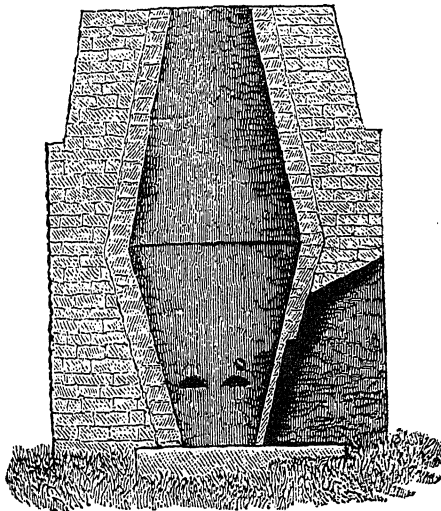

Fig. 1.—German Stückofen.

cast into any desired size or shape. It is believed by Lower that cast iron was made in Sussex about 1350, and soon afterwards the art of ironfounding was understood on the Continent; it was introduced into England about the year 1500; the first cast-iron cannon produced in the United Kingdom was made by Ralph Hogge in 1543, while such progress had been made by 1595 that cannon weighing 3 tons each were produced.*

A recently discovered inventory of the cannon belonging to the Prince of Hessen in 1544, shows that he possessed a large number of cast-iron guns at that date.

But the use of cast iron was not restricted to foundry purposes, for it was argued that, as by one application of the purifying influence of fire the crude metal had been extracted

* Percy, *Iron and Steel*, p. 379.

from the ore, so by a further application of the same purifying agency the crude metal might be converted into malleable iron. Thus wrought iron came to be made from cast iron by an indirect process in small fineries, and the blast furnace took the position it has so long held, and which it appears likely still to retain, as the first step in the manufacture of iron and steel.

Iron Working in Scotland.—The manufacture of iron in Scotland had its rise in the vicinity of Loch Maree, Ross-shire, towards the end of the sixteenth century. Previous to this time much of the iron used in Scotland had been imported, while the residue was made for local consumption in primitive forges scattered through the country. In 1609, Sir George Hay started iron works at Letterewe, on Loch Maree, at which local bog ore was smelted with charcoal, while workings at Fasagh, in the same neighbourhood, were commenced some years earlier. These latter works contained at least one blast furnace, and two hearths, so that both cast and wrought iron were produced, while the necessary power was obtained by means of a water-course; in all probability the workmen in this instance were Englishmen who had been brought to Ross-shire by Sir George Hay to start the industry. The site of the Fasagh works has been explored and illustrated by J. Macadam,* and was visited by Drs. Tilden and Thorpe in 1892. Specimens of wrought iron left by the ancient workers were analysed, and found to have the following composition† :—

	Tilden and Brown.	Thorpe and Dougal.
Carbon,	·140	·192
Silicon,	·047	·077
Sulphur,	traces	·012
Phosphorus, . . .	·247	·087
Manganese, . . .	·08	·038

The sample examined by Mrs. Dougal was also submitted to physical and mechanical tests, which showed that this material was nearly, if not quite, equal to the metal made by modern methods, despite the fact that it was produced so long ago, from relatively poor ores, and by comparatively crude processes. Iron making was continued in Ross-shire for a considerable period, but the industry was gradually transferred to other districts, as the supply of wood was exhausted.

Growing Scarcity of Charcoal.—With the introduction of Continental methods of manufacture into England, the trade of

* *Trans. Inverness Sci. Soc.*, 1893, vol. iii., p. 222.

† *Birm. Phil. Soc.*, 1894, vol. i., p. 48; *J. Chem. Soc.*, 1894, vol. lxx., p. 749.

this country revived, and at the end of the sixteenth century, in the reign of Elizabeth, it had assumed very considerable proportions, particularly in Sussex, but also in Staffordshire, in Yorkshire, and some other parts. With this increase of trade, a new and unexpected difficulty presented itself. Hitherto the only fuel used in the iron furnaces had been charcoal, which, so long as England was well wooded and the trade was small, had been obtained without difficulty. But with a largely increased trade in iron, and a greater demand for timber for shipbuilding and other purposes, the supply of timber was insufficient, and in order to prevent the wholesale destruction of the remaining timber, various Acts of Parliament were passed in the reign of Elizabeth, in the years 1558, 1562, 1580, and 1584, restricting the number and position of the iron works, and prohibiting the erection of new works in certain districts. Suffering from this absence of fuel, it is not to be wondered at that the iron trade again languished, and in the middle of the eighteenth century it was considered necessary to pass Acts of Parliament to encourage the importation of iron into the United Kingdom.

Use of Coke by Dud Dudley.—The great scarcity of charcoal directed attention to the use of pit coal as a substitute in the manufacture of iron. The first successful attempt in this direction was due to Dud Dudley, a natural son of Edward, Earl of Dudley, who was the owner of several iron works in the neighbourhood of Dudley. Dud Dudley came from College at Oxford, at the age of twenty, in the year 1619, to superintend his father's works, and after some preliminary trials succeeded in preparing coke from Staffordshire coal, and by the use of this coke he produced pig iron in the blast furnace. By the influence of the Earl of Dudley a patent was obtained from King James I. for carrying on the invention, and Dud Dudley successfully made iron from pit coal for a number of years, but the misfortunes which arose from the civil war, from a flood, and from opposition of other iron masters caused the manufacture to be abandoned, and for nearly a century the matter was allowed to rest, while the iron trade sank to its lowest ebb.

When Dud Dudley was well advanced in life he published an account of his invention and of his misfortunes under the title of *Metallum Martis*; this very interesting volume has been republished in the original form by Longmans & Co., London, and we are thus able to obtain an insight into the general arrangement of an iron works of that period. As a supply of charcoal was necessary for carrying on the manufacture, the works were always situated in the neighbourhood of large woods or forests, the furnaces were small, and built of masonry, being usually strengthened by the use of large oak beams, such as were used in the construction of the half timbered houses of that period, the blast was produced by the use of bellows, driven

by water wheels, which were introduced about 1600, and the works were situated at the side of a running stream, the production of cast iron did not exceed a maximum of 100 tons per week, and was frequently less than half this amount. The furnaces did not work more than ten months in the year. It was usual for the pig iron to be converted into wrought iron at the same works, in small hearths, and, as the use of the blast furnace had not yet been introduced, the blooms were hammered into wrought iron probably by water power. As the production of each ton of iron was so small it was necessary to have a number of furnaces scattered throughout the country, and it is not surprising to learn that early in the reign of James I., when the trade was at its best, there were upwards of 800 furnaces, forges, and the United Kingdom.

Blast Furnace Practice in 1686.—The following description is given by Dr. Plot, written in 1686,* describe the form and mode of working a blast furnace at that time:—"When they have their ore before it is fit for the furnace, they burn or calcine it upon the ground, with small charcoal, wood, or seacoal, until it break into small pieces, which will be done in three days; this they call annealing it or firing it for the furnace. In the meanwhile they also heat their furnace for a week's time with charcoal, without blowing it, which they call seasoning; then they bring the ore to the furnace thus prepared, and mix it in with the charcoal in baskets—*i.e.*, a basket of ore and a basket of coal. Two vast pairs of bellows are placed on each side of the furnace and compressed alternately by a large wheel turned by water, the fire is made so intense that after three or four days the metal will begin to run; still after increasing until at the end of fourteen night's time they can run a sow and pigs once in three hours, which they do in a bed of sand before the mouth of the furnace." . . . "The hearth of the furnace into which the metal and the coal fall is ordinarily built square, the sides descending obliquely and drawing near to one another like the hopper of a mill; where these oblique walls terminate, which they call boshes, there are set four other stones, but these are set perpendicular, and reach to the bottom stone, making a square perpendicular stone that receives the metal."†

A series of three drawings of German blast furnaces have been published by Professor Ledebur, who remarks that these furnaces differ but little from those in use a century or two earlier.‡

Use of Coke by Darby.—The production of pig iron from coke is so simple in principle, and has so long been the best method of procedure, that it is now somewhat dif-

* *Natural History of Staffordshire*, p. 161.

† *Ibid.*, p. 162.

‡ *Stahl und Eisen*, vol. xi., p. 219.

understand how the idea was allowed to remain so long in abeyance after the death of Dud Dudley. But the matter was revived in 1713 by Abraham Darby, at Colebrook Dale, in Shropshire, and after much perseverance and labour, his son, also named Abraham Darby, succeeded in the attempt. The experiment is thus described by Dr. Percy—"Between 1730 and 1735 he determined to treat pit coal as his charcoal burners treated wood. He built a fireproof hearth in the open air, piled upon it a circular mound of coal, and covered it with clay and cinders, leaving access to just sufficient air to maintain slow combustion. Having thus made a good stock of coke, he proceeded to experiment upon it as a substitute for charcoal. He himself watched the filling of his furnace during six days and nights, having no regular sleep, and taking his meals at the furnace top. On the sixth evening, after many disappointments, the experiment succeeded, and the iron ran out well. He then fell asleep in the bridge house at the top of his old-fashioned furnace, so soundly, that his men could not wake him, and carried him sleeping to his house a quarter of a mile distant. From that time his success was rapid."

Darby's success rendered available for the purposes of the iron-master the greater part of the coal supply of this country, doing away with the necessity for the use of charcoal for the production of cast iron, and laying the foundation of that pre-eminent position in the iron trade of the world which Britain so long enjoyed.

The use of coke now spread rapidly in the United Kingdom, for Darby's practical success was achieved but little before 1740, in which year there were only 59 blast furnaces in England and Wales, while the average weekly output per furnace was slightly under 6 tons. But half a century later, in 1790, the number of furnaces had increased to 106, of which 81 used coke, and only 25 used charcoal. At the same time, owing chiefly to the employment of improved machinery, the weekly yield had increased to slightly over 10 tons per week in charcoal furnaces, and over 17 tons per week in furnaces using coke.*

Huntsman's Improvements in Steel.—But as the commercial position of Great Britain is not due to any single industry, so the development of the iron trade did not depend upon one invention, great as was the importance and far-reaching character of this change introduced by Darby. The cutlery trade of the country had not yet assumed any considerable proportions, and much of the best steel was imported from Germany. It is doubtful when the process of cementation was first introduced for the production of steel for tools and cutlery, but that it has been known for some centuries is beyond doubt; it was described by Reaumur in 1722, and was in use in Sheffield

* Scrivenor, pp. 57, 359-361.

at the period of which we are speaking. About the same time that Darby succeeded in his experiments, a clockmaker at Doncaster named Huntsman had his attention directed to the need of a more uniform quality of steel than could be produced by cementation. After many unsuccessful efforts, he obtained the desired result by breaking the bars of cemented or "blister" steel into small pieces, selecting them according to the desired purpose, and melting the steel in clay crucibles. He removed to Handsworth, near Sheffield, in 1740, where he erected works and conducted the operation with great precautions to ensure secrecy for a number of years, and Huntsman's steel was in the highest repute; but at length his competitors obtained a knowledge of the process by dishonourable means, and many other steel manufacturers adopted it.* Thus the present method for the production of steel of the best quality for tools and cutlery was introduced, and Sheffield rapidly developed, though the production of pig iron in this country was not increased by this change, since the iron used for steel making was of special quality, and was imported from Russia and Sweden. An interesting illustrated account of Huntsman's discovery has been recently given by R. A. Hadfield.†

Improved Machinery.—The great improvements effected in the construction of the steam engine by Watt, about the year 1768, not only caused a considerably increased demand for iron but also gave to ironmasters a source of power, of which they were not slow to avail themselves. The earliest application of the steam engine in iron making was by Wilkinson for the production of blast for the blast furnace. The first blowing cylinders, driven by water, had been erected by Smeaton at the Carron Iron Works, in Scotland, in 1760,‡ and the days of leather bellows, driven by water power, were over. At first Newcomen "fire" engines were used, but these soon gave way to the condensing engine of Watt, and by about 1790 these had come into pretty general use. With the increased pressure of blast thus obtained, the furnaces drove more rapidly, and the production per furnace increased. About this time, also, steam engines of the improved pattern were introduced into the mills and forges of Great Britain, as with the rapidly increasing volume of trade, and the improvements in the mechanical arrangements for working wrought iron, water power was found to be quite inadequate. In early times bars or rods of iron were produced by the tedious process of hammering; the smallest bar that could be made by this method was $\frac{3}{4}$ inch square, and all smaller sizes were cut in the splitting mill. Plates and sheet

* Jeans, *Steel*, p. 16.

† *Inst. Journ.*, 1894, vol. ii., p. 224.

‡ For a description of these blowing cylinders, and of the increased yield resulting from their use, see Scrivenor, pp. 83-85 and 91.

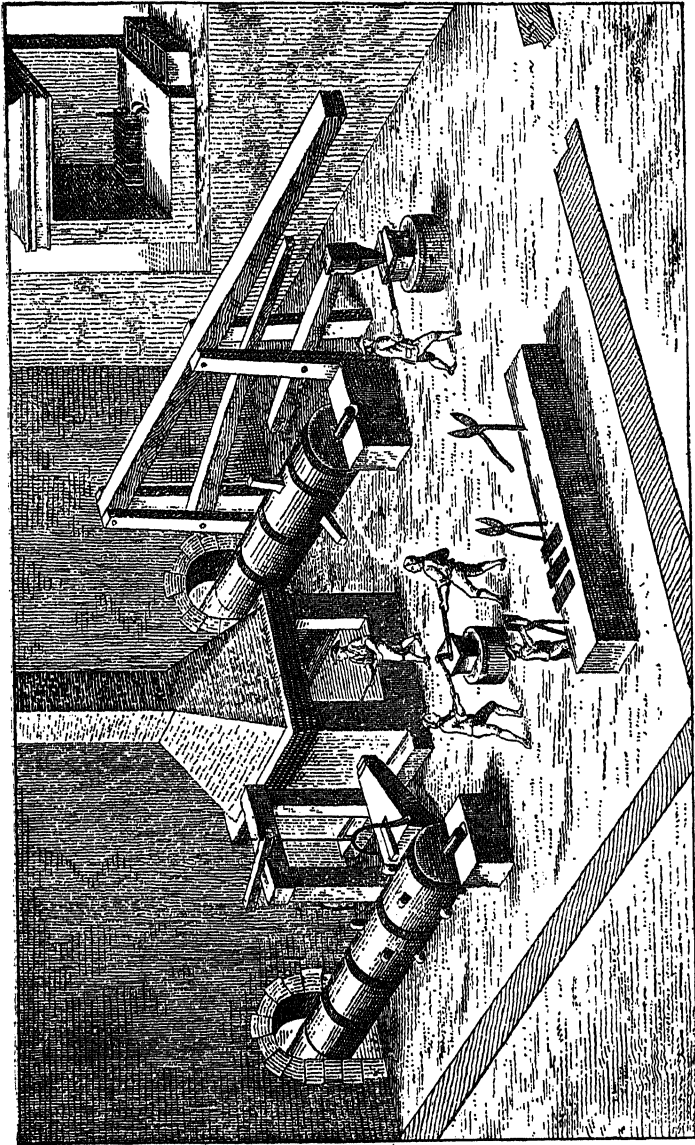

Fig. 2.—Manufacture of sheet iron in 1714.

were also produced by hammering, at first entirely by hand, but afterwards by water power, as shown in Fig. 2, taken from a paper by P. W. Flower on the "Manufacture of Tin Plates."* In this illustration, representing the manufacture of sheet iron in 1714, are shown two pairs of bellows worked by water power, and supplying blast to a charcoal hearth used for heating the iron to be treated; while on the other side of the hearth, also actuated by water power, is seen the hammer used for producing the rough plates, which were apparently finished by hand on a small anvil. But in 1720 the tin plate manufacture was started at Pontypool by Major Hanbury, who in 1728 introduced the process of sheet iron rolling, or, as it was then described, "the art of expanding bars by compressing cylinders." This mill was driven by water power, and had plain rolls.

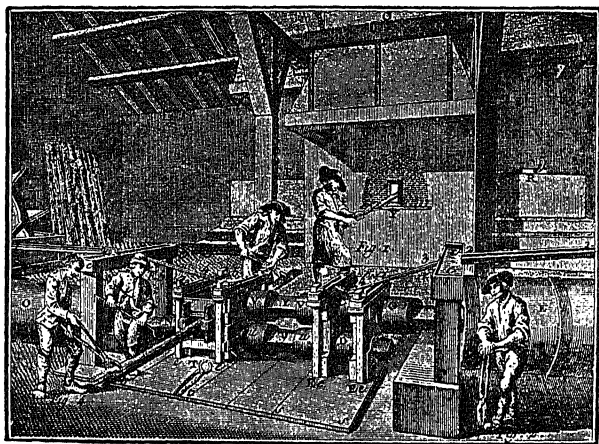

Fig. 3.—Bar mill, 1760 (French).

In Fig. 3, which is taken from a paper by B. H. Thwaite,† is shown a train of rolls as used for rolling bars in France in 1760. It will be seen that the rolls were driven by a water wheel connected with wooden shafting of large diameter; the rolls themselves were small and plain—*i.e.*, their surface was plain and smooth like that of a sheet roll, and hence only flat bars with imperfect edges could be rolled in such a mill. The metal was heated, before rolling, in the closed furnace shown behind the rolls, while the rolls themselves were kept cool by allowing a stream of water to run over them.

* *Inst. Journ.*, 1886, vol. i., p. 36.

† *S. S. Inst.*, 1893.

The use of grooved rolls was patented by Cort in 1783, and this marks a great advance in the mechanical treatment of wrought iron, since, by a single operation, a long bar can be quickly and cheaply produced from a mass of iron, while by varying the size and shape of the rolls an indefinite number of useful sections can be obtained. "Guide" rolls, a small variety used in the production of thin rods of iron, and in which the metal is mechanically guided through the rolls, were invented a few years afterwards by Shinton in Staffordshire.* These improvements, together with the use of larger and more numerous appliances of other kinds, due to the increased output, rendered the use of the steam engine of the utmost possible value; apart from this aid coming just when most needed, the development which followed would have been impossible.

Invention of Puddling by Cort.—The necessity for the use of the steam engine was rendered still greater by the invention of puddling by Cort in 1784; this invention was of the greatest possible importance to the iron trade, and laid the foundation of much of the commercial greatness of Great Britain during the century that followed. Before the days of Cort cast iron had been decarburised in small hearths, generally with charcoal. This system involved a great expenditure of fuel, while the waste and labour were also great, as only about 1 cwt. could be treated at once. But Cort introduced the use of a reverberatory furnace, in which the metal to be decarburised was not in contact with the fuel, but was only heated by the flame, which was caused to strike down or "reverberate" from the roof of the furnace. This enabled the manufacturer to employ coal instead of charcoal, and thus not only introduced a cheaper fuel, but one which, in this country at all events, was specially suitable for the purpose. At the same time, the reverberatory furnace allowed of the use of charges weighing $2\frac{1}{2}$ cwts., even in Cort's original process, and this quantity was afterwards almost doubled. Though Cort's two inventions were thus of immense practical importance to the nation, the story of his life is a particularly sad one. Through the malpractices of a dishonest partner, who shortly afterwards died suddenly, Cort's patent was seized to satisfy his partner's liabilities, and owing to the indifference of the Government, he was unable to derive any benefit from, or work under the patent. After enduring this unjust treatment for some years he died in poverty in 1800, and more than half a century elapsed before the then Government awarded to his surviving descendant a tardy and insufficient recognition of his services. And yet it is stated that if a single ironmaster, Mr. Richard Crawshaw, who learned the process by seeing it in operation at Cort's works, had fulfilled his promises and paid

* This statement is made on the authority of Mr. Bishop, a friend of the author, and grandson of the Shinton above-mentioned.

his royalties, Cort would have received £25,000 before his death.*

In the original puddling process as invented by Cort, or, as it has since been called, "dry puddling," the bottom of the furnace was of sand, and decarburisation was effected by fluid oxide of iron produced by atmospheric oxidation from the pig iron itself. Hence the waste was always great, but more particularly so with grey or silicious iron. To successfully carry on the process with grey iron it was found necessary to submit the metal to a previous oxidising melting, or refining. This process is stated to have been introduced by S. Homfray, of Tredegar, about 1790;* it continued in use until after dry puddling was superseded, and is used in W. Yorkshire and occasionally in other localities even at the present day.

Iron Making at the Beginning of the Nineteenth Century.—We are thus brought in this rapid and necessarily incomplete survey of the early history of iron to the beginning of the nineteenth century, and before considering the more recent developments of this great industry, it may be advisable to glance at the condition of the iron trade, more particularly in Great Britain, at that period. The improvement in the iron trade which took place under the Tudors was largely due to the adoption of Continental, and more particularly of German, methods of manufacture, and the stagnation which followed was caused in great part by the scarcity of charcoal. But by the close of the eighteenth century the United Kingdom had assumed a leading position among the iron-making countries of the world, and the iron trade was about to enter upon a still greater development. The new processes now in use in Britain were the inventions of her own sons, men like Hanbury, Darby, Huntsman, and Cort, who had shown how to utilise the resources and improve the productions of their country. At the same time the invention of the steam engine, together with the great development of the mechanical arts, had created a demand for iron which the manufacturers were scarcely able to supply, so that in spite of the largely-increased production, prices were high, and a considerable quantity of iron was imported into the country from other parts of Europe. Iron was now also coming into considerable use for constructive purposes. The first bridge of iron of any magnitude was cast about 1788, at Colebrookdale, it was erected at Ironbridge over the Severn, and is still in use. The blast furnaces of this period were not more than 40 feet high, with a capacity of less than 2,000 cubic feet; they were built of masonry, with small square hearths, and the blast was introduced by a single twyer. The average weekly production per furnace did not exceed 20 tons through-

* Percy, *Iron and Steel*, p. 632.

† *Ibid.*, p. 625.

out the whole of Great Britain in 1796,* and in many cases was much less than this. A few charcoal furnaces still survived, though they were getting much less numerous; the last furnace in Sussex, at Ashburnham, being blown out in 1827,† while a charcoal furnace was worked at Bunawe, in Scotland, up to so late a date as 1866, the ore being imported from Cumberland. The last charcoal furnaces to survive in the United Kingdom are near Ulverston, in Lancashire, the works having been carried on for nearly two centuries.

At the beginning of the nineteenth century South Wales and Staffordshire were the two most important iron-producing districts in the United Kingdom, and together made more than three-quarters of the total annual production of pig iron. Formerly the blast was introduced by a single twyer, but now several twyers were introduced, and this change led to increased yield and greater uniformity in working.

The form and dimensions of the blast furnace, which were destined to be soon completely changed, had undergone little alteration since the days of Plot, and before proceeding to consider these modern improvements in another chapter, it may be interesting to have on record some account of the blast furnaces in use in the year 1825. The following details of the period in question were supplied to the author by Mr. T. Oakes, of Dudley, who, in the early part of the century, was a member of the largest firm of furnace builders in the country, and who died in 1891 at an advanced age. As an example of the simplest forms of furnace then in use, that of Charlcot, near the Clee Hills, may be taken. The outside of the furnace was square, and built of solid masonry, which was held together and supported by solid oaken beams. The furnace was about 20 feet high, and the diameter at the boshes about 7 feet. The blast was driven by a pair of bellows worked by a water-wheel, while the air was delivered through two twyers on opposite sides of the furnace. The ore used was native clay ironstone, obtained by sinking square pits into the hillside, and the fuel was charcoal. The weekly production of pig iron did not exceed 7 tons, all the materials were carried for some distance on the backs of pack-horses, and the metal was also taken on horseback to Bridgenorth to be sent down the Severn in barges. Bridgenorth appears to have had a considerable trade in iron at one time, and in St. Leonard's Church there are a number of monumental slabs of cast iron, evidently of local manufacture, and in good preservation, one of which dates from 1679. Owing to the bad state of the roads the furnace could not be worked during the winter months. From this description it will be seen that charcoal furnaces had

* Scrivenor, pp. 93-95.

† Wilkie, *Manufacture of Iron*, p. 3.

remained almost unaltered in construction for at least two centuries.

The coke blast furnaces of that period were constructed of masonry, and as lifts were not yet introduced, they were built against an embankment for convenience of filling. These furnaces were 30 to 40 feet in height, the diameter across the boshes was about 10 feet, and that of the tunnel head and filling hopper about 3 feet. At this period the hearth was always built square, and was only about 2 feet across. Each furnace was supplied with three twyers, which for convenience of attachment were connected to the blast main by means of leather bags. The blast was cold, and the pressure about 2 lbs. to the square inch, while the nozzle of the twyer pipe was about 2 inches in

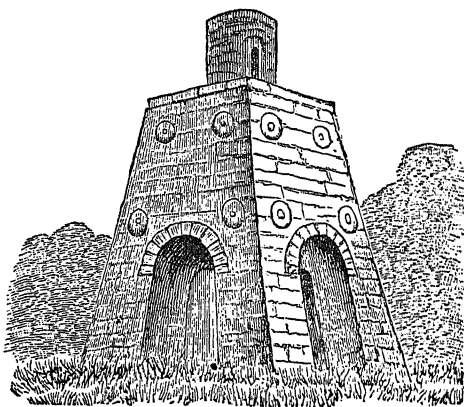

Fig. 4.—Welsh blast furnace, 1825 (from an old pamphlet).

diameter. The fuel used was coke, and the fuel consumption corresponded to about $3\frac{1}{2}$ tons of raw coal per ton of pig iron produced. The weekly production of pig iron per furnace was about 35 to 40 tons, and the small scale on which the operations were conducted is shown by the fact that the cinder was cooled and dragged away by one man with a cinder hook, while the man who worked the blast engine also carried the pigs and weighed them; the furnace fillers wheeled all the materials, measuring the coke in baskets, and the ore and limestone in iron boxes; while at each furnace a girl was stationed to break up the limestone.

At this time, about 1825, the make of pig iron in Staffordshire was more than one-third of the total production of the United Kingdom, and the above description of a coke furnace is believed to be a fair representation of what was good practice at that period. This part of the subject has been dealt with at some

length, as it is necessary to understand something of the condition of the iron trade at the beginning of the nineteenth century, in order to appreciate the enormous advances that have been made during the lifetime of persons now living. It is usual to refer with pride to modern improvements in many directions, and to compare the express train or steamboat of to-day with the old stage coach or sailing ship. Yet in the same period the advances made in the metallurgy of iron and steel, which have rendered these other improvements possible, have themselves been equally wonderful and important in their results, though their value, being less evident, is not so widely recognised.

In addition to the works mentioned in the text the following may be consulted with advantage:—

S. Gardner. *Iron work*, London, 1893, which deals with the history of the subject from the earliest times to the end of the mediæval period.

M. T. Richardson. *Practical Blacksmithing*, London, about 1890, in which is contained a very interesting account of the application of wrought iron for armour and many useful and ornamental purposes during the middle ages.

J. M. Swank. *Iron in all Ages*, Philadelphia, 1884 (1st edition). An important book in which is given a very complete account of the history of the iron trade, particular attention being paid to the early development of the industry in America.

Also papers—“Rise and Progress of the Iron Manufacture of Scotland.” *Inst. Journ.*, 1872, vol. ii., p. 28.

J. H. Dixon. “Old Iron Works at Gairloch.” *Trans. Inverness Sci. Soc.*, vol. iii., p. 222.

CHAPTER II.

MODERN HISTORY OF IRON.

Invention of Hot Blast.*—The modern development of the manufacture of iron may be considered to have begun with the great advance in blast furnace practice in the second quarter of the nineteenth century. In the year 1828 it occurred to J. B. Neilson, the manager of the Gas Works of the City of Glasgow, that it would be advantageous to heat the air used for combustion in smiths' fires, in cupolas, and in the blast furnace. It would not be easy to show that Neilson had any scientific or other good reason for believing that a certain weight of fuel, burned outside the furnace for heating the blast, would produce a greater useful effect than the same quantity of fuel consumed inside the furnace. At all events the use of hot blast for smiths' hearths and cupolas, to which he appears to have attached considerable importance, has never come into successful use. But when in 1829 Neilson's patent was tried at the Clyde Iron Works the benefit was unmistakable. During the first six months of the year 1829, when all the cast iron at these works was made with cold blast, 8 tons $1\frac{1}{2}$ cwts. of coal, converted into coke, was required to produce a ton of iron; but during the first six months of the following year, while the air was only heated to 300° F., the consumption of coal, converted into coke, was reduced to 5 tons $3\frac{1}{4}$ cwts. per ton of iron made. The original apparatus employed in these experiments is shown in Fig. 5, and will be afterwards described. In 1833 the temperature of blast was raised to 600° F., and the consumption of coal was further reduced to 2 tons $5\frac{1}{4}$ cwts. This last result was obtained with the use of raw coal instead of coke, as was formerly employed. †

The introduction of hot blast was of special importance to Scotch manufacturers; the fuel consumption was originally un-

* F. J. Bliss in excavations at Tell el Hesi in 1892 discovered the remains of a furnace which had probably been employed for baking pottery some 1,400 years B.C. In the sides of this furnace air passages were found which were apparently designed to supply hot air for combustion, the heat being abstracted from the walls of the furnace as in the modern Boëtius system. It is difficult to suggest any other use for the passages in question than that assigned by their discoverer, and if this theory be correct then the use of hot air and fire-brick stoves is of great antiquity (*Quart. Statement Palestine Exploration Fund*, April, 1893, p. 108).

† Scrivenor, pp. 295-299.

usually high in the works where the process was introduced, and was generally higher in Scotland than throughout the rest of the country. The economy effected was thus very great, and it was accompanied by the advantage that raw coal could be used instead of coke, and the use of raw coal is still continued in Scotland.

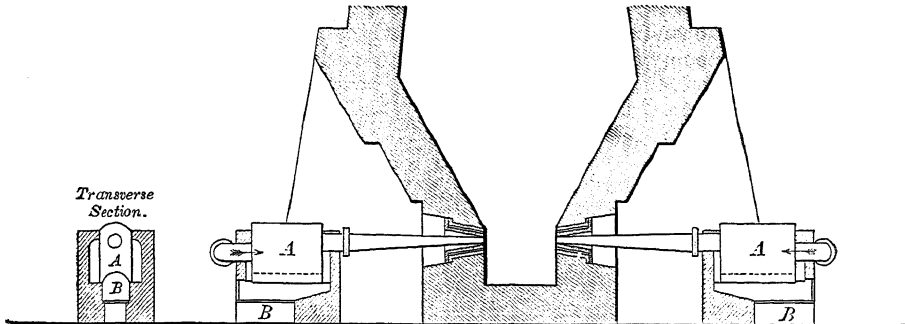

Fig. 5.—Neilson's original hot blast apparatus, 1829.

But there was a third advantage to Scotch ironmasters. When the Carron Iron Works were established in 1760 ore imported from Lancashire and Cumberland was used, with coal and ironstone from the neighbourhood, and limestone from the Firth of Forth. The Clyde Works were established near Glasgow in 1788, and thus opened what is now the most important iron-making district in Scotland. Black-band ironstone, which is the chief ore occurring in the west of Scotland, was discovered by David Mushet in 1801, and was used in mixture with other ores at the Calder Iron Works shortly afterwards; it was first used alone by the Monkland Company in 1825.* Considerable difficulty had been met with in treating this class of ore with cold blast, but it was found that hot blast was particularly suited for the smelting of black-band. Hence the use of hot blast rapidly spread in Scotland, and the production of pig iron, which was only 37,500 tons in 1830, rose to upwards of 200,000 tons in 1840. Each furnace produced more iron, because less fuel was burned, and space previously occupied in the furnace by coke was now filled with ore; while the prosperity of the Scotch iron trade led to the starting of a number of new furnaces. The Scotch ironmasters were thus very ready to take advantage of Neilson's discovery, but they were not so willing to pay him royalties; and though they acknowledged the receipt of net profits of £54,000 in a single year, Neilson only received

* Mushet, "Papers on Iron and Steel," pp. 121-127; also J. Mayer, *Inst. Journ.*, 1872, vol. ii., pp. 28-35.

his royalties when his patent had been upheld by the Scottish Courts at Edinburgh in 1843, after one of the most memorable lawsuits of the century.* When the advantages of the hot blast had thus been demonstrated in Scotland, it was ultimately adopted throughout the whole of the iron trade, except where special uniformity or strength was required, and in all cases its introduction was accompanied with increased production, and with marked economy of fuel. As in S. Wales and Staffordshire the coal consumption originally was not so excessive as in Scotland, the reduction in the fuel consumption was not so great, and was usually less than a ton of coal per ton of pig iron produced. According to Dufrenoy the saving to Scotch ironmasters was 26s. per ton of iron, and only 1s. 8d. in S. Wales. † But in each district some special advantage was noticed in addition to the increased yield and fuel economy; in S. Wales the use of hot blast allowed of the employment of anthracite coal in iron smelting, and for a number of years this was a very important industry; while in Staffordshire it allowed of the smelting of cinder and other materials which could not previously be treated in the blast furnace. The use of the hot blast for smelting iron with anthracite was also introduced into the United States, and thus was laid the foundation of that great industry in eastern Pennsylvania which has since grown to such enormous proportions.

Improved Shape of Blast Furnace.—The greatly increased output due to the use of hot blast directed attention to the theory of the blast furnace, and thus about the same time other important improvements were introduced. One of the Blendare furnaces, near Pontypool, built as usual with a top only about 3 feet in diameter, and carrying but little burden, by some means gave way so that the filling place widened to about 9 feet. This accident was immediately followed by a cooler top, by a better quality of iron, and by a larger weekly yield. During the next few years the improvement thus accidentally discovered was generally adopted, and the diameter of the throat of the blast furnace was enlarged to about 10 feet, ‡ but the most important improvement in the form of the blast furnace was inaugurated about the same time in Staffordshire; the changes thus introduced led to Staffordshire becoming for a number of years the chief iron producing district of the world, and laid the foundation of the greater developments afterwards introduced in Cleveland, and still more recently in America. In 1832, T. Oakes erected a furnace for J. Gibbons at Corbyn's Hall, and fortunately both of these gentlemen had large experience with blast furnaces. They had noticed that in the

* Percy, p. 396, *et seq.*

† Bell, *Iron Smelting*, p. 362.

‡ Scrivenor, p. 283.

old form of furnace, with small square hearths, as shown in section in Fig. 6, the furnace took some months to arrive at its maximum production; and that by this time the sides had been much melted away, that the hearth had become round, its diameter had much increased, and the boshes had worn away so as to be much steeper than they were built originally. Gibbons' idea in building his furnace was to give to the newly constructed stack as nearly as possible that internal shape which furnaces that were known to have worked well had formed for themselves in actual practice. The hearth was, therefore, made circular and of increased diameter (4 feet 3 inches), while the boshes were made steeper, and the upper parts of the furnace lining were scooped out to give greater capacity. The capacity

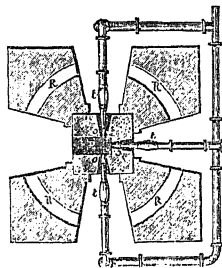

- D, Square hearth.
- o, Twyers.
- t, Cold blast pipe with leather connections.
- R, Passages in masonry.

Fig. 6.—Section of old blast furnace with square hearth.

of the furnace was increased from about 2,700 to 4,850 cubic feet, and as the height was increased from 45 to 60 feet and the throat was widened, the increased capacity was chiefly in the upper part of the furnace. The result was that the fuel consumption was reduced, the furnace came to its maximum production much earlier, it worked more regularly, and required fewer repairs; at the same time the production of pig iron increased to the hitherto unapproached weekly output of 115 tons.*

In 1838, T. Oakes started the Ketly Iron Works, in which he carried these improvements still further. Three furnaces were erected 60 feet high, with 16 feet bosh, and a circular hearth 8 feet in diameter. The blast pressure was increased to 4 pounds to the square inch, and it was introduced by means of six twyers. The yield of pig iron was by these changes enormously increased, reaching 236 tons of cold blast pig iron per week, a quantity which, with cold blast, has seldom been exceeded. By the general adoption of the improved furnace lines now introduced, and by the use of hotter blast, the production increased until in 1854 a weekly yield of 300 tons, or

* Scrivenor, pp. 285-288.

upwards, was not uncommon, and the average throughout the whole of the United Kingdom had risen to 106 tons. A general view of a S. Staffordshire furnace of the period, together with the pig bed and hot blast stoves, is given in Fig. 7. The changes which led to this marked increase in production were thus the use of hot blast, and greater blast pressure, with more twyers; the introduction of circular hearths of increased diameter, and steeper boshes; and the increased height, and the greater capacity of the furnace, particularly in the upper portion. These changes foreshadowed others, on similar lines, introduced later in Cleveland and America.

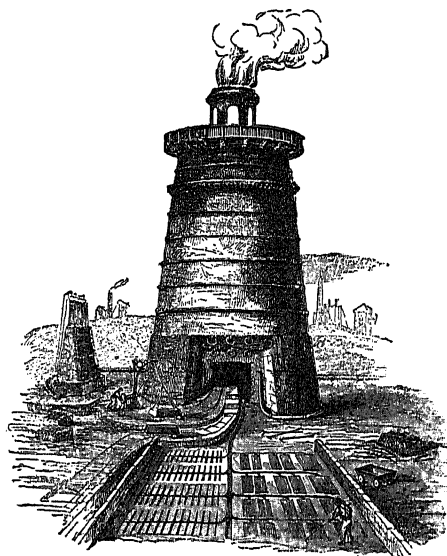

Fig. 7.—Staffordshire blast furnace, 1854.

Improvements in Puddling.—The period of which we are speaking was, however, memorable for improvements in other directions. In 1830 the Bloomfield Iron Works in Staffordshire were founded by J. Hall, who invented the modern system of puddling. The introduction of “pig boiling” was the first step in the direction of improvement, and originated in an attempt to recover the waste due to the accumulation of slag and scrap iron in the boshes in which the puddlers cooled their tools. This waste was successfully treated, and a superior quality of iron obtained, by heating it to a very high temperature in a puddling furnace. During this operation the whole mass “boiled” violently, owing, no doubt, to the evolution of carbonic oxide, and the slag and metal were thoroughly fluid

until the end of the process. The success of this experiment led Hall to apply the same method of working to pig iron, ultimately with complete success in this case also. The advantages derived from the change were that grey iron could be used in the puddling furnace without the preliminary process of refining, larger charges could be employed, and the tendency to "red-shortness" was greatly diminished. But it was found that the sand-bottomed furnaces allowed the fluid cinder to run out during the melting, and the sand, which had previously been useful as a flux, was itself a cause of loss now that more siliceous pigs were employed. Hall, therefore, introduced cast-iron plates,* cooled by the circulation of air outside, and protected inside by a layer of old furnace bottoms. As the new method of working extended, old furnace bottoms became more and more difficult to obtain, and a substitute had to be provided. This was at last procured by calcining the cinder from the same process, whereby it was oxidised and rendered less fusible, and suitable for lining the puddling furnace so long as only fairly pure iron was employed; afterwards, as less pure iron was treated, more infusible furnace linings were substituted. Hall obtained a patent for calcining tap cinder for this purpose in 1839, and thus the old method of puddling on a sand bottom, with previous refining, gave way to the process invented by Hall, whose improvements included the three separate ideas of working at a high temperature, or "boiling," the introduction of cast-iron bottoms, and of a furnace lining containing a large proportion of oxide of iron.†

Manganese in Steel Melting.—A century had passed since Huntsman introduced cast steel, and no improvement of importance had taken place in this branch of manufacture, when in 1840 the use of manganese was adopted by the Sheffield steel-makers, it having been patented by J. M. Heath for this purpose in the previous year. Heath had been employed in the Civil Service of the East India Company, and his attention had been directed to the development of the manufacture of steel in India, in which he achieved considerable success; and on returning to this country he carefully studied chemical analysis, and with the assistance of Dr. Ure and David Mushet, he investigated the influence of manganese on cast steel. He discovered that the addition of manganese during the melting of crucible steel greatly improved its welding properties; while, by allowing of the use of British iron, it reduced the cost of manufacture by about 50 per cent., and at the same time rendered this country in a great measure independent of those

* Iron bottoms had been used by S. B. Rogers, of Nantyglo, as early as 1818, and gave increased production with less waste. (Percy, p. 652.) Hall was, therefore, not the first inventor of iron bottoms.

† J. Hall, *The Iron Question*, pp. 20-33.

supplies of Russian and Swedish iron upon which it had previously relied for the production of steel of the first quality. Heath added his manganese in the form of "carburet"—*i.e.*, metallic manganese containing a few per cent. of carbon, and in his patent he directed that this should be used. But in introducing his process, through an agent named Unwin, he directed that this carburet should be prepared in the crucible from oxide of manganese and coal tar, and he supplied Unwin with these materials for the purpose. Unwin shortly afterwards ceased to act as agent for Heath, set up as a steel manufacturer himself, and refused to pay any royalty; in this he was supported by a number of other manufacturers, who made common cause against Heath. Heath was thus the author of an invention conferring commercial profits to be reckoned by millions; and he described the invention according to the best of his knowledge at the time. The manufacturers adopted a process that was chemically equivalent, and one that was communicated to them by the inventor within a few months after the date of his patent, while the invention was on its trial. Its adoption led to a saving of from 40 to 50 per cent. on the cost of the steel, and the royalty demanded by Heath was only one-fiftieth of this saving. Payment was refused by a section of manufacturers, who created out of their savings a fund to contest his rights, while all the expense of the fifteen years' litigation fell upon him. After he had with his own hands arranged his stall at the exhibition of 1851, he died, leaving his case to be carried on by his widow. The result of fifteen years' litigation was that, of thirteen judges, seven were in favour and six against the claims of Heath; of the eleven judges of the House of Lords, seven were in favour and four against his claims; and the House of Lords ultimately decided, in favour of the minority, against Heath.*

Use of Blast Furnace Gases.—While thus the steel trade benefited enormously, and the uncertainties of the law killed the inventor, important improvements were introduced in other directions. In this country blast furnaces had hitherto always been constructed with open tops, and the combustible gases were allowed to burn as they issued from the furnace. In France, so early as 1814, M. Aubertot had employed the waste gases for preparing steel by the cementation process and for the burning of bricks. In 1834, an attempt was made at the Old Park Works, Wednesbury, to heat the blast with furnace gases, by means of a cast-iron cylinder placed inside the tunnel head at the top of the furnace. But it was not till 1845 that J. P. Budd, of the Ystalyfera Furnaces, obtained a patent for heating the blast in stoves fired by the waste gases from the blast furnace, and this invention was applied with a marked economy of fuel. Shortly

* *The Case of J. M. Heath*, by T. Webster, F.R.S., pp. 5-15.

afterwards, Mr. Budd also employed waste gases for heating boilers as well as for heating the blast, and these improvements were adopted, and, in some cases, improved upon by other iron makers. Iron ore was calcined by means of waste gases from the blast furnace in 1852 at Coltness in Scotland, though this has not come into very general use.* The arrangement for closing the top of a blast furnace, known as the "cup and cone," was introduced by G. Parry at Ebbw Vale in 1850, and it is now very commonly adopted. At Ystalyfera the gases were drawn off by means of chimney draft through openings below the level of the materials in the furnace,† and this method is still sometimes employed.

When closed tops to furnaces were first introduced some difficulties were met with, and in certain cases it was noticed that the resulting iron was inferior to what had been previously made. Dr. Percy (p. 472) quotes an experiment, by S. H. Blackwell, of Dudley, in which it was found on applying the cup and cone arrangement to a furnace which had previously been making grey iron, that nothing but white iron could be obtained, even when the fuel was increased. But this difficulty, which caused a prejudice against the cup and cone arrangement, has been shown by W. J. Hudson ‡ to have been due to other causes, and long experience with closed top furnaces, in almost every iron making district of the world, has proved that the quality of iron is unchanged, while the consumption of fuel is reduced, by the adoption of the closed top.

Opening of the Cleveland District.—In 1850 the Cleveland district was opened up by Messrs. Bolckow & Vaughan, who, in 1851, erected three furnaces at Middlesbrough. In 1853 Messrs. Bell Bros. founded the Clarence Iron Works, and other manufacturers soon followed. What had been a thinly populated agricultural district, became a great manufacturing centre. Employing Durham coke, which is said to be the best in the world, possessing an almost inexhaustible supply of ore, which, if not rich, is uniform and easily smelted, and having the advantage of sea carriage, Cleveland rapidly advanced, until it became the chief iron producing district in the world, and its annual production was reckoned by millions of tons. In 1851, also, owing largely to S. H. Blackwell, the Northampton district was opened up, and soon produced iron in considerable quantities at a comparatively low price; at the same time, the production of Derbyshire was largely augmented, and the trade of the United Kingdom rose by leaps and bounds.

Extended Application of Wrought Iron.—The manufacture of wrought iron kept pace with the production of the raw

* F. J. Rowan, "Iron Trade of Scotland," *Inst. Journ.*, vol. ii., 1886.

† Percy, pp. 462-468.

‡ S. S. *Inst.*, 1884.

material. In the earlier days of the steam engine and of the railway, cast iron had been used for constructive purposes, even for works of the first importance, such as the high-level bridge erected by Stephenson at Newcastle-on-Tyne. Cast iron was also almost exclusively used for cannon, and its properties had been most carefully investigated by Hodgkinson and Fairbairn in their classical researches. The first sea going iron ship was built by Hodgkinson of Liverpool in 1844, and, with the erection of the building for the Great Exhibition of 1851, wrought iron came to be the chief material for constructive purposes; the railway station at Birmingham was erected immediately after, and bridges, rails, buildings, and ultimately ships and ordnance were all made of malleable iron. Just when, in 1856, the demand for iron was thus increasing in every direction, the world was

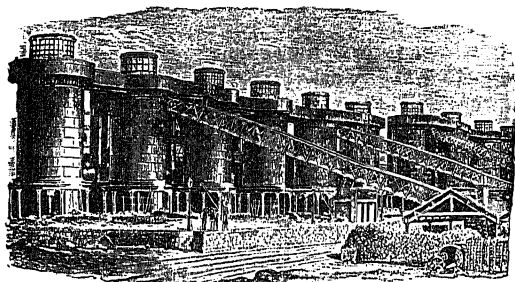

Fig. 8.—Blast furnaces at Barrow, 1865.

startled by the announcement of Bessemer's invention. The changes thus inaugurated will be discussed in another place, but for some years the manufacture of steel did not in any way reduce the demand for iron. It did, however, lead to the opening up of the hæmatite deposits of Cumberland and Lancashire; for though these districts had been worked from very early times, on a limited scale, it was not until Bessemer had created a demand for a pig iron free from phosphorus that the Barrow Works were started in 1861; and as other furnaces were erected in the district soon afterwards, an important addition was made to the iron making resources of this country. In Fig. 8, which is reduced from Kohn's *Iron Manufacture* (frontispiece), is shown a row of blast furnaces erected at Barrow-in-Furness at this period.

Development of the Blast Furnace.—A number of new sources of iron having thus been opened up, the next ten years were spent by ironmakers in developing the blast furnace, which had been but little altered for a quarter of a century. Fig. 9 shows in section a Staffordshire furnace of about the year 1860, and fairly represents the general practice of the time. Such a furnace would be not more than 58 feet high, with a capacity

of 7,000 cubic feet, and many were about 45 to 50 feet high, with a capacity of less than 5,000 cubic feet. The weekly production of a blast furnace was then about 200 tons, and the fuel consumption not less than 30 cwts., and frequently as much as 40 cwts., of coke per ton of iron made. Furnaces designed on the Staffordshire model were erected in all the new districts above mentioned.

The revolution which followed originated around Middlesbrough. The first furnace erected in the Cleveland district was only 42 feet high, and had a capacity of 4,566 cubic feet; during the next ten years a number of furnaces were erected in the neighbourhood, but no important changes were introduced. In 1861 Messrs. Whitwell built three furnaces at Thornaby, 60 feet high, and with a capacity of nearly 13,000 cubic feet; in the following year Messrs. Bolckow & Vaughan increased the height to 75 feet, though the capacity was only 12,000 feet. The first furnace erected by Mr. Samuelson, built at Newport in 1864, was 68 feet high, and had a cubic capacity of 15,300 feet. In 1866 Messrs. Bolckow & Vaughan, with about the same capacity, adopted a height of 96 feet, and in 1868 this furnace was enlarged, without altering the height, to a capacity of 29,000 cubic feet. In 1870 the extreme height of 106 feet was reached at Ferry Hill, in Durham; while in the following year a furnace was erected by Mr. Cochrane 92 feet high, and with a capacity of 42,500 cubic feet.*

Thus in ten years the average height of a blast furnace in Cleveland had nearly doubled, and the cubic capacity had increased from six to ten fold. As might be anticipated, the make per furnace increased, though not in proportion to the increased capacity, and rose from 400 to 500 tons of pig iron

* Sir L. Bell, *Chemical Phenomena of Iron Smelting*, Preface. For full details and drawings see Jno. Gjers, *Inst. Journ.*, 1871, p. 202.

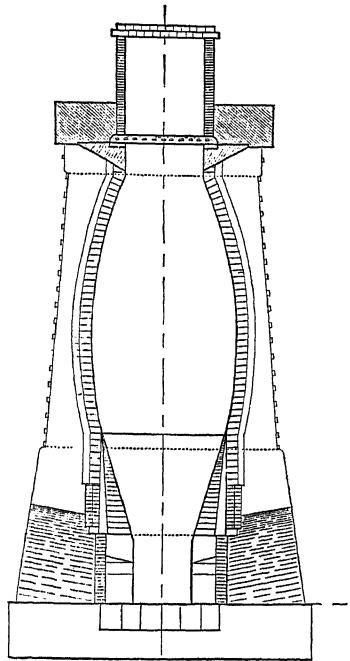

Fig. 9.—South Staffordshire blast furnace, 1860.

per week. The furnaces also worked more regularly; but the great advantage derived from the erection of larger furnaces was in the reduced fuel consumption. The amount of coke used per ton of iron was diminished by about one-fourth of that previously employed, and did not exceed $22\frac{1}{2}$ cwts. in the best furnaces.

In addition to the alterations of height and capacity, other changes took place in the form of the blast furnace which deserve mention. The old form of furnace, built of massive masonry, with an external shape of a truncated cone resting upon its base, was unsuitable for larger erections; it was therefore replaced by a lighter form of construction, with a wrought-iron cylindrical casing, supported upon cast-iron pillars. The walls of the furnace and the lining of the hearth were made much thinner than formerly, the internal shape of the lining being to a great extent preserved by the cooling effect due to the atmosphere, and radiation through the thinner walls of the furnace.

Subsidiary Improvements in Blast Furnace Practice.—

An important improvement in a different direction was generally adopted about this time. Iron ores were originally calcined in open heaps, and in certain districts this wasteful and unsatisfactory method is still adopted. Rectangular kilns were afterwards introduced, and these were at first very simple contrivances and intermittent in action. But circular calcining kilns shaped like a blast furnace, but shorter and of greater diameter, were now adopted in Cleveland, and very generally in other districts where calcination is necessary. These kilns give a more uniform product, and occupy less space; they save fuel and labour, and protect the materials from the effects of inclement weather.

A further improvement was introduced in Cleveland shortly after 1860. In the older forms of hot-blast stoves the air was heated by passing through a series of cast-iron pipes, and only a moderate temperature could be obtained owing to the danger of melting the pipes. But the adoption of the regenerative principle of gas firing by Sir W. Siemens introduced a system which is one of the most important, and perhaps theoretically, the most beautiful, of modern metallurgical inventions. A fire-brick stove on the regenerative principle, heated by the waste gases from the blast furnace, was invented by Cowper, and another of different construction by Whitwell, and thus it became possible to obtain blast at a much higher temperature, so high indeed as to be actually red-hot, so that the iron pipes conveying the blast are now often visibly red at night. The additional heat imparted to the blast led to a further diminution of fuel consumption, and it became possible to produce a ton of iron with 20 cwts. of coke, or with about 27

cwts. of raw coal. At the same time an increased yield was obtained corresponding to the diminished fuel consumption.

The continued increase in the production of the blast furnace, thus brought about by successive improvements, necessitated other changes in the details of furnace design. The mound of earth, or the incline, along which the small quantities of materials were previously drawn, was replaced by powerful lifts capable of treating the enormous weights now employed. The old-fashioned beam engines used for producing the blast were replaced by powerful machinery capable of forcing an increased volume of blast at a pressure of 5 to 7 lbs. to the square inch. Small pig beds were replaced by large areas suitable to the increased production, while railways have been generally introduced for removing the large weight of slag produced by a modern furnace. Lastly, the open forepart which was formerly universal, was in a number of cases removed, as it was found that in many districts closed furnaces give an increased yield and greater regularity of working.

Thus about 1880, as a result in a great measure of discoveries and inventions originating within her own shores, Great Britain occupied the leading position in the iron trade of the world, and Cleveland was the most important iron producing district. Owing, however, to the great advances that had been made in the production and application of steel, the wrought iron trade had commenced to decline, and the annual production of this class of material decreased relatively to steel year by year until about 1890, when on the Continent and in America the production once again increased, while it more than held its own in this country. It is perhaps too early to speak definitely on this point at present, but iron manufacturers believed that wrought iron and steel had now found their relative positions, and that the production of the older material would not seriously suffer in the near future.*

IMPORTATION OF NON-PHOSPHORIC ORES.

Among the changes due to the introduction of steel making may be noted the importation of large quantities of iron ore into this country, chiefly from Spain, but also, though to a smaller extent, from other countries. Spanish ore is free from phosphorus, and is used in iron making districts situated near the sea, particularly in South Wales, Cleveland, and the West of Scotland, for the production of pig iron suitable for the manufacture of steel by the acid processes. This importation of ore has grown to such proportions that at present about one-fourth of the pig iron made in the United Kingdom is made from ore shipped from abroad.

* Sir J. Kitson, *Inst. Journ.*, 1889, vol. i., p. 14.

Modern American Blast Furnace Practice.—Previous to the year 1880, from which the modern development may be considered to begin, the production of the American iron works was comparatively small. The weekly production of blast furnaces in Staffordshire and Scotland in 1880 was about 300 tons, that of the larger furnaces in Middlesbrough did not exceed 500 tons, and was usually less, while the greatest outputs were obtained from furnaces smelting the rich Cumberland or Spanish ores, and did not exceed 700, or at the very outside 900 tons per week. The first iron furnace in America was a bloomery erected in Virginia in 1619, and the first blast furnace with forced blast was built about 1714 in the same State. The ore smelted was the "gossan," or oxidised cap of deposits of cupriferos pyrites. Shortly after the Revolution numbers of charcoal furnaces were working; while the Eastern Pennsylvanian anthracite district was opened up soon after the introduction of hot blast. The growth of the Western Pennsylvanian or bituminous district is of a later period, while in Alabama and other Southern States iron making is of very recent origin.* In America in 1871 the Struthers furnace in Ohio had a weekly output of about 400 tons, and this was probably the maximum make per furnace at the time. In 1876 the Isabella furnace at Pittsburg made 560 tons of pig iron per week, with a coke consumption of 3,000 pounds per ton, and a furnace capacity of 197 cubic feet per ton of iron made daily. In 1878 at the Lucy furnaces, also at Pittsburg, with a coke consumption of 2,850 pounds, a weekly production of 821 tons had been reached; but even these relatively large yields were little if at all in advance of British outputs.

Matters were completely changed after the erection of the Edgar Thompson furnaces in 1879. The first blast furnace erected at these works was originally worked as a charcoal furnace in Michigan, and was removed to the Edgar Thompson works and re-erected in 1879. Its height was 65 feet, and the hearth was 8.5 feet in diameter; the boshes were made steeper than usual, having an angle of 84°, while the angles inside the furnaces were rounded as much as possible so as to offer less resistance to the descent of the charge. The capacity of this furnace was only about 6,400 cubic feet; and the volume of air used was 15,000 cubic feet per minute, or as much as was used elsewhere with double the capacity. The furnace reached a weekly output of 671 tons of pig iron, with a consumption of coke equal to 2,343 pounds per ton of iron made. This was considered such remarkably good work for so small a furnace as to be received by many iron masters with incredulity.

The second furnace at the Edgar Thompson works was put into blast in 1880. It was 80 feet high; the diameter of the boshes was 20 feet, of the hearth 11 feet, and the capacity was

* *Inst. Journ.*, 1891, vol. ii., p. 232.

nearly 18,000 cubic feet. It was well equipped with stoves of modern construction, and supplied with more boiler and engine power than had been usual hitherto. The volume of blast reached a maximum of 30,000 cubic feet per minute. The ore mixture contained about 55 per cent. of iron, and the weekly make rose to 1,200 tons, though the fuel consumption was as high as 2,750 pounds of coke per ton of iron. Another furnace built in 1882, after some experience in rapid driving had thus been gained, reached a weekly output of 1,500 tons, while the fuel consumption was somewhat reduced, and now stood at 2,570 pounds of coke per ton of iron made.

These results excited much friendly rivalry among the blast furnace managers of the United States, and large makes became the order of the day, each manager endeavouring to beat the record for large yields, though frequently by means of an enormous waste of fuel. But in 1885 it began to be more generally recognised that it was possible to obtain large yields without a high consumption of coke, and attention was soon directed quite as much to beating the record for small coke consumption as for maximum production. The volume of blast used was therefore somewhat reduced, while to preserve the shape of the furnace, water blocks were introduced around the hearth and sides. This latter improvement was adopted because it was noticed that as the sides of the furnace wore away from the shape which experience had proved to be best, the fuel consumption largely increased. In 1886 a furnace was started at the Edgar Thompson works which reached an average production of 2,035 tons per week over a period of five months working, while the amount of coke required was only 1,980 pounds per ton of pig iron. The same furnace was re-lined and blown in again in 1889; it reached a maximum weekly production of 2,462 tons, and the coke consumed in this furnace in 1890 fell to 1,882 pounds, or 16·8 cwts. per English ton of iron. The ore used was rich, containing 62 per cent. of iron; the volume of air was 25,000 cubic feet per minute. This was heated to a temperature of 1,100° F., and had a pressure at the tuyers of 9·5 pounds to the square inch. In this case the furnace capacity producing 1 ton of iron daily was reduced to 59 cubic feet. Thus in American practice the weekly make per furnace rose from 560 tons in 1876 to 2,500 tons in 1890; the furnace capacity needed to produce 1 ton of iron daily, fell from 197 to 59 cubic feet; and the consumption of fuel was reduced from 3,000 to 1,882 pounds per ton of pig iron.* Even these results have been somewhat improved upon recently.

Urged by the energy and skill of iron makers, supported by the requirements of a rapidly developing country, and protected

* J. Gayley, "Development of American Blast Furnaces," *Inst. Journ.*, 1890, vol. ii., pp. 18-86.

by tariffs, the iron trade of America made marvellous strides from 1885; and 1890 is memorable in the history of the iron trade from the fact that in this year for the first time the United States took the first place among the iron-making countries in the world; a position Great Britain had so long honourably maintained. In 1890 the production of pig iron in the United States reached nearly 10,000,000 tons, while that of the United Kingdom was not quite 8,000,000 tons.

The introduction of the basic process into Germany about the year 1880 also led to the employment of a class of ores for steel making which are very plentiful in that country, but which were not suitable for the production of steel by the earlier systems. This led to a considerable development in the steel trade of Germany, and combined with the general prosperity of the country, caused a great increase in nearly all branches of the iron trade, so that the production of pig iron has rapidly increased year by year, and is now more than half of that of the United Kingdom. Large outputs are also not uncommon in German practice; in 1890 at Ilsede a daily production of 192 tons was reached, while a daily average of over 176 metric tons of basic pig iron was obtained.*

* *Inst. Journ.*, 1891, vol. i., p. 350.

CHAPTER III.

THE AGE OF STEEL.

I. THE BESSEMER PROCESS.

THE age of steel, in which we now live, may justly be considered to have commenced with the meeting of the British Association for the Advancement of Science held at Cheltenham in 1856; for it was on this occasion that Sir Henry Bessemer first made public the process which a few years afterwards revolutionised the trade of the world. It has already been pointed out that steel was known before the commencement of the Christian era; that the cementation process had been employed from a remote period; that Huntsman had introduced the manufacture of cast steel; and that Heath had patented the addition of manganese. Eminent scientific men had already studied the nature of steel; in 1722 Reaumur published a treatise on *The Conversion of Bar Iron into Steel*, and described the production of steel by dissolving wrought iron in a bath of molten cast iron; in 1781 Bergman clearly stated that steel differed from wrought iron in that it contained more carbon; at the beginning of the nineteenth century Sir H. Davy investigated the hardening and tempering of steel; and later, Faraday made some important observations on the composition of different varieties of this material; while other investigators, scarcely less famous, had contributed to the same enquiry. But prior to 1856 the production of steel was comparatively small, its use was restricted to the production of cutlery and tools, and it was so costly that cast steel had never been sold in Sheffield for less than £50 per ton.

Bessemer's Early Life and Experiments.—Born in 1813 at Charlton, in Hertfordshire, the youngest son of a very ingenious French refugee, and receiving an ordinary education in the neighbouring town of Hitchin, Bessemer early exhibited indications of an inventive genius. At the age of eighteen he was working in London as a designer and modeller, and in 1832 he exhibited one of his models at the Royal Academy. After having invented the method of stamping deeds now in use, and thus, by preventing fraud, effecting a large annual saving to the country, without himself deriving any pecuniary benefit, he

introduced improvements in the casting and setting of type, and various other inventions, with more or less success; but he succeeded in making a considerable sum of money by carrying on a secret process, invented by himself, for the production of bronze powder. He had thus earned the title of "the ingenious Mr. Bessemer" in the public press before he turned his attention to the metallurgy of iron and steel. The Crimean War directed his attention to the subject of projectiles, and he invented a method of imparting a rotating motion to a projectile when fired from a smooth-bored gun. This was tried, with satisfactory results, by the French Artillery Authorities, and Napoleon III. was very generous in his support of the experiments at this stage.

But it soon became evident that the cast-iron guns then in use were wholly unsuited for the more powerful projectiles pro-

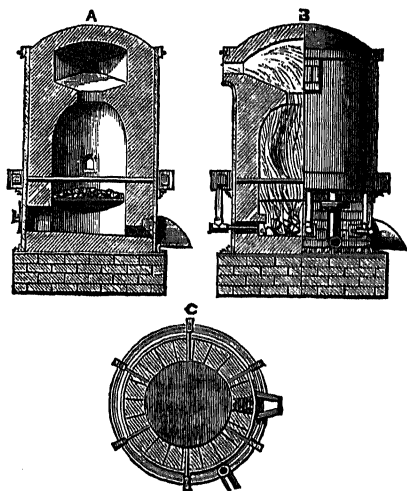

Fig. 10.—Early form of Bessemer converter.

posed by Bessemer, and he therefore set himself to discover a stronger material for the manufacture of ordnance. When he commenced this task he had little knowledge of the metallurgy of iron, and no idea how he was to accomplish what he desired. In 1846 J. D. M. Stirling had patented a method of "toughening" cast iron by the addition of a quantity of malleable iron, and this process had met with considerable application. In 1855 also (No. 2618), Price and Nicholson had patented a method of strengthening cast iron for ordnance by mixing ordinary grey iron with refined iron in suitable proportions; and in May, 1854, James Nasmyth patented the introduction of steam *below*

the surface of molten cast iron to oxidise the impurities. Thus others were working to produce a strengthened metal for ordnance, and the use of oxidising agents, introduced under the surface of the molten metal, had been already suggested. These ideas appear to have formed the basis of the experiments of Bessemer. He first patented the use of air as an oxidising agent in October, 1855, and in his early experiments only produced refined iron. But, encouraged by his success, he directed his attention to the manufacture of malleable iron. His first experiment was conducted in a crucible with a few pounds of metal; the iron remained fluid till the end of the operation, and the product was malleable. Much encouraged by this result, he prosecuted his researches, his idea being to employ a number of crucibles and pipes to deliver the air. Ultimately he adopted the plan of introducing the air from the bottom of a large converter, an early form of which is shown in Fig. 10; this was patented in February, 1856. His first experiments on a large scale were conducted at Baxter House, St. Pancras, London; a circular vessel 3 feet in diameter and 7 feet high was employed, the charge weighed 7 cwts., and the operation was completely successful.

The Bessemer Process before the Public.—Bessemer was astonished at his own success, and particularly at the fact that

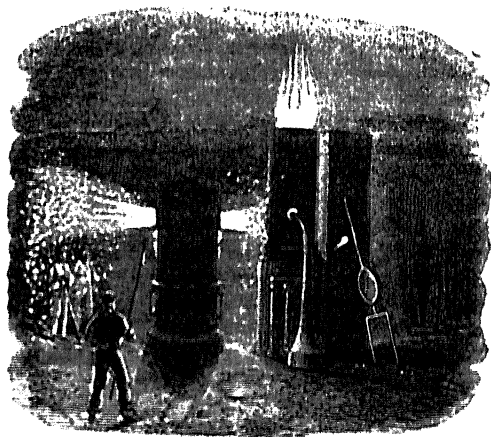

Fig. 11.—Bessemer's experiments at Baxter House (after Pepper).

the highest temperature known in the arts could be produced by the simple introduction of atmospheric air into fluid cast iron. He now devoted six months to further experiments, which involved an outlay of over £3,000, and was then persuaded by Mr. Rennie to make the first public announcement of his

process at the Cheltenham meeting of the British Association on August 11, 1856, the title of his paper being "The Manufacture of Malleable Iron and Steel without Fuel." The excitement that followed was intense; several public trials of the process were made at Baxter House with very satisfactory results, the pig iron used by Bessemer being low in phosphorus and obtained from Blaenavon. Numerous experiments were tried by iron manufacturers throughout the country, in some cases with success; but in other instances complete failure followed, the iron made being rotten when hot, and brittle when cold. The reason for these failures was at first imperfectly understood, though it was soon recognised that while Bessemer's process removed carbon and silicon, it was incapable of eliminating the phosphorus present in the original cast iron. The following remarkable passage occurred in a letter, dealing with the new process, written by Dr. Collyer on September 11, 1856. Speaking of the injurious effects of phosphorus and sulphur, the writer says:—

"The former I consider the most pernicious of all. I would suggest, with due deference, that a stream of finely pulverised anhydrous lime (dry lime) be forced at a given time with the compressed air into the incandescent mass of iron. The lime having a great affinity for silica (sand) and phosphorus would form a phosphate and silicate of lime, and be thrown off with the slag. By this contrivance I cannot conceive but that the phosphorus would be entirely got rid of." It was nearly a quarter of a century before the basic process thus so plainly foreshadowed was successfully adopted in practice.

Bessemer's Difficulties.—Bessemer now recognised that the cold shortness observed in the product of his process with certain kinds of iron was due to the presence of phosphorus, and that the success of his earlier attempts was due to the employment of non-phosphoric materials; he therefore tried to accomplish the removal of the obnoxious element by modifying his converter linings so as to make his process as nearly as possible resemble puddling. But he shortly abandoned these attempts when he found that he could obtain Swedish iron, almost perfectly free from phosphorus, for £7 per ton. His great initial difficulty was thus overcome, but in producing steel from Swedish iron, Bessemer had two further difficulties to meet. During the progress of the "blow" in the converter the silicon and carbon were gradually eliminated until, at the conclusion of the operation, the resulting fluid metal was nearly pure iron; it was in fact much purer than the best varieties of wrought iron imported from Sweden. It was thus too soft and malleable for the purpose of steel manufacture, and some method was needed whereby the required content of carbon could be obtained. At the same time the metal was often red-short

and cracked, or even crumbled to pieces, when rolled at a red heat. Both of these difficulties were remedied by the addition of a suitable proportion of "spiegel-eisen," a variety of cast iron rich in manganese and carbon.

The importance of manganese as an addition to Bessemer steel was recognised from the first by R. Mushet, who took out patents to cover all possible methods of introducing this element, his first patent being dated September 22, 1856. But it has been already shown that in all probability the Romans used manganese ore for producing steel. So early as December 6, 1799, a patent had been granted to W. Reynolds, of Ketley, Salop, for mixing the oxide of manganese or manganese either with cast iron, or with the materials from which cast iron is produced, in any process for the conversion of cast iron into steel, either in the finery, bloomery, puddling, or any other furnace. Heath had also employed manganese in more than one form for the production of cast steel. Bessemer never acknowledged the validity of Mushet's patents, though he made him a sufficient allowance in his later years to keep him well removed from poverty, and the matter was not legally contested. In fact, Mushet's patents were allowed to lapse when the first renewal fees became due, though the author is informed by Thos. D. Clare (Mushet's partner) that this was owing to a misunderstanding on the part of those who were financing the patents for Mushet, and not to any doubt as to their value. The claims of Mushet in this connection have been fully dealt with in a book published by himself.*

While the chemical difficulties of the process were thus being overcome, Bessemer introduced a number of mechanical improvements in the methods of working, the most important of which was the use of a converter mounted on an axis and capable of being rotated, so as to bring the tuyers above or below the fluid metal at will; this improvement also provided a ready means of introducing the original cast iron and of pouring out the fluid steel, which has been almost universally adopted ever since. About the same time Bessemer also found that the iron made from the hematite ores of Cumberland was well suited for the production of steel by his process, and he was thus provided with an abundant supply of cast iron suitable for steel making.

Bessemer's Success.—After four years' incessant labour, and an expenditure of £20,000 in experiments, the process was perfected, and it is a remarkable fact that not only the first conception, but also the mechanical details of the process were all originated by the same mind, and the invention left the hands of its originator so complete that no improvement,

* *The Bessemer-Mushet Process* (Cheltenham, 1883).

except in minor details, has since been introduced. It must, however, be admitted that the claims put forth in the title of Bessemer's paper had not been realised, for fuel was still needed to produce cast iron in the blast furnace, and fuel in another form is burned in the Bessemer converter. The Bessemer process also is incapable of producing the fibrous wrought iron which was the aim of the inventor in his early experiments, but if the process has failed when judged from these standpoints, it has succeeded in doing more even than its own inventor originally hoped, and has supplied a material which, for many purposes, is to be preferred to wrought iron, and which has now largely superseded the older material.

But when the process was thus perfected an unexpected difficulty arose. So much had been heard of the invention at first, and so much had been hoped from it, that the disappointment at the early failures had been proportionally keen; the process had been the subject of ridicule in numberless publications, and about 1860 the prejudice against it was so strong that no manufacturer would look at it. Under these circumstances Bessemer and his partner Robert Longsdon joined with Messrs. Galloway, of Manchester, and erected steel works at Sheffield; at these works steel of excellent quality was produced and sold for engineers' tools at £42 per ton, while it was gradually introduced for rails, boilers, ordnance, and constructive purposes. In this way the value of the material was proved, and steel manufacturers learned its importance by the keen competition with which they had to contend. Thus the Sheffield manufacturers were forced to adopt the new process, Messrs. J. Brown & Co. taking the lead in this direction, and other firms throughout the country soon followed. The works thus started by Bessemer and his partners continued in operation fourteen years, when having accomplished the purpose for which they were erected, they were sold for twenty-four times their original value, while the profits had amounted to fifty-seven times the original capital; thus each of the partners received eighty-one times his original capital, or cent. per cent. every two months. The Prussian patent office refused to grant Bessemer a patent owing to an alleged want of novelty; the Belgian manufacturers thereupon also refused to pay royalty, and the leading French manufacturers after coming to England and studying the process at Bessemer's works, and receiving from him detailed drawings for the erection of a plant, managed to delay its erection until a few weeks before Bessemer's French patent expired, and never paid a single penny for all the information they had received. In spite of such dishonourable conduct in some quarters, it is satisfactory to know that before the expiration of his patents the inventor received over a million pounds in royalties, and certainly this amount, large as it is, was not too great a recompense for an invention which, it has

been truly said, was of far more importance to the world than all the gold of California and Australia.

Bessemer Steel Boilers.—The properties of Bessemer steel were now carefully examined by engineers, and as its advantages were more understood the purposes to which it was applied steadily increased. It was first used for the construction of boilers by Daniel Adamson, of Manchester, who gave his first order for boiler plates on May 8, 1860, and the boilers so produced not only gave satisfaction in every other respect, but on account of the greater tenacity of steel as compared with wrought iron, they allowed of the use of steam at a pressure of 80 pounds to the square inch;* needless to say higher pressures have since been employed with marked economy of fuel, and steel plates are now almost universally adopted for the construction of boilers. Encouraged by the success attending the use of steel for stationary boilers, Mr. Ramsbottom in 1863 constructed the first steel locomotive boiler; this gave every satisfaction, and lasted much longer than was usual with iron. About the same time steel began to be applied for two other purposes of even greater importance, namely, for rails and for shipbuilding.

Steel Rails.—The first steel rail was made by R. Mushet in one of his earliest experiments in 1856, and was laid at Derby Station, with the result that it remained as perfect as ever after six years' wear, though it was in a position in which an iron rail required to be replaced every three months. The first application of steel rails, on any considerable scale, was made at Chalk Farm, where steel rails were laid down on one side of the line and iron rails on the other. In this position the traffic was very heavy, and as the iron rails wore they were first turned, and after the second face was worn away the rail was replaced. In 1865 Bessemer exhibited one of these steel rails in Birmingham, at the meeting of the British Association; one face of the rail was almost worn away, while on the other side of the line eleven iron rails had been completely worn out; thus one steel rail outlasted more than twenty iron rails. But in spite of this very satisfactory result, railway companies were cautious in adopting the new material, though in 1880 two-thirds of the lines in the United Kingdom were laid with steel, and steel rails are now almost universal.

Steel Ships.—In 1863 Bessemer succeeded in persuading a shipbuilder to construct two stern-wheel barges of steel, and in the following year a paddle-wheel steamer of nearly 400 tons capacity was built; soon afterwards a clipper ship of 1,250 tons was launched. The wonderful ductility of steel was shown in a remarkable manner during the first voyage of this vessel, which was in Calcutta in October, 1864, when a fearful cyclone caused enormous damage. The following extract gives a graphic pic-

* *Inst. Journ.*, 1888, vol. i., p. 10.

ture of the events that happened after the ship in question had been struck fairly on end by a vessel of 1,000 tons burden:—“The plates were beaten in, but not fractured. Forward, the continual hammering of several large vessels beat the bulwarks level with the deck; the plates forming them were, nevertheless, so tenacious, that they were prized back to their original position, and made to do duty again without the aid of a riveter. In another part of the bulwarks a plate had been partially knocked out, and, catching against the side of the other vessel, was rolled up as perfectly as a sheet of paper could be. In the stern, between the upper deck and the poop, several plates were driven in by repeated blows from a heavy wooden ship. These and the angle irons were twisted into a thousand fantastic forms, in some cases doubled and redoubled, and in no case was there a crack or fracture that indicated any brittleness in the metal.” In spite of all this hard usage the vessel did not make a drop of water. Thus the superiority of mild steel for shipbuilding was demonstrated in 1864; but some years elapsed before steel plates were in common use for this purpose, though in recent years, in this direction also, wrought iron has been almost entirely replaced. At the same time the experience and confidence that has been gained in the use of steel has led to its application to bridge building, the manufacture of guns and projectiles, and for innumerable other useful purposes.*

II. SIEMENS' STEEL.

The growing demand for steel soon brought other inventors into the field in which Bessemer had been so successful. Among these may be mentioned Attwood, Heaton, Henderson, and Parry, but the only process which can be said in any way to approach that of Bessemer, in its general application, will always be associated with the name of the late Sir W. Siemens.

Early History of Sir W. Siemens.—Born at Lenthe, in Hanover, in 1823, a member of a family with world-wide renown for their scientific and inventive achievements, Siemens was educated at the Polytechnical School of Magdeburg and at the University of Gottingen. In 1843 he paid his first visit to England for the purpose of introducing to Messrs. Elkington, of Birmingham (just after Sir Josiah Mason had joined the firm), a method by which silver could be electro-deposited with a smooth surface, instead of with a crystalline appearance as was formerly the case. Siemens returned to England in 1844, and henceforth resided in this country; during the forty years that followed he

* W. T. Jeans, *Creators of the Age of Steel*, p. 99, *et seq.*, from which much of the information given in the section has been condensed.

was not only a prolific inventor, but a constant contributor to the literature of the highest branches of physical and metallurgical science; though in spite of the ingenious and valuable nature of many of his inventions in other directions, it is as the originator of the regenerative gas furnace and of the open hearth process of steel making that his fame will be most widely recognised.

The Regenerative Furnace.—The Brothers Siemens in their scientific studies had been much impressed with the theory of the conservation of energy, which was then being introduced, and also with the determination of the mechanical equivalent of heat by Joule; there can be no doubt that these studies laid the foundation of the great discoveries that followed. So early as 1817 the Rev. Dr. Stirling, of Dundee, had suggested the application of the regenerative principle in the construction of his engine, and W. Siemens following on the same lines, at first directed his attention to the construction of a regenerative steam engine. A number of these were erected and put into practical operation, but while they were economical in fuel, the wear and tear of the heating vessels was so great that they were ultimately abandoned. In 1857 his brother Frederick suggested to him the application of the regenerative principle for producing a high temperature in furnaces, and in the next five years several forms of furnace on this principle were constructed and used for heating steel bars. But with larger furnaces difficulties arose which at first appeared insuperable; at length Siemens adopted the system of gasifying his fuel before burning it in the furnace, and his difficulties were to a great extent overcome. The first furnace on his improved principle, patented in 1861, was erected the same year at Messrs. Chance's glass works near Birmingham. This furnace was worked with separate gas producers, and with fire-brick regenerators which were also separate from the furnace; it was simple in operation and economical in its results, while the beautiful principles involved in its construction so impressed the mind of Faraday, that the great physicist chose this as the subject of the last popular lecture he ever delivered at the Royal Institution.

The regenerative furnace was soon applied on a considerable scale, as its advantages in economy and regularity of working became appreciated; some of its earliest uses were for zinc distillation, for reheating iron and steel, for melting crucible steel, and for puddling. But the Prussian Patent Office, which had previously declined to grant protection to Bessemer for his invention, also refused Siemens a patent for his regenerative furnace, on the ground of its resemblance to a mediæval warming apparatus which had been employed for heating two rooms in the ancient preceptory at Marienburg! *

* Jeans, *Steel*, p. 104.

Steel Making in the Regenerative Furnace.—Siemens now directed his attention to the manufacture of steel on the hearth of his furnace, and at first met with but indifferent success. In 1862 an open hearth furnace was erected for C. Attwood in Durham, who employed it for producing steel by melting together wrought iron and spiegel-eisen, but the result was not very satisfactory. In 1863 a large furnace was erected at Mont Luçon in France, and excellent steel was produced, but the roof of the furnace was unfortunately melted, and the experiments were then abandoned. Trials were conducted at Glasgow and at Barrow in 1866, also at Bolton in 1867, but in each case were soon abandoned. Under these circumstances Siemens found it necessary to erect experimental steel works at Birmingham, where the success of the process could be demonstrated; there he produced large quantities of excellent steel, from old iron rails principally, which were converted into steel and were afterwards relaid by several of the more important Railway Companies. While the process was thus brought to a successful issue in England, equal good fortune attended the labours of P. & E. Martin at Sireuil in France, who in 1863 had erected a furnace from plans supplied by Siemens, and who after much labour succeeded in preparing steel by dissolving wrought iron in cast iron on the hearth of a Siemens furnace. Thus originated the "Siemens-Martin process"—*i.e.*, the production of steel by Martin's process of dissolving wrought iron scrap in a bath of cast iron, with a suitable addition of manganese and carbon at the end of the operation; this process was conducted in a Siemens furnace, and in its original form is now of little importance. At the same time Siemens was himself busy in perfecting his idea of decarburising cast iron by the use of iron ore, with or without the use of iron and steel scrap, and when the success of this process had been amply proved at the experimental steel works at Birmingham, it was adopted early in 1868 by the London and North-Western Railway Company at Crewe. The Siemens steel works at Landore were also started in 1868, and in the following year thousands of tons of steel were made by the Siemens process in this country, while its use was spreading rapidly on the Continent.

Siemens' Direct Process.—Not content with the success he had thus achieved in producing steel from pig iron and ore (a method which was called the "direct" process, in distinction from the use of pig iron and scrap), Siemens now directed his attention to a still more direct method, and devised a rotating regenerative gas furnace, in which steel was produced by the action of carbon on iron ore in a single operation. On account of the reputation of the inventor, and the simplicity of the chemical changes involved in such a direct method of production,

great hopes were entertained of the ultimate result of this process. In 1873 works were erected at Towcester, in Northamptonshire, for carrying on the manufacture, and steel of splendid quality was produced, but the cost was found to be so great as to render working unremunerative, and the works were ultimately abandoned. The Steel Company of Scotland was formed in 1871, and had at first in view the production of steel, by the use of rotating furnaces, from purple ore, which is the residue from the roasting of Spanish pyrites. One furnace of this type was erected, but it was stopped, and the whole plant removed in 1875, owing to the excessive cost of production.* Not daunted by these failures, Siemens returned to this question in 1880, at Landore, and only a few months before his untimely death, in 1883, he effected important improvements in the process, and apparently never lost faith in it to the end. This direct ore-reduction process has, however, not been in use, at all events in its original form, for some years, while the pig and ore, or the "Siemens" process, has made steady progress year by year throughout the world, and now ranks as second only in importance to the Bessemer process itself. There are indications which point to a still greater application of the Siemens process in the immediate future, and persons with great experience in the steel trade have even predicted that the Siemens process will ultimately lead in the race. While the Bessemer process has the advantage that steel can be produced in the finished state from pig iron, without any expenditure of fuel, the Siemens process, on the other hand, though it requires fuel, gives a larger yield from a given weight of pig iron, the operation is more under control, and the product is more uniform; the Siemens furnace is also specially in favour for the production of steel suitable for castings. Bessemer's process is now practically without a rival for the production of large outputs of rails, but Siemens steel, on the other hand, is employed for important structures like the Forth Bridge, for the manufacture of ships' plates, for the production of very mild steel of specially uniform quality, and for steel castings of every description.

III. THE BASIC PROCESS.

It has been already stated that as early as the year 1856 it was pointed out by Dr. Collyer that the ordinary Bessemer process, conducted in converters lined with siliceous material, did not eliminate the phosphorus present in the original pig iron. Collyer had also pointed out that this objectionable element could be eliminated by the use of lime, and his views

* J. Riley, "Scotch Steel Trade," *Inst. Journ.*, 1885, vol. ii.

were afterwards confirmed by Percy, Gruner, and other metallurgists. It was thus generally recognised that the use of a base in some form was necessary in order to produce steel from phosphoric iron, but the great difficulty was to devise a practicable method of applying the principle which was thus so generally recognised.

Heaton had employed oxygen and a base together in the use of sodium nitrate, and by this process phosphorus was eliminated; but the operation was so difficult to control, and the incidental expenses were so great, that the method was abandoned after great anticipations had been raised as to its ultimate success.

Sir Lowthian Bell has also met with considerable encouragement in experiments with molten cast iron and fluid oxide of iron at comparatively low temperatures,* and the "washing" process thus invented was adopted by Krupp, at Essen, for the partial dephosphorisation of pig iron before using it for other purposes. G. J. Snelus had, moreover, very nearly reached a successful solution of the problem when in 1872 he patented the use of lime or limestone, magnesian or otherwise, in all forms for lining furnaces in which metals or oxides are melted or operated upon when fluid; and this inventor actually did line a small Bessemer vessel with lime and produce a hundredweight or more of dephosphorised iron from Cleveland pig at the time of which we are speaking.

Thomas and Gilchrist.—The names of Sidney Gilchrist Thomas and of his cousin, Percy C. Gilchrist, will always be associated with the practical solution of this great problem, and to them alone is due the credit of ultimately bringing the matter to a successful issue.

Thomas was born in 1850, and educated at Dulwich College, intending to follow the medical profession. By the death of his father he was compelled to enter the Civil Service, in which he remained until 1879; his evenings were, however, devoted to scientific study, and he took the opportunity of entering for the examinations of the School of Mines, though unable to attend the classes. Gilchrist was a year younger, was educated at the Royal School of Mines, where he took his Associateship in 1871, and was then appointed chemist at Cwm-Avon, in Wales, though he shortly afterwards moved to Blaenavon, under the management of E. P. Martin. The original conception of the invention appeared to have been due to Thomas, though the earlier trials, and all the analyses, were conducted by Gilchrist, who not only took an equal share in all the earlier work, but had also to guard the interests involved in the patents after the untimely death of his cousin, which took place but a few years after the success of the process had been publicly demon-

* *Inst. Journ.*, 1878, vol. i., p. 17.

strated. The essential idea of the invention consisted in the substitution of a basic lining, instead of the acid material previously used in the Bessemer and Siemens processes, and the addition of a quantity of quicklime during the operation, so as to combine with the silicon and phosphorus, and thus to save the lining as much as possible. The lining was composed of well burned or "shrunk" lime, made from dolomite or magnesian limestone, which was finely ground and mixed with dry tar, as suggested by E. Riley, so as to allow of its being pressed into bricks which were afterwards baked, or of being rammed, so as to form a lining to the converter.

The first public announcement of the success of the basic process was made by Thomas in the spring of 1878 at the meeting of the Iron and Steel Institute, during the discussion of a paper by Sir L. Bell on "The Separation of Phosphorus from Pig Iron." On this occasion, Thomas is reported to have stated that "he had succeeded in effecting the almost complete removal of phosphorus in the Bessemer process. Experiments had been carried on at Blaenavon, with the co-operation of E. P. Martin, on quantities varying between 6 lbs. and 6 cwts., and some hundreds of analyses by Gilchrist, who had had the conduct of the experiments from the first, showed a removal of from 20 to 99.9 per cent. of phosphorus in the converter. He believed that the practical difficulties had been now overcome, and that Cleveland pig iron might be made into good steel without any intermediate process."*

The announcement thus made attracted little attention, and a paper, which the inventors prepared on the subject for the next meeting of the Institute, attracted so little interest that it was deferred till the spring meeting of 1879. In the meantime, the matter had been taken up by E. Windsor Richards, who was then manager at the works of Bolckow, Vaughan & Co., Middlesbrough, and with this powerful aid, the success of the invention on the large scale was amply shown, and a public demonstration was given on April 4, 1879. Middlesbrough was soon besieged by an army of metallurgists from Germany, Belgium, France, and America, all of whom were anxious to have an opportunity of seeing the process in operation, and the extension of the process has since been steady, uninterrupted, and even more rapid than that of the Bessemer process itself. Basic steel is produced in considerable and steadily increasing quantities in the United Kingdom, especially for metal which is low in carbon; but the chief extension has been on the Continent of Europe, particularly in Germany, where large deposits of phosphoric ores are met with, which could not otherwise be employed for the manufacture of steel; and the annual production of basic steel in Germany is now more than one

* *Inst. Journ.*, 1878, vol. i., p. 40.

million tons, the greater part of which is very low in carbon. This is more correctly called "weld or ingot iron" than steel, as it welds readily, and possesses many of the properties of wrought iron, the chief difference being that, owing to its having been produced in the fluid condition, and the consequently more perfect elimination of slag, it does not possess that fibrous structure which is characteristic of wrought iron. In many respects, however, mild steel is superior to wrought iron, and its use is now steadily increasing year by year.

CHAPTER IV.

CHIEF IRON ORES.

What Constitutes an Iron Ore.—The term “ore” is applied to the metalliferous material in the form in which it occurs in nature. These materials are not unfrequently met with in the form of crystallised minerals of great chemical purity, but such cases are comparatively rare, and of but little importance to the manufacturer. Usually the valuable portion is associated with more or less earthy or other foreign matter which is known as “gangue”; in mining with veins or lodes the gangue is frequently called “matrix” or “vein-stuff.” The proportion of metal which must be present before an ore can be worked with profit, depends both on the intrinsic value of the metal itself, and also on local conditions, such as cost of fuel, labour, and carriage. In the case of silver ores, for example, it is usual to regard 3 ounces to the ton as the minimum which can be profitably worked, or in other words, one part of silver can be extracted from about 10,000 parts of ore without pecuniary loss; with gold ores even less than one-fiftieth part of this, or one part in 500,000, can be worked with profit under favourable conditions. But in dealing with iron ores, on account of the low intrinsic value of the metal, and the relatively high cost of the processes of extraction, it is necessary to observe—

(1) That the proportion of iron present should be considerable. The poorest ores smelted in the United Kingdom are those of Cleveland, which contain about one-third of their weight of metallic iron, while the poorest ores regularly smelted in the United States are the “lean” ores of Ohio, which yield only one-fourth of their weight of metal. It is true that occasionally even poorer materials are employed, but in such cases there are special reasons, such as the presence of fluxing materials in the gangue, which may make the ore valuable.

(2) Ores of iron must also be free, or relatively free, from such elements as sulphur and phosphorus if they are to be of value to the smelter; the immense deposits of iron pyrites which occur in Spain and elsewhere are thus not available as a source of iron unless the sulphur has been previously eliminated. Unfortunately, at present, no method is known whereby phosphates can be economically removed from iron ores previously

to their being smelted in the blast furnace, except to a limited extent by means of magnetic concentration.

(3) It is further necessary that any material which it is proposed to employ as a source of iron should be plentiful before it can be of real value in a modern iron works. A blast-furnace plant of modest dimensions would produce 1,000 tons of pig iron per week, or 50,000 tons per annum; the ore would seldom average more than 50 per cent. of metallic iron, so that upwards of 100,000 tons of ore would be required each year. Such a plant would be expected to run at least ten years to repay the original outlay, hence it would be useless to commence smelting with less than a million tons of ore in prospect, and a larger works of modern construction would require a proportionally larger quantity.

(4) The associated gangue must be of such a character that it can be readily and economically fluxed in the blast furnace, the presence of titanium or other material which interferes with the regular working of the furnace being objectionable.

Iron ores to be valuable must thus be rich, pure, plentiful, and easily reduced; practically it is found that only the oxidised compounds—*i.e.*, the oxides and carbonates, fulfil these conditions.

Classification of Iron Ores.—The ores of iron may be arranged according to the following general classification:—

I. *Magnetic Oxide or Magnetite.*

a. Pure magnetites.

b. Magnetites in which part of the oxide of iron has been replaced by the oxide of another metal—*e.g.*, chromium (chromite), titanium (ilmenite), or zinc (franklinite).

II. *Ferric Oxide or Hæmatite.*

a. Anhydrous ferric oxide or red hæmatite.

b. Hydrated ferric oxide, including brown hæmatite, limonite, bog ore, laterite, &c.

III. *Ferrous Carbonate or Spathic Ores.*

a. Pure spathic ores.

b. Carbonate ores associated with clay (clay ironstones, argillaceous ores) or with bituminous matter (blackband).

Ferrous oxide (FeO) is not stable in the air, but absorbs oxygen, becoming ultimately converted into ferric oxide, which is unaffected by exposure to air or moisture. Ferric oxide (Fe_2O_3) is unaffected by a red heat in the absence of reducing agents, though at extremely high temperatures it loses some of its oxygen and is converted into magnetic oxide. Ferrous oxide

never occurs free in nature, but being more stable when in a state of combination, is met with combined with carbon dioxide as ferrous carbonate (FeCO_3), with silica in various silicates, and with ferric oxide in magnetite (Fe_3O_3 , FeO , or Fe_3O_4). Ferric oxide combines with water in different proportions, producing what are known as hydrated oxides. Artificially prepared ferric hydrate is a reddish-brown bulky solid, and has the formula $\text{Fe}_2\text{O}_3 \cdot 3\text{H}_2\text{O}$; on drying in the air, or at a temperature not exceeding 100°C ., this loses part of its water, and approximates to $2\text{Fe}_2\text{O}_3 \cdot 3\text{H}_2\text{O}$, which has a yellowish-brown colour, and, when native, is called brown hæmatite. If brown hæmatite be heated to a temperature exceeding 200°C ., the whole of its water is eliminated, and ferric oxide is obtained.

I. MAGNETITES.

(a) **Pure Magnetites.**—Magnetite occurs in the pure form, imbedded in chlorite schist in well-defined octahedral crystals, which are sometimes as much as an inch in length, and which frequently exhibit polar magnetism; these are collected by the natives of India, who are aware of this magnetic property, and the crystals are strung together like beads. From these exceptionally large crystals all gradations of size are found down to the massive variety in which the constituent crystals are indistinguishable to the naked eye. The hardness of magnetite on Moh's scale is 6, its density is about 5; it is brittle, and gives a black streak when rubbed on a hard and slightly-roughened surface. It is always attracted by a magnet, even when itself not magnetic; its colour is black, with a well-defined metallic or sub-metallic lustre, though when weathered the surface assumes a brown tint. Magnetite is the richest ore of iron, and when pure contains 72.4 per cent. of metal; it is met with in immense quantities in Sweden, in parts of North America, particularly in the Lake Superior district, and in the southern portions of the Madras Presidency in India. The development of the magnetic ores of the Salem district of the Madras Presidency is among the most remarkable facts connected with the geology of India, and, owing to the persistency of the ore beds, they often furnish an admirable clue to the geology of the district. These beds are occasionally as much as 50 to 100 feet in thickness, and where they are steeply inclined an enormous quantity of ore is laid bare in ridges and precipices. Iron ore is to be obtained in this region, of the best quality, in quantities which can only be estimated in thousands of millions of tons; but the scarcity of fuel in the district, and the cost of transit have hitherto combined to prevent the working of these deposits on a large scale.* The

* V. Ball, *Geology of India*, vol. iii., p. 348.

magnetic ores of the Lake Superior district are of at least equal magnitude, and are for the most part of Bessemer quality,* while owing to the facilities for cheap transit to Pennsylvanian and other furnaces, these deposits have been worked on a large and rapidly-increasing scale during recent years. The magnetites of Sweden have long been famed for their special purity, the name of Dannemora having a world-wide reputation. The iron ores of Dannemora are stated to have been worked in the thirteenth century, and consist of a series of lenticular deposits in a band of limestone, surrounded by granites and other crystalline rocks. The ore deposit as worked is some 2,000 yards long by 200 yards wide, while the workings are over 200 yards deep, and the annual production is about 35,000 tons of ore. This contains from 66 to 72 per cent. of magnetic oxide of iron, 9 to 15 per cent. of silica, .002 to .009 per cent. of phosphorus pentoxide, together with some 10 per cent. of lime and magnesia. The ores are comparatively rich in sulphur, and are consequently roasted before smelting.† Since 1870 a steadily-increasing export trade in magnetic ore has been developed in Scandinavia, nearly half a million tons being exported from Sweden in 1893; the greater part of this was used in Germany, though some is imported into the United Kingdom. The ore is sold in several grades, some being remarkably pure, while other grades are phosphoric, and are used for basic pig. An account of these deposits, with illustrations of the method of mining, has been given by Jeremiah Head.‡ In smaller quantities magnetite occurs throughout Europe, in the West of England, and in North Wales in connection with metamorphic rocks.

In workable magnetic ores the gangue generally exceeds 10 per cent., and usually consists of quartz or some other form of siliceous matter; in some cases silica and lime occur in such proportions as to form a self-fluxing ore in the blast furnace. Magnetic ores are generally very free from phosphorus and sulphur. In some cases calcium phosphate, or apatite, occurs in the form of olive-coloured scales or particles, distributed throughout the mass, and these can be, to a considerable extent, separated by magnetic concentration. In other instances, iron pyrites (FeS_2) is met with in small grains or crystals disseminated through the ore, in which case the material is generally weathered or calcined before smelting.

(b) **Impure Magnetites.**—In addition to the relatively pure magnetites above described, other varieties occur in which either the ferrous or the ferric oxide is replaced by the oxide of another metal. The most important of these are the following:—

(1) *Franklinite* or *zincite*, which occurs in the metamorphic

* *Inst. Journ.*, 1887, vol. ii., p. 220.

† *Ibid.*, 1894, vol. i., p. 408.

‡ *Ibid.*, p. 47.

rocks of New Jersey in the United States. In this ore the ferrous oxide, which usually occurs in magnetite, is to a greater or less extent replaced by oxide of zinc. This oxide of zinc is, however, not pure, but is associated with manganese, which imparts a reddish colour. Franklinite generally contains about 30 per cent. of ferric oxide, 15 per cent. manganous oxide, 30 per cent. of zinc oxide, and 10 per cent. of silica, together with some lime, alumina, and magnesia. The ore is first subjected to a distillation in the zinc works to remove this metal, and is afterwards smelted in the blast furnace for the production of a manganiferous iron, called "spiegel-eisen," which, in this instance, contains about 20 per cent. of manganese.*

(2) *Ilmenite* or *titanic iron ore* is met with in immense deposits in the massive form in Norway, and to a smaller extent as sands in the United States, Canada, India, and New Zealand. It contains titanium in the form of oxide (TiO_2). This is somewhat difficult to smelt in the blast furnace, owing to the formation of a curious substance known as cyano-nitride of titanium, which collects in the hearth of the furnace, and which resembles crystals of bright metallic copper. The slags produced are also less fusible than usual, and hence ilmenite is seldom employed in the blast furnace. It has been used successfully as a fettling in the puddling furnace in Henderson's process, and was employed for twelve years at Tondü, near Bridge End, S. Wales, though experiments conducted in the ordinary puddling furnace in South Staffordshire were not successful. It was experimented on by the late David Mushet, who took out no less than thirteen patents for its application, chiefly for the purpose of steel making. Mushet's partner, T. D. Clare, introduced the use of finely powdered ilmenite as a protection for iron work, under the name of "titanic paint," which has been used with advantage on many important structures; finely powdered ilmenite also makes a capital knife polish. According to Koenig and Pforten† the formula for titanic iron ore is FeTiO_3 .

(3) *Chrome iron ore* or *chromite* contains oxide of chromium (Cr_2O_3) replacing part of the ferric oxide of ordinary magnetite. It is the source of the chromates, and thus of the colouring matter in many pigments, glasses, and enamels. It occurs in metamorphic rocks in Canada, Germany, Sweden, India, and elsewhere, though usually in comparatively small quantities. It is smelted in the blast furnace for the production of chrome pig iron, the chief application of which is in the manufacture of steel of special hardness. It is usually neutral or somewhat basic in character, and in the absence of reducing agents is very refractory. Some of the best varieties are infusible even in the oxyhydrogen flame, and are unaffected by fluid oxide

* *Inst. Journ.*, 1894, vol. i., p. 416.

† *Berichte*, vol. xxii., p. 1485.

of iron at high temperatures; on this account chrome iron ore, though costly, is sometimes employed as a furnace lining. In appearance chromite closely resembles magnetite, having a black colour and a sub-metallic lustre; it crystallises in the same form as magnetite, its density and hardness are nearly the same, and it is sometimes magnetic. It may, however, be distinguished by the colour of its streak, or powder, which is brownish-grey, while that of magnetite is black. Some of the richer samples of chrome ore have a distinct olive-green colour.

II. FERRIC OXIDE OR HÆMATITE.

(a) **Anhydrous.**—Red hæmatite is a general term applied to a number of minerals, all of which consist essentially of anhydrous ferric oxide (Fe_2O_3), and which give a red streak; in many cases also these ores possess a distinct red colour, though this is by no means always so. Red oxide of iron is prepared artificially, by heating ferrous sulphate ($\text{FeSO}_4 \cdot 7\text{H}_2\text{O}$) in a closed vessel to a red heat, and by other processes; it is the basis of many red paints, and is used by the jeweller as “rouge.” The colour of this oxide varies according to the method of preparation, and it is said that as many as 300 varieties or shades of colour are recognised in the trade. When heated to a high temperature the bright-red colour changes to a purple shade, and at a still higher temperature the oxide becomes almost black, at the same time bright glistening particles are seen. That no chemical change has taken place is shown by the fact that if this dense black oxide be ground finely and levigated with water, it becomes once again distinctly red, and the brightness of the tint improves as the particles become more and more finely divided. The shade is also brighter in the presence of a sulphate than with a chloride, and on this account it is not unusual to add alum or other sulphates when producing the more vivid shades.

Red hæmatite is occasionally met with in the crystallised form, and is then in small irregular crystals; its maximum hardness is 6 on Moh's scale, and its greatest density about 5.2; many varieties are, however, much more porous and soft. A special variety also occurs in octahedral crystals, and is known as marlite. Among the more important varieties of this ore the following may be mentioned:—

(1) *Specular iron ore* is a very pure form occurring in brilliant crystals which are often iridescent on the surface; it is met with in the Island of Elba and in a few other localities in Europe, and occurs in large quantities in Canada, the United States, in the Iron Mountain in Mexico, and in the Central Provinces of India.

(2) *Micaceous iron ore* is a pure variety which occurs in large

quantity, and has been long worked in the Lake Superior district of North America. In appearance it is often a very beautiful mineral; the glistening dark-grey scales are not unlike mica, and from this the name is derived. The red hæmatite of Cumberland not unfrequently has a dark grey colour also, when very compact.

(3) *Kidney ore* is a common form in Cumberland; this occurs in radiating masses, made up of concentric layers with smooth reniform (or kidney-shaped) surfaces; it is generally bright-red in colour, and has a characteristic radiated or conchoidal fracture.

(4) Much of the hæmatite of Cumberland and the red fossil ore of the United States is met with in the *earthy* form; it varies in colour from dark-red to bright-red, and has a characteristic unctuous (or soapy) feel when rubbed between the fingers. The hæmatites of Cumberland are very free from phosphorus, and their modern development dates from about the year 1865, when the commercial success of the Bessemer process led to the demand for a pig iron free from phosphorus, and to the establishment of the Barrow Hæmatite Company's works. In Cumberland this ore does not occur in beds, but in large irregular deposits or pockets in the carboniferous limestone; these are worked by a modified pillar and stall method. (See p. 71.) The geological characters of these deposits have been considered by J. L. Shaw.*

The deposits of *red fossil ore* which occur in the United States run southward from Central New York, through Pennsylvania, to the immense beds of Alabama. These ores are usually self-fluxing, but contain about 0·5 per cent. of phosphorus. Usually two beds of ore occur, one hard and the other soft; in Alabama both hard and soft ore are used, and are met with in beds from 20 to 30 feet thick. The following figures, taken from a paper by W. J. Keep and the author,† illustrate the composition of these ores:—

	Clinton Soft. (Abandoned.)	Clinton Hard. (Used.)	Alabama Hard.	Alabama Soft.
Metallic Iron,	30·08	47·50	36·00	50·00
Silica,	29·72	11·20	8·00	18·00
Alumina,	4·13	4·89
Lime,	8·57	5·53	38·00	...
Manganese,	·31	·10	trace	trace
Phosphorus,	·67	·52	·42	·70
Sulphur,	·837	·18

When pure, ferric oxide contains 70 per cent. of metallic iron,

* *Inst. Journ.*, 1892, vol. ii., p. 306.

† *S. Staff. Inst.*, March, 1888.

but the ores worked in the United Kingdom usually contain not more than 60 per cent. of iron, the chief constituent of the gangue being silica.

(b) **Hydrated Oxides.**—The proportion of water which exists in a state of combination in hydrated oxides of iron is usually from 10 to 15 per cent., though this is by no means constant in quantity. In nature all stages of hydration are met with, from ferric oxide to ferric hydrate. As the proportion of water increases, the colour of the ore changes from bright-red to brown or yellow, and with much water the tint is frequently a dark brown. Many varieties of the Spanish "rubio" ores are red in colour, and frequently resemble red hæmatite; other samples contain more water, and resemble ordinary brown hæmatite in appearance. Millions of tons of these ores are now imported into the United Kingdom per annum, and on account of their richness in metallic iron, which amounts to nearly 60 per cent., their freedom from phosphorus, and their easy reducibility, Spanish ores are largely employed, particularly in South Wales and Cleveland, for the production of pig iron of Bessemer quality. The hæmatites of the Forest of Dean, in Gloucestershire, were worked during the Roman occupation of Britain, and are still mined, though on a comparatively moderate scale. This ore is red in colour, and generally contains less than 10 per cent. of combined water. It occurs in "churns" or pockets in the upper beds of the carboniferous limestone, and contains about 0.04 per cent. of phosphorus, which is slightly more than is present in Bessemer ores of the best quality.

Brown hæmatite is a general term applied to a number of minerals, all of which consist essentially of hydrated ferric oxide; they vary in colour from bright yellow, passing through brown, to almost black, but all agree in yielding a brown or yellow streak; these minerals may be divided into two classes—

(1) *Goethite* ($\text{Fe}_2\text{O}_3 \cdot \text{H}_2\text{O}$) usually occurs in well-formed and brilliant crystals, but is also met with in other forms in Cornwall and in numerous localities on the Continent; when pure it contains about 63 per cent. of metallic iron.

(2) *Limonite* ($2\text{Fe}_2\text{O}_3 \cdot 3\text{H}_2\text{O}$) is commercially of much greater importance. It most commonly occurs in the earthy form, but also in radiated concretions with reniform exterior, and in cellular and compact masses. Some of the finer varieties are employed as pigments, such as ochre, umber, &c. The brown hæmatite of Northamptonshire occurs in beds in the oolite formation, which stretch into Lincolnshire and Oxfordshire. It usually contains at least 10 per cent. of combined water, from 10 to 20 per cent. of silica, and about 0.6 per cent. of phosphorus. The ores as brought from the mines contain about 45 per cent. of metallic iron.

The brown hæmatite deposits of Luxemburg-Lorraine are

among the most important in Europe. The ore, which closely resembles that of Northamptonshire, is known as *minette*, and occurs in the form of oolitic grains, about the size of a pin's head, which are cemented together by calcareous, argillaceous, or siliceous material. It varies considerably in composition, samples which contain less than 27 per cent. of metallic iron not being considered suitable for smelting purposes. As the gangue is in some instances siliceous, and in others calcareous, self-fluxing mixtures are prepared, and the addition of lime is unnecessary. The ores which are smelted in the district contain about 31 per cent. of metallic iron, while those which are sent down the Rhine are somewhat richer, and yield 38·5 per cent. of iron and 10 per cent. of water. These ores are phosphoric, containing 0·5 to 2·0 per cent. of phosphorus, and their use has enormously increased since the introduction of the basic process of steel-making.* Other examples of brown hæmatite are met with in the bog ores of Ireland, and the ore which is dredged during the early winter months from the bottom of the shallow lakes in Sweden and Canada; such ores are frequently very rich in phosphorus. Analyses of a number of these will be found in Percy's *Iron and Steel*, p. 324. Brown hæmatites derive much of their value from the readiness with which they can be mined, and the ease with which they are reduced in the blast furnace.

Laterite is a generic term applied to a group of tertiary rocks which occupy an important position in the superficial geology of India. The character common to all of them is the presence of a considerable proportion of iron, in the form of hydrated brown oxide; the reddish-brown colour, and the fact that this stone is commonly employed for building purposes, has led to the adoption of the name, which is derived from "*lateritis*," a brick. Laterite varies considerably in character, both as regards richness in iron and in structure; it is usually quite soft when first cut, but hardens on exposure to the atmosphere. Only the richer kinds are employed as a source of iron, and these at present to a very moderate extent.†

III. CARBONATE ORES.

The ores which consist essentially of ferrous carbonate, are of great interest, whether considered from the point of view either of their history, their distribution, or their importance; they may be conveniently divided into four classes—

(a) **Spathic Iron Ore** is the purest form in which ferrous carbonate occurs in nature, and contains a maximum of $48\frac{1}{2}$ per cent. of metallic iron. It is sometimes met with in distinct

* E. Schroedter, *Inst. Journ.*, 1889, vol. i., p. 114; also Wandeleben, *ibid.*, 1890, vol. ii., p. 655.

† Ball, *Geology of India*, vol. iii., p. 549.

crystals, with a pearly lustre, in the mineral chalybite or siderite; in the massive form it occurs in immense deposits in Styria, at Eisenerz; its colour varies from pearly white, through various shades of pink and red, to brown or nearly black, the last-mentioned tints being produced by exposure. The deposits in Styria are very free from phosphorus and other objectionable impurities, but usually contain a somewhat considerable proportion of manganese; not unfrequently the quantity of manganese is sufficient to allow of the ores being employed for the production of spiegel-eisen. Considerable deposits of spathic ore are also worked in Westphalia, and other parts of Germany.

(b) **Impure Carbonates.**—(1) *Clay ironstone* is the historic ore of Staffordshire, South Wales, and West Yorkshire. It consists of ferrous carbonate, with some 15 per cent. of clayey matter, and on this account is often referred to as *argillaceous iron ore*. It occurs in the coal measures, in beds which are mined in a similar manner to the adjacent coal. It varies in colour from light brown to dark grey, and often occurs in nodular masses. In Staffordshire a number of varieties are locally recognised which have received such names as brooch-stone, lamb-stone, pudding-stone, white-stone, &c. The clay ironstones of Great Britain are becoming to a great extent worked out, so far, at all events, as the best qualities are concerned, their place being taken by native or imported hæmatites. Clay ironstones are also expensive to mine, as much shale has to be removed in proportion to the ore raised, and the amount of iron is relatively low, being seldom more than 40 and generally only from 30 to 35 per cent. Staffordshire clay ironstone of good quality contains about 0.25 per cent. of phosphorus, and the pig iron obtained therefrom is of special reputation for the production of wrought iron of the best quality, and for strong castings. In clay ironstone the proportion of silica to alumina is fairly constant, and is generally about as 2 to 1.

(2) *Cleveland ironstone* is a less pure form of clay ironstone, which occurs in large masses in the Lias formation of the Cleveland Hills, in the West Riding of Yorkshire; it is now mined in larger quantities than any other ore in the United Kingdom. It is found in beds which are of uniform composition over considerable areas, and contains about 33 per cent. of metallic iron. It also contains about 0.75 per cent. of phosphorus, while the gangue consists of clay, with calcium and magnesium carbonates in sufficient quantities to be self-fluxing or nearly so, though it is necessary to add limestone in the blast furnace, as otherwise the iron obtained is inferior. The pig iron produced contains about 1.6 per cent. of phosphorus, and is one of the lowest-priced irons in the United Kingdom. An interesting account of the geological characters of the Cleveland district, and of the history of its early development has been given by Bewick in his

Geology of Cleveland, published in 1861. The ore occurs in the Middle Lias, and is divided by bands of shale and pyrites into several beds; where best developed it has a thickness of over 20 feet, the two principal beds being called respectively the *pecten* and the *avicula* seams, from their characteristic fossil shells. The usual colour of the ore is a dull bluish-green, caused by the presence of silicate of iron; it has an oolitic structure, and is fossiliferous. The main bed attains its greatest thickness at Eston; the whole of the workable ironstone is in the highest part of the Middle Lias, and the yield per acre reaches as much as 50,000 tons.* The "main seam" is the one first opened by Mr. John Vaughan, and is now the only one worked. The duration of the best deposits, at the present rate of consumption, is estimated at nearly sixty years.†

(3) *Blackband Ironstone*.—A variety of clay ironstone occurs in Linlithgow and Lanark (in Scotland), in North Staffordshire, and to a smaller extent in South Wales and Western Pennsylvania, which is impregnated with carbonaceous matter to the extent of some 15 per cent. On account of its black colour and stratified condition it has received the name of "blackband." It was first discovered by Mushet, in Lanarkshire, in 1801; but the supply is rapidly becoming exhausted. It is valuable because the carbonaceous matter present, which generally varies from 10 to 25 per cent. of the ore, is sufficient to allow of its calcination without the employment of any additional fuel; when calcined the residue contains from 50 to 70 per cent. of metallic iron. A specially pure variety of this calcined ore, rich in manganese, is obtained from North Staffordshire, and is employed, under the name of "pottery-mine," as a fettling in puddling furnaces, and for this purpose is in great repute.

Chemical Composition of Iron Ores.—The varieties of spathic ore which are specially valued for the production of the highest class of iron and steel, are those which are rich in manganese, and which at the same time contain but little phosphorus; it is noticed that generally in carbonate ores these characters accompany each other. Thus the proportion of phosphorus in the spathic ores of Styria and Carinthia is very small, clay ironstone contains more phosphorus, while Cleveland iron-

* Phillips, *Ore Deposits*, p. 174.

† On the geology of the Cleveland ores, see Tate and Blake, *The Yorkshire Lias*, p. 18; and *Pro. International Geological Congress*, 1888, p. 378. On the methods of mining these deposits, see A. L. Steavenson, *Inst. Journ.*, 1874, p. 329; 1893, vol. ii., p. 45. According to Snelus, ores of very similar character occur in large quantity in China, near Hankow, where modern iron works on an extensive scale were commenced in 1890, and are now completed. In addition to these carbonate ores, however, there are in the same province considerable deposits of rich hæmatite, which in purity and richness closely resemble those of Bilbao (*Engin. Review*, 1894, p. 51).

APPROXIMATE COMPOSITION OF CHIEF IRON ORES.

	Swedish Magnetite.	Red Hematite, Cumberland.	Red Spanish Ore, Bilbao.	Forest of Dean Hematite.	Brown Spanish Ore.	Northampton Brown Hematite.	Styrian Spathic.	Staffordshire Ironstone.	Cleveland Ironstone.	Blackband, Scotland.
Ferric oxide (Fe_2O_3),	65	90	70	90	71	65	...	0.5	3	2.5
Ferrous oxide (FeO),	25	50	47	40	41
Manganous oxide (MnO),	1	0.5	10	2	1	1
Carbon dioxide (CO_2),	3	38	30	25	26
Silica (SiO_2),	10	6	7	1	8.5	13	...	10	8	7
Alumina (Al_2O_3),	...	1	1	...	1.5	3	...	5	7	3
Lime (CaO),	...	1	5	...	1	variable	2	2	7	2
Magnesia (MgO),	1	2	4	1
Phosphoric anhydride (P_2O_5),	0.03	0.04	0.03	0.07	0.04	1.3	0.04	0.04	1.6	0.5
Water,	12	9	18	14	...	1	3.4	1
Organic matter,	trace	trace	15

Upwards of a hundred detailed analyses, chiefly of British ores, have been given by Dr. Percy.* An account of the history, characters, and mode of extraction of the *Iron Ores of Great Britain and Ireland* has been published by J. D. Kendall, in which the information is brought up to the year 1893; H. Carnot has also tabulated about 1800 analyses of the iron ores of France and Algeria, giving details of their geological distribution.† J. F. Kemp has published a book on the deposits of the United States; nearly a hundred analyses of Lake Superior ores are given by G. W. Goetz,‡ while a most useful series of articles on this subject will be found in *Iron*, 1888, vol. i., pp. 73, 164, 338, 550. To these and similar sources the student is referred for fuller information.

* *Annates des Mines*, vol. xviii., pp. 1-163.

† *Inst. Journ.*, 1890, vol. ii., p. 666.

‡ *Iron and Steel*, p. 204.

stone contains still more. On the other hand, Cleveland ore carries least manganese, while the Styrian ores contain the largest proportion of manganese, and are thus employed for the production of manganiferous irons known as "spiegel-eisen."

Iron ores are subject to considerable variations in composition and character, even when taken from the same mine, and the table on p. 60, which gives the approximate composition of certain representative iron ores, must be regarded merely as giving a general indication of the usual proportions of the substances mentioned.

For commercial purposes it is usual to classify iron ores as phosphoric or non-phosphoric. The latter class includes all ores which are sufficiently free from phosphorus, to permit of their use in acid steel making; the limit for this purpose is generally taken as 0·04 per cent. of phosphorus in the pig iron.

		Phosphorus per cent. in pig iron.
Non-phosphoric,	Swedish magnetites, . . .	trace to 0·06.
	Cumberland hæmatite, . . .	0·04 to 0·06.
	Spanish ore, red, yellow, or brown, . . .	0·04 to 0·06.
	Forest of Dean,	0·07.
Phosphoric,	Purple ore (Blue Billy), . . .	0·10.
	Lake Superior magnetites, . . .	variable, about 0·10.
	South Staffordshire,	0·40 to 0·60.
	Leicestershire,	0·60.
	Blackband,	0·60.
	American red fossil ore,	about 0·60.
	North Staffordshire,	0·80 to 1·00.
	Rhenish brown hæmatites,	about 1·00.
	Northampton,	1·0 to 1·5.
	Cleveland,	1·10 to 1·75.
Lake and Bog ores,	variable, about 2·0.	

Formation of Iron Ores.—In nature iron compounds are constantly being removed from some places and deposited in others, chiefly by the action of air, water, and carbon dioxide, and it is probable that all the deposits of iron ore with which we are familiar were produced by agencies such as are at present in operation, only extended over an indefinite period of time. As first pointed out by Kindler in 1836, ferric oxide is dissolved by water containing organic acids in solution, such as surface drainage from cultivated or peaty soil, and this effect is often visible in the bleaching of red or yellow sands in a railway or other cutting for some feet immediately below the surface vegetation. R. Hunt afterwards proved that decomposing vegetable matter not only prevents the oxidation of ferrous compounds, but actually reduces ferric to ferrous oxide, while at the same time carbon dioxide is produced. The ferrous oxide and carbon dioxide combine to form ferrous carbonate, which may be de-

posited as it is formed, since it is not soluble in water.* It is, however, well known that ferrous carbonate is soluble in water in the presence of carbonic acid, and the number of mineral waters which owe their characteristic virtues to iron so dissolved is considerable. A solution thus rich in iron if allowed to slowly evaporate, out of contact with air, would deposit ferrous carbonate, either in the form of crystals, or in the sparry form resembling calcium carbonate; such deposits are familiar in the sparry forms of chalybite, which are often met with in mineral veins, and which occur in a less pure form in clay ironstone. In the case of massive deposits it is evident that in some cases, at least, the ferrous carbonate was not deposited by mere evaporation, but by replacement of the material which was originally present, such, for instance, as limestone. An example of this replacement, by means of ferrous carbonate in solution, is afforded by the enormous deposit of spathic ore which constitutes the Erzberg, in Styria. In this case the gradual change in the character of the deposit from the limestone of the district into nearly pure chalybite, can be readily traced, and all the stages in the process can be fully observed. Though in the absence of air a deposit of ferrous carbonate may be produced from the solution in carbonic acid water, either by removal of the free carbonic acid, by evaporation, or by replacement, the action will be quite different if the solution be allowed to oxidise in the atmosphere; in this case the carbon dioxide will be evolved, and oxygen will be absorbed, resulting in the production of a precipitate of hydrated ferric oxide, or brown hæmatite. If the solution of iron be oxidised in a pool or lake, this deposit will take the form of bog ore, while if the deposit be formed *in situ*, or if by subsequent changes the bog ore be partially dried, ordinary brown hæmatite will be produced. It is also a very common observation that where carbonate ores are exposed to the action of the atmosphere, a brown coating is produced; iron pyrites is oxidised in a similar manner. When dense spathic ores are thus weathered, the result is usually the production of limonite, and on the Erzberg beautiful specimens are met with which are internally unaltered spathic ore, and externally converted into limonite, a perfectly sharp line of demarcation being visible.

The ores of Lincolnshire and Northamptonshire were originally in the form of a bed of clay ironstone, 10 to 20 feet in thickness, and often containing much calcium carbonate. Owing to its proximity to the surface the ore, originally in the form of carbonate, has been converted into brown hæmatite.

The following analyses, quoted by Sir L. Bell from Dr. Percy, exhibit the nature of the changes which result in the conver-

* Lyell, *Elements of Geology*, p. 395.

sion of ferrous carbonate into brown hæmatite,* ferrous oxide being oxidised to ferric oxide and water absorbed:—

Ferrous oxide (FeO), . . .	49·77	10·77	...
Ferric oxide (Fe ₂ O ₃), . . .	0·81	49·57	73·08
Manganous oxide (MnO), . . .	1·93	3·06	6·60
Earthy matter, &c., . . .	9·99	13·66	7·57
Carbon dioxide (CO ₂), . . .	37·20	14·49	0·13
Phosphorus pentoxide (P ₂ O ₅), trace		0·01	0·22
Water,	0·30	8·44	12·40

Sir L. Bell has discussed the geological formation of iron ores at some length,† while H. V. Winchell has also written on the same subject.‡

Brown hæmatite is thus formed by the oxidation of pyrites or of ferrous carbonate, either when in solution or in the solid form. But when any hydrated oxide of iron is heated to a moderate temperature, which need not much exceed 200° C., practically the whole of the water is driven off, the brown colour of the ore disappears, and a bright red ferric oxide is obtained.

In this manner, it is quite easy to see how in nature red hæmatite may be produced from brown hæmatite by the simple removal of water. But if ferrous carbonate be subjected to a moderately high temperature in contact with steam, and out of contact with air, carbon dioxide is given off, the water is in part decomposed, and magnetic oxide produced. Or if the red hæmatite be simply heated to a very high temperature out of contact with air, oxygen would be given off, and magnetic oxide produced. Thus, starting with iron in solution in the form of ferrous carbonate, it would be possible by a series of reactions of the simplest kind, and such also as are going on in nature every day, to produce all the known oxidised ores of iron.

Geological Distribution of Iron Ores.—The geological distribution of iron ores is in harmony with what is here suggested. The carbonate ores belong in the main to an intermediate geological period, such, for instance, as the carboniferous; while brown hæmatites belong to more recent, or even, in many cases, to quite recent periods. Red hæmatites, again, are almost always older than carbonate ores, and have thus been more altered, but magnetites almost invariably belong to the oldest rocks with which we have to do in iron mining, and have, therefore, been subjected to the influence of the highest temperature, very probably while in contact with steam.

Thus in India magnetite is met with in beds or veins in most of the regions where metamorphic rocks occur. In the Salem district of the Madras Presidency magnetite occurs in almost unparalleled quantities, whole hills and ranges being formed of the purest varieties of this ore, and in many cases these deposits

* *Inst. Journ.*, 1892, vol. ii., p. 23.
1890, p. 96.

† *Inst. Journ.*, Amer., vol. for
‡ *Inst. Journ.*, 1893, vol. i., p. 178.

are not lodes but true beds, like the gneissose and schistose rock with which they are associated. The rich ores of central India, on the other hand, are principally found as hæmatites in the Bijawar or lower transition series of rocks, while the ironstone shales of the Raniganj coalfield belong to the carboniferous period. In the cretaceous rocks nodular iron ore occurs in quantity, and when fuel was more abundant was smelted to a considerable extent by the natives. The characteristic ore, laterite, belongs to a more recent period, though its exact age is doubtful in, at least, some cases; while, lastly, there are the more or less soft and decomposed ores, formed by the breaking up of the above deposits, and these are frequently preferred by the natives as being less difficult to mine and reduce.*

In the United States the chief ore deposits belong to three distinct geological periods. Lowest of all are the archæan ores, which are magnetites and hæmatites, and which occur in enormous masses. These are met with in the eastern portion of the State of New York, beginning near Lake Champlain, and running thence, always on the eastern side of the Alleghanies, through New Jersey and Eastern Pennsylvania, down to Northern Carolina. The deposits are believed to pass right under Western Pennsylvania and Ohio, and reappear at Pilot Knob, in Missouri, and in the enormous deposits of the Lake Superior region. Next in order is the red fossil ore, which occurs about the middle of the silurian formation, in beds known as the Clinton; this deposit runs nearly parallel with the outcrop of the magnetites, but some 100 to 200 miles further inland in the direction of the Mississippi. This ore is worked in New York, Pennsylvania, Ohio, Virginia, Tennessee, and Alabama. The third class consists of carbonates; they are relatively much less important, and occur in beds of the carboniferous period of about the same age and character as those in which the clay ironstone of the United Kingdom is met with. Each class of ore previously mentioned is accompanied with surface deposits of brown hæmatite, found chiefly in the upper silurian formation, and formed by the weathering of the older deposits. The ores of the United States thus occur in the same order as those of the United Kingdom, but they belong to relatively earlier geological periods (compare *Inst. Journ.*, Amer., vol. for 1890, p. 92).

With the exception of Alabama, and a few other favoured localities in the United States, the ore and fuel do not occur in the same vicinity, and it is stated that the average distance to which the materials to be used for iron smelting are transported is about 600 miles. The expense of collecting iron-making materials is thus much greater in the United States than in Great Britain. The exceptional facilities for transport afforded

* V. Ball, *Geology of India*, vol. iii., p. 335.

by the great lakes, the Hudson and St. Lawrence Rivers, and a great system of canals and railways, enable the ores of Lake Champlain, or of Lake Superior, to be conveyed to the coke of Western Pennsylvania, to the anthracite of the eastern portion of the same State, or to the coals of Ohio.*

A carefully prepared map of the United States, showing the position of the chief coalfields, and the geological and geographical distribution of the chief iron ores, has been published in the American Volume of the *Journal of the Iron and Steel Institute*, p. 68, and a geological account of the ores of the United States, was prepared by the late T. Sterry Hunt in 1890.† To these papers the student is referred for further information.

A valuable contribution to the geological history of iron ores has also been made W. H. Hudleston,‡ who states that the ores raised in the United Kingdom in 1881 may be classified as follows:—

Tertiary iron ores (Ireland),	Tons. 200,000
Jurassic „ (Cleveland, Lincoln, Northampton),	8,976,000
Permian „ (Lancashire, Cumberland),	2,805,000
Coal measure iron ores,	5,418,000
Ores older than coal measures,	238,000
	17,637,000

Phosphorus Content and Geological Age.—It is worthy of observation that, as a rule, to which, however, there are exceptions, the proportion of phosphorus present in iron ores, a factor which so largely influences their commercial value, is least in magnetites and other ores of ancient origin, while it is greater in recent than in earlier carbonate ores, greater again in brown hematites, and probably reaches its maximum in some samples of recent bog ores. It has been suggested by Sir L. Bell § that this apparent concentration of phosphorus in recent ores is due to the increase of life in modern as compared with earlier ages. While such an explanation is possible, it is not necessary to make any such assumption as to the amount of life upon the globe at different periods, as there are forces now at work which are quite sufficient to account for the removal of phosphorus from the older deposits if it were originally present. The phosphorus, according to the researches of J. E. Stead,|| exists in ores, not in combination with the iron, but in the form of calcium phosphate, and it may be extracted from the ore by digesting with sulphurous acid. Calcium phosphate is an essential material for the support of plant life, and is obtained by plants in the form of a solution of the monobasic phosphate in water containing carbonic acid. The nature of the changes which result in the conversion of insoluble tribasic calcium phosphate occurring in

* Keep and Turner, *S. Staff. Inst.*, March, 1888.

† *Inst. Journ.*, 1890, vol. ii., p. 28.

‡ *Proc. Geol. Assoc.*, vol. xi., p. 104; *Inst. Journ.*, 1889, vol. ii., p. 310.

§ *Inst. Journ.*, 1892, vol. ii., p. 22. || *Trans. Cleveland Eng.*, 1877, p. 132.

soils into soluble monobasic phosphate are well described by Professor Tanner.* When, on the other hand, iron has once been deposited as oxide, this is but little affected by carbonic acid water; the result is that the proportion of phosphate present in ores that have been long deposited may be expected to be less than in more recent ores, since calcium phosphate is removed by atmospheric agencies. It is unfortunate that this action is so slow that long geological periods are required for its accomplishment; for if the phosphorus could be efficiently removed by weathering in the ordinary way, or by some equally simple process, it would render available for the production of steel a number of ores which are at present of comparatively little value, as they contain too much phosphorus for acid steel-making, and too little to make the pig iron produced suitable for the basic process.

There are other facts which indicate that many, at least, of the older ores were originally richer in phosphorus than they now are. In connection with some of the deposits of magnetite in Sweden, it is observed that while the mass of the ore is almost free from phosphate of lime, there are deposits of this material, in the form of apatite, in the immediate neighbourhood of the ore, and even in some cases distributed through the ore in the form of olive-green or brown semitransparent masses, which can be separated by hand picking. Though the cause of the peculiar separation which, in this instance, has taken place is not clear, it is evident that there was no deficiency of phosphorus in the original deposit from which the magnetites were produced. Ores of this class are specially suited for treatment by magnetic concentrators, as in special instances tailings containing upwards of 10 per cent. of phosphorus have been separated, while the concentrates have been almost perfectly free from this objectionable element.

Spanish Ores.—With the demand for hæmatite ores, which originated about 1860 from the introduction of the Bessemer process, came a marked development of the ore-mining industry of Spain, particularly on the north coast; and it is estimated that some 56 million tons of ore were raised in the Bilbao district between 1860 and 1894. These ores are rich hæmatites, which vary in colour from the red or “rubio” ore, which is almost anhydrous, to the light yellow, brown hæmatite containing upwards of 10 per cent. of combined water. In the United Kingdom these ores are chiefly imported in Cleveland, South Wales, and the West of Scotland, for the production of hæmatite pig iron for the acid Siemens, and Bessemer steel works. A description of the iron ore district of Bilbao, with special reference to the methods of mining and haulage, employed at the time, was given by W. Gill in 1882.† Other deposits, though relatively of less importance, are met with in the Eastern Pyrenees.‡ The geological distribution of Spanish ores has been discussed by J. D. Kendall,§ who

* *Agriculture*, p. 34.

† *Inst. Journ.*, 1882, vol. i., p. 63.

‡ *Ibid.*, 1894, vol. i., p. 404.

§ *Ibid.*, 1892, vol. ii., p. 308.

states that the magnetites of Malaga are of Archaean age, while the ores in the provinces of Vizcaya and Santander occur in rocks corresponding to the Upper Greensand, and in many features resemble the hematite deposits of Cumberland.

The demand for Spanish hematite ores has, however, been so great in recent years that, at the present rate of output of some four million tons per annum, the exhaustion of the Bilbao district cannot be far distant. There are, however, underneath the hematite large deposits of spathic ore, the extent of which is at present unknown. This ore, when raw, contains 43 per cent. of iron and 25 per cent. of carbon dioxide, but when calcined the iron is increased to 58 per cent. Large calcining kilns have recently been erected, and it is probable that in this way the supply of ore may continue for a number of years.*

In the opinion of A. P. Wilson the iron ores of the South of Spain, and especially of the province of Almeria, will play a large part in the future of the iron trade. There are hematite ores of all kinds in the southern districts, including hard purple ores, brown hematites, and manganiferous ores containing over 50 per cent. of iron, with 12 per cent. of manganese. These ores do not occur in the form of lodes, but as beds or deposits produced by replacement; they are usually upon schist rocks, and covered by limestone or dolomite. As a rule there is no clear division between the ore and limestone, as one passes gradually into the other, but the division between the ore and schist is clear and well defined. These deposits are all situated in the slopes of mountain ranges; there is an almost continuous series of deposits along the north-eastern coast of Spain, and most of the outcrops are worked by the open cast system. The following are a few selected analyses of these ores † :—

	Herrerias.	Purple Garrucha.	Alfaro.	Magnetite Marbella.
Ferric oxide,	75·21	79·46	69·69	} 57·86 Fe ₂ O ₃ } 26·58 FeO
Manganese dioxide, . .	13·44	2·40	4·67	
Silica,	2·12	7·25	2·23	8·65
Alumina,	·95	·27	nil	·34
Lime,	·24	2·34	6·25	·50
Magnesia,	·09	·54	4·08	5·29
Phosphorus pentoxide, .	·018	·036	traces	·015
Water,	7·53	7·04	13·44	·69
Metallic iron,	52·65	55·62	48·78 in dry ore.	61·26

* Windsor Richards, *Inst. Journ.*, 1893, vol. i., p. 16.

† *Inst. Journ.*, 1894, vol. ii., p. 182; see also *ibid.*, 1893, vol. i., p. 181.

Iron Ores of the Colonies.—In New Zealand almost every known variety of iron ore has been discovered, though workings have only been conducted on a small scale, and have been confined to the black sands which occur plentifully on the coasts, those of Taranaki being best known.

In Canada enormous deposits of iron ore occur, and in Nova Scotia and British Columbia ore and coal are found in the same neighbourhood. The rich magnetites and hæmatites which occur in the neighbourhood of the great lakes are, however, largely exported to the United States, owing to the absence of suitable fuel. A detailed account of the characters and distribution of the Canadian ores in the different provinces, together with chemical analyses and some account of the works in operation at the time, has been given by P. C. Gilchrist and E. Riley.* Notwithstanding the abundance of rich ore, and the fact that iron manufacture was introduced into Quebec by the French as early as 1737, the production of Canada is still relatively very small.

Previous reference has already been made to the rich non-phosphoric ores of India, which have long been worked by the natives. It is stated that considerable quantities of iron ore have been met with in South Africa, particularly in Natal, where coal is also found, though these deposits are as yet entirely undeveloped.

In Australia deposits of iron ore of all classes occur, but owing largely to the want of suitable fuel, and to the undeveloped state of the country, little progress has been made in the manufacture of iron. The greater part of Western Australia is yet unexamined, though there are indications of rich deposits; South Australia possesses an almost unlimited supply of non-phosphoric ore, chiefly hæmatites and limonites, some of which are rich in manganese, but no workable coal has yet been found.

In Queensland clay ironstone is stated to occur near to coal, while non-phosphoric hæmatites, limonites, and magnetites also occur. Victoria yields brown hæmatite, titanite iron sand, and other ores, though in quantities which are at present undetermined. The chief iron deposits, however, appear to be in New South Wales, in many parts of which coal, iron, and limestone are found in close proximity. The ores include magnetite, red hæmatite, goethite, limonite, and spathic ore, while chrome iron ore and oxides of manganese also occur in the same colony.† These ores are generally non-phosphoric, and are often rich and easily obtainable. Analyses of forty samples of iron ore from New South Wales will be found in the paper by P. C. Gilchrist and E. Riley, to which previous reference has been made, who

* "The Iron Making Resources of the British Colonies," *Inst. Journ.*, 1886, vol. ii., p. 497.

† *Inst. Journ.*, 1892, vol. ii., p. 310.

state that, in their opinion, there is no reason why, with cheap labour and efficient supervision, India and the Colonies should not rival the mother country in the magnitude of their iron industries, and they believe that before very long Canada, India, New South Wales, New Zealand, and Queensland will become important producers of iron and steel.

Meteoric Iron.—Iron of meteoric origin is met with in many parts of the world, though not in sufficient quantity to be of practical importance, except to savage tribes. The ancient Greeks were familiar with the fact that iron fell to the earth in the form of meteorites, and the metal so obtained was highly prized by them (see p. 4). It is noticeable that meteoric iron almost invariably contains considerable proportions of nickel, and also cobalt, carbon, and phosphorus, together with smaller amounts of other elements. The following analyses, selected from a number by various authorities,* will serve to illustrate the composition of meteoric iron :—

	1.	2.	3.	4.	5.
Iron,	90·80	89·83	71·04	87·96	91·35
Nickel,	3·24	3·08	26·64	9·19	7·89
Cobalt,	0·29	0·79	1·67	2·60	·56
Combined carbon, .	4·85	6·43	0·30	0·38	trace

Analysis No. 5 in the above list is of a meteorite from New South Wales, by Mingaye.†

There is some reason for believing that iron occasionally occurs native in the form of small grains. Daubr e and Meunier have examined native iron, obtained when washing for gold in Siberia, and found it to contain a little platinum, but no nickel. This iron did not yield the characteristic lines known as Widmannst ttian figures when carefully etched, and was, therefore, probably not of meteoric origin. Native iron from Lake Huron, examined by G. C. Hoffman, was also stated to be of terrestrial origin.‡

* *Inst. Journ.*, 1891, vol. i., p. 260.

† *Royal Soc. New South Wales*, June, 1893. For other analyses and details of meteoric iron, see *Inst. Journ.*, 1889, vol. i., p. 236; 1891, vol. ii., p. 149; 1892, vol. ii., p. 324; 1893, vol. i., p. 195; 1894, vol. i., p. 423, &c.

‡ *Inst. Journ.*, 1891, vol. ii., p. 148.

CHAPTER V.

PREPARATION OF IRON ORES.

Extraction of Iron Ores.—Iron ores occur in so many forms and in rocks of such various geological periods that their extraction affords examples of all kinds of mining. Iron sands and small deposits of brown ore are not unfrequently met with as surface deposits, and are thus very easily worked. The brown hæmatite of Northamptonshire and Leicestershire, of Alabama, and also the spathic ores of Styria are mined in open works or quarries; the surface earth is first removed, and the ore is thus exposed; where the land is valuable for agricultural purposes the surface soil is replaced after the ore has been got, so as not to interfere with the subsequent cultivation of the land. The celebrated deposits at Cornwall Banks in Pennsylvania consist of three hills overlying an immense underground mass of ore. A spirally constructed railway permits locomotive and waggon access nearly to the top of the hill. The ore is cut in terraces a little above the level of the waggons, and is thrown directly into the vehicle. It is stated that in this way one man can work and load 1 ton per hour. Where rivers containing iron in solution enter lakes, and the ferruginous water is allowed to remain at rest and oxidise, a quantity of hydrated ferric oxide is precipitated; this is obtained by dredging from the bottom of the lake in districts where other supplies of ore are limited, as in some parts of Canada and Sweden. The ores that occur under a more or less considerable deposit of rock and earth are extracted by regular mining, the arrangements for which naturally depend upon the shape and distribution of the ore deposit. Occasionally veins of rich ore are found, and these are treated by methods such as are regularly employed for lodes in metal mining. A deposit of this kind was formerly worked at Mumbles Head in Glamorganshire, but is now exhausted. The iron ores of the coal measures generally occur in regular beds or seams, which lie in a similar manner to the coal itself, and the ironstone is mined in the same manner as the coal. In the hæmatite districts of Cumberland and Lancashire, on the other hand, the red hæmatite is met with in irregular pockets in the limestone. The largest of these deposits is that belonging to the Barrow Hæmatite Company, known as the Park Mines; this is 450 yards long, 250 yards broad, and of unknown depth. The ore has

been worked since 1850, and the present output is about 600,000 tons per annum. It is worked by means of levels which are driven into the adjacent limestone at distances of 10 fathoms, a lower level being driven as soon as the one above is worked out. Rises are put up from the new level to the exhausted workings above, and workings are opened out in a 9-foot slice by the pillar and stall method, the next slice being worked as soon as the upper one is taken out. The workings are timbered by heavy uprights 3 feet apart, the roof is formed with timber and rubbish, while the mines are ventilated with natural draught.* In the Whitehaven district some of the finest deposits of ore occur in pockets in the upper beds of limestone, immediately below the millstone grits, but in the Furness district the hematite is usually in the lower limestone beds in the vicinity of, and often in actual contact with, silurian slates. Illustrations showing the character of these deposits have been given by Phillips; † while Sir L. Bell has described the method of working similar deposits in the Lake Superior region. ‡

Iron ores which contain ferrous oxide, such as magnetites, are always more or less magnetic, and are frequently also distinctly polar. Deposits of iron ore, therefore, frequently have a marked influence on a magnetic needle, and advantage has been taken of this fact in explorations for iron deposits. The instrument employed in preliminary work of this kind is generally a simple form of dip needle; this is capable of indicating the existence of iron ores, but does not afford accurate information of the extent or position of the deposit. In order to obtain more definite information, accurate instruments are needed, and a number of observations must be taken. Details of the methods adopted in such cases have been given by B. H. Brough,§ and by H. Sjogren,|| and it is stated that, especially in Sweden and in America, important deposits of iron ore have been discovered by such observations. This method of exploration is cheap and expeditious, but does not answer so well when there is a number of small and scattered deposits of ore.

PREPARATION OF ORES.

In some cases the ores of iron can be at once treated in the blast furnace, or by whatever method may be adopted for their reduction, without preliminary treatment of any kind. Where any preparation is necessary, this must, from the nature of the case, be of a relatively cheap and simple character. In treating

* *Inst. Journ.*, 1892, vol. ii., p. 332.

† *Ore Deposits*, p. 160.

‡ *Inst. Journ.*, Amer., vol. for 1890, p. 75.

§ *Inst. Journ.*, 1887, vol. i., p. 289.

|| *Ibid.*, 1890, vol. ii., p. 669.

ores of the precious metals, such as gold, silver, or even tin, lead, or zinc, it is not unusual to resort to troublesome and expensive methods of crushing, washing, and concentrating. In such instances this is possible, on account of the relatively high intrinsic value of the metal and the small quantity of material to be treated. With iron ores, however, it is altogether different, as the metal to be extracted is, weight for weight, worth only one-fifty-thousandth part as much as gold, and the bulk of ore to be dealt with is so great.

Sizing.—The ore is roughly separated from the earthy and other associated matters at the mine, and is then sometimes hand-picked, to separate pyrites or apatite, both of which can in this way be occasionally removed. It may then be sized, so as to promote regularity in the subsequent operations. Ores which contain less iron, like Cleveland ironstone, may be smelted in much larger lumps, on account of their porous character, than is the case with richer ores, especially if these contain a proportion of ferrous oxide, like magnetites. It is usual, therefore, when smelting rich magnetites or compact hæmatites, to break the ore so that the pieces shall not be much larger than an egg, as by this means more regular and satisfactory results are obtained.

Concentration of Iron Ores.—It is seldom that any system of concentration can be profitably applied to iron ores other than magnetites, and, in exceptional cases, to dense red hæmatites. The systems of concentration that are actually employed include *washing*, which is the older, and *magnetic separation*, which is the more important process.

Washing.—Magnetic iron sands or tailings are sometimes washed by hand in India, Sweden, Canada, and elsewhere, though this is conducted on a very moderate scale. In the Khasi Hills, in India, the ore occurs in the form of a fine sand, consisting of minute crystals of titaniferous magnetic oxide, which are regularly distributed in the mass of decomposed granite. This soft and easily-yielding rock is not mined or quarried, but merely raked by Khasi women, during the rainy season, into a small stream of water conducted along a little channel at the base of the rock from which the ore is obtained.* In Malabar a friable decomposed schist is crushed by the natives with a large wooden hammer, and the sand thus produced is washed in a wooden trough with water, to separate the magnetite which is present. But where washing of iron ores is still conducted, mechanical arrangements have in most cases been introduced to save time and labour. These mechanical concentrators may be classified into three kinds—jigs, troughs with revolving shafts, and cones. In its simplest form, a jig consists of a wooden box with a perforated bottom; the ore is placed in

* V. Ball, *Geology of India*, vol. iii., p. 413.

the box, and the whole is immersed in water; a pulsating motion is imparted to the particles of ore, either by shaking the box, or by pumping the water; the particles being thus kept in a state of continued motion while suspended in water, arrange themselves according to their relative densities, and may be separated. At Norberg, in Sweden, ores consisting of red hæmatites, with variable quantities of magnetite and quartz, have been concentrated, on a considerable scale, by first crushing with a stone-breaker, and sizing by means of conical trommel screens. The ore after being thus carefully sized was treated in jigs, and the fine ore made into briquettes, with about 10 per cent. of lime; after standing for some time these briquettes became quite hard and suitable for smelting.*

The Thomas ore washer consists of a water trough some 25 feet long, 5 feet wide, and 2 feet deep. In this trough the ore is passed and kept in constant motion by means of two revolving shafts which may be geared together, and which force the ore up the inclined bottom of the trough; the clay is thus broken up and carried away by the water to suitable settling tanks. Such a washer, with about 40 gallons of water per minute, and 15 horse-power, would wash some 70 tons of ore per day. Cone washers, which resemble the ordinary buddle, are also sometimes employed. Ore washing is more largely conducted in Virginia, Georgia, Alabama, and Tennessee than elsewhere.† For a description of an improved ore washing plant erected at Longdale, Virginia, in 1891, see *Inst. Journ.*, 1894, vol. i., p. 427.

Magnetic Concentration.—Magnetic concentration has been introduced in recent years in the treatment of Lake Superior ores in America, and of the magnetites of Sweden and elsewhere; it was first proposed by Chenot in his patent of 1854 for the direct production of steel, though no details were given of the machine. Brass filings had previously been freed from iron by a machine in which permanent magnets were employed, but Chenot proposed the application of electro-magnets arranged so as to sort the ore in a continuous manner.‡ Modern magnetic concentrating machines are improved applications of the principle thus suggested by Chenot.

The ore to be concentrated is usually the waste from the mine, and is in a tolerably fine state of division. In some instances it is roasted before being passed through the magnetic concentrator. In any case it is crushed and sieved so far as may be necessary to bring it to a uniform size. The size of the particles depends partly on the nature of the ore and also on the degree of concentration desired, finer crushing being necessary for more perfect purification. The screens employed for different samples of ore

* *Inst. Journ.*, 1889, vol. i., p. 240.

† *Ibid.*, 1890, vol. ii., p. 670.

‡ *Jeans, Steel*, p. 39.

have meshes which are from about $\frac{1}{4}$ inch to $1\frac{1}{4}$ inches apart. There are a variety of machines in operation at present, differing in details of construction, in all of which powerful electro-magnets are employed. The arrangements for handling the ore are as far as possible automatic throughout, and the cost of crushing, concentrating, and loading into waggons is stated under favourable conditions not to exceed ninepence per ton. It is best, especially with finely-divided ores, not to allow the ore to fall directly on to the separator, but it is caused to pass near to the magnets, either while it is carried on a revolving band, or while held by centrifugal force against the sides of a rotating drum; occasionally also the ore is suspended in a stream of water. A much more satisfactory separation is obtained in this manner than in cases where the ore is fed on to the separator, as the materials in the latter case are simply bound together on to the magnets. The separation is also more complete when powerful currents are employed, and when the crude ore is as far from the magnets as is compatible with efficient working.

Magnetic concentration not only removes a considerable proportion of the gangue, thus adding to the intrinsic value of the material, and reducing the cost of transport, but it has the additional advantage of eliminating a large proportion of the phosphorus, and in some cases also the sulphur, that is present in the original material. Practically this is the only method of removing phosphorus which has been successful for the treatment of ores on the large scale; and it is stated that when the sulphur is present in the form of pyrites it is more readily removed by magnetic concentrators than by calcination. The following figures illustrate the results obtained by the use of the "Monarch" magnetic separator at the Benson Mines in America:—*

	Crude Ore.	Concentrates.	Tailings.
Iron, per cent., . . .	45·48	61·40	5·60
Phosphorus,	0·158	0·042	1·25

In this case the tailings formed 25 per cent. of the original weight of the ore.

The Venström magnetic separator, which has been in use at Dannemora and elsewhere in Sweden, and in America for a number of years, is capable of treating ore in large pieces, up to 3 inches in diameter, and is said to give very satisfactory results.†

It is stated that the chief types of magnetic concentrators employed in the United States in 1890 were the Ball and Norton, the Conkling, and the Wiman, each of which consists of a

* *Inst. Journ.*, 1890, vol. ii., p. 676.

† *Ibid.*, 1889, vol. i., p. 243; 1890, vol. ii., p. 672.

revolving magnetic drum acting on a stream of finely-crushed ore. The cost of concentrating a 35 per cent. magnetite to 57 per cent., including crushing, interest on machinery, loss in tailings, steam, and all charges, is 4s. 10d. per ton, raising the original price of the ore (8s.) to 12s. 10d.*

Magnetic Treatment of other Ores.—Brown hæmatites, limonites, and other hydrated oxides of iron are not magnetic, and so are not capable of being concentrated by magnetic separators. But it has been pointed out by C. Jones† that these ores become magnetic when heated to low redness. This writer, therefore, suggests that such ores could be profitably concentrated, in many cases, after careful roasting at a cherry red heat. The ore is drawn off when it has reached this temperature, and is ready for magnetic concentration. It is stated that concentrates containing nearly 50 per cent. of metallic iron, and tailings with only 2·5 per cent., can thus be obtained from limonite.

According to G. Prus, however, it is usually necessary to convert ferric oxide into magnetic oxide before concentration, and this can be done by calcining the material when mixed with from 1 to 5 per cent. of fine coal.‡

Some experiments on this point, conducted at Mason College by H. Harris in 1893, at the suggestion of the author, have shown that ores which consist essentially of ferric oxide are non-magnetic, or nearly so, both before and after heating to redness; the same is also true of the sample of brown hæmatite and limonite examined in these experiments, though, as stated by Prus, all these ores become magnetic when calcined with a small proportion of coal, so as to ensure a partial reduction. Carbonate ores are non-magnetic when in their native condition, but on heating to redness they become distinctly magnetic. The magnetic property, therefore, appears to be connected with the presence of ferrous and ferric oxide together, either in the original material or while it is being heated. Ores which have been calcined on the large scale are generally magnetic, even though, as with Northampton ore, no ferrous oxide were originally present; apparently there is sufficient reduction during calcination to render the ore magnetic. An ore which has been once magnetised appears to retain its magnetism, even though it be afterwards completely oxidised at a red heat. In these experiments it was found possible, by means of a magnet, to considerably reduce the proportion of silica and phosphorus in a sample of powdered Cleveland ironstone which had been calcined in a kiln in the usual manner. In British ores, however, the calcium phosphate and silica are generally present in a state of fine division, and are intimately associated with the ore; magnetic

* *Inst. Journ.* (Amer. vol.), p. 350.

† *Trans. Amer. Inst. Min. Eng.*, vol. xix.; *Inst. Journ.*, 1890, p. 671.

‡ *Inst. Journ.*, 1891, vol. i., p. 273.

concentration does not, therefore, yield such good results as in the cases previously described, where the apatite and pyrites exist in the form of separate particles.

Preparation of finely-divided Iron Ores.—Ores which are in a very fine state of division are often difficult to smelt in the blast furnace, owing to the resistance they oppose to the passage of the blast. This is one reason why the Bloomery and other direct processes are still employed in districts where iron sands have to be reduced, as such material can be more readily treated in small quantities. In some instances, after the ore has been calcined, as afterwards described, the product is allowed to run over inclined sieves, so as to remove the finer portions, which are either treated separately or even thrown away; and it is found that the extra expense thus incurred is more than repaid by the improved regularity in the furnace working. A number of suggestions have been made for the utilisation of "purple ore," the residue left after the extraction of sulphur and copper from Spanish pyrites, which is almost pure ferric oxide in the condition of a fine and tolerably uniform powder. The methods that have actually been adopted, though in no case on any very considerable scale, include mixing with lime, or with coal tar, and pressing into bricks; while clay has also been employed for the same purpose. Hutchinson and Harbord (Eng. Pat., 2,747, 1891) have proposed to utilise such ores by incorporating them with molten blast furnace slag. This has the effect of rendering the material coherent, and at the same time the ore is self-fluxing, as the slag readily melts again in the blast furnace. Thus, it is claimed, that on incorporating a mixture of equal weights of purple ore and Cleveland slag, a valuable self-fluxing ore is obtained. The approximate composition of the slag and of such a mixture is as follows:—

	Slag.	Mixture.
Silica,	27·6	14·0
Alumina,	22·2	11·0
Lime,	40·1	20·0
Magnesia,	7·6	3·8
Ferric oxide,	49·0
Other constituents,	2·5	2·2

The native ores which are smelted in Germany are in many cases in a state of very fine division, and, according to A. Thielen,* more than one-fourth of the ore smelted in the blast furnaces of Germany is of a size much finer than peas, and is sometimes as fine as dust. On this account it is necessary to

* *Inst. Journ.*, 1890, vol. ii., p. 49.

employ furnaces of only moderate height, and to use a relatively low blast pressure. It is, however, a noticeable fact that in America large quantities of finely-divided ore are smelted, even with rapid practice. Such ores for instance as have been crushed for concentration by washing or with magnetic separators are in a state of tolerably fine powder, and J. Gayley states that at the Edgar Thomson Works recent practice has shown that far better results are obtained by discarding the lumps and using the fine ore.* E. Moffart also gives as the result of his experience that with concentrated Lake Champlain ore, all of which would pass through a sieve with a $\frac{1}{4}$ -inch mesh, and much of which was much finer, that no difficulty was met with when treating 50 per cent. of concentrates in the blast furnace.† The above statements indicate that no uniform method is adopted in preparing ores which are in a state of fine division, but that the treatment varies according to the special conditions of the locality.

Weathering.—After the ore has been raised from the mine it is not unfrequently stacked in heaps and exposed to the action of the weather, for a period which varies from about three months to some three years. The object of weathering is twofold. Ores such as clay ironstone, obtained from the coal measures, are often associated with more or less shaly matter, which adheres so firmly to the ore itself as to make its separation by hand-picking a matter of extreme difficulty. The ore is, however, dense and of uniform texture, while the shale is deposited in layers; if the ore and shale are exposed to the weather together, the shale is split off by the moisture and frost in thin sheets, which soon crumble to powder; the ore, on the other hand, if it be not weathered for too long a period, is but little altered. Ores which contain sulphur in the form of iron pyrites (FeS_2) are also weathered; the moisture and oxygen of the atmosphere oxidize the sulphide of iron, converting it into sulphate (FeSO_4), which is readily soluble in water. It is, therefore, washed out by the rain, and finds its way into the drainage water. If this drainage water also contains peaty matter, an inky blackness is produced which is not uncommon in some parts of Sweden. The objects of weathering are thus to remove shale and sulphur, and only such ores are weathered as contain these substances in objectionable quantities. Ores which are already in a state of fine division should not be weathered, as they would be converted into still finer powder; nor should materials which contain both lime and sulphur be weathered, for in such cases the ferrous sulphate formed by oxidation would be decomposed by the calcium carbonate present in the ore; the result would be the formation of calcium sulphate, which is very difficultly soluble in water. It would, therefore, not be washed away in

* *Inst. Journ.*, 1890, vol. ii., p. 73.

† *Ibid.*, 1889, vol. i., p. 300.

the drainage water, but would retain the sulphur in a form which would be nearly, if not quite, as objectionable as the original pyrites.

Calcination of Iron Ores.—The term calcination is applied when a material is heated in order to drive off any volatile constituent, such for instance as in burning lime, when carbon dioxide is driven off from limestone. The word roasting, on the other hand, is used when the chief object is to oxidise the material; it is not necessary in roasting that any volatile portion should be removed. In the metallurgy of iron the difference between these terms is often overlooked, and the whole is known as calcination; the objects of calcination are as follows :—

1. To drive off water which, when present in too large quantities, leads to irregular working in the blast furnace.

2. To eliminate carbon dioxide from carbonate ores. This concentrates the material, and also diminishes the liability to waste of fuel owing to a reaction between carbon dioxide and carbon in the upper parts of the furnace; it also diminishes the bulk and improves the quality of the gases from the furnace.

3. To eliminate sulphur, and to a smaller extent arsenic and any other volatile impurities.

4. To oxidise the ore and by converting ferrous into ferric oxide to diminish the liability to the formation of a "scouring" slag—*i.e.*, one which is very fusible owing to the presence of ferrous oxide, and which leads to loss of iron and to the rapid destruction of the furnace lining.

5. To remove carbonaceous matter, which when present in considerable quantity, as in blackband ores, prevents the proper fusion of the materials in the blast furnace.

A series of experiments has been conducted by S. G. Valentine in order to determine the conditions under which sulphur can be most efficiently removed by roasting from iron ores which contain pyrites. Such ores can be properly desulphurised if there be free access of atmospheric air during the calcination; the presence of air is, however, absolutely necessary for complete desulphurisation, as otherwise only one-half of the sulphur in pyrites is eliminated. Sulphates of iron are decomposed equally well whether air be present or absent, so that if the ore be sufficiently oxidised in the preliminary stages of the calcination, desulphurisation may be completed in a neutral atmosphere. Partial fusion or "sintering" of the ore is very liable to prevent complete desulphurisation, as it interferes with the ready access of oxygen. Since by the action of reducing agents sulphates are converted into sulphides, the sulphur in iron ores cannot be removed in a reducing atmosphere, as for instance in the upper parts of the blast furnace.* The magnetic ore of the celebrated

* *Inst. Journ.*, 1889, vol. ii., p. 333.

PREPARATION OF IRON ORES.

Cornwall Banks in Pennsylvania was in all probability originally deposited in the form of iron pyrites, and still contains about 2.5 to 3.25 per cent. of sulphur. It is generally calcined as afterwards described by gaseous fuel, which is frequently obtained from the blast furnace; the sulphur is thus reduced to about one-twentieth of that in the native ore. It is thus possible that efficient calcination to very considerably diminish the percentage of sulphur in many iron ores.

On the other hand, it is important to observe that, as phosphorus in iron ores exists chiefly in the form of calcium phosphate, which is unaltered by heat in an oxidising atmosphere, the amount of phosphorus originally present is not diminished by calcination, and as the weight of the calcined ore is less than the weight of the raw ore, the proportion of phosphorus in the calcined ore is greater after calcination, owing to its concentration in a smaller bulk of material.

Ores which contain but little water, sulphur, carbon dioxide, or carbonaceous matter, do not need calcination; hence magnetites and red hæmatites are seldom calcined except when they contain pyrites; brown hæmatites are calcined at a temperature sufficient to drive off most of their combined water; while carbonaceous ironstones and blackbands are almost invariably calcined. Calcination is usually accompanied by a marked change of colour, and brown hæmatites, light brown spathic ores, grey clay ironstones, and jet-black blackbands are all alike converted into red ferric oxide. If the temperature employed in calcination is high, the ferric oxide frequently has a deep purple colour, which at times becomes almost black. But on grinding the material to an impalpable powder, it becomes once again bright red, showing that the dark colour is due to a physical change in the oxide, whereby it is rendered more compact. Ores which have been improperly calcined frequently have a black colour, and are very dense and clotted together. This is caused by local overheating, usually combined with a deficiency of air. These conditions prevent complete oxidation, and the presence of some ferrous oxide causes the materials to assume a black colour and to clot together in lumps. Such portions are unsuitable for smelting, and are sometimes broken up and recalined.

Roasting in Open Heaps.—Calcination was formerly always conducted in heaps in the open air, and this primitive method is still followed to a limited extent in certain localities, particularly for blackbands, brown hæmatites, and tap cinder. A level, open piece of ground is chosen, and on this lumps of ore are placed. A rough slack is spread over these, and alternate layers of ore and slack are spread until a heap of the required size is obtained. In Staffordshire these heaps are from about 5 to 10 yards wide, 2 to 4 yards high, and 10 to 50 yards long. The heaps are kindled at one end, and the combustion is allowed to proceed

until the operation is completed, while the temperature is regulated as far as is possible in such a case by opening up the outer parts of the heap, or covering it with fine ore, as may be required to increase or diminish the supply of air. Blackband ores often themselves contain so much carbonaceous matter that it is not necessary to add any coal in calcining; these ores are almost invariably calcined in open heaps, as economy of fuel need not be considered, and it is necessary to remove the carbonaceous matter.

Calcining in Kilns.—In modern works the general practice is to calcine in kilns, which are usually, though not invariably, circular in section, and which possess the following advantages as compared with open heaps:—

Kilns occupy much less space, and as they are continuous in their action, they can be placed near to the furnace, thus saving the labour required in distributing and collecting the ore over a large area. They further save labour, because the materials can be readily brought to the top of the kiln by mechanical means; and as it descends by gravity, the charge does not require handling again until it is taken to the furnace. In kilns the ore is protected from the weather, and irregularities due to wind, snow, or heavy rain are minimised; the process is thus much more under control: while, lastly, the consumption of fuel is less in properly-constructed kilns than in open working. This economy of fuel is partly owing to diminished loss by radiation, due to the fact that combustion proceeds in a space which is surrounded by brickwork; but, in addition, the method of working such a kiln causes it to act in some measure as a regenerator. Combustion takes place chiefly below the surface of the freshly-charged cold materials, and the hot gases in passing through the upper parts of the calciner, give up their surplus heat to the cold charge. On the other hand, the hot ore in descending through the lower parts of the kiln, gives up much of its heat to the ascending current of air; thus the materials, from the mere fact of being charged in at the top and withdrawn below, assist in heating up the air that is required for the combustion, and in cooling the products of this combustion before they pass away.

Roasting between Closed Walls.—Iron ores are not unfrequently calcined between closed walls, and this method occupies an intermediate position, so far as economy and convenience are concerned, between open heaps and kilns. In calcining the brown hæmatites of Northamptonshire, where it is only desired to drive off part of the water which is present, and where a very moderate temperature is required, it is customary to employ a series of walls of masonry, of moderate height, arranged in a row, and parallel to each other. The ore and fuel are brought by an overhead railway, which passes down the centre of the row of walls, at right angles to the length of each wall. The materials

are thus readily brought to the calcining heaps, which are situated close to the blast furnace. This method requires less space and labour than open heaps, but the ore is exposed to the weather. In South Staffordshire tap cinder is frequently calcined between closed walls, though the arrangement is somewhat different from that just described. In this case a long wall of masonry is built, and at right angles to this wall are smaller walls, all of equal length. A number of stalls are thus obtained with permanent walls on three sides. In these stalls the cinder and fuel are placed, and as each stall is filled up, a temporary wall is made at the front of the stall. In this way a number of what are practically rectangular kilns built back to back are produced. Though this method is better than the use of open heaps, it does not completely protect the materials from the influence of the weather, while it involves much labour in removing the calcined materials.

Calcining Kilns.—Modern calcining kilns may be classified according to variations in shape and methods of firing. They are generally circular in section, and fired with coal; in Germany rectangular kilns are sometimes employed, while at Dowlais kilns with parallel sides and circular ends have been used for many years. In America, Sweden, and a few other localities kilns are fired by means of the waste gases from the blast furnace, or other cheap gaseous fuel.

The form of kiln most generally used in Britain is known as the Cleveland calciner; it is also called the Gjers kiln from the fact that it has been described by Jno. Gjers.* This is a circular kiln made of wrought-iron plates, rivetted together, and lined inside with about 14 inches of fire-brick; it is shown partly in elevation and partly in section in Fig. 12, the scale being 10 feet to an inch.

The floor of the kiln is covered with cast-iron plates, *c*, on the centre of which is fixed a cast-iron cone, *d*, 8 feet high and with a base 8 feet in diameter; the object of this is to cause the descending materials to pass outwards and so assist in the regular descent of the charge. A number of short cast-iron columns, *b*, rest upon the bottom plates, and support a cast-iron ring, *a*, upon which the kiln itself is built. These calciners are about 33 feet high and 24 feet in diameter; their capacity is about 8,000 cubic feet, or 350 tons of ore; they calcine rather less than 1,000 tons of ore weekly, and use about 1 cwt. of coal per ton of ore treated. The ore and fuel are brought to the kiln in trucks running on the two lines of rails shown at the top of the calciner, and the trucks are arranged to allow of the materials readily falling out when the bottom of the truck is released. In the lower row of plates is a number of openings, *f*, to which are attached doors by means of which the draught can

* *Inst. Journ.*, 1871, p. 212.

be regulated, and any obstruction removed in case of irregular working. Illustrations of other forms of kilns employed for calcining iron ores will be found in Phillips-Baerman's *Metallurgy*, 1891 Edit., p. 206; Roberts-Austen's *Metallurgy*, p. 186.

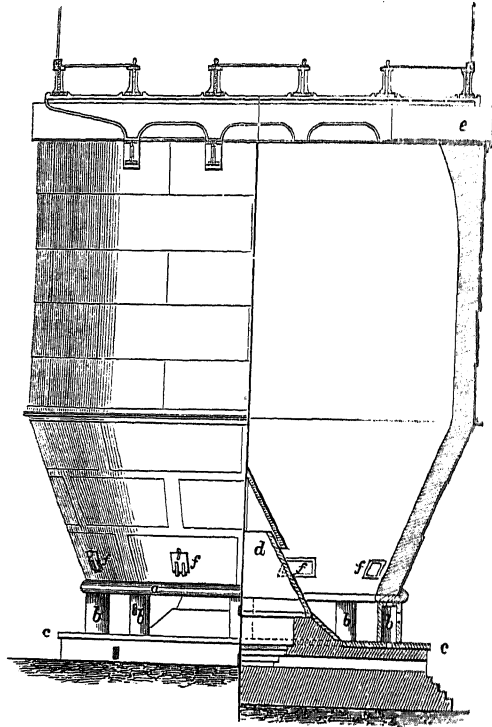

Fig. 12.—Cleveland calciner.

Use of Gaseous Fuel.—Gaseous fuel has been successfully applied for the calcination of iron ores, particularly with pyritic ores in Sweden and America, and it is found that sulphur is much more perfectly removed in this way than when coal is employed. Thus at the Cornwall Ore Hills in Pennsylvania an immense deposit of magnetite occurs, which is worked on an extensive scale, but which in its native condition contains sufficient iron pyrites to yield at least 2 to 2·5 per cent. of sulphur. This is reduced to less than 0·5 per cent., and sometimes to considerably less than this, by roasting with gaseous fuel, while when solid fuel is used, the sulphur in the roasted ore amounts

to about 1 per cent. The gas is either made in producers, or is obtained from the blast furnace when the latter is available. A vertical section of the lower part of the kilns employed is given in Fig. 13, from which it will be seen that the outer shell is of iron plates supported on cast-iron columns as usual, though the shape is different to that commonly adopted in Great Britain. The chief peculiarity of this kiln is the way in which it is fired, gas passages being provided in the lower part of the fire-brick lining, and suitable ports arranged for the entry of the gas; the air is supplied by the natural draught of the kiln. For further details of these ores and calcining kilns, see *Inst. Journ.* (Amer. vol.), pp. 78, 234, 367. Kilns on a similar principle for

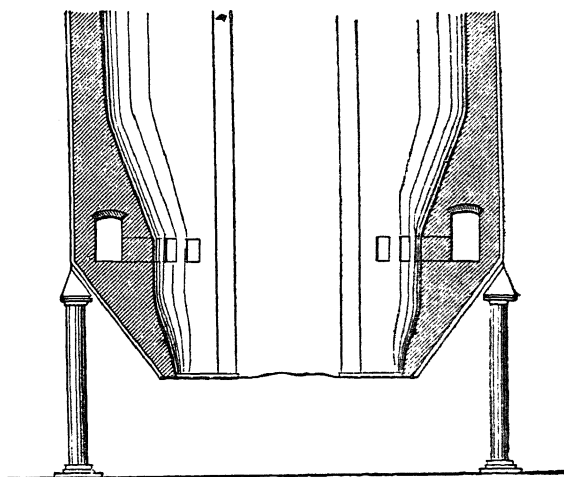

Fig. 13.—Gas-fired calciner.

calcining iron ores with the waste gases from the blast furnace have been in general use in Sweden for many years, and are illustrated by Dr. Percy (*Iron and Steel*, p. 376).

The Davis-Colby kiln is another form of calciner which has met with favour in America, and in which gaseous fuel is employed. In the later forms of this calciner the ore is charged into an annular chamber; this is in turn surrounded by a gas combustion chamber, while inside is a central vertical flue. The products of combustion pass from the outer chamber through the ore and away by the central flue. The ore is fed over a central cone and withdrawn below. The gas is supplied by a single Taylor gas-producer which uses about 3 tons of bituminous coal in twenty-four hours, during which 125 tons of ore are

roasted. The kiln is stated to work uniformly, and to give a very complete removal of sulphur in pyritic ores. It is also used for carbonate and brown ores, while the waste gases from the blast furnace may be employed if desired.*

The Taylor-Langdon kiln is a form of gas-fired calciner employed at the Bristol iron mines, Canada, where New Jersey magnetites, which are very hard and dense, are treated. The kiln consists of a central gas distributing chamber surrounded by ore chambers which are arranged so as to receive their supply of ore from a common receptacle at the top of the furnace. The magnetite is charged in lumps about as large as a man's fist, and after calcining, is withdrawn from the bottom of the ore chambers by suitable shoots. The gas used is regulated by dampers, and is obtained from anthracite, of which about 6 tons are required to calcine 100 tons of ore.†

In exceptional cases complicated methods are adopted, as in the treatment of spathic ores at Alleward, where the large pieces are first hand-picked, then calcined in gas-fired kilns, again hand-picked, and afterwards passed through a magnetic concentrator. The small ore is differently treated, being first mechanically sized, then washed, calcined in reverberatory furnaces, wetted to slake the lime and magnesia, and pressed into bricks, which are smelted after being dried for some eight days.‡ It has, however, been already explained that such a complicated system is not usual for the preliminary treatment of iron ores.

* *Inst. Journ.*, 1894, vol. i., p. 428.

† *Ibid.*, 1887, vol. ii., p. 232.

‡ *Ibid.*, 1894, vol. i., p. 426.

CHAPTER VI.

THE BLAST FURNACE.

Selection of Site.—When in earlier times the materials for the smelting of iron were obtained in the immediate neighbourhood of the works, and when the greater part of the product was intended for local consumption, the locality of the blast furnace was determined chiefly by the nearness of the supplies of raw material, and the vicinity to a convenient market for the iron produced. The actual site of the furnace was usually selected with a view to smelting the materials with as little expenditure of power as possible, and a position was thus generally preferred on the side of a hill, or in a valley, so that the charge could be wheeled on to the furnace top, while the slag and iron ran out on to the level ground below.

With the enormously increased production of modern times, the position of a blast furnace is determined less by the nearness of the supplies of raw material than by the readiness with which these materials can be brought to the furnace. Modern iron works are, therefore, generally erected near the sea, or on the banks of a tidal river, or in some other situation with facilities for cheap and ready transit; the site chosen should be a well drained level piece of ground, sufficiently large to allow space for calciners, stoves, pig beds, stocks, railways, and other requirements. If the land be not already in good condition it must be carefully made up and levelled, and it is necessary that a good firm foundation should be provided for the furnaces if the land be loose or shifty. The weight of a large furnace with the materials it contains when at work is very great, and to carry this weight in shifty soil it is often necessary to drive long piles; not unfrequently, even after considerable expense has thus been incurred, inconvenience is caused by the settling of the foundation some time after the furnace has commenced operations. Nearness to the sea not only allows of the ore and coke being cheaply transported, which, on account of the great weight of the former, and the bulk of the latter, is of prime importance, but also allows of the ready disposal of the slag for the reclaiming of low-lying land, the formation of breakwaters, and for other useful purposes.

Arrangement of Works.—When the materials were taken to the furnace top by means of an incline, a bank of earth was a necessity, but with the almost universal application of lifts a level

laid with railways has come to be preferred. The rails provided for the transport of materials in the works should be laid with easy gradients, and sharp curves should be avoided, as they involve additional working expenses. It is convenient to have

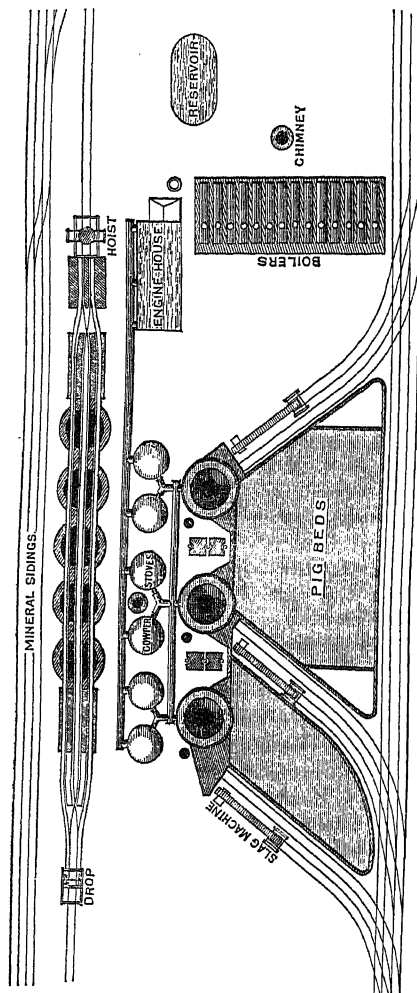

Fig. 14.—Plan of Cleveland blast-furnace plant.

railways in the works of the standard gauge, and when the has to be calcined several lines of rails should be provided and the calciners. Each furnace should be built with sufficient ce to allow of ready access to all parts, and with ample room

for stoves, pig beds, slag runners, and for working round the furnace. A good supply of water for cooling and other purposes is also necessary. In America it is not unusual to cover the pig beds with a light and tolerably lofty roof.*

The general arrangement of a blast furnace plant in the Cleveland district is shown in Fig. 14, which is taken from a paper by Sir B. Samuelson,† and which is a plan of three blast furnaces with the necessary stoves, calciners, boilers, engines, pig beds, and railways. The ore is brought into the works in trucks on the mineral sidings shown in the plan, and from thence is raised by a hoist to the top of the calciners; it then passes down a gentle incline over the calciners, into one of which the ore is dumped while the empty truck passes on to the drop and thus out of the works. Two lifts are provided to supply the three furnaces with calcined ore, fuel, and limestone, while each furnace is provided with separate rails for removing the slag, and with two Cowper stoves for heating the blast. The blast is supplied from one main to the three furnaces, and five calciners are required to calcine the ore used. The number of furnaces in a modern plant varies, occasionally as many as twelve being built in a row, as at Barrow, but the plan given by Sir B. Samuelson may be considered as typical of many of the best works in the United Kingdom. In the paper from which these details are taken full particulars are given of the cost of the plant, from which it appears that to erect three furnaces in Cleveland with all the necessary appliances costs about £75,000.

The arrangement of blast furnace plant in a modern American works differs in some respects from that adopted in Great Britain, and a plan of a typical American works is given in Fig. 15, which represents the celebrated Edgar Thomson Works at Bessemer, near Pittsburg, Pa. This plant includes nine blast furnaces, lettered respectively from A to I, and thirty-three hot blast stoves, the total weekly output being about 11,000 tons of pig iron; all the blast furnaces make iron of Bessemer quality except A, which produces manganiferous iron or "spiegel," and is, therefore, of smaller size, and worked in a different manner to the rest of the furnaces. As the ore used is rich and free from moisture and carbon dioxide, calciners are not required, but stock yards are provided, which are roofed over and well supplied with railways. The furnaces are arranged in pairs, but each is independent of the other being provided with separate blowing engines, and with a double cage hoist for raw materials, which is worked with a suitable engine. Each pair of furnaces is provided with a group of boilers and with the necessary chimney stack. Suitable railways are also arranged for dealing with the slag and iron produced by the furnaces.

* H. Pilkington, "Blast Furnace Equipment and Design," *S. Staff. Inst.*, 1892.

† *Inst. Journ.*, 1887, vol. i., p. 91.

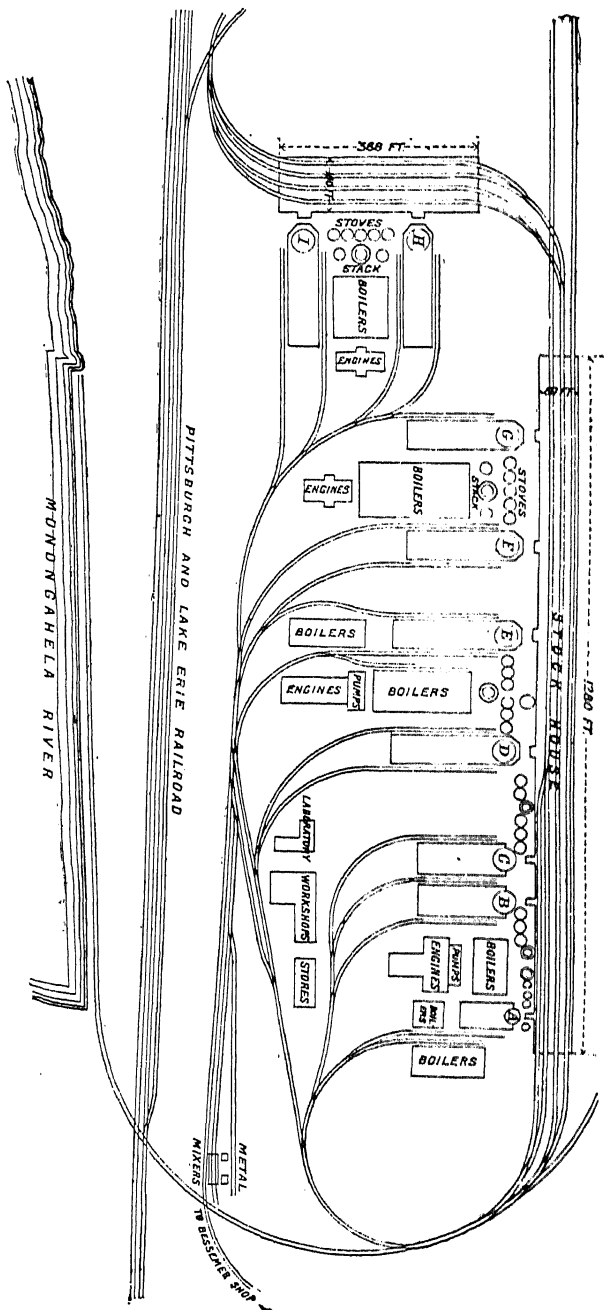

Fig. 16.—Plan of Edgar Thomson Works, Pittsburgh, Pa.

Construction of the Blast Furnace.—The internal shape and dimensions of a modern Cleveland furnace are shown in Fig. 16, taken from Sir B. Samuelson's paper. The furnace con-

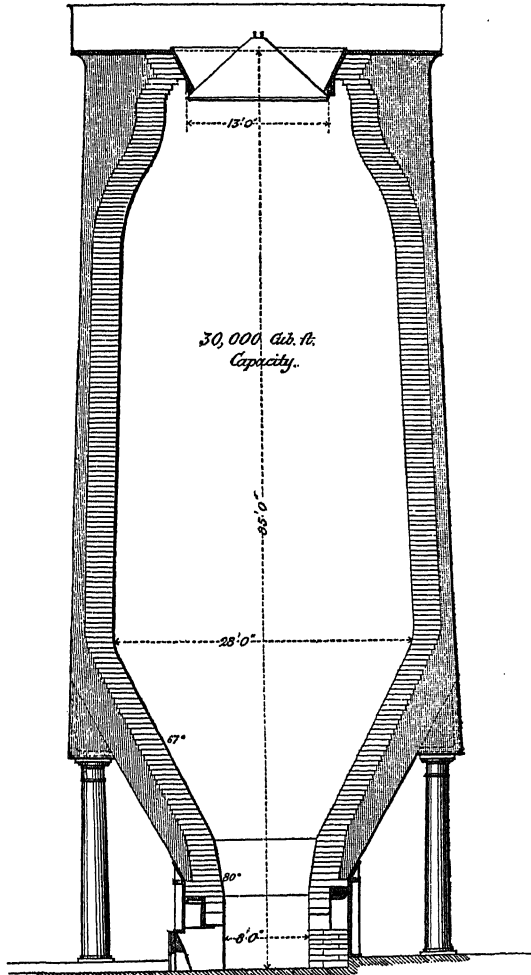

Fig. 16.—Section of Cleveland blast furnace.

sists of an outer shell of wrought-iron plates, rivetted together, and resting on a ring which is supported on cast-iron pillars. It is lined with fire-brick slabs, and closed at the top with the cup and cone arrangement, which is now generally employed, to

allow of the collection of the waste gases and the proper distribution of the charge. The waste gases pass off by means of a vertical pipe or "downcomer" not shown in the figure.

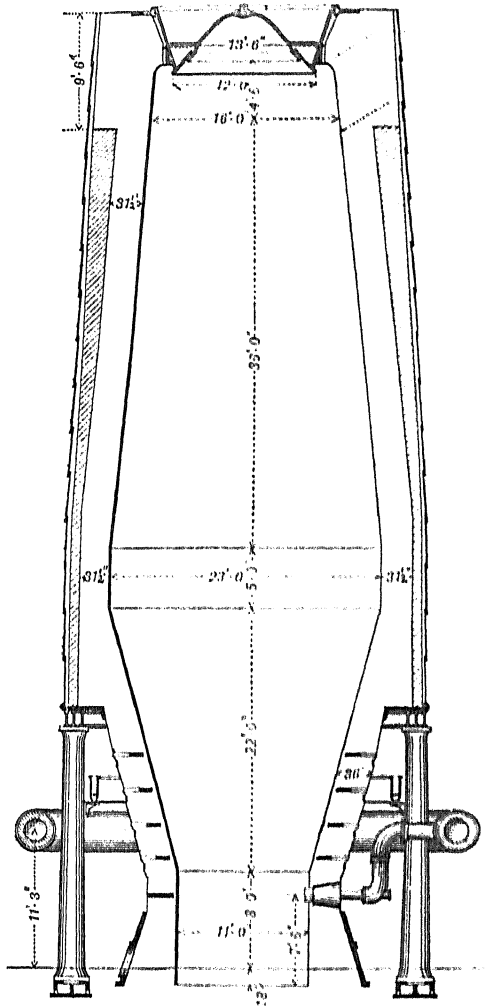

Fig. 17.—Section of blast furnace, Edgar Thomson Works.

This furnace is 85 feet high, the internal capacity 30,000 cubic feet, the diameter at the boshes 28 feet, and at the hearth 8 feet, while that of the charging bell is 13 feet. The blast is heated

by two Cowper stoves for each furnace, and enters through six tuyers at a temperature of about $1,450^{\circ}$ F., and a pressure of 5 lbs. to the square inch. The Cleveland ore employed contains but slightly over 30 per cent. of metallic iron, and is calcined before being used in the blast furnace; about 12 cwts. of limestone is added for each ton of iron made, while about 20 cwts. of hard Durham coke, containing about 7 per cent. of ash, are required per ton of iron. The weekly output of such a furnace would be about 500 tons of grey pig iron, while 750 tons of slag would also be produced in the same time.

As an example of the internal construction of a modern American blast furnace, that of furnace F of the Edgar Thomson Works which is shown in Fig. 17 may be taken.

The furnace is supported in what is now the usual manner on cast-iron columns, upon which rests an annular ring, upon which in turn the shell of the furnace is supported. This consists of plates of wrought iron or mild steel rivetted together, and lined with specially shaped slabs of fire brick. In America the internal lines of the furnace consist of four parts, each represented in section by a straight line—viz., the hearth, the boshes, the belly part, and the stack. The fire bricks are, therefore, more uniform in shape than in Great Britain, where curved lines are often preferred, and each ring of slabs is different in curvature from that immediately above or below it. The maximum internal and external diameters of this furnace are respectively 22 and 30 feet, the diameter of the hearth 11 feet, of the charging bell 12 feet, and of the throat 15.5 feet. The height is 80 feet, and the cubic capacity 18,200 feet. The blast supplied is 25,000 cubic feet per minute, which enters the furnace through 7 tuyers at a temperature of $1,100^{\circ}$ F., and a pressure of 9 to 10 lbs. to the square inch. The ore used is rich, containing 62 per cent. of metallic iron; 10 cwts. of limestone are required as a flux for each ton of iron produced, while 17 cwts. of hard Connellsville coke, containing 10 per cent. of ash, are employed. The slag produced contains 33 per cent. of silica and 13 per cent. of alumina; the waste gases which pass off by two downcomers contain 27.5 per cent. of carbon monoxide, 11.7 per cent. of carbon dioxide, and escape at a temperature of 350° F. This furnace has produced an average weekly output of 2,208 tons of pig iron, 95 per cent. of which was No. 1 or No. 2 grades, during eleven months working, the maximum being 2,462 tons per week; a similar furnace has since produced over 3,000 tons per week.*

Of these two examples it will be observed that the Cleveland furnace has the largest internal capacity, and the smaller hearth; it smelts a poorer ore, has a smaller weekly yield, makes more slag, and consumes more coke per ton of iron made, though the coke is somewhat better than Connellsville. On the other hand,

* *Inst. Journ.* (Amer. vol.), 1890, p. 241.

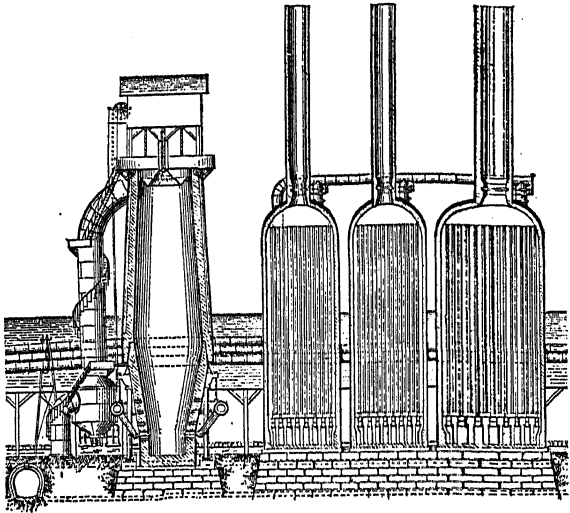

Fig. 18.—Section of blast-furnace plant, Alabama.

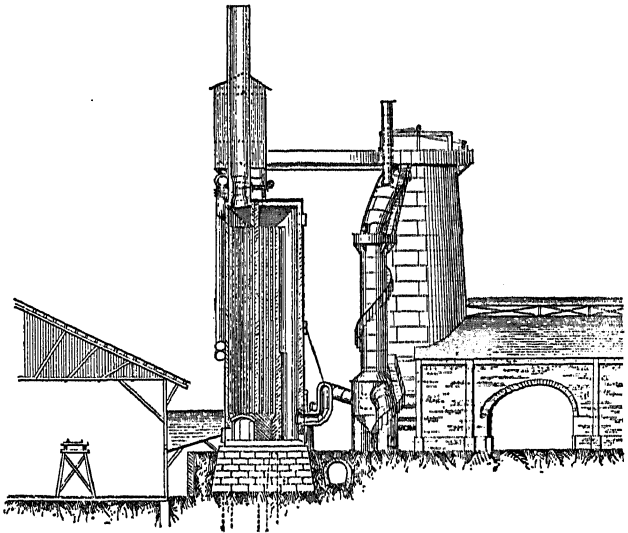

Fig. 19.—Section at right angles to Fig. 18.

the original cost of the plant is somewhat less, while the furnace runs about five times as long without requiring relining, so that the actual production of iron during the working life of each furnace is about the same. In order to lengthen the wear and retain the shape of the boshes in furnaces which work rapidly, it has been found necessary to introduce water blocks, or hollow iron castings through which water circulates, in the brickwork of the bosh. Four such water blocks are shown in the section of the Edgar Thomson furnace, and in more recent furnaces the number of water blocks has been increased still further. For a description of several varieties of bosh plate see *Inst. Journ.*, 1891, vol. ii., p. 241.

The accompanying illustrations (Figs. 18 and 19) show the elevation of a furnace erected in 1890, and forming part of a plant of the Sheffield and Birmingham Iron Company, Alabama. It will be seen that the furnace is provided with the cup and cone charging apparatus; with a downcomer to which a dust catcher is attached; with three fire-brick stoves with separate chimneys, cross-sections of the stoves being given at right angles in the drawings; with underground gas flues; with water blocks in the boshes; with covered stock yard and pig beds; and a separate hoist, only the upper part of which is shown in the drawings.*

Shape of the Blast Furnace.—Much difference of opinion has been expressed as to the proper shape of a blast furnace, some remarkable experiments having been tried from time to time, such as that illustrated by Wilkie,† in which the upper part of the furnace was constructed in the form of a large dome, so as to increase the temperature of that portion. Another marked deviation from usually adopted lines was introduced by Rchette in 1862. This is a vat-shaped furnace, rectangular in plan, 3 feet wide at the twyers, 7 feet wide at the throat, and about 30 feet high. The blast is introduced through about 8 twyers, 4 on each of the longer sides of the hearth, and a weekly output of about 200 tons of grey pig iron is obtained. This furnace was designed by its inventor in accordance with his theoretical views on the distribution of the blast; it has been in use in the Ural district for a number of years, and appears to be suitable for the ores and fuel there employed, but has not been adopted elsewhere. Furnaces of elliptical section were also constructed by Alger in the United States in 1858, but have not met with any favour, and a circular section is now practically universal. A marked departure from the usual form of furnace lines has been introduced in Cleveland by Hawdon and Howson, the boshes being lower and smaller than usual, while the greatest capacity is in the upper or reducing zone of the furnace, the result being a

* *Engineering*, Oct. 24, 1890.

† *Iron Manufacture*, p. 38.

furnace with two boshes, one just above the hearth, and the other near the top of the furnace, with a cylindrical portion between these two smaller boshes. The inventors of this form of furnace claim that a smaller fuel consumption and greater regularity of working result from these alterations.*

The height of blast furnaces varies from about 35 feet with small charcoal furnaces to 105 feet, adopted some years ago at Ferry Hill in Durham. With hard fuel, such as best coke, greater height may with advantage be employed than with soft ores and charcoal; but even in the former case it appears to have been proved in Cleveland practice that no corresponding advantage is obtained with a greater height than about 85 feet. This is due in part to the fact that heat is evolved in the upper part of the furnace by the reduction of ferric oxide by carbon monoxide, and that, consequently, the temperature at the top cannot be reduced much beyond a certain point even by extra height, as raising the furnace would merely raise this source of heat.

The capacity of blast furnaces varies from about 2,000 cubic feet with charcoal and rich ores to a maximum of 50,000 cubic feet in Cleveland. Increased capacity gives diminished fuel consumption owing to more perfect cooling of the escaping gases. This is, however, true only within certain limits, and as the production per unit of capacity decreases as the capacity becomes greater, a point is ultimately reached where no advantage is obtained by additional internal space. In Cleveland modern coke furnaces have a capacity of about 25,000 cubic feet, while in America with richer ores 18,500 cubic feet is preferred. With charcoal furnaces less capacity is required as the gases are cooler owing to the zone of reduction being lower in the furnace.

The angle of the boshes, and their relative height as compared with the rest of the furnace, has led to much discussion. In the early part of the nineteenth century small hearths with flat boshes, which were often low in the furnace, were used. These were replaced by furnace lines with steeper boshes and a gentle curvature, so as to prevent obstructions forming, and similar lines are still often adopted. But the modern tendency appears to be in the direction of a more cylindrical shape, with boshes at an angle of about 75° and tolerably low in the furnace, as shown in Fig. 17. It appears, however, to be quite proved that no one shape is universally the best, but that modifications are necessary according to the nature of the ore and fuel, and with rapid working and richer ores a steeper bosh is permissible. It may be added that perfectly cylindrical furnaces have been tried but have always worked unsatisfactorily. Although attention has long been given to the internal shape of the blast furnace, and the question was discussed at some length by Dr. Percy in

* *Inst. Journ.*, 1894, vol. i., p. 78.

1864,* many details connected with this subject are still in dispute, and it is a common occurrence to find even in the same works, when treating similar materials, considerable variations in the internal shape of furnaces which are working side by side.†

Details of Construction.—The following details of construction illustrate modern practice at representative British blast furnaces:—

	Eston.	Dowlais.	Lowmoor Cold Blast.
Height,	92 feet	75 feet	70 feet
Diameter at boshes,	23 "	20 "	18 "
Angle of bosh,	72°	78°	...
Diameter of throat,	15 feet	15.5 feet	15 "
" bell,	11 "	11 "	11 "
" crucible,	10 "	10 "	9 "
Number of tuyers,	6	7	3
Diameter of muzzles,	5½ inches	5 inches	4 inches
Blast pressure,	5¼ lbs.	5½ lbs.	4 lbs.
Coke per ton of iron,	19 cwts.	under 20 cwts.	38 cwts.

The furnace at Eston is provided with Cowper stoves, which supply blast at a temperature of visible redness in daylight; the ore contains 50 per cent. of metallic iron, and the weekly production is about 1,000 tons of pig iron.

At the Dowlais Company's works at Cardiff the blast is heated with Cowper stoves to about 1,300° F., and a separate blast engine, giving about 19,000 cubic feet of air per minute, is attached to each furnace. The ore is rich "rubio" from Spain; the weekly production is, per furnace, about 1,400 tons of pig iron, 70 per cent. of which is No. 1 grade.

The Lowmoor furnace is probably the largest cold-blast furnace yet constructed. The ore used is calcined clay ironstone, containing 42 per cent. of metallic iron; each furnace is provided with a separate blowing engine, which supplies about 10,000 cubic feet of cold air per minute, while the weekly production of pig iron is 350 tons. Detailed drawings of this furnace are given in the paper from which the above particulars are extracted.‡

It is usual to rest the furnace shell on lintel plates, which are supported on cast-iron columns about 20 feet high; these are sufficiently strong to receive the whole weight of the furnace lining and superstructure. The hearth must be relieved of the weight of the lining, and this, again, of the weight of the bell,

* *Iron and Steel*, 475. See also Chap. II.

† On this subject see *Inst. Journ.*, 1887, vol. i., pp. 392, 393; vol. ii., p. 284; E. Walsh, *Amer. Inst. Min. Eng.*, 1886.

‡ Windsor Richards, *Inst. Journ.*, 1893, vol. i., p. 20.

hopper, and platform. These fittings at the top of the furnace are, therefore, usually supported on internal iron brackets attached to the casing. As the lintel has to support a very considerable weight, it is either made of heavy ribbed plates, or is supported by relieving arches sprung from column to column. In America the same object is attained by rolled joists, bent to the circle of the furnace, upon which an ordinary lintel plate rests. In this manner any extra weight due to accident or uneven settlement is safely carried.

Recently furnaces have been built in which the charging platform is supported on a staging altogether separate from the furnace, while the boshes are also made separate from the stack. This arrangement possesses the advantage that, in case of accident or repairs, each portion is distinct, and can be separately dealt with. It will be observed that in Fig. 18, the boshes are represented as separate from the stack, while Dr. Wedding has illustrated arrangements introduced by Lürmann for the same object, and also a furnace at Hoerde with a staging for carrying the superstructure of the furnace.*

In order to preserve the internal shape of the furnace, the brickwork is made as thin as possible, so as to permit of air-cooling. The use of iron columns instead of solid masonry has allowed of the boshes in particular being made light and thin, though, as previously mentioned, water blocks are being introduced in the boshes to still further maintain the shape, as the furnace then works better and more economically.

Furnace Hearths.—The hearth or crucible of the furnace is circular in section, varying in diameter from about 5 to 13 feet, and, so long as other conditions do not alter, its capacity largely determines the output of the furnace. The larger the diameter of the hearth, and the greater the vertical distance between the slag notch and the twyers, the greater is the output, since with enlarged diameter the melting area is increased, while by raising the twyers above the slag level, fusion proceeds without hindrance. The bottom of the hearth is made of blocks of refractory sandstone, carefully jointed; they are at first made quite flat, but in course of time wear into a hollow, and the metal which accumulates in this space when the furnace is blown out is called a "bear." It is usually highly graphitic, and is encrusted with "kish" or separated graphite; with cyano-nitride of titanium, in the form of beautiful crystals with a bright-copper colour, with cinder, and with silica, in the form of beautiful radiating masses, which in appearance resemble a vegetable growth. The properties of this fibrous silica have been fully described by Dr. Percy,† and by Blair,‡ while the conditions of its formation have been studied by the author, who has shown that it is pro-

* *Inst. Journ.*, 1890, vol. ii., pp. 511, 514.

† *Iron and Steel*, p. 507; *Inst. Journ.*, 1886, vol. i.

‡ *Ibid.*

duced by the slow oxidation of the silicon present in the iron by the carbon monoxide present in the atmosphere surrounding it.*

In some cases the furnace bottoms have a tendency to grow, owing to the adhesion of infusible substances; in such cases it is best to deepen the hearth, and always keep about 12 or 18 inches of fluid metal below the tapping hole. This keeps the bottom warm, prevents the formation of objectionable deposits, and diminishes the wear on the hearth bottom. The tapping hole should be midway between two tuyers, so as to be cool, and convenient of access; the slag notch should, for similar reasons, also be placed between two tuyers, and away from the tapping hole. Fig. 20 shows a section through the slag notch and tapping hole of a blast furnace at Hörde, and is from a drawing by Dr. Wedding.†

The arrangement of hearth just described is that now in most general use, and is known as a "closed" hearth. This method of working the blast furnace was introduced by Lürmann about 1875, and it was formerly the invariable custom to have an "open fore part." In front of the furnace there was an arched-over opening extending from the furnace

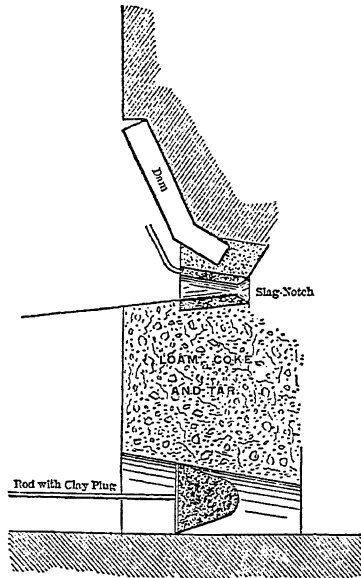

Fore-Hearth, Cinder- and Iron-Notches of a Blast-Furnace at Hörde.

Fig. 20.

bottom to a little above the level of the tuyers; the sides and roof of this opening formed a cavity known as the *fore-hearth*. A wall of fire-brick called the *dam* was carried to the tuyer level; it formed the back of the fore-hearth, and was supported by a cast-iron *dam-plate*; in the dam-plate was a vertical slit which was stopped with loam, and which allowed of a tapping hole being made at any convenient level, while the excess of cinder ran off through a semi-circular *cinder-notch*. The arch above the dam was called the *tump*; it was kept in position by a *tump-plate* of cast iron, and generally cooled by running water. The open fore part necessitated longer time for opening and repairing the tapping

* *Inst. Journ.*, 1887, vol. i., p. 203]

† *Ibid.*, 1890, vol. ii., p. 512.

hole at each cast, and also required the blast to be off during the time the furnace was being tapped. A closed fore part, therefore, increases the production of a furnace in a given time.* On the other hand, in case of irregular working or very infusible materials, an open fore part allows of the withdrawal of infusible lumps by means of iron rods, and so assists in keeping the furnace "open," or preventing its becoming "gobbed up." Open fore parts are, therefore, still used in some cases, as in the production of rich ferro-manganese and other special irons, and in places where modern methods have not been adopted.

Wear of Linings.—According to Lürmann, the chief causes which lead to the wearing away of blast furnace linings may be divided under four heads:—(1) The actual wear due to contact with the descending charge; this is relatively unimportant. (2) The action of alkaline cyanides and other substances present in the furnace gases; which, though probably important, produce an effect the amount of which is at present not accurately determined. (3) The action of sodium chloride or other alkaline substances contained in the coke; this is probably one of the most important causes of wear, as at a high temperature salt is decomposed by silica, and a fusible silicate is obtained. (4) The flaking of the bricks due to deposition of carbon, from carbon monoxide, around any iron particles reduced from impurities in the original bricks. The last cause can to a considerable extent be prevented by a proper selection of bricks. In regular working the lining of the blast furnace is to a great extent protected by a deposit of carbon, resembling kish, which forms on the sides.

Carbon Linings of Furnace Hearths.—In blast furnace working the linings of the boshes and hearth undergo very rapid corrosion, especially with hard driving, until a carbonaceous deposit forms, between the charge and the brickwork, which to a great extent arrests the destructive action. According to T. Jung, bricks made of fine coke or charcoal had long been used in the lead works of the Hartz, in positions where the corrosion of the furnace lining was unusually great, but they were first applied on a practical scale in the iron blast furnace at Gelsenkirchen. The coke is dried, pulverised, and sifted; it is then intimately mixed with about one-fifth of its weight of tar, and moulded into bricks which are allowed to dry in the mould for fourteen days, and are then fired without access of air. The bricks so produced cost about twice as much as good fire-bricks, but they possess the advantages that they are absolutely infusible at the highest temperature of the blast furnace, while, as they resist the action of both acid and basic slags, they are very durable. As they are bad conductors of heat they reduce the

* T. Whitwell, *Inst. Journ.*, 1878, vol. i., p. 200.

loss by radiation, and they prevent the formation of furnace "bears."*

J. Gayley also proposes to line the hearth and boshes of blast furnaces with carbon bricks, which are prepared by grinding good hard coke, heating, and mixing it with hot tar; it is then moulded by pressure into bricks, which are fired at a low temperature in a muffle (Eng. Pats., 13,690 and 19,330, 1891).

According to Dr. Wedding, the use of carbon linings renders special cooling of the boshes and hearth less necessary; carbon bricks are suitable even for bosh and belly walls, and are likely to find increasing favour except where lead or zinc occurs in quantity in the ore.†

Lifts or Hoists.—In modern iron works some method of rapidly raising large quantities of raw material to the furnace top is a necessity. Among the best known forms of machinery for this purpose are the following:—

1. The inclined plane, generally with two tables, one of which descends while the other ascends; it is worked by means of a separate small engine which has thus merely to lift the load and overcome the friction of the apparatus. It is a relatively slow lift, requiring considerable space, and is now seldom employed.

2. The blast lift, in which the floor of the lift forms the top of a wrought-iron cylinder, which is connected with the cold blast and is open below, and which rises and falls in a circular pit of water, according to the pressure of the air inside, like a gasometer. This lift has the advantage of being driven by the blast engine, but is slow in its action and not much used. For illustrations of this and other forms of lift see Phillips and Bauerman's *Metallurgy*, p. 258, *et. seq.*

3. Vertical lifts with two tables, worked with a separate small steam engine with drum and pulley wheels, similar in principle to the head gear of a coal pit, are in favour in America, and to some extent elsewhere.

4. The water balance lift is in very general use in the United Kingdom. Occasionally single tables are used, but it consists usually of two tables, which are so constructed as to form at the same time two water tanks; these tables when empty counterbalance each other; when working, sufficient water is run into the tank of the empty cage at the furnace top to more than counterbalance the load in the other cage. The water used can, if necessary, be pumped by the blast engine so as to avoid the use of special machinery, and this lift is cheap, simple, and rapid in action.

5. Hydraulic lifts are also employed, having been first introduced by Lord Armstrong. In these a small quantity of water at high pressure is employed, and the necessary motion of the

* *Inst. Journ.*, 1891, vol. ii., p. 240.

† *Ibid.*, 1890, vol. ii., p. 506.

winding rope is obtained by causing it to pass several times round a series of pulleys attached to the ends of the hydraulic cylinder and piston respectively; the motion of the piston can thus be multiplied to any desired extent. For a sketch of such a lift see Kohn's *Iron Manufacture*, p. 40.

The barrows employed for filling the materials into the blast furnace are made of sheet iron, and vary somewhat in construction and capacity. According to Ridsdale, they hold about 7 cwts. of coke, 13 cwts. of calcined iron ore, 15 to 16 cwts. of limestone, and from 15 to 24 cwts. of heavy slags. The following figures, giving the approximate weight of a cubic yard of materials used in the blast furnace, are useful for reference:—

1 cubic yard of Durham coke	weighs about	6½ cwts.
" " calcined Cleveland ironstone	" "	20 "
" " limestone	" "	20¾ "
" " raw Cleveland ironstone	" "	24 "
" " mill furnace tap, . . .	" "	34½ "

Collection of Waste Gases.—The top of the blast furnace was originally quite open to the air, and the gases were allowed

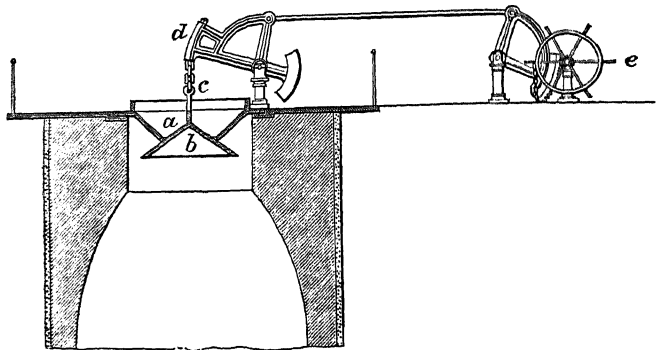

Fig. 21.—Cup and Cone arrangement.

to burn as they issued; in modern practice, however, the gases are collected and utilised. The methods of withdrawing the gases may be classified according as to whether the gases are drawn off from above or from below the level of the materials in the furnace. The most general method of collecting the gases, and at the same time assisting in the regular distribution of the furnace charge, is known as the "cup and cone" or "bell and hopper" arrangement; it was first introduced by G. Parry at Ebbw Vale in 1850, though a cone and cylinder had been previously used elsewhere. This is illustrated in Fig. 21, from which it will be seen the cone (b) is supported by means of a chain (c) or by an iron link to a counterbalanced lever (d), while the

materials are charged by means of hand filling with barrows into the cup (*a*) and around the cone, which is in the meantime kept closed, and the gases pass into the downcomer from above the stock line of the furnace. The cone is then lowered so as to allow the materials to fall into the furnace, and during this momentary interval gas escapes and burns with a flame of considerable size. The cone is again raised so as to close the opening, and charging proceeds as before. The gas as it leaves the furnace is under pressure above that of the atmosphere equal to supporting a column of water half an inch in height, and this is sufficient to carry it to the stoves or boilers. The size and angle of the cone exert a considerable influence on the proper distribution of the materials, and thus on the regular working of the furnace, and to this further reference will be made.

Though the cup and cone arrangement is most generally em-

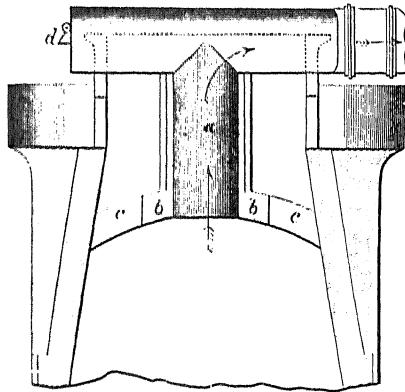

Fig. 22. - Central Tube arrangement.

ployed, especially with dry materials of considerable size, other methods of withdrawing the gases from below the stock line are also in use, especially where wet or very finely-divided ores are used. One of the earliest plans was the provision of a gas flue and suitable openings in the walls of the furnace, a few feet below the top of the charge; by means of a regulated chimney draught a considerable proportion of the gases could then be drawn off, while the furnace was otherwise open-topped, as was then usual. The same result is also obtained by the use of a central tube supported upon arches; this tube passes down some feet beneath the surface of the materials in the centre of the furnace; it is open below, and as the charge offers some resistance to the passage of the gas, while the tube has the assistance of chimney draught, the greater part of the gas is collected and utilised. If too much draught were employed in these cases,

of course, air would be drawn in, and an explosive mixture produced. One form of this apparatus is illustrated in Fig. 22, and a similar arrangement is still employed at a number of furnaces in Cumberland. A central tube of this kind was employed at Thornaby Iron Works in 1864.* A top closed with a lifting-valve, and having a fixed distributing cone underneath the valve, was used at Ormesby about the same time, but afterwards abandoned in favour of the cup and cone.† In North Lincolnshire, where the ores are soft, and contain a considerable proportion of water, a charging cylinder is attached to the hopper at the top of the furnace. The charge in this tube checks the escape of the gas, which is drawn off by chimney draught, and employed for boilers and stoves as usual. A small quantity of gas burns in the central tube, and so dries the ore, and this method is found to give better results with wet ores than the cup and cone. In America the cup and cone is almost universal, and not unfrequently the apparatus is worked by overhead steam or hydraulic power, so as to give a strictly vertical motion, as this gives better distribution of the materials than the usual method of suspension, in which the cone moves through the arc of a circle. In Germany a number of methods are in use, which include the cup and cone for lump ores, and central tubes for finer materials. The cones are sometimes operated by steam power, as in America, while the central tubes are made to contract somewhat as they pass lower down the furnace. Special arrangements for charging are also sometimes adopted, of which illustrations have been given by Dr. Wedding.‡ The gases are frequently collected from the centre of the throat, instead of from the sides, as is usual in the United Kingdom; a gas-tight joint is obtained by means of a water lute, a telescopic gas tube is used, and the bell raised or lowered, as the case may be, to allow of the introduction of the charge.

Dust Catchers.—The waste gases from the blast furnace frequently contain considerable quantities of dust, consisting of particles of ore, carbonaceous matter, &c., mechanically carried over, together with more or less oxide of zinc and other matter. The amount of dust is variable, being very small in some cases, but is usually greater when smelting manganiferous ores. This dust is objectionable, as it rapidly stops up the air passages of the hot-blast stoves, while in some cases, as when zinc is present, the dust is itself of value, and pays to collect. In order to keep the stoves as clear as possible, many forms of dust catchers are in use, these being placed in the “downcomer” or wide pipe, bringing the waste gases from the furnace to the gas main. Fig. 23 shows a form of dust catcher in use in America, and

* *Inst. M. E.*, 1864, p. 253.

† *Ibid.*, p. 163.

‡ *Inst. Journ.*, 1890, vol. ii., pp. 508-513.

needs but little explanation. The gases pass down the central tube into a wider tube which they ascend on their way to two tubes leading to the main gas flue. The dust collects at the bottom of the wide tube, and can be readily removed by means

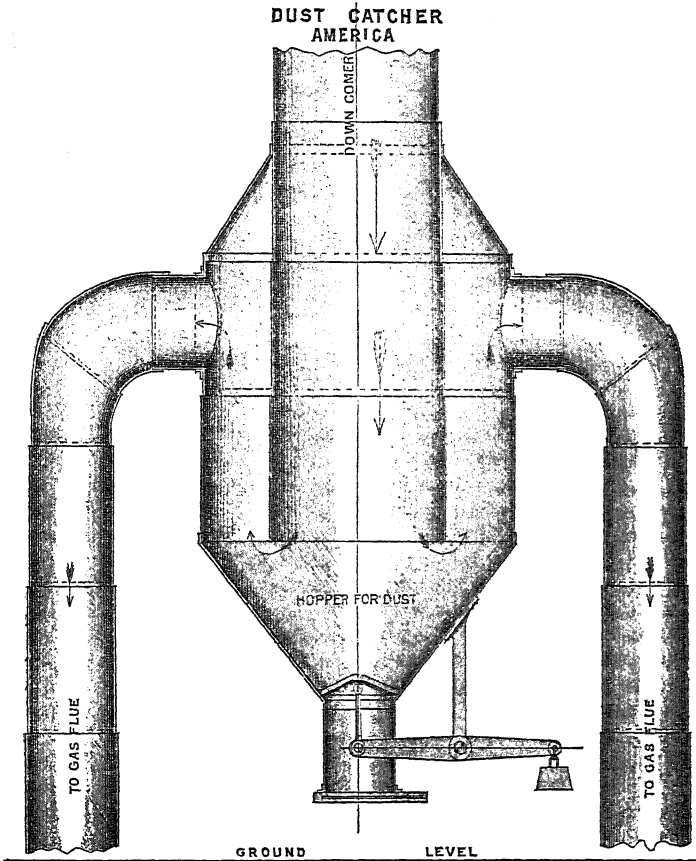

Fig. 23.

of a weighted lever attached to a valve at the bottom.* The downcomer should be of ample capacity, so that the gases shall never exert any back pressure, and the upper part or neck of the tube should be constructed so as to prevent the lodgment of dust. The amount of dust passing to the stoves is also dimin-

* Pilkington, *S. S. Inst.*, 1892.

ished if, by the use of wide and long tubes, the gases have to travel further and at a slower rate.

As previously mentioned, the dust collected from blast-furnace gases not unfrequently contains zinc, in the form of oxide, in sufficient quantity to make it valuable; other volatile substances, such as arsenic or alkaline chlorides or oxides, are present, as would be anticipated. At Hoerde the flue dust contains a considerable proportion of potassium sulphate, which is extracted by lixiviation and the subsequent evaporation of the solution so obtained. In many cases, however, the dust is of no commercial value, as, for instance, the following sample from Dowlais analysed by E. Riley :—*

Silica,	30·33	per cent.
Ferric oxide,	47·05	„
Alumina,	8·43	„
Calcium sulphate,	4·42	„
Manganous oxide,	1·77	„
Lime,	2·30	„
Magnesia,	1·13	„
Potash,	1·80	„
Other constituents,	1·77	„
	<hr/>	
	100·00	„

Handling of Pig Iron.—It was formerly the universal custom to remove the pig iron from the beds by hand when it had cooled sufficiently, and this practice is still very generally adopted; the enormously increased production of modern blast furnaces has, however, led to the introduction of improved methods of handling pig iron. At the Dowlais Company's Cardiff works the moulding is done by mechanical means, so that the pigs are of uniform size and equidistant, and are cast in groups each of thirty pigs. When the metal is cold an overhead crane picks up the whole group of thirty pigs and runs with it at a high speed down an incline to a pig breaker. The pigs are broken with a hydraulic ram, and the broken pieces slide down a shoot into a railway waggon. This arrangement, working nine hours per day, is capable of dealing with 4,000 tons of pig iron per week, and saves labour, while it assists in the classifying and storing of the iron.† In America an apparatus has been introduced which consists of grapplers, which are suspended from trolleys running on a traveller which spans the pig bed. A powerful electromagnet, suspended from a crane, and which can be raised or lowered at will, has also been employed, and in this case the load can be dropped by simply stopping the electric current. ‡ The pigs are usually broken by manual labour, being allowed to fall from a height upon an iron ball, and are then classified

* Percy, p. 472.

† *Inst. Journ.*, 1893, vol. i., p. 18.

‡ *Ibid.*, 1890, vol. ii., p. 751.

according to their fracture. Grey pigs made from non-phosphoric ores are very tough, and more difficult to break in this way than less pure samples; hence with hæmatite iron and large outputs, pig breakers are not unfrequently employed. A machine has been invented for this purpose by Armstrong & James, of Middlesbrough (English Patent 16,696, 1892).

Blowing In and Out.—When a furnace is first started, or when it has been standing for some time idle and smelting is again resumed, it is said to be “blown in.” It is then necessary to raise the temperature of the brickwork gradually, so as to allow it to dry and to expand regularly. For this purpose the hearth is filled with wood, above which are layers of coal or coke; the fire is lighted through one of the twyer holes, and a very gentle blast introduced, special nozzles of small diameter generally being employed. Blank charges of coke are added from time to time, and usually a quantity of blast furnace slag is melted before any ore is used. The burden is at first light, and the product is usually a “blazed” or “glazed” iron rich in silicon. The burden is gradually increased until the full charge is employed, but it is usually several months at least before the furnace reaches its maximum weekly output. As illustrating the methods adopted in blowing in a large coke furnace the account given by J. Gayley of the practice at the Edgar Thomson Works in America may be read with advantage.* When the lining of the furnace is worn out, or when for any reason its working is to be stopped, it is “blown out” by gradually reducing the burden, and at last using nothing but fuel, so as to melt all obstructions on the furnace walls and to clear the hearth as far as possible from slag, metal, and other materials. If owing to shortness of supplies, strikes, or similar reasons a temporary stoppage is necessary the furnace is “damped down” by charging in a quantity of coke, and carefully shutting off all access of air; the heat may thus be maintained for weeks, and smelting can be resumed at any time when desired.

Blast Furnace Practice in America and in the United Kingdom.—Owing to a variety of circumstances, the aim of the American blast furnace manager has been largely directed to the production of large outputs, while, as fuel is cheaper in America, economy in this respect has not been so necessary, though, as has been pointed out elsewhere, in some instances very remarkable results have also been obtained in this direction in American practice. The materials used in the north of the United States are different in character from those employed in the Southern States, and the northern furnaces have generally been most efficient. The circumstances which have brought about such large makes in America have been summarised by W. Hawdon as follows:—†

* *Inst. Journ.* 1891, vol. ii., p. 233.

† *Ibid.*, vol. i., p. 335.

1. The use of rich ores, which are in a state of tolerably fine division, and which are thus easily acted upon by the furnace gases, and by the fuel. The ores are also carefully mixed and selected, so as to ensure uniformity of quality, and a readily fusible slag.

2. The use of good strong coke, of uniform quality. The coke for any particular iron works is usually all obtained from one source of supply; this renders the working more uniform in character, but has the disadvantage, in case of labour or other troubles, that the supply may be suddenly cut off. In the United Kingdom the coke used is also generally excellent.

3. The use of a blast pressure as high as 9 or 10 lbs. to the square inch. In England it is customary to supply all the furnaces at an iron works from the same blast main, but in America the air which is delivered into each furnace is supplied by a separate engine, and is regulated by the number of revolutions of the engine. In case a furnace "hangs," or drives slowly from any cause, when the blast is supplied to several furnaces by one main, less air passes through that particular furnace, which is really most in need of driving; on the other hand, if the blast is regulated by the number of revolutions of the engine the same quantity of air is forced into the furnace whether there is any stoppage or not, and any obstruction is thus more easily melted and removed.

4. The blast is employed at a high temperature from modern regenerative stoves; in this respect the practice is identical in the United Kingdom.

5. Regular filling and distribution of the charge in the blast furnace.

6. A healthy rivalry to beat the record, in which the workmen readily join.

To the above must be added the fact that the improved furnace lines, with steeper boshes and larger hearths, adopted in America have no doubt largely contributed to the increased yield; the shape of the furnace lining has been maintained by the use of water blocks in the boshes, and even around the well of the furnace; the iron used in the Bessemer works is lower in silicium than in the United Kingdom, and hence the furnace production is greater; while improved appliances have been introduced for handling the larger quantities of materials. A detailed account of modern American practice has been given by J. Gayley,* in a paper which was discussed at length by the leading metallurgists of Great Britain and America.

The rapid driving of a blast furnace leads to the rapid destruction of the furnace lining, so that in America it is usual for the stack to require relining about once in three years, while in England the furnace lining lasts from about eleven to fifteen

* *Inst. Journ.*, 1890, vol. ii., p. 18.

years. With rapid driving, also, the wear and tear on the engines, boilers, and other accessories is much greater. Much difference of opinion has, therefore, been expressed as to the relative advantages and disadvantages of the two systems, and it is generally considered that in the end the most economical makes are obtained with moderately rapid working.

Starting with an ordinary Cleveland plant making 500 tons of pig iron per furnace per week, it would be necessary, in order to increase the production to 1,000 tons per week, to double the number of boilers, stoves, engines, and calciners, and to provide a separate lift to each furnace, instead of one lift to three furnaces, as at present. It would also be necessary to increase the size of the well of the furnace to enable it to hold the larger bulk of iron and slag; the blast main, downcomers, steam pipes, and feed-water pipes would all be too small, while, lastly, the under ground chimney flues would need to be largely increased in size to deal with the waste gases, and a separate chimney would have to be provided for each furnace. The alterations needed would thus be so revolutionary that it is not likely that they will be introduced in plants already in satisfactory work, and where American practice is adopted in this country it will be in newly erected works.*

Production of Cast Iron in Styria.—The chief ore employed in the Styrian iron works is that obtained from Erzberg, or the Ore Mountain, near Eisenerz. The mountain consists of a bedded deposit of spathic iron ore, which rests below upon schists which are believed to be of Devonian age. The mountain itself is conical, with a rounded summit, reaching to a height of 4,800 feet, or nearly 3,000 feet above the small town of Eisenerz. The ore is obtained in open works or quarries on the face of the Erzberg, and has been so quarried for nearly 2,000 years. The lowest ores are somewhat more siliceous, and so less valuable, but those higher on the mountain are of special purity. The ore is usually basic in character, and in the raw state contains upwards of 40 per cent. of iron, 2 per cent. of manganese, 3 per cent. of magnesia, and 5 per cent. of lime.

The ore after being brought from the quarries or mines is calcined in kilns with the waste gases from the blast furnace.

* C. J. Bagley, *Inst. Journ.*, 1891, vol. i., p. 356. Students interested in the modern development of blast furnace practice may read with advantage papers by C. Cochrane (*Inst. M. E.*, 1864, p. 163), and J. G. Beckton (*ibid.*, p. 249) for a description of Cleveland practice in 1864; then Jno. Gjers, "A Description of the Ayresome Iron Works" (*Inst. Journ.*, 1871, p. 202); Thomas Whitwell, "Cleveland and American Construction, Dimensions, and Management of Blast Furnaces" (*Inst. Journ.*, 1878, vol. i., p. 197), and afterwards papers by J. Potter (*Inst. Journ.*, 1887, vol. i., p. 163; 1890, vol. ii., p. 55); H. Pilkington (*S. Staff. Inst.*, 1891), and J. L. White (*Iron Age*, vol. xlvi., p. 406). They will thus be able to trace the gradual development of modern practice.

Much of the carbon dioxide is thus eliminated, and the iron is almost entirely oxidised to the ferric condition. The following is an analysis of the calcined ore:—

Ferric oxide (Fe_2O_3),	67.78	per cent.
Ferrous oxide (FeO),	2.00	„
Manganous oxide (MnO),	3.86	„
Lime (CaO),	7.15	„
Magnesia (MgO),	2.90	„
Alumina (Al_2O_3),	1.79	„
Silica (SiO_2),	7.05	„
Copper oxide (CuO),	trace	„
Phosphorus pentoxide (P_2O_5),	0.057	„
Sulphur trioxide (SO_3),	0.11	„
Carbon dioxide (CO_2) and water,	7.60	„
	100.297	„

This material is of very special purity, being low in phosphorus, copper, and sulphur, and relatively high in manganese. It is smelted in small blast furnaces, the fuel used being entirely charcoal. Of such furnaces there is a number in the vicinity of the Erzberg, and these vary somewhat in shape and dimensions. A representative furnace is about 11.4 metres (36.4 feet) high, with a capacity of 35 cubic metres (1,240 cubic feet). The blast is produced by a water-wheel, and requires 25 horse-power, 5 additional horse-power being required for other purposes connected with the furnace. The blast pressure is 45 to 50 millimetres of mercury (about 1 lb. to the square inch); it is heated in pipe stoves by the waste gases, to a temperature of 200° to 300° C., and enters the furnace by 5 bronze twyers. The charge consists of 12 hectolitres (33 bushels) of charcoal, 438 kilos (8.6 cwt.) of calcined ore, and 9 kilos (20 lbs.) of quartz, which is required to act as flux. The time required for the ore to pass from the furnace top to the hearth is about four and a half hours. About 118 charges are employed per day, the furnaces being tapped about sixteen or seventeen times during the same period, each tapping consisting of about 1,600 kilos (1½ tons) of cast iron, corresponding to a daily output of 26,500 kilos (26 tons), or a weekly production of about 180 tons. Professor Tunner states that, with good working, about 65 to 70 lbs. of charcoal are required to produce 100 lbs. of pig iron.* The furnace has no fore-hearth, but slag and metal are allowed to accumulate together, and are then tapped off; the slag, which is fluid and siliceous, floats on the top, while the iron is allowed to run into a thin cake, which is broken up for subsequent use. The metal obtained is a white iron, very low in silicon and phosphorus; other grades may, of course, be produced in these furnaces, but white iron is always preferred for the production of open-hearth steel, and a similar metal is also employed in the

* *Inst. Journ.*, 1882, vol. ii., p. 561.

Styrian puddling furnaces. The following are analyses of such iron :—

STYRIAN WHITE CAST IRON.

	Supplied by Makers.	Percy.	Greenwood.	
Total carbon, . . .	3·430	3·81	2·93	3·25
Silicon,	0·110	0·37	0·307	0·13
Sulphur,	0·016	0·02	0·018	0·03
Phosphorus,	0·066	0·05	0·021	0·02
Manganese,	1·010	1·02	0·724	0·71
Copper,	trace
Metallic iron, . . .	95·368	94·68	96·00	...
	100·000	99·95	100·000	...

The pig iron, as above, having been broken into pieces of a suitable size, is employed for the production of steel by the puddling or the open-hearth charcoal fining process.*

* F. Korb and T. Turner, *S. Staff. Inst.*, 1889. Further details of the blast furnaces and subsidiary processes will be found in the following:—*Inst. Journ.*, 1882, vol. i., p. 286; vol. ii., pp. 426, 534, 618; Greenwood, *Steel and Iron*, pp. 130, 133. Other analyses of Styrian cast iron will be found in the *Jahresbericht*, 1885, p. 2,035; *Inst. Journ.*, 1891, vol. i., p. 364.

CHAPTER VII.

THE AIR USED IN THE BLAST FURNACE.

Blast Engines.—In India and other parts of the world where the natives produce wrought iron direct from the ore, various simple forms of bellows are made from the skin of an animal and

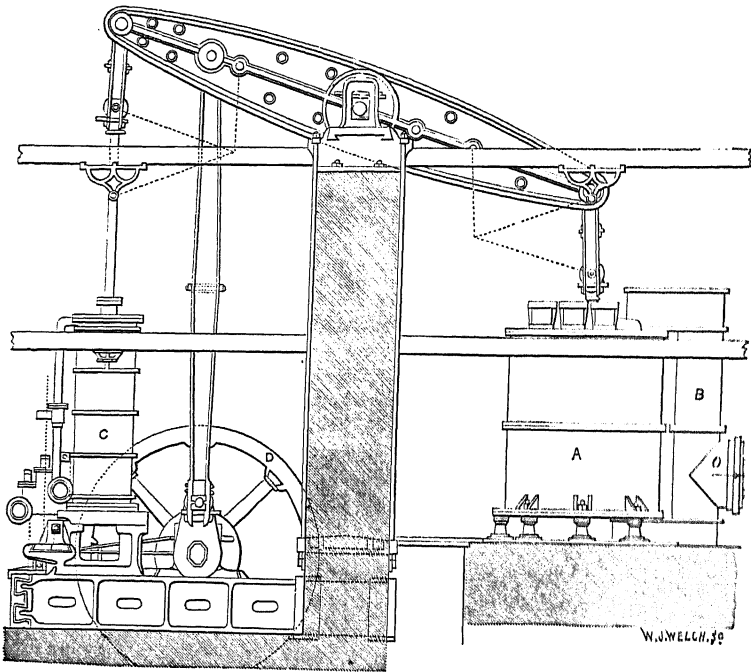

Fig. 24.—Beam Blast Engine.

A, Blast cylinder. B, Blast pipe leading to main, O. C, Steam cylinder.
D, Fly wheel.

worked by hand; furnaces and bellows of similar design were employed by the ancient Egyptians many centuries before the Christian era. These were afterwards replaced by leather bellows with valves, which were at first worked by hand and afterwards with water power. One of the first applications of

the steam engine was for the blowing of air for blast furnaces, and some blowing engines of the early type are still working in the older iron districts. These engines are of the Watt pattern, and consist of a massive beam of cast iron supported at the centre, a steam cylinder being connected to one end of the beam and a blowing cylinder to the other; low pressure steam is used, and the engine is worked with condensers and with a single steam cylinder. Such engines often work for many years with but trifling repairs, but on account of the great weight of metal to be moved they can only be worked at a slow rate, they are not so economical in fuel as more modern engines, and if a fracture of the beam does occur it usually occasions much damage and loss of time. A drawing of a blast engine of this kind is given in Fig. 24, while another illustration of a similar form, together with the necessary pumps, fly-wheel, &c., is given in Dr. Percy's *Iron and Steel* (p. 387).

Vertical direct-acting engines are now generally preferred for producing the blast, and the compound principle has been successfully applied at a number of modern works. As an example of this the blast engines at the new Dowlais Works at Cardiff may be taken. These engines, which are illustrated in Fig. 25, are worked with a boiler pressure of 100 pounds to the square inch, and have two steam cylinders, side by side, one 36 inches in diameter for high pressure steam, and another, which is steam-jacketed and 64 inches in diameter, for low pressure. Connected with, and directly underneath, each steam cylinder is a blast cylinder 88 inches in diameter. The engines are designed to give a maximum pressure of 10 pounds to the square inch, and working with a 5-foot stroke at 23 revolutions per minute they give 19,000 cubic feet of air per minute at atmospheric pressure. There is a separate engine for each furnace, on the American principle, and the number of revolutions of the engine is automatically recorded by means of a mechanical counter. The engine is capable if necessary of blowing 25,000 cubic feet of air per minute, and the pressure actually developed by the engine in ordinary working is rather over 5 lbs. to the square inch.* A number of American blowing engines have been illustrated and described in *Iron Age*, vol. xlvii, pp. 319, 968; vol. xlvi, pp. 303, 441.

It appears from information collected by A. von Ihering that in 1892 there were in Austria and Germany 191 blowing engines for blast furnaces; of these 87 were vertical, 70 were horizontal, and 25 were beam engines, while 9 were worked by water power. It will be thus seen that for blast furnaces vertical engines are generally preferred, especially in modern works, though with higher pressures and smaller volumes of air as in Bessemer steel works, horizontal engines are best.†

* *Inst. Journ.*, 1889, vol. i., p. 19. † *Inst. C. E.*, vol. cxii., p. 432.

Theory of the Hot Blast.—It may at first sight appear strange that any economy should result from the use of hot blast, and in the early days of this discovery it was urged that

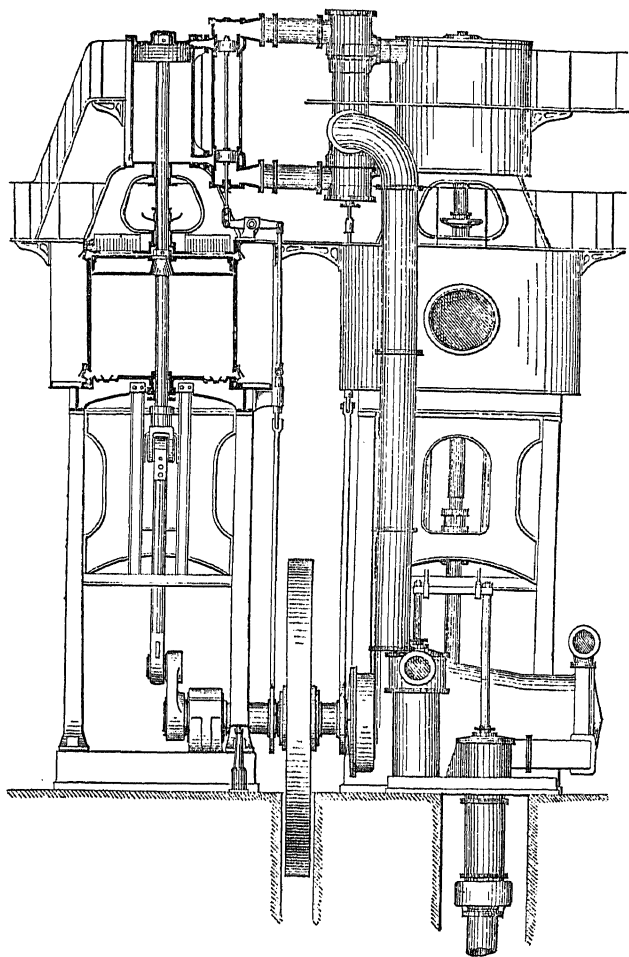

Fig. 25.—Vertical Direct-acting Blast Engine (Half Section).

a given weight of fuel burned in the furnace would give as good a result as if part were burned inside the furnace and part employed to heat the blast. The following are some of the more important reasons for the economy observed with hot blast:—

1. In the lower part of the blast furnace carbon is not fully oxidised to carbon dioxide (CO_2), but only carbon monoxide (CO) is produced. The combustion of carbon by air forced into the blast furnace, therefore, generates only 2,473 heat units, while when complete combustion takes place, as in heating the blast, carbon generates 8,080 heat units. The heat liberated by a unit of carbon burned in heating the blast is thus more than three times as great as that yielded by a unit of carbon burned in the blast furnace.

2. The use of hot blast naturally increases the temperature of combustion near the twyers, and this assists in the rapid melting of the slag and iron.

3. Owing to this increase of temperature the carbon is at once converted into carbon monoxide, and the heat of combustion is thus localised. In a furnace using cold blast a quantity of carbon dioxide is produced near the twyers, this is decomposed into monoxide higher in the furnace with the result that the reaction is completed further away from the twyers than with hot blast.

4. Owing to the more local combustion, and smaller quantity of air employed with hot blast, the upper part of the furnace is cooler, and the escaping gases carry off much less sensible heat.

5. Owing to the diminished consumption of fuel, due to the above causes, less ash has to be converted into slag, less flux is needed, and thus fuel is saved.

6. As less fuel is required with hot blast, less time is needed for its combustion. A furnace of given capacity contains more ore, and the yield of the furnace is largely increased.

Although the heat generated is greater when carbon is burned to CO_2 than when CO is obtained, the temperature is locally higher in the latter case. This is owing to the fact that CO_2 begins to dissociate into CO and O at about $1,200^\circ$ to $1,300^\circ \text{C}$., and hence CO can only be completely burned to CO_2 when the temperature of combustion does not much exceed $1,300^\circ \text{C}$. It is for this reason that the hot blast, by leading to the immediate formation of CO , yields a higher temperature in the hearth than would be possible if CO_2 were there produced.

The sensible heat brought into a blast furnace by the blast is generally about one-seventh of that required by the furnace, though the proportion will vary with the temperature and volume of blast. A useful table has been prepared by C. Cochrane,* giving the equivalent in cwts. of coke, of the heat brought in by the blast; in this table the weight of blast ranges from 55 cwts. to 145 cwts. per ton of iron produced, and the temperature from 10° to 800°C ., and it thus includes all variations met with in practice.

Limit to the Advantages of Hot Blast.—It is obvious that there is a theoretical limit to the temperature which can with

* *Inst. M. E.*, 1883, p. 124.

advantage be imparted to the air used in the blast furnace, for since a reducing agent is necessary to remove the oxygen of the ore, it is not possible to smelt iron with hot air alone, or with less than the quantity of carbon needed to remove the oxygen. If, therefore, the minimum quantity of carbon required for combination were ever reached, it would be useless to further increase the temperature of the blast. It must be remembered that there are difficulties in the way of heating air much above the temperature now attainable, and these difficulties are very great, if not unsurmountable. Owing to the dissociation of carbon dioxide at temperatures little above the melting point of steel, the combustion of carbon is incomplete, and its full calorific power cannot be obtained. At the same time the loss by radiation, and the wear of the heating apparatus, increase rapidly at high temperatures, so that it becomes more and more costly to raise the air through each succeeding increment of temperature. This question has been dealt with at considerable length by Sir L. Bell,* who shows that the saving of fuel on raising the blast from 1,000° F. to 1,700° F. was only 1 cwt. per ton of iron made, and concludes that it is not economical to raise the temperature beyond 1,700° F.

Sir L. Bell's conclusions would, however, need some revision in view of modern practice with good fire-brick stoves, as it does not appear that in actual working the economical limit has been yet often exceeded or even reached.

Methods of Heating the Blast.—The original patent, No. 5,701, granted to J. B. Neilson, of Glasgow, on 11th September 1828, for "improved application of air to produce heat in fires, forges, and furnaces where bellows or other blowing apparatus are required," reads as follows:—

"A blast or current of air must be produced by bellows or other blowing apparatus in the ordinary way, to which mode of producing the blast or current of air this patent is not intended to extend. The blast or current of air so produced is to be passed from the bellows or blowing apparatus into an air vessel or receptacle, made sufficiently strong to endure the blast, and through and from that vessel, by means of a tube, pipe, or aperture, into the fire, forge, or furnace. The air vessel or receptacle must be airtight or nearly so, except the apertures for the admission and emission of the air; and at the commencement and during the continuance of the blast, it must be kept heated artificially to a considerable temperature. It is better that the temperature be kept to a red heat or nearly so, but so high a temperature is not absolutely necessary to produce a beneficial effect. The air vessel or receptacle may be conveniently made of iron, but as the effect does not depend on the nature of the material, other metals or convenient materials may

* *Principles*, sects. 6 and 7. See also *Inst. Journ.*, 1893, vol. ii., p. 242.

be used; the size of the air vessel must depend upon the blast, and on the heat necessary to be produced. For an ordinary smith's fire or forge, an air vessel or receptacle capable of containing 1,200 cubic inches will be of proper dimensions; and for a cupola of the usual size for cast iron founders, an air vessel capable of containing 10,000 cubic inches will be of a proper size. For fires, forges, or furnaces upon a greater scale, such as blast furnaces for smelting iron, and large cast iron founder's cupolas, air vessels of proportionately increased dimensions and numbers are to be employed. The form or shape of the vessel or receptacle is immaterial to the effect, and may be adapted to the local circumstances or situation. The air vessel may generally be conveniently heated by a fire distinct from the fire to be effected by the blast or current of air, and generally it will be better that the air vessel and the fire by which it is heated should be enclosed in brickwork or masonry, through which the pipes or tubes connected with the air vessel should pass. The manner of applying the heat to the air vessel is, however, immaterial to the effect if it be kept at a proper temperature."

From the above specification, to which no drawings were attached, it will be observed that Neilson claimed no special form of apparatus, but merely the principle of employing heated air for combustion. How far he at the time correctly understood the facts underlying his invention is doubtful, but it is interesting to notice that even in his original specification Neilson mentioned the use of a red heat, and throughout his whole life he consistently advocated the use of the highest attainable blast temperature; the temperature obtained with the apparatus at first introduced was, however, far below redness.

The apparatus employed by Neilson in his first practical application of the hot blast early in 1829 at the Clyde Iron Works, Glasgow, is shown in Fig. 5, p. 21. It consisted of a small wrought-iron heating chamber, 4 feet long, 3 feet high, and 2 feet wide, which was set in brickwork with a grate below like a steam boiler. The cold blast entered immediately over the grate and passed out at the opposite end, being warmed in its passage to about 200° F. The blast entered the furnace by means of 3 twyers, each of which was provided with a similar heating box. This apparatus was only capable of warming the air, but the results obtained were such as to indicate the great advantages to be derived from the application of hot blast. The wrought-iron chamber thus employed not only had the disadvantage of exposing little heating surface to the blast, but it was soon burned out and required renewal. It was, therefore, replaced by a cylindrical cast-iron tube (A), set horizontally in a heating chamber (B) (see Fig. 26), and, as before, each twyer was provided with a separate heater. These horizontal pipes gave a higher temperature, but such an arrangement led to irregular heating, and to much trouble

with the expansion and the contraction of the pipes. Full details of Neilson's early forms of apparatus are given by H. Marten,* from whose paper the accompanying sketches are reproduced.

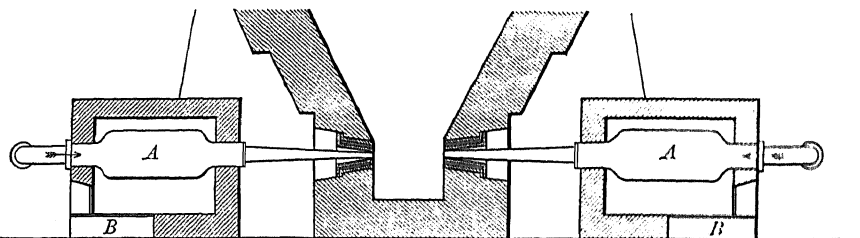

Fig. 26.—Neilson's cylindrical oven.

The first cast-iron tubular oven was erected at the Clyde Works in 1832, and is shown in Fig. 27. From this it will be seen that the blast furnace was supplied with 3 tuyers, to each of which was attached a stove, which consisted of a chamber of brickwork, heated by means of a fire grate placed underneath, and through which the air passed in a series of

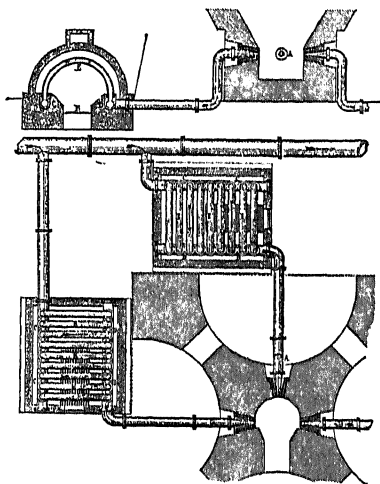

Fig. 27.—Original tubular oven.

circular cast-iron pipes, which were arched over the fireplace as shown in the sketch. Hot-blast stoves on this principle were soon adopted in all the chief iron-making districts, numerous modifications of detail being introduced from time to time. In order to diminish the difficulties due to expansion of the metal

* *Inst. M. E.*, 1859, p. 62.

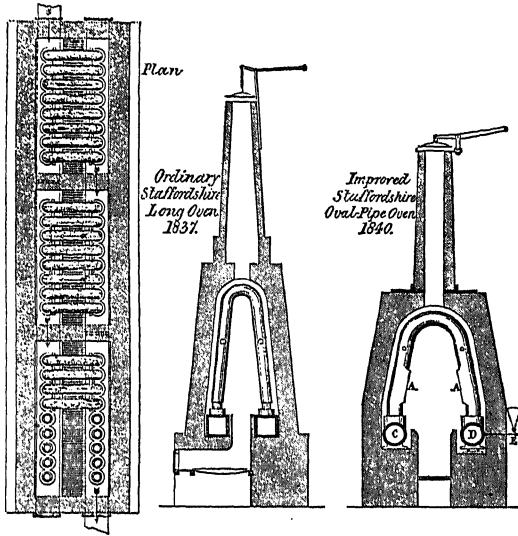

Fig. 28.

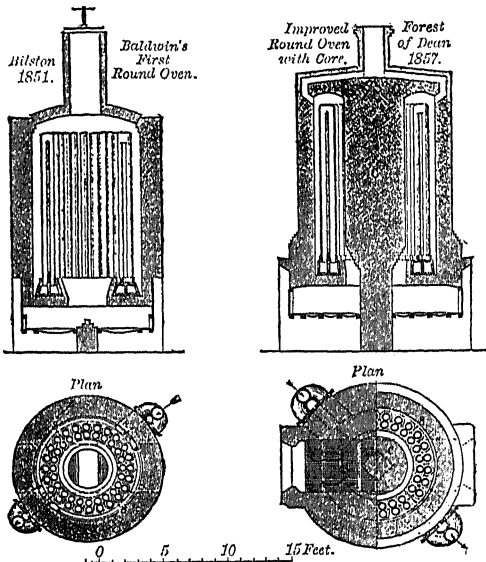

Fig. 29.—Round and long ovens.

a U or V shape was employed for the pipes, while to give greater heating surface they were cast with an elliptical section. The stoves were built larger so as to do away with the necessity of

a separate heating arrangement for each tuyer, while in order to obtain a higher temperature each stove was divided into several separate chambers, and the air caused to pass through these in succession (Fig. 28). To economise space in some cases circular ovens were constructed on similar principles; the first circular hot blast stove was erected by M. Baldwin in 1851 at Bilston in Staffordshire, and though the heat so obtained was not greater than in the rectangular form, the trouble due to leakage and fractures was much diminished (Fig. 29). A form of stove which also met with considerable favour was introduced by Mr. Baird at Gartsherrie, and known, from the peculiar shape of the heating pipes, as the "pistol pipe" stove: this is shown in Fig. 30, from which it will be seen that the pipes are divided by a partition which passes throughout the greater part of their length, and the air, instead of passing across the

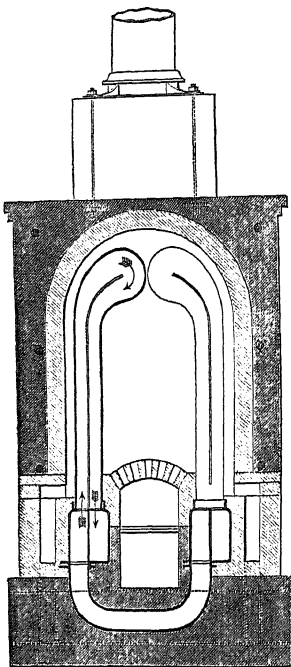

Fig. 30.—Pistol pipe stove.

stove, is made to travel up on the outside and down the inside of the same divided tube.

Gas-Fired Regenerative Stoves.—The early forms of hot-blast stove were all heated by the combustion of solid fuel, and although in 1833 Faber du Faur invented a hot-blast stove heated by the combustion of the waste gases from the blast furnace, and experiments in the same direction were conducted at Wednesbury in the following year, it was not until after Budd's patent of 1845 that this system of heating was successfully introduced. Direct-firing stoves held their own, side by side with gas-fired stoves, for a number of years, until the regenerative system invented by Siemens was applied to heating the blast, with the waste gases, by E. A. Cowper in 1860.

The Cowper Stove, which is shown in sectional elevation in Fig. 31, consists of an outer shell of plates of wrought iron or

mild steel, rivetted to form a cylindrical chamber some 60 feet high, 28 feet in diameter, and with a dome-shaped roof. This chamber is lined internally with fire-brick, a circular flue extends from the bottom to the top, while the rest of the chamber is filled with fire-bricks. The waste gases from the blast furnace enter the Cowper stove by the gas valve shown in the sketch; the air required for combustion enters at the air valve, and combustion takes place at A at the base of the internal gas flue. The hot products of combustion pass downwards through the regenerator of honeycomb brickwork to the exit valve, which is connected with the chimney. The mass of brickwork in the regenerator absorbs heat from the hot gases, and itself becomes red hot, in the upper portion particularly. When this has gone on sufficiently long to thoroughly heat the brickwork, the air, gas,

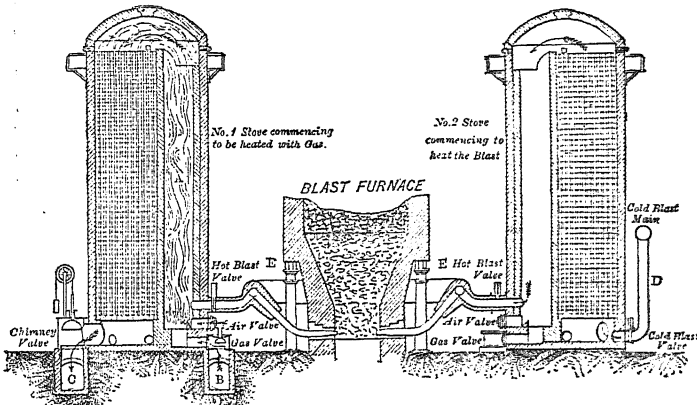

Fig. 31.—Cowper's hot-blast stoves.

and chimney valves are closed, and cold blast is admitted through the cold-blast main in the opposite direction, when it takes up heat from the brickwork, and is delivered to the furnace through the hot-blast valve. It is necessary to have two stoves for each blast furnace, so that one may absorb heat while the other is heating the blast, and it is advisable to also have a stove in reserve in case of accident.

In the original Cowper stove the bricks were arranged loosely, without any binding material, as in the Siemens' regenerator. Afterwards, about 1875, the bricks were arranged in rows, with every other brick projecting so as to form vertical channels. A history of the development of fire-brick stoves has been given by Lührman.*

The honeycomb brick employed for the regenerator of the

* *Inst. Journ.*, 1890, vol. ii., p. 754.

modern Cowper stove is illustrated in Fig. 32, and is designed, when the bricks are placed together, so as to form hexagonal gas passages, all of which have walls of Stourbridge fireclay, 2 inches in thickness. Each brick is 6 inches in height, and weighs about 32 lbs. In plan these bricks consist of a hexagonal air passage, the greater diameter of which is 7 inches, surrounded by a wall of fireclay 2 inches thick; at each of the six corners of this hexagonal wall, a short projecting wall 2 inches square

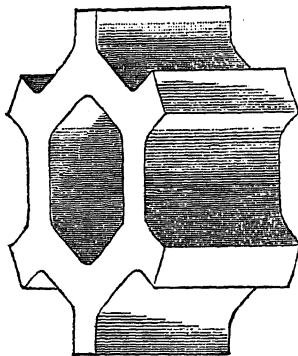

Fig. 32.—Honeycomb brick.

and 6 inches high is attached in the direction of the longer diameter, the whole forming one brick. The projections are so arranged that, on placing the bricks into position side by side in the stove, the whole of the interior is divided into upright hexagonal air passages, with a larger diameter of 7 inches, and with fireclay walls 2 inches thick. The bricks are made by pressing the clay into a column of the required shape by suitable machinery, and cutting off horizontal slices from this column each 6 inches high; these are dried and baked in kilns before use. The bricks were formerly pressed separately by hand, but this method has been replaced by that just described.

The combustion flue inside the Cowper stove is usually circular in cross section, but it is found that with this form the gases have a tendency to pass chiefly down the centre of the honeycomb bricks, this being the shorter path, and to leave the corners comparatively cool. In order to equalise the distribution of the gases, a \cap shaped combustion flue has been introduced as described by W. J. Hudson (*S. S. Inst.*, Nov., 1891, Discussion), with the result that the crescent-shaped corners in the filling of brickwork have been done away with, and a more uniform heating obtained. At Friedenshütte, in Upper Silesia, the same object is obtained by a modification due to Böcker, who, instead of giving a uniform cross section to the brickwork passages of the stoves, makes those in the centre, where the gases travel a shorter path, smaller than those at the sides through which the travel is longer; this is illustrated in *Inst. Journ.*, 1890, vol. ii., p. 516.

The hot-blast valve of a Cowper stove is shown in Fig. 33. The valve seat is of cast iron; a wrought-iron tube being cast in, and water circulated through the tube to protect the casting from over-heating. The valve itself is of steel, and has a sheet

of asbestos on each side, which is kept in place by a plate; this prevents the valve from burning at the high temperatures employed. The usual temperature obtained by Cowper stoves as employed for blast furnace purposes is 1,500° F. (815° C.), but a temperature of 2,000° F. can be attained if desired.*

As compared with pipe stoves the Cowper stove gives a much higher temperature, and has thus led to an increased yield of about 20 per cent. from similar furnaces; the fuel consumption is at the same time lessened; in some experiments conducted by Mr. Hawdon the quantity of gas required by a Cowper stove was only two-thirds of that of a pipe stove, while the temperature obtained was 1,500° as against 1,000° F. These advantages have been so fully proved that hundreds of Cowper stoves are now in use throughout the world, and a number of modifications of the regenerative fire-brick stove have also been introduced. The

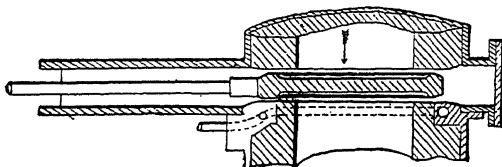

Fig. 33.—Hot-blast valve.

Cowper stove probably gives the highest temperature of any of these varieties, but it has the disadvantage of being somewhat easily clogged with dust, especially when smelting finely-divided or maganiferous ores. To minimise this difficulty dust catchers are often employed (see p. 102). But even under the most favourable conditions dust accumulates in the Cowper stove, and necessitates occasional cleaning. For this purpose C. Wood, of Middlesbrough, employs a small bronze cannon, which is charged with powder and run into the stove to be cleaned when the blast is turned off. The charge is fired from outside by means of a sliding hammer which strikes a percussion cap, and which is set in motion by blowing down a long india-rubber tube. The explosion thus caused displaces the dust, which is allowed to settle and is afterwards removed. Another method of cleaning such stoves, which is now in pretty general use, depends on the use of release valves, such as Lister's, which allow of the instantaneous discharge of the imprisoned air; in order to remove the dust the full blast pressure is turned into the stove, and then by the release valve this is allowed to pass instantaneously into the chimney. A cloud of dust is immediately discharged, and being shot up into the air is often visible for considerable distances. Cowper stoves are now not unfrequently raised on

* E. A. Cowper, *J. S. C. I.*, 1893, p. 311; also *S. Staff. Inst.*, Sept., 1884.

columns so as to allow men to stand underneath for cleaning with a scraper. This is done at casting time and when the stove has been on blast for some time, as the bottom is then comparatively cool.

The Whitwell Stove.—The first Whitwell stove was erected at the Thornaby Iron Works at Stockton-on-Tees in 1865. This

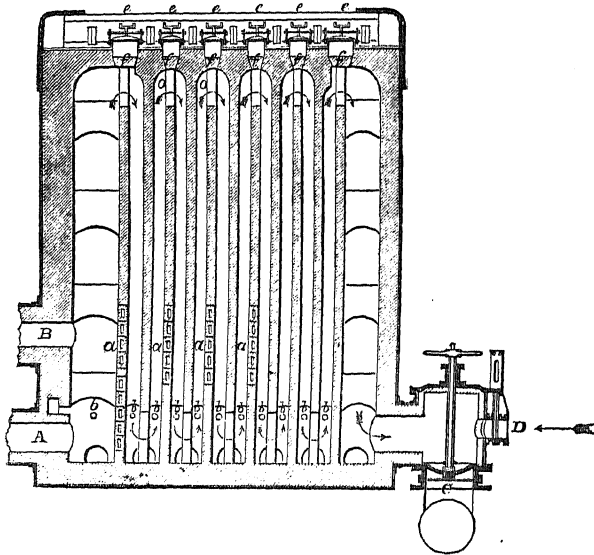

Fig. 34.

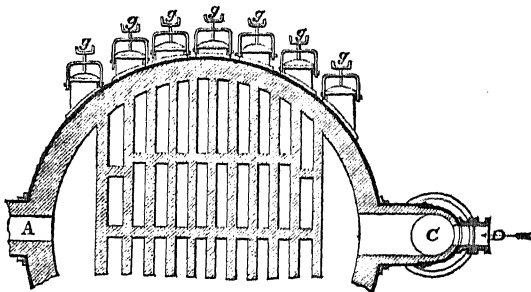

Fig. 35.—Whitwell stove.

stove is also a regenerative gas-fired stove, and like the Cowper is constructed of plates of iron rivetted together to form a cylinder, which in modern stoves is some 65 feet high and 25 feet in diameter,

with a dome-shaped top, and lined throughout with fire-brick. But the internal arrangement of the two stoves is quite different. Figs. 34 and 35 show

a vertical and horizontal section of a Whitwell stove, in the interior of which is a regenerator which consists of a series of vertical fire-brick passages made of 5-inch brick-work. The gas is admitted at A at the bottom of the combustion chamber, while air is introduced by feed passages (a), and the products of combustion pass to the chimney through the flue (C). The hot and partly burned gases pass repeatedly up and down through the brickwork passages, and after giving up their heat to the stove ultimately leave at a low temperature. Air is admitted by valves into the feed passages so as to complete the combustion as the gases pass through the stove, and in this the Whitwell principle differs from that adopted by Cowper. When the brickwork is thoroughly hot the gas is turned off, the cold blast enters the stove at D, takes up heat from the heated brickwork, and passes out at B on its way to the furnace.

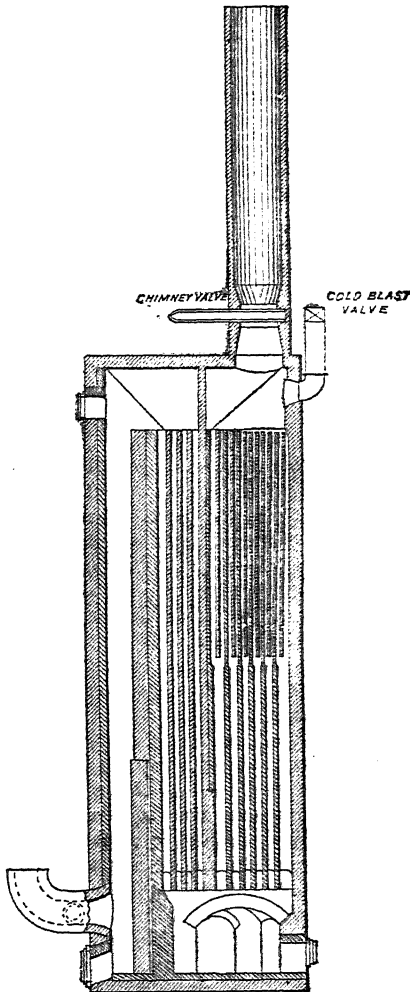

Fig. 36.—Gordon-Cowper-Whitwell stove.

The Whitwell stove not only offers less opportunity for the accumulation of dust, but also, on account of the shape, allows of more ready cleaning while at work, and is thus in

favour where the gases are more than usually dusty. The stove shown in Figs. 34 and 35 is of the original pattern introduced by Mr. Whitwell; it was 25 feet high and had a flat roof. The more recent forms are 60 to 70 feet in height, while an arched top, like that of the Cowper stove, is also adopted.

A number of modifications has been introduced in the construction of fire-brick stoves in America, one common plan being to make them quite independent of the draught of the stack by providing a separate chimney, with a valve, at the top of each stove. At the same time the arrangement of the regenerator has been modified in many ways.

In the *Gordon-Cowper-Whitwell* pattern, which is very popular in the Southern States, and which is shown in sectional elevation in Fig. 36, both the Whitwell and the Cowper systems are combined, while a separate chimney is provided as is usual in America. It is claimed that such stoves have the advantage that gases which contain a considerable proportion of dust may be employed, while as the latter part of the regenerative action is conducted by Cowper bricks, the gases are efficiently cooled, and a high temperature can be imparted to the blast.*

In the *Massick & Crookes Stove* the regenerator is on the Whitwell principle, but arranged in what is known as a "three pass" system; the main combustion tube is placed in the centre of the stove, and the gases after passing up the central tube pass once down and once up through gas passages similar in principle to those of the Whitwell stove, but arranged concentrically around the main combustion tube. The products of combustion pass out at the top of the stove by a separate chimney.†

The *Ford & Moncur Stove* was introduced in Cumberland a few years ago, and has since met with considerable favour.‡ This stove is on the fire-brick regenerative principle, with the usual external casing of iron plates lined with fire-brick. The modifications introduced are intended chiefly to facilitate cleaning: for this purpose bricks are employed, the upper edges of which are dormer shaped so as to prevent the dust lodging; the stove is also divided into four separate parts by vertical partitions, so that, when it is desired to clear out the dust, the blast is turned on to each section separately, and by proper release valves the air is allowed to suddenly escape and so carry away the dust, and it is claimed that the stove can thus be readily kept clean without any necessity for stoppages. Instantaneous release valves, invented by Lister, have also been pretty largely adopted for cleaning other varieties of hot blast stoves, and materially reduce the deposit which accumulates during the heating by gas. Hot-blast valves were formerly a source of much trouble, owing

* *Inst. Journ.* (Amer. vol.), p. 335.

† *Ibid.*, 1890, vol. ii., p. 340; also *ibid.*, Plate 24.

‡ *Ibid.*, 1890, vol. i., p. 391.

to the burning of the seat and consequent leakage. Westray and Copeland have overcome this difficulty by the use of cast-iron valves which have a pipe coiled round the seat; by circulating water through this pipe the seat is cooled and lasts much longer; at the same time arrangements are made for bolting on the seat, so that it can be readily changed when necessary (see p. 121 *ante*).

Temperature of the Blast.—The temperature of the blast is generally ascertained by the workmen by means of some simple test, though various pyrometers have been suggested, and to some extent applied, for this purpose. In Staffordshire, when a moderate temperature is employed, a bunch of dry twigs, or a besom, is held in the blast which should cause the wood to at once ignite; this corresponds to a temperature of about 350° C. For similar purposes a stick of lead is often employed. For higher temperatures supplied by modern stoves, a stick of zinc is used; this should melt at the edges in a few seconds when held in heated blast, and the time required for fusion affords an indication of the temperature. Such methods, though rough and incapable of giving quantitative results, are very useful in the hands of men who are accustomed to their use.

Among the more refined methods that have been used in practice, may be mentioned the *electric pyrometer* invented by Sir W. Siemens, which, though accurate at the temperature of hot blast, is not automatic in action, and the observations occupy a considerable time. The *Siemens' copper-ball pyrometer* has also been somewhat extensively used, and is easy to manipulate, but though fairly accurate for a few observations, is not suited for continuously recording high temperatures. An *air pyrometer* introduced by J. Wiborgh,* in which the air is kept at constant volume, has met with a good deal of favour in recent years, particularly in Sweden, and is capable of affording accurate indications for a lengthened period. In the *Frew pyrometer*, as applied for determining the temperature of the hot blast, a stream of air at constant pressure and temperature is passed through a tube placed in the hot-blast main; the air thus attains the temperature of the hot blast. The heating tube is comparatively long and of small diameter, and the resistance to the passage of the gas through the tube increases with the temperature. This increased resistance is rendered visible by means of a delicate pressure gauge, and as the apparatus works uninterruptedly for months at a time, it is possible to tell at any time, at a glance, the temperature of the blast.† The use of substances of known melting point provides a convenient indication of variations in temperature, especially since the laborious observations of the late Dr. Carnelly have given so large a list of salts of known melting point. It is thus possible to measure by the aid of a series of salts, most of which are easily obtainable,

* *Inst. Journ.*, 1888, vol. ii., p. 110.

† *Ibid.*, p. 125.

any temperature between 150° C. and 900° C., to within a very few degrees. A convenient table of melting points of various salts is given by Dr. Tilden.* Platinum pyrometers have been carefully studied by H. L. Callendar, who has given a convenient summary of his researches,† while Heycock and Neville have more recently published a valuable contribution to the same subject,‡ though such instruments are not at present adopted in the manufacture of iron and steel.

A special form of air pyrometer, which consists of a platinum vessel and tube, intended to be introduced into the hot blast main, has been drawn and described by H. Morton, *J. S. C. I.*, 1894, p. 869.

Thermo-electric couples have been applied for the determination of the temperature of the blast by Professor Roberts-Austen, who has devised a form of apparatus in which, by the aid of photography, an automatic record is obtained on a sheet of sensitised paper placed upon a rotating cylinder.§ His apparatus was first used at the Dowlais New Works, Cardiff, and it promises to realise E. P. Martin's expectation respecting it, that it will establish a new era in the management of iron and steel works,|| the thermo-electric couple being introduced into the horse-shoe blast main of a furnace by means of a tube and gland. The furnace was supplied with hot blast by three Cowper stoves, and the following illustrates a record of work:—The blast was at first supplied by No. 2 stove, which had an initial temperature of about 1,160° F.; at the end of an hour this had fallen to about 955° F. when connection was made with No. 3 stove. This had an initial temperature of 1,230° F., which fell in an hour and fifty minutes to 1,020° when the blast was introduced from No. 1 stove. The stoves were then worked in rotation during the period under observation, and during twenty-four hours the temperature never rose above 1,400° F., or fell below 950° F.¶

The upper record, Fig. 37, shows good and careful firing. The falling line, *x y*, indicates that the blast from a particular stove was let into the horse-shoe main (in which, as stated above, the thermo couple was placed) at an initial temperature of 1,400° F. The time marked on the base line shows that after an hour and a-half the temperature of the blast had fallen to 1,300° F., and the blast from another stove was then turned on at an initial temperature of 1,430°. The record proves that the stoves were charged regularly every hour and a-half; that the furnace had "taken the blast" well, and that the blast had not been interrupted for any purpose, such as changing a twyer. Everything, in fact, had been working satisfactorily.

* *Inorg. Chemistry*, p. 284.

† *Inst. Journ.*, 1892, vol. i., p. 164.

‡ *Trans. Chem. Soc.*, 1895, p. 160.

§ *Ibid.*, 1892, vol. ii., p. 33; see also *Introduction to the Study of Metallurgy, Pyrometry*. || *Ibid.*, p. 117. ¶ *Ibid.*, 1893, vol. i., p. 112.

The lower record, on the other hand, indicates that a very different set of conditions prevailed while it was taken. It is, however, not a continuous record, as it has been made up from a series of actual records obtained both in England and in Germany, and it proves that the recording pyrometer enables irregularities

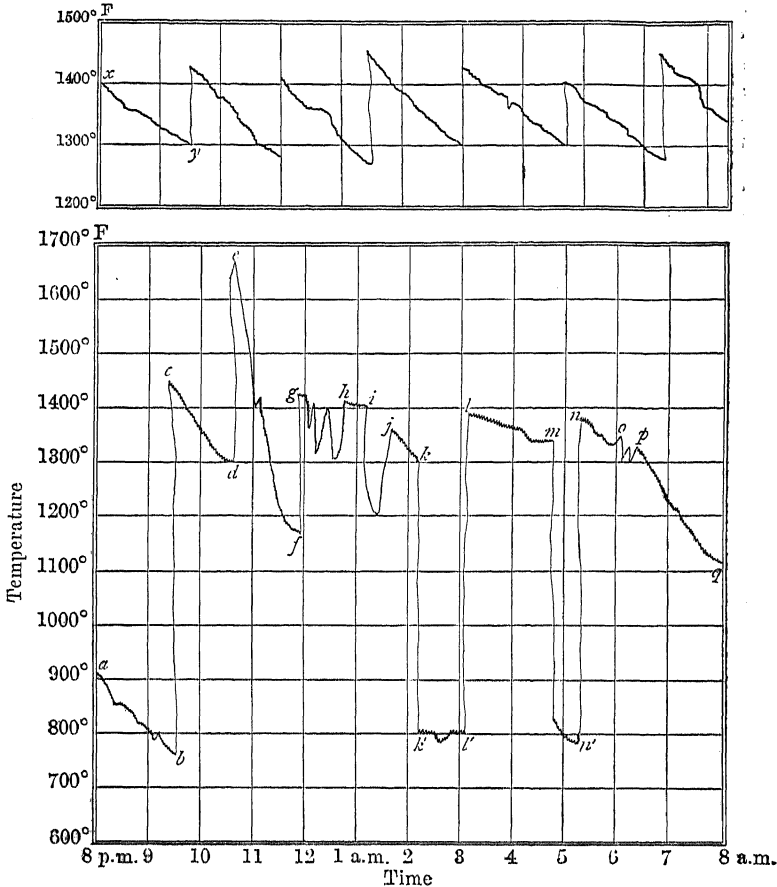

Fig. 37.—Automatic records of temperatures of hot-blast stoves.

of working to be at once detected. Of course all the mishaps recorded could hardly have happened during the time which this diagram represents.

It shows that while the line *a b* was being photographed, cold blast was mixed with the hot, as the furnace had been "sticking,"

and the line cd indicates that the use of hot blast had been resumed. The very high temperature noted at e was due to the firing of the blast in the horse-shoe main. When the blast was "taken off" in order to put the tapping hole in, the temperature fell very rapidly when normal working was resumed. The line gh represents the sort of curve obtained when the furnace has been "jumped"—that is, the furnace had been "sticking," and the blast was taken off and turned on suddenly several times in order to loosen the obstruction. The line ij is attributed to the fact that a twyer had been changed, and probably the blast was taken off for that purpose. The deep dip represented by the lines kk' , ll' , was the result of taking off the hot blast and substituting cold as the iron was becoming too "grey." The line lm shows no irregularity, but the furnace was producing very grey iron, and had not "taken the blast" well; the temperature of the blast (and consequently of the stove supplying it) had only fallen about 60° in an hour and a-half.

The line $m, n'n$ was obtained as the result of a furnace "breaking out," and a stoppage for repairs was necessary.

The line op has been a little exaggerated. It shows where the blast was taken off after tapping in order to "stopper the hole," and finally pq shows a rapid fall due to a "break out" of the furnace. The blast was taken off, and some hours elapsed before it was again turned on.

Twyers.—The high temperature which prevails in the hearth of the blast furnace, combined with the heat of the blast itself, leads to the rapid destruction of the ends of the pipes, or twyers, employed for delivering the blast into the furnace, unless these are efficiently protected. The usual method of protection is by means of water cooling. The twyers themselves are usually of wrought iron, though cast iron and bronze are also employed, the former on account of cheapness and readiness of production, and the latter because of their greater durability. Twyers may be classified according to the manner in which the water cooling is effected.

1. The first water twyer ever introduced was invented by a Mr. Condie in the west of Scotland shortly after the introduction of hot blast.* It is generally known as the *Scotch twyer*, and consists of a coiled wrought-iron tube which is embedded in a short hollow conical pipe of cast iron. The tube is first coiled in such a manner that both ends protrude from the base of a truncated cone, one on each side; the coil thus prepared is placed in a suitable mould and cast iron is poured round it so that the tube becomes imbedded in the cast iron. Twyers of this kind are in very general use, though not unfrequently the seating for the twyer is now formed of another similar coil, of larger diameter

* Percy, *Iron and Steel*, p. 428.

but shorter, as shown in Fig. 38, where the outer coil is used to preserve the wall of the furnace and so to diminish the loss of time due to changing twyers and similar repairs, while the longer and interior coil forms the twyer proper.* Nozzles of wrought iron are frequently employed for restricting the quantity of blast used, as when blowing in a furnace. The largest

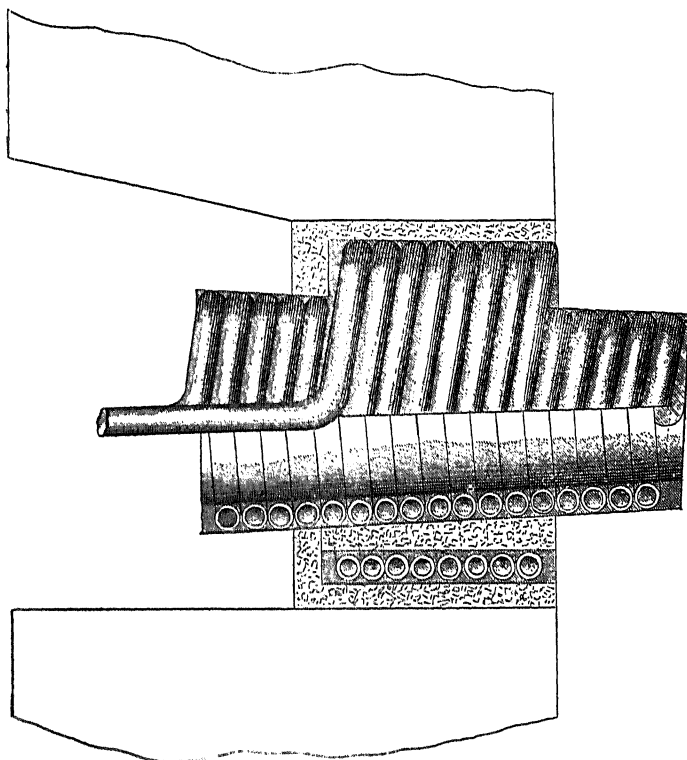

Fig. 38.—Scotch Twyer with outer coil.

twyer nozzles, used in America, are as much as $7\frac{1}{8}$ inches in diameter.†

2. The *Staffordshire twyer* was introduced shortly after that just described. It consists of two truncated cones of equal length but different diameter so arranged as to leave an annular space. This space is kept filled with water, and the twyer is thus cooled. The *Staffordshire twyer* was at one time in very general use, but

* H. Pilkington, *S. Staff. Inst.*, 1891.

† *Inst. Journ.* (Amer. vol.), p. 235.

is not now so much in favour. It is illustrated in Figs. 39 and 40.

3. The *open twyer* has been largely adopted since its introduction by F. H. Lloyd in 1876. It consists of two cones of wrought iron, one inside the other, and thus resembles the Staffordshire twyer; it is, however, cooled in a different manner, water being introduced in the form of a spray which cools the exposed parts of the twyer. The back of the twyer is open; it thus allows of ready inspection, and, owing to the greatly diminished danger of accidents due to unperceived leakages of water, has met with a very favourable reception. In a modification of the open twyer, introduced by T. W. Plum in 1877, the water is distributed by

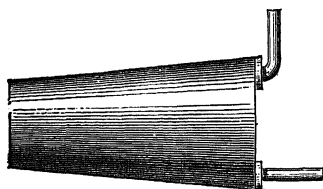

Fig. 39.—Staffordshire Twyer.

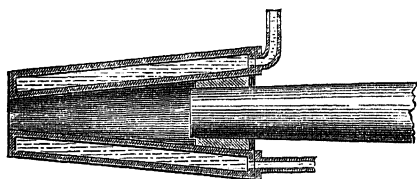

Fig. 40.—Staffordshire Twyer (Section).

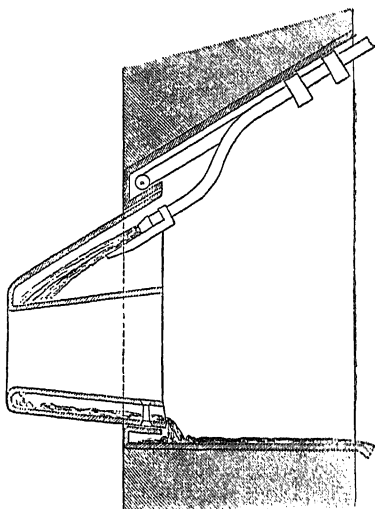

Fig. 41.—Water Cooled Open Twyer.

a spreader of sheet metal, instead of a spray; the object of this modification was to permit of the use of turbid water which would cause the small holes of the spray to become stopped up.* The ordinary water cooled open twyer is shown in Fig. 41, taken from a drawing by Dr. Wedding of the twyer at Hoerde.†

An American open twyer is illustrated in Fig. 42, taken from Mr. Pilkington's paper. This may be regarded as made up of two parts, both of which are separately cooled. The outer one is fixed in the furnace walls, and, as it is not exposed to any great heat, may be regarded as a seating for the inner portion. This is attached to the blast pipe; it is of smaller diameter, and

* *Inst. Journ.*, 1878, vol. i., p. 299.

† *Ibid.*, 1890, vol. ii., p. 515.

is arranged so as to be readily replaced when any repairs are needed. This part may be regarded as the twyer proper, and is separately cooled by water introduced by the pipe shown in the drawing.

Though twyers are usually inserted horizontally in the furnace, there is much difference of opinion as to the best practice in this respect. Sometimes a slight downward inclination is given, as this tends to prevent the bottom rising, and, as the hearth is filled with a more oxidising atmosphere, the pig iron is slightly refined while in the furnace. Other furnace managers,

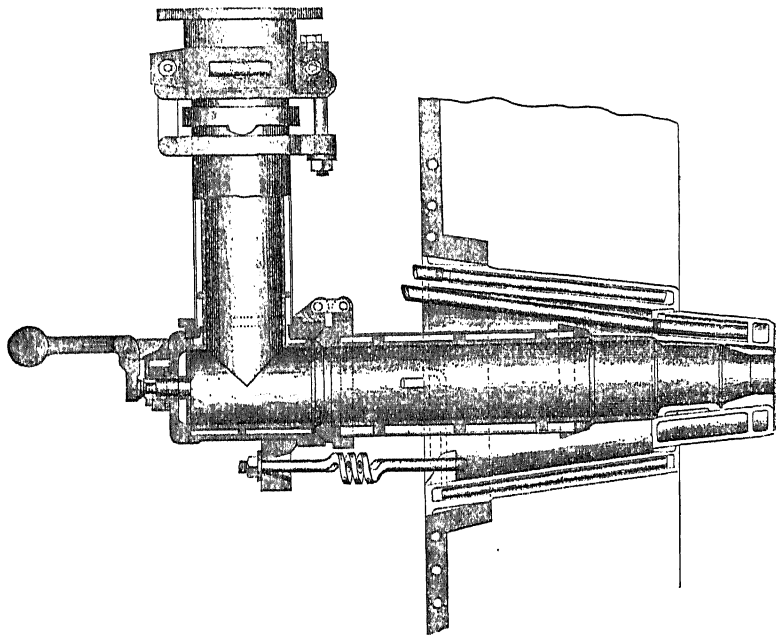

Fig. 42.—American Open Twyer.

however, prefer a slightly upward inclination to the twyers, believing that the furnace works better, and that a softer iron is obtained. Probably the proper inclination of the twyers will be regulated by a number of more or less complex conditions, and no definite rule can be made on the subject.

The cutting action on the sides of the furnace is greatest in the vicinity of, and just above, the twyers; in American practice, where this cutting action would otherwise be great on account of the high pressures employed, it is counteracted by the introduction of special water cooling blocks. The cutting action is also diminished by an increased "overhang" of the twyers—that is,

by allowing them to pass through the walls of the furnace and project some distance into the hearth. The overhang of the twyers has an important effect on the available capacity of the hearth, and hence on the production of the furnace, as the available melting space is not measured by the diameter of the hearth from side to side so much as by the distance which intervenes between the nozzles of the twyers. So that while increased overhang of the twyers diminishes the cutting action on the walls, it diminishes the melting capacity of the hearth. If, however, the blast pressure is insufficient for a furnace of a given diameter, increased overhang of the twyers may lead to greater regularity of working.

Effect of Moisture in the Blast.—The quantity of moisture present in the atmosphere varies from day to day, and, on account of the enormous scale on which iron is produced in modern iron works, this variation makes a marked difference in the quantity of water which is daily decomposed in the lower part of the furnace. The production of hydrogen and carbon monoxide by the action of water vapour on red-hot coke is accompanied by a considerable absorption of heat, and the consequence is that the temperature of the hearth is lower when much water vapour is present. In the days of cold blast practice it was noticed that the furnace always worked better in clear cold weather than when the air was warm and moist, the reason being that the heat absorbed by the decomposition of the water vapour in summer time more than compensated for the increased temperature of the atmosphere. In hot-blast practice the influence of moisture in the atmosphere is less marked, though, doubtless, this is one of the causes of the irregularities in blast furnace work which are often so difficult to explain. It was at one time held that in hot-blast practice the introduction of water vapour would be advantageous, as the hydrogen produced is so powerful a reducing agent. The question has, however, been considered at great length by Sir L. Bell, in his *Principles of the Manufacture of Iron and Steel*, and this eminent authority is of opinion that the part played by hydrogen in the reactions of the blast furnace is relatively unimportant, and that there is no advantage to be obtained by increasing the quantity of water vapour in the blast. The question has since been discussed by W. H. Fryer, who claims that desiccated blast would lead to increased production and diminished fuel consumption, and states that, if desired, the blast could be dried at a cost of 4½d. per ton of pig iron.*

* *Inst. Journ.*, 1891, vol. i., p. 360.

CHAPTER VIII.

REACTIONS OF THE BLAST FURNACE.

Materials Employed.—The weight of the materials required in the blast furnace for the smelting of iron is usually from seven to nine times the weight of the iron produced. Considerably more than half of this weight is atmospheric air required for the combustion of the coke or other solid fuel. Though upwards of 3 tons of solid matter are charged for every ton of iron made no solid products are obtained, all the materials passing off either in the form of gas at the top of the furnace, or as fluid metal or slag at the bottom. The following summary gives the approximate weight of the charge employed, and of the products obtained, during the smelting of 1 ton of No. 3 Ormesby (Cleveland) hot-blast pig iron :—

<i>Charge.</i>		<i>Products.</i>	
	<i>Cwts.</i>		<i>Cwts.</i>
Calced ironstone, . . .	48	Iron No. 3 grade, . . .	20
Limestone,	12	Slag,	30
Hard Durham coke, . . .	20	Waste gases,	130
Blast, heated in Cowper stoves,	100		
	9 tons.		9 tons.

The weight of ore required, or the "burden," will depend upon the richness of the materials, and is seldom less than 30 or more than 50 cwts. per ton of iron made. With rich ores the weight of limestone and of slag is proportionately reduced, and the fuel consumption is less. The fuel consumption also varies with the grade of the iron produced, being greatest with very grey and least with white iron. It follows, therefore, conversely that so long as other conditions remain the same increased burden tends to the production of white iron, and decreased burden to the production of very grey iron.

The materials introduced into the blast furnace form two currents passing in opposite directions. The first is gaseous and more rapid; it is introduced from below and passes away from the top; by taking up carbon from the fuel, oxygen from the ore, and carbon dioxide from the decomposition of the limestone, it increases considerably in weight and bulk during its passage through the furnace. It enters the hearth at the relatively high pressure of about 4 to 10 lbs. to the square

inch, and expanding into the upper parts of the furnace passes at a reduced speed and constantly lowering temperature and pressure through the column of descending material. The descending stream consists of solid materials which are charged into the upper part of the furnace when cold or nearly cold; their total weight is less than that of the ascending current, they move more slowly; but while their temperature rises and their weight diminishes their speed increases as they pass lower down the furnace until at length they become fluid in the hearth. In exceptional cases, with irregular working, pieces of iron ore may pass through the furnace without being reduced as in a case described by E. S. Cook,* which occurred at the Warwick furnaces in Pennsylvania; a similar instance with Marbella iron ore has been described by E. A. Cowper.† Sometimes also lumps of coke or lime are removed from the hearth; but these cases are quite abnormal, and, as a general rule, the whole of the products of the blast furnace are fluid. According to Grüner the average rate of descent of the solid materials charged into the blast furnace is about 20 inches per hour, while the gases pass upwards at the rate of some 20 inches per second, the relative speed of the two currents being therefore about as 1 to 3,600.

THE ASCENDING CURRENT IN THE BLAST FURNACE.

Combustion in the Hearth.—When air which has been previously strongly heated is forced into a blast furnace the carbon of the fuel burns with the oxygen of the air to produce carbon dioxide; this at the high temperature prevailing in the hearth is almost instantly dissociated, and the liberated oxygen combines with more carbon to produce carbon monoxide, thus:—

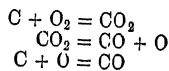

The result is that at a very short distance from the tuyers no free oxygen and no carbon dioxide is to be found in the ascending gases. This question has been recently reinvestigated by W. Van Floten, who collected samples of gas from a coke blast furnace working with about 800 cubic feet of air per minute, introduced at a temperature of 700° C., and a pressure of 5 lbs. to the square inch; the furnace was making about 900 tons of basic iron per week. The following analyses show the composition of the gases at different points in the hearth of the furnace, and prove that free oxygen is not found in the furnace gases more than 24 inches in front of the tuyers or 25 inches

* *Inst. Journ.*, 1889, vol. ii., p. 391.

† *Inst. M.E.*, 1883, p. 151.

above them; even in cases where a large excess of air is blown into the furnace no free oxygen or carbon dioxide exists a short distance from the twyers, and any waste of fuel is due to loss of carbon carried off in the gases in the form of carbon monoxide; the same remark applies to cold blast furnaces, though in this case the zone of combustion extends higher in the furnace:—*

Locality.	Percentage Composition.				
	O.	CO ₂ .	CO.	H.	N.
1. Middle of twyer eye,	13·0	6·0	0·0	0·75	80·5
2. Near edge of twyer eye,	0·0	13·5	6·0	0·25	80·25
3. 25 inches above No. 1,	0·0	11·0	11·75	2·00	75·25
4. Midway between twyers,	0·0	0·0	33·75	1·75	64·5
5. Close to wall of hearth,	0·0	0·0	45·25	2·00	52·75
6. Central point of hearth,	0·0	0·0	37·00	3·00	60·0

The gaseous current passing upward from the hearth into the boshes has approximately the following composition:—

Oxygen,	0 per cent.
Carbon dioxide,	0 "
Carbon monoxide,	34 "
Hydrogen,	2 "
Nitrogen,	64 "
	100
	100

Upper Zone of Reduction.—The gases of the blast furnace are thus rich in carbon monoxide, which is a powerful reducing agent, and which combines with the oxygen of the ore to produce carbon dioxide and metallic iron. This change may be most simply represented thus—

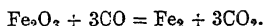

Reduction takes place in the upper part of the furnace, though the position of the reducing zone varies somewhat, according to the nature of the ore and fuel, the height of the furnace, and also as to whether lime or limestone is used as a flux. The reducing zone is lower in the furnace with easily reducible ores and charcoal than with refractory ores and coke (see p. 142).

The reduction of ferric oxide by carbon monoxide is exothermic—that is, it liberates heat, though the quantity of heat so evolved is not great. From the equation above given it follows that 112 parts of iron are reduced from ferric oxide by the oxidation of 84 parts of carbon monoxide. The reduction of 1

* *Stahl. u. Eisen*, 1893, vol. i.; *J.S.C.I.*, 1893, p. 928.

gramme of metallic iron from ferric oxide absorbs about 1,725 calories, while the oxidation of 1 gramme of carbon monoxide liberates 2,403 calories. The heat liberated is, therefore, $2,403 \times 84$, or 201,852 units, against an absorption of $1,725 \times 112$, or 193,200 units, leaving a balance of heat liberated over that absorbed of 8,652 units. That heat is evolved, owing to this equation, has been experimentally proved by Sir L. Bell (*Principles*, p. 76), who, after carefully noting the temperature of the gases issuing from a blast furnace working under normal conditions, replaced the burden of ore by a mixture of flint and blast-furnace slag, which was inert to carbon monoxide, though its specific heat was the same as that of the ore. This change led to a diminution of 200° F. in the sensible heat of the issuing gases.

It is thus evident that in the blast furnace there are two centres of heat generation; one in the hearth, due to combination of oxygen and carbon, the other in the upper part of the furnace. The latter is due to a reaction which takes place at a temperature below redness, and is of considerable importance, though the amount of heat liberated is relatively small.

With these two exceptions, all the reactions of the blast furnace, such as the decomposition of limestone, formation of slags, reduction of silicon, phosphorus, &c., and carbon impregnation, are endothermic, or lead to the absorption of heat.*

The two chief centres at which change of composition of the upward gaseous current occurs are thus at the bottom, where carbon burns, and near the top where oxygen is absorbed. There are, however, other important changes taking place in the interval of the passage of the gas through the furnace. It is observed, for instance, that if a common red brick, such as is used for building purposes, and which contains ferric oxide, is heated for a lengthened period in a reducing atmosphere rich in carbon monoxide, the ferric oxide is not merely reduced to metallic iron, but around each particle of iron a deposit of carbon is formed, and this is deposited in such quantity as to lead to the complete disintegration of the brick.† This result is due to an action by which carbon monoxide is decomposed when heated in contact with spongy iron, and carbon and carbon dioxide are produced—

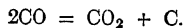

A precisely similar action takes place in the blast furnace, commencing as soon as reduction is completed, and continuing until fusion commences. The result is that the ore, which was originally charged in the form of lumps, becomes all split up and

* For fuller details the student may read the chapter on Thermo-Chemistry in Roberts-Austen's *Introduction to Metallurgy*, 3rd ed.

† *Inst. Journ.*, 1891, vol. ii., p. 74.

disintegrated into a black powder before the coke burns or the slag melts. At the same time a small but gradually-increasing proportion of carbon dioxide is found in the gases from the boshes upwards. Just below the zone of reduction a further considerable increase in the proportion of carbon dioxide takes place, owing to the decomposition of the limestone forming part of the charge, according to the equation—



Other Reactions of Carbon Monoxide.—The action of carbon monoxide on metallic iron varies in a remarkable manner according to the conditions, particularly as regards temperature. When the gas is allowed to remain in contact with finely-divided iron at low temperatures, ferro-carbonyls corresponding to the formulæ $\text{Fe}(\text{CO})_5$ and $\text{F}_2(\text{CO})_7$ are slowly produced, as shown by L. Mond.* The former of these is a liquid boiling at 103°C . and solidifying at -21°C .; it is decomposed when heated to 180°C . with the deposition of a bright mirror of metallic iron. Ferro-carbonyl has been found in carbonic oxide which had been compressed in an iron cylinder; it is believed by Roscoe to be the cause of the red deposit sometimes found when coal gas burns in steatite burners, and has been found by Thorne in gas compressed in cylinders for use with the limelight. It has been suggested by Berthelot† and by Garnier‡ that the carbonyls may play an important part in the reduction of iron in the blast furnace, and account for certain cases in the metallurgy of iron in which the metal volatilises. Mond, however, does not believe that in the blast furnace the temperature is ever low enough to permit of the formation of a body like ferro-pentacarbonyl which decomposes at 180°C .

When carbon monoxide is passed over metallic iron at a temperature of 400°C . the gas is decomposed, and carbon is deposited, while oxide of iron and carbon dioxide are produced. The relative quantity of oxide of iron and carbon dioxide which is produced depends chiefly upon the temperature employed; at low temperatures ferrous oxide is chiefly obtained, but as the temperature rises, since carbon decomposes ferrous oxide more readily at high temperatures, the products of the decomposition of carbon monoxide are carbon and carbon dioxide, very little oxide of iron being obtained. It is probable that at the high temperatures which prevail in the blast furnace the latter is the chief reaction which occurs.

The presence of carbon dioxide in the lower part of the blast furnace, where little or no reduction takes place, may also be in part due to a reaction described by Berthelot,§ who states that

* *Journ. Chem. Soc.*, 1891, pp. 604, 1090.

† *Compt. Rend.*, vol. cxii., p. 1343.

‡ *Ibid.*, vol. cxiii., p. 189. § *Ibid.*, vol. cxii., p. 594.

when pure dry carbon monoxide is heated in glass tubes to about 550° C. a small quantity of carbon dioxide is produced without any separation of carbon, and suggests that an action such as may be represented by the following equation takes place :—

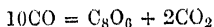

Leading to the formation of a sub-oxide of carbon and carbon dioxide. Should the correctness of this observation be confirmed it would doubtless be of importance in the reactions of the blast furnace.

The reactions of carbon monoxide in the blast furnace afford interesting examples of the influence of physical conditions in determining the nature of chemical action. Thus the reduction of the ore by the furnace gases is distinctly an example of what is known as the influence of mass, since with a certain definite proportion of carbon dioxide, equal to about one-half of the monoxide present, no reduction takes place; with still more carbon dioxide the gases become actually oxidising. The particular change which occurs is thus dependent not merely on the nature of the gases themselves, but also on their relative quantities. It has been further experimentally proved by Sir Lowthian Bell that the rates of carbon deposition in the lower part of the furnace, and of reduction in the upper portions, are alike increased or diminished as the speed with which the carbon monoxide passes through the furnace is greater or less, and this observation affords another example of the influence of mass. On the other hand, temperature plays a most important part in connection with the reactions of blast furnace gases, since, as is elsewhere shown, one fundamental reason for the advantage in the use of hot blast is due to the dissociation of carbon dioxide at high temperatures. This dissociation also prevents carbon monoxide from completing the reduction of any oxides which may have passed through the zone of gaseous reduction into the lower parts of the furnace, which are at a temperature at which carbon monoxide and oxygen have little tendency to unite. The rate of carbon deposition too is much influenced by temperature, as deposition commences at about 420° F., and gradually increases until a temperature just below visible redness is reached; on further raising the temperature the action becomes gradually less marked, and at or above a bright red heat is scarcely appreciable. The action of carbon monoxide both in reduction and in carbon deposition is also largely influenced by the density, size, and other characteristics of the ores employed. The chemical reactions of carbon monoxide are thus modified by physical conditions, such as the mass, temperature, or texture of the materials used.

Lower Zone of Reduction.—Since finely-divided iron is

partially oxidised when heated with carbon monoxide, as already explained, it follows that it is not possible by means of carbon monoxide alone to completely deoxidise an iron ore. It has been observed by Ebelmen, see p. 142, that in the lower part of the blast furnace ferrous oxide exists side by side with metallic iron, and this is what would be expected from the known reactions between ferric oxide, iron, and carbon monoxide. The silica and other non-metallic oxides present are not reduced by carbon monoxide but only by solid carbon, and this reduction is also effected just before the charge melts. It follows, therefore, that as there are two zones in which heat is developed, the chief being near the tuyers where carbon burns to monoxide, and the other at the top of the furnace where ferric oxide is reduced by the gases, so there are also two zones of reduction, the more important being in the upper part of the furnace where the iron is reduced by carbon monoxide, and the other near the tuyers where ferrous oxide, silica, and phosphorous pentoxide are reduced by solid carbon.

By the decomposition of carbon monoxide in the furnace both oxygen and carbon are added to the charge in the solid form, and pass down the furnace until at length they combine together and are evolved as gas; it thus follows that in the lower part of the furnace the proportion of oxygen and carbon, in chemical combination in the gases, is greater than that calculated from the weight of blast and fuel used. This is illustrated in the following figures given by Sir L. Bell for a furnace 80 feet high; the numbers representing cwts. of oxygen and carbon calculated per ton of iron made:—*

Depth in feet.	Escape pipe.	11½	17¾	24	30	36	42	49	74
Oxygen,	36·48	32·86	32·53	29·88	28·76	23·52	24·29	25·20	32·55
Carbon,	21·49	20·56	20·86	19·62	19·50	17·64	18·22	18·43	23·29

The calculated quantity, in this instance, from the weight of fuel, blast, and flux employed was 23·47 cwts. of oxygen per ton of iron; this agrees closely with what was found at a depth of 36 feet, while there was an excess of both carbon and oxygen at lower depths. From these figures it appears that in passing through the lower 38 feet of the furnace, from a depth of 36 feet to 74 feet, some 5½ cwts. of carbon and 9 cwts. of oxygen were added to the gases, or about 14½ cwts. out of the total 56 cwts. given off at the furnace top.

Hydrogen in the Blast Furnace.—The reducing effect of hydrogen has been held by some authorities to be of great import-

* *Inst. Journ.*, 1887, vol. ii., p. 82.

ance in blast furnace work; the question has, however, been considered at great length by Sir L. Bell, in a special chapter of his *Principles of the Manufacture of Iron and Steel*, who shows that the part played by hydrogen in the reduction of iron is relatively unimportant; while from thermo-chemical principles it follows that no advantage would be gained by the use either of hydrogen itself, or of water vapour or other substances of a similar character which, by decomposition in the furnace, would yield hydrogen. Space does not allow of the subject being treated in detail here.

DESCENDING CURRENT IN THE BLAST FURNACE.

When the iron ore is charged into the furnace it at first suffers no chemical alteration, but gradually absorbs heat until, when in a coke furnace, it has passed a few feet below the surface, and its temperature is raised to about 200° C., it begins to slowly lose oxygen, which combines with carbon monoxide to form dioxide, and in so doing, as before explained, liberates heat. At first reduction is very slow, but as the materials descend their temperature gradually rises, and at about 600° C. reduction is rapidly accomplished. At this temperature, also, limestone begins to decompose, thus:—

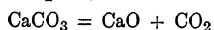

producing quicklime and liberating carbon dioxide, part of which takes up carbon from the fuel, producing carbon monoxide at a point where it can take little or no part in the reduction. To this waste of fuel the term "carbon transfer" has been applied.

By the decomposition of carbon monoxide with metallic iron carbon is deposited, as previously explained, and this action commences almost as soon as reduction itself. When the charge has passed through not more than about 30 feet it has thus been deoxidised, and consists of lumps of ore which have been converted into spongy iron; these, if exposed to the air, would be pyrophoric, and contain the gangue. Side by side with these lumps are pieces of coke and quicklime. The whole now passes down the furnace some 40 feet suffering little chemical alteration, except such as is due to decomposition of carbon monoxide, and the influence of the relatively small quantity of alkaline cyanides which are always present. At length a temperature is reached which is sufficient for the formation of slags by the combination of silica with lime and other bases. At the same time more or less phosphorus, silicon, &c., are reduced by solid carbon, and become combined with the iron. The charge then melts, and running down into the hearth, collects below the level of the twyers in two layers, the lower one being metal,

and the upper one slag, the density of the latter being less than half that of the former.

Cyanides in the Blast Furnace.—Much importance has at various times been attached to the reducing action of cyanides in the blast furnace, since Desfosses, in 1826, showed that cyanides are produced when nitrogen is passed over red-hot charcoal, and Bunsen and Playfair, in 1845, found cyanogen in the gases from a furnace at Alfreton. The latter experimenters, who withdrew considerable quantities of potassium cyanide from the furnace, calculated that each cwt. of coal yielded nearly 1 lb. of this salt, and believed it to exert an important part in the reduction of the ore. Dr. Percy, however, from these figures, calculated that the cyanides could not have reduced more than about 3 per cent. of the iron made in this furnace,* and other investigators have generally confirmed the view that the part played by cyanides is relatively small.† It may be pointed out that, in the blast furnace, all the conditions necessary for the formation of cyanides are present, as the ash of the fuel and the ores themselves supply the necessary alkali. W. Hempel has recently shown, by means of a porcelain tube, surrounded by a strong air-tight steel cylinder, and heated internally with the electric current, that cyanides are formed more readily as the pressure increases, and that the cyanides of the alkalies are more readily formed than those of the alkaline earths.‡ These facts may help to explain the observation that cyanides are formed chiefly in the lower part of the furnace, and that, though much lime is present, the cyanogen combines in preference with the relatively small quantity of potash.

Professor Roberts-Austen attaches more importance to the action of cyanides than some other writers on this subject, and states that in the lowest region of the blast furnace the reduction of the residual oxide of iron is accomplished chiefly through the agency of the cyanides formed near the twyers, the cyanide itself becoming changed to cyanate. This is probably decomposed with the formation of nitrogen and an alkaline carbonate. The alkaline salts condense in the upper part of the furnace, and are again brought down to the level of the twyers as the materials descend. Consequently, each particle of alkali metal does duty over and over again, the alkalies introduced in small quantities in the fuel accumulating in the furnace to a very large extent. As much as 4 cwts. of alkali metal and 2 cwts. of cyanogen per ton of iron have been found in the gases near the level of the twyers, and this concentration of alkali explains the fact that furnaces reduce more readily after they have been some time in blast.§

* *Iron and Steel*, p. 451.

† Compare Sir L. Bell, *Inst. Journ.*, 1871, p. 81.

‡ *Ber.*, vol. xxiii., p. 3388.

§ *Metallurgy*, p. 195.

Reduction in Charcoal Furnaces.—The changes during the descent of the solid materials in a charcoal furnace are, however, very different in character from those above described. In some experiments by Ebelmen with charcoal furnaces, the materials to be examined were placed in an apparatus of strong sheet iron, constructed so as to be permeable to the furnace gases; the apparatus was attached to a chain and was allowed to descend with the charge into a furnace to a determined depth and was then withdrawn, and the materials examined; the following table shows in a convenient form the results obtained:—

	La Chapelle (Pisolitic) Ore.			Laissey (Oolitic) Ore.		
	Fe ₂ O ₃ .	FeO.	Fe.	Fe ₂ O ₃ .	FeO.	Fe.
Original ore,	59·6	36·2
Time. Depth. Temperature.						
2 hours, 8 feet, Black Hot, .	63·4	3·2	...	37·0	trace	...
4½ ,, 14½ ,, Dull Red, .	33·0	32·5	...	27·8	12·7	...
5½ ,, 16½ ,, Cherry Red, .	26·0	41·8	trace	24·1	17·5	...
6½ ,, 18½ ,, Wrought Ironsoftens,	...	35·0	26·7	...	30·2	10·0

The total height of the furnace was 35½ feet, and the depth of the boshes 18½ feet; both ores employed were easily reducible. It will be observed that at first the proportion of ferric oxide actually increased owing to the expulsion of water, and that reduction had scarcely commenced when the materials had passed one-fourth of the distance down the furnace. Even at the boshes reduction was incomplete, and the ore appears to pass through the stages of magnetic oxide and ferrous oxide before metallic iron is produced.* By similar methods with a charcoal furnace using roasted spathic ore, Tunner found the first signs of reduction at a depth of about 25 feet at a temperature of about 850° C. which was attained when the materials had been in the furnace about two hours; at another furnace the same observer found reduction to commence at 840° C. at a depth of 31 feet when the materials had been in the furnace six hours.† It will be seen, therefore, that in a coke furnace reduction takes place chiefly while the charge is descending through the first quarter of the height of the blast furnace, and that this reduction leads to the direct production of metallic iron by the action of carbon monoxide at a low temperature; in a charcoal furnace, on the other hand, reduction is accomplished chiefly in the middle of the furnace, it takes place at a relatively high temperature, and ferrous oxide is produced as an intermediate stage in the reduction.

* Percy, *Iron and Steel*, p. 457.

† *Ibid.*, p. 456.

Temperatures of the Blast Furnace.—The maximum temperature in the blast furnace is in the hearth immediately in front of the twyers; the position of this point of maximum varies, however, according to the temperature of the air used, it being further removed from the twyers with cold blast. The temperature of the zone of fusion, just above the hearth, is determined largely by the fusibility of the slag, and that of the upper part of a furnace of given capacity, chiefly by the temperature of the blast and the nature of the fuel. In coke furnaces the use of hot blast cools the upper part of the furnace, and increased capacity acts in a similar manner, though this cooling can only be carried to a certain extent as there is a liberation of heat, due to the action of carbon monoxide on ferric oxide, which leads to the production of a certain minimum temperature in the upper part of the furnace, so long as the ore and fuel are the same, whatever is the height of the furnace or temperature of the blast. With charcoal furnaces, where the zone of reduction is lower, the materials in the upper part of the furnace are cooler, so that while the temperature of the escaping gases from a coke furnace is usually over 200° C., that of the gases from a charcoal furnace, despite its smaller capacity, is, according to the determination of Ebelmen, about 100° C., and sometimes even so low as 50°. Ebelmen determined temperatures below the mouth of a charcoal furnace by lowering into the furnace an iron rod, at the end of which was a small crucible containing pieces of various metals, and showed that at 26 feet 4½ inches down the furnace, or 2 feet above the boshes, though silver melted, it was not sufficiently hot to melt copper; at the twyer, wrought iron melted almost instantaneously. In a coke furnace the same observer found the temperature at the mouth about 300° with a heavy charge, and 400° with a lighter charge, while at the top of the boshes copper melted, and white pig iron softened. By a somewhat similar method Tunner also determined the temperature of a charcoal furnace at Eisenerz, Styria, with the following results:—

Depth in feet,	0	7	11	15	17	21	24	25½	29	34
Temperature,	320°	340°	550°	640°	680°	840°	910°	950°	1150°	1450°

These temperatures would doubtless require modification in view of modern determination of the melting point of copper, which does not exceed 1,080° C. Relatively to each other, however, the values determined by Tunner are probably trustworthy.

It will be seen from these figures that the temperature increased very uniformly from the mouth to the twyers. The temperature of the issuing gases was higher than observed by Ebelmen, but in this case calcined ore was employed, and with raw ore the temperature at the mouth is lower.*

* Percy, *Iron and Steel*, p. 453.

According to Sir L. Bell,* the reduction of ferric oxide by carbon monoxide may be considered to commence at about 200° C., while the reduction of ferric oxide by solid carbon commences at about 400° C. It is evident, therefore, that in ordinary working in large furnaces, as the materials are gradually heated as they pass down the furnace, the ore will be almost completely reduced by carbon monoxide before it reaches the temperature at which solid carbon can begin to act. The action of carbon dioxide on metallic iron, which would lead to oxidation of the iron sponge, does not commence till the temperature reaches about 425° C., and when this temperature is reached the charge is in an atmosphere which contains relatively little carbon dioxide. The action of carbon dioxide on hard coke, leading to the production of carbon monoxide, commences at about 815° C., or at a full red heat. It must, however, be remembered that some ores are more easily reduced than others, and that charcoal and other soft fuels are more readily attacked by carbon dioxide than coke.

The impregnation of the reduced ore with carbon by the reduction of carbon monoxide commences almost immediately after the reduction of the oxide of iron, and the temperature most favourable for carbon deposition is about 400° or 450° C.† There does not, however, appear necessarily to be any connection between the rate of carbon deposition and that of reduction.

According to H. Le Chatelier,‡ the highest temperature attained in front of the tuyers of a blast furnace is about 1,930° C., while the first part of the tappings from a blast furnace making grey Bessemer iron had a temperature of 1,400°, and the last and hottest portion of the same tappings had a temperature of 1,570° C. According to the same authority, Swedish white cast iron melts at 1,135° C., and grey cast iron at 1,220° C.

The temperature of the waste gases from a modern coke blast furnace under normal conditions varies from about 150° to 270° C. (300° to 700° F.), being lower after the introduction of fresh ore. The greatest variations are caused by irregularity in filling, due to stoppages at meal times, or for other purposes, and subsequent rapid charging to make good the deficiency. Regularity of charging leads to better working, and to diminished fuel consumption.§

Descent of the Charge in the Blast Furnace.—The materials which are charged into a blast furnace do not descend in distinct strata in the order in which they are charged, or like a piston in a cylinder, but they form a kind of vortex or funnel, much as sand does in an hour glass. According to the method

* *Principles*, p. 71.

† *Ibid.*, p. 189.

‡ *Compt. Rend.*, vol. cxiv., p. 470; *J. S. C. I.*, vol. xi., p. 607.

§ C. Bell, *Cleveland Engineers*, 1892.

of charging, the larger lumps tend to accumulate in the centre, at the circumference, or at some intermediate position, the last being the preferable position. Whenever the coarse particles thus accumulate, the ascending gases pass more readily, as the interstitial space is greater; and if a marked separation of coarse and fine materials occur, as when the lumps are at the middle or the circumference, the finer ore is imperfectly reduced, and thus clots, and leads to irregular working. The distribution of the materials is affected by the shape and size of the furnace, as shown by F. Brabant,* but to a still greater extent by the diameter of the mouth, and by the diameter and the angle of the charging cone.

The descent of the charge in the blast furnace has been studied by Sir L. Bell by the aid of a wooden model with a glass front,† and more recently Richards and Lodge have adopted the same principle, but have recorded their observations in a very interesting series of photographs.‡ A wooden-scale model, 40 inches in height, was constructed of the Edgar Thomson furnace, D. 1885; the model was provided with a plate-glass front, and the space between the glass front and the wooden back was $1\frac{1}{2}$ inches. The materials were charged into the top of the model by hand, with the aid of a small scoop, and were withdrawn from a small bin at the bottom in which they collected. Four separate mixtures were employed, differing in the proportion of coarse and fine particles, while the size of the cone in one series of experiments was double that employed in the other series. In each case the charge was withdrawn from below and charged in above until a definite distribution of the materials was obtained, when a photograph was taken to preserve a record of the result. These photographs, of which Figs. 43a and 43b are examples, show that a bell of relatively large diameter always gives three columns of material in the model, the inner being coarse, and the two outer fine. In actual practice this would correspond to a column of coarse material in the centre, with an annular ring of fine outside (Fig. 43a). A bell of small diameter gives a charge which is in five columns in the model, the centre and the two outside columns being coarse, and the intermediate ones fine (Fig. 43b).

Furnaces without a bell, but in which the top is of smaller diameter than the stock line, give a fairly uniform distribution of materials. Furnaces fed with a central funnel have a column of fine in the centre, which is surrounded by an annular ring of coarse material.

In order to indicate the relative rapidity of the descent of different portions of the charge, a layer of charcoal was intro-

* *Inst. Journ.*, 1887, vol. ii., p. 283.

† *Principles*, p. 124.

‡ *Amer. Inst. Mining Engin.*, July, 1887.

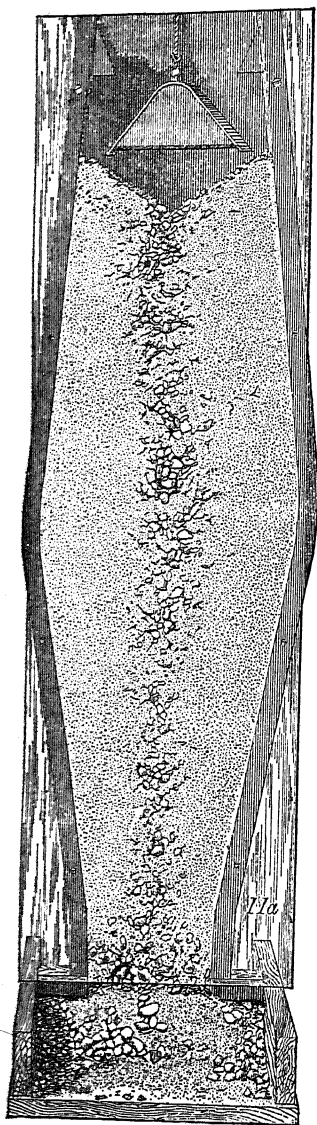

Fig. 43a.

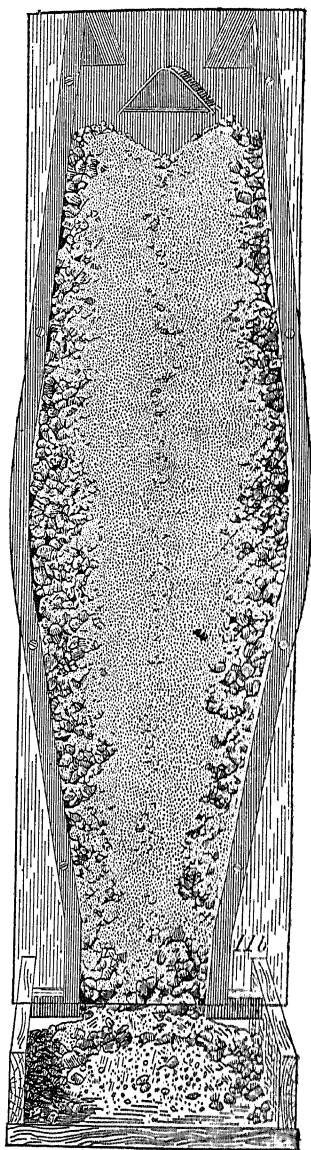

Fig. 43b.

Model illustrating the influence of the size of cone on descent of charge.

duced, and its position was marked after the removal of each scoopful of material from the bottom of the model. It was thus shown that lumps descend more rapidly than finer particles, and that, particularly in the lower part of the furnace, the central portion moves more rapidly than the sides. In a model of this kind, however, it is not possible to accurately represent what takes place in the lower part of the furnace, where the materials first begin to soften and afterwards to melt. It is observed in practice that if the diameter of the bell be too small in proportion to that of the throat of the furnace, the coarse material collects chiefly at the outside, as above stated, the result being irregular working and much wear of the furnace lining. An account of such a case has been given by E. C. Pechin,* who states that the distance between the edge of the bell and the wall of the furnace should not exceed $\frac{1}{2}$ feet, as this gives the proper distribution of the materials.

Scaffolds.—When the materials in the blast furnace stick to the sides instead of descending regularly they lead to the production of what is known as a “scaffold.” Ordinary scaffolds may be detected by the fact that the charge descends less rapidly on the side on which the scaffold occurs; annular scaffolds are more difficult to detect as they extend over the whole of the furnace. Scaffolding is almost invariably accompanied by irregularities in the composition of the waste gases, by black slags, and by close-grained iron, circumstances which are due to imperfect reduction of the ore. Usually when the materials underneath the scaffold are removed by the working of the furnace the obstruction becomes detached and a “slip” occurs. This leads to imperfectly reduced ore passing through the furnace, and to the occurrence of ferrous oxide in the slag.

Scaffolds are caused by irregularities in the furnace charge, by weak fuel and small ore, by improper fluxing, by irregular charging, and by unsuitable furnace lines. They are also more common when blast of a relatively high temperature is used and are seldom met with in furnaces working with cold blast. Generally, a scaffold is followed by a slip, and with a little attention the furnace once more resumes its normal working. In some cases special methods have to be adopted, such as the removal of the solid materials in the hearth, the introduction of a gas blowpipe to melt the obstruction, or the use of crowbars to dislodge it; occasionally a “skull” or “ring” scaffold may lead to the complete stoppage of the furnace, or to the destruction of its sides by the magnitude of the slip. T. Whitwell mentions among the methods employed to dislodge a skull scaffold, “jerk ing” the furnace by suddenly taking off all the blast, and then rapidly turning it on again; the use of petroleum introduced above the tuyer by which intense heat is developed and the

* *Inst. Journ.*, 1888, vol. ii., p. 235.

materials melted; and cutting through the plating and masonry of the furnace some 15 feet above the existing twyers, or at such place as the obstruction is believed to exist, and introducing twyers at that point.*

The question of the formation of scaffolds has recently been dealt with at considerable length by W. Van Floten, who states that scaffolding generally originates when the general working of the furnace is good, while with a furnace which is working badly the charge is usually sufficiently open to allow of the free passage of air. Scaffolding usually commences when bad coke, soft wet ore, or a very hot blast is employed. Narrow furnaces with nearly vertical walls, and furnaces with very wide hearths are particularly liable to this trouble. Scaffolds are also produced by very heavy tapping, which leads to the formation of a large cavity in the hearth. Incipient scaffolding is indicated by a clear transparent flame at the top of the furnace, while with irregular working this flame becomes white or smoky. As a rule, also, the charge is noticed to sink more slowly when scaffolding begins; this may be followed by an absolute stoppage, which may be remedied by stopping the blast for a short time; while there is a third and worst stage of scaffolding in which stoppage of the blast has no effect. Scaffolds are generally produced in the lower part of the furnace, not above the top of the boshes, and consist largely of carbonaceous matter, part of which is in a state of fine division. Hence the use of cold blast is often very efficacious in removing such accumulations as the distribution of heat in the furnace is changed and more carbon is burned.†

It has also been pointed out by W. Van Floten‡ that, as before stated, the descent of the charge cannot be assumed to take place uniformly over the whole section of the furnace, especially in the zone of fusion. When the burden approaches the twyers it is already melted, and takes up but little space; the hearth is, therefore, almost entirely filled with coke, which can only be removed by oxidation. The coke is unchanged, except in the spaces immediately in front of the twyers, and these form but a small proportion of the whole area of the furnace. The charge must, therefore, descend in as many small funnels as there are twyers, the motion being most rapid at the bottom.

According to this writer, "scaffolds" are formed separately for each twyer, and do not extend over the whole of the furnace, though when scaffolds are formed over all the twyers they may combine to form an arch, which is the worst kind of scaffold met with in the blast furnace.

Reduction of Phosphorus.—The phosphorus in the furnace

* *Inst. Journ.*, 1878, vol. i., p. 202.

† *Stahl. u. Eisen*, 1892; *J. S. C. I.*, 1893, p. 927.

‡ *Inst. C. E.*, vol. cxii., p. 438.

charge is usually present in the form of calcium phosphate; it is, therefore, not affected by carbon monoxide, but is reduced by solid carbon in the lower parts of the blast furnace. It is necessary at the same time that silica should be present in order to combine with the lime, since calcium phosphate is not reduced by carbon alone. Hence although phosphorus pentoxide alone would be reduced by solid carbon at a much lower temperature, the phosphorus in the ore is not reduced until that point is reached where slags are formed and melted, and where the lime is removed. In ordinary cases practically the whole of the phosphorus present in the ore passes into the pig iron, and only a trace is met with in the slag. To this there are, however, two exceptions. In the first place, if the slag be rich in ferrous oxide, as in the "scouring" slag, which often accompanies white iron, a certain portion of the phosphorus passes into the slag, though in the blast furnace it is not practicable in this way to produce a pure iron from impure ores, as the waste of iron in the slag and the wear of the furnace lining are great in proportion to the phosphorus removed. Secondly, it has been shown by N. Kjellberg* that when the ore contains 3 per cent. of phosphorus, if the charge be very basic, as much as half of the phosphorus may pass into the slag. Ores used in practice seldom contain 1 per cent. of phosphorus, and it then passes into the iron whether the slag is acid or basic; but as the phosphorus in the charge increases an increasing proportion passes into the slag, especially when the slag is basic. No phosphorus is lost by volatilisation in the blast furnace. Cinder pig, which is made from tap cinder, as first suggested by B. Gibbons of Corbyn's Hall New Furnaces, near Dudley, soon after the introduction of hot blast, sometimes contains over 5 per cent. of phosphorus, and with exceptional mixtures as much as 7 per cent. of phosphorus may be present in pig iron.

Reduction of Silicon.—The silicon existing in the oxidised condition in the furnace charge, as silica or silicates, is not attacked by carbon monoxide, or by carbon alone, and is only reduced with difficulty by carbon in the presence of certain metals at the highest furnace temperatures. It follows, therefore, that silicon is reduced just before the charge melts, and that carbon monoxide is evolved by the reaction. Usually not more than one-twentieth part of the silicon in the charge is reduced, the rest passing into the slag. The reduction of silicon is favoured by high temperatures, and hot-blast pig iron is, therefore, usually more siliceous than that made with cold blast, but this tendency can be, to a considerable extent, counteracted by the use of more lime in the charge. A siliceous burden also favours the production of pig iron rich in silicon. For certain purposes iron containing upwards of 18 per cent. of silicon or "silicon pig" is now regularly produced in the blast furnace. Though special

* *Dingler's Journ.*, 1893, vol. cclxxxvii., p. 207.

fluxes, such as fluorspar, are recommended, the author is informed by T. E. Holgate, who has had large experience in this direction, that high silicon pig can be made without any such additions, but that very hot working, a large fuel consumption, and a siliceous charge are the chief essentials.

Reduction of Manganese.—All cast iron contains manganese in greater or less proportion, which is obtained from the oxides of manganese originally present in the ore. It is, however, not possible, in ordinary blast-furnace working, to reduce the whole of the manganese present in the charge, and the proportional loss of manganese is greater when the percentage originally present is small. The manganese which is not reduced passes into the slag, chiefly in the form of manganous oxide (MnO), which is basic; hence the loss of manganese is less when a basic slag—*i.e.*, one rich in lime—is employed, and when the temperature of working is high. Basic slags have a high melting point, and thus involve high temperatures, with the accompanying tendency to low sulphur, and also, when there is little manganese, to the formation of graphitic carbon. According to C. H. Ridsdale,* the following table gives the minimum proportion of manganese which passes into the slag, when the furnace is working well, with different proportions of manganese in the metal:—

Mn per cent. in pig iron.	Minimum Mn per cent. in slag.
Up to 5	1
5 „ 10	1½
10 „ 15	2
15 „ 20	2½
20 „ 25	3
25 „ 30	3½
50 „ 70	4
70 „ 85	4½

To produce spiegel-eisen, which usually contains from 5 to 25 per cent. of manganese, the manganese ores are mixed so that if three-quarters of the manganese in the charge is reduced, and a quarter passes into the slag, the necessary composition will be obtained; to prepare ferro-manganese, which contains up to 86 per cent. of manganese, a richer mixture must be employed, of which about four-fifths of the manganese is reduced, and only one-fifth passes into the slag.

Reduction of Sulphur.—Usually not more than one-twentieth of the sulphur present in the charge passes into the iron, the remainder being found, chiefly as calcium sulphide, in the slag. The conditions affecting the absorption of sulphur have been considered at length by the author in a paper on “Silicon and Sulphur in Cast Iron,”† in which the previous work on this

* *Notes on Iron and Steel Manufacture*, p. 43.

† *Inst. Journ.*, 1888, vol. i., p. 28.

subject is summarised, and much experimental evidence adduced in support of the following conclusions:—

1. That a high temperature prevents the absorption of sulphur by iron.

2. That a basic slag readily combines with sulphur.

3. That the amount of sulphur actually retained in the iron on cooling is influenced by the proportion of silicon, manganese (and possibly other elements) present in the metal, these elements tending to exclude sulphur.

In connection with the last of these conclusions it may be observed that the author found that, though under special conditions, it was possible to produce mixtures which contained considerable proportions (*e.g.*, 10 per cent.) of silicon and sulphur together, these elements tended to separate on keeping the iron fluid for a time. A lighter portion which floated to the top contained most of the sulphur, while the larger and heavier part below retained most of the silicon. The author concluded that for every proportion of silicon there is a certain proportion of sulphur which cannot be exceeded in cast iron under normal conditions; and if by any means an excess of either element be introduced, this tends to separate on remelting the mass and keeping it for a time at rest. Similar experiments by Hilgenstock have confirmed the above observations.* In a curve representing the maximum sulphur with a given percentage of silicon,† the author showed that silicon did not under ordinary circumstances reduce the sulphur below about 0.2 per cent., so that the addition of silicon would not afford a means of desulphurising iron for steel-making purposes. The failure to observe this fact has led to some adverse criticisms on the author's conclusions.

Sulphur and Manganese.—The desulphurising effect of manganese is much more marked than that of silicon, and it is generally observed that with metal which contains from 1 to 2 per cent. of manganese, the sulphur is low, even though there may be very little silicon, and the iron consequently white. In ordinary grey iron, such as that used for Bessemer purposes, which contains from 2 to 3 per cent. of silicon, the sulphur is almost invariably low: but with white iron, such as is used for the basic process, the silicon is low, and sulphur would, therefore, be present in relatively large quantity if manganese were not added to the charge in sufficient quantity to give some 1.5 per cent. in the metal.

By a process introduced by J. Massonez,‡ cast iron is desulphurised after it is tapped out of the furnace by keeping it in bulk, in a large ladle or "mixer," in the fluid state, and adding

* *J. S. C. I.*, 1894, p. 1064.

† *Inst. Journ.*, 1888, vol. i., p. 40.

‡ *Ibid.*, 1891, vol. ii., p. 76.

a quantity of iron containing the requisite quantity of manganese. It is then allowed to stand at rest for a time, when the manganese and sulphur combine, and float to the surface as MnS .* The desulphurised iron, which contains at least 1 per cent. of manganese, is then taken to the steel works, or otherwise used. This process, which has now been in regular use for some years, affords a very efficient means of desulphurisation, and is claimed to be more economical than the use of manganese ores in the blast furnace. The manganese-sulphur slag may be returned to the blast furnace, where the greater part of the sulphur is eliminated, and the manganese recovered. The plant employed in this method of desulphurisation is shown in Fig. 44, from which it will be seen that the fluid iron is brought to the mixer

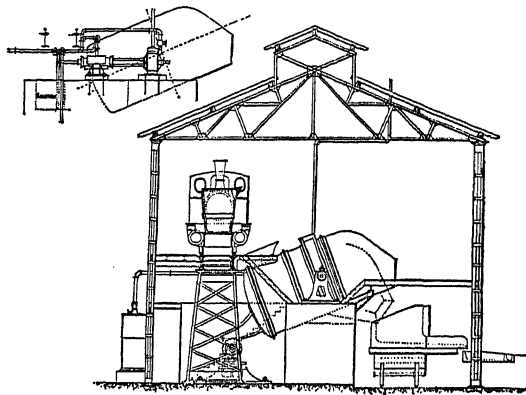

Fig. 44.—Metal mixer and desulphuriser.

in a ladle by means of a locomotive, and is afterwards tapped out as required with another similar ladle on a lower level. Irons too rich in manganese may, if required, be treated with iron pyrites (FeS_2), which will remove the manganese without any injurious effect so long as the elimination is not allowed to proceed too far. The reactions which take place between manganese and sulphur in pig iron have been treated at length by T. E. Holgate, who has had special experience with rich manganese alloys.† Other methods of desulphurising, which are not connected with blast-furnace reactions, will be afterwards considered.

Composition of the Waste Gases.—The gases which issue from a blast furnace consist essentially of carbon monoxide, carbon dioxide, and nitrogen, with smaller and variable quantities of marsh gas, hydrogen, and ammonia. The proportion of these

* *Inst. Journ.*, 1891, vol. ii., p. 248.

† *S. Staff. Inst.*, 1892; see also *J. S. C. I.*, 1894, p. 1063.

constituents depends chiefly on the fuel which is employed, though in part also upon the perfection with which the process of reduction is being conducted from time to time.

Generally speaking, the gases from furnaces employing raw coal are, as might be anticipated, richer in hydrogen and hydrocarbons; in coke furnaces, the volume of carbon monoxide is somewhat greater than double that of the carbon dioxide; while in charcoal furnaces, the greatest proportion of carbon dioxide occurs. It is generally found that the most economical working is accompanied by a high proportion of carbon dioxide; the reasons for this are discussed in the section dealing with fuel consumption.

The following analyses may be regarded as fairly typical of the volume of the various constituents in the gases from the three kinds of fuel generally employed, though in actual practice considerable variations occur:—

	FUEL USED.		
	Coke.	Charcoal.	Bituminous Coal.
Carbon monoxide (CO).	25	19·5	28·0
Carbon dioxide (CO ₂), .	12	12·5	8·6
Nitrogen,	59	63·5	53·5
Hydrogen,	2	2·5	5·5
Marsh gas,	2	2	4·4

The gases from bituminous coal would contain from 0·1 to 0·15 per cent. of ammonia, which would also be present, though in much smaller quantities, in the gases from other fuel. A collection of analyses of gases from various furnaces will be found in Percy, *Iron and Steel*, p. 430; while numerous analyses will also be found in Bell's *Principles*.

The composition of the waste gases affords considerable insight into the regularity and economy with which the blast furnace is working: and for this reason analyses of these gases are regularly performed in many important iron works. The calculation of these results sometimes leads to intricate problems which have been discussed at length by Sir L. Bell in his *Principles of the Manufacture of Iron and Steel*, and by J. E. Stead,* and W. Hawdon,† where detailed information can be obtained.

Utilisation of Blast Furnace Gases.—The chief application of the waste gases in modern iron works is for heating the hot-blast stoves which are almost universally of the firebrick regenerative type and heated by gas. Next in order of importance

* *Inst. M. E.*, 1883, p. 138.

† *Inst. Journ.*, 1883, vol. i., p. 101.

come the boilers necessary for raising steam for the blast engines and other purposes, and usually the gases collected are sufficient in quantity to heat both stoves and boilers, and to leave a surplus. The waste gas is brought to the boilers by means of a large overhead pipe, with branches to each of the boilers which are usually set in a row. It is best to arrange for combustion to take place in a space surrounded by firebrick, as this, when thoroughly heated, allows of perfect combustion which is not possible if the burning gases impinge directly on the relatively cold metals of the boilers. The hot brickwork also greatly diminishes the possibility of an explosion due to the accidental admixture of air with the gas drawn from the furnace. Drawings of suitable burners for various kinds of boilers have been given by H. Pilkington.* Where there is an excess of gas over that required for stoves and boilers, as is particularly the case where raw coal is used, this may be utilised either for roasting the ore in suitable kilns, as is practised in Sweden and America (see p. 82), or for general heating purposes, as at the Carron Iron Works in Scotland, where a large foundry is attached to the blast furnace plant, and the blast furnace gases are distributed in pipes and used for drying the moulds in the foundry, and many similar purposes. In this instance the blast furnaces act as gas producers, and would still be needed for this purpose even if they did not produce any metal. Modern practice has thus proved the correctness of the statement made in 1848 by J. B. Budd, the first successful worker in this direction in the United Kingdom, that "it would appear to be more profitable to employ a blast furnace, if as a gas generator only, even if you smelted nothing in it, and carried off its heated vapours by flues to your boilers and stoves, than to employ a separate fire to each boiler and each stove."†

Recovery of Tar and Ammonia from Blast Furnace Gases.—When fuel, such as coke or charcoal, which has been subjected to previous destructive distillation is employed in the blast furnace the proportion of ammonia in the gases is so small that it does not pay to extract. But where raw coal is used, as in the West of Scotland and in North Staffordshire, the 1.35 per cent. of nitrogen which is present in the fuel is equivalent to about 150 lbs. of commercial sulphate of ammonia per ton of coal, of which rather less than one-fifth is given off as ammonia and can be recovered, while the rest leads to the production of cyanides or passes away as nitrogen in the gases. The processes employed for the extraction of ammonia may be classified as follows:—

I. Those depending on the cooling and scrubbing of the gases.

(a) The *Alexander and M'Cosh process*, which is adopted at Gartsherrie and other Scotch iron works, involves the use of

* *S. S. Inst.*, Nov., 1891.

† *B. A. Report*, 1848.

an atmospheric cooler of iron tubes, similar to that employed in ordinary gas works, which cools the gases from about 350° to 120° F.; it is then passed through water condensers, consisting of tiers of tubes, in the inside of which water is circulated, and is thus cooled to about 65° F., when about 30 gallons of ammoniacal liquor are condensed per ton of coal. The gas then passes through two "scrubbers" where it is brought into intimate contact with, and thoroughly washed by, water so as to condense the tar, and recover the rest of the ammonia. The ammoniacal liquor is afterwards distilled, with as much lime as is required to liberate the ammonia, which is passed into sulphuric acid and converted into ammonium sulphate.

(b) The *Dempster process* is adopted at the works of R. Heath & Son near Stoke-upon-Trent. The gases are passed into iron vessels containing water in four compartments with a water seal; they thus pass four times under water and deposit much tar and dust. They are then cooled in an atmospheric cooler of iron pipes, washed with Livesay washers which contain plates perforated with small holes so as to split up the gas into small currents and condense the tar, and finally with scrubbers. The ammonia is afterwards converted into sulphate, and the tar rectified.

(c) The *Henderson process* is similar in principle to those previously described, though each differs in details of working.

II. Methods depending on the use of acids.

(a) The *Neilson process*, conducted at Summerlee, involves the washing of the gas in a scrubber so as to reduce its temperature from about 500° to 140° F. This removes much of the tar and also the alkaline dust which would contaminate the ammonia salts. The gases then pass into a lead lined scrubber where they are washed with dilute sulphuric acid, which when very nearly neutralised by the ammonia is evaporated and crystallised.

(b) The *Addie process*, carried out at Langloan, depends upon the addition of sulphur dioxide to the furnace gases in sufficient quantity to combine with the free ammonia to form ammonium sulphite. The sulphur dioxide is obtained by burning coal "brasses" or pyrites "smalls" in retorts, care being taken to avoid any excess of free oxygen. The blast furnace gases are first mixed with sulphur dioxide in quantity sufficient to give a slightly acid reaction; they are then scrubbed, and their temperature reduced to 150° F.; by a second scrubbing the temperature is further reduced to about 140° F., and practically the whole of the ammonium sulphite removed. The liquor is then mixed with milk of lime and distilled.*

The composition of the tar recovered from blast furnace gases varies according to whether the gases have been thoroughly

* W. Jones, *Inst. Journ.*, 1885, vol. ii., p. 410; Sir L. Bell, *ibid.*, 1892, vol. ii., p. 15.

cooled, as by the Gartscherrie and similar processes, or only partially cooled as when acid is employed. Gartscherrie tar has been examined very completely by Watson Smith,* who states that its density is 0.954; it contains about 24 per cent. of phenols, and is a transition tar, being intermediate between the paraffinoid tars obtained by distilling shale at a low temperature, and the benzenoid tars obtained when coal is strongly heated in making coal gas. The tar from the acid processes is heavier than water, having a density of about 1.08; it contains less oil and more pitch than that previously described. These tars have been applied on a considerable scale for oil gas making, while the phenols they contain are separated and used for the production of "carbolates" for disinfecting purposes. The amount of ammonium sulphate collected from the iron works of the United Kingdom in 1890 was about 5,000 tons, and the production appears to be fairly stationary at that figure.†

* *Inst. Journ.*, 1887, vol. ii., p. 97.

† *Ibid.*, 1891, vol. ii., p. 245.

CHAPTER IX.

ON THE FUEL USED IN THE BLAST FURNACE.

Blast Furnace Coke.—The coke used for the smelting of iron ores in the blast furnace is of special quality, and in this country is still generally made in the bee-hive oven. The Coppee coke oven is also used, in which case the coal in the form of fine slack is washed, to free it from pyrites and earthy matter before coking. In Germany numerous varieties of ovens of various designs are employed, and generally tar and ammonia are extracted from the evolved gases. Numerous trials of similar ovens have been made in the United Kingdom, but it has generally been held that the value of the products recovered from the waste gases did not compensate for the slightly inferior quality of the coke produced.

Good blast furnace coke is hard and compact; it should be clean to the hands, sonorous, and should possess a dark silver grey lustre; it should also be free from moisture, and from volatile hydrocarbons. Coke which is not sufficiently hard or strong crumbles to powder under the weight of the superincumbent materials in the furnace, and thus interferes with the free passage of the blast. Soft and porous coke is also more readily attacked by carbon dioxide in the upper parts of the furnace; this leads to the production of a quantity of carbon monoxide, above the zone of reduction, and to a corresponding waste of fuel. In exceptional cases, however, it is observed that porous coke, where other conditions are favourable for its use, works very economically in the blast furnace, and its action then appears to resemble that of charcoal.

Good coke contains about 90 per cent. of carbon, and as little ash and sulphur as possible. Any ash which is present is not merely a source of loss, owing to its own incombustible nature, but it increases the weight of slag, and of the flux, and consequently the number of heat units required per ton of pig iron produced. There is usually not more than a trace of phosphorus in good furnace coke, and the presence of this element is to be avoided, as any phosphorus contained in the coke would be reduced and pass into the pig iron. The presence of much sulphur in coke leads either to the production of a sulphury pig, or to the use of more limestone, and consequently of more fuel, in the furnace. Coke of good quality generally contains from 0.5 to 1.0 per cent. of sulphur, and from 6 to 9 per cent. of ash.

Gas coke, which is sometimes used in mixture with other fuel for the production of cheap iron, is soft and friable, it has a dull grey or black colour, and usually contains some 1·5 to 2 per cent. of sulphur, and upwards of 10 per cent. of ash. The hard coke made in bee-hive ovens in Durham, and employed in the Cleveland district, is unsurpassed for blast furnace purposes, while the coke produced in South Wales is also of very excellent quality.

The coke used in the blast furnaces of the United States is almost exclusively made in bee-hive ovens of the old-fashioned type, and is generally somewhat richer in ash, and often also in sulphur, than that used for similar purposes in the United Kingdom. The following analyses of representative varieties are by Simmersbach :—*

	Connelsville.	Pocahontas.	Chattanooga.	Birmingham.
Carbon,	89·58	92·58	80·51	87·30
Volatile constituents,	·46	·49	1·10	·80
Water,	·03	·20	·45	·16
Ash,	9·11	6·05	16·34	10·54
Sulphur,	·81	·68	1·59	1·20

In a paper dealing with the physical properties of blast-furnace coke, M. P. Rossignaux † observes that when coke began to be substituted for charcoal in the blast furnace, a light, porous coke was necessary, as the furnaces were low, of small capacity, and driven with cold blast. In such furnaces hard coke would descend to the twyer level almost unchanged. In modern practice, however, coke must be hard and compact, to resist the weight of the heavy furnace charge. The crushing strength of coke depends on the coal used and the method of coking; coals yielding less than 19 or more than 40 per cent. of volatile matter, are unsuitable for the production of best hard coke. The density of the coke is greater when the temperature used in its production is high, and, usually, the more dense the coke the lower is the fuel consumption, as dense coke is less acted upon by the carbon monoxide of the furnace gases. Sir L. Bell found that a Clarence furnace consumed 10 per cent. more fuel when the coke was made in the Simon-Carvès oven than when it was prepared in the ordinary bee-hive oven, in which a higher temperature is employed.

Use of Coal in Blast Furnaces.—Although coke is the most important fuel used in the blast furnace, considerable quantities of coal are also employed.

* *Inst. Journ.*, 1891, vol. i., p. 301.

† *Ibid.*, 1891, vol. ii., p. 187.

Coal may be thus classified :—

1. Non-caking, rich in carbon.
2. Caking.
3. Non-caking, rich in oxygen.

Of these *caking* coal is not used in the blast furnace.

Anthracite is a non-caking coal, rich in carbon, of which it contains from 88 to 94 per cent. It occurs in South Wales, where at one time it was largely used for blast furnace purposes, and in Eastern Pennsylvania, where it is still very largely employed. The volatile combustible matter in anthracite is small, and chemically it closely resembles coke, though in practice it is found that more anthracite than coke is required to produce a ton of pig iron. Anthracite does not burn readily, and so can only be employed with hot blast, and on account of its tendency to splinter and crumble in the furnace, high-pressure blast up to 10 lbs. per square inch is employed. It is usual also in America to carefully screen the coal, so as to remove the finer portions and secure greater uniformity of size after it comes from the collieries.

Bituminous coal, belonging to the class non-caking, rich in oxygen, is used in the West of Scotland and in the Midland counties of England. Such coal yields about 55 per cent. of fixed carbon, and has a calorific power of about 6,100 calories, or three-fourths that of pure carbon, but even under most favourable circumstances, 27 to 30 cwts. of coal are required to produce a ton of iron, and often fully 2 tons are employed. This is due to the fact that the volatile combustible matter is largely evolved before reduction of the ore is accomplished; it therefore takes little or no part in the reduction, but increases the volume, and improves the quality of the waste gases; while as heat is required for the decomposition of the coal, it is abstracted from the top of the furnace, and the fuel consumption is increased.

In the West of Scotland, in the Clyde basin, a variety of coal which is suitable for blast-furnace purposes occurs in considerable quantity. It is known as *splint coal*; some varieties show but little tendency to cake during coking, it is very free from decrepitation, and gives a good strong coke, capable of resisting considerable pressure. It contains about 40 per cent. of volatile matter, of which rather over 30 per cent. is combustible, and yields from 50 to 55 per cent. of fixed carbon. Its composition is shown by the following analyses :—

Carbon,	71·65		66·00
Hydrogen,	5·13		4·34
Oxygen,	10·13		11·09
Nitrogen,	1·40		·94
Sulphur,	·78		·59
Ash,	3·27		5·42
Water,	7·64		11·62
	100 00		100·00
	100 00		100·00

This coal is employed in the blast furnaces of the West of Scotland, in furnaces of from about 50 to 72 feet in height; these furnaces consume about 500 tons of raw coal per week, and produce rather over 300 tons of pig iron. The gases leave the furnace at a temperature of about 500° F.; they are richer in combustible constituents than when coke or charcoal is used, and the volume of gas per ton of coal averages 125,000 cubic feet at 60° F. Rather less than one-fifth of the nitrogen which is present in the coal can be recovered from these gases in the form of ammonia.* Raw coal of similar character is employed in the blast furnaces of North Staffordshire and Derbyshire, while in South Staffordshire about one-third of raw coal is often used in mixture with coke. A special form of blast furnace was introduced by Ferrie for use with bituminous coal.† The upper portion was divided into compartments intended to act as coking chambers, and the intention was to coke the coal in the furnace before it was burned. Furnaces on this plan were in use for some years at Wishaw and elsewhere, but have been abandoned, as the irregularity of working more than counterbalanced any advantage of the system. The relative advantages of coal and coke have been discussed at length in connection with a paper written by Sir L. Bell.‡

Brown Coal.—In Austria and Germany considerable quantities of lignite or brown coal occur, and this fuel is used for many metallurgical operations. It is of a more recent geological age than the ordinary coal of the carboniferous period, and is of lower calorimetric value, as the proportion of carbon is low. Attention was directed to the use of raw lignite in the blast furnace in Styria so early as 1806, but with little success; further experiments between 1871 and 1880 were somewhat more promising, and have been continued, though the large volume of gas which is evolved, often with an explosion sufficient to crumble large lumps of the coal to powder, is a source of considerable difficulty. According to Professor Tunner, the only place at which raw brown coal has been used exclusively was at Kalan, by Herr Massenez, and the results were not satisfactory. Mixtures of brown coal and coke have, however, been employed in a number of cases with good results, especially with a blast pressure rather greater than usual, so as to counteract the resistance to the passage of the gases due to the crumbling of the charge. Inferior lignites, which contain as much as 30 to 40 per cent. of water, are quite unsuitable for blast-furnace purposes; those which contain 10 per cent. of water may, as before stated, be employed in mixture with other fuel, though hitherto the results either of using even superior raw lignites alone, or

* W. Jones, *Inst. Journ.*, 1885, vol. ii., p. 410.

† *Ibid.*, 1871, p. 432.

‡ *Ibid.*, 1884, vol. i., p. 13.

of producing blast-furnace coke from such fuel, have not been satisfactory.*

Charcoal.—For many centuries charcoal was the only fuel used in iron making, but in modern times the scarcity of wood combined with large supplies of coal of suitable character, has caused charcoal to be entirely replaced in the great centres of the iron trade. Charcoal is still, however, extensively used in North America, Sweden, and Styria, and to a smaller extent in other parts. The wood to be charred should be dry, mature, and in pieces of considerable size; it should be well burned, so as to give a hard, compact charcoal. The bark of the wood should be removed, as it is considerably richer in phosphorus than the interior portions.† Charcoal made in retorts in the manufacture of pyroligneous acid is not sufficiently heated and is of inferior quality. In Europe charcoal is generally burned in heaps in the woods, while in Canada the timber is brought to permanent kilns, resembling the bee-hive ovens which are employed for blast furnace coke. In the United States retorts are very generally employed.‡ Charcoal which has been quenched with water and allowed to stand in the air, though quite dry to outward appearance, often contains upwards of 20 per cent. of moisture. It is, therefore, dried at a low temperature before being used in the blast furnace, the heat for this purpose being obtained from the furnaces. The charcoal is often placed on perforated wrought-iron trays, or in trucks of the same material, and caused to pass slowly down a shaft or inclined tunnel, up which a current of heated air is made to flow. When charcoal is employed in the blast furnace it is generally observed that the fuel consumption is less, often by as much as 25 to 30 per cent., than when coke is used. This fact will be referred to at length later.

The working of the two charcoal furnaces still remaining in Great Britain was described by W. J. Macadam in 1887. They belong to Messrs. Ainslie, and are situated at Newlands and Blackbarrow, near Ulverston, in Lancashire. One dates from before 1711, having been rebuilt in 1870, while the other was built in 1747. The height is about 30 feet, and the make does not exceed 30 tons per week. Cold blast is used, and the slags are glasses variously tinged with colour, and quite unlike any other blast furnace slag. The charges used to produce 1 ton of pig iron in 1738 and 1887 respectively were as follows:—

	1738.		1887.
Charcoal,	35 cwts.	Charcoal,	40 cwts.
Red hæmatite,	40 „	Red hæmatite,	32½ „
Iron stone,	½ „	Irish aluminous ore,	1 „
Limestone,	2½ „	Limestone,	2 „

* *Inst. Journ.*, 1882, vol. i., p. 96.

† *Ibid.*, 1888, vol. i., p. 260.

‡ For details of these see *Inst. Journ.*, 1888, vol. i., p. 259.

Each furnace is blown out once in three years for repairs, and is allowed to remain out of blast a year, so as to allow of an accumulation of charcoal. The wood takes sixteen years to grow, and about $2\frac{1}{2}$ tons of wood are required to produce 1 ton of charcoal, so that 5 tons of wood are needed per ton of pig iron. The iron is of the best quality, and fetches a very high price.* This method of production is still followed (1894), just as above described.

Use of Gaseous Fuel in the Blast Furnace.—Many attempts have been made to smelt iron with gaseous fuel, but with little success. It is obviously not possible to burn gaseous fuel at the bottom of the furnace, so as to produce the heat necessary for fusion, and to also employ the same gas as a reducing agent for the ore in the upper part of the furnace. If gas be introduced into the hearth to act as a reducing agent, the immediate result is a lowering of temperature, which would ultimately lead to the stoppage of the furnace. Hence the ore must be mixed with carbon in some form, to act as a reducing agent, and the gas merely used for heating and fusion. Even when gas is burned in the hearth, so as to produce the necessary heat, and reduction is accomplished by solid carbon, great trouble is experienced owing to the hanging of the charge and irregularities in its descent, and special means of supporting and distributing it during its passage through the furnace are necessary.

Among the more recent attempts in this direction may be mentioned some experiments by J. T. Wainwright,† who constructed a furnace with a vertical shaft and with an auxiliary combustion chamber leading into the hearth. The furnace charge was supported above the hearth on wrought-iron tubes; these were protected from melting by means of a covering of fireclay, and by passing a blast of air through their interior. In this furnace natural gas was used as fuel, and it was shown that the ore could be smelted with only 15 per cent. of the coke generally needed. Even with an experiment arranged as described, it was not found possible to entirely do away with the use of solid fuel, and in all probability the only advantage which would be derived from the adoption of such a method would be in exceptional cases, when inferior fuel might be used.

Since, as is afterwards shown, some 75 per cent. of the available heat from the solid fuel used is now actually utilised in blast-furnace practice, there is little reason to believe that any great advantage would accrue, in ordinary cases, from the employment of gaseous fuel, unless indeed some other method of applying it be devised than has hitherto been introduced.

A few years ago, with the approval of the late J. Head (F. Siemens' chief assistant), the author suggested a modified

* *Trans. Inverness Scientific Soc.*, vol. iii., p. 256.

† *Inst. Journ.*, 1889, vol. i., p. 294.

method of working the blast furnace, which, although it has been brought under the notice of several blast-furnace proprietors, has not yet been actually tried. The object was to apply the same principle in blast-furnace working, especially where coke is employed, as has been found so beneficial in the new form of Siemens' furnace. It was proposed to take a certain portion of the waste gases, not more than one-third of the whole, and to pass them again through the blast furnace, the gas being introduced either at the hearth or at some higher level, as found most convenient. As will be shown later, the waste gases consist of about 2 volumes of carbon monoxide to 1 volume of carbon dioxide, and the chief reducing agent in the furnace is monoxide. The reaction which would take place is as follows:—

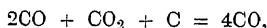

so that one unit of solid fuel would produce four volumes of reducing gas, instead of only one as at present (Eng. Pat. 1,161, 1890).

As it would not be possible, at best, to diminish the fuel consumption in this manner by more than a few cwts. per ton of iron made, the objections to the use of ordinary gaseous fuel would not apply, as there would still be ample coke used to keep the charge open. An objection to this proposal has been made on the ground that the furnace would be chilled by the reaction which takes place; but the cost of the suggested experiment is so small, and the possibilities so great, that the author believes it is well worthy of trial. It may be added that the patent was allowed to expire in 1894, so that no property is now claimed in the above suggestion.

Consumption of Fuel in the Blast Furnace.—The number of reactions which take place in the process of iron smelting is so great, and their relative importance varies so much, according to the conditions under which the furnace is being worked at any given time, that it is almost impossible to accurately determine, from thermo-chemical data alone, the amount of fuel which is theoretically required in order to produce a ton of pig iron. When, however, the assumptions upon which such calculations are based are clearly expressed and understood, the results often approximate very nearly to what actually occurs in practice, the difference between the calculated and actual fuel consumption not exceeding 1 cwt. of fuel per ton of iron.

It has been already explained that in the ordinary blast furnace, using coke as fuel, the reduction of ferric oxide to metallic iron is accomplished chiefly in the comparatively cold upper part of the furnace by the action of the carbon monoxide of the furnace gases. The equation is usually given as follows:—

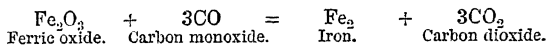

But since the experiments of Sir L. Bell have shown that owing to the oxidising effect of carbon dioxide on metallic iron at high temperatures complete reduction of calcined Cleveland ore is only possible in the blast furnace when the proportion of CO to CO₂ by volume is as 2 : 1 (or as 1 : .78 by weight), it is necessary to have 2 volumes of carbon monoxide in the issuing gases for every volume of carbon dioxide; the equation, therefore, takes the following form:—

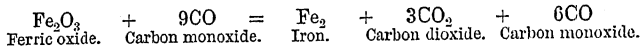

Proceeding now to calculate the amount of carbon necessary to produce 20 cwts. of iron, according to the above equation, it will be found that 1 ton of iron corresponds to $\frac{20 \times 160}{112}$, or nearly 28.6 cwts. of ferric oxide, and the oxygen to be removed will be 28.6 - 20, or 8.6 cwts. per ton of iron produced. To remove this oxygen it will require $\frac{8.6 \times 108}{48}$, or 19.35 cwts. of carbon, since 3 atoms, or 48 parts by weight of oxygen, are removed by 9 atoms, or 108 parts by weight of carbon in the form of carbonic oxide. This result of 19.35 cwts. of carbon per ton of iron is, therefore, the theoretical quantity of fuel required in an ordinary coke blast furnace on the simplest possible assumption—namely, that the materials to be dealt with are pure, and that the only reaction is that which takes place between carbon monoxide and ferric oxide. This does not take into account the ash and moisture which are always present in the coke, the carbon, silicon, &c., in the pig iron, the possible direct reduction by solid carbon, or the carbon impregnation in the furnace, circumstances which will to some extent counter-balance each other; but it leaves an ample margin of heat for melting the metal, slag, &c., in addition to that required for reduction.

Thermo-Chemical Calculations of Fuel required.—It is interesting to compare such a result, arrived at entirely from chemical considerations, with that deduced by Sir Lowthian Bell from his extended observations on the calorific efficiency of Cleveland furnaces. The following is an estimate of the number of calories, or centigrade heat units, which this investigator regards as necessary for smelting No. 3 Cleveland foundry iron of average composition, and includes those sources of waste which may be regarded as inseparable from the operation. As a basis of calculation 20 kilos. are employed; this permits of a ready comparison with 20 cwts., a weight which is familiar to English manufacturers* :—

* *Principles of the Manufacture of Iron and Steel*, p. 95.

	Weight in kilos.	Calories per unit weight.	Calories.
Evaporation of water in coke } estimated at, }	.58	540	313
Reduction of 18.6 kilos. of iron } from ferric oxide, }	18.6	1,780	33,108
Carbon impregnation, }	.6	2,400	1,440
Decomposition of limestone, }	11.0	370	4,070
Decomposition of CO ₂ from } limestone to CO, }	1.32 carbon	3,200	4,224
Decomposition of water in blast, } Reduction of phosphorus, sul- } phur, and silicon estimated at, }	.05 hydrogen	34,000	1,700
Fusion of pig iron, }	20.0	330	6,600
Fusion of slag, }	27.92	550	15,356
Total heat units usefully applied,			70,311
Estimated loss through walls of furnace, }		3,600	
" " in twyer water, }		1,800	
" " due to expansion of blast and other } causes, }		3,389	
			8,789
Carried off in escaping gases, }			7,900
Total heat necessary,			<u>87,000</u>

It is thus seen that to produce 20 kilos. of No. 3 Cleveland foundry pig iron some 87,000 heat units are necessary; but if the blast be supplied at a temperature of 540° C. this will introduce about 12,000 heat units derived from the combustion of the waste gases; thus leaving 75,000 units to be provided in the furnace itself.

The waste gases from a Cleveland furnace must, according to Sir L. Bell, contain at least 2 volumes of carbon monoxide to 1 volume of carbon dioxide; from which it follows that the calorific power of carbon when burned in the blast furnace is not 8,080, as usual in ordinary combustion, because only 1 part of carbon is fully oxidised, while 2 parts remain in the form of carbon monoxide. The calorific power of carbon under these conditions will be, therefore, $\frac{(8,000 \times 1) + (2,400 \times 2)}{3}$, or 4,266 calories. But coke of good average quality may be assumed to contain 10 per cent. of ash and moisture, so that its calorific power is less than that of pure carbon to this extent, and the number of heat units evolved by the combustion of a unit of coke becomes $4,266 - 426 = 3,840$. This number represents the calorific value of coke when burned in the blast furnace, and it is easy to determine the weight of coke necessary to yield 75,000 heat units; thus $75,000 \div 3,840$ gives 19.53 as the units of coke required to produce 20 units of metal in the blast furnace under the conditions above given. This result, deduced from thermo-chemical data, agrees with that previously calculated

from chemical considerations of the simplest character, viz., 19.35 cwts. of carbon per ton of iron, and extended experience during many years has shown that this fuel consumption approximates to what may be obtained with modern furnaces in Cleveland with hard Durham coke.

Duty of Fuel used.—Sir Lowthian Bell * has also calculated the useful effect and the allowances necessary for radiation, loss at boilers, chimneys, &c., and his conclusion is as follows:—

Heat generated by complete combustion of 18.83 units of carbon (18.83 × 8,080),	150,640 units.
Useful Heat—	
Furnace work, as previously calculated,	70,311
Heat in steam generated,	28,118
Available heat in unutilised gases,	10,837
Heat in twyer water,	1,800
	111,066
Waste,	39,574

This waste is accounted for as follows:—

Loss at chimneys, boilers, and hot-blast stoves,	19,096 units.
Estimated waste in utilising gases,	7,277
Radiation, &c., at furnace,	6,989
„ at boilers, stoves, &c.,	6,212
	39,574

From these figures the duty of the fuel used may be found, and it is seen that $\frac{111,066 \times 100}{150,640}$, or about 74 per cent. of the total available heat, is usefully applied. So large a proportion of the total heat generated is probably not utilised in any other manufacturing operation, so that for economy of smelting large quantities of material the blast furnace is without a rival. Nor does it appear probable that any considerable economy in fuel will in future be introduced into furnace practice where ore and coke, such as are used in Cleveland, are smelted, and where the ferric oxide is chiefly reduced by a reaction which leads to the occurrence of at least 2 volumes of carbon monoxide in the waste gases, to 1 of carbon dioxide.

So long as this is the case, the figures just given appear to prove that nearly 1 ton of coke will be needed to produce 1 ton of pig iron, and the consumption of fuel will necessarily be greater when raw coal is employed, since a large proportion of volatile constituents are then driven off in the upper part of the furnace, and lead to production of waste gases of greater volume and higher calorific power.

* *Principles of the Manufacture of Iron and Steel*, p. 144.

Low Fuel Consumption in Coke Furnaces.—But though what has been above stated may be regarded as proved for Durham coke and Cleveland ore, it has been found possible in modern American practice to produce a ton of pig iron with only 16 cwts. of coke, and the author is informed by managers of long experience in South Staffordshire that when using soft, in mixture with other, coke the fuel consumption is sometimes reduced to from 16 to 17 cwts. in furnaces of only moderate size. These facts do not detract from the correctness of the previous conclusions, but indicate that under different conditions other results are obtained.

The following comparison has been made by Sir L. Bell of the practice at the Edgar Thomson Works at Pittsburg, and the Clarence Works at Middlesbrough.†

Particulars of the Furnaces.	Clarence Works.	Pittsburg Works.
Temperature of blast,	704° C.	593° C.
Weight of blast per ton of iron,	87·15 cwts.	71·20 cwts.
Weight of gases per ton of iron,	119·17 "	100·10 "
Temperature of escaping gases,	250° C.	171° C.
Cubical contents of furnace,	25,500 ft.	18,200 ft.
Weekly output per 1,000 cubic feet,	21·57 tons.	128·00 tons.
Ore (Clarence was calcined) per ton of iron,	48·00 cwts.	32·26 cwts.
Limestone per ton of iron,	11·00 "	9·03 "
Slag per ton of iron,	28·00 "	10·71 "
Coke consumed per ton of iron,	19·99 "	16·80 "

	Cwts. of Coke per ton of Iron.	
	Clarence Works.	Pittsburg Works.
Reduction of peroxide of iron,	7·47	8·00
Reduction of metalloids in pig,	·94	·64
Dissociation of carbon monoxide,	·33	·35
Fusion of pig iron,	1·49	1·59
Evaporation of water in coke,	·06	·02
Decomposition of water in blast,	·54	·56
Expulsion of carbon dioxide from limestone,	·92	·75
Reduction of this carbon dioxide to monoxide,	·95	·84
Fusion of slag,	3·48	1·42
Carried off in gases,	1·60	1·21
Loss by radiation, heating twyer water, &c.,	2·21	1·42
	19·99	16·80

* *Inst. Journ.* (Amer. vol.), p. 172.

From these figures it appears that, in the above instance, the chief cause for the greater fuel consumption in the Cleveland furnace was the greater weight of slag and limestone, due to the use of poorer ore. The heat carried off by the gases, and the loss by radiation, &c., were also greater, due doubtless to slower working.

It is, however, noticeable that the ratio of carbon dioxide to carbon monoxide in coke furnaces, instead of being as 1 : 2 as in Cleveland practice, is sometimes increased to as 1 : 1.5, as in a furnace belonging to the Illinois Steel Company, examined by J. Whiting. With such an increase in the oxidation of the gases the fuel consumption is diminished; it is observed that at the same time the temperature of the escaping gases is lowered, and the yield per unit of furnace capacity is increased.*

Carbon Transfer.—According to C. Cochrane,† who has had exceptional experience in the building and management of blast furnaces, all economy in fuel with any particular furnace depends upon the following three conditions:—

1. The temperature of the blast.
2. The temperature of the escaping gases.
3. The proportion of carbon dioxide which can be maintained as such after it has been produced from the carbon monoxide generated in the hearth by the oxidising action of the ore.

Cochrane points out that the carbon burned at the tuyers is converted into carbon monoxide with a liberation of only 2,473 calories; this monoxide is in part converted into carbon dioxide during the reduction of the ore, and each unit of carbon thus oxidised yields a total of 8,080 calories. It is, therefore, advantageous to have as large a proportion of carbon dioxide as is consistent with the proper reduction of the ore. Any carbon dioxide which has been once formed and is again reduced to monoxide by the red-hot fuel leads to loss, and if the whole of the carbon dioxide formed by the reduction of the ore could be maintained as such, no further economy need be sought for. The carbon dioxide produced in the upper parts of the furnace by the decomposition of limestone is not a source of any heat or economy, but of loss, owing to the reaction with red-hot coke whereby monoxide is produced where it can take little or no part in the reduction.

The reducing action of carbon on carbon dioxide is least when the temperature of reduction is low, and is thus not so great with ores that are easily reduced. With ores which are more difficult to decompose, and which are charged in large pieces, a quantity of unreduced oxide of iron may be carried further down into the furnace. In ordinary working most of the oxide of iron is reduced by carbon monoxide before the charge attains

* *Inst. Journ.* 1891, vol. ii., p. 244.

† *Inst. M.E.*, 1883, p. 93.

a red heat, but with more refractory materials, or bad working, a considerable proportion of carbon dioxide may be produced in the lower parts of the furnace and thus lead to waste. The amount of carbon absorbed by the ascending gases, according to the equation $\text{CO}_2 + \text{C} = 2\text{CO}$, is styled by Cochrane the "carbon transfer," and is expressed in cwts. of carbon per ton of iron made. Cochrane has called in question the correctness of the law enunciated by Sir L. Bell that, in order to completely reduce ferric oxide, it is necessary to have at least 2 volumes of carbon monoxide to 1 volume of carbon dioxide, and believes that economy in blast furnace working depends less upon the composition of the furnace gases than upon the reactions which have resulted in giving that composition. Sir L. Bell, on the other hand, contends that the composition of the waste gases when rightly understood indicates the nature of these reactions.

Effect of Working Conditions.—In the previous observations on the consumption of fuel the furnace has been generally assumed to be of suitable height, shape, and capacity, and working in a regular and satisfactory manner. It may, however, be observed that any irregularity of working, such, for example, as scaffolding, almost invariably leads to increased fuel consumption when the weight and grade of the product are considered. Any reduction in the height of the furnace also leads to the use of more fuel, whether this be due to alterations in the height of the structure itself, or to differences in the height of the materials owing to irregular charging.

Thus in an experiment performed by T. Oakes many years ago at the Ketley Iron Works, a furnace which was working well at a height of 55 feet, and giving grey iron, had charging holes made in the side about 40 feet above the twyers, or 15 feet lower than before. The furnace still worked satisfactorily, except that the iron produced was all white, and since less fuel is required to produce white iron than grey, this was equivalent to a larger fuel consumption. The increased consumption of fuel, due to irregular filling, has been pointed out by W. J. Hudson, and more recently in a paper on "The Temperature of the Blast Furnace" by C. Bell.* An excessive amount of blast also leads to waste of fuel, not that it leads to free oxygen being found in the furnace gases, as was at one time suggested, or even that the proportion of carbon dioxide is increased. The result of an excess of air is the production of an undue proportion of carbon monoxide in the furnace, and this passes away with the waste gases without taking part in the reduction of the ore. This was doubtless the cause of excessive fuel consumption in the early days of large outputs in America, as has been pointed out by F. W. Gordon.† In smelting poor ores, owing to the

* *Cleveland Engineers*, 1892.

† *Inst. Journ.*, 1890, vol. ii., p. 74.

ger time required for reduction with such materials, an excess blast leads to the production of a scouring slag rich in ferrous oxide.

Speed of Working and Economy.—The length of time taken for the charge in passing from the throat of the furnace to the hearth has a considerable influence on the fuel consumption, it being usually observed that this is less with rapid- than with slow-working furnaces. When charcoal is employed for fuel, the charge passes through the furnace much more rapidly than with cold coke, and a much shorter period elapses between the time when the ore is charged into the furnace and its arrival in the reduced condition in the hearth; and it has already been pointed out that with easily-reducible ores and rapid working in America unusually low fuel consumptions have been obtained. The explanation of this economy is doubtless in part a physical one, the rapid charging in, and descent of, cold materials would allow the ascending gases much more perfectly than when the furnace works more slowly, and the materials become gradually reduced throughout.* A small furnace working rapidly on rich ores thus cools the escaping gases as efficiently as one of much greater cubic capacity working slowly. At the same time it is probable that, as the escaping carbon dioxide remains for a much shorter period in contact with heated fuel, and is brought into contact with much less fuel, the mutual action between carbon dioxide, or carbon transfer, which leads to the production of carbon monoxide in the upper portions of the furnace, where it can exert little or no beneficial influence, is proportionately lessened, and fuel is saved. Excessive driving, on the other hand, is associated with waste of fuel, owing to the increased proportion of carbon monoxide in the waste gases due to the excess of blast.

Consumption of Fuel in Charcoal Furnaces.—It is observed that the consumption of fuel in charcoal furnaces, which are of relatively small size and driven with cold or nearly cold blast, is usually only two-thirds of that employed in a modern hot-blast coke furnace, and this observation has led to much discussion. The first important fact to be remembered in connection is that, with the gases from a charcoal furnace, the proportion of carbon dioxide is usually greater than from a coke furnace, and not unfrequently exceeds the ratio of 1 volume of CO_2 to 2 volumes of CO . The carbon is thus more completely oxidised, and the consumption of fuel diminished; the speed of working and the yield per cubic foot of internal capacity are increased, while the gases are more perfectly cooled. The difference in the composition of the waste gases is due to the fact that reduction takes place at a much lower level in a charcoal furnace, and, as Tunner's experiments have shown,

For proof of this statement see Sir L. Bell, *Inst. Journ.*, 1893, vol. ii., p. 46.

scarcely commences below a temperature of about 800°C. There is, therefore, no zone of heat evolution near the top of a charcoal furnace as in a coke furnace, and the upper part of the furnace is much cooler, so that despite the much smaller size of a charcoal furnace, the gases leave at a lower temperature. It has been previously pointed out that when the ore has descended through about one-fourth of the height of a Cleveland furnace deoxidation is practically complete, while with charcoal the charge passes half-way through the furnace before reduction commences. The upper part of the furnace being thus cool carbon transfer is much lessened.

Analyses prove that in the lower part of a charcoal furnace the proportion of carbon dioxide is greater than when hard coke is used; and since a higher temperature is required to effect reduction it is probable that the action is of a different character. It is remarkable that, while the proportion of carbon dioxide present in the gases of a charcoal furnace is greater than is compatible with efficient reduction in a coke furnace, the actual quantity of carbon dioxide is less than would be formed if the ore were reduced by carbon monoxide. Carbon dioxide is, therefore, present in quantity which is proportionally too great, but actually too small, for a coke furnace. This may be due to two causes; the ore may be in part reduced by carbon, either in the form of fuel or as impregnated carbon, with the production of carbon monoxide, thus—

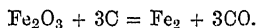

Or again, carbon dioxide produced by the reduction of part of the ore by carbon monoxide may act on the fuel to reproduce monoxide, thus—

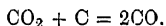

And this CO being produced low down in the furnace may again take part in the reduction. In either case the ultimate result would be the same as though the ore were reduced by solid carbon.

Probably both reactions take place, the first in the zone of fusion, and the second to a smaller extent somewhat higher in the furnace. It is reasonable to assume that the direct reaction between carbon and ore is of more importance in charcoal than in coke furnaces, because the fuel is soft and more readily acted upon by oxidising agents, while the ore to be smelted is usually tolerably rich, and easily reduced. If this be not so it is difficult to see why an easily reducible ore in a charcoal furnace should only be reduced at about 800° C., the temperature at which solid carbon burns, while a difficultly reducible ore is appreciably reduced at about 400° C. by the gases of a Cleveland furnace.

It has been urged against the theory that reduction is due in part to the action of solid carbon that the ore and fuel are present

in the form of lumps, and that, therefore, no admixture is possible. It is noticed, however, even in Cleveland practice, that the lumps of ore charged into the top of the furnace are disintegrated in passing through the furnace, chiefly owing to carbon impregnation, and though lime and coke may pass through in lumps it is very unusual indeed for the ore to be in the form of large pieces in the lower parts of the furnace. It will be readily understood that in Cleveland practice, even though the ore is thus disintegrated, solid carbon would have relatively little action, because reduction is nearly complete at the top of the furnace, and because the coke is in lumps, and is comparatively inert. The conditions are, however, different in a charcoal furnace where the fuel is in a much finer state of division and chemically much more active, where reduction takes place much lower in the furnace, and where experiments have proved the existence of oxides at a depth of upwards of 25 feet below the furnace mouth. It must also be remembered that the reducing power of carbon monoxide is less at very high than at moderate temperatures (see p. 138).

The foregoing considerations appear to indicate that the smaller fuel consumption observed when smelting rich ores, or when using charcoal, is a result of the following causes:—

1. Less slag has to be melted, hence less flux is required, and less fuel is needed; at the same time less CO_2 is evolved from the limestone, and less coke is attacked in the upper part of the furnace.

2. Reduction takes place at a lower temperature and at a lower level in the furnace, hence the CO_2 is in contact with the heated fuel for a shorter period, and less carbon transfer takes place.

3. The ore is more completely deoxidised in the zone of reduction, and thus less CO_2 is generated further down in the furnace where carbon transfer can occur.

4. As a result of the diminished carbon transfer, combined with the easy reducibility of the ore, a higher ratio of CO_2 to CO than 1 vol. to 2 vols. is obtained, and a higher calorific power is obtained per unit of fuel.

5. The direct action of solid carbon on the ore, which is small with hard coke and refractory ores, is probably of more importance with rich ores and soft fuel.

6. Owing to the rapid descent of the charge the issuing gases are cooled more perfectly than with similar furnaces working with refractory ores.

Theoretical Minimum Fuel Consumption.—It has been previously shown that in order to obtain 20 cwts. of metallic iron from ferric oxide it is necessary to remove 8.6 cwts. of oxygen. It is interesting to consider by what reactions this oxygen may be removed with the smallest possible fuel con-

THE FUEL USED IN THE BLAST FURNACE.

sumption. If the whole of the oxygen were removed by action of solid carbon, thus—

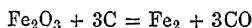

since 12 parts of carbon combine with 16 parts of oxygen, minimum consumption of carbon would be $\frac{8.6 \times 12}{16} = 6.45$ c per ton of iron. It is easy by a similar calculation to find weight of coke needed to produce a ton of pig iron when composition of fuel and metal is known.

But though 6.45 cwts. of carbon thus satisfies the chemical requirements of reduction it might not supply sufficient heat for the reaction. The following figures show the heat generated and that required for reduction, according to the equation under consideration. In the calculation no allowance is made for incidental losses of heat, many of which are due to the use of impure materials and to imperfect methods of working; while the carbon monoxide produced is assumed to be burned and its heat utilised:—

	Heat Units
6.45 units of carbon oxidised to CO, and the CO afterwards oxidised to CO ₂ , and the whole of the heat utilised (6.45 × 8,080),	52,116
Reduction of 20 units of iron from ferric oxide (20 × 1,780)	= 35,600
Fusion of 20 units of pig iron (20 × 330)	= 6,600
	42,200
Surplus,	9,916

It is thus evident that 6.45 cwts. of pure carbon are sufficient either from a chemical or a thermal point of view, to reduce 1 ton of iron assuming the use of perfectly pure materials. The quantity of carbon necessary to convert pure iron into pig iron be added—*i.e.*, 3 per cent. of the weight of the iron—carbon becomes as nearly as possible 7 cwts. per ton of iron.

Though this figure is very low indeed as compared with what is at present attainable, it is theoretically possible by a simple reaction to produce a ton of iron with a still smaller consumption of carbon. In the former case it was assumed that the carbon monoxide produced by the action of carbon on ferric oxide was burned and its heat utilised. If, however, the carbon monoxide were employed for the reduction of another quantity of ore, 3 molecules of monoxide would combine with 1 atom of oxygen to produce 1 volume of CO₂ and 2 volumes of CO. Hence 4 atoms of oxygen would be removed from ferric oxide instead of 3, and the carbon required would be

less in proportion, or $\frac{6.45 \times 3}{4} = 4.84$ cwts. This carbon would satisfy the chemical conditions, but the heat generated, the

sufficient to accomplish reduction, would not be sufficient to melt the metal, thus—

	Heat Units.
4.84 cwts. of carbon burned to CO ₂ (4.84 × 8,080)	= 39,107
20 cwts. of iron reduced from ferric oxide (20 × 1,780)	= 35,600
Fusion of 20 units of pig iron (20 × 330)	= 6,600
	42,200
Deficiency, . . .	3,093

This deficiency would necessitate the use of 0.38 unit of carbon, while the carburisation of the metal would require about 0.6 unit, and the result is as follows:—

Required for reduction alone,	4.84 units.
Additional carbon to supply heat,38 „
To carburise the iron,60 „
	5.82
Theoretical minimum,	5.82

That so low a fuel consumption will ever be attained in actual practice is not to be expected, but there is a sufficiently large margin between what is thus theoretically possible, and what is actually obtained in even the best practice to stimulate further investigation in the direction of increased economy. From what has been stated above it will be seen that very little economy is possible in coke furnaces so long as the chief reaction is the indirect one between CO and the ore, instead of the direct action of the solid fuel; nor does experience with other types of furnaces lead to hope of greater economy with any of these than with the blast furnace. The so-called “direct” processes are all so costly in labour, fuel, and repairs that it is probable that the economy of the future will be found in improved methods of working in the blast furnace itself, instead of a direct reduction which dispenses with the blast furnace altogether.

The student wishing for more information on the consumption of fuel in the blast furnaces may with advantage read the lengthy paper by Sir L. Bell “On the Waste of Heat, Past, Present, and Future, in Smelting Ores of Iron,” *Inst. Journ.*, 1893, vol. ii., pp. 219-284.

CHAPTER X.

SLAGS AND FLUXES OF IRON SMELTING.

Appearance of Blast-Furnace Slags.—The colour and appearance of the slag from the blast furnace afford a valuable indication of the working of the furnace, and not unfrequently a change in the character of the slag is the first indication of altered conditions of working. With an excess of lime, as is usual for the production of an open-grain iron, such, for instance, as No. 1 grade, the slag is difficultly fusible, and when solidified is white in colour, light, and soft in texture, and when it comes in contact with water it readily slakes. With intermediate grades, such as No. 4, the slag is more hard and compact, and usually has a grey colour, with more or less of a greenish or bluish shade, caused by a small quantity of ferrous oxide, and probably also by sulphide of manganese. It is this class of slag which is chiefly employed for road metal, and for the production of slag bricks; not unfrequently also definite crystals are met with in these slags. When the furnace is making white iron the slag produced is dark in colour and very fluid; it contains unreduced iron in the form of ferrous oxide, and on account of its great fluidity when melted, and its power of attacking the furnace lining, is known as a "scouring" slag.

It may therefore be remembered, as a simple rule, that when the iron is grey the slag is light in colour, while conversely, when white iron is accompanied with a dark-coloured slag. The proportion of iron present in dark-coloured slags may, in exceptional cases, amount to as much as 10 per cent., though usually it is much less than this, and the analyses of sixteen slags from Dowlais with white iron (by E. Riley) gave an average result of 2.5 per cent. of ferrous oxide; while in Cleveland practice with grey iron the slags contain only 0.25 per cent. of ferrous oxide.

Disposal of Slag.—It was formerly the custom to run off the slag from the blast furnace at intervals between the tapping of the metal; this system is known as "flushing," and is still adopted where furnaces with open fore hearths are in use. With small yields the slag is then run into rough open sand moulds in each of which a hook is placed, to allow of handling the resulting slag block with a chain and pulley. Generally, however, slag bogies running on rails are employed; the body of

the bogie consists of cast-iron segments bolted together so as to give a taper block of slag, as this form of mould is more easily removed when the slag solidifies; while in case of sticking, the iron frame can be taken to pieces.

In Cleveland the slag is now generally run through a bronze twyer about 1 inch internal diameter, and flushing is prevented. At Sir B. Samuelson's works the slag then flows down a trough, from whence it runs into small pans fixed on an endless chain of bar links. As the chain revolves the slag is delivered into iron trucks, which are placed beneath the outer pulley round which the chain passes. The trucks, when full, pass down an incline, and the slag is cooled with a spray of water; it is then taken by a locomotive to a wharf, where the bottom doors of the trucks are dropped, and the slag shot down a spout into a barge. The barges are afterwards towed out to sea, and the slag deposited. This arrangement is intended to save the great wear and tear of bogies and barges due to large blocks of slag, as the slag is broken into shingle by the above treatment. If the slag is tipped on land, side- or end-tipping waggons are employed.* In America, in some instances, the slag is removed from the furnace at intervals in side-tipping ladles, which are lined with firebrick, and mounted on bogie carriages; the lining is said to last for months, and the saving in labour and repairs, as compared with a train of cinder bogies, is said to be considerable.†

At the Völklinger Iron Works blast-furnace slag is granulated by running into water, and collected in a large iron receiver fitted with a perforated false bottom and divided into two parts, so that one side can drain while the contents of the other side are being removed. Spouts are arranged around the bottom of the receivers, so that the slag sand can be loaded into buckets, which are conveyed on an aerial wire railway across the river Saar to a waste heap, while the empty buckets are utilised, as they return, for conveying coal to the works from a neighbouring colliery. Attempts have been made to use similar methods for conveying slag blocks cast in iron buckets, but the wear and tear of the buckets was too great, and though granulated slag occupies a larger bulk, it is in the end advantageous to treat the slag as above described.‡

An interesting method of utilising the waste heat of blast-furnace slag has been patented by Sir L. Bell, and employed at the Clarence Iron Works, Middlesbrough. Connected with these iron works are extensive salt and chemical works, and the slag when cast from the blast furnace in large blocks, and still red hot, is taken to the salt works and placed under the pans

* *Inst. Journ.*, 1887, vol. i., p. 99.

† *Ibid.* (Amer. vol.), 1890, p. 233.

‡ *Ibid.*, 1890, vol. ii., p. 620.

in which the brine is evaporated. In this way the heat of the slag is gradually given off, and utilised for the production of salt, instead of burning solid fuel as usual.

Composition of Blast-Furnace Slag.—The following analysis by E. Riley gives the composition of the blast-furnace slag at Dowlais in 1859. The experiments were conducted upon thirteen furnaces, and during seven consecutive days a portion of slag was run into a ladle from each furnace, and an average sample obtained from each portion. The slag from each furnace was then separately analysed, and the following figures give the mean of these thirteen analyses:—

Silica,	41·85
Alumina,	14·73
Ferrous oxide,	2·63
Manganous oxide,	1·24
Lime,	30·99
Magnesia,	4·76
Potash,	1·90
Calcium,	1·15
Sulphur,	0·92
Phosphorus pentoxide,	0·15
	100·32

Of these thirteen furnaces twelve were making the common white forge pig so largely used in South Wales at the time, the other furnace was making grey iron; all of the furnaces were working with coke and hot blast. The following table illustrates the extreme variations in the composition of the slags working on white iron, while the analysis of the slag from the furnace making grey iron is added for comparison:—

	White Iron.		Grey Iron.
	Maximum.	Minimum.	
Silica,	45·23	39·09	38·48
Alumina,	17·14	11·55	15·13
Lime,	34·32	23·81	32·82
Ferrous oxide,	6·91	1·29	0·76
Sulphur,	1·31	0·47	0·99
Phosphorus pentoxide,	0·43	0·10	0·15

Of these figures it may be noticed all the cinders from white iron contained more silica than that from the grey iron, and only one of the white cinders examined contained less than 40 per cent. of silica. The ferrous oxide was in every case higher with white-iron cinders, while the phosphorus in the slag was not

appreciably increased until upwards of 2 per cent. of ferrous oxide was present. These results are worthy of note, on account of the number of furnaces experimented with, the care exercised to obtain representative samples, and the reputation of the analyst. Full details are given by Dr. Percy.*

The following analyses of blast-furnace slag and of the pig iron produced at the same time are quoted from H. Pilkington.† The iron was of foundry quality, and made at Tipton Green furnaces in Staffordshire :—

Slag.		Pig Iron.	
Silica,	39·40	Graphite carbon,	2·900
Alumina,	13·30	Combined carbon,	0·250
Ferrous oxide,	0·95	Phosphorus,	2·805
Manganous oxide,	0·52	Silicon,	2·839
Lime,	41·26	Sulphur,	0·047
Magnesia,	3·65	Manganese,	0·436
Sulphur,	1·02	Iron (by difference),	90·669
	100·10		100·000

Although it is usual for blast-furnace slags to contain a considerable proportion of lime, it is possible, in exceptional cases, to obtain a satisfactory slag without lime, when this base is replaced by the oxide of some other metal. Thus Sir L. Bell ‡ has given the following analyses of a slag from Rhenish Prussia, in which lime is replaced by oxide of manganese (MnO) :—

Silica,	49·57
Alumina,	9·00
Manganous oxide,	25·84
Magnesia,	15·15
Sulphur,	·08
Ferrous oxide,	·04
	99·68

Utilisation of Slag.—The quantity of blast furnace slag annually produced in the chief iron-making countries of the world is upwards of 20 millions of tons, of which but a small proportion is at present profitably utilised. The methods which have been applied on any considerable scale include the following :—

1. The harder varieties are often used for road metal, especially where suitable stone is not easily procured.
2. Slag is largely employed in levelling and reclaiming waste land, in the building of breakwaters, and as ballast for railways.
3. Bricks are prepared by casting slag in revolving or other iron moulds; only certain kinds of slag are suitable for this

* *Iron and Steel*, p. 498.

† *S. Stoff. Inst.*, December, 1887.

‡ *Principles*, p. 169.

process, and the bricks produced are liable to crack from internal strains.

4. The slag is allowed to slowly trickle into water, and is thus granulated. The granulated slag is then either mixed with lime and pressed into bricks, which set very hard in time, or it is ground to an impalpable powder and used for cement.

5. The molten slag is blown by a jet of steam which produces small globules, to each of which is attached a long thin filament. It is drawn by a gentle exhaust down a pipe bent twice at right angles, and the globules are thus detached by striking against the side and bottom of the tube. The filaments then pass up an incline into a room surrounded with wire gauze, in which they are deposited as "slag wool," which is employed as a non-conducting, non-inflammable packing.

Methods 4 and 5, which have been employed for a number of years with satisfactory results, were suggested by Charles Wood, of Middlesbrough, who was the first and best known worker in this direction in recent years. It is, however, interesting to notice that an English patent was granted to Messrs. Mander, Manby & Vernon so long ago as May 31st, 1813, for the utilisation of blast furnace slag in the preparation of castings to be used for replacing bricks, quarries, and tiles; and it was stated at the time that a similar method of using blast-furnace slag had long been practised at the iron furnaces of Sweden.* A still earlier patent had been granted to J. Payne in 1728, though in this case the details of the proposed procedure are somewhat vague, and applied to slags from "divers mettalls and ores." In 1855 Messrs. Chance, of Spon Lane, obtained a patent for casting slags, produced by the smelting of iron, in sand moulds which had been previously heated; the process did not answer commercially, but ornamental articles are still produced on a limited scale by similar methods. A summary of recent practice in the utilisation of slag has been given by W. Hawdon,† while J. E. Stead has described the manufacture and properties of slag cement.‡ The utilisation of blast-furnace slag is conducted on a considerable scale in Germany, one firm having produced over 5 million slag bricks between 1875 and 1892, while in the latter year there were in Germany ten slag cement factories with a total production of 600,000 tons. A detailed account of the German industry has been given by R. Zsigmondy.§

At the Edgar Thomson Works a method has been adopted in which the fluid cinder is received in brick-lined tank-waggons holding 10 tons. These, when filled, are drawn to a waste heap about half a mile from the furnaces, when, by opening a valve,

* Thompson's *Annals of Philosophy*, vol. ii., p. 157.

† *Inst. M. E.*, 1892, p. 70.

‡ *Inst. Journ.*, 1887, vol. i., p. 405.

§ *Dingler's Journ.*, vol. cclxxxiv., p. 233; *J. S. C. I.*, vol. xii., p. 264.

the fluid cinder is run on the ground. This arrangement requires less land and saves trouble, as compared with the ordinary process of casting into blocks.*

Paving Blocks.—Certain kinds of blast furnace slag when run into an iron mould and afterwards annealed make excellent paving blocks. In the Cleveland district some 5 million such blocks are produced annually by the following process:—Slag of suitable quality is run from the furnace into a bogie ladle, from which it is poured into cast-iron moulds secured to the periphery of a horizontal wheel. Each mould has a hinged bottom, and as the wheel is slowly rotated the bottoms of the mould are released in succession. The blocks, which are solid at the surface, but molten inside, are dropped on to a bed of granulated slag, and quickly removed and stacked in an annealing oven, and allowed to anneal without any additional heat. In about eight hours the oven is opened and the blocks withdrawn, when they are ready for use. If the blocks were merely cast and not annealed they would soon crumble to pieces from the action of internal stresses. Flags for pavements are also made on a considerable scale in Cleveland from ground slag, which is mixed with Portland or slag cement, and moulded into the required shape. They are then slacked for some weeks to harden before use.†

Calculation of Furnace Charges.—In order to calculate the nature and quantity of flux required for any particular iron ore, it is necessary, in the first place, by means of analyses, to determine its composition. From the known characters of the silicates of lime, magnesia, alumina, and other metals, either alone or when mixed together, the required weight of flux can then be determined. The calculations involved are much shortened by the adoption of the method suggested by Professor Balling, in which the composition of the most readily-fusible silicates is diagrammatically represented by means of right-angled triangles. These triangles are obtained by taking the proportions of acid and base in the required silicates as ordinates and abscissæ respectively, and connecting the points so obtained by a straight line. The composition of the ore being known, the proportions of the various bases are marked off on the base line, and by a simple construction involving merely the describing of a line parallel to the longest side of each of the standard triangles, the necessary proportion of acid is found in turn for each base which is present. The excess of acid or base in the ore is thus determined, and by a similar construction its equivalent in flux is obtained. This method has been fully described, with examples, by Professor Roberts-Austen,‡ and his description need not be here repeated.

* Phillips-Bauerman, *Metallurgy*, p. 220.

† J. Head, *Inst. M. E.*, 1893, p. 240.

‡ *Metallurgy*, pp. 161-171.

In order to render Balling's method more easy of application where many such determinations have to be performed, several modifications have been suggested. H. C. Jenkins* has adopted a drawing board with a graduated T square, and with triangles drawn to correspond with any silicates which may be desired. Instead of having to draw parallel lines for each observation, it is only necessary to move the square the required distance on a graduated base line, and to read off the corresponding quantity of acid on the graduated square. A. Wingham,† on the other hand, adopts the principle of the slide rule, and by means of one large slide and four smaller ones, which represent the most important silicates, he is able to determine the amount and quantity of flux necessary for an ore of known composition.

The methods above described are specially useful when new ores have to be treated, but in the great majority of cases in actual practice the general character of the ore is already known, and the object is to guard against accidental variations, while it is not practicable to constantly obtain complete analyses of the materials to be smelted. It is usual, therefore, to control the working of a blast furnace by the examination of the slag, and the substances of most importance in this connection are silica and lime.

The composition of the slag in connection with the temperature and yield of a blast furnace is of the greatest importance, for just as it is not possible to heat water in which ice is suspended to a temperature much above that at which water freezes, so it is not possible, unless the hearth is kept filled with coke, to raise the temperature of the blast furnace much above the temperature at which a slag is formed by the materials charged into the furnace. With low melting-point slags any increase of fuel or blast only alters the yield, without giving a higher temperature, since, in order to maintain a high temperature, it is necessary to employ slags which have a high melting point. When, however, the slag is of approximately the correct composition, the rate of working is determined chiefly by the time required for the combustion of the solid carbon in the hearth.

It is observed that so long as other conditions do not vary, the rapidity of the furnace working depends on the proportion of silica in the slag. This in its turn affects the "grade" of the iron, since the reduction of silicon and the absorption of sulphur, which are the chief factors in determining the "richness" of the iron, depend upon the temperature of the furnace. Hence it follows that by carefully regulating the proportion of silica on the one hand, or of lime on the other, the grade of the iron can be at the same time controlled. When the proportion of silica reaches or slightly exceeds 40 per cent., the iron obtained is white, while

* *Inst. Journ.*, 1891, vol. i., p. 151.

† *Ibid.*, 1892, vol. i., p. 233.

the slag is dark in colour from the presence of ferrous oxide, it chills quickly, and contains but little sulphur; with about 37 per cent. of silica a forge iron is obtained, while softer and more open grades of iron are produced with still less silica, since more sulphur then passes into the slag. These values are modified somewhat by alterations in the relative proportions of the bases present, but are generally true so long as only a moderate amount of alumina is in the slag. With more alumina, as in Cleveland, the proportion of silica is less, though still a constant quantity for a particular grade of iron.

The flux required in a given case may thus be calculated as follows:—Let it be assumed that the ore contains, in addition to ferric oxide, which need not enter into the calculation, 18 parts of silica, 2 of lime, 1 of magnesia, and 6 of alumina. The total bases will thus amount to 9 parts, while the silica, or acid, is 18 parts. But since the silica in the slag should not exceed 40 per cent., the bases together must be at least 60 per cent., and $\frac{18 \times 60}{40} = 27$ parts as the smallest quantity of bases which

will work satisfactorily. As 9 parts of base are already present, 18 parts of lime should be added to combine with the excess of silica. The lime would usually be added in the form of limestone, and to convert CaO into CaCO₃, the weight of lime should be multiplied by $\frac{100}{56}$, which brings the minimum quantity of

limestone to 32 parts in the case under consideration. It must be remembered that the most suitable proportion of silica for the grade of iron required must first be known from actual experience before this method can be applied. The author has seen this method in use at a number of works with good results; the silica in the slag being determined daily as a check upon the working of the furnace. The analysis and calculation involved are of a very simple character, while the method affords an excellent guide to the working of the furnace. Numerous calculations on a similar principle, but adopting the ratio of silica to bases of 0.85 to 1 as more suitable for American practice, have been given by F. F. Amsden.*

Similar results may be obtained from a consideration of the proportion of lime present in a given slag, for it is observed in practice that particular varieties of ore require approximately constant quantities of lime in the slag if the furnace is to work satisfactorily. The ores employed in the United Kingdom may be divided into the following representative classes, and according to how nearly any particular ore approaches to one or other of these classes, so must the burden be altered to yield a slag corresponding in its proportion of lime to that given in the table:—

* *Inst. Journ.*, 1891, vol. i., p. 369.

	Lime per cent.	Magnesia allowed for in Slag.
Clay ironstone, of which Cleveland is the type, .	30-35	5-7
Brown hematite, of which Lincolnshire is the type, .	30-40	4-6
Pure hematites, of which Cumberland or Spanish is the type, .	42-45	2-7
Basic mixtures, with cinder, &c.,	40-45	4-7
Slags for spiegel-eisen, ferro-manganese, &c., .	43-48	2-7

In the first three cases the product would be No. 3 iron; basic pig would usually be mottled, while manganiferous irons are white. When the magnesia in the burden considerably exceeds that which is given in the above table, this excess of magnesia must be allowed for, remembering that 1 part of magnesia is equivalent to 1.4 parts of lime.*

Alumina in Slags.—The basic character of alumina in slags is much less pronounced than that of lime or magnesia, and there are reasons for believing that in some cases, when alumina is present in excess, it behaves as a feeble acid. Hence variations in the proportions of alumina have frequently more influence on the physical properties, and on the melting point, than on the chemical behaviour of a slag. According to the experiments of P. Gredt † on the influence of different proportions of alumina on the fusibility of blast-furnace slags, the addition of alumina to mixtures of lime and silica increases the fusibility until a composition of 1.87 parts of silica, 1.07 of alumina, and 1.75 of lime is obtained; but if more alumina be added to this the melting point again rises. Starting with this most fusible mixture, which melts at about 1,410° C., this same experimenter found that on adding magnesia the melting point was further lowered, until a mixture was obtained with 1.88 parts of silica, 1.07 of alumina, 0.93 of lime, and 0.58 of magnesia. This melted at 1,350°, which was the lowest temperature observed in these experiments, and any further addition of alumina or of magnesia rendered the slag less easily fusible.

Ore Mixtures, and Self-Fluxing Ores in Furnace Working.—In smelting ores, the gangue of which consists of one material only, such as silica, it is found advantageous to add alumina to the charge in some convenient form, as mixed silicates are, as indicated above, more fusible than those with a single base. In smelting Cumberland hæmatites, the gangue of which consists chiefly of silica, it is usual to employ in mixture a certain proportion of aluminous ores, such as those which are imported

* Ridsdale's *Syllabus, Iron and Steel*, p. 30.

† *Inst. Journ.*, 1889, vol. ii., p. 412.

from Belfast and from Algiers. Belfast ore, which was first introduced for this purpose in 1862, contains about 30 per cent. of alumina; and bauxite, which is sometimes used for similar reasons, about 60 per cent. In making basic pig a considerable proportion of tap cinder is generally employed; this contains very little alumina, and in such cases it is advantageous to add argillaceous ores. In the Cleveland district, when smelting imported hæmatites, which are also deficient in alumina, it is found convenient to add a quantity of slag produced in smelting Cleveland ores; this is, of course, practically free from phosphorus, as all the phosphorus originally present in the ore passes into the Cleveland pig, while the slag contains about 20 per cent. of alumina, and thus acts as a cheap and suitable flux. In making basic pig, when the proportion of phosphorus in the charge is less than usual, a suitable addition of basic slag from the steel works is employed; this replaces limestone in the furnace charge, and at the same time supplies the required phosphorus. In some parts of Lincolnshire and Northamptonshire ores are met with which are very rich in lime, though sometimes these ores contain comparatively little iron. They can, however, be advantageously used with siliceous ores to produce a self-fluxing mixture. The brown ores of the Rhenish provinces, known as minette, are often also self-fluxing. In those cases, which are not very frequent, where the gangue is basic, as in Styria, the flux added is necessarily acid in character, such as quartz, sand, &c. If the slag is made more than usually siliceous, it becomes more fusible, and white iron is produced; this generally happens if the silica in the slag exceeds 40 per cent. Ore mixtures yielding slags of this character can seldom be used with advantage, except when a considerable quantity of manganese is present, as the white iron then produced is free from sulphur; in other cases, though the make of the furnace is greater and the fuel consumption less, the product is so inferior that siliceous slags are quite out of the question. It must also be borne in mind in arranging a blast-furnace charge, that a certain proportion of slag is required per ton of iron in order to make the furnace keep "open" and work satisfactorily; it may therefore be necessary in some instances to add easily-fusible materials, simply to give the required slag, and occasionally for this purpose a quantity of the slag made by the furnace itself may be added to the charge.

The heat required to melt a unit weight of slag is greater than that required for cast iron, the value adopted by Sir L. Bell for slag being 550 heat units, and for cast iron 330 heat units. It is probable, however, that the former number was over-estimated, as Akerman's researches gave an average value of 388 units, as required for the fusion of slag. This number was obtained as a result of the examination of seventy-four slags, while the lowest

value was 340 units in a somewhat siliceous slag from Vordernberg, in Styria, and the maximum 463 from a titaniferous Swedish slag high in magnesia. It is stated that the melting points of blast-furnace slags range from about 1,100° C. to 1,500° C.*

Limestone.—The limestone which is employed in the blast furnace as a flux should be as free from silica, phosphates, and other impurities as possible. It should contain at least 90 per cent. of calcium carbonate, the residue consisting of carbonate of magnesia together with silica, alumina, and other earthy matters. Limestone which contains any considerable proportion of bituminous matter is unsuitable for use as a flux, as the carbonaceous material is not in a form which admits of ready combustion, and it therefore renders the limestone very refractory in the blast furnace. Dolomite or magnesian limestone usually contains about 55 per cent. of calcium carbonate, 40 per cent. of magnesium carbonate, and 5 per cent. of silica, oxide of iron, and alumina. Slags rich in magnesia are less fusible than those with calcium carbonate alone, and thus lead to a more complete removal of sulphur; for this reason it is not unusual in Cleveland to add a certain proportion of dolomite to the furnace charge.

An analysis of Cleveland limestone made in the Metallurgical Laboratory of Mason College by W. L. Roberts gave the following values:—

Lime,	49·75
Magnesia,	2·08
Carbon dioxide,	41·20
Silica,	5·17
Alumina,	·69
Ferric oxide,	·83
Organic matter,	·20
	99·92

The following analyses of limestone, used for blast furnace purposes, are quoted by H. Pilkington from various sources:—†

	Dudley.	Wenlock.	Froghall.	Welsh.	Derbyshire.
Carbonate of lime,	97·31	91·30	98·44	99·25	98·89
Carbonate of magnesia,	1·00	0·79	0·49	0·41	0·22
Oxide of iron and alumina,	1·89	1·36	0·26	0·10	0·21
Silica,	6·55	0·80	0·10	0·35
Phosphoric acid,	0·04	...	trace	trace
Sulphur,	trace	...	trace	trace
Water,	0·27
Organic matter,	0·01
Alkalies,	0·14	...
	100·20	100·04	100·00	100·00	99·94

* Phillips-Baerman, *Metallurgy*, p. 216. † *S. Staff. Inst.*, Dec., 1887.

The proportion of sulphur in a sample of good limestone is small, and usually does not exceed 0·25 per cent.

Use of Lime in the Blast Furnace.—In some cases the limestone is burnt, or causticised, before being used; this is done to lessen the bulk of materials charged into the furnace per ton of iron produced, while, at the same time, it reduces the waste of coke caused by the reaction between carbon dioxide and the solid fuel, whereby carbon monoxide is produced in the upper parts of the furnace, where it can be of no assistance in promoting reduction. The bulk of the waste gases is proportionally reduced, while by the removal of so much carbon dioxide their quality is improved. Opinions are, however, by no means unanimous in favour of this method of procedure.

Dr. Percy mentions some experiments conducted in the Ural so long ago as 1836, where, by the substitution of lime for limestone, it was stated that an economy of about 2s. per ton of pig iron was obtained. Some experiments in Belgium in 1852 are said to have given an increased yield of 25 per cent. with a diminished fuel consumption when lime was used; these experiments were continued for some years with satisfactory results. At the same period in Silesia the use of lime led to greater yield and diminished consumption of coke, though only to the extent of about 3 per cent. in each of these respects. Quicklime was also used in Wales at Dowlais and Ebbw Vale in 1863; it was stated that the furnaces worked hotter and carried more burden with lime than with limestone, and that there was a saving of expensive fuel in the furnace to the full extent of the cheap fuel used in calcining the lime.* C. Schinz in 1870 also concluded as the result of theoretical investigations that the use of lime was advantageous.†

This question has more recently been examined by C. Cochrane,‡ who, in experiments conducted with Cleveland ore at the Ormesby Iron Works, found that by the substitution of lime for limestone the make per furnace was increased from 2,141 to 2,453 tons of pig iron per month, while the consumption of coke fell from 21·19 to 17·44 cwts. per ton. The weight of the waste gases is less when quicklime is used, since the carbon dioxide of the limestone is eliminated in the lime kiln. In the experiments at Ormesby when limestone was used the waste gases per ton of pig iron made amounted to 146 cwts., containing 27 per cent. of carbonic oxide by weight; while only 113 cwts. containing 26 per cent. of carbon monoxide were produced when quicklime was employed. The materials in the upper part of the furnace are thus exposed to the action of a smaller volume of reducing gases when lime is used, the difference in the case under

* Percy, *Iron and Steel*, p. 518.

† *The Blast Furnace*, p. 151.

‡ *Inst. M. E.*, 1888, p. 589; *Inst. Journ.*, 1889, vol. ii., p. 368.

consideration being as between 39.6 cwts. of carbon monoxide with limestone and 29.7 cwts. with quicklime. In the discussion which followed the reading of this paper Windsor Richards stated that in smelting Cleveland ironstone in large furnaces at Eston, though he had not found any economy to result from the use of quicklime, the yield per furnace had increased about 70 tons per week, and it was pretty generally acknowledged that in small furnaces the use of quicklime is advantageous.

In his discussion of this subject Mr. Cochrane has been careful to point out that there are both advantages and disadvantages in the use of quicklime.* When limestone is used part of the carbon dioxide it contains is converted into monoxide by the coke; this increases the activity of the reducing zone in the upper and cooler region; this cooler region is also extended downwards into the furnace by the absorption of heat due to the reduction of the carbon dioxide. The period of reduction is thus extended, and the reduction of the ore is more complete in the upper parts of the furnace. On the other hand, when lime is used the volume of the reducing zone is diminished, and the quantity of reducing gases is less; hence more of the ironstone passes through the reducing zone without being completely reduced, and carbon dioxide is generated in the lower parts of the furnace. Sir L. Bell has also suggested † that the quicklime charged into the furnace is rapidly converted into carbonate by absorption of carbon dioxide, though, so far as the author is aware, this has not been proved by actual experiment in the blast furnace, while as dry lime has been shown by Velez ‡ to be very inert, and the time of exposure in the furnace is short, it is possible this action is not so great as has been supposed. At all events, it cannot lead to a loss of heat, as the heat liberated by the combination of carbon dioxide and lime would be exactly equivalent to that required for the subsequent decomposition at a higher temperature. Compare Bell, *Principles*, pp. 58-60.

It would appear, therefore, that on the whole the advantages and disadvantages of the use of quicklime are pretty equally balanced, and that, though under special circumstances, as with small furnaces, or when the quantity of the waste gases is unusually great, the use of quicklime may be beneficial, it may be safely assumed that, as the question has been in dispute for more than half a century, and as many cases are recorded where lime has been abandoned in favour of limestone, the advantages are not so great as to be likely to lead to the general adoption of quicklime.

In the latest contribution to this discussion (Iron and Steel Institute, Brussels Meeting, 1894) Sir L. Bell has expressed an

* *Inst. M. E.*, 1888, p. 601.

† *Ibid.*, p. 612.

‡ *Pro. Chem. Soc.*, 1893, p. 114.

opinion which very closely coincides with that just given, while C. Wood states that he has for years calcined limestone and ironstone in a kiln together with marked advantage, and C. Cochrane, in a lengthy contribution based on his own experiments, calls in question the correctness of some of Sir L. Bell's figures, and states that in recent years the use of lime instead of limestone has been adopted on a steadily-increasing scale in Cleveland.*

Smelting of Puddling Cinder.—When forge or mill cinder is employed in the blast furnace for the production of iron, the resulting pig is not only rich in phosphorus, but is often white and hard, containing both sulphur and silicon together in quantity. In ordinary working it is unusual to find both sulphur and silicon together, but these cinders, which consist essentially of ferrous silicate, are very fusible, and are often not completely reduced in passing through the furnace. A very fusible slag is thus produced, and the temperature of the furnace is low; sulphur is then absorbed with the production of a white iron. Silicon is also more easily reduced when the silica is combined with a fusible base, so that the pig is unusually siliceous for the low temperature employed. When the cinders contain much manganese, as is the case in Staffordshire, the sulphur is more completely eliminated, and consequently Staffordshire cinder pig is often low in sulphur, despite the fact that gas coke is used. The low temperature of the furnace and ready fusibility of these cinders can, to a great extent, be remedied by the use of an excess of lime in the furnace burden. Tap cinder is employed on a considerable scale for the production of "basic pig," *i.e.*, pig iron specially prepared for the production of steel by the basic process, and is, on this account, recently in considerably increased demand. The cinder is first calcined in open heaps, and is usually smelted in mixture with other materials, with the addition of considerable proportions of lime. Manganese is usually added to the charge to diminish the proportion of sulphur present in the pig iron, which, as it must contain but little silicon, would otherwise be rich in sulphur. Instead of adding manganese to the furnace charge, the fluid metal may be afterwards desulphurised by the addition of manganese (Massenez' process), or of calcium oxy-chloride (Saniter's process); see pp. 151, 201.

* *Inst. Journ.*, 1894, vol. ii., p. 62.

CHAPTER XI.

THE PROPERTIES OF CAST IRON.

General Properties.—Cast iron consists of metallic iron, together with at least 1·5 per cent. of carbon. It also contains silicon, sulphur, phosphorus, manganese, and other elements in greater or less proportion, but these may be regarded as impurities, though their presence is often useful or even necessary for the purposes for which cast iron is applied. The proportion of elements other than iron is usually about 7 per cent. of the total weight, though this varies considerably, and is sometimes very much more. Cast iron is fusible at a temperature of about 1,200° C.; when cold it is hard and brittle, some varieties being much more so than others; it is not malleable or ductile, like wrought iron or mild steel, nor can it be hardened and tempered like ordinary carbon steel. The iron founder distinguishes between *pig iron*, or the form in which the metal is obtained from the blast furnace, and *cast iron*, or the form it assumes after it has been again melted; but no such difference is recognised by the chemist, and pig iron is merely a variety of cast iron which is produced in a particular form.

Carbon in Cast Iron.—Cast iron, when fused, consists of a saturated, or nearly saturated, solution of carbon in iron. The amount of carbon which molten iron can thus dissolve is about $3\frac{1}{2}$ per cent. of its own weight, though the solubility is largely influenced by the presence of other elements. With much chromium the maximum solubility of about 12 per cent. of carbon is reached; with much manganese, up to 7 per cent. of carbon may be dissolved; while with about 20 per cent. of silicon the minimum solubility of carbon is obtained, and only about 1 per cent. of carbon then dissolves. Apart from special alloys, such as those mentioned, it is very unusual to meet with less than 2 per cent., or more than 4·5 per cent. of carbon in cast iron. Whether the dissolution of carbon in iron is to be regarded merely as a physical action, like that of dissolving salt in water; whether it is simply an example of chemical combination; or a result of both physical and chemical attraction, is at present undetermined. It presents some resemblances to the union between tin and copper, where at least one, and probably two, definite chemical compounds can be recognised, though the alloys which are of practical importance consist of a definite

compound of tin and copper, together with an excess of copper. Similarly, there are observations which point to the existence of a definite iron carbide, or of several carbides, in cast iron, though these carbides are associated with a quantity of free iron. This point will be discussed at length when dealing with carbon in steel.

So long as iron containing some 3 per cent. of carbon remains in the fluid condition, the composition is uniform throughout, and the carbon has no tendency to separate from the metal, except with very grey iron; in this case a layer of graphite, which often occurs in beautiful plates, and is known as *kish*, may be formed. But when molten cast iron is cooled to a temperature at which it begins to solidify, it may either retain the carbon and solidify in a relatively homogeneous form, called *white* iron; or it may, in solidifying, precipitate the greater part of the carbon in the form of small scales of graphite, which, being entangled by, and uniformly distributed through, the iron, impart to it a somewhat spongy nature, and produce the dark colour and soft character met with in *grey* iron. When about half of the carbon is precipitated as graphite, and the rest retained in combination, the result is the production of dark grey portions in a matrix of white, and the iron is then said to be *mottled*.

The condition which the carbon assumes on the solidification of the mass, is dependent partly on the rate of cooling, and still more on the nature and quantity of the associated elements. In connection with the influence of cooling, cast iron obeys the laws which govern other solutions, for it is well known that slow cooling assists the production of crystals, and leads to the formation of crystals of larger size, while with rapid cooling both solvent and the substance dissolved may solidify together. In a similar manner slow cooling tends to produce graphitic carbon, and the slower the cooling the larger are the flakes of graphite which separate. Some kinds of white iron may thus be rendered grey by slow cooling, while some kinds of grey iron may be made perfectly white by rapid cooling or "chilling." It is, however, only with intermediate irons that the rate of cooling produces a marked effect, for irons which are either very white or very grey cannot be changed in this manner. The influence exerted on the condition of the carbon by the other elements present in cast iron is of the greatest importance; thus manganese and chromium, which increase the solubility of carbon in iron, lead to a greater percentage of total carbon in the fluid metal, and when the iron solidifies this carbon is retained in solution, so that irons rich in manganese and chromium are white, and no amount of slow cooling will alter this character. On the other hand, silicon and aluminium diminish the solubility of carbon in iron; if much of either of these elements be present in the fluid metal, it is capable of dissolving less carbon, and retains it with

less energy when it solidifies; as a result the carbon is precipitated as graphite, and grey iron produced. Just as irons which contain much manganese or chromium are permanently white, so metal rich in silicon or aluminium is permanently grey.

Separation of Graphite.—That the carbon which exists in grey iron is in the graphitic form can be proved by many simple tests. Thus, if finely-divided white iron be rubbed between the fingers it is clean to the touch, while grey iron produces a smooth black coating on the skin, exactly like that due to plumbago. It was first shown by G. J. Snelus* that nearly pure graphite can be separated from grey iron by means of a magnet or by careful sifting; and the author has obtained a similar result by washing finely-divided grey iron with water, in which the iron sinks and some of the graphite floats. On dissolving white cast iron in dilute hydrochloric or sulphuric acid the carbon combines with the nascent hydrogen to form ill-smelling hydrocarbons which pass away with the evolved hydrogen; if nitric acid be employed as solvent the combined carbon dissolves in the liquid, producing a deep brown colour, which forms the basis of the Eggertz test for combined carbon. If grey iron be treated with either of the three solvents above-mentioned the carbon remains in the liquid in the form of black flakes; this carbonaceous matter, when purified from silica by treatment with hydrofluoric acid, burns at a red heat without leaving any residue, and exhibits all the other properties of graphitic carbon. In the microscopic examination of grey cast iron also the graphite can be readily observed, and is then seen to be in the form of scales or particles which are quite distinct from the matrix in which they are embedded.

Carbon in Foundry Iron.—The proportion of total carbon in iron to be employed for a given purpose is often of secondary importance; it is governed by furnace conditions, and by the proportion of other elements. A moderate alteration in total carbon, or in the graphite, will frequently have little effect on the physical properties of the product, while a small change in the combined carbon will profoundly alter the strength and hardness of the casting. Probably no other constituent in cast iron is of importance equal to that of combined carbon, and the influence of the other elements is largely due to the effect they produce in increasing or diminishing the combined carbon. The following proportions of combined carbon will usually be found suitable for the purposes specified:—

	Combined Carbon.
Extra soft siliceous grey iron,	0·08
Soft cast iron,	0·15
Maximum tensile strength,	0·47
" transverse " 	0·70
" crushing " 	over 1 00

These figures are, however, subject to some variation according to the size of casting, and the proportion of other elements. The hardness of the metal increases regularly with the increase of combined carbon.

Silicon in Cast Iron.—All cast iron contains silicon, in quantities varying in ordinary cases from under 0.5 to over 4 per cent., while "silicon pig" is made in the blast furnace with from 10 to 18 per cent. of silicon. No factor is of greater importance in determining the suitability of a sample of cast iron for any purpose in the foundry than its content of silicon, as this element is so constantly present, and its proportion is so variable, while the influence it exerts on the condition of the carbon present, and consequently on the hardness and fluidity of the metal, is so marked. It was formerly very generally held that silicon was injurious in all proportions, and the less there was present in iron for foundry purposes the better. It is true that Sefström had observed, long ago, "that the carbon in grey iron, in which much silicon exists, say from 2 per cent. to 3 per cent., is wholly, or nearly so, in the graphitic state.* A similar observation was made by Snelus in 1870, and was still more plainly stated by Ledebur in 1879. It was also known in the United States that certain irons from Ohio, which were rich in silicon, could be used as "softeners" in foundry practice, and certain Scotch irons were in favour for similar purposes, though the reason of this was not understood. It may, however, be claimed that no general application of these facts, or accurate knowledge of the principles underlying them, existed before the researches of the author on the "Influence of Silicon on the Properties of Cast Iron," published in 1885.† For the purpose of these experiments cast iron as free as possible from silicon was specially prepared by heating wrought iron with charcoal to a high temperature in closed crucibles. This was then remelted with a silicon pig containing about 10 per cent. of silicon in proportions necessary to yield any desired composition. The trials were made with sufficient material to allow of proper mechanical tests being performed, and a graduated series of mixtures was prepared. The tensile, compression, and ductility tests were performed by Professor A. B. W. Kennedy with the testing machine at University College, London, while the hardness determinations were performed by the author with a weighted diamond point, as described in his paper on the "Hardness of Metals."‡ The chemical analyses were checked by J. P. Walton, at that time chemist to the Glasgow Iron Company, Wishaw.

The original pure cast iron was white, hard, and brittle; on

* Percy, p. 131.

† *Journ. Chem. Soc.*, 1885, pp. 577, 902.

‡ *Birm. Phil. Soc.*, Dec., 1886.

EFFECT OF SILICON ON THE PROPERTIES OF CAST IRON.

Silicon per cent. (calculated).	Relative Density at 20° C. (Water at 20°=1.)		Relative hardness.	Tensile Strength = per Square Inch.		Modulus of Elasticity.	Crushing Strength per Square Inch.		Calculated Transverse Strength. Bars 1 foot long, 1 inch square, loaded in the centre.	CHEMICAL ANALYSES.							
	Cylinders.	Turnings.		Lbs.	Tons.		Lbs.	Tons.		Total Carbon.	Graphite.	Combined Carbon.	Silicon.	Phosphorus.	Manganese.	Sulphur.	
																	Lbs.
0	7.560	7.719	72	22,720	10.14	25,790,000	168,700	75.30	2,702	1.206	1.98	0.38	1.60	0.19	0.52	0.14	0.05
0.5	7.510*	7.670	52	27,580	12.31	28,670,000	204,800	91.42	3,280	1.464	2.00	0.10	1.90	0.45	0.33	0.21	0.05
1	7.641	7.630	42	28,490	12.72	31,180,000	207,300	92.54	3,370	1.504	2.09	0.24	1.85	0.96	0.33	0.26	0.04
1.4	7.555	7.473	...	31,440	14.04	23,500,000	183,900	82.08	3,498	1.561	2.21	0.50	1.71	1.37	0.30	...	0.05
2	7.518	7.350	22	35,180	15.70	23,560,000	137,300	61.29	3,446	1.538	2.18	1.62	0.56	1.96	0.28	0.60	0.03
2.5	7.422	7.388	22	32,760	14.62	25,450,000	172,900†	77.18†	3,534†	1.577†	1.87	1.19	0.68	2.51	0.26	0.75	0.05
3	7.258	7.279	22	27,390	12.23	21,150,000	128,700	57.45	2,850	1.272	2.23	1.43	0.80	2.96	0.34	0.70	0.04
4	7.183	7.218	27	25,280	11.28	15,640,000	106,900	47.74	2,543	1.185	2.01	1.81	0.20	3.92	0.33	0.84	0.03
5	7.167	7.170	32	22,780	10.16	18,720,000	103,400	46.16	2,342	1.046	2.03	1.66	0.37	4.74	0.30	0.95	0.05
7.5	7.128	7.138	42	11,950	5.34	14,750,000	111,000	49.55	1,505	0.672	1.86	1.48	0.38	7.33	0.29	1.36	0.03
10	6.978	6.924	57	10,630	4.75	13,930,000	76,380	34.10	1,252	0.559	1.81	1.12	0.69	9.80	0.21	1.95	0.04

* This number is rather low, as the specimen afterwards proved to be somewhat faulty.
 † The value in this case is probably exceptionally high; a crushing strength of about 60 tons might be anticipated from its position in the series.

adding silicon this became grey, soft, and strong; but with a large excess of silicon it once more became weak and hard. The

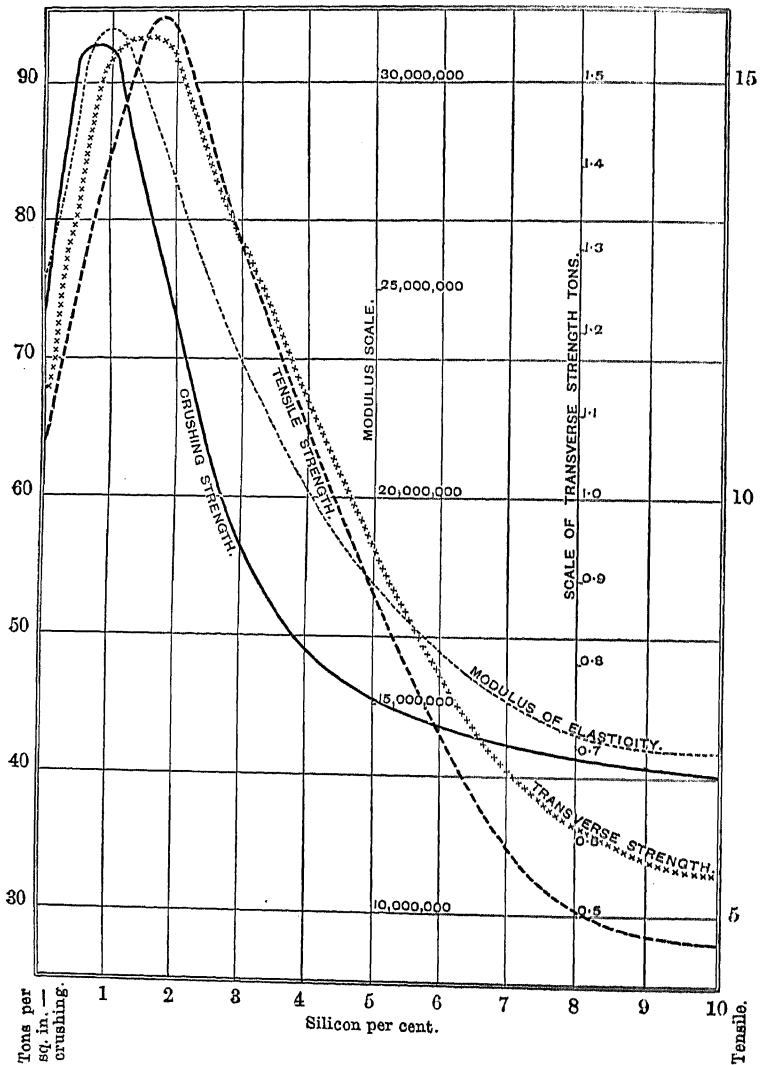

Fig. 45.—Influence of silicon on the strength of cast iron.

results of the mechanical and chemical tests are given in the accompanying table, and are represented graphically in Figs.

45, 46, and it will be observed that the proportions of silicon corresponding to the various properties were as follows:—

Maximum hardness,	under 0·80 per cent.
Crushing strength,	about 0·80 „
Modulus of elasticity,	„ 1·00 „
Density, in mass,	„ 1·00 „
Combined crushing and tensile strength; transverse strength,	}	„ 1·40 „
Tensile strength,	„ 1·80 „
Softness and working qualities,	„ 2·50 „
Lowest combined carbon,	under 5·00 „

It must be borne in mind that these values are only true for the author's experiments. Experience has since proved that these are approximately correct in other cases, and that the order is as above given, but in practice the size of the casting and the

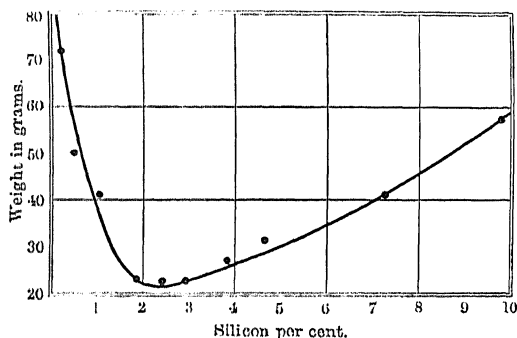

Fig. 46.—Influence of silicon on the hardness of cast iron.

proportion of other elements will have an important influence. These matters are dealt with briefly in the author's papers on the "Constituents of Cast Iron"* or "Scientific Iron Founding,"† and in Chapter XII. of the present volume.

Silicon in Foundry Practice.—Shortly after the author's experiments on the influence of silicon on the properties of cast iron were published, the question was re-investigated by W. J. Keep, of Detroit, Mich., who employed the system of testing which he originated, known as "Keep's tests," and which will afterwards be described. This most careful and experienced foundry manager confirmed the accuracy of the author's conclusions, and pointed out that a white iron frequently does not give sound castings, and the blowholes lead to lower specific gravity and diminished strength. A small addition of silicon eliminates blowholes and produces sound castings. As soon as the metal is sound, with the least graphite, the greatest crushing

* *Inst. Journ.*, 1886, vol. i.

† *S. Staff. Inst.*, March, 1887.

strength is obtained; this condition also gives the maximum density. Further addition of silicon leads to the formation of graphite, diminishes the brittleness, and gives the greatest transverse and tensile strength. When the graphite increases beyond this point the metal is divided by the interspersed graphitic material, and the strength and hardness decrease. The deflection also increases with the increase of graphite, but when the maximum separation of graphite has taken place any further addition of silicon causes stiffness or brittleness, and so diminishes the deflection. White iron shrinks during solidifying more than grey iron, while highly siliceous iron shrinks still more than white. Hence, on adding silicon to white iron the shrinkage is diminished, but an excess of silicon, on the other hand, leads to increased shrinkage. Shrinkage appears to closely follow the hardness of cast iron, hard irons almost invariably shrinking most, and as both hardness and shrinkage depend upon the proportion of combined carbon they may be regulated by a suitable addition of silicon.*

Economical Use of Silicon.—In the author's early experiments silicon was added in the form of ferro-silicon containing about 10 per cent. of silicon, as this was the most convenient method of procedure. But when the same principles came to be applied on the large scale it was found that ferro-silicon was too expensive, and other irons were, therefore, substituted. In Scotland the author used a 5 per cent. iron from the West of Scotland, and in the Midlands a 4.5 per cent. from Northamptonshire; while in Cleveland C. Wood employed a 4.5 per cent. Cleveland pig. On the other hand, in France F. Gautier used ferro-silicon, and the relative advantages of the two methods gave rise to considerable discussion on the Continent and in America. W. J. Keep showed in a paper on "Ferro-silicon and Economy in its use"† that in America there was no commercial advantage in the use of rich ferro-silicon, while H. Paul also stated that in Germany, especially in the eastern divisions of the Empire, ferro-silicon cannot be used economically, as the foundry pig iron of Silesia can be obtained with as much as 5 per cent. of silicon at a low price,‡ and experiments conducted by Jüngst have led to the same conclusion.§

The practical application of silicon in the iron foundry is due chiefly to C. Wood, of Middlesbrough, who was working in this direction with J. E. Stead in 1885, when the author's experiments on the subject were published, and who himself contributed an important paper on "The Value of Silicon Pig to the Iron-

* *Amer. Inst. Min. Eng.*, 1888.

† *Ibid.*, Oct., 1888.

‡ *Inst. Journ.*, 1887, vol. ii., p. 293.

§ See article "Employment of Ferro-silicon," *Colliery Guardian*, vol. lxiii., p. 740.

founder" at the Glasgow meeting of the Iron and Steel Institute a few months afterwards. This was succeeded by a paper by F. Gautier on "Silicon in Foundry Iron," at the next spring meeting, when it was shown that in France a very considerable application of these facts had already been made. It is perhaps not too much to claim that the author's experiments laid the basis for the introduction of those scientific methods of iron-founding, which have since been largely adopted throughout the civilised world.

Condition of Silicon in Cast Iron.—Silicon, like carbon, is known to exist in two, if not in three, allotropic conditions, and it has been asserted by various observers that in cast iron silicon exists sometimes in the amorphous or combined condition, while at other times it separates in the form of scales corresponding to graphitic carbon. Wöhler is stated to have separated graphitic silicon from cast iron,* and a similar result was said to have been obtained by R. Richter,† and by Dr. Percy.‡ On the other hand, G. J. Snelus,§ though able to separate graphitic carbon from grey cast iron by sifting, failed to separate graphitic silicon, while Morton|| and Dr. Tilden,¶ by other methods, also failed to isolate silicon in the graphitic state. The black scales separated by Richter were shown by Hahn** to be most probably iron silicide (FeSi_2), while, through the kindness of Dr. Percy, the author had the opportunity of examining the specimen upon which this eminent metallurgist's opinion was based, and it was proved that the black scales really consisted of graphitic carbon. The question has been considered at length by A. E. Jordan and the author,†† and, as a result of the careful analyses of a number of samples containing up to 10·3 per cent. of silicon, it was concluded that, in all the specimens examined, no proof of the existence of graphitic silicon was found, and it is now generally acknowledged by metallurgists that graphitic silicon does not occur in cast iron. There is still, however, much uncertainty as to the cause of the "blazed" or "glazed" appearance of iron containing upwards of 4 per cent. of silicon. With about this percentage some samples are perfectly grey and soft, while others of precisely the same ultimate chemical composition are glazed and brittle, and it is suggested that this difference is due to some variation in the condition of the silicon, though there is at present little known as to the probable nature of this supposed variation.

It has been shown by Mulhaeuser, and also by Moissan,‡‡ that

* *Jahresbericht*, 1857, vol. iii., p. 8. † *Berg. u. Hutt. J.*, 1862, p. 289.

‡ *Iron and Steel*, p. 164. § *Inst. Journ.*, 1870, p. 28.

|| *Chem. News*, vol. xxix., p. 107. ¶ *Birm. Phil. Soc.*, vol. iii., p. 203.

** *Ann. Chem. u. Pharm.*, vol. cxxix., p. 57.

†† *Journ. Chem. Soc.*, vol. xlix., p. 215.

‡‡ *Journ. Chem. Soc.*, vol. lxvi., II., p. 42.

silicon and carbon combine when strongly heated, to form a silicon carbide, with the formula SiC. This carbide is also obtained by heating iron silicide in the electric furnace with excess of silicon, and forms colourless crystals, which act powerfully on polarised light, and which are not affected by ordinary acids, or by heating to redness in air or oxygen. The carbide can also be obtained as an amorphous, colourless powder, which is slowly oxidised when heated in air. Different observers have noticed peculiar colourless or nearly colourless crystals when viewing microscopic sections of iron and steel, and, following Sorby, have regarded these as crystalline forms of silicon. The composition of these crystals is, however, as yet undetermined, and they are more likely to be a silicide of carbon or of iron than silicon itself.

Distribution of Silicon.—An interesting series of experiments on the variations in the silicon percentages of different samples of pig iron from the same cast has been more recently made by H. Rubricius (*J. S. C. I.*, 1894, p. 889), who points out that the proportion of silicon is usually lowest in that part of the metal which is nearest to the bottom of the hearth while fluid in the blast furnace. The iron which is nearest to the slag hole, on the other hand, is richer in silicon, the difference being in some cases as much as 1 per cent. Sulphur and phosphorus do not vary in the same manner; the result in the product being that silicon varies somewhat from pig to pig, being generally lowest in the first pigs cast, and highest in those which are produced at the end of a tapping: sulphur, on the other hand, varies in different parts of the same pig, as shown by Stead (see p. 202); while phosphorus is generally much more uniformly distributed. The following figures are given by Rubricius:—

PERCENTAGES OF SILICON IN SAME TAPPING, NUMBERED
FROM BELOW UPWARDS.

No. of Test.	1 (Bottom).	2.	3.	4.	5.	6.	7 (Top).	Maximum Difference.
1, . . .	1·13	1·15	1·15	1·19	1·33	1·40	1·42	·29
2, . . .	1·38	1·44	1·45	1·60	1·63	1·72	1·79	·41
3, . . .	1·15	1·34	1·43	1·57	2·17	2·18	2·20	1·05
4, . . .	1·49	1·50	1·54	1·66	1·82	1·84	1·88	·39
5, . . .	1·95	2·09	2·13	2·45	2·70	2·72	2·76	·81
6, . . .	1·81	1·83	1·84	1·86	1·89	2·16	2·20	·39
7, . . .	2·72	2·74	2·77	2·79	2·85	2·88	2·89	·17
8, . . .	2·46	2·48	2·50	2·53	2·54	2·58	2·60	·14

Aluminium.—Although in many early analyses of cast iron aluminium is stated to have been present, and various patents

have been granted for the reduction of aluminium in the blast furnace from aluminous materials, it is now generally accepted that at most merely the slightest trace of metallic aluminium is so reduced, and passes into the iron. The analyses previously mentioned were, therefore, incorrect, and the patents worthless. Ferro-aluminums containing 5, 10, 20, or other percentages of aluminium, are prepared by melting the materials in crucibles, or by the use of the electric furnace; they can now be regularly purchased, of uniform composition, and are employed for steel melting to give soundness to the ingot, and in the foundry to produce soft, grey castings. Ferro-aluminium has a close-grained, grey fracture, and is not appreciably harder than the iron from which it is prepared. In the foundry its influence is almost precisely the same as that of silicon, except that its action is much more energetic, only 0.1 per cent., or even less, remaining in the product, being sufficient to render the metal soft and grey. The use of aluminium for foundry purposes has been carefully studied by W. J. Keep,* who states that the addition of aluminium increases the proportion of graphitic carbon, and so diminishes the tendency to chill; it also diminishes the shrinkage and increases the strength, especially as regards resistance to impact. The soundness and density of the castings are also improved. In spite of these advantages, however, aluminium has only met with a limited application in the foundry for the following reasons:—

1. The cost is increased, as the necessary softness can also be obtained by means of silicon without any additional expense.

2. The amount of aluminium required is so small, and its effect so marked, that the presence of rather more oxygen than usual in the metal may lead to great irregularities in the product, as little or no aluminium may remain in the castings.

3. Metal containing aluminium is less fluid than ordinary cast iron, and as it flows through the mould appears to have a skin upon its surface which prevents its filling the crevices. This surface tension causes the metal to solidify in large spherical drops, and where two currents of fluid metal meet in the mould they are apt to form "cold shuts," or fail to unite.

4. The surface skin is apt to break away in the form of scum, and to form irregular patches on the surface of the castings.

It must also be remembered that it is only to white iron, or other metal low in silicon, that aluminium can be added with advantage; as in other cases, where the quantity of graphite is already large, the addition of aluminium only leads to a further separation of graphite, and the consequent weakening of the metal. According to Keep, it is better to add aluminium in the metallic form in the ladle and to pour the fluid cast iron upon it, as when ferro-aluminium is used it is apt to float to the top

* *Inst. Amer. Min. Eng.*, 1890.

of the metal and become covered with a crust which prevents their fusion and admixture. The general correctness of Keep's observations on the influence of aluminium on cast iron have been confirmed by Borsig and Ledebur, who point out the marked difference in the action of aluminium when added to cast iron and to steel respectively.*

Sulphur.—The presence of sulphur in cast iron tends to cause the carbon to assume the combined form, and thus to produce hard, weak, and brittle metal. Such iron is also unsuitable for puddling and for steel making, so that hitherto sulphur has been regarded as a specially objectionable element. Foundry iron of good quality should not contain more than 0.15 per cent. of sulphur.

Of the sulphur which is charged into the blast furnace as an impurity in the fuel, ore, or limestone the greater part passes into the slag, or is eliminated in the furnace gases, and it is estimated that in ordinary Cleveland practice, when producing grey iron, quite nineteen-twentieths of the sulphur is thus removed. The amount absorbed by the iron varies according to the furnace conditions, low temperatures and acid slags leading to the absorption of sulphur, and, as the silicon is also low, to the production of white iron. On the other hand, high temperatures and slags rich in lime and of high melting point, lead to the elimination of sulphur. Temperature is thus of the very greatest importance in determining the proportion of sulphur in a sample of pig iron. In addition, however, to the conditions of furnace working, there is another circumstance which largely affects the content of sulphur, namely, the composition of the resulting pig iron itself. It is known that, in the act of solidifying, grey iron rich in sulphur frequently becomes covered with protuberances, which consist either of sulphide of iron or of iron abnormally rich in sulphur. These curious exuded portions have been examined and described by Sir F. Abel, A. Ledebur, the author, and others, and appear to be connected with the composition of the mass of the metal. The author has shown that in a specially-prepared specimen which contained 10 per cent. of silicon and 10 per cent. of sulphur, the material separated into two distinct layers when remelted, the greater part of the silicon being found at the bottom, while the sulphur collected chiefly at the top.†

It thus appears that, under ordinary conditions, it is not possible to have more than a few tenths per cent. of sulphur in a sample of cast iron which also contains upwards of 3 per cent. of silicon. This fact has led W. J. Keep, in a paper on "Sulphur in Cast Iron," † to contend that sulphur does not produce whiteness in cast iron in ordinary foundry practice. The author's

* *Inst. Journ.*, 1894, p. 737. † *Ibid.*, 1888, vol. i., p. 28.

‡ *Amer. Inst. Min. Eng.*, Aug., 1893.

experiments have, however, led him to strongly support the common view, that sulphur does lead to the production of combined carbon in pig iron, and the conclusions of Mr. Keep are probably only correct in cases where a considerable proportion of silicon is present, and where, consequently, little sulphur can be absorbed, while the effect of that which is so taken up is counteracted by the silicon present. In irons which contain less silicon, and where the equilibrium of the carbon is more easily affected, the addition of only 0.05 per cent. of sulphur may quite spoil the metal for special purposes on account of the increased combined carbon, and consequently greater hardness and brittleness.

But while the presence of silicon causes the incomplete expulsion of sulphur in the form of iron sulphide, which is extruded as above described, manganese leads to the much more perfect removal of sulphur, which is eliminated in the form of manganous sulphide (MnS); this floats to the surface of the molten iron, and forms part of the slag which collects at the top of the metal. This fact, which has been long observed, forms the basis of the process of sulphur elimination recently patented by Massenez, in which manganese is added to molten iron rich in sulphur, which is thus purified and rendered suitable for the use of the steel maker (see p. 251).

Removal of Sulphur by Alkalies.—Reference has already been made, when discussing the reactions of the blast furnace, to the partial elimination of sulphur in molten iron, due to the presence of a basic or alkaline slag. It was shown by Ball and Wingham* that the addition of about 10 per cent. of potassium cyanide to molten iron containing 0.46 per cent. of sulphur, eliminated practically the whole of this objectionable element. The volatility and poisonous character of the cyanide would prevent such a process from being practically applied, so other experiments were tried, in the course of which it was proved that sodium carbonate alone diminished the sulphur, though not to less than 0.15 per cent., while the addition of 2 per cent. of a mixture of equal quantities of sodium carbonate and potassium cyanide eliminated all but 0.06 per cent. of sulphur. These experiments, though throwing light on the removal of sulphur, and proving the importance of a fluid basic substance, did not lead to commercial results. The solution of the problem was supplied by E. H. Saniter,† who employed quicklime, to which was added crude calcium chloride, obtained as a bye-product from certain chemical works, in order to produce a mixture which would be cheap, basic, and readily fusible. The process has been successfully employed on a considerable scale, especially for the purification of iron to be used for the basic process. As this iron is low in silicon it is apt to be sulphury unless man-

* *Inst. Journ.*, 1892, vol. i., p. 102.

† *Ibid.*, 1892, vol. ii., p. 216.

ganese be present, but, by the subsequent treatment by Saniter's process, iron may be employed which has been made without special additions of manganese ore in the furnace, and thus cinder pig and similar materials become available for steel making. Saniter's process has been studied in detail and favourably reported upon by Stead, and also by Snelus.*

Distribution of Sulphur in Cast Iron.—It is important to observe that the sulphur present in pig iron is often irregularly distributed through the mass, as this fact accounts for some of the discrepancies observed in analyses. Thus J. Addie, of Langloan, observed that certain pigs which had a peculiar appearance in the centre, contained more sulphur in that portion, and the sulphury part did not extend more than 3 inches in the length of the pig,† and the author has observed spangles of a peacock hue in the centre and upper portions of a sample of pig iron selected by H. Pilkington, and these spangles were very rich in sulphur. The question has been more recently examined by J. E. Stead,‡ who took drillings from various parts of two pig irons—one a basic iron containing rather more than 2 per cent. of manganese, and the other a hematite iron containing but little manganese. In the first case the sulphur was in largest proportion in the upper and outer parts of the pig, as cast, while the bottom part contained less than half of the proportion of sulphur occurring in the top corners of the pig. In the hematite iron, on the other hand, an almost exactly opposite effect was observed, as the sulphur was concentrated more in the middle of the sample, while the bottom and sides contained in round numbers only half as much sulphur as was found in the centre.

Phosphorus in Cast Iron.—The phosphorus which is present in cast iron exists in the form of phosphide, and is in great part eliminated with the excess of hydrogen as phosphorated hydrogen, when the metal is treated with diluted sulphuric or hydrochloric acid. For many purposes, such as the manufacture of steel by either of the acid processes, or the production of wrought iron for conversion into tool steel, it is of prime importance that the proportion of phosphorus should be as low as possible, and the maximum limit for such purposes is 0.06 per cent. It was formerly held that foundry iron should also be free from phosphorus, but the author has shown that cast irons of special strength always contain a moderate proportion of this element. If a large proportion of phosphorus be present, such as from 2 to 5 per cent., the metal is very fluid when melted, and takes an excellent impression of the mould. On this account such iron is sometimes employed for the production of very fine thin castings, but it cannot be used for any purpose

* *Inst. Journ.*, 1893, vol. i., pp. 67, 77.

† Kohn, *Iron Manufacture*, p. 34.

‡ *Inst. Journ.*, 1893, vol. i., p. 72.

where strength is required, as the presence of so much phosphorus induces great brittleness. The brittleness caused by phosphorus is so marked that a practical man can often approximately tell the percentage of phosphorus by the readiness with which the pig iron fractures when dropped on the pig breaker. On the other hand, grey pig iron containing merely a trace of phosphorus, such as that from the best hæmatite or magnetite ores, is so soft and malleable as to be somewhat wanting in strength and soundness, and hence gives inferior results for rolls, columns, girders, and other purposes for which strength is necessary. In exceptional cases it is advantageous to have the phosphorus as low as 0.2 per cent. in cast iron, but it is doubtful whether there is ever any advantage in going below this limit. For ordinary strong castings of good quality about 0.55 per cent. of phosphorus gives excellent results, and this proportion is about the same as that found in Staffordshire All Mine and other similar irons which have in times past been held in such high reputation for foundry purposes. For the general run of foundry practice, where fluidity and softness is of more importance than strength, from 1 to 1.5 per cent. of phosphorus may be allowed, but beyond this higher limit, which is that of Cleveland iron, the further addition of phosphorus causes such marked brittleness as to lead to marked deterioration.

Phosphorus appears to have but little effect on the condition of the carbon in pig. It is true that common cinder pigs, rich in phosphorus, are often white, but this is accounted for by the composition of the metal in other respects, and in ordinary irons there is no reason to believe that phosphorus leads to the production of combined carbon. It does, however, lead to the metal becoming slightly harder, as phosphorus induces hardness *per se*, and also diminishes the dark grey colour of the fracture, which is so characteristic of foundry irons of special quality, and leads to the production of a greyer or more earthy appearance.*

Phosphorus in Foundry Practice.—The influence of phosphorus on cast iron has been carefully studied by W. J. Keep,† who prepared a phosphide of iron containing about 10 per cent. of phosphorus by melting wrought-iron drillings with red phosphorus. Several grey and white irons were also selected, in which other elements were, as far as possible, constant, while the phosphorus varied.

In this way series of tests were made with metal which was either white or grey as desired. These experiments led to the conclusion that phosphorus exerts no influence in changing combined carbon to graphite, or *vice versa*; it does, however, lessen the tendency to form blowholes, and causes the metal to remain fluid longer when melted, but does not make the molten metal

* Compare Kjellberg, *J.S.C.I.*, vol. xii., p. 604.

† *Amer. Inst. Min. Eng.*, Oct., 1889.

so limpid as has been supposed. Though the phosphorus does not alter the quantity of combined carbon, or the greyness of the iron, it leads to the production of a lighter colour, and in each phosphorus series, in these experiments, the colour became lighter with every addition of phosphorus. It also lessens the shrinkage and prolongs the period of fluidity. Probably no element, of itself, weakens cast iron so much as phosphorus, especially when present in large quantities; yet, with less than 1 per cent., its influence in this direction is not sufficiently great to counterbalance its other beneficial effects. In conclusion, Mr. Keep supports the view advanced by the author that, in ordinary foundry practice, phosphorus is beneficial, but adds, that usually "from 0.5 to 1 per cent. will do all that can be done in a beneficial way, and that all above that amount weakens the iron without corresponding benefit. It is not necessary to search for phosphorus, most irons contain more than is needed, and the care should be to keep it within limits."

Manganese.—The proportion of manganese which is met with in iron produced in the blast furnace ranges from a mere trace to upwards of 86 per cent., and, speaking generally, the higher the percentage of manganese the more valuable is the product, on account of the use of this element by the steel-maker. The physical properties of cast iron are not greatly altered so long as the manganese present does not much exceed 1 per cent., and larger proportions may be present in siliceous iron without producing the appearance in the fracture which is so characteristic of manganese. When about 1.5 per cent. of manganese is present the iron is very appreciably harder to the tool, and is more suitable for smooth or polished surfaces. But when the amount of silicon is relatively small, and the manganese exceeds 1.5 per cent., a white iron is obtained with a glistening fracture showing flat crystalline plates, which, when very marked, leads to the application of the name "spiegel-eisen" or mirror iron, and which is too hard to be cut by cast-steel tools. Spiegel-eisen contains up to 20 per cent. of manganese, but with higher proportions the grain becomes once again uniformly close and granular, and a material is obtained which exhibits a characteristic light grey colour, and which is so brittle that it may be readily pounded in an iron mortar. To these varieties the term "ferro-manganese" is applied; while for some purposes an iron rich in both silicon and manganese, containing, for example, 10 per cent. of silicon and 20 per cent. of manganese, is produced, and is known as "silicon-spiegel" or "silicon ferro-manganese."

From the examination of the tests conducted at Woolwich in 1858,* and numerous analyses of selected samples of cast iron of special strength, the author concluded that the presence of some manganese was rather beneficial than otherwise in foundry

* *Report, Cast Iron Experiments, 1858.*

practice, though probably any benefit ceases when the proportion of manganese is much greater than 1 per cent.* The good effect of manganese appears to be twofold; by its own action it leads directly to a measure of hardness and closeness of grain which is beneficial, while indirectly it is useful in preventing the absorption of sulphur during re-melting.

The subject has been carefully studied by W. J. Keep,† who states that the addition of manganese to cast iron renders it less plastic, and consequently more brittle; it also increases the shrinkage during cooling, though the effect of manganese can, to a great extent, be neutralised by the addition of silicon. Mr. Keep states that in some of his experiments an increase of 1 per cent. of manganese led to an increase of hardness of about 40 per cent., and this hardness appeared to be due to the action of the manganese itself, and not to an indirect effect caused through an alteration in the amount of the combined carbon.

The effect of manganese when alone is thus always to harden cast iron, and yet cases have come under the author's notice in which in actual practice ferro-manganese has been added in small quantity to molten metal in a foundry ladle, with the result that the iron has been very much softened and improved. The reason for this doubtless lies in the fact that manganese counteracts the effect of sulphur and silicon, tending to eliminate the former and neutralise the latter, and so, where common iron is employed, it sometimes happens that ferro-manganese may be used as a softener. The hardness, however, generally returns if the iron be remelted, as the manganese is oxidised and more sulphur absorbed.

Manganese has in this way been employed as a softener by A. E. Outerbridge, who, in a paper on the relation between the physical and chemical properties of cast iron, states that a remarkable effect is produced on the properties of hard cast iron by adding to the molten metal, a moment before pouring it into the mould, a small quantity of powdered ferro-manganese, say 1 lb. of the latter to 600 lbs. of cast iron. As a result of several hundred carefully conducted experiments this writer states that the transverse strength was increased 30 per cent., the shrinkage and depth of chill decreased about 25 per cent., while the combined carbon was diminished by about one-half.‡ These observations accord with those made at Smethwick by the author, though in all probability their success depends, as above explained, on the peculiar composition of the cast iron used.

Chromium in Cast Iron.—Chromium was discovered by Vauquelin in 1798. It does not occur native, but has been met with in meteoric iron, and is not uncommonly present in small

* *Inst. Journ.*, 1886, vol. i., p. 185.

† *Amer. Inst. Min. Eng.*, 1892.

‡ *Trans. Franklin Inst.*, Feb., 1888.

quantities in ordinary iron ores, from which it passes into the resulting pig iron. In a number of samples of pig iron from various sources in the United Kingdom, J. E. Stead* found a maximum of 0.12 per cent. of chromium in a sample from Holwell, while the minimum was 0.008 from Forest of Dean hæmatite pig. The influence of such small quantities of the element on the properties of the pig iron is probably negligible. Chromium is eliminated during the puddling process, and passes into the cinder; Stead found that a sample of pig iron which contained 0.057 per cent. of chromium yielded a puddled bar with only 0.004 per cent., while the cinder contained 0.290 per cent. Chromium is also oxidised in steel making, though to a smaller extent. In the basic Bessemer process a sample of pig iron, which contained 0.035 per cent. of chromium, yielded a steel with 0.018 per cent., while the chromium in the slag increased from 0.038 to 0.1 per cent.

For special purposes rich alloys of iron and chromium, known as "ferro-chromes," are specially prepared, and these contain up to 84 per cent. of chromium. The commercial source of these alloys is chrome iron ore, and alloys containing from 40 to 70 per cent. of chromium are prepared by reducing the ore in crucibles, while ferro-chromes containing up to 40 per cent. are produced in the blast furnace by the use of rich ores, high temperatures, and very hot high-pressure blast. The fuel used is coke, and the weight of fuel employed is about three times as much as is needed with ordinary iron. The ore contains about 50 per cent. of chromic oxide (Cr_2O_3), and as this is very infusible special fluxes are added, such as fluorspar, alkaline carbonates, and borax.

In order to obtain fluid ferro-chrome the reduction of the oxide must be as nearly as possible complete, for if only 5 per cent. of oxide of chromium is present in the slag, the metal is not sufficiently fluid to flow from the furnace, and the slag is then usually of a yellowish-brown colour. In the production of ferro-silicon and ferro-manganese, on the other hand, the slag always retains a considerable quantity of silicon or of manganese in the oxidised condition.

Though ferro-chrome is more refractory than ordinary cast iron, it is very fluid when well melted; it does not scintillate like ordinary iron, but runs "dead," and very rapidly solidifies. Chromium increases the solubility of carbon in iron in a remarkable manner, as much as 12 per cent. of carbon being sometimes met with in chrome pig, and the whole of this is in the combined form. Chromium, therefore, renders iron hard, white, and brittle, behaving in an exactly opposite manner to silicon or aluminium. Chromium also does not confer soundness in foundry work like the elements just named, and despite the

* *Inst. Journ.*, 1893, vol. i., p. 168.

high temperature employed in its production, ferro-chrome may contain relatively large proportions of sulphur. Ferro-chromes containing up to 30 per cent. of chromium are readily attracted by the magnet, but with more chromium the magnetic properties become less marked, and with high chromium, together with much carbon, the metal is not attracted by the magnet except when in the form of fine powder. The fracture of low ferro-chrome, if rapidly cooled, closely resembles that of spiegel-eisen; but with much chromium a very characteristic appearance is developed, the chief peculiarity being a marked acicular (*i.e.*, needle-shaped) structure.* Behrens and Van Linge have shown that ferro-chromium, when etched with an acid, yields non-magnetic, bayonet-shaped crystals, which have a hardness of 7·5, and which consist of chromium ferro-carbide.† H. Moissan has also prepared carbides of chromium, which are stated to be harder than quartz.‡ As the exceptional hardness of ferro-chromium is due to the formation of these crystals of carbide, the hardness is greater as the carbon and chromium increase.

Ferro-chrome is unsuitable for ordinary foundry purposes, and can only be used in the forge in mixture with other irons, as when much chromium is present it is oxidised early in the puddling process, and renders the slag highly refractory. This causes the slag to thicken, and by adhering to the iron in subsequent operations, produces a variety of red-shortness and a dirty iron. According to E. Riley, the presence of a small quantity of chromium in puddled bar does not appear to have any marked influence on its physical properties.

The following analyses of ferro-chromes, which are stated to have been produced in the blast furnace at Boucau, and to contain an average of 0·06 per cent. of phosphorus and only 0·01 of sulphur, are introduced to illustrate the manner in which the percentage of carbon increases with the proportion of chromium:—§

	1.	2.	3.	4.	5.	6.	7.
Chromium, . . .	44·80	51·10	55·50	57·96	60·35	63·10	65·20
Iron,	45·00	39·10	34·20	30·35	28·10	25·38	21·90
Carbon,	8·50	8·75	9·10	9·38	9·55	10·05	11·80
Silicon,	·40	·32	·56	·45	·60	·40	·38
Manganese, . . .	·40	·40	·35	·50	·45	·42	·38

Vanadium invariably accompanies chromium in pig iron, and is present usually to the extent of not more than 0·2 per cent. ||

* R. A. Hadfield, *Inst. Journ.*, 1892, vol. ii., p. 49.

† *Journ. Chem. Soc.*, 1894, vol. iii., p. 452. ‡ *Ibid.*, p. 453.

§ *Inst. Journ.*, 1891, vol. i., p. 364.

See E. Riley, *Journ. Chem. Soc.*, vol. xvii., p. 21.

Its action has not been accurately determined, but it appears to resemble phosphorus in some of its properties, and is usually present in the slag from the basic process.* As it occurs in small quantities, and is removed by oxidation like chromium, it is probable that the proportion usually met with is not injurious to iron for forge, foundry, or steel-making purposes.

Reduction of Titanium.—In the blast furnace only a portion of the titanium which is present in the charge is reduced and passes into the iron. In this respect titanium resembles silicon; and white pig irons, which contain little silicon, are free from titanium, while the largest proportion of titanium is found in very grey irons. Titanic ores are much more difficult to smelt than siliceous ores, owing to the infusible nature of titanitic slags. According to A. J. Rossi,† however, the choice of fluxes determines the successful treatment of titaniferous ores. This writer gives the following analysis of an ore used in Norway, and of the slag produced when smelting this ore, to prove that with suitable fluxes even large proportions of titanitic oxide can be smelted in the blast furnace:—

	Ore.	Slag.
Ferrous oxide,	30·00	1·86
Ferric oxide,	18·59	
Silica,	5·70	27·83
Titanic anhydride,	39·20	36 18
Lime,	24·36
Alumina,	2·89	9·18

In this case all the titanium was fluxed into the slag, except some 1 per cent. which was reduced and passed into the iron: there was, therefore, no trouble with scaffolding, as is so often the case with titaniferous ores.

A curious compound is frequently met with in the bears of furnace smelting ores which contain a small proportion of titanium. It is known as *cyano-nitride of titanium*, and occurs in small cubes which have a metallic lustre and bright red colour, so that the compound in appearance almost exactly resembles bright metallic copper. It was first examined by Wollaston in 1822, and an analysis by Wöhler gave the following result:—‡

Titanium,	77·26
Nitrogen,	18·30
Carbon,	3·64
Graphite,	0·92
	<hr/>
	100·12
	<hr/>

* Stead, *Inst. Journ.*, 1887, vol. i., p. 222; 1893, vol. i., p. 170.

† *Inst. Journ.*, 1890, vol. ii., p. 748. ‡ Percy, *Iron and Steel*, pp. 163, 510.

The proportion of titanium which is met with in ordinary cast iron is generally small, and it is doubtful if it exerts any injurious effect even when in sufficient quantity to be recognised by the difference in the appearance of the fracture.

A sample of grey pig iron produced at Earl Dudley's furnaces with an ore mixture containing titanium was recently presented to the author, by J. Roberts. This sample, the fracture of which is shown in Fig. 47, showed the peculiar black mottled

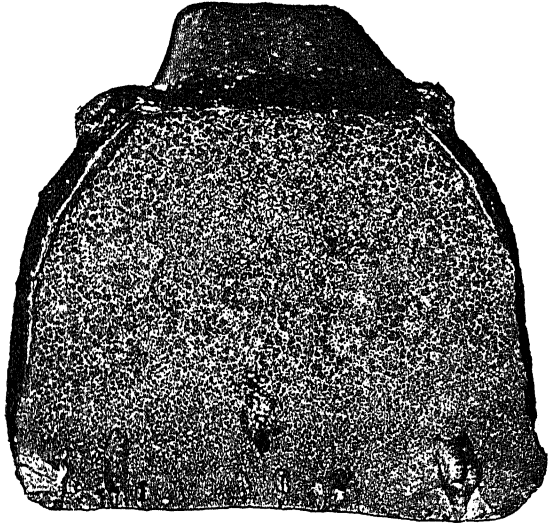

Fig. 47.—Fracture of pig iron containing titanium.

fracture which is so characteristic of titanium: an analysis by H. Silvester gave the following values:—

Carbon	{ Graphite,	3.273
	{ Combined,347
Silicon,	1.580
Sulphur,048
Phosphorus,106
Manganese,724
Titanium,280

From this analysis it is evident that the characteristic fracture is observed with a relatively small quantity of titanium; the tenacity, hardness, and other properties appear, however, to be unaltered, and in the proportions which are usually met with, such as the above, no other characteristic physical effect due to titanium can be detected. E. Riley has paid special attention to the analyses of titaniferous iron, and has recorded the composition

THE METALLURGY OF IRON AND STEEL.

various samples.* The cause of the curious black mottled appearance of titanite cast iron is not well understood, though it appears to be connected with the separation of a titanium carbide. It was pointed out by E. Riley† that the graphite separated from pig iron which contained titanium always yielded titanite when heated; while more recently P. W. Shimer has isolated a carbide of titanium which occurs in pig iron in the forms of minute particles; these are not soluble in hydrochloric acid, but dissolve in nitric acid, and consist of TiC ; they can be separated from the insoluble residue insoluble in hydrochloric acid by very careful washing.‡

It has been observed by T. W. Hogg§ that crystals of cyanide of titanium occur in rich ferro-manganese. These crystals are obtained by careful washing of the insoluble residue left on dissolving the ferro-manganese in an acid: they are so small that some hundreds of thousands of them occur in a cubic inch of rich ferro-manganese, and yet their total weight is only some 0.02 per cent. of that of the original metal. The author has had an opportunity of examining Hogg's preparations of these remarkable crystals, which certainly have all the appearance of titanium nitride, and which were met with in every sample of rich ferro-manganese examined. It is, however, very probable in view of what is known of the influence of titanium, that the small quantities present in ferro-manganese exert any perceptible effect in its commercial applications.

Arsenic.—Many iron ores contain small proportions of arsenic, which if present in quantity as sulphide or oxide would be easily expelled by calcination. Arsenic and phosphorus, however, possess many points of resemblance, one of them being that both elements are volatile, each is capable of entering into combination with oxygen to form compounds which are fixed at high temperatures. It has already been pointed out that phosphorus exists in iron ores as phosphate of lime, and that the greater part of the phosphorus usually passes into the pig iron. It is probable also that some of the arsenic exists as arsenate, and it is in this form is not eliminated by calcination, but is reduced in the blast furnace and is found in the cast iron produced. Though the whole of the arsenic thus charged into the furnace is reduced, the proportion is generally small, seldom exceeding 0.1 per cent., and its influence on the properties of the cast iron is somewhat similar in character, though much less marked in degree than that of phosphorus. According to Pattinson and others, arsenic exists in iron as an arsenide which is insoluble in nitric acid, and so produces an effect analogous to that of phosphorus in soft steel. These experimenters also state that arsenic

* Percy, p. 551; *Journ. Chem. Soc.*, vol. xv., p. 311; vol. xvi., p. 387.

† *Soc. civ.* ‡ *Inst. Journ.*, 1887, vol. i., p. 401.

§ *B. A. Report*, 1893, p. 721.

is not eliminated in puddling or in steel-making, either by the acid or the basic process.*

Grading of Pig Iron.—For commercial purposes pig iron is classified or “graded” according to the appearance of the fractured surface, the first member of the series being taken as the most open-grained grey iron, while white iron is taken at the other extremity.

There are two systems in use in the United Kingdom. The Staffordshire method is still employed for “All-Mine” iron,

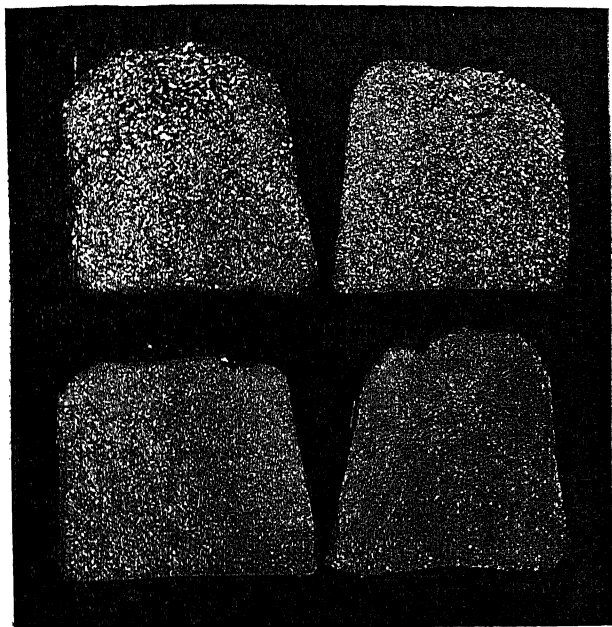

Fig. 48.—Fractures of Nos. 1, 2, 4, and white Northampton pig iron.

which is graded from 1 to 8, or occasionally from 1 to 10, the higher number being, as before explained, white iron. This method is now not much used, the one in most general favour being that adopted in Cleveland and the other chief centres of the iron trade; it is as follows:—

No. 1.		No. 4, forge.
No. 2.		Mottled.
No. 3.		White.
No. 4, foundry.		

This method of grading is illustrated in Fig. 48, in which are shown Nos. 1, 2, 4, and white Northampton pig iron.

* *Inst. Journ.*, 1838, vol. i., p. 171.

The upper left-hand sample, which is coarsest in the grain, is No. 1, and the upper right-hand sample, No. 2, while the lower left- and right-hand samples are No. 4, and white respectively.

The following analyses, collected from various sources, show that, as a general rule, in passing from No. 1 through the series to white iron, the combined carbon and the sulphur regularly increase, while the silicon at the same time steadily diminishes. These differences are often not so marked in haphazard analyses, but with a series of carefully-selected samples, prepared under as nearly as possible the same conditions, the rule above given will be found to be very generally correct:—

HEMATITE PIG IRON (*C. H. Ridsdale*).

	No. 1.	No. 2.	No. 3.	Forge.	Mottled.
Carbon, graphitic, .	3·52	3·40	3·10	2·30	2·16
„ combined, .	·18	·25	·36	·79	1·05
Silicon,	2·85	2·60	2·08	1·35	1·10
Sulphur,	·03	·04	·05	·28	·48
Phosphorus, . . .	·03	·03	·03	·04	·04
Manganese, . . .	1·31	1·24	1·09	·36	·33
Copper,	·11	·10	·10	·11	·11

CLEVELAND PIG IRON (*C. H. Ridsdale*).

	No. 1.	No. 2.	No. 3.	Forge.	Mottled.	White.
Carbon, graphitic, .	3·20	3·16	3·16	2·72	1·84	...
„ combined, . .	trace	·20	·48	·08	1·25	3·05
Silicon,	3·50	2·90	2·59	1·93	1·01	·67
Sulphur,	·05	·06	·08	·10	·32	·40
Phosphorus, . . .	1·67	1·69	1·57	1·55	1·57	1·60
Manganese, . . .	·68	·62	·60	·75	·62	·42

STAFFORDSHIRE ALL-MINE (COLD BLAST) PIG IRON (*A. E. Tucker*).

	No. 1.	No. 2.	No. 3.	No. 4.	No. 5.	No. 5a.	No. 6.	White.
Carbon, graphitic, .	3·30	2·68	2·55	2·14	1·90	1·25	·55	·20
„ combined, . .	·40	·45	·40	·50	·56	1·10	1·70	2·00
Silicon,	1·88	1·72	1·92	1·33	·97	1·09	·89	·71
Sulphur,	·02	·04	·07	·09	·12	·17	·16	·19
Phosphorus, . . .	·71	·68	·52	·56	·51	·56	·48	·47
Manganese, . . .	·40	·54	·40	·25	·52	·36	·46	·50

FOREST OF DEAN HÆMATITE (*Pattinson and Stead*).

	No. 1.	No. 2.	No. 3.	No. 4.	Mottled.	White.
Carbon, graphitic,	3·897	3·660	3·020	2·865	2·375	0·835
„ combined,	·395	·570	1·075	1·065	1·310	2·387
Silicon,	1·073	·975	·587	·728	·401	·305
Sulphur,	·011	·022	·050	·050	·063	·093
Phosphorus,	·070	·064	·059	·069	·066	·066
Manganese,	·217	·123	·202	·173	·115	·145

The above analyses appear to have been made from a specially selected series of samples; the author has had a number of opportunities of analysing the foundry irons made at the same works, and has invariably found less combined carbon and more silicon than is given in the analyses above quoted. All the Forest of Dean samples contained a trace of copper.

FRODINGHAM-LINCOLNSHIRE (through *Prof. R. H. Smith*).

	No. 1.	No. 2.	No. 4.	No. 5.	Mottled.	White.
Carbon, graphitic,	2·121	2·782	2·727	2·100	1·240	·802
„ combined,	·162	·330	·494	·750	1·350	1·500
Silicon,	2·750	2·400	1·500	1·026	·681	·300
Sulphur,	·023	·037	·024	·059	·075	·100
Phosphorus,	1·284	1·396	1·340	1·350	1·320	1·273
Manganese,	1·886	1·931	1·720	1·325	1·250	1·100

Grading of American Pig Iron.—In the southern parts of the United States the following method of grading pig iron into nine numbers was adopted in 1889.*

1. No. 1 Foundry.	4. No. 1 Soft.	7. Grey Forge.
2. No. 2 Foundry.	5. No. 2 Soft.	8. Mottled.
3. No. 3 Foundry.	6. Silver grey.	9. White.

Of these the Nos. 1, 2, and 3 foundry, grey forge, mottled, and white resemble similar numbers in the United Kingdom, while Nos. 1 and 2 soft, and silver grey, are siliceous irons, which are more carefully graded in America than is usual in this country. The following analyses, published by G. L. Luetscher, of the pig iron made from the ore of Red Mountain, Alabama, will serve to illustrate the composition of the different grades of southern iron:—†

* *Iron Age*, vol. xlii., p. 498.

† *Inst. Journ.*, 1891, vol. ii., p. 245.

	Silver Grey.	No. 2 Soft.	No. 1 Soft.	No. 1 Foundry.	No. 2 Foundry.	No. 3 Foundry.	Grey forge.	Mottled.	White.
Graphitic carbon,	3·13	3·48	3·53	3·49	3·55	3·48	3·00	2·11	·10
Combined carbon,	·02	·03	·03	·07	·07	·10	·57	1·22	2·92
Silicon, . . .	5·5	3·5	3·75	3·15	2·40	2·20	1·50	1·35	·95
Sulphur, . . .	trace	·004	·005	·005	·024	·025	·06	·125	·30
Phosphorus, . .	·68	·68	·68	·68	·68	·64	·64	·64	·64
Manganese, . .	·25	·26	·27	·25	·22	·21	·19	·14	·10

It will be observed that the silicon regularly decreases, with one slight exception, from 5·5 per cent. with silver grey, to 0·95 per cent. with white iron. At the same time the sulphur and combined carbon increase together from mere traces in silver-grey iron to 0·3 per cent. of sulphur, and nearly 3 per cent. of combined carbon in white iron. The phosphorus is slightly lower with the closer grades. These differences are exactly such as are noticed with similar grades in the United Kingdom, the most noticeable difference being the remarkably small quantities of sulphur met with in the open-grade American iron. That American foundry irons have an unusually low percentage of sulphur is a fact which is supported by the results of numerous analysts, and which has not yet been satisfactorily explained.

Special Irons.—The following analyses of three carefully-selected series of irons are by T. E. Holgate, of Darwen,* who has had special experience in the production of ferro-silicon, ferro-manganese, and silicon-spiegel. The last is used chiefly in the production of steel castings:—

FERRO-SILICON SERIES.

In which carbon and manganese decrease with the rise in silicon.

Silicon, . . .	8·54	10·18	14·00	16·13	17·80
Manganese, . . .	3·25	2·16	1·95	2·29	1·07
Sulphur, . . .	·064	·055	·078	·050	·041
Phosphorus, . .	·047	·104	·076	·090	·115
Carbon, graphitic, .	2·40	1·70	1·20	·62	·55
„ combined, . .	·14	·11	·23	·35	·11
„ total, . . .	2·54	1·81	1·43	·97	·66

* *S. Staff. Inst.*, 1888.

FERRO-MANGANESE SERIES.

Showing the increase of carbon with high manganese. In these samples the carbon is almost wholly in the combined form.

Manganese, . . .	8.11	19.74	41.82	53.32	71.32	80.04	87.92
Silicon,110	.52	.42	.46	1.12	.97	.53
Phosphorus,080	.078	.100	.110	.162	.175	.155
Carbon, . . .	4.27	4.78	5.63	6.25	6.17	6.53	6.31
Copper,33	.13	.23
Iron, . . .	87.40	74.75	51.90	39.80	20.65	12.10	4.75
	99.970	99.868	99.870	99.940	99.752	99.945	99.895

SILICON-SPIEGELS.

In these samples the carbon is somewhat higher than in the corresponding ferro-silicons, and partly in the graphitic form.

Silicon, . . .	10.74	12.60	14.19	15.94
Manganese, . . .	19.64	19.74	22.98	24.36
Phosphorus,074	.080	.095	.085
Carbon, graphitic,	.33	.67	1.13	.90
„ combined,	1.85	.98	.29	.30
	2.18	1.65	1.42	1.20
Iron, . . .	67.56	66.10	61.60	58.30
	100.194	100.17	100.285	99.885

CHAPTER XII.

FOUNDRY PRACTICE.

A CONSIDERABLE proportion of the pig iron which is annually produced is used by the iron founder for the purposes of his art. The application of cast iron for this purpose in England dates from the reign of Elizabeth, since which period ironfounding has steadily gained in volume and importance. It has been sometimes suggested that cast iron was in danger of being superseded by wrought iron or steel, and though since about 1850 the use of cast iron has been gradually abandoned for constructive purposes, so many other applications have been found for this material that the art of the founder is in no danger of extinction or even of serious diminution. Cast iron is the cheapest and most abundant form in which the metal is met with in commerce; it is fusible at a temperature which can be readily attained, and as it receives remarkably exact and clean impressions of a mould, it can be cheaply produced, even in very intricate forms. Its tensile strength, varying from an average of about 7 tons per square inch in common castings, to upwards of 15 tons with special mixtures, is ample for many purposes; its crushing strength is greater than that of any other material, reaching a maximum of about 100 tons per square inch. Being protected by a skin, cast iron resists atmospheric influences better than either wrought iron or steel; while for the wearing surfaces of machinery nothing is superior to cast iron on cast iron so long as sufficient area is provided.

Castings are much more easily and cheaply produced than forgings, so that the latter are only employed where special requirements of strength or ductility render their adoption necessary; while, as compared with steel castings, the advantages of cast iron for ordinary uses include not only the cheapness of the original material, but also the diminished cost in preparation of the moulds, the smaller loss in casting, and in the saving of expense and time required for annealing, which is necessary with steel but not for cast iron. Iron castings can thus be prepared to meet a pressing emergency, while their fine surfaces, sharp edges, and pleasing appearance recommend them for general use. It is probable, therefore, that while the greater strength of steel will lead to its extended application in the future, this will not result in the exclusion of cast iron.*

* J. Head, *Inst. M. E.*, 1886, p. 325.

Foundry Mixtures.—In the production of car wheels, of malleable castings, and for other special purposes, it is not unusual to employ but one brand of iron, merely mixing two or more grades of the same iron to give the required hardness. In such cases the greater part of the charge consists of a grade of iron similar to that which is desired in the casting, while a smaller quantity of a softer iron is added to counteract the hardening effect due to melting and to the admixture of foundry scrap. But in general foundry work it is preferable to employ a mixture of different brands of pig iron obtained from several localities. This causes the regularity of the work to be less dependent on the continuity of the supply of any particular iron, while it has a further advantage in that, if mixing is intelligently performed, very often a better result is obtained than when a single brand of iron is used. The reason of this is connected with the fact that irons from any particular locality have special characteristics; thus Northamptonshire pig contains 3 to 4 per cent. of silicon, North Staffordshire pig about 2 per cent. of manganese, and Cleveland iron 1.6 per cent. of phosphorus, while hæmatite iron contains little or no phosphorus. There is no advantage in mixing different irons, unless the mixtures are so arranged that each brand of iron used supplies what would otherwise be deficient in the casting. It must be borne in mind that "pure cast iron," or iron containing merely some 3 per cent. of carbon, is quite unsuitable for foundry use, but that silicon, and to a smaller extent manganese, phosphorus, and probably sulphur, act beneficially when present in suitable quantities, though the proportion of these elements, which may with advantage be allowed, varies with the purpose for which the mixture is required. Pure cast iron is white, hard, and brittle; it is thick when melted, and takes but a poor impression of the mould, while the castings are often full of blowholes. The addition of silicon converts this into a fluid iron, which fills every crevice of the mould, and which, on solidifying, is soft to the tool and free from blowholes; if too much silicon be added, however, the metal becomes brittle and somewhat hard. Iron which contains only silicon and carbon, though suited for some purposes, is not so close-grained as that which also contains some phosphorus and manganese, and its tenacity is deficient, though, again, excess of either of these elements leads to brittleness. It is evident, from these considerations, that foundry mixtures should be made with a due knowledge of the composition of the iron used, and of the most suitable mixture for the particular purpose in view.

In 1846-47 R. Stephenson conducted some experiments in connection with the erection of the high-level bridge at Newcastle-on-Tyne. The object was to determine, by the transverse strength of the product, the most suitable mixture of cast iron for the

construction of the girders of the bridge. Among the conclusions arrived at were the following: -

1. That simple samples did not run so solid as mixtures; further, that they are sometimes too hard and sometimes too soft for practical purposes.

2. That mixtures of hot and cold blast together gave a better result than either separately; though hot blast iron alone was not much inferior to cold blast iron alone.

For a detailed account of the foundry mixtures employed in the United Kingdom at this period, the *Report of the Commissioners on Iron for Railway Structures*, 1849, p. 418, should be consulted; in this report particulars of the proportions of different brands of iron used by various manufacturers for producing both large and small castings are given, and except where scientific knowledge has been applied in the foundry, the procedure is still much the same as in 1849.

Considerable importance was formerly attached to the source of the iron, the ores employed, and the temperature of the blast. It is now, however, generally recognised that these conditions are merely equivalent to certain chemical and physical properties, and so long as these properties are obtained, the stages which have led up to the desired result are not in themselves important.*

Special Mixtures.—Numerous proposals have been made from time to time for improving the strength of cast iron, the materials to be added for this purpose being of a most varied character, and ranging from tin to tobacco juice. Few of these are of any importance, but the following are worthy of mention: -

Price & Nicholson's process (Eng. Pat., 2,615, 1855) consisted in the use of refinery metal, or hard white cast iron low in silicon, produced in the refinery, in mixture with other irons, for the production of castings of special strength. The object was to lower the percentage of silicon in the product, while the proportion of carbon was unaltered. The process was, therefore, only of use with metal which originally contained too much silicon; in other cases the admixture, instead of being beneficial, was actually injurious. Some excellent results were obtained by this invention; but the introduction of Bessemer metal led to the abandonment of Price & Nicholson's process.

Stirling's Toughened Cast Iron.†—The late J. D. M.

* Interesting articles on "Cast Iron for Mechanical Purposes" (with numerous analyses), have been written by Ed. Deny (*Iron*, 1888, vol. ii., p. 42); on "The Chemistry of Foundry Iron," by C. A. Meisner (*Iron*, 1888, vol. ii., p. 548); and on "The Constitution of Cast Iron," by Dudley and Pease (*Amer. Inst. Min. Eng.*, Feb., 1886-7).

† For fuller details, see Patent 11,262, 1846, "Toughened Cast Iron," &c. *Report of the Commissioners on Iron for Railway Purposes*, 1849, p. 415, *et seq.* *Inst. C. E.*, 1851-2, vol. xi., p. 238; 1859, vol. xviii., p. 359. *Inst. M. E.*, 1853, p. 19 (an important paper by Stirling himself). W. Fairbairn, *Application of Iron to Building Purposes*, 1857-8, p. 68. T. Box, *Strength of Materials*, 1863, pp. 202, 503, &c.

Stirling took out four patents in all, between the years 1846 and 1851 inclusive. They all referred either to metals or metallic alloys, and generally do not appear to have been much applied. In the first patent, however, taken out in 1846, a very important method for the production of "toughened cast iron" is mentioned. Thus in the specification, p. 3, it is stated: "For certain purposes, such as shaftings . . . where a metal possessing greater tenacity or strength than ordinary cast iron is required, and where it is an object to vary the degree of hardness, I made a mixture of wrought and cast iron. . . . I melt cast iron . . . and add to it . . . a quantity of malleable iron less than the weight of the cast iron. . . . This mixture is afterwards to be re-melted as convenient. . . . And I would remark that cold blast iron will require a smaller addition of wrought iron than hot blast iron; but I find that the addition of one-third to one-fifth of wrought iron to answer well in the generality of cases where increased strength, toughness, and tenacity are required." Similar experiments were conducted about the same time by Lillie of Manchester, and greatly increased strength was obtained; but the trials were abandoned when Stirling took out his patent.

The advantage of this process is no doubt connected with the fact that many foundry irons contain too much silicon, and sometimes, also, too much phosphorus and manganese, to give a satisfactory casting; while, by the addition of a proper quantity of wrought iron a suitable chemical composition is obtained. Stirling, however, did not understand the true reasons underlying his process, but thought it depended on the reduction in the percentage of carbon due to the addition of wrought iron. No analyses were published in connection with these experiments, but it was known that hard irons were deteriorated by the addition of wrought iron, and that with soft irons there was a definite limit, beyond which any further addition was injurious. This is illustrated by the results of some experiments given below, in which different proportions of wrought iron were added to a sample of cast iron, and the greatest improvement was observed with about 30 per cent. of wrought-iron scrap.

Cast Iron.	Wrought Iron.	Transverse Strength. Increase per cent.
100	10	22½
100	20	31½
100	30	60
100	40	33

As to the method of applying this process, it was recommended that the mixture should be made at the blast furnace,

by placing the metal in the moulds into which the molten cast iron was to be run. The malleable iron was thus firmly fixed, and when remelted in the cupola a uniform product was produced. It is stated that wrought iron gave better results when somewhat rusty, and roasting was sometimes promoted by previously adding salt water or diluted hydrochloric acid. The product appears to have been subjected to rigorous and impartial tests, and to have yielded very satisfactory results. Toughened cast iron met with considerable application during the lifetime of Stirling, among the larger works for which it was employed being Chelsea, Yarmouth, and Windsor Bridges, and Manchester Viaduct. In the latter case Stirling states that the contractors for the heavy castings, by being allowed to reduce the scantlings in proportion to the increased strength, were enabled to profitably fulfil their contract, whereas had they employed common iron, they would have been heavy losers. The use of wrought-iron scrap in the foundry has not met with the general application which was at one time anticipated, partly on account of the special care and experience which are necessary in order to obtain a satisfactory result, and more particularly because of the introduction of steel for foundry and other purposes where greater strength is desirable. It was, however, formerly a well known trick in the foundry when an inspector was at hand, and a specially-strong test bar was needed, to introduce a handful of wrought-iron turnings into the ladle from which the bar was to be cast. For special purposes also, wrought iron or steel scrap still meets with considerable application. In Germany cupola furnaces have been introduced, which are specially designed for the melting of wrought-iron scrap with common siliceous pig iron.*

In America also, S. M. Carpenter patented (173,159, 1876) the use of steel for strengthening cast iron, and T. D. West has given directions for the proper use of steel scrap, remarking that it must not be understood that the more steel or wrought iron is mixed with cast iron the stronger it will be, for there is a limit to the percentage which should be employed, and this limit greatly depends on what grades of steel and cast iron are mixed together.† In 1885 the author suggested the use of wrought iron or steel scrap with iron rich in silicon, as being cheap and convenient in many cases,‡ and F. Gautier subsequently experimented in this direction, showing that with 1 part of ferro-silicon, which contained about 10 per cent. of silicon, 3 parts of wrought iron or steel scrap might be employed; the resulting castings showed very remarkable toughness and resistance to shock, combined with soundness, softness, and a close-

* *Inst. Journ.*, 1882, vol. ii., p. 784.

† *American Machinist*, 30th May, 1885, p. 5.

‡ *J. S. C. I.*, vol. v., p. 293.

grained, grey fracture.* In the discussion which followed the reading of this paper, Sir H. Bessemer mentioned experiments in which he had obtained very satisfactory results by mixing 2 parts of fluid-decarburised iron and 1 part of grey iron, the castings being used for railway crossings and for stamp heads for quartz crushing.

Soft Mixtures.—For a large number of foundry purposes, the chief properties which are desired in the iron are easy fusibility, perfect admixture, fluidity, and the property of producing soft, grey castings with good surfaces, which exactly reproduce the impressions of the mould, and which do not chill even in the thinnest parts. To obtain such a result, relatively cheap mixtures can be employed, which should contain about 3 to 3·5 per cent. of silicon, about 1 per cent. of phosphorus, not more than 1 per cent. of manganese, and as little sulphur and combined carbon as possible. The elements other than carbon should thus amount to from about 4 to 5 per cent., and of these the greater part should be silicon. Such a mixture, though somewhat deficient in strength, is in other respects an ideal iron, on account of its fluidity and softness, while it possesses the additional advantage that it allows of the use of a considerable proportion of foundry scrap.

Remelting.—The pigs of iron as received at the foundry, if not already broken, are fractured, usually into two pieces; for this purpose hydraulic breakers are very convenient, and are becoming much more generally used. The pigs when broken can be more readily handled, and can be classified according to the appearance of the fracture. The metal is then melted in one of the three following furnaces:—

1. *The Crucible (or Pot) Furnace* is not unfrequently employed in the malleable cast iron trade, and in other cases where the quantity required is small, and the metal relatively expensive. Crucibles are also convenient for experimental tests or original investigations. The crucibles used are generally of clay, while coke is the fuel employed, and the arrangement of the melting house resembles that adopted for the production of crucible steel. Melting in crucibles is so expensive that it is only adopted where special reasons render this method preferable.

2. *The Reverberatory (or Air) Furnace* is employed where special quality or uniformity is required, as in the manufacture of chilled rolls. The furnace is a large reverberatory; the chief peculiarity is that the roof instead of being straight, as usual, is curved somewhat sharply downwards from near the fire bridge to near the flue end. This reduces the space in the melting part, and directs the flame upon the metal. The bottom of the furnace is of sand, the fuel used is coal, and a reducing (or smoky) flame is continually maintained, so as to diminish the change by

* *Inst. Journ.*, 1888, vol. i., p. 58.

oxidation during re-melting to a minimum. Each furnace is sufficiently large to allow of several tons being melted at once. The advantage of this method of melting is that a clean iron is obtained, which differs but little from that originally charged into the furnace, while the metal can be retained in the fluid state until it has been tested, and any necessary additions can then be made; great uniformity is thus secured, but the air furnace is not suited for general foundry work, as melting is performed but slowly, while the consumption of fuel is relatively high.

3. *The Cupola* is in by far the most general use for remelting iron. A cupola is a small blast furnace, of which there are many varieties employed; they are generally circular in section, and are driven with low-pressure blast at, or near, the atmospheric temperature. The fuel used is generally hard coke, though occasionally gaseous fuel or charcoal is employed. Usually the melted metal collects at the bottom of the cupola, and is tapped off at intervals; in some cases separate receivers are adopted.

When coke is used the fuel consumption varies from about $1\frac{1}{2}$ to $2\frac{1}{2}$ cwts. per ton of iron melted, being greater with small outputs on account of the loss due to heating the cupola with each charge. A small quantity of limestone is usually added, as it fluxes off the silica added in the form of sand adhering to the pigs, or produced by the partial oxidation of the silicon in the iron; it combines with the ash of the coke, and also diminishes the amount of sulphur which is absorbed from the coke by the iron.

The blast, which is not heated, is driven by means of a fan, or more usually by a Roots' blower, the pressure being only a few ounces per square inch. In the ordinary form of cupola the blast is introduced through one or more twyers in a single row around the zone of fusion. In Ireland's cupola, which was introduced about 1860, two rows of twyers are employed, and the cupola is provided with boshes like a blast-furnace. The object of the upper row of twyers is to ensure more complete combustion of the carbonic oxide, which otherwise passes through the charge unburned. This form of cupola has been largely used, and is sketched and described by Kohn.* In the Greiner and Erpf cupola, which has met with much favour in Germany, there is a circle of five or six twyers around the melting zone, while there are also about twelve to eighteen smaller twyers, each about one inch in diameter, which are placed around the furnace in spiral form.† M. Hamélius has also employed cupolas with three rows of twyers at different heights, the top row being placed in an oblique plane so as to embrace a greater volume

* *Iron and Steel Manufacture*, p. 52.

† *Inst. Journ.*, 1887, vol. ii., p. 296.

of the cupola, and a larger mass of the charge.* In some cases the air for combustion, instead of being forced in under pressure, is aspirated by means of a steam jet arranged in a tube or chimney connected with the cupola. The Woodward cupola, introduced about 1860, was of this type, and was employed by a number of firms of repute in the United Kingdom; it has been sketched and fully described by Kohn (p. 53). More recently the Herbertz cupola, which is of the same class, has met with much favour in Germany, though it has not been successfully introduced into the United Kingdom. When the steam-jet cupola was first introduced, it was claimed that there was an extraordinary economy of fuel and working expenses by melting in this way. These anticipations have not been realised, but it

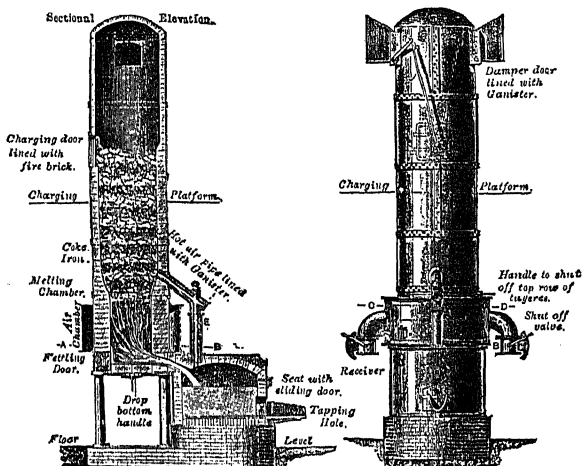

Fig. 49.—Stewart's "Rapid" cupola.

is stated that the iron obtained in steam-jet cupolas is softer and cleaner than usual. In a paper on cupolas for melting iron, M. A. Gouvy has described a number of forms which are in actual use, and has tabulated the details of thirty-three different cupolas, chiefly German.† This writer concludes that the use of hot blast, the replacement of forced draught either by natural draught or by the use of aspirators, and the injection of fuel either through the tuyers or otherwise, do not appear to have led to any considerable economy; he further states that hitherto the best results have been obtained with cupolas with several rows of tuyers, of which the Greiner and Erpf may be taken as an example.

* *Inst. Journ.*, 1887, vol. ii., p. 296.

† *Ibid.*, p. 294.

Stewart's "Rapid" cupola, which is shown in Fig. 49, may be regarded as a type of the form in use in many foundries in the United Kingdom. It is driven with forced draught in the ordinary way, but is provided with a double row of tuyers, and with a separate receiver, into which the metal runs as it is melted. The author has obtained very good results when using this cupola. J. Riley has introduced a cupola for remelting iron for the Siemens process, in which the fuel used is producer gas; the advantages claimed for this form is that a clean pure metal is obtained, while the combustion is under more complete control.*

Influence of Remelting.—It is observed that when cast iron is remelted it becomes harder and more close in texture; if the metal operated be soft the casting is stronger than the original iron, but when hard iron is used it becomes still harder, and weak, like ordinary foundry scrap. There has long been an impression that remelting improves cast iron, but that this is not so is proved by melting the metal in a carefully covered crucible, where no change in composition takes place, and the properties of the iron are unaltered. In some experiments by Sir W. Fairbairn,† a sample of No. 3 Eglinton grey iron was remelted in an air furnace 18 times, test bars being cast at each melting, and it was found that the iron improved up to the twelfth melting and afterwards rapidly deteriorated. Other experiments were performed shortly afterwards, in connection with the manufacture of cast-iron ordnance, in which marked improvement was noticed on remelting cast iron and keeping it for a longer or shorter period in a state of fusion. No explanation of these effects was given, but the experiments were referred to in numerous text-books, and led to the belief that remelting *per se* was beneficial, though it was observed that the number of remeltings required to produce the best effect varied largely with different samples.

Some analyses of Sir W. Fairbairn's samples were made by Professor Calvert, but these analyses only made the matter less intelligible, and some doubts, which the result amply justified, as to correctness of these analyses were expressed by Snelus and others. By the kindness of Professor Unwin, who assisted in Sir W. Fairbairn's experiments, the author was supplied, more than thirty years after the tests were made, with samples of the test bars, and was enabled by their analysis to clear up some of the difficulties which had surrounded the subject.‡ The results of the author's analyses were as follows:—

* *Inst. Journ.*, 1885, vol. ii.

† *B. A. Report*, 1853, p. 87.

‡ *Journ. Chem. Soc.*, vol. xliv., 1886, p. 493.

No. of Melting.	Total Carbon.	Combined.	Silicon.	Sulphur.	Manganese.	Phosphorus.
1,	2·67	0·25	4·22	0·03	1·75	0·47
8,	2·97	0·08	3·21	0·05	0·58	0·53
12,	2·94	0·85	2·52	0·11	0·33	0·55
14,	2·98	1·31	2·18	0·13	0·23	0·56
15,	2·87	1·75	1·95	0·16	0·17	0·58
16,	2·88	...	1·88	0·20	0·12	0·61
18,	2·20

It will be noticed that, owing to the oxidising effect of remelting, the proportion of silicon steadily diminished, while sulphur was at the same time absorbed from the furnace gases. The natural effect due to these changes was produced upon the condition of the carbon, which, instead of being almost wholly graphitic, became nearly all combined, thus producing a hard, white iron, which was deficient in tenacity, and brittle. The elimination of manganese with the silicon, the increase in the percentage of phosphorus due to its concentration in a smaller quantity of metal, and the initial increase of total carbon for a similar reason, are all in accordance with what is observed whenever iron is melted in the air, and when the resulting slag is not strongly basic.

The physical effects produced when cast iron is remelted are thus merely indications of chemical changes which have taken place in the material, while the nature of these changes, and hence the effect produced by remelting, will vary with the composition of the iron employed and the oxidation to which it is subjected.

In Sir W. Fairbairn's experiments the metal was melted in an air furnace, but in ordinary practice a cupola is employed. Here the oxidation is greater, while as the iron melts in contact with the fuel it more readily absorbs sulphur. As a consequence, though the changes which take place are of the same kind, and follow the same order as that previously given, the effect of each melting is more marked. This is illustrated by the following analyses,* from experiments conducted by Jünger in the Imperial Foundry at Gleiwitz:—

	1st Melting.	2nd Melting.	3rd Melting.
Carbon, graphitic,	2·73	2·54	2·08
" combined,	·66	·80	1·28
Silicon,	2·42	1·88	1·16
Sulphur,	·04	·10	·20
Phosphorus,	·31	·30	·28
Manganese,	1·09	·44	·36

* *Inst. Journ.*, 1885, vol. ii., p. 645.

Moulds.—The size, shape, and character of the moulds employed in an iron foundry depend upon the class of work in hand; they may be conveniently divided into the following four classes:—

1. Green-sand.
2. Dry-sand.
3. Loam.
4. Chills.

1. *Green-sand moulds* are made of moulding sand, which is first uniformly damped, so as to make it adherent, and is lightly

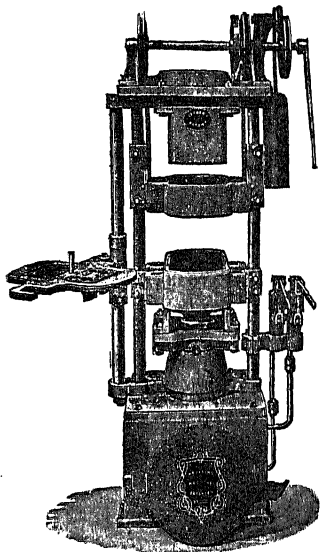

Fig. 50.—Sand moulding machine.

rammed around a pattern to obtain the required shape. For common castings, especially when of large size, open sand is often used, but for the majority of purposes the sand is contained in boxes, which in this country are usually of cast iron, though wooden moulding boxes are frequently used in the United States. Usually there are two boxes, upper and lower, the pattern or patterns being placed partly in each box, and the "gate," or opening for the entry of the metal, being commonly in connection with the middle of the castings. Where a hole or passage is required in the casting, a "core" is employed; this generally consists of sand, moulded into the necessary shape, and supported by iron wire or other suitable means.

The patterns are generally of wood, and if of intricate forms, are made in parts designed to allow of their removal from the mould; the several parts are kept in position by suitable pins. Green-sand moulding is the process most generally adopted, as it is rapid and cheap; it involves the use of no expensive plant, and is specially suitable for the production of a large number of articles of similar form. Machine moulding is employed by manufacturers who have a considerable demand for one class of work, and in such cases sand-moulding machines are coming steadily into favour, though they can never replace hand work in a general foundry. A form of patent moulding machine which is now adopted in a number of foundries

in the United Kingdom is shown in Fig. 50, while the method of supporting the pattern will be understood by reference to Fig. 51. Many other forms of moulding machine are also in use.

2. *Dry-sand moulds* are made of a loamy sand which, after being roughly moulded into shape, is dried by heat, and then carefully finished with the tool. The mould is sufficiently soft to be readily cut, though rigid enough to retain its shape when the molten metal is poured into it. Such moulds have the advantage of giving sounder castings, as they evolve less gas, while where a single casting is needed they save money, as no pattern is required. When, however, a pattern has once been prepared, green-sand moulds are much cheaper.

3. *Loam moulds* are more particularly employed for curved or spiral surfaces of large size, such as sugar pans, "copper" boilers, soda pans, water pipes, &c. The outer part of the mould is

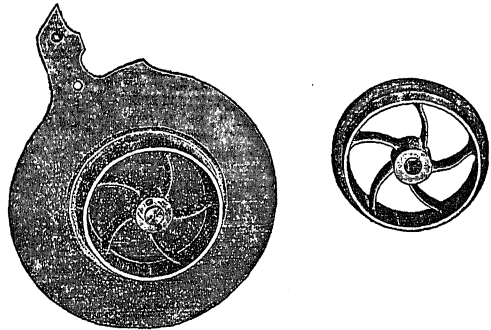

Fig. 51.—Pattern for sand moulding machine.

either built up of brickwork, held in place with iron ties; or where a number of similar articles is required, an iron casing is employed. The inner surface of the mould is made of loam which is laid on by the trowel and worked by the hand and usually faced with some carbonaceous blacking. The whole is then carefully dried before use, one of the most general methods being by the introduction of a flame of gas into the interior. Such moulds can, of course, only be employed for one casting, and the labour and cost of loam moulding is much greater than that of green sand.

4. *Chills* are used when it is desired to produce a casting, the outside of which is unusually hard. The iron used is generally close-grained grey, and this is converted to white iron where it comes in contact with the cold side of the mould during solidification. A familiar example of the use of chills is met with in the production of chilled rolls. These are cast on end, with

good head of metal, so as to give soundness, while as the shanks of the roll are required to be turned to size, these are cast in sand, and are, therefore, relatively soft. The intermediate part of the mould, in which the barrel of the roll is cast, is made up of a number of large annular rings of cast iron resting one upon another. These are not used cold, or a violent explosion would take place when the hot metal came in contact with the cold, and, therefore, probably slightly damp chill. The mould is, on this account, heated to a temperature of about 150° to 200° C. before the metal is introduced, and the iron is caused to enter from the bottom, and in an oblique direction. By this means a circular motion is imparted to the metal, and thus, as it rises, it collects all dirt and impurities on its surface, and so fills every crevice of the mould.

As it is intended that the subject of ironfounding shall be dealt with in another volume of this series of text-books, it will not be necessary to enter into more details here.*

Moulding Sand.—The proper selection and preparation of moulding sand has an important influence on the appearance and quality of the castings produced in the foundry. The mould must be capable of retaining the fluid metal in every direction, but at the same time it must allow of the free passage of the air which is collected, and the gases which are generated when the mould is filled with hot iron. It must give to the casting a smooth clean surface, and hence must neither act upon, nor be affected by, the fluid metal at the high temperature at which they are brought in contact; the higher the temperature is that is necessary to retain the metal in the perfectly fluid condition, the greater is the difficulty of complying with this condition. Thus moulds for cast iron require more careful preparation than those for brass, while those to be employed for steel castings require still more careful attention. Moulding sands consist chiefly of silica, together with variable proportions of alumina, magnesia, lime, and other metallic oxides; coal dust is also frequently added in small quantity. The higher the proportion of silica the more refractory the sand becomes; but it is then apt to be wanting in cohesion, and to be difficult to mould, while the moulds crack in drying, or are injured by the flow of metal. Alumina and magnesia impart cohesion and plasticity, though excess, especially of alumina, causes it to be less refractory. Magnesia is refractory, forming a good cement for siliceous sand, but when present in quantity it renders the mould less porous. Lime and other metallic oxides render sand less refractory, and should be avoided as far as possible. If the lime be present as carbonate, gas will be given off at high temperatures, and will produce rough surfaces in the casting; while

* On "Chilled Castings," see *Inst. Journ.*, 1891, vol. ii., p. 250; 1892, vol. i., p. 126; T. Morgans, *Pro. Bristol Nat. Soc.*, Jan., 1887.

if it be present as silicate, it will cause the sand to adhere to the surface of the hot metal. According to Kohn,* a suitable composition for green-sand moulding is approximately as follows:—Silica, 92 per cent.; alumina, 6 per cent.; oxide of iron, 1.5 per cent.; and lime, .5 per cent.; while sand for stove-dried moulds is usually richer in alumina and oxide of iron. According to the same author, a composition largely used in steel works for moulding purposes is prepared from Sheffield ganister, which is mixed with sufficient magnesia and alumina to give a product containing about 85 parts of silica, 5 to 10 of alumina, and 5 to 10 of magnesia.

In addition to the sand being of the right chemical composition, which condition affects its plasticity and refractory nature, as above indicated, it is also necessary that it should be of proper degree of fineness, as when the particles are too coarse the surface of the castings is inferior, and the sand is wanting in cohesion, while when the sand is unusually fine it is unsuitable for large castings, as the gases cannot so readily escape.

Effect of Size and Shape.—The strength and solidity of a casting are affected by the bulk of metal employed, and by the form of the casting made. Thus if a sample of pig iron which would be suitable for a casting of small size be employed for making very heavy work, it will be found that owing to the slower cooling in the latter case the grain of the metal becomes much more open, and the strength is proportionally diminished. On the other hand, if the same metal were used for very small castings, the chilling in the mould would tend to make the product close and hard, and in many cases this would be so marked as to make the castings quite brittle. The grade of the iron used must therefore depend upon the size of the casting to be made, the general rule being that a closer grained or less siliceous iron must be used for large than for small castings. At the same time, it is generally found that the strength of a large casting per unit of area is somewhat less than that of a smaller one, since the closeness of grain is usually, though not always, associated with increased tenacity.

It is also very important that in large castings, where strength is required, no sharp or re-entering angles should occur, as these in all cases lead to the formation of planes of weakness in the casting. When the metal cools in the mould a crystalline structure is developed, the crystals forming at right angles to the cooling surface.

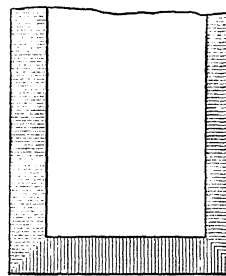

Fig. 52.—Diagram showing effect of sharp angles in a casting.

* *Iron Manufacture*, p. 55.

If this cooling surface be curved, the crystals interlace so as to yield a strong casting of uniform structure, while on the other hand, whenever a sharp change of curvature takes place a plane of weakness is the result. Thus, in a case which came under the notice of the author some years ago, an hydraulic cylinder was cast, as shown in Fig 52, with sharp corners at the base and a plane of weakness all round. The result was that when the cylinder came to be used, and a little extra pressure applied, the bottom was forced out in a piece, and considerable loss and inconvenience was occasioned, which might have been readily prevented by casting the same weight and quality of metal in a curved form, so that uniform crystallisation could take place.

Shrinkage of Cast Iron.—Although cast iron, especially when very grey, expands at the moment of solidification, and thus gives a sharp impression of the mould, the subsequent cooling from a red heat to the ordinary temperature leads to a still greater contraction, and the nett result is that the casting is always smaller than the pattern from which it is made. For this reason it is usual in pattern-making to allow about $\frac{1}{8}$ of an inch per foot for shrinkage, and if the casting is required 1 foot long, the pattern is made 1 foot and $\frac{1}{8}$ of an inch in length. The shrinkage in castings is, however, by no means a constant quantity, but varies with the proportions of the castings and with the character of the metal used; as much as $\frac{1}{10}$ of an inch per foot being allowed when casting beams, and only $\frac{1}{32}$ with large cylinders. Not unfrequently much loss and inconvenience is occasioned in foundry work by variations in the shrinkage, caused by altering the shape or proportion of a pattern, or by the use of a different variety of iron.

When cast iron, or any similar material, is poured in the fluid state into a cold mould, solidification commences at the outside, and during the subsequent stages of cooling, the casting consists of a comparatively rigid envelope, containing hot and relatively soft material. If, now, the conditions of a small piece of such metal in the centre of a square be considered during cooling, it will be seen from the accompanying diagram (Fig. 53) that the contracting force exerted on each side of the square will be the same, and hence a cube or a sphere of cast iron in cooling contracts in a uniform manner throughout its mass. If, however, two such squares be placed side by side, so as to produce a rectangle (Fig. 54), on each half of the sides the contracting forces are the same as before, or one unit, but on the ends, since there is no rigid division between the two squares, both particles exert a unit of contracting force; the result is that the contracting force at the ends is equal to that on the sides, or on a unit of length the contracting forces are double as great on the ends as on the sides. If this rectangle were made 12 inches long and

1 inch wide, the contracting force on each inch in length would still be but one unit, while at the ends it would be twelve times as much. Accordingly, in a bar of cast iron 12 inches long by 1 inch in square section, it is found that the contraction in the direction of the length is much greater than in the cross section, though owing to the rigidity of the outside during cooling, and

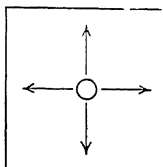

Fig. 53.

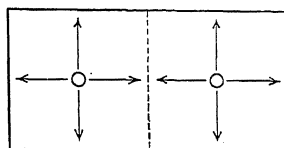

Fig. 54.

Diagrams illustrating influence of shape on shrinkage.

other causes, it will not be exactly, or perhaps even not approximately, twelve times as great in one direction as in the other. In casting very thin strips the shrinkage in the length is thus very great, while in the thickness it is scarcely appreciable. This principle is of general application. A square plate shrinks little in thickness, but equally in width and breadth; a flat disk shrinks little in thickness, but equally in all diameters; a thin ring shrinks more in diameter than a thick one, and so forth. The following example will illustrate the application of these facts:—

A wheel, as in the accompanying sketch (Fig. 55), may be regarded as made up of three parts, each of which contracts differently—the outer ring, A; the spokes, B; and the hub, C. If a pattern as shown give a good result with a particular iron, and any alteration be made in the proportions of the pattern, it is very probable that fractured castings will be obtained. Thus if the outer ring be thickened it will contract less in diameter, and the spokes will tend to break away from it in cooling; if the hub be made thicker it will contract less, and probably the outer ring will be forced open in consequence; while if the spokes be thickened, they would contract less in the direction of their length, and also tend to fracture the outer ring. If the pattern be made thinner in parts, instead of thicker, there would be similar tendency to fracture during the cooling of the wheel.

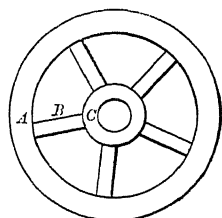

Fig. 55.—Diagram illustrating shrinkage in a cast-iron wheel.

In the author's experiments on cast iron it was noticed that silicon pig shrank most in the mould, though no accurate deter-

minations of shrinkage were made. The subject has since been carefully investigated by W. J. Keep, of Detroit, whose experiments embody the whole of the trustworthy data available, and who measures shrinkage by casting bars in sand between iron chills $12\frac{1}{8}$ inches apart. The contraction is carefully measured by means of graduated wedges which are inserted between the ends of the cold bar and the iron chill in which the bar was cast. Mr Keep concludes that, when silicon varies, and other elements do not vary materially, castings with low shrinkage are soft, and that as shrinkage increases, hardness increases in almost, if not exactly, the same proportion. For ordinary foundry practice the scale of shrinkage agrees with the scale of hardness, so long as sulphur and phosphorus do not vary over wide limits. This is an important fact, and as shrinkage tests are very easily performed by an ordinary workman, the subject is worthy of more attention than it has hitherto received.*

When it is known that iron with different shrinkage to that generally employed is to be used in a foundry, the patterns should be altered to meet the changed conditions. As already explained, the contraction will be greatest in the direction of the length of thin parts of the casting, and these should, if possible, be somewhat thickened when the shrinkage increases, so as to restore uniformity. If the pattern cannot conveniently be altered, then such additions must be made to the foundry mixture as are necessary to give a metal with the required shrinkage; silicon, unless in excessive quantities, gives grey, soft iron, which has the minimum shrinkage, and thus, in many cases, a judicious mixing of iron will give the required product without any extra expense.

It is stated that charcoal iron has usually a melting point which is considerably higher than that of less pure iron made with coke. Charcoal iron, therefore, sets more quickly in the mould, and contracts more, so that an extra allowance for shrinkage must be made in the patterns employed.†

Hardness of Cast Iron.—The hardness or softness of cast iron is in many instances of the greatest importance, as the metal has to be turned, planed, filed, or otherwise worked with tools; hence a number of methods have been devised at various times with the object of determining relative hardness. In the older form of apparatus, such as was used by the American Ordnance Commissioners in 1856, and has since been employed by Calvert and Johnston, Bottone, and other experimenters, an indentation was made in the surface of the metal to be tested. By determining either the force required to make a hole of a given size, or, on the other hand, the size of the

* W. J. Keep, *Silicon in Cast Iron*, p. 22.

† Kohn, *Iron Manufacture*, p. 57.

indentation needed by a given force, a measure of hardness was sought to be obtained. Such a method is, however, erroneous unless the tenacity of all the specimens to be examined is the same, as otherwise a deeper hole will be produced in the weaker metal, irrespectively of hardness. In the author's researches a weighted diamond was employed for determining the hardness of cast iron, and the results obtained with increasing proportions of silicon are graphically represented in Fig. 46. When very little silicon was present the metal was extremely hard owing to the large proportion of combined carbon, while when sufficient silicon had been added to convert the greater part of the carbon into the graphitic form the maximum softness was obtained. With further additions of silicon the metal became harder owing to the hardening effect of silicon itself, and for this reason an excess of silicon, beyond about 3 per cent., is injurious to the working qualities of the metal. The sclerometer, or hardness machine, introduced by the author for these tests, has been adopted by W. J. Keep in his valuable investigations on the properties of cast iron, and by various firms in America and elsewhere for similar purposes. The apparatus and method of working have been fully described before the Birmingham Philosophical Society* (see Fig. 56).

Hardness and Strength of Cast Iron.—When cast iron has to be turned or otherwise worked the hardness is of considerable importance, while in some cases smoothness of surface and general perfection of the casting are of the utmost moment. Hard cast iron is brittle, deficient alike in crushing, transverse, and tensile strength, and seldom gives smooth clean castings. With metal which is a little less hard the maximum crushing strength is obtained; while on rendering it a little softer, or as the workman would call it "moderately hard," the maximum transverse strength is observed. With slightly softer cast iron the highest tensile tests are obtained, while still softer metal works with the utmost facility, though it is deficient in strength. It will be seen, therefore, that when the general connection between hardness and strength has been fully grasped, the ironfounder requires only the information how to harden or soften his metal at will, by the use of silicon or other agents, to be able to produce castings in which crushing, transverse, or tensile strength shall predominate as desired, or in which softness and fine surfaces shall be the most characteristic feature.

There is a somewhat prevalent idea among founders that if considerable strength is required a hard iron must be employed. Doubtless this is to some extent true in connection with crushing and transverse tests, but is certainly not correct with tensile

* Vol. v., part II., *Chem. News*, vol. lv., pp. 179, 195, 205, 217.

strength. In all specimens of exceptionally high tensile strength examined by the author the metal was a soft good working iron, specially suited for engineers' purposes. In accompanying table is a summary of the author's results on the tenacity and hardness of cast iron, as affected by alterations in the proportion of silicon.* The working qualities of the specimens are also given, and it will be seen that the hardness as determined by the sclerometer agrees very closely with the observations of the workman. It will be noticed, however, that hardness and tensile strength do not vary together, but on the contrary high tensile strength is met with in the softer irons.

INFLUENCE OF SILICON ON THE HARDNESS AND TENACITY OF CAST IRON.

No.	Silicon per cent.	Tensile Strength.	Hardness.	Working Qualities.
1	0·19	10·14 tons	72	Very hard indeed.
2	0·45	12·31 „	52	Very hard, though not so hard as No. 1.
3	0·96	12·72 „	42	Hard, though softer than No. 2.
4	1·96	15·70 „	22	Good, sound, ordinary, soft-cutting iron, of excellent quality.
5	2·51	14·62 „	22	Rather harder than No. 4.
6	2·96	12·23 „	22	Like No. 4.
7	3·92	11·28 „	27	Like No. 6, but rather harder.
8	4·75	10·16 „	32	Rather harder than No. 7, though not unusually hard.
9	7·37	5·34 „	42	Still harder, cutting very like No. 10.
10	9·80	4·75 „	57	Hard-cutting iron, though still softer than No. 1.

Crushing Strength.—Cast iron possesses an exceptionally high crushing strength, and for the majority of purposes the founder relies upon this, and does not perform special tests. Usually the tensile strength is not above one-sixth of the crushing strength; hence, if power to resist a tensile force is assured, the crushing strength is usually sufficient for ordinary work. In performing compressive tests it is necessary to have perfectly parallel surfaces, and to bed the specimen as true as possible, otherwise the results will be low. With regard to the shape of test piece to be employed, Mr. Hodgkinson concluded that "where the length is not more than about three times the diameter, the strength for a given base is pretty nearly the same;" † hence the test pieces used for compressive tests are short prisms and cylinders of various dimensions. Professor A. B. W. Kennedy employs cylinders 3 inches high and 1 inch in diameter for these tests; other engineers recommend cylinders

* *Journ. Chem. Soc.*, 1885.

† Fairbairn, *Iron Manufacture*, 1869, p. 219.

2½ inches high and 1 inch diameter. The following examples will serve to illustrate the results which have been obtained:—

Experimenters.	Tons per square inch.			Authorities.
	Max.	Min.	Mean.	
Hodgkinson, . . .	64·9	36·5	48	Fairbairn, <i>Iron</i> , 1869, p. 218.
Hodgkinson (1849), . . .	53·8	24·7	38·5	Pole, <i>Iron Construction</i> , p. 84.
Woolwich (1858), . . .	62·5	19·9	40·6	<i>Report</i> , 1858, p. 2.
Fairbairn, . . .	95·9	40·7	...	<i>B. A. Report</i> , 1853, p. 87.
Turner, . . .	92·5	34·1	...	<i>J. Chem. Soc.</i> , 1885, p. 907.

The average crushing strength of British cast iron is thus about 40 tons per square inch; exceptionally, results so low as 19·9 tons have been observed, while, on the other hand, a strength of upwards of 90 tons has been produced in some instances. In the above experiments no special pains were taken to produce an iron possessing a high crushing strength; on the contrary, only such irons were taken as were met with in commerce. In the light of modern researches, iron could doubtless be produced with a crushing strength of 100 tons to the square inch, while a strength of 70 tons could, if necessary, be regularly assured. A series of sketches illustrating the fractures of test pieces with different proportions of silicon, when subject to a compressive force, are given in the author's paper on "Silicon in Cast Iron."* The samples were prepared by the author, and the mechanical tests performed by Professor Kennedy at University College. From these experiments it is probable that the maximum crushing strength would be obtained with about 0·75 per cent. of silicon, and 2 per cent. of combined carbon.

Transverse Strength.—As before stated, the maximum transverse strength is obtained with metal a little softer than that which possesses the highest crushing strength. Transverse strength depends, at least in part, on the power to resist both a crushing and a tensile force; hence transverse strength is intermediate between crushing and tensile so far as the character of the iron is concerned. This combination of properties imparts to the metal characters which are most valuable in certain cases. For transverse tests many shapes and sizes of test bar have been adopted, and, for scientific purposes, the results so obtained are converted by calculation into values for a bar 1 foot long and 1 inch square. The common test bar in use by founders is 3 feet long, 2 inches deep, and 1 inch broad. By multiplying cwts. recorded with such a bar by 84, the results may be converted into pounds on the standard bar. Or conversely, divide

* *Journ. Chem. Soc.*, 1885, p. 909.

pounds on the standard bar by 84 to obtain cwts. on the ordinary 3-foot bar.

The following numbers illustrate results obtained:—

Experimenters.	Lbs. per sq. in. on bar 1 ft. long by 1 in. sq., loaded in centre.	Cwts. on bar 3 ft. long, 1 in. wide, 3 in. deep, loaded in centre.*	Authorities.
Robert Stephenson, 1847,	{ Max. 3,216 Min. 2,058	{ 38·2 24·5	Pole, <i>Iron for Construction</i> , p. 88.
Hodgkinson and Fairbairn,	{ Max. 2,632 Min. 1,638 Mean. 2,063	{ 31·3 19·5 24·5	
Woolwich, 1858,	{ Max. 2,358 Min. 539 Mean. 1,479	{ 28·1 6·4 17·5	<i>Report</i> , p. 2.
Fairbairn, 1853,	Max. 3,114	37·0	
Turner, 1885,	Max. 3,534	42·1	

It will be noticed that the transverse strength of the standard bar, 1 foot long by 1 inch square, varies from the exceptionally low value of 539 lbs. to 3,534 lbs., corresponding to a variation of from 6·4 to 42·1 cwts. on the common test bar. The average for common iron is about 20 cwts. on the ordinary test bar, while 30 cwts. is required for better-class castings. For specially-good work some South Staffordshire founders can produce a strength of 40 cwts. with tolerable regularity, and as much as 44½ cwts. have been recorded.† In performing transverse tests, care should be taken to avoid even the slightest twist on the specimen, and the weights used should be added very gradually, otherwise low and irregular results are obtained. The size of bar used has also an influence on the strength, smaller sectional areas giving higher values. It should be remembered that the strength of a test bar does not accurately represent the strength to be expected in the casting, if the size of the latter, and the circumstances of pouring, do not pretty closely agree with those of the test bar itself. Some engineers recommend a time test in addition to the breaking test, and such observations are certainly valuable. For example, the ordinary 3-foot bar is sometimes loaded for twenty-four hours with a weight of 20 cwts., the specimen being afterwards tested to rupture. This test gives additional security to the engineer, and is worthy of adoption in cases where a specially-trustworthy product is required.

Tensile Strength.—In many of the less important foundries tensile tests are omitted, but in the better works such tests

* These values are calculated.

† *Iron*, vol. xxix., p. 186.

are generally performed, and appear to be growing in favour. It was shown by the American Ordnance Experiments (1856) that the tenacity of cast iron usually serves as a guide to its mechanical value, and practical experience quite confirms this view. Tensile test pieces are of various forms; they are sometimes used with the skin on, at others the surface is carefully turned; sometimes small pieces are cast separately, while other founders cast the pieces on to the object which is being made. At Rosebank Foundry, Edinburgh, the practice is to cast a test piece on to the top and bottom of each important article; these pieces are afterwards broken off, and carefully turned down to a suitable size before breaking. Such a method is calculated to give a result very nearly approaching what may be expected in the casting itself; for not only is the test piece of the same composition as the casting, but it is also cast under as nearly as possible the same conditions as to temperature, pressure of metal, and rate of cooling, all of which have a considerable effect on the strength of the product.

The following table condensed from a paper by the author will serve to illustrate the results obtained by different observers * :—

Experimenters.	TENSILE STRENGTH.			Authorities.
	Tons per Square Inch.			
	Max.	Min.	Mean.	
Minard and Desormes, 1815,	9·08	5·09	7·19	<i>Tredgold</i> , 4th Edit., p. 230.
Hodgkinson and Fairbairn, 1837,	9·76	6·0	7·46	<i>B. A. Report</i> , 1837, p. 339.
Hodgkinson and Fairbairn, 1849,	10·5	...	6·8	<i>Pole, Iron Construction</i> , p. 79.
Woolwich, 1858,	15·3	4·2	10·4	<i>Report</i> , 1858, p. 2.
Turner, 1885,	15·7	4·75	...	<i>J. Chem. Soc.</i> , 1885, p. 580.
Rosebank, 1886,	18·2	

It will be seen that the highest tensile strength of British iron above recorded (18·2 tons) was obtained in the experiments at Rosebank Foundry in 1886. The average tensile strength obtained by earlier experimenters was about 7 tons, while in 1858 the mean was raised to 10·4 tons. This increase represents a real improvement in the metal tested, and was due to a selection of the more suitable irons as a result of increased knowledge. Foundry practice has since improved, and some engineers now stipulate that a bar 1 inch in section shall be capable of bearing a weight of 10 tons for twenty-four hours without fracture, and this apparently severe test has been com-

* *J. S. C. I.*, vol. v., p. 289.

plied with. Contracts are now satisfactorily executed, in which a minimum strength of 12 tons per square inch is required, and to produce this nothing but Cleveland iron is employed. The author has also succeeded in regularly producing an iron of excellent working qualities, with a tensile strength of from 13 to 13·5 tons per square inch, from a mixture costing under £2 per ton and consisting of cast iron scrap, and siliceous iron. This is a striking instance of the value of combined chemical and mechanical knowledge to the iron-founder.

In foreign cast iron some tensile strengths have been recorded, which have not yet been equalled in Britain, though probably these results are to be regarded as quite exceptional. Thus Professor Ledebur records a tensile strength of 19·1 tons per square inch with German iron,* while the American Commission on Metal for Cannon, in 1856, obtained a maximum of 20·5 tons, and at the Wassiac furnaces, New York, 21·2 tons have been obtained.† Much difference of opinion has been expressed as to the value of tensile tests for cast iron, as the metal is now never used in tension. Professor Ledebur, who is probably the best authority on this subject in Germany, states that tensile tests should always be made, and the author's experience leads to the conclusion that where a complete system of tests, such as that of W. J. Keep, cannot be adopted, no other test affords so good an indication of the value of the metal, as cast iron with high tensile strength is almost invariably soft, sound, and fluid. In the following table seven analyses by the author of samples of cast iron of unusually high tensile strength are given, together with the results obtained at Woolwich, in 1856, and at Wassiac. Full details of the preparation of these samples are given in the original paper.‡

	Woolwich Experiments, 1856, Average.		Rosebank Irons, 1886.				Dumbarton Irons.		Wassiac Iron.	Average.
	...	15·7	18·2	17·1	16·8	16·4	16·68	15·2	18·46	...
Tensile strength— Tons per sq. in.	}		18·2	17·1	16·8	16·4	16·68	15·2	18·46	...
Graphitic carbon,	Per Cent. 2·59	Per Cent. 1·62	Per Cent. ...	Per Cent. ...	Per Cent. ...	Per Cent. ...	Per Cent. 2·90	Per Cent. 2·60	Per Cent. 2·31	Per Cent. ...
Combined carbon,	...	0·56	0·36	0·58	0·52	0·40	0·32	0·30	0·78	0·475
Silicon,	1·42	1·96	1·29	1·50	1·13	1·33	1·34	1·63	1·31	1·434
Phosphorus,	0·39	0·28	0·56	0·47	0·41	0·70	1·09	1·10	0·29	0·587
Sulphur,	0·06	0·03	0·06	0·07	0·06	0·05	0·14	0·12	0·08	0·074
Manganese,	0·58	0·60	1·00	1·00	1·33	0·65	1·38	1·29	1·51	1·037

* *Inst. Journ.*, 1891, vol. ii., p. 252.

† *Inst. C. E.*, vol. lxxiv., p. 373.

‡ *J. S. C. I.*, vol. vii., p. 200.

The average composition shown in the above table may be regarded as typical for good cast iron when the maximum strength is desired, together with soundness and good working qualities. By increasing the silicon the metal becomes more soft and fluid, while by diminishing the silicon the transverse and crushing strength, together with the tendency to chill, are increased.

Keep's Tests for Foundry Iron.—With any uniform material, such as wrought iron or steel, a small sample cut from a larger piece may be said to have very nearly, if not exactly, the same properties and characteristics as the larger piece from which it is taken, and when tested, either chemically or physically, it is generally and properly taken to fairly represent the larger piece. With castings, however, the case is entirely different, as different portions of the same casting may differ essentially from each other in strength, and in other respects, while a small casting, though poured from the same ladle as a larger one, will in all probability give no direct indication of what the larger castings may be in important particulars. For these reasons W. J. Keep has abandoned the attempt to establish a direct relation between the strength and other characteristics of castings and of test pieces, and has substituted therefor a system of testing which is entirely *relative*, but by which every test made in any foundry will be alike. The relation between the results of these tests and the strength and other properties of castings, is simply that experience will show what an iron must stand, by Keep's test, in order to be suitable for certain purposes, and the record of any "Keep's test" made anywhere, or by any one, will be as useful as any other by the same system.

It is much to be desired that some plan could be adopted by which a test-piece casting would indicate exactly and directly the physical qualities of a casting of the same metal; but no method of doing this has been devised, or seems likely to be. Keep's plan is, therefore, presented as the next best thing, and as an excellent practicable test, which has been applied in a number of the chief foundries in the United States. Keep's tests were first described in the United Kingdom in a paper read by the author,* where further details will be found.†

* *S. Staff. Inst.*, 1888.

† The following papers by Mr. Keep will be found of importance by those interested in foundry work:—"Physical Tests for Cast Iron," *Journ. U. S. Assoc. Charcoal Iron Workers*, 1887; "Influence of Aluminium upon Cast Iron," *Trans. Am. Assoc. for Advancement of Science*, 1888; "Ferro-Silicon and the Economy of its Use," *Trans. Am. Inst. Min. Eng.*, vol. xvii., p. 258, 1888; "Silicon in Cast Iron," *ibid.*, vol. xvii., p. 683, 1889; "Aluminium in Cast Iron," *ibid.*, vol. xviii., p. 102, 1889; "Phosphorus in Cast Iron," *ibid.*, vol. xviii., p. 459, 1889; "Aluminium and other Metals Compared," *ibid.*, vol. xviii., p. 798, 1890; "Aluminium in Wrought-Iron and

The tests may be performed either upon the original pig iron, as is more general, or, if preferred, the metal from the foundry ladle may be used. In the former case remelting is performed in a carefully closed crucible in a wind furnace, and experience has shown that when this is carefully performed the changes due to remelting are so small as to be practically negligible. The metal is cast in green sand in the ordinary way, the only difference being that J shaped yokes or chills are inserted in such a manner that the test bars are cast with their ends against a chill of cast iron. The bars are $\frac{1}{2}$ inch square in section and 12 inches long, the chills being made $12\frac{1}{2}$ inches apart so as to allow for shrinkage. In addition to the square bar cast between the chills, as above described, a thin bar, $12 \times 1 \times \frac{1}{8}$ inch is also cast in a similar manner. The tests are now applied to the bars so prepared as follows:—

1. *Shrinkage* is measured by replacing the bars in the yokes between which they were cast, and inserting a graduated wedge between the end of the bar and the chill.

2. *Transverse strength* is determined by means of a specially arranged lever machine, the bar being supported at the ends, and a gradually increasing weight being applied at the centre. At the same time an autographic record of deflection is obtained.

3. *Depth of chill* is ascertained by breaking the end of a bar in the direction of its length and recording the point at which chilling ceases.

4. The *grain of the fracture* is observed under a lens; for this purpose a double convex lens, with a diameter of $1\frac{1}{4}$ inches and a focal distance of $\frac{3}{4}$ of an inch, is recommended.

5. *Resistance to impact* is measured by means of a pendulum hammer, and the height of fall gradually increased until fracture takes place. For this purpose a similar bar is employed to that used for the transverse test.

6. *Fluidity* is measured by using a pattern 1 foot long .06 inch thick, and running the metal from one end. The metal rarely runs the whole length of such a mould, and the length to which it flows gives an indication of the relative fluidity of the iron.

7. Some irons have a tendency to cool irregularly, and to produce distorted or crooked castings. The "*crook*" is determined by means of a 12-inch flat bar, on one side of which a rib is cast, and, when cold, the distance the rib has pulled away the ends of the bar from a straight line is taken as a measure of the crook.

Steel Castings," *ibid.*, vol. xviii., p. 835, 1890; "Aluminium in Carbonised Iron," *Inst. Journ.*, vol. i., 1890; "Manganese in Cast Iron," *Trans. Am. Inst. M. E.*, vol. xx., p. 291, 1891; "Silicon in Foundry Mixtures," *Iron Age*, June 9, 1892. Also papers on "Carbon in Cast Iron," "Sulphur in Cast Iron," "Chromium in Cast Iron," and "Keep's Test applied to Malleable Iron Castings," published in 1893; *Foundry Mixtures*, 1894.

8. *Hardness* is measured by a sclerometer, as introduced by the author, and somewhat modified for this special purpose by W. J. Keep. At the end of a perfectly balanced arm a standard diamond is fixed so that its point rests upon the polished surface of the metal to be tested. By sliding a set of suitable weights along the beam a point is reached when the diamond makes a standard scratch on a standard surface. The weight in grams on the diamond point is a measure of the hardness of the metal. Probably more trustworthy results are obtained by this than any other method, though the values depend to a considerable extent on the skill of the operator.

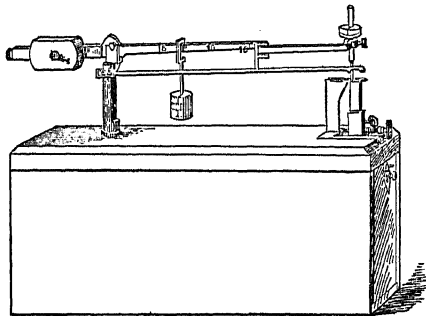

Fig. 56.—Turner's sclerometer.

Malleable Cast Iron.—Ordinary pig iron has the advantage of fusibility and thus can readily be cast in any desired form, but the castings when made are relatively brittle and weak. Forgings in wrought iron, on the other hand, are tough and strong, but are very costly when intricate shapes are required. By the process now to be described, articles are first cast in the ordinary way and then subjected to a special treatment, which confers upon them increased strength, together with much greater ductility, so that they resemble wrought iron in many respects, though the metal so prepared cannot be welded, and is liable to contain blowholes. This process is now largely employed in the neighbourhood of Birmingham, Walsall, and Wolverhampton, for the production of small articles for a great variety of purposes. Malleable cast iron has been in use for many years, since Reaumur wrote a full description of its preparation in 1722, and supplied drawings of the apparatus used and of the appearance of the fracture of the pig iron suitable for the purpose. Many descriptions have since appeared, though the scientific principles underlying the process are still in need of further investigation.

The metal employed in the United Kingdom is a special variety of white iron, which is obtained in the form of small pigs, and is

prepared by refining hæmatite iron so as to as far as possible eliminate the silicon. White iron, prepared in the blast furnace from hæmatite ores, is also sometimes used, but gives inferior results, as it is less regular and is frequently too rich in sulphur, which leads to the production of blowholes in the castings. Such metal should consist of iron with about 3 per cent. of carbon, almost entirely in the combined form, and as little as possible of the other elements—silicon, sulphur, phosphorus, and manganese—which are generally present in cast iron. If much silicon or manganese be present, the iron cannot be “converted” in the subsequent process, while phosphorus produces brittleness in the finished metal. The presence of sulphur, as before stated, tends to the production of blowholes, though the author has often met with as much as 0.25 or 0.3 per cent. of this element without injury. A certain quantity of mottled or grey iron of similar quality, but somewhat richer in silicon, is also used, so as to counteract the effect of remelting, and allow of the use of some scrap from previous meltings.

The iron is broken up and remelted in crucibles in smaller establishments, or in cupolas where larger outputs are required. It is then cast in ordinary green sand moulds, and the castings are cleaned from sand by rotating in iron barrels. The metal is now sufficiently hard to scratch glass readily; it is very brittle, and perfectly white when fractured. The castings are now “annealed” by heating in large covered boxes, which are filled with hæmatite ore. The ore employed is a variety of red hæmatite, which is carefully sorted so as to be in grains of uniform size somewhat smaller than peas. It is not usual to employ new ore alone, but to mix it with ore which has been used in a previous operation, as otherwise the process is too rapid and irregular. Other materials, such as bone ash, burnt clay, and similar substances, may be used instead of hæmatite, and were formerly employed, but have been generally abandoned, as the result is less satisfactory.

When the hæmatite has been frequently used its power of conversion is diminished, and ultimately becomes very small, so that an addition of new ore is made, the quantity added being about one-third of the resulting mixture, though a more oxidising ore is required with large than with small work. The box containing the work to be converted is placed in a suitable furnace and heated, usually by direct firing with coal, though gas furnaces have also been introduced for the purpose. The full heat is continued for twenty-four hours or upwards, according to the size of the castings, and the whole operation of charging, heating, and cooling, takes usually from three days to a week. The castings when withdrawn are grey in fracture, and so soft as to be readily worked with a file or cut with a chisel; they are sufficiently malleable to allow of bending without

fracture, or of being flattened with a hammer, and can thus be readily dressed and finished.

In 1881 Forquignon conducted an important series of experiments on the methods of production, composition, and strength of malleable cast iron, and concluded that malleable castings always contain amorphous graphite, and that the castings may be rendered malleable by annealing without any appreciable loss of total carbon taking place.*

The changes which take place during this so-called annealing process have also been studied by A. Ledebur,† who has shown that the carbon which originally existed in the combined form becomes converted into a special variety of graphite, which does not occur in the ordinary flat plates, but is in a much finer state of division, though in other respects it possesses the properties of graphite, and when dry soils the fingers like ordinary black lead. But experiments conducted by O. Francis at Mason College, under the author's direction, show that a change in the state of the carbon present is not the only alteration due to the prolonged heating with hæmatite. The total carbon is, in practice, always less in the annealed than in the original iron, and usually by at least one-fourth of that originally present. At the same time the hæmatite ore is changed, becoming much darker in colour, and is found to contain metallic iron, which is readily attracted by a magnet, and which dissolves in diluted acids with the evolution of hydrogen. Another somewhat curious change also occurs, for analyses of the annealed samples always show an appreciable diminution of sulphur during the conversion, and hæmatite ore which has been frequently used contains a considerable proportion of sulphur, which is present in such a form as to be eliminated as sulphuretted hydrogen when the material is treated with diluted hydrochloric acid.

The changes which take place may, therefore, be summarised as follows:—The carbon in the iron is changed from the combined to a special variety of the graphitic form, and is diminished in quantity, while some of the sulphur is also eliminated. At the same time the hæmatite ore is partially reduced to metallic iron, and combines with sulphur to form an appreciable quantity of sulphide of iron. How far this change in the proportion of sulphur is connected with the alteration in the state of the carbon is at present undetermined.

* *Ann. Chem. Phys.*, vol. xxiii., p. 433; *Journ. Chem. Soc.*, vol. xlii., p. 116.

† *Inst. Journ.*, 1880, vol. i., p. 388; 1893, vol. ii., p. 53.

CHAPTER XIII.

WROUGHT IRON.

Definition.—Wrought iron may be conveniently defined as commercially pure iron, which, having been produced in a pasty condition, is always associated with more or less intermingled slag. The slag remaining as a sheath around the separate particles or granules of metal causes them to assume an elongated or hair-like form when the metal is rolled into strips or bars, and leads to the production of a characteristic fibrous appearance in the fracture obtained by nicking a bar of wrought iron on one side and then bending it double. The uniformity of the fibre of this fractured surface is an indication of the uniform character of the original granules of iron, and also of careful manipulation in the later stages of preparation, and so is a convenient practical test of the quality of the iron. Wrought iron melts at a full white heat, but below this temperature it assumes a pasty condition, in which it can be readily welded—more readily, in fact, than any other variety of iron or steel. It is ductile when cold, and if heated to redness and quenched in water does not appreciably harden, thus differing from cast iron, which is brittle when cold, and from true steel, which hardens when quenched from a red heat in water.

DIRECT PRODUCTION OF WROUGHT IRON.

In all the processes which were employed by the ancients for the production of wrought iron the metal was obtained from the ore in a single operation. Such processes are, therefore, called "Direct," in distinction from the methods now in general use, whereby cast iron is first produced in the blast furnace, and the crude metal so obtained is afterwards purified by partially oxidising it in a reverberatory or other furnace. The direct process is still employed by all savage races who make iron, and is also in use where the character of the ore, the fuel, or other conditions render the adoption of the blast furnace impracticable. The methods employed for the direct production of wrought iron may be conveniently classified, according to the kind of furnace in which the operation is conducted, as follows:—

1. Open hearths.
2. Small blast furnaces.
3. Tall blast furnaces.
4. Retorts or crucibles.
5. Reverberatory furnaces.

The processes included under divisions 1, 2, and 3 are generally of ancient origin, and the fuel used is charcoal; while those coming under divisions 4 and 5 are more modern, and permit, at least in part, of the use of mineral or gaseous fuel. The number of such methods which have been proposed from time to time is very large, and reference will here be made only to the more representative of them.

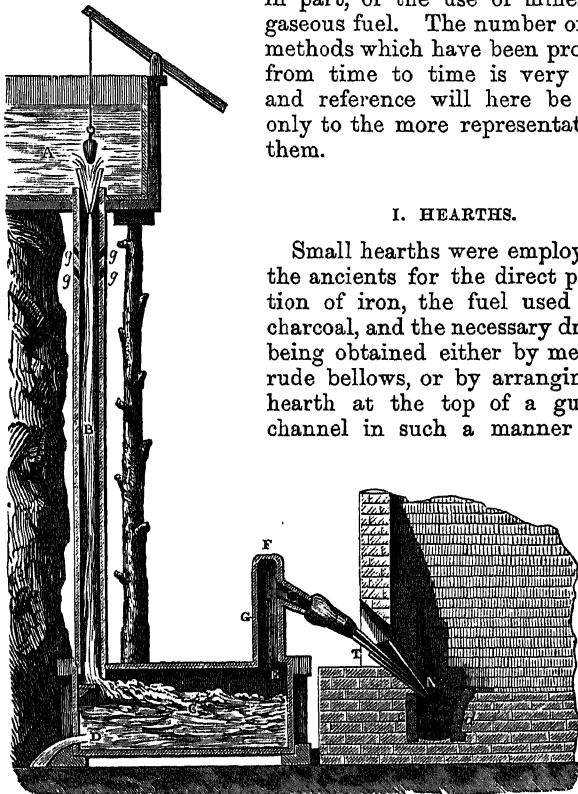

Fig. 57.—Section of Catalan forge.

take advantage of the prevailing wind. Such processes are still used by savage tribes, particularly in Africa, and also survive in some parts of India.

Catalan Process.—A modification of this method of pro-

ducing wrought iron, which was at one time in considerable use in Southern Europe, was known as the Catalan process. The name is derived from the province of Catalonia, in Northern Spain, where, it is probable, the process was first introduced. In principle this was the same as that conducted in the simple hearths above mentioned, the chief difference being that a blast of air of considerable volume, and of a pressure of $1\frac{1}{2}$ to 2 lbs. to the square inch, was obtained by means of a water blower called a *trompe*, and in consequence of the increased air supply, blooms weighing as much as 3 cwts. were produced in about six hours. The *trompe* consisted of three parts—a water reservoir (A) arranged to give a constant head of water; a vertical wooden pipe or hollowed tree-trunk (B) about 25 to 30 feet high, with holes (*g*) in the upper part for the admission of air; and, thirdly, of a wooden chest or blast box. The water in falling down the wooden pipe aspirated air through the openings above mentioned, and air and water together entered the wooden chest below. Suitable openings (D) were arranged for the water to flow away from the bottom of the chest, while the air was conducted by means of a pipe and twyer (E, G, F, T) to the hearth (N). By this process about 3 tons of rich hematite or other pure ore, and nearly 3 tons of charcoal, were required to produce 1 ton of bar iron. As compared with modern processes for treating similar ores, the consumption of ore and fuel were both very high, while the yield in a given time was small, and the cost of labour therefore relatively great. Though formerly conducted on a considerable scale, this process has gradually given way to a newer method, and is now practically extinct. It will not, therefore, be here described in detail, but very full particulars and drawings have been given by Dr. Percy,* and may be consulted for further details.

American Bloomery.—This is probably the most important of any of the direct processes when judged by the annual output of wrought iron. It is practised chiefly in the Western States where charcoal can be obtained and where a rich finely divided magnetic ore, which is often titaniferous, is employed. In principle the process is identical with that formerly adopted in Catalonia, though a number of modifications in detail have been introduced with the object of saving labour and fuel. Thus the sides of the hearth are of iron, and being water-cooled last almost indefinitely, while the blast is produced by steam power or by a water wheel, and instead of being used cold, as in ancient times, is warmed by circulating through cast-iron pipes heated by the waste heat of the furnace. The arrangement of an American bloomery is thus very similar to that of a Styrian steel works, which is described in detail in a later

* *Iron and Steel*, pp. 278-315.

chapter, see p. 264, the chief difference being that while in the bloomery wrought iron, or, if required, steel, is produced from the ore in a single operation, in the Styrian process pig iron is first produced and this is employed for the preparation of wrought iron or steel. The American bloomery, as already explained, is only suitable for a particular class of ore and for charcoal, so there is no likelihood of it being introduced into the United Kingdom. It suffers from the disadvantages inherent in all direct processes—namely, that the yield in a given time is relatively small, while the cost of labour and fuel and the loss of iron in the slag are greater than with modern processes in which the blast furnace is employed for the preliminary elimination of the impurities of the ore. For details of this process an illustrated description by H. M. Howe should be consulted.*

It will be observed that in the direct processes which have been described, as with the majority of those which are afterwards mentioned, the fuel used is charcoal, and that coal or coke cannot, except in one or two special instances, be employed. This is due to the fact that the spongy iron, which is produced at a low temperature, readily absorbs any sulphur present in the furnace charge, with the result that the finished metal is red—short, and inferior, if either mineral fuel or sulphurous ores be employed. Charcoal being much more free from sulphur, and at the same time a more active reducing agent, is therefore employed in preference.

Reactions.—The chief reaction which occurs in the small charcoal hearths or furnaces employed in Catalonia, India, America, and elsewhere, is probably that between solid carbon and the iron ore, thus :

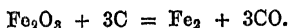

leading to the production of metallic iron on the one hand and carbon monoxide, which burns at the top of the furnace, on the other. At the same time, part of the oxide of iron combines with the silica and other gangue to form an easily fusible slag, consisting essentially of ferrous silicate ($2\text{FeO} \cdot \text{SiO}_2$), and this being basic in character, and the temperature of reduction comparatively low, leads to the greater part of the phosphorus present passing into the slag. It is thus possible, by the direct process, to produce an iron of considerable chemical purity from phosphoric ores, while, when pure magnetites are used, the iron obtained is of exceptional quality, suitable for the production of tool steel and similar purposes. The iron made by such processes is, however, apt to be irregular in carbon content, the outer part of the bloom being more carburised than the interior. This can be to some extent obviated by careful attention to maintain a fairly oxidising atmosphere when making wrought iron, while a

* *Metallurgy of Steel*, p. 270.

steely iron is not unfrequently intentionally produced by using a blast of somewhat lower pressure, and inclining the twyer so as to keep the lower part of the furnace filled with a more reducing atmosphere. It is thus possible, by slightly varying the working conditions, to produce either wrought iron or steel in these simple furnaces directly from the ore.

II. SMALL BLAST FURNACES.

¶ **The Osmund Furnace.**—This was a small blast furnace which occupies an intermediate position between hearths, such as the

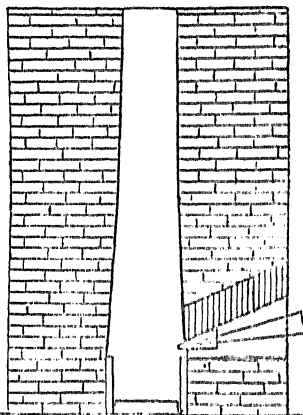

Fig. 58.—Section of the Osmund furnace.

Catalan forge and the high-bloomery or Stückofen, formerly employed in Germany. This furnace, which is shown in section in Fig. 58, was in use in Finland and the North of Europe from before the introduction of Christianity until 1875, and is possibly still employed in remote districts. The ore used was the native bog or lake ore, which is dredged in the early autumn while the ice is thin, from the bottom of lakes or rivers; it consists of easily reducible brown hematite, tolerably rich in phosphorus. The ore was first dried by exposure to the air, and calcined in heaps, using wood as fuel; it was afterwards smelted with charcoal and a bloom of wrought iron obtained, which was called an *osmund*, from which term the furnace derives its name. The phosphorus originally present in the ore passed almost entirely into the slag, which was easily fusible, and rich in iron. The furnace was constructed of masonry, which was frequently surrounded by earth held together by a casing of timber; blast was introduced through a single twyer by means of hand bellows; the hearth of the furnace was rectangular, and a tapping hole was provided for running off the slag, while the front of the furnace was removed at the conclusion of each operation to allow of the extraction of the finished bloom. The blooms made in such a furnace would not weigh more than 30 cwts. per week, and these would suffer a loss of at least 33 per cent. in subsequent working. This furnace has been illustrated and fully described by Dr. Percy.*

* *Iron and Steel*, p. 320.

Small Blast Furnaces in India.—For the direct production of wrought iron in British India the natives employ open hearths, small blast furnaces, or tall blast furnaces, according to the nature of the ore, and more particularly of the charcoal which is employed. The following description of the production of wrought iron in small blast furnaces in India is condensed from a paper by the author.* Fuller details and references are given in the original.

Ore Supply.—The natives in India never use magnetite in the massive form if it can be by any means avoided, as this would not only involve the labour of mining, but the lumps of ore would require to be broken by hand to small pieces, while the finer particles thus produced would be carefully separated and thrown away. The native workmen, therefore, generally select the weathered pieces of ore which are found on the surface of magnetic deposits, and which are either already in small pieces or which can be readily broken. In some cases, as in the Khasi Hills and in Malabar, concentrated ore, obtained by washing a decomposing granitic matrix is employed. At Rajdoha, in Central Bengal, a weathered magnetite, which occurs in the form of small brown lumps, of tolerably uniform size, is the chief ore which is treated. Each lump consists of an unaltered kernel of black magnetite surrounded by a shell of brown ore. An analysis, performed under the author's superintendence by H. Harris, gave the following results:—

Ferric oxide (Fe_2O_3),	Per Cent.
Ferrous oxide (FeO),	69.65
Silica (SiO_2),	19.50
Manganous oxide (MnO),	5.83
Alumina (Al_2O_3),	0.22
Lime (CaO),	0.51
Magnesia (MgO),	0.36
Sulphur (S),	trace
Phosphoric anhydride (P_2O_5),	0.02
Moisture at 100°C .,	0.03
Combined water and loss,	0.60
	3.28
	<hr/>
	100.00

From this it will be seen that nearly 90 per cent. of the ore consists of oxide of iron, and the metallic iron amounts to 63.92 per cent. The proportion of phosphorus is exceedingly low, and there is little more than a trace of sulphur.

Fuel.—In an interesting handbook, No. 8 of the Imperial Institute Series, Indian Section, published by authority in 1892, and written by T. H. Holland, Assistant-Superintendent of the Geological Survey of India, an account is given of the manufacture of iron in the southern districts of the Madras Presidency. From this it appears that the scarcity of fuel is the great draw-

* *Inst. Journ.*, 1893, vol. ii., p. 162.

back to the development of the enormous iron ore deposits of Southern India, the only carbonaceous deposits hitherto discovered being beds of bituminous shale or small deposits of lignite.

The fuel which the natives prefer, where it can be obtained, is charcoal made from the wood of the *Albizia amara*, a deciduous tree of moderate size, with a mottled hard heart wood, and concentric alternating light and dark bands. This tree grows up to an elevation of about 1,000 feet; its wood is also used for building and other purposes, while the crooked branches are employed for ploughs. Where other wood cannot be obtained bamboo charcoal is employed. This is soft and friable, and in pieces, few of which exceed 2 inches in length or 1 inch in thickness. It contains about 8 per cent. of ash, 8.7 per cent. of moisture, and, by difference, 83.3 per cent. of carbon. It is, therefore, an inferior fuel, both as regards character and composition, though perhaps the ash may act advantageously as a flux during smelting.

Small Blast Furnaces.—At Rajdoha small blast furnaces are employed, which are made of a mixture of mud from the hills of



Fig. 59.—Blast furnace and native iron workers, Salem District, India.

white ants, together with rice straw. The furnace is 4 feet 6 inches in height, and tapers from an external diameter of 3 feet 6 inches at the base to 1 foot 10 inches at the top. The interior of the furnaces tapers in a similar manner from a diameter of 5 inches at the top to 1 foot 5 inches at the point where the bloom is formed. The blast is introduced by a single twyer, which consists of a hollow bamboo set with clay. The air is forced by means of a pair of goat-skin bellows, which are worked by hand by a native squatting on the ground. Small blast furnaces of similar construction, though differing slightly in detail, are used in many parts of India, and also in Africa.

A small blast furnace of this kind as used in the Salem district, and the native workmen, is shown in Fig. 59, from a photograph by T. H. Holland. The process described to the author by G. Davis as being conducted by the natives of Mashonaland, is almost identical with that practised at Rajdoha. At Rajdoha a charge is worked off in about six hours; this requires about 106 lbs. of charcoal, and yields an irregular pear-shaped bloom of crude iron, weighing about 38 lbs.; no flux of any kind is added. When the bloom is ready, the thin wall of the front arch is taken down and the iron removed. The bloom, while still hot, is hammered into an irregular disc, and cut up into pieces about 8 inches long and $2\frac{1}{2}$ inches square; these pieces weigh about 5 lbs. each, and are in a convenient form for subsequent reheating and working into bars. The cutting up of the iron in this way also ensures much greater uniformity in the finished product.

The following analyses by H. Harris illustrate the composition of the crude iron, and of the finished bar produced at Rajdoha:—

	Crude Iron.	Finished Bar.
Carbon,	{ 0·660 (chiefly charcoal) }	0·030
Silicon,	{ 1·113 (chiefly slag) }	0·010
Sulphur,	0·005	trace
Phosphorus,	0·028	0·013
Manganese,	0·013	nil.
Iron, by difference,	98·181	99·947
	100·000	100·000

As might be anticipated from this analysis, the bar is soft and tough, works splendidly in every way, and is in great demand where it can be obtained, on account of its excellent quality. If this analysis fairly represents the character of the iron produced in India, it is evident that the metal is equal to the best obtainable from any other source, and suitable for the production of steel of the very best quality, and for use for electrical purposes when absolute purity is so much desired. Its composition supports the statement made in an official Indian handbook, that the metal is "perfectly tough and malleable, and superior to any English iron, or even the best Swedish."

The slag produced at the same time as the above-mentioned iron had the appearance of tap cinder, but contained a number of cavities, apparently due to enclosed gas, and also fragments

of partly-consumed charcoal. Its composition was as follows, the analyses being by H. Harris:—

	Per Cent.
Ferric oxide,	8.13
Ferrous oxide,	73.95
Silica,	10.33
Manganous oxide,	0.23
Alumina,	1.85
Lime,	2.49
Magnesia,	1.07
Sulphur,	0.03
Phosphoric anhydride,	0.35
Charcoal and loss,	1.57
	100.00

This corresponds with 63.21 per cent. of iron, and it is evident from the increased proportion of lime, magnesia, and phosphorus, as compared with that present in the ore, that some, at least, of these constituents must have been derived either from the ash of the fuel or the walls of the furnace.

III. TALL BLAST FURNACES.

To this class belongs the ancient blast furnace or Stückofen of Germany (Fig 1), which is now entirely abandoned in civilised countries. In the district of Malabar in Southern India, however, the natives use tall blast furnaces, which from the hearth to the throat are 10 feet high, and rectangular in section. At the throat the inside measurement is 1 foot from front to back, and 3 feet from side to side. The interior of the furnace is widest about 4 feet from the top, where it measures 2 feet from front to back, and 3 feet 6 inches from side to side; from this point the furnace narrows down to the hearth.

Several furnaces are built together, and the walls below extend into a common platform, while above they are about 2 feet thick. The front wall of the furnace is only 3 inches thick, but is strengthened with wedges made of hardened clay and straw, and shaped like a 60° set square; these wedges are inserted between the furnace itself and a wooden framework which binds the furnace together. The furnace walls are built of a mixture of red clay and sand. The platform above-mentioned is a solid structure, and adds greatly to the strength of the erection, while at the same time it acts as working-place for the man who charges the furnace. Immediately behind each furnace a pit is hollowed out, and into this the slag trickles, through a hole in the bottom of the furnace, and cools as a black ropy-looking mass.

In front of each furnace two small platforms are erected, on each of which is a pair of goatskin bellows. Each pair of bellows is worked by one man, and the blast is introduced by separate

clay twyers, one on either side of the front of the furnace. Between the two twyers, in the front of the furnace, a row of about a dozen clay tubes is placed; these tubes enable the workman to see the interior of the furnace, and their ends are stopped with a daub of wet clay when not being thus used as peep-holes. In these furnaces a bloom of iron weighing 5 cwts. is produced in from forty-eight to sixty hours; the bloom is removed by breaking down the lower front of the furnace, when the iron is allowed to cool for two days and is broken into small pieces for the market.*

The chief seat of the iron manufacture of Malabar is at Nellumboor, where the ore used is a black magnetite which is found in lodes in the laterite, or as gravel in the river beds. It is used in the condition of a powder, which is sometimes washed before smelting; the fuel is charcoal, which is made in circular holes in the ground, from the wood of the irool tree, which yields a coarse hard timber. The timber is cut into pieces about 9 inches long and 4 inches in diameter, and yields a bright hard charcoal. A small quantity of flux is added in the form of sea-shells brought from the coast. The charge is added in small quantities at a time, each addition consisting of about 4 lbs. of ore, 8 lbs. of charcoal, and a few shells. The yield is only about 20 per cent. of the ore used; the product consists of two qualities. One of these is fibrous and is sold to the smiths, who forge it by hand, the other is crystalline and steely, and is melted in small crucibles for the production of steel.†

The direct process adopted by the natives of India is not without its advantages, and is perhaps, under the circumstances, preferable to the production of cast iron as a preliminary stage of the process. Ore is so abundant that the use of fluxes is not necessary on the score of economy, while the production of a slag rich in ferrous oxide assists in removing phosphorus, when this element is present either in the ore or fuel; at the same time it renders the slag very fusible, and so saves fuel, and diminishes the danger of carburisation. The scouring effect of the slag on the sides of the furnace is but a slight drawback when the simplicity of the structure is remembered, and the fact that the materials used in its construction are met with on the spot, while at the end of each operation a considerable part of the furnace is necessarily broken down, to allow of the removal of the product. If the native industry were conducted under proper direction also, instead of leading to the destruction of timber as at present, it might lead to the conversion of large areas of what is at present waste land into productive forests.

For these reasons Holland is of opinion that the future of iron smelting in southern India is a forest question, and points out, on the authority of Sir Deitrich Brandis, that if a

* T. H. Holland, *Imperial Inst. Handbook*, 1892, No. 8, p. 16.

† *Inst. Journ.*, 1891, vol. ii., p. 254.

large manufactory were erected to produce 10,000 tons of wrought iron per annum, by methods similar to those at present in use, some 35,000 tons of charcoal, or 140,000 tons of wood would be needed, and to obtain an annual production of this quantity of timber an area of 437 square miles of land, of suitable quality, in the immediate neighbourhood of the works would be required. Success is therefore much more likely to be obtained by a number of small works than by one large one, and in this respect the conditions resemble those which prevail in Styria and in Western America.

H. M. Howe also points out that the direct process is more specially applicable in some cases than others, and considers that its advantages are more marked with rich ores; with cheap ores, especially when de-phosphorisation is needed or where fuel is dear; and lastly with fuels of high calorific power which are low in sulphur, but which for physical reasons cannot be employed in the blast furnace. In these cases gaseous fuel may be employed, and thus materials utilised which are unfit for use in blast furnace work.*

The Husgafvel Process.—The Osmund furnace had been in use in the North of Europe with little alteration for many centuries, when in 1875 Husgafvel commenced experiments with the object of obtaining better results, with larger furnaces of this type. The result was not satisfactory, as the furnace had to be blown out with the production of each bloom, and thus much time and fuel were wasted. This difficulty was at length overcome by the adoption of a movable cast-iron hearth, and the height and capacity of the furnace were subsequently increased with considerable advantage.

The Husgafvel furnace, which is shown in half elevation in Fig. 60, consists of a wrought-iron shell resembling an ordinary blast-furnace casing, but surrounded by another wall or shell extending from the hearth to the throat; the space between the two shells is divided by spiral partitions, and thus forms a continuous spiral flue, coiled, as it were, around the furnace. The blast passing through this flue is heated to about 200°. The circulation of the blast through this flue is regulated by a series of dampers, and if the blast temperature be too high the connection with the upper part of the flue is cut off. The furnace is provided with four tuyers, two on either side of the hearth, while there are two holes for each tuyer, one over the other, the former being used when there is little metal in the hearth, and the latter towards the end of an operation. The hearth stands upon a platform which can be raised or lowered a few inches, so as to allow of the production of a tight joint at the interval between the hearth and the furnace being luted with clay. The slag is tapped off into a car through four ta-

* *Metallurgy of Steel*, 260.

ping holes, one above the other, in the movable hearth. The charge required to produce a ton of iron consists of about 7 tons of lake ores, 1 ton of puddling cinders, and 160 bushels of charcoal. From two-thirds to four-fifths of the phosphorus

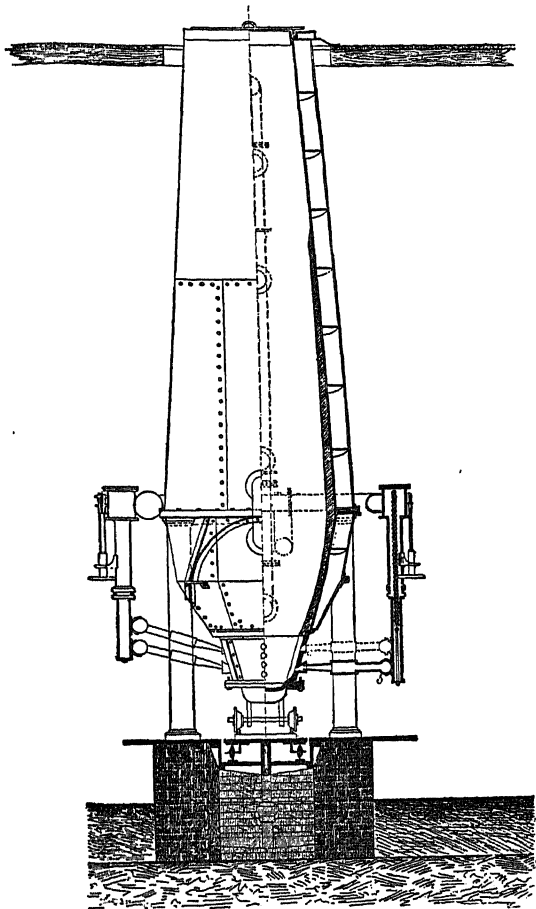

Fig. 60.—Husgafvel furnace—part section.

present in the charge is eliminated in the slag, but the blooms produced still contain too much phosphorus to be hammered and rolled, and are melted on the hearth of the basic Siemens furnace. It is found that the materials in the furnace sink rapidly on the side at which the new hearth is introduced,

in order to equalise this effect, the hearths are introduced alternately from opposite sides. The blast, in passing between the walls of the furnace, cools the materials, and to a great extent concentrates the reducing action in the lower part of the furnace; consequently, the reduced iron has not time to take up sufficient carbon to produce cast iron. As the iron forms it sinks below the thin fluid slag, and in so doing, the carbon it has taken up is more or less oxidised, the amount of oxidation being regulated by the direction given to the blast, and by the composition of the charge. If hard iron or steel be desired, the temperature of the lower part of the furnace must be increased, and the inclination of the blast into the hearth diminished. When the operation is taking place properly, the light from the twyer hole is clear and bright, and the flame from the throat bright and lively; while the slag should be light in colour and thoroughly fluid. If the furnace has been driven too fast, or if too much ore has been charged, the slag has a yellowish-red colour, indicating a great loss of iron. With increasing carburisation, on the other hand, the slags become less fluid. The amount of iron in the slags varies from about 18 per cent., when the softest kind of iron is produced, to about 7 per cent., when the product is somewhat steely. When soft iron is produced, at least two-thirds of the phosphorus present in the ore may be eliminated in the slag; but when the ore is reduced as completely as possible, the greater part of the phosphorus goes with it, so that if the product be high in carbon, it is also rich in phosphorus. It is not advisable to have the iron too low in carbon, or oxygen is absorbed, and the product is apt to exhibit red-shortness. In some works magnetite ores are used in the Husgafvel furnace; the materials, both ore and slags, are then crushed small, and a corresponding improvement of output is observed.*

IV. RETORTS.

During the last half century a very large number of processes have been suggested or introduced, with the object of producing iron in a state of commercial purity direct from the ore, and at the same time avoiding the disadvantages inherent in the more ancient methods. Few of these modern suggestions have been carried out on any considerable scale, still fewer have met with commercial success, and at present there is no direct process known which has proved itself capable of competing for a lengthened period with the indirect or blast furnace process, where the conditions are favourable to the latter method.

Chenot Process.—One of the earliest suggestions which met

* See J. L. Garrison, *Amer. Inst. Min. Eng.*, Feb., 1888; also, *Inst. Journ.*, 1887, vol. ii., p. 299; 1889, vol. i., p. 325.

with general attention was that introduced by Chenot, a sponge of iron obtained by this process having been exhibited at the 1851 exhibition, while a gold medal was awarded to the inventor at Paris in 1855.

Several modifications in detail were afterwards introduced, but the process, as conducted at Hautmont, was as follows:—The ore used was a rich oxide from Sommorostro, in Spain, and was broken into pieces less than 2 inches cube. If poor or finely divided ores were employed, they were first concentrated and compressed, sometimes with the addition of a little resin, to promote adhesion. The ore was then mixed with rather more than its own bulk, or about one-fifth its weight of charcoal, this quantity being more than sufficient for reduction. The mixture was then charged into the heating chamber, which consisted of a rectangular retort 28 feet high, and rather more than 6 feet long and 18 inches wide. Two such retorts were placed vertically side by side; they were supported on a pedestal of masonry, and surrounded by an elliptical truncated cone of firebrick and masonry, so as to allow of their being externally heated. The result of the operation was the production in about six days, including the time required for heating and cooling the furnace, of a sponge of metallic iron which weighed about 12 cwts., while 30 cwts. of rich calcined ore, nearly half a ton of charcoal, and 26 cwts. of coal were used. If this sponge of iron were allowed to come into contact with the air while warm, it would at once burn and form ferric oxide. To avoid this a rectangular case of sheet iron or cooler was provided at the base of each retort, while below the cooler, and on a level with the ground, was a waggon running on rails for removing the cold sponge. The iron sponge, if properly reduced, was iron grey in colour, and so soft as to be easily cut with a knife, while it oxidised so readily that it might be ignited with a match. The sponge was either compressed, reheated, and rolled into bars of wrought iron, or if desired, was converted into steel by melting in crucibles, or at a later date on the hearth of a Siemens furnace. By a modification of the Chenot process, the ore was heated and reduced at once by the introduction of reducing gas in regulated quantity at the bottom of the retort. In practice the Chenot process proved slow and costly, and has now been almost, if not entirely, abandoned.*

In the Blair process for the direct reduction of iron from the ore, an attempt was made to improve the Chenot process and render it commercially successful. Each furnace consisted of a group of three vertical retorts, each 3 feet in diameter and 28 feet high, and surrounded by a casing of brickwork, arranged so as to leave a combustion chamber between the outside of the firebrick retorts and the inside of the masonry. The retorts were heated externally by gas jets, while ore mixed with carbonaceous

* For full details see Percy, *Iron and Steel*, pp. 335-345.

matter was fed into the retorts. In a subsequent modification of the process vertical firebrick retorts were used, but the heating was accomplished by a stream of hot carbon monoxide in the interior of the retorts; other modifications have also been proposed. The result of the operation was the production of a sponge of metallic iron, which was cooled rapidly so as to prevent oxidation, and afterwards melted in crucibles to obtain tool steel, if the ore used were of special purity; in other cases the sponge was melted in the Siemens furnace. Details of the operation and drawings of the apparatus have been given by J. Ireland.* A process almost identical with that described by Ireland had been carried on independently, though only on a small scale, in America, by Mr. Yates, in 1860.†

In the later modification of the Blair process finely divided ore, or concentrates, is mixed with ground charcoal, and the mixture is charged into hollow cast iron retorts, which are placed horizontally and heated externally. In each retort a hollow water-cooled arm, provided with plough-blades, revolves so as to incorporate the materials. Reduction is complete in about three and a-half hours, and the product is cooled, mixed with pitch, and sold for the manufacture of open hearth or crucible steel. It may also be balled up in the puddling furnace.‡

The Adams (or Blair-Adams) Process.—One important modification of this process has recently been introduced in America, in which form a mixture of fine ore with about 15 per cent. of coal is charged into a vertical rectangular chamber (Fig. 61), which is tapered to allow of the ready descent of the charge. Reducing gas enters through a number of openings at the sides of the vertical chamber, and assists in the reduction of the ore. This gas is first heated to about 1,000° F. by passing through regenerator chambers. The reduction is accomplished in about five hours, no temperature above a red heat being employed, and the chambers are sufficiently large to hold the materials necessary to produce 20 tons of iron; so that nearly 100 tons of malleable iron can be produced in twenty-four hours. This furnace has been worked at Pittsburg, and the iron produced has been transferred directly to the hearth of a Siemens steel melting furnace.§ It may however, if desired, be allowed to cool in a close chamber, as shown in Fig. 61, taken from the *Journal of the Iron and Steel Institute* (Amer. vol., p. 317).

This drawing illustrates the principle of one form of apparatus used for the Blair-Adams process at Pittsburg. The ore is introduced through the hopper at the top, and passes into the tapered reducing chamber, through which reducing gases pass

* *Inst. Journ.*, 1878, vol. i., p. 47.

† *Ibid.*, p. 229; Percy, *Iron and Steel*, p. 345.

‡ *Iron Age*, vol. xlii., p. 119; *Inst. Journ.*, 1889, vol. i., p. 328.

§ *Inst. Journ.*, 1890, vol. ii., p. 766.

in the direction shown by the arrows, the gas afterwards passing down to the regenerators below. The spongy iron produced is received into the cooling chamber at the base of the retort, and when cold can be compressed, and either reheated and rolled into bar iron, or melted for the production of steel. In this instance solid fuel is dispensed with, and reduction is accomplished by gaseous materials. On some of the commercial aspects of the

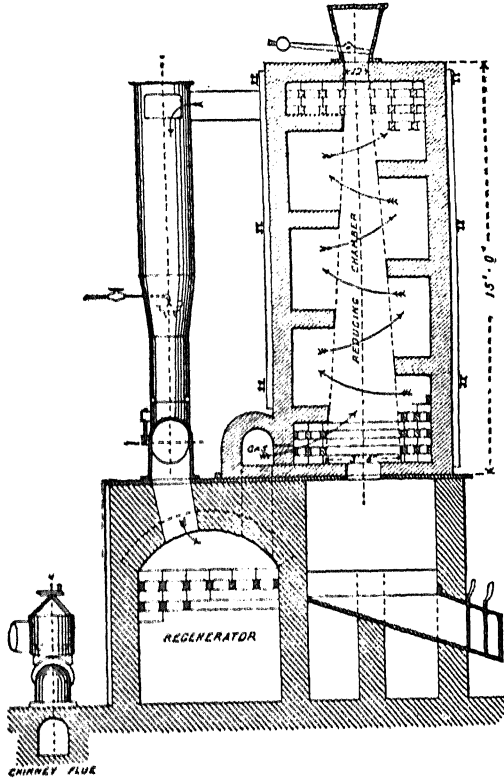

Fig. 61.—The Blair-Adams direct reduction furnace.

process the remarks of Sir L. Bell (*ibid.*, p. 188) may be read with advantage, though they are unfavourable to the ultimate success of the plant, as this authority estimates the cost of production of iron by Blair's process to be greater than by Siemens rotating furnace, which will be afterwards briefly described, and to be still greater than the cost of production by the relatively inexpensive American bloomery.

V. REVERBERATORY FURNACES.

One of the first, if not indeed the earliest, of the attempts to produce wrought iron directly from the ore in a reverberatory furnace was made by W. N. Clay, who had previously, in 1837, obtained a patent in which iron ore was reduced by heating with charcoal in a clay retort. This method proving unsuccessful, Clay charged the materials on the bed of a puddling furnace, and so in a single operation produced wrought iron, which was hammered and then rolled into bars. The ore used was hæmatite, which was previously passed through a $\frac{1}{2}$ -inch riddle, and mixed with coal slack. The slack was prepared by washing in salt brine, and only the portions which floated were used. A mixture of soda ash, fireclay, and salt was also added, in proportion equal to about 12 per cent. of the ore employed, so as to flux away the impurities. A quantity of pig iron was added, in some cases, to assist in reducing the ore charged. The process was conducted on a commercial scale at several establishments, but in each case was ultimately abandoned, as the time taken was longer than in the ordinary puddling process, while the cost was greater and the quality of the product less uniform.* Some years after Clay's process had been abandoned in England the idea was revived in America by J. Renton, who, in 1851, employed a reverberatory furnace for the direct reduction of iron ore—the chief alteration introduced by Renton being the use of a firebrick chamber some 10 feet high and 6 feet by 7 inches in section. This chamber was heated from the outside by the waste gases of the puddling furnace, and acted as a vertical retort in which preliminary heating and reduction occurred. The materials then fell on to the bed of the puddling furnace and were balled up as in Clay's process.† This plan was adopted for a few years at Cincinnati, Ohio, and Newark, New Jersey, but was abandoned after having been thoroughly tried and proved to be commercially unsuccessful.

Numerous attempts to carry out Clay's process, with improvements in detail, have since been made, but it will probably be sufficient to refer to two of them, one due to the late Sir W. Siemens, and the second an American attempt to overcome some of the difficulties inherent in the Siemens direct process.

Siemens Rotating Furnace.—After having experimented for some time with direct reduction in retorts, Sir W. Siemens in 1873 at length adopted a rotating-cylindrical furnace, which was made of wrought-iron plates rivetted together, forming a chamber about $10\frac{1}{2}$ feet long, and the same in greatest diameter. This cylinder was arranged with its axis horizontal, was lined internally with a basic lining consisting of bauxite, magnesia

* Percy, *Iron and Steel*, p. 330.

† *Ibid.*, p. 334.

bricks, or other suitable materials, which were again covered with a lining of oxide of iron, which was obtained by introducing a quantity of ferric and magnetic oxides, and strongly heating while the furnace was caused to revolve. In this way a firmly-adherent and yet infusible covering was obtained, which was not attacked by the ferruginous slags produced during the subsequent operation. The rotating furnace was heated internally by means of producer gas and air, which were admitted at one end, while regenerators were employed so as to economise heat and allow of the production of a high temperature. The working door of the furnace and the slag holes were at the opposite end of the heating chamber to that by which the gas entered, while water-cooling rings were provided at each end, so as to diminish the wear of the vessel. The gases entered with a velocity sufficient to cause them to circulate right round the heating chamber, and to allow of the products of combustion being drawn off by chimney draught from the same end as that by which the gases entered. The ore employed was generally rich and easily reducible; it was obtained of the size of beans or peas, and, if necessary, a little lime or other fluxing material was added. To about 1 ton of such ore about 12 cwts. of roll scale (a rich variety of magnetic oxide of iron) and 6 cwts. of charcoal or small soft coal were added. The furnace was then caused to slowly rotate, by means of a small steam engine, during some three or three and a-half hours, when a ball of about 9 cwts. of wrought iron was obtained, and the furnace, after tapping off the slag and being slightly repaired, was red hot, and ready to receive another charge. As a large ball would necessitate the use of larger machinery, it was found convenient to arrange a number of prominences in the furnace lining, so as to split up the charge into several smaller balls, and this arrangement had the additional advantage that it prevented the charge sliding round as the furnace rotated, and so ensured the charge being properly mixed. It will be noticed that the amount of iron actually obtained by this process did not represent nearly the whole of that present in the charge, and the rotating furnace was not only wasteful in this respect, but was also very costly in repairs. At the same time, the very basic and fluid slag obtained led to the almost complete removal of phosphorus and sulphur, and hence to the production of pure iron. Whether even the genius of Sir W. Siemens, if he had lived, could have ultimately led to modifications which would have ensured success, is doubtful, but it is a fact that soon after his death the process was abandoned, and is now not applied in any of the iron-making countries of the world.

Eames' Direct Process.—A more recent process, described by A. E. Hunt, and adopted at the works of the Carbon Iron Company, Pittsburg, is based on precisely the same principle

as that last mentioned, but some details are modified with the object of reducing the loss of iron and cost of repairs.* The ore employed is obtained from Minnesota, and contains from 62 to 65 per cent. of metallic iron. It is ground to a fine powder, in mixture with graphite, or in the latest modification, with coke and a little lime, so as to pass through a sieve with sixteen meshes to the inch. The charge consists of 20 cwts. of ore, 5.35 cwts. of coke, and a little lime; the object of the use of coke and lime instead of charcoal, is to retard the combustion of the carbon, and so give time for the oxygen of the ore to combine with the coke. This diminishes the waste of carbon in the early stages of the operation, while the lime probably also tends to combine with sulphur, and so improve the quality of the product. The mixture, prepared as above described, is reduced at a moderate temperature on the bed of a gas-fired puddling furnace, which may be heated with natural gas. If the temperature be allowed to rise unduly, the iron sponge will absorb phosphorus from the ore, and the loss by oxidation will also be excessive. When reduction is accomplished, the sponge is taken to a rotary squeezer, and the greater part of the slag is removed. The iron can then, if preferred, be shingled, and afterwards rolled into bars, though usually it is charged, while still hot, on to the bed of an open-hearth steel-melting furnace, and by melting with a suitable addition of pig iron is ultimately converted into steel. In this process the cost of the preliminary grinding of the ore is considerable, and it is estimated that if conducted in England in 1892, the blooms which, after squeezing, contain about 93 per cent. of metallic iron would cost about £4, 15s. per ton. The process is stated to have given satisfactory results in Pittsburg, but has not yet been adopted in any European iron-making district, nor is it likely to be so applied if the above estimate is correct, as finished iron or steel produced by other methods could be purchased for less money.†

* *Inst. Journ.*, 1888, vol. ii., p. 252; 1889, vol. ii., p. 423.

† *Ibid.*, 1882, vol. ii., p. 252; special volume, pp. 321, 499.

CHAPTER XIV.

INDIRECT PRODUCTION OF WROUGHT IRON.

CLASSIFICATION OF PROCESSES.

It has already been stated that, by the ancient processes, wrought iron was obtained by a single operation from the crude ore. It has also been shown that during the middle ages, at a period, the exact date of which cannot now be fixed with certainty, tall blast furnaces became general, and cast iron was regularly produced. That this is the cheapest and most convenient method of producing iron follows from what has been before written. Unfortunately, however, cast iron is not malleable, and cannot be worked by the hammer either when hot or cold, so that it becomes necessary to remove the greater part of its associated impurities before it can be employed for the purposes of the smith, or the numerous other useful applications to which it is put in daily life.

This further purification is always accompanied by means of oxidation, though the details of the process employed vary according to whether the necessary oxygen is supplied chiefly from the atmosphere, or from other materials added for this purpose, and as to whether the iron to be purified is heated in contact with the fuel, or whether it is heated in a separate furnace or chamber to that in which the fuel is burned. For simplicity, the furnaces used for the indirect production of wrought iron may be classified into—(1) hearths, and (2) reverberatory furnaces. In hearths the chief source of oxidation is atmospheric air, and the fuel is burned in contact with the iron to be treated; while in reverberatory furnaces the chief source of the necessary oxygen is magnetic oxide of iron, or other added oxidising materials, and the fuel is burned in a chamber separate from, though in communication with, that in which the metal is heated. The methods of production of wrought iron from cast iron may also be classified according to whether the operation is performed in a single furnace, or whether it is conducted in two stages, for each of which a separate furnace is usually required. When only one furnace is used, the iron operated upon is white, and the carbon combined; while when two furnaces are needed, the first is called a refinery, and the operation conducted in this is merely preparatory, and leads to

the elimination of silicon from the grey iron which is used, in order to convert the carbon from the graphitic to the combined form, and the grey iron into white.

I. HEARTHES.

The date at which hearths were first employed for this purpose is unknown, though it was doubtless shortly after cast iron came into general use. It is probable that, in accordance with the ideas of the time, some German iron worker, finding that a single application of fire to the crude iron ore led to the removal of so much impurity and the production of an impure metal, argued that a second application of the same purifying agency might be again beneficial. No doubt, if this were so, the result of his experiment appeared to fully justify the theory upon which he acted. In all probability the early hearths were little more than small holes dug in the ground, such as are used in some parts of India for the same purpose at present; or possibly an ordinary smith's hearth may have been used, in which it is quite possible to conduct the operation. These more simple hearths, however, gradually gave way to somewhat more complex forms which, with the processes conducted in them, were modified, according to local conditions, in various parts of Europe, until considerable complexity was obtained, and Professor Tunner, of Leoben, in writing on the German *Frisch-ofen* and other similar processes, classified them into fourteen separate methods (Freiberg, 1858). As, owing to the extended application of steel, these processes are now of much less importance than formerly, and in this country, at all events, are almost entirely superseded, they will not be described in detail, and it will be sufficient to briefly outline two representative modifications. Full details of others will be found in Percy.* The two processes selected for description represent respectively the method of treatment of white iron on the one hand, and grey cast iron on the other. The Germans speak of these as "Frischen" processes, and this term is very convenient and expressive.

(1) **The Styrian Open Hearth.**—The following account is condensed from papers contributed to the *S. Staff. Inst.*, Feb. and Nov., 1889, by F. Korb and the author. It relates to the production of Styrian open hearth steel; but as the works for the production of wrought iron are in the same neighbourhood, and similar in all respects, this description may be conveniently introduced here. It may be premised that in these works the iron used is white, and the process is conducted in a single furnace or hearth, the usual English term for which would be a "Finery."

* *Iron and Steel*, pp. 579-620.

These works are distributed along the sides of rivers in the Styrian Alps, each small works being at a slope or fall of the river capable of developing about 50 horse-power.

The necessary power for the hammer is obtained by means of a breast waterwheel, substantially built of larch wood. Its outer diameter is 3.5 metres, it has 25 curved paddles, and makes 25 revolutions per minute. There are five cams on the axle for working the hammer (a tail helve), hence there are 125 blows per minute. The hammer weighs 310 kilos. (6 cwts.), the lift is 0.47 metre, and this requires nearly 50 horse-power. The blast used in the process is obtained by means of a powerful turbine and blower, from which it passes to a regulator. It is then warmed by passing through cast-iron pipes placed in the chimney as shown in Fig. 62, which is an external view of such a hearth. From this it will be seen that the size and sectional area of the chimney is very large indeed when compared with the small hearths with which it is connected. The object of this is to prevent the escape of glowing sparks, since the Styrian houses are built partly of wood, and are covered with wooden tiles, so that without special care a conflagration might easily take place.

The actual hearth itself is rectangular in plan, the sole, or working area being about 0.74 metre (29 inches) long and 0.5 metre (19.7 inches) broad. The sides are formed of four cast-iron plates, each of which is inclined. The two shorter sides are respectively the *formzacken* and the *windzacken*. The *formzacken* is inclined at an angle of 80° to 85°, hanging over the hearth, while the three other sides are inclined in an outward direction, the *windzacken* at an angle of 67°, the *hinterzacken* or back plate at an angle of 80° to 87°, and the *sinterblech* or fore-plate (lit. cinder sheet) at an angle of 70° to 76°. The blast pipe enters in the middle of the *formzacken*, and is thus at one end of the sole. The blast is supplied at a temperature of about 160° C. under a pressure of about 25 mm. of mercury (about half a pound to the square inch); the blast pipe is inclined downwards at an angle of 15° to 20°, and the diameter of the pipe where it enters the hearth, or the form eye, is slightly over 1½ inches. The fore-plate is

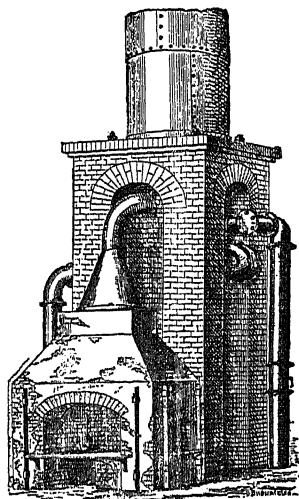

Fig. 62.—Styrian open hearth.
General view.

provided with several holes at different heights for running off the slag.

The Process.—The hearth is prepared by placing a layer of *lösche* (or *brasque*) into the sole, and this is levelled by the workman, who stamps it with his wooden-soled shoes. A shovelful of hammer slag is then spread over, and the hearth filled with *lösche* nearly to the form, a small groove being made under the form, and finally the charcoal is put on. The working begins with the reheating of the *massel*, or pieces of crude steel from the previous operation, each of which weighs about 16 to 20 lbs., and three of them being placed in the fire at once. After being thus heated and afterwards hammered into bars, the raw steel is taken, while still red hot, and hardened by being thrown into a tank through which a stream of cold water constantly runs. In the meantime part of the pig iron has been introduced in the form of a pile or sheaf of plates (*flossengarbe*), each of about 1½ to 2 inches in thickness, and weighing together 60 kilos. (132 lbs.). The pile, formed as described, is held by a pair of large tongs, which rest on the side of the hearth and are balanced by weights hung on their shanks outside. These tongs retain the cast iron in the desired position on the wind side, above the charcoal, where it is very gradually heated. It is then moved to the other end of the furnace (towards the *windform*) and during this period both metal and charcoal are freely sprinkled with slag. Towards the end of the heating period, and when there are only two *massel* in the fire, the second *flossengarbe*, which weighs 40 kilos. (88 lbs.), is placed as before, on the wind side. When the heating period is finished the first pile is held over the twyer, and as soon as the whole of this cast iron has melted down, the second pile, which in the meantime has been moved nearer the *windform*, is treated in the same manner. As soon as the pig iron has melted down it is essential that the temperature should be lowered as quickly as possible. For this purpose the slag is tapped off into a tank of water, the blast is reduced, and a shovelful of wet slag is thrown into the hearth. From the above it will be seen that decarburisation, due to the combined action of the blast and the oxidising slags present, has proceeded very nearly as far as is desired at the end of the melting down stage. The raw steel should now be in the form of a lump, the top of which is some 2 inches below the twyer. The lump after being lifted in the hearth and cooled for fifteen to thirty minutes, so as to attain the proper temperature, is taken to the hammer.

The result of working a charge in the Styrian open hearth is thus the production of a ball of raw steel, which weighs nearly 200 lbs., and is called a *flossel* or *dachel*, both words being employed; this is taken to the hammer and is divided in ten to twelve pieces, each of which is called a *massel*. The smaller pieces are reheated and hammered into bars. A little apparent com-

plexity is produced by the fact that in this process the *ausheizen* (reheating) of the *massel* and the *frischen* of the pig iron go on in one and the same fire, and at the same time. The charge of pig iron weighs about 2 cwts., and the operation lasts three hours; the production is some 7 cwts. per day of twelve hours. The loss of metal is about 10 per cent., and the consumption of soft (pine wood) charcoal necessary to produce 2 cwts. of raw steel is 1·87 hectolitre, or nearly 55 bushels.* It is obvious that by slight modifications in the details of manipulation, any kind of metal, ranging from the very softest and purest wrought iron to the hardest tool steel, can be produced in the Styrian charcoal open hearth at the will of the operator.

Open Hearths for Wrought Iron.—The method adopted for the production of wrought iron by decarburising cast iron in open hearths in Austria is very similar to that just described for the manufacture of Styrian steel, the chief difference being that the blast is regulated so as to be somewhat more oxidising, and the process of decarburisation is more complete. It is also usual to employ a more manganiferous pig iron for the production of steel. According to C. A. Jacobsson,† there are three forms of open hearth in pretty general use—namely, the ordinary hearth with one twyer, as used for steelmaking; a similar hearth with two twyers; and a double hearth. Of these the double hearth is said to give the best results, and the single twyer the worst. The blast is frequently warmed by waste heat, and it is found that by raising the blast temperature to only 250° C., the consumption of charcoal is reduced by about 11 per cent. The iron to be treated in any form of open hearth must be of a different character to that which is suitable for puddling, as conducted in the United Kingdom. It is stated by Jacobsson that iron which is grey in fracture, and which contains as much as 0·8 per cent. of silicon, is very difficult to treat in an open hearth, as so much silicon causes a red slag, bad iron, and great loss. The presence of much manganese also appears to be particularly objectionable in this process, for with above 0·4 per cent. the slag is red, and has a low melting-point; the iron produced is of poor quality, while there is a great loss of iron and increased fuel consumption. Ranström ‡ also confirms the fact that much manganese is objectionable in the open hearth, and mentions a furnace which worked badly when 0·55 of manganese was present; but the difficulty was obviated by reducing the proportion to 0·23 per cent. For satisfactory working when producing wrought iron in the open hearth, the silicon should not exceed 0·7 per cent., the phosphorus 0·1, and the manganese 0·4 per cent. Owing to the deficiency of oxidising slags, and the absence of fettling rich

* Full details of this part of the process are given by Dr. Percy, *Iron and Steel*, pp. 783-6.

† *Inst. Journ.*, 1891, vol. i., p. 376.

‡ *Ibid.*, p. 379.

in oxide of iron, it is necessary to employ comparatively pure pig iron in open hearth working, since the oxidation of the impurities is carried on chiefly by means of magnetic oxide, produced by the action of the atmosphere from the iron itself. The conditions are thus different from those of the ordinary puddling process, and more nearly resemble those of "dry puddling." The presence of any considerable quantity of impurity in the pig iron to be decarburised therefore leads to greater waste, and often also to an inferior product.

The process, conducted in a single hearth and using white iron as above described, is not confined to Austria, but is specially interesting from the fact that the celebrated Swedish iron, which has been imported into this country for centuries for the production of Sheffield steel of the greatest possible purity, is made by an almost identical method. At Dannemora what is known as the Walloon process has long been employed; it derives its name from the Walloons, or inhabitants of Flanders, who introduced the process into Sweden in the reign of Charles XII.,* and differs but in minor details from that practised in Styria and other parts of Austria. The Swedish-Lancashire hearth is used for a similar process, which is stated to have been introduced into Sweden from Lancashire, and which is no longer practised in the United Kingdom. But as in Austria, so also in Sweden, it has in recent years been found that more economical results can be obtained with larger hearths and a greater number of twyers than with the original form.

In the three-twyer Lancashire hearth, as used in Sweden in 1883, the third twyer is inserted at the back of the hearth, so that an ordinary two-twyer hearth can be readily converted into the more recent form. A four-twyer hearth was patented by Stridsberg in 1885; this is practically a double hearth, having two twyers on each of its long sides, and is provided with two working doors. It is stated that a three-twyer hearth uses a charge of 330 lbs. of white pig iron, the loss being equal to about 14.5 per cent. of the iron charged. The consumption of charcoal is about 2.2 tons per ton of iron made, and the weekly output about 20 tons. The three-twyer hearth, with the same number of workmen, has nearly 20 per cent. greater output, and saves some 15 per cent. of fuel.†

The *Franche-Comté process* is another process similar to those employed in Sweden and Styria. Its name is derived from a province in the East of France, where this method was long practised and probably originated. The hearth used is similar in principle but differs in detail from that used in Austria, and the process, as in all other modifications, may be divided into the three characteristic stages. In the first place white iron is melted in

* Percy, *Iron and Steel*, p. 599.

† *Inst. Journ.*, 1886, pp. 329, 929; 1888, vol. ii., p. 254.

a charcoal hearth; secondly, the partly decarburised metal is cooled and broken up, so as to expose it to the oxidising influence of the atmosphere; while thirdly, the iron "comes to nature" and is worked into a ball or balls. The more modern hearths of this type have two or more tuyers, are covered in to economise fuel, and employ heated air.*

(2) *The South Wales Process.*—The Walloon and similar methods being only applicable to white iron, could not be used for the cast iron produced in the United Kingdom, the majority of which, owing to the use of mineral fuel in the blast furnace, and to the consequent presence of sulphur in the charge, was necessarily grey. If white iron were made under these circumstances, it would be so rich in sulphur as to be unsuitable for the production of wrought iron of special quality, and it was, therefore, necessary to employ a somewhat higher temperature and a more basic slag, and so remove the sulphur and produce grey pig. This was then treated in two stages (first in a refinery, and afterwards in a finery) for the production of wrought iron for tin plates and other purposes where great ductility was required. The South Wales process has in recent years been almost completely abandoned in this country in favour of steel, and is now only used on a limited scale for the production of "best charcoal iron," or the fineries are used occasionally in tin-plate works as a convenient means of working up scrap.

The refinery or "running-out fire," as it is commonly called, will be afterwards described. It consists of a rectangular hearth surrounded on three sides by a water-cooled iron casting; air at low pressure is supplied by a number of tuyers, the charge of pig iron is about 5 cwts., while the fuel employed is coke. The result of remelting grey cast iron in this way is that the greater part of the silicon and some carbon is removed, while the phosphorus is generally but little affected. The product is run out in the fluid condition into a horizontal iron mould, and forms a flat plate of white cast iron, which is known as "plate" iron. It is, however, usually broken up while still red hot and tender, into convenient pieces which are now ready for the second part of the process.

This is conducted in two similar but smaller hearths, which are most conveniently arranged near to, but slightly lower than, the refinery, so that the fluid metal at the end of the first stage can be tapped out into the fineries. The size of the fineries is such that the two together contain the metal treated in the refinery. In other cases the metal is broken up as before stated. The fining operation is conducted as follows:—The finery being hot from the last operation, is filled with molten-refined iron, and any slag is removed in the form of a solidified crust. A basket of charcoal is then thrown in, and the blast, which is

* Percy, *Iron and Steel*, p. 602.

cold and at low-pressure, turned on. The charcoal is wetted with water occasionally to prevent waste. The metal has in the meantime become solid, but is very friable; it is now loosed from the bottom, broken up, and brought from time to time in front of the twyer. When the operation is about half finished a quantity of fluid cinder is tapped off, and a fresh supply of charcoal added, and at the end of rather more than an hour the metal is collected into a ball and taken to the hammer, where the greater part of the intermingled cinder is expelled. Part of this hammer slag is returned to the furnace to increase the yield in a subsequent operation, while the iron is cut up and reheated in piles in what is called a "hollow fire."

The pieces which are called "stamps" weigh about 28 lbs. each; three of them are placed on a "staff" or bar of iron some 4 feet long, to one end of which is welded a flat piece of the same quality as the "stamps." The pile is then placed in the hollow fire and raised to a welding heat, when it is hammered into a bloom and nicked across the upper surface, after which, while still hot, it is doubled, and the two parts welded together so as to obtain a finished plate of uniform surface, the surfaces being, in fact, made from one piece. The hollow fire consists essentially of two small rectangular heating chambers, side by side, and separated by a wall of brickwork. Each chamber is connected with a fireplace which is supplied by one twyer with cold blast, and the fuel used is coke, the fireplace being at the side of, but somewhat lower than, the heating chamber. The iron is thus heated out of contact with the fuel, and the waste gases pass backwards over the fireplace, into what are called the stoves or heated spaces, where the iron is subjected to preliminary heating. These hollow fires give a very high and equable temperature, but differ from ordinary reheating furnaces in being smaller in size, in the employment of coke for fuel, in the absence of a chimney-stack, and the use of a blast of air. The heating chamber may thus be conveniently kept filled with a reducing atmosphere which is under a slight pressure from the blast, so that no air leaks into the furnace to oxidise or waste the iron. The plates obtained by hammering the piles, after reheating in the hollow fire, were afterwards cut to size, heated to a lower temperature, and rolled into black sheets. The process, as above described, is stated to have been introduced by E. Rogers at Pontypool in 1807; up till that date a method allied to the "Lancashire" process had been used, the iron being decarburised in a finery and reheated in a "chafery," which resembles a blacksmith's forge.*

* Percy, *Iron and Steel*, p. 590.

II. REVERBERATORY FURNACES.

(1) **Dry Puddling.**—So far as we are aware, all the wrought iron made in this country was produced by means of the finery and chafery at the time when, in 1784, Henry Cort patented the use of the “reverberatory or air furnace—the bottoms of which are laid hollow, or dished out, so as to contain the metal when in a fluid state,” and thus introduced the puddling process which was destined to be of such enormous benefit to the United Kingdom and to the world at large. Cort, however, though recognising the value of the use of scrap iron as an addition during the process, did not give any particulars as to the nature of the materials of which the bottom of the furnace should be made, and does not appear to have employed any form of oxide of iron for this purpose. For a number of years afterwards it is known that sand bottoms were employed, and that these bottoms were built solid, as in the case of many forms of modern roasting furnaces. The result of this was that the oxidation which took place while, according to Cort’s directions, the molten iron was “worked and moved about by means of iron bars and other instruments,” was due to atmospheric action. The operation was, therefore, very slow, and only white iron could be used. At the same time the siliceous bottom was attacked by the oxide of iron produced, and this led to the rapid wearing away of the lining of the furnace, and to loss of time and irregular working. As the metal employed was white iron, which is never very fluid, and the amount of slag was relatively small, this original process is called “dry puddling,” as distinct from the modern or “pig-boiling” process, in which a grey iron is employed, together with oxides of iron, which assist the purification of the iron and the production of fluid cinder.

Cort’s original process was, however, improved in detail before being changed in principle, as air-cooled cast-iron bottoms were afterwards introduced, while, by the use of the refinery, grey iron was converted into white iron by a preparatory treatment, and thus rendered available for use in the puddling furnace.

Dry puddling, when first introduced, was accompanied by “a waste of about 20 cwts. of pigs to a ton of puddled bars, or in other words, it took 2 tons of pigs to make 1 ton of bars; and for some years afterwards it required 35 to 30 cwts., even when the process became much better known”; and when the refinery was used before the introduction of pig boiling, the use of 26 to 27 cwts. of pigs was considered good practice.* At the time when sand bottoms were used, the puddlers seldom charged more than

* *Scrivenor*, p. 289.

2½ cwts. of metal, and could not work more than four heats in twelve hours; the principal cause of delay arose from the puddler having to make a fresh bottom each time before he charged.* In the modern puddling process not more than 21 cwts. of pigs should be needed in order to produce a ton of puddled bars, and six heats of about 4½ cwts. each are worked in twelve hours.

The Refinery.—The refinery or “running-out fire,” which was formerly in general use in Staffordshire, was carefully

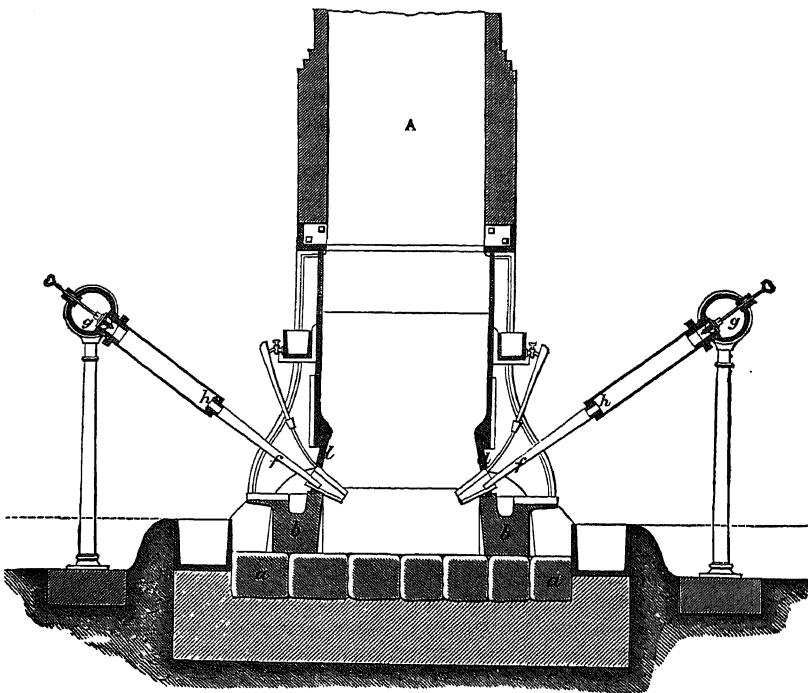

Fig. 63.—Refinery—section.

sketched and described by Dr. Percy.† The author had an opportunity of examining the same refinery at the Bromford Iron Works a quarter of a century later, after it had been disused for some years; it is now demolished, and the refining process is no longer employed in Staffordshire, except occasionally for the production of “charcoal” iron, or for the melting down of scrap, which is in too large pieces to be used in the

* *Scrivenor*, p. 289.

† *Iron and Steel*, p. 621.

puddling furnace. The refinery, which is shown in cross-section in Fig. 63, consisted essentially of a rectangular hearth, with three water-cooled tuyers (*f*) on each side, which were inclined downwards at an angle of about 45°. The sides and back were water-cooled hollow castings or water blocks (*h*), while the front consisted of a solid cast-iron plate with tapping hole. The furnace bottom was made of blocks of stone (*e*) or brickwork covered with sand. The fuel used was coke, with a cold blast of air of about 3 lbs. pressure per square inch. The space immediately above the hearth was enclosed—on the two sides with cast-iron plates, at the back with folding wrought-iron doors, and the front by a balanced wrought-iron door, which could be raised or lowered during working. Above was a short rectangular chimney of masonry (*A*) which was supported on cast-iron columns. The blast was regulated by the valves (*g*).

The mode of working was as follows:—The hearth being hot from the last charge, the folding doors were opened and coke thrown in; on this the charge of from 1 to 2 tons of pig iron was placed, and covered with more coke, about half a hundred-weight of hammer slag was then added, and the blast turned on. The metal melted in about one and a-half hours, and was exposed to an oxidising blast for a further period of about half an hour, though the time depended partly on the composition of the iron employed.

The cinder and metal were then run out together into a flat bed or mould in front of the refinery; it was quickly cooled with water, and when the iron had solidified the cinder was run off into a further mould. The product of the operation was a hard white iron, low in silicon, which was known as "plate iron" or "refined metal." It usually contained a number of blowholes, and practically its only application was in the puddling process.

The following analyses of refined iron and refinery slag produced at Bromford are quoted from Dr. Percy* :—

REFINED IRON.		REFINERY CINDER.	
Carbon,	3·07	Silica,	22·76
Silicon,	·63	Ferrous oxide,	61·28
Sulphur,	·16	Manganous oxide,	3·58
Phosphorus,	·73	Alumina,	7·30
Manganese,	trace	Lime and Magnesia,	4·17

The refinery cinder thus consisted of ferrous silicate, which contained rather less iron than ordinary puddling cinder, while the result of refining was to considerably diminish the silicon and manganese, and to somewhat reduce the proportion of phosphorus, sulphur, and carbon, originally present in the cast iron. The consumption of fuel was about 4 cwts. of coke per ton of iron

* *Iron and Steel*, pp. 626-7.

used, the loss of metal at least 10 per cent. of that charged, while the time taken, including repairs and tapping, was from two to three hours.

The following analyses, illustrating the chemical changes which take place during refining, are by A. E. Tucker.* The greater phosphorus removal in this instance is due to the use of iron cinders, rich in oxide, which were not employed in the early sand-bottomed refineries:—

	Rhymney Forge Fig.	After Melting.	8 Mins. after Melting.	12 Mins. after Melting.	16 Mins. after Melting.	22 Mins. after Melting.	Refined Metal.
Carbon, . . .	3·52	3·42	3·36	3·32	3·30	3·20	3·15
Silicon, . . .	1·86	·62	·52	·38	·32	·24	·20
Phosphorus, .	1·72	1·65	1·50	1·46	·85	·85	·80
Sulphur, . .	·05	·05	·05	·04	·04	·04	·04

(2) **The Modern Puddling Process.**—The following outline of the history of the introduction of this process, and a brief description of the method of working, are based on notes forwarded to the author from an unknown source. They are substantially in accord with the account given by Joseph Hall himself in a rare book,† and with that given by Dr. Percy.‡ The pig-boiling process was introduced by J. Hall, a founder of the firm of Barrows & Hall of Tipton, Staffordshire, about the year 1830. Hall was a thoroughly practical man, and noticed that the process as then conducted required much time, and rightly attributed this to the use of sand bottoms, while he also noticed that the waste in the refinery was greater than that which took place in the puddling furnace when the process was properly conducted. The first step in the change was the substitution of old furnace bottoms, broken into pieces, for the ordinary sand bottom, the result being that, by the use of this oxidising material, the process was shortened and the refinery dispensed with. The next difficulty that arose was connected with the furnace itself, which at this period was constructed simply of firebrick and fireclay, materials which were in practice incapable of long resisting the intense heat employed. After a time, however, a frame of air-cooled cast-iron plates was substituted, and so the present form of puddling furnace originated. As the process came into more general use old bottoms gradually became scarce, and it was necessary to find a substitute. This was at length obtained by calcining tap cinder, the slag made in the process itself. By this means part of the ferrous

* *S. Staff. Inst.*, Jan., 1887.

† *The Iron Question*, London, 1857.

‡ *Iron and Steel*, p. 669.

silicate is oxidised to the ferric condition, and is thus rendered both less fusible and more capable of supplying oxygen to the charge. This calcined tap cinder is still employed for the same purpose to a limited extent under the name of "Bull-dog." The process itself is conducted as follows:—

The furnace is first charged with a sufficiency of fluxing cinder or "hammer slag," which has been squeezed out under the hammer from previous balls, and there is then introduced rather more than 4 cwts. of good grey forge iron. The door is closed and the charge is then heated to melt the iron, and the most favourable results are obtained when the iron and the cinder, charged as above described, become pasty and melt down together. Owing to the greater proportion of graphitic carbon in the iron, and the greater quantity of cinder employed, the charge becomes much more liquid when melted than in the original process. When the iron has thoroughly melted down and has become fluid, it is carefully watched until it has "cleared," and until a number of small blue jets of flame issue from the surface of the liquid. The damper is now "put down," or closed, so as to fill the furnace with a reducing atmosphere and lower the temperature somewhat. In a short time the jets of blue flame almost cease, and the mixture of iron and cinder rises in the furnace to a height of some 8 or 10 inches, and during this stage constant stirring or "rabbling" is necessary to prevent the iron settling on to the bottom of the furnace, and to assist the decarburisation by bringing the iron and cinder into uniform and intimate contact. The whole mass should now be in motion, and bubbles of gas should rise and burn with a blue flame, tinged more or less with yellow, at the surface. When the "boil" is thus in full progress, or "well on," the damper may be raised somewhat, and the iron will soon be observed to "come to nature" or to separate from the cinder. The first sign of this is the appearance of small bright spots on the surface of the cinder, which alternately appear and disappear. The cinder now gradually sinks and leaves the iron as an irregular mass, not unlike the small globules or grains of butter produced by the churn; and as in good butter-making so in good puddling, the grains should be small and uniform throughout the mass. The temperature should now be raised to the highest point so that the iron may be at a welding heat; the puddler after first lifting the metal and turning it over, by inserting a bar underneath in order to prevent the bottom becoming colder than the top, and breaking it up, proceeds to collect it into balls, which are taken to the hammer.

The following brief directions for conducting this process, given by J. Hall himself, are worthy of being here recorded:—First, charge the furnace with good forge pig iron, adding, if required, a sufficiency of flux, increasing or diminishing the same in pro-

portion to the quality and nature of the pig iron used. Second, melt the iron to a boiling or liquid consistency. Third, clear the iron thoroughly before dropping the damper. Fourth, keep a plentiful supply of fuel on the grate. Fifth, regulate the draught of the furnace by the damper. Sixth, work the iron into one mass before it is divided into balls; when thus in balls, take the whole to the hammer as quickly as possible, after which, roll the same into bars for mill purposes. The bars being cut into lengths, and piled to the desired weights, are then heated in the mill furnace, welded, and compressed by passing through the rolls, and thus finished for the market.*

Oxidation in Puddling.—The following remarks on the oxidation of cast iron under different conditions, condensed from a paper by the author, will explain the differences between the old and newer processes of puddling:—†

It is usual to speak of atmospheric air as oxidising and removing the impurities present in cast iron, but if a globule of cast iron be melted in the air, and then exposed to a blast of air or oxygen, it will be observed that the impurities are not the only substances that are oxidised. It is true that, under very special conditions, either the carbon or the silicon may be separately oxidised. But on performing the experiment above indicated, it will be found that the iron itself is oxidised in about the same relative proportion as the other elements, and the result is that practically a layer of impure magnetic oxide of iron is formed outside the globule, while the portion of metal that is left is of nearly the same composition as the original iron. If the cinder be allowed to run away as rapidly as it is formed, ultimately the whole of the iron would be converted into magnetic oxide, and the last particle of cast iron so removed would have nearly the same composition as the original metal. In this case oxidation has taken place, but no purification has resulted.

If, now, the same experiment be tried, but the fluid oxide be allowed to remain and to cover the fused metal, the oxidation of the iron will proceed very little further; a reducing action will then be commenced whereby the silicon, carbon, and other easily oxidisable elements will be removed, but at the same time a corresponding weight of iron will be returned to the globule from the surrounding slag. But if, thirdly, a globule of cast iron be covered with magnetic oxide of iron to protect it from the air and to supply the necessary cinder, and it be then strongly heated, it will be found that the globule has not lost in weight, but has become distinctly heavier during the process. It is scarcely necessary to say that the waste which takes place during reheating or remelting, corresponds to the first condition

* *The Iron Question*, p. 27.

† Presidential Address, *S. Staff. Inst.*, 1892.

above given. The oxide runs away as it is formed, and this is an example of waste of iron pure and simple. The only redeeming feature is that sometimes the oxide produced may be of value for other purposes. The early open-hearth processes for producing wrought iron in fineries, and the original method of puddling, resemble the second case, for part of the iron is wasted to produce the cinder needed to remove the impurities from the remainder of the metal. The larger the proportion of these impurities, the greater will be the loss of iron necessary to make the required cinder, and for this reason a comparatively pure iron is needed, in order to obtain the least waste, while at best the waste is comparatively great. A deficiency of fluid cinder in the early stages of ordinary puddling or "pig boiling," has an exactly similar effect, and leads to waste for the same reasons.

In the modern method of working, on the other hand, the object is to imitate the conditions of the third case previously supposed. Oxide of iron can be bought much more cheaply than it can be made from pig iron, and, besides, the oxidation of pig iron requires the expenditure of time and fuel. Oxide of iron is, therefore, supplied in its cheapest and most readily available form, and as much of this oxide as possible is reduced and converted into wrought iron. To do this, it is necessary that the iron and fluid oxide should be brought into actual and frequent contact, and so perfect fluidity and constant rabbling are needed. There is, of course, a practical limit to the amount of carbon which can be present, due to the fact that cast iron cannot take up more than a certain amount, say 4 per cent., of this element. There is also a practical limit in the case of both silicon and phosphorus; the first being regulated by the increased consumption of time and fettling with excess of silicon, and the second being determined by the inferior quality of iron produced, with large proportions of phosphorus. But within these practicable limits it is advantageous to reduce as much of the oxides of iron supplied as possible.

The original puddling process is not now employed, and the use of the refinery has been almost entirely abandoned in Staffordshire and other leading iron-making centres in Great Britain and America, a grey iron being employed, with rich fettling, instead. White cast iron is still puddled on the Continent by the variety of the puddling process which depends upon the air for oxidation, and which is known as *Luftfrischen*, but the procedure which most nearly resembles the original puddling process is that which is adopted for the production of best Yorkshire iron, and which is still conducted, on a somewhat considerable scale, almost exactly as was the case a century ago. This process, which is somewhat intermediate between dry puddling and pig boiling, may be conveniently considered here.

Best Yorkshire Iron.—The wrought iron of West Yorkshire has long been famed for its special excellence, such names as Bowling and Lowmoor being known all over the world. The Bowling ironworks were started in 1788, and Lowmoor about three years later. This manufacture is distinct from that in other districts, both in the materials used and in the details of production. The ore from which the pig iron is produced is a clay ironstone of a brown colour, which occurs on the property of the forges, and which contains about 32 per cent. of metallic iron, or after calcination about 42 per cent. The coal measures in which the ore occurs supply a coal low in sulphur, and very suitable for furnace purposes; the limestone also is obtained in the neighbourhood. The blast furnaces are driven with cold blast, the charge per ton of pig iron being about 50 cwts. of calcined ore, 30 cwts. of coke, prepared from the coal above-mentioned, and about 20 cwts. of limestone. The weekly yield of a furnace making this class of iron is about 150 tons. The cast iron so obtained is treated in refineries, in charges of about 2 tons, and after refining is run out into a large flat iron mould. The white iron so obtained, known as "plate metal," is reheated and charged hot on to the bed of the puddling furnace. The bed of this furnace is smaller than usual, and the stack is higher, so that there is a stronger draught in the furnace and a higher fuel consumption. The charge usually weighs only about 3 cwts., and the fuel consumption is 30 cwts. of coal per ton of puddled bars.

The general character of the changes that take place during puddling Yorkshire iron are the same as in the ordinary process, except that as the metal used is free from silicon the time is shortened, especially in the early stages; the whole operation only lasts about one hour and twenty minutes, so that nine or ten heats can be worked in a turn of twelve hours. As the temperature is also somewhat higher, this assists the more complete dephosphorisation and quickens the process. From the moment the metal is melted, or about twenty-five minutes after charging, the iron must be constantly rabbled by the puddler, and when it comes to nature it is made up into four balls of about 90 lbs. each. These are taken to the helve and shingled into blooms or "noblins," about 12 inches square and 2 inches thick. These are broken under a falling weight, and the pieces are selected according to the appearance of the fracture for different purposes; the softer and fibrous pieces are used for purposes where special malleability is required, while the more crystalline and harder kinds are employed for bars. In either case the slabs are piled, reheated, welded under the hammer into billets, and after being again reheated they are rolled into the required form. The author is indebted to Mr. Mather, general manager of the Bowling Iron Company, for revising the above brief account of the process as now conducted in West Yorkshire.

The following analyses, given by Sir L. Bell,* illustrate the composition of the cold blast pig iron and the refined metal employed at Bowling, and also that of the finished iron obtained :—

	Cold Blast Pig.	Refined Metal.	Finished Iron.
Carbon,	3.656	3.342	0.226
Silicon,	1.255	0.130	0.109
Sulphur,	0.033	0.025	0.012
Phosphorus, . . .	0.565	0.490	0.064

The total loss in the production of best Yorkshire iron is about 15 per cent. of the pig iron used; this loss is about equally divided between refining and puddling.

At Lowmoor cold blast iron is exclusively used, a rich grey forge quality being preferred with about 1 to 1.25 per cent. of silicon, and 0.3 per cent. of phosphorus. No pig iron is puddled without previous refining; this eliminates the silicon, reduces the phosphorus to about 0.1 per cent., and leaves the carbon practically untouched. The puddler, therefore, has only to eliminate the carbon and the small quantity of phosphorus present. Ten heats of refined metal, each weighing 3 cwts., are worked per turn, and uniformity of quality is ensured by careful inspection and a special system of rewards to the best workmen. The balls are worked by steam hammers into slabs of varying thickness, and about 1 foot long by 10 inches wide; these are afterwards reheated and rolled into the required shape.†

Best Yorkshire iron will stand the fire well—*i.e.*, it will allow of being frequently heated to a high temperature and smithed without deterioration. It welds readily, and is of great uniformity in quality. Best Yorkshire plates support a tensile test of 22 tons per square inch with the grain, and 20 tons across the grain, with an elongation of 16 and 10 per cent. respectively, while bars have a tensile strength of 24 tons per square inch, and an elongation of 25 per cent. Additional tensile strength can be obtained if desired, but this is accompanied by a reduced ductility.‡

Manufacture of Russian Sheet Iron.—A particular kind of sheet iron, famous for its smooth, glossy surface, is manufactured in the districts to the east of the Ural Mountains, in Russia. The colour of this iron is dark metallic grey, and not bluish grey, as with common sheet iron. On bending this iron backwards and

* *Principles of Manufacture of Iron and Steel*, p. 360.

† Windsor Richards, *Inst. Journ.*, 1893, vol. i., p. 22.

‡ Sir J. Kitson, *Inst. Journ.*, 1889, vol. i., p. 14.

forwards with the fingers, no scale is separated, as is the case with sheet iron manufactured in the ordinary way by rolling; but, on folding it closely, as though it were paper, and unfolding it, small scales are detached along the line of fold. The cast iron from which this sheet iron is prepared is smelted from local ores in charcoal furnaces, and is then converted into wrought iron, either in puddling furnaces or in small charcoal fineries. The puddle balls so obtained are crystalline and somewhat steely in character; they are rolled by water power into bars about 5 inches wide and $\frac{1}{4}$ of an inch in thickness; these bars are cut up and reheated in a closed muffle furnace of special construction, employing wood as fuel; they are then cross rolled in packets of three sheets. Just before rolling, a small quantity of charcoal powder is sprinkled between the sheets, and this prevents their sticking together in places as is not unusual in the ordinary process. The sheets are now sheared to about the required size, and are annealed in closed packets in a wood fire for five or six hours. The annealed sheets are made up into packets of about 70 or 100, and are then hammered, by water power, with a very smooth and hard-faced hammer; this increases the size of the sheets and improves the surface. They are then finished by hammering in the same way under a finishing hammer, though in this case each sheet is placed between two other sheets which have been finished in a previous operation. The packets thus contain some 200 sheets during the finishing process, and by the use of finished sheets, in this manner, the resulting surface is much improved. The late Dr. Percy published a description of this process in a pamphlet on *The Manufacture of Russian Sheet Iron* (London, 1871). In this it is stated that the samples he examined contained a trace of copper, but no sulphur or phosphorus, while the carbon in one sample was 0.06 and in another 0.305 per cent. A more recent description has been given by F. L. Garrison,* who visited the works where this variety of sheet iron is manufactured, and saw the process conducted as above described.

* *Inst. Journ.*, 1888, vol. ii., p. 284.

CHAPTER XV.

THE PUDDLING PROCESS.

Arrangement of the Works.—The site chosen for the erection of iron works should be, if possible, level, well drained, and firm, so as to afford a good foundation. Usually a rectangular piece of ground is preferred, and easy access to rail and water carriage is necessary for all large works. The plant is divided into two separate portions; one, called the “forge,” contains a number of puddling furnaces, placed conveniently in the vicinity of a central steam forge hammer, and set of forge rolls or other appliances for treating the balls of crude iron, the whole being arranged so as to allow of ready access to every part of each furnace. The other portion of the plant is called the “mill,” and consists of a number of reheating or mill furnaces, which are larger than, though they otherwise generally resemble, puddling furnaces, and which are arranged near to the rolls necessary to produce the various shapes or “sections” of finished iron which may be required. If iron forging forms part of the routine, a steam hammer or hammers may also be employed in the mill. The mill and forge are both covered with a roof, so as to protect the workmen from sun and rain; while the sides are open, so as to allow of free ventilation. The floor of the works is usually formed of cast-iron plates, which are clean, and convenient for the conveying of heavy masses of hot or cold metal.

The Puddling Furnace.—The ordinary puddling furnace is a single bedded reverberatory of simple construction, formed externally of cast iron plates, tied together with wrought-iron rods, and provided with suitable openings in front for the fire hole and the working door, and lined internally with refractory firebrick. The crown of the furnace is also of firebrick, and is open to the air. The bottom of the furnace is composed of three cast-iron plates, which rest upon an iron frame. The grate of the furnace has wrought-iron fire-bars, and is large in proportion to the bed or crucible part on account of the very high temperature required, particularly towards the end of the process. Each puddling furnace is provided with a separate flue, which is either connected to a simple rectangular stack, provided with an iron damper, or which passes into a boiler flue so as to economise the waste heat of the furnace. In many iron works puddling furnaces are arranged on both systems, as if all the

furnaces were connected to boilers more steam would be generated than could be profitably used. The firebridge is made of cast iron; it is protected by firebrick, and is cooled internally either by means of a stream of water or in some cases by a current of air. In the latter method of cooling, one end of the firebridge casting is left open, while the other is connected with an iron tube some feet in length, like a stove pipe, which assists in producing the necessary draught. The working door is balanced so that it can be readily raised or lowered, and is sometimes cooled by the

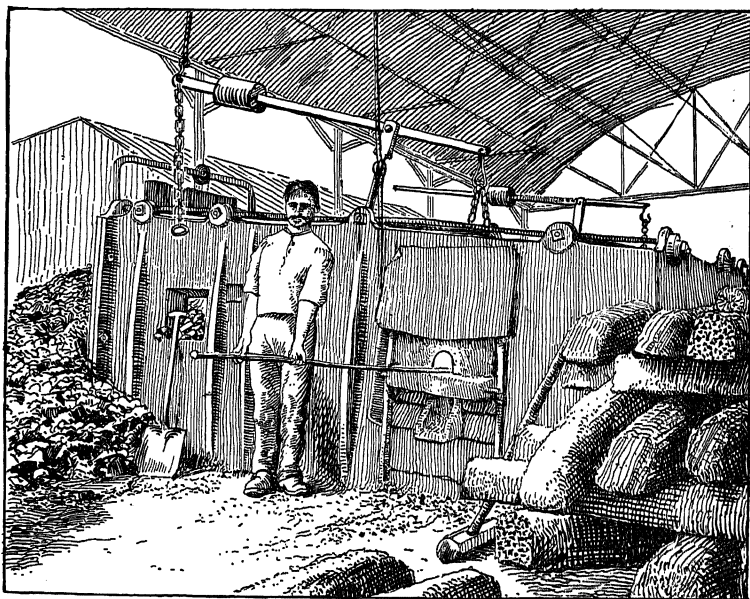

Fig. 64.—General view of puddling furnace.

insertion of a wrought-iron pipe, through which water circulates. At Menden, in Westphalia, a hanging water-cooled sheet-iron screen is used to cover the whole surface of the heated casing plates, and is removed before the metal is balled up.* Generally, however, the only protection the workman has is a sheet of wrought iron which can be slid so as to partly cover the furnace door while the charge is being worked. A general view of such a furnace, from a photograph by the author, is shown in Fig. 64.

Two men are employed at each furnace, and are called the

* *Inst. Journ.*, 1890, vol. ii., p. 765.

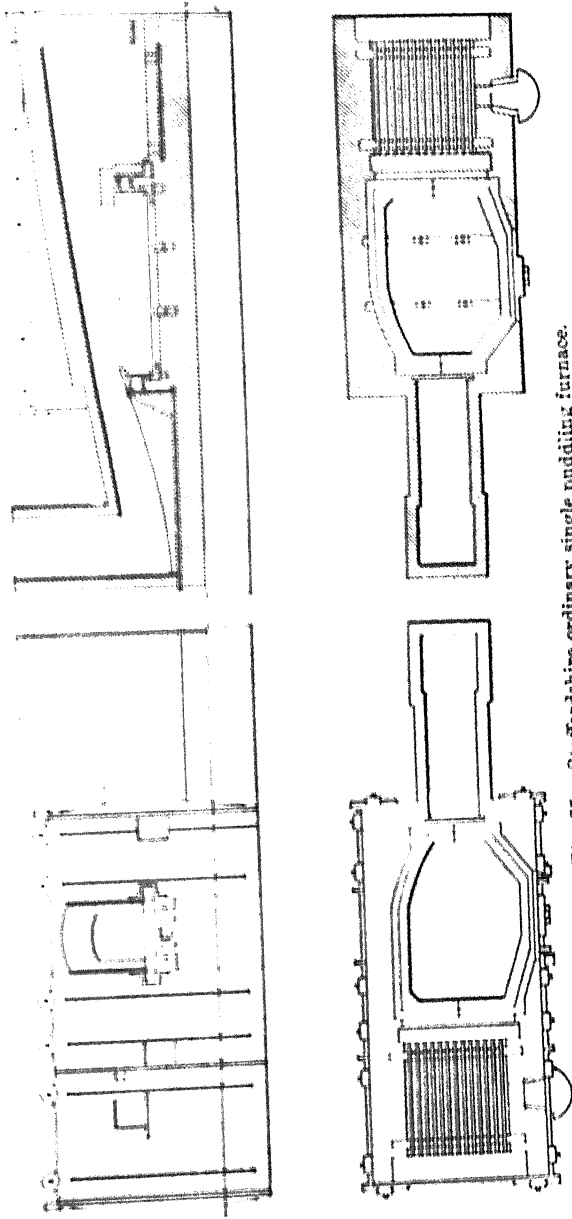

Fig. 65.—Staffordshire ordinary single puddling furnace.

“puddler” and the “under-hand” respectively. The work is very laborious, while it entails no little skill if good results are to be obtained. Usually six heats are worked in a turn of twelve hours, but exceptionally seven heats are obtained, as advocated by H. Kirk,* in which case a special iron, containing less silicon and phosphorus than usual, is employed.

The ordinary puddling furnace which has been in use for many years in South Staffordshire is shown in Fig. 65, which is taken from drawings supplied by R. Edwards, of Walsall, a forge manager of considerable experience.

The framework of the puddling furnace is composed chiefly of castings which are generally cast in open sand moulds, as this method of production is cheaper and the finish of the castings so produced is sufficiently good for the purpose. There are about sixty separate castings in an ordinary single puddling furnace, and it may be of interest to record the names of these as given in a list prepared by a Sub-Committee, of which the author was a member, appointed by the South Staffordshire Institute in 1893 to consider the best shape of puddling furnace as at present in use. The list so prepared included the following castings for outside the furnace:—Foundation plates, fire hole plates, bridge jamb plates, flue jamb plates, tail end plate, flue end plate, centre plate tail end, centre plate back end opposite door frame, tie plate underneath breast plate, breast or tap hole plate, fire plate, door frame, door, and fire hole plate. For the inside of the furnace the following castings are necessary:—V-bearers for grate bars, bearers for bottom frame, bearers for bottom plates, side plates for grate bearers, bearers for tail end, bottom frames, bottom plates, firebridge bearer, firebridge plate, flue bridge plate, flue jamb plate, bridge jamb plate, large back wall plate, small back wall plate, and plates for carrying back walls and jumbs. In addition to the foregoing cast-iron plates and castings, wrought iron is employed for the hangers inside the furnace, the tie bars, bolts, nuts, and cramps, and also for the lever and hanger of the door.

Anderson's Puddling Furnace.—In the form of puddling furnace patented by A. Anderson, of Sunderland, the end and crown of the combustion chamber, of a puddling furnace of the usual type, is formed of a double wall of bricks; between the two walls are brickwork air passages, which are formed by pitching off the interior wall in a particular manner with special bricks. These passages are zig-zag, thus $\wedge\wedge\wedge\wedge$, and the air in passing through them becomes heated and is delivered hot at the firebridge. It is claimed that such an arrangement, by keeping the outside of the furnace cool, reduces the cost of repairs, while, by introducing a regulated quantity of hot air at the bridge, more complete combustion is obtained and little or

* *S. Staff. Inst.*, August, 1887.

no smoke is produced. This is an application in another form of the principle adopted on the Continent in the Boëtius furnace, and in this country in the Smith-Casson reheating furnace.* Anderson's method of construction has been adopted in several important iron works in the north of England, and is employed for ball, mill, and other furnaces in addition to puddling.

In some cases "double furnaces" are employed. They may be regarded as two ordinary furnaces placed back to back, and with the dividing wall removed, they take a charge equal to that of three ordinary furnaces, and employ only four men. They thus save labour; but the result is generally considered to be less satisfactory owing to the difficulty of getting uniform results with larger masses of metal, and the fact that the men seldom work equally and satisfactorily at such furnaces.

At North Chicago a "double-double" furnace has been used. It has four times the capacity of the ordinary furnace, and has two doors on either side directly opposite each other, so that four men can work the charge at one time. The charge, weighing about 1 ton, is brought in a ladle from the blast furnace, and charged in the fluid state into the puddling furnace, thus saving labour and fuel. This furnace is stated to have given good results, but its use has apparently not extended.†

Numerous attempts have been made to introduce modifications into the shape or working of the puddling furnace with the object chiefly of saving labour and fuel. Some few of these forms which are in actual use, or which had been employed on a large scale, will be briefly described later; but in the United Kingdom the tendency has been for some years past to revert to the ordinary single furnace, with merely such alterations in minor details of construction as have been found to diminish the cost and to facilitate repairs.

Fettling.—The different varieties of oxidising material or fettling used in the puddling furnace may be classified according to their relative fusibility, and, generally speaking, the infusible kinds are more costly and contain less impurities than the fusible varieties.

(1) *Fusible.*—These consist essentially of ferrous silicate, with more or less magnetic oxide of iron. The commonest form is hammer slag, or the cinder obtained from the compression of the puddle balls. It closely resembles tap cinder in composition, but is somewhat richer and more pure than any cinder which runs out of the puddling furnace. The puddler usually regards this not as fettling proper but as "flux," and the object of its use is to provide a bath of fluid cinder into which the globules of cast iron may trickle as the metal melts. In this way considerable purification is obtained during the melting-down stage,

* *Inst. Journ.*, 1884, vol. i., p. 60.

† *Ibid.*, 1888, vol. i., p. 323.

while if there is a deficiency of fluid cinder the operation is delayed until the necessary quantity has been produced by the melting of fettling, or oxidation of the iron. Any deficiency of flux, therefore, leads to waste of time, fuel, and fettling, and also to an increased waste of iron. The amount of flux required varies with the iron to be treated, but may be taken in round figures as about $\frac{1}{3}$ of the pig iron charged, so that many works have a surplus of hammer slag. As a rule, however, in the most economically managed establishments little or no hammer slag is sold, and it may even be necessary to buy from other iron-masters.

(2) *Moderately Fusible*.—The second class of fettling is used to form the sides of the basin-shaped cavity in which the metal is melted; it is required to resist the temperature at which pig iron melts, but to become gradually fusible as the heat increases, and to “nourish” the iron at the later stages. It consists of “bull-dog” and similar materials, which contain ferrous silicate, together with more ferric oxide than occurs in hammer slag. Bull-dog is made by calcining tap cinder, as it is by this process rendered much more infusible, owing to the conversion of part of the ferrous into ferric oxide. At the same time some of the phosphorus and other impurities are removed by liquation, as a fusible portion runs away and collects in the lower part of the kiln. Calcination is usually conducted in rectangular kilns of simple construction, though open heaps are also employed. Bull-dog is used either ground into a coarse powder as a covering for less fusible fettling in ordinary working, or is sometimes used in the lump form when making best iron. The use of bull-dog for the latter purpose is, however, steadily diminishing, the tendency being to use more infusible fettling and more flux, as this method of working is better suited for common pigs. The form of ferric oxide known as “blue billy” or “purple ore,” which is obtained from iron pyrites in the manufacture of sulphuric acid, may also be classed as moderately fusible, as owing to its fine state of division it is more easily melted than similar material when in the lump form. Blue billy is now largely used in Staffordshire in preference to bull-dog, and gives excellent results. It must, however, be as free as possible from sulphur, and of uniform size, as otherwise the metal is red-short, and inferior. Good purple ore should not contain more than 0.35 per cent. of sulphur, while bad samples sometimes contain over 1 per cent. of sulphur and a considerable residue of copper, which lead to the production of a red short bar. If the purple ore be in small lumps also it is apt to get entangled in the balls and to squeeze out under the hammer as a dry powder, which leads to a form of red-shortness, as it prevents the iron from welding.

(3) *Infusible*.—The fettling classed under this head is composed essentially of either ferric oxide or magnetic oxide of iron, and is

usually in the form of dense compact lumps, which are employed for making the sides of the basin in which the metal is melted. Where it can be economically obtained red hæmatite may be employed; but in Cleveland and Staffordshire either "best tap" or "pottery mine" is preferred.

Best tap is the name given to a specially-prepared cinder obtained when working a mill furnace with an oxide bottom, as afterwards described. For the following analysis of a sample of best tap made at Great Bridge from a mill furnace employing a bottom of pottery mine, the author is indebted to J. Woodhouse:—

Ferrous oxide,	67·46
Ferric oxide,	26·86
Manganous oxide,	1·30
Alumina,	·35
Silica,	3·05
Lime,	·26
Magnesia,	·40
Phosphorus pentoxide,	·87
Sulphur,	trace

Corresponding to metallic iron, 70·57 per cent.

From this it will be seen to consist essentially of magnetic oxide of iron; it is very infusible, though it melts when exposed to the highest temperature of the mill furnace. When placed in any position, such as the sides or bottom of the puddling furnace, where it is to some extent protected from the direct welding heat, it is one of the best and least fusible fettlings known.

Pottery mine is the term applied to the ore or "mine" obtained in the North Staffordshire or "Pottery" district. It is a variety of blackband, which is generally calcined in open heaps, and which after calcination consists of ferric oxide, with more or less magnetic oxide, and a somewhat unusual proportion of manganous oxide. It is therefore very suitable for use as a fettling for common iron, as it resists a high temperature, and is relatively pure, while the manganese it contains is also advantageous.

Pig Iron for Puddling.—On the Continent white pig iron is still often used for puddling, and was formerly employed in this country for the production of the wearing surface of iron rails, as it was found that a harder iron could be thus obtained. White pig iron is also sometimes used in the sheet-iron trade, as the surface of the iron so produced is less liable to black streaks, due to the presence of a thick slag which is produced when using less pure iron. White pig iron works more quickly than grey, as it usually contains less silicon and manganese, but in the ordinary pig-boiling process it gives a smaller yield, as the silicon present in grey iron, when not in undue quantity,

reduces more than its own weight of iron from the fettling, and so increases the weight of the product.

The iron generally preferred in the United Kingdom is a close-grained grey, or "strong" iron, usually a somewhat close-grained No. 4 pig. Sometimes foundry numbers are employed, but this is generally when a very soft and ductile iron is needed.

The pig iron selected varies according to the fettling employed, the quality of the desired product, and the price of materials from time to time. One simple but important rule is that pure pig irons require a more fusible fettling, as they produce less slag when puddled; and, conversely, with cast irons rich in silicon and phosphorus, or "hungry" irons as they are called, a more pure and infusible fettling should be used. In modern practice, for economical motives, common irons are more used than was the case half a century ago, and the fettling employed has changed to meet the altered conditions.

One of the advantages of the puddling process is its suitability for dealing with pig iron of very widely-differing composition, and it is not possible to lay down any hard and fast lines as to the best composition of pig for forge purposes. In the United Kingdom the pig iron made from the clay iron-stone of South Staffordshire, South Wales, and West Yorkshire has long had the highest reputation, and for the production of best iron is, chemically, all that can be desired; while, when it can be obtained, an iron such as No. 4 in the following list can be thoroughly recommended:—

	No. 1.	No. 2.	No. 3.	No. 4.
Carbon,	2·60	3·60	3·00	not given
Silicon,	1·20	1·25	2·00	·992
Sulphur,	·08	not given	·10	·144
Manganese, . . .	·50	·50	·25	·693
Phosphorus, . . .	·57	1·00	1·80	1·233

In the above table No. 1 is a South Staffordshire All-Mine pig, a turn of six full heats of which would require about 26½ cwts. of pig and 13 cwts. of fettling, while it would yield about 27½ cwts. of puddled bar. No. 2 is a standard pig for puddling, as used by A. E. Tucker for purposes of comparison; this will work into puddled bar with a loss of about 3½ per cent. No. 3 is a cheaper part-cinder mixture, used in South Staffordshire, and which is not very different from Cleveland pig. No. 4 shows the average composition of a half-year's pig iron, as given by H. Kirk, and the yield showed a loss of exactly 3¼ per cent. With an iron of this composition, seven heats per turn may be regularly obtained.

The presence of some silicon is necessary in forge iron for the ordinary or "boiling" process, as otherwise the yield is deficient, while the iron is "dry" and unsatisfactory in the furnace, though this can be to some extent remedied by the use of hammer slag or other siliceous fettling. Generally, the cheaper forge irons are too siliceous and "hungry." This requires more time, uses more fettling, makes the cinder too thin, and gives a brittle bar. Some phosphorus is also an advantage in puddling, as it increases the yield and prevents the cinder from getting too thick at the end of the operation, and thus causing a variety of red-shortness. Too much phosphorus, on the other hand, leads to waste of iron and fettling, and renders it impossible to produce a good fibrous iron, unless, indeed, an unusually large proportion of fluid cinder is used, and the boil is conducted at the very highest attainable temperature. The presence of manganese is advantageous, as it "covers" the carbon, and, by delaying its removal, leads to somewhat prolonged fluidity, and thus to a more complete removal of phosphorus. Sulphur is not advantageous; in moderate quantity it is almost entirely eliminated by puddling, but if present in excess it leads to "red-shortness."

Preparation of the Furnace.—In commencing work with a furnace which has been either newly built or stopped for repair, the first object is to get a good firm bottom on which to work in the subsequent process. This working bottom is obtained as follows:—Refractory fettling, such as best tap, is broken up into small pieces and spread over the cast iron plates to a depth of some 2 or 3 inches; roll scale or other finer material is then added, and the whole is levelled. The fire is then lighted and a good heat obtained, sufficient in fact to soften the materials and make them cohere. A quantity of scrap iron is also charged into the furnace, heated to a welding temperature and made into a ball, which is worked repeatedly over the bottom. In this way a quantity of magnetic oxide is produced, which flows over the bottom and unites the whole into one smooth, solid, non-conducting mass. If during the subsequent working of the furnace this bottom wears, as with impure or "hungry" pig iron, it is repaired from time to time by means of a scrap ball, and, if necessary, by the addition of fettling. It is of the greatest importance that the working bottom should be kept in good order, as otherwise the cast-iron plates get bare and are exposed to the full heat of the furnace, with a result that they are rapidly burnt out, and entail loss not only for their replacement, but also for the necessary stoppage of the furnace, and by the irregular character of the iron produced with a "cold" bottom. The care and skill displayed by a puddler may to a considerable extent be gauged by the length of time the cast iron bottom-plate wears. It may be added that as the centre-plate is the

one which is the most readily attacked, arrangements are made in the construction of some furnaces for this to be replaced without interfering with the others.

The bottom now being made, and the furnace red-hot, the puddler proceeds to charge in the fettling, and to arrange it so as to form a shallow basin to contain the fluid iron. For this purpose the larger lumps of refractory fettling are charged around the sides and against the firebridge, so as to protect it as far as possible from excessive heat. Similar material of smaller size, or in some cases less refractory material, is then added, so as to fill up the spaces between the larger lumps, and ground bull-dog

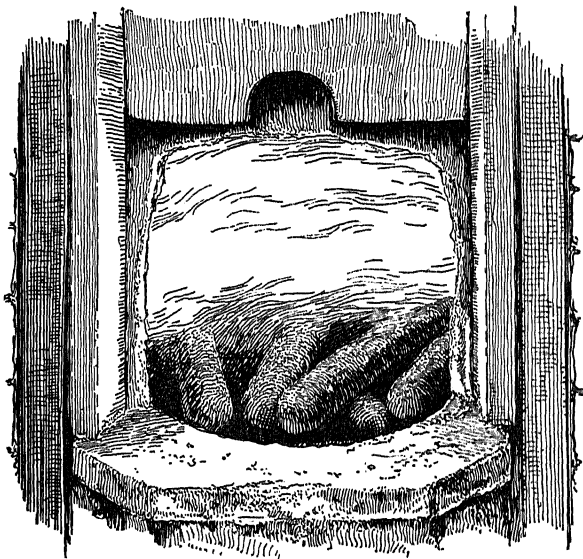

Fig. 66.—Pig iron charged into puddling furnace.

or fine purple ore, which is generally damped with water to make it cohere, is added to cover. From $\frac{1}{2}$ cwt. to 1 cwt. of hammer slag is then shovelled in, and the pig iron, which weighs about $4\frac{1}{2}$ cwts., and is in half pigs, or about nine large pieces in all, is lifted by hand and thrown on the top of the hammer slag, as shown in Fig. 66, from a photograph by the author.

Details of Working.—The working of a heat of puddled iron may be conveniently divided into four stages, which will be separately described, namely:—

(1) *Melting down stage*, lasting about half an hour, by the end of which most of the silicon and manganese and a considerable proportion of phosphorus have been removed.

(2) *Quiet fusion or "clearing" stage*, lasting about ten minutes, during which the rest of the silicon and manganese and a further quantity of phosphorus are removed.

(3) *The boil*, which lasts nearly half an hour, during which the greater part of the carbon is eliminated, together with a further quantity of phosphorus.

(4) *Balling up stage*, which occupies some twenty minutes, and by which time the purification, except as regards the removal of slag, has practically ceased.

1. The furnace having been suitably prepared, and hot from a previous heat, the pig iron is charged as before described; the door is then closed, and the working opening in the bottom of the door covered with an iron plate and rendered as far as possible air-tight by means of a little fine cinder thrown with the shovel. The fire is also made up, and heating proceeds for some twenty minutes, by which time the top of the pig iron is red-hot and the flux begins to soften. The pigs are now turned so as to heat them more uniformly and the door is again closed; in a few minutes the iron begins to melt, and if carefully watched may be seen to trickle down into the cinder in drops. The workman now introduces an iron rod, stirs up the mass, and brings up any pieces of iron which have not completely melted, and which might otherwise remain covered and take longer to melt. When the whole is thoroughly fluid and well mixed the melting down stage is finished.

2. One of the workmen, generally the underhand, now introduces a bar which is bent at the end at right angles, and so acts as a scraper or stirrer, and the whole charge is well stirred and exposed to the action of the fettling and cinder, and also to some extent to the oxidising influence of the air. The temperature is maintained as high as possible during this stage.

The iron is thus thoroughly "cleared" or purified from silicon, the point at which clearing is completed being judged by the appearance of the charge, and upon the skill of the workman at this stage much of the subsequent success depends.

3. When the metal has cleared, and is in a state of tranquil fusion, the next point is to bring on the "boil." The puddler, therefore, diminishes the draught, or "puts his damper down" so as to fill the furnace with a smoky flame and lower the temperature. In some cases also the door is opened and water thrown in at this stage, as this promotes rapid cooling and supplies oxygen at the same time. The metal being thus somewhat thickened, and being vigorously stirred during the whole time, becomes intimately mixed with the cinder; the carbon is thus oxidised, producing carbon monoxide, which burns in blue flames as the bubbles of gas rise and burst. These flames are sometimes called "sulphur" or "puddler's candles"

on account of their pale blue colour. The charge thus swells up and rises some 6 inches in the furnace, and as the heat increases and the damper is opened somewhat, a quantity of red-hot slag flows over the fireplate into a cast-iron slag waggon placed ready to receive it. The violence of the action now gradually diminishes, the iron "comes to nature," and the charge settles in the furnace; the less fusible wrought iron is in the form of a porous cake, and the residue of slag collects chiefly underneath.

4. In the fourth, and last, stage the puddler has to manipulate the iron into convenient forms for subsequent treatment. For this purpose the cake of metal is broken up by inserting a bar underneath, and is worked at a welding heat into one uniform mass or ball. This is now divided into about six balls, of approximately equal size, each of which weighs about 80 lbs., and these are in turn withdrawn from the furnace and taken to the hammer where the slag is to a great extent expelled, and a bloom of iron is obtained. This is rolled, without reheating, into "puddled bar," which is the name given to the crude wrought iron produced as above described.

"Physic."—It is not unusual to make certain additions during the puddling process with the object of assisting in the removal of the impurities and the more rapid oxidation of the charge. Numerous quack remedies have been employed from time to time, animal, vegetable, and mineral, generally without any regard to their chemical action. The most usual is perhaps a mixture of manganese dioxide and salt, which are ground together and added at the early stages of the boil. The presence of manganese dioxide supplies some additional oxygen to the cinder, and afterwards renders the slag more fluid, and assists in the removal of sulphur. The salt also promotes fluidity, and as it is decomposed when heated with silica, with the liberation of chlorine and the production of a more basic slag, it probably assists in the more complete removal of phosphorus. Generally, however, the few ounces of the mixture which are thus added are insufficient to produce any very marked effect, and a better result is obtained by grinding fine ore with manganese dioxide, and using it as a covering for the fettling before the pig iron is charged into the furnace.

Best Staffordshire Iron.—The following details illustrate the procedure adopted for the production of best Staffordshire iron, the figures being supplied by A. E. Barrows, of Tipton. The iron used varies somewhat with the class of work in hand, but consists of a mixture of about four brands of All-Mine pig iron; such a mixture would contain about 0.55 per cent. of phosphorus. The weight charged is 4 cwts. 1 qr. 18 lbs. The varieties of fettling used, together with the relative prices in 1892, were as follows:—

	Per Ton.	
	s.	d.
Best tap,	17	0
Ore (purple),	13	6
Bull-dog,	12	6
Do. ground,	15	0
Roll scale,	7	0
Hammer slag,	1	0

Calcined pottery mine is also an important fettling in South Staffordshire, but hæmatite is not used.

The consumption of fettling, as calculated over a week's work of the above iron, was, per turn, averaging 25 cwts. 2 qrs., as follows :—

	Cwts.	Qrs.	Lbs.
Best tap,	3	0	0
Ore,	0	3	0
Bull-dog,	2	2	0
Do. ground,	1	2	0
Scale,	1	1	0
Hammer slag,	4	0	0

13 0 0 per turn,

Or nearly $10\frac{1}{4}$ cwts. of fettling per ton of pig. It must be remembered that this is for best iron, and is more than is used by ordinary makers. The following figures give the weight of pig iron charged, the puddle bar obtained, and the cinder produced in three ordinary heats, as above, the weights being taken for the author for experimental purposes :—

Weight Charged.			Yield.			Tap Cinder Boilings.			Tap Cinder Tappings.		
Cwts.	Qrs.	Lbs.	Cwts.	Qrs.	Lbs.	Cwts.	Qrs.	Lbs.	Cwts.	Qrs.	Lbs.
4	1	18	4	2	14	1	1	0	1	1	0
4	1	18	4	2	14	1	0	0	1	1	12
4	1	18	4	2	7	1	0	20	1	2	0

From these figures it will be seen that the weight of pig iron charged was less than that of the puddled bar obtained, and this is not an unusual result when the pig iron and fettling are suited to each other, and great care is taken in puddling the iron. As a rule, however, there is a loss in puddling, and this loss sometimes amounts to upwards of 10 per cent. of the iron charged.

Reactions of the Puddling Furnace.—The following table gives the results of Calvert & Johnson's original investigation of the changes which take place during puddling :— *

* *Phil. Mag.*, 1857.

Description.	Time after Charging.		C.	Si.	S.	P.
	Hrs.	Mins.	Per Cent.	Per Cent.	Per Cent.	Per Cent.
Cold blast Staffordshire No. 3 grey, charged Sample No. 1 . . . " " 2 . . . " " 3 . . . " " 4 . . . " " 5 . . . " " 6 . . . " " 7 . . . " " 8 . . . Puddled bar " 9 . . .	0	0	2.275	2.720	.301	.645
	0	40	2.726	0.915
	1	0	2.905	0.197
	1	5	2.444	0.194
	1	20	2.305	0.182
	1	35	1.647	0.183
	1	40	1.206	0.163
	1	45	0.963	0.163
	1	50	0.772	0.168
...	...	0.296	0.120	.134	.139	

The changes which take place during the working of a heat in the puddling furnace, may be conveniently represented graphically in the accompanying diagram (Fig. 67), from analyses by A. E. Tucker.*

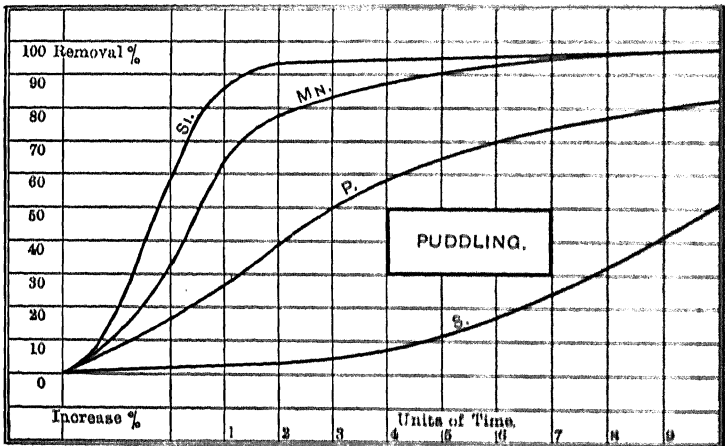
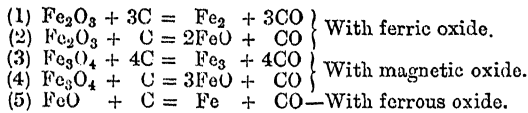

Fig. 67.—Removal of non-metals (other than carbon) in puddling.

Though it has long been recognised that the removal of the impurities in the pig iron charged into the puddling furnace is chiefly due to the action of the oxide of iron in the fettling, further information is required as to the exact reaction or series of reactions which take place in the process. Thus, in the case of carbon, a number of actions is possible such as—

* *S. Staff. Inst.*, Jan., 1887.



If 12 parts by weight of carbon be taken as a standard for comparison, and the above equations are arranged in the order of iron reduced and fettling used, the following values are obtained—

Equation.	Iron Reduced.	Fettling Used.
(5)	56	72
(3)	42	58
(1)	37	53
(2)	0	160
(4)	0	232

Hence, taking the two extremes, according to equation (5), 1 lb. of carbon would reduce $4\frac{2}{3}$ lbs. of iron, and use 6 lbs. of fettling; while, according to equation (4), 1 lb. of carbon would reduce no iron, but use $19\frac{1}{3}$ lbs. of fettling. It is, therefore, of importance, if possible, to determine what the action is which really takes place in practice.

Theories of Puddling.—There are two principal theories which have been advanced to explain the chemical changes which take place in the puddling furnace; these may be called respectively the magnetic oxide and the ferric oxide theory. Other explanations have also been attempted, but have met with less support than those above mentioned.

1. *The Magnetic Oxide Theory* was advanced by Sir W. Siemens in a paper on "Puddling Iron,"* in which the following language is employed:—

"Supported by these observations, I venture to assert that the removal of the silicon and carbon from the pig in the ordinary or 'boiling' process is due entirely to the action of the fluid oxide of iron present, and that an equivalent amount of metallic iron is reduced and added to the bath, which gain, however, is generally and unnecessarily lost again in the subsequent stages of the process . . . the cinder may be taken to consist of Fe_3O_4 (this being the fusible combination of peroxide and protoxide), together with more or less tribasic silicate ($3\text{FeO}, \text{SiO}_3$), which may be regarded as a neutral admixture not affecting the argument."

From the above premises it was then calculated that each unit of silicon in the pig iron, when oxidised by magnetic oxide, reduced 2.8 times its weight of iron, and thus increased the

* *B. A. Report*, 1868.

yield. Taking the accepted atomic weight of silicon as 28, this would give 3 parts of iron for each unit of silicon oxidised to SiO_2 , and the "tri-basic silicate" closely approximates to normal ferrous silicate, $2\text{FeO}, \text{SiO}_2$, the difference in the percentage of iron represented by the old and modern formulae being only 0.5 per cent.

2. *The Ferric Oxide* explanation was proposed shortly afterwards by G. J. Snelus in a report on the Danks' mechanical puddling process,* who gives the following equation for the removal of silicon—

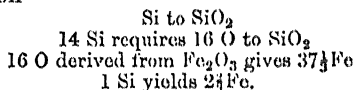

In this statement the old atomic weights are used, but with the accepted values this action may be represented by the following equation:—



Probably the magnetic oxide theory affords the more correct explanation of the changes which take place as the reaction is chiefly one between fluid iron and fluid cinder, and so long as ferric oxide remains infusible it is comparatively inert. But it was pointed out by H. Rose in 1851 that ferric oxide when strongly heated melts, and is at the same time reduced to magnetic oxide,† and this has been recently confirmed by A. A. Read,‡ so that it is doubtful whether ferric oxide ever exists as such in fluid cinder.

A consideration of the thermal aspect of this question, on the other hand, supports the view that ferrous oxide or ferrous silicate takes but little part in the oxidation. The heat developed by the combination of one gram of iron with oxygen in different proportions is approximately as follows:—

1 gram of iron oxidised to Fe_2O_3	yields	1,725	calories.
1 " " Fe_3O_4	"	1,600	"
1 " " FeO	"	1,350	"

By calculating from these numbers the heat required to liberate the same quantity of oxygen for each of the three oxides, the following values are obtained:—

To liberate a unit weight of oxygen and produce metallic iron from	FeO	absorbs	1,350	calories.
" " " "	Fe_3O_4	"	1,200	"
" " " "	Fe_2O_3	"	1,150	"

Since more heat is required to obtain an equal weight of oxygen from FeO than from either Fe_3O_4 , or from Fe_2O_3 , it follows that but little FeO will be reduced so long as higher

* *Inst. Journ.*, 1872, p. 250.

† Percy, *Iron and Steel*, p. 16.

‡ *Pro. Chem. Soc.*, 1894, p. 48.

oxides are present; but in tap cinder much, at least, of the FeO is already combined with either SiO₂ or P₂O₅, and this would render the reduction of the iron still more difficult. Of the remaining two oxides, Fe₂O₃ is somewhat more readily reduced than Fe₃O₄, but much more infusible, and it is not unreasonable to suppose that the infusibility of ferric oxide would counteract the slight advantage it possesses in reducibility, and that the main reaction is of that between magnetic oxide and the non-metals present in the cast iron. This in the case of carbon, may be represented in general terms by the following equation:—

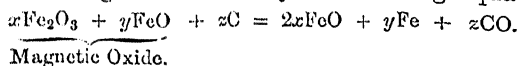

Varieties of Tap Cinder.—In the ordinary process of puddling there are two distinct varieties of cinder produced, and the difference between the two, though of great importance, is frequently overlooked. The first variety of cinder is known as “boilings,” from the fact that it boils over the foreplate during the heat, and is collected in the tapping-waggon. The second kind is known as “tappings,” and is tapped out at the end of the process. The “boilings” are usually more or less honeycombed in structure, and are more easily fractured than the tappings, which are, on the other hand, more compact and dense. The tappings are free from metallic iron, while the boilings always contain some shots or globules of metal, which are carried over by the turbulence of the boil, and in some specimens examined by the author as much as 16 per cent. of metal was found in the form of small globules, which were separated by a moderately powerful magnet from the crushed cinder. These globules of iron still retain carbon, and, being in contact with an oxidising slag, they produce carbonic oxide, which burns in jets at the surface of the molten cinder. The tappings, on the contrary, usually evolve little or no combustible gas.

The mean composition of these two varieties of cinder, as deduced from the seven heats, was as follows:—

	Boilings.	Tappings.
Ferric oxide (Fe ₂ O ₃),	6.94	12.90
Ferrous oxide (FeO),	62.61	64.62
Silica (SiO ₂),	19.45	15.47
Phosphoric anhydride (P ₂ O ₅), . .	6.32	3.91
Not estimated (MnO, S, CaO, &c.), .	4.68	3.10
	100.00	100.00
Total iron,	53.55	59.29



Fig. 68.—Tapping cinder from ball furnace.

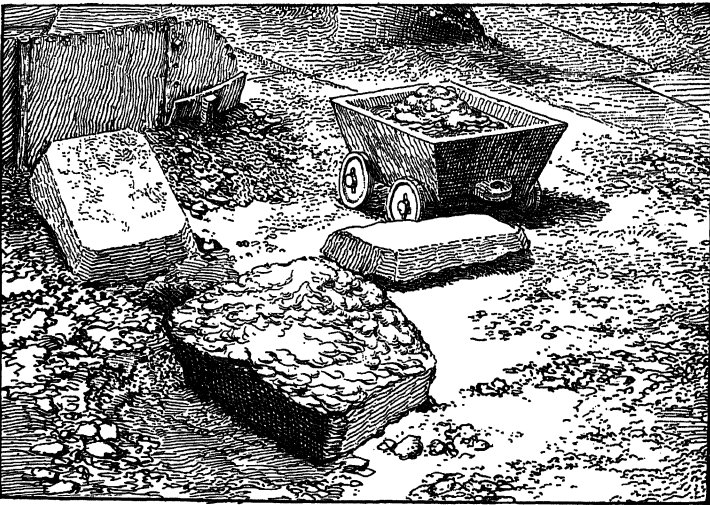

Fig. 69.—Boiling cinder from puddling furnace. From photographs by the author.

From these analyses it will be seen that the boilings are very much richer in phosphorus and in silica than the tappings, and are, in fact, in economical puddling nearly saturated with these impurities under the conditions of furnace working.

As a general rule, if the tappings are lively in the waggon while hot, and honeycombed and brittle when cold, the process is not so satisfactory as when they are more quiet and compact. When the tappings have solidified in the waggon, the surface of the mass is comparatively smooth and level, as shown in Fig. 68, while the surface of boilings is usually covered with irregular volcano-like protuberances, as seen in Fig. 69.

It is noticeable that there are three distinct methods of treating the cinder in puddling. In one case very infusible fettling and much flux is used, much boiling cinder is produced, and is allowed to run away over the fore plate, and at the end of the operation no cinder remains to be tapped out. By another method of working, moderately fusible fettling is employed, and the weights of tappings and boilings are equal, as in the figures given on p. 293. In the third modification, no boilings are allowed to run over the fore plate, but all the cinder is tapped out at the end of the operation. Probably the first is the most economical method, and is most suitable for a relatively impure pig iron, the second is used chiefly for making best iron, while the third is most suitable where there is a deficiency of fluid cinder. Each method has its advocates, but, on the whole, the advantages are in favour of the first.

In any case balls should, when taken to the hammer, retain a considerable quantity of tolerably thick cinder, which should so adhere to the iron as not to leave a trail behind on the way to be shingled, and yet which, when under the hammer, should cover and almost bathe the metal in slag.

Constitution and Reactions of Puddling Cinder.—Magnetic oxide of iron is produced when iron burns in air or oxygen, and is usually represented by the formula Fe_3O_4 (or FeO, Fe_2O_3), though there are considerable differences in the proportion of ferrous and ferric oxide found in various samples of native magnetite and in the artificial "best tap." This magnetic oxide is fusible, as is evidenced by the fluid cinder on an "oxide bottom," sometimes used in reheating furnaces when "best tap" is made. But though magnetic oxide is fusible, it does not melt nearly so readily as ordinary puddling cinder. Ferrous silicates, such as FeO, SiO_2 , or $2FeO, SiO_2$, are readily fusible, but have little oxidising power, and the iron they contain is not easily reduced by carbon or other reducing agents.

Puddling cinder may be regarded as being essentially composed of these two substances—ferrous silicate and magnetic oxide of iron. Ferrous silicate though readily fusible, is comparatively neutral so far as its influence on the constituents of the iron is

concerned, and cheap. It can be obtained at a nominal cost in the form of hammer slag, which also contains a very appreciable and useful quantity of magnetic oxide. Magnetic oxide itself, on the other hand, is less fusible, and with much ferric oxide is extremely refractory. It is an active oxidising agent, and is the chief constituent of the best tap, bull-dog, &c.; for it is erroneous to suppose that these materials consist of ferric oxide alone. During the puddling process the more readily fusible silicate melts first, and then dissolves the magnetic oxide, or the still more refractory ferric oxide, which when dissolved forms magnetic oxide; and thus puddling cinder may be regarded as a solution of ferrous and ferric oxides in ferrous silicate.

Since in modern puddling the greater part of the oxidation which takes place is due to the action of the cinder, the amount of the dissolved oxide is of considerable economic importance. Ferrous silicate melts easily, and can be used in a form which is inexpensive; hence it is economical to have the highest proportion of this material present which is consistent with good working. On the other hand, ferric oxide (which is an essential constituent, and often the source of magnetic oxide) is necessary, but dear. Too large a proportion of magnetic oxide, therefore, means preventible loss of fettling, while too small a proportion will involve the use of more time, a larger total weight of cinder, and consequent waste of fuel.

The character and proportion of ferric oxide in the cinder must be varied according to the pig to be treated, the object in each case being to remove the greatest possible amount of silicon and phosphorus at the beginning of the process. Having thus transferred the impurities from the pig iron to the cinder, and as far as possible *saturated the cinder with impurities* (which is the key to economy at this stage), this cinder should be removed from the furnace, and this is most easily done, not by tapping, but by regulating the damper so as to produce a good boil, and thus boiling out the impure cinder into the tapping-waggon. Care must be taken to avoid undue loss of metal in the form of globules at this stage, and the boiling cinder may be tested occasionally by crushing in a mortar, sieving, and treating with a moderately powerful magnet.

In puddling unusually pure iron, or metal that is more apt to produce a deficiency than an excess of cinder, the foregoing reasoning with regard to the boilings does not apply, and it may in such a case be best to produce little or no boiling cinder. The general practice of the present day is to use much more impure pig iron than was the case forty years ago. It is quite possible, by the use of a sufficiency of cinder, by thoroughly boiling the iron, and by boiling out a good deal of the first cinder, to produce a splendid bar iron from very impure materials, and the quality of the finished iron often depends more upon the

details of manipulation than upon the chemical composition of the original pig iron.

Causes of Loss.—It can readily be shown by a calculation of the reducing power of carbon, silicon, and other elements present in cast iron, that theoretically cast iron should yield more than its own weight of puddled bar, as when the non-metallic elements are removed by the oxygen of the fettling they reduce more than their own weight of metallic iron, which is added to the charge. There are, however, certain sources of loss, some of which are unavoidable, and which combine to produce a different result. The chief source of loss is excessive oxidation, particularly when this oxidation is due to atmospheric air. Excessive oxidation may also result from the presence of too much ferric oxide in the cinder, which condition is generally accompanied by a thicker slag than usual. The action may then be of the following type:—

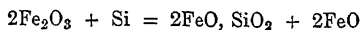

and no metallic iron is produced by the oxidation of the silicon.

It is also noticed that as the basin, or working bed of the furnace becomes larger, owing to the wearing away of the fettling, the charge works somewhat quicker and the waste is increased. In this case the depth of metal is less, and the surface exposed is therefore larger, so that oxidation proceeds more rapidly and the action of the air is greater. If on the other hand the working space is too small oxidation is delayed, and loss of time results. The chief loss is, however, that due to the action of the oxidising furnace gases on the "young" iron while it is being balled up, and while the balls remain in the furnace at a welding heat, this loss can only be to a certain extent diminished by the presence of a reducing atmosphere and a slag of suitable consistency, which covers the globules of iron and thus affords some slight protection. The loss of iron at this stage probably amounts to at least one-tenth of the whole charge, and this loss constitutes one of the inherent disadvantages of the puddling process. Since the non-metals reduce more than their own weight of iron from the fettling, any deficiency of these elements will also tend to diminish the yield, though it must be remembered that an excess of non-metallic elements by delaying the process, attacking the fettling, leading to loss of time, labour, and fuel, and producing an inferior product, is also a source of waste in puddling. The yield is less when an excessive proportion of silicon is present, as the process is delayed and the loss by atmospheric and other oxidation much more than counterbalances the gain by reduction from the fettling.

The increase of yield due to increasing the proportion of non-metals in the pig iron, is illustrated by the following figures, given by F. Scarf* :—

* *Inst. Journ.*, 1891, vol. i., p. 150.

Sample.	Silicon.	Phosphorus.	Silicon + Phosphorus.	Waste in Puddling.
A	2.1	1.3	3.4	9.7%
C	2.66	1.58	4.24	7.1
B	3.5	1.0	4.5	7.8
D	3.7	1.69	5.39	5.2
E	3.15	2.83	5.98	4.2

From this it will be observed that the waste diminished, or, in other words, the yield increased, steadily as the non-metals increased, though if the proportion of non-metals had become much greater than in sample E the waste would have again considerably increased.

Considerable waste of iron may arise from having either too little cinder or a too fluid cinder during balling, as this leaves the finely-divided metal exposed to oxidising gases at a critical stage of the process.

Deficiency of Cinder.—The injurious effects produced by a deficiency of slag of suitable composition in the puddling process is well illustrated in some experiments conducted by M. Millard at Wolverhampton in 1893, and communicated to the author at the time. In a puddling furnace of the ordinary type the usual fettling was replaced by a lining of a very refractory chrome ore from Silesia. The bed of the furnace was carefully made with lump ore, and all crevices were filled in with small ore; scrap balls were first worked, as usual, in order to get the bottom in good condition, while plenty of hammer slag was charged in with the pig iron, as it was expected that there would be a deficiency of cinder. The iron melted and boiled well, but at the end of the boil, when the metal "dropped," it was in the form of minute grains which retained no cinder, and which did not cohere. Much time and labour were needed in balling up the iron, and considerable oxidation, no doubt, took place at this stage. The resulting metal could not be worked under the hammer until it had cooled nearly to blackness; it was brittle when cold, and when rolled into sheets had very imperfect surfaces. The same puddling furnace had during 227 previous heats produced 58.23 tons of puddled bar from 58.13 tons of pig iron, thus showing a gain of about 0.17 per cent., while during 12 heats in which chrome ore was employed, 3.06 tons of pig iron only yielded 2.79 tons of puddled bars, which corresponds to a loss of 8.7 per cent. In the ordinary method of working in the puddling furnace the fettling at the end of the boil supplies a cinder rich in oxides of iron, and this assists not only in the purification of the metal, but also in the welding together of the small granular particles

of iron. In these experiments with an infusible lining it would appear that no cinder for this purpose was available; it therefore had to be produced from the iron itself, with a consequent loss of time and yield, and the production of inferior iron.

Elimination of Phosphorus.—The late Dr. Percy favoured the view that during puddling phosphide of iron was separated by liquation, and regarded the exact explanation of the removal of phosphorus as obscure. Greenwood, twenty years later,* favoured a similar view, stating that “the rationale of its separation is not clearly understood,” and this opinion was supported by Mattieu Williams. On the other hand, Miller† states that silicon and carbon are removed during the earlier stages of the process, while sulphur and phosphorus resist oxidation, but are afterwards removed by the violent stirring of the puddler when the mass is becoming granular. Bauerman, again,‡ who gives a more than usually good account of puddling, says, “The removal of the foreign matters takes place in the following order—first silicon, then manganese, then phosphorus, and, lastly, sulphur.”

There has thus been considerable difference of opinion expressed as to the conditions under which phosphorus is removed, and as this is one of the most important points in the whole operation it is worthy of special attention. The researches of Snelus and of Stead have done much to clear up this question, and have shown conclusively that the elimination of phosphorus is due to the oxidising action of the oxide of iron which is present.

Under ordinary conditions of puddling, with a sufficiency of cinder, and a fairly high temperature, a large proportion of the phosphorus is oxidised during the melting down of the pig iron, so that the melted metal frequently contains less than half of the phosphorus originally present. Phosphorus is further eliminated during the quiet period which precedes the boil, so that at the beginning of the boil the metal frequently retains not above one-fourth of the original amount of phosphorus. When the metal once becomes granular, or comes to nature, phosphorus elimination almost entirely ceases. The presence of silicon in excess retards phosphorus elimination; manganese acts in the same way when present in excess, but when part of the manganese has been removed, and the two elements are present in about equal proportions, they are rapidly removed together, and yield a very pure product.

The greater part of the phosphorus should thus be eliminated by the action of the fluid oxide of iron before the beginning of the boil if the process has been properly conducted. The removal of a considerable proportion of the remainder is, however, essen-

* *Steel and Iron*, 1884, p. 253.

† *Chemistry*, 6th edit., p. 624.

‡ *Metallurgy of Iron*, 1882, p. 329.

tial if a good product is to be obtained, and the three necessary conditions for this removal are as follows:—

1. Sufficient rich and tolerably pure fettling to supply the necessary oxygen and combine with the phosphorus when oxidised.

2. A high temperature so as to maintain the iron in the fluid condition as long as possible, and to supply fluid cinder from the fettling as required.

3. A thorough and uniform incorporation of the iron and cinder, so as to promote the necessary chemical change.

The effect of working the same metal under different conditions is illustrated by the following analyses given by J. E. Stead.* The original pig iron contained 1.54 per cent. of phosphorus.

	Phosphorus in the product.
1. Puddled at very low temperature,52 per cent.
2. Cinder tapped out before boil ("bleeding"),49 "
3. Puddled under normal conditions,31 "

The phosphorus present in tap cinder is in the oxidised condition, and probably exists as ferrous phosphate. That it is in combination with iron is shown by the fact observed by the author,† that it is not possible by means of a magnet to separate the phosphorus from even very finely-powdered tap cinder, while it has been previously pointed out that this is accomplished to a considerable extent in magnetites, where the phosphorus exists as calcium phosphate. It is possible also to separate phosphoric acid from tap cinder by digesting it, when finely powdered, with ammonium sulphide, while Stead has shown that this is not so with the iron ores he examined. It is further noticed, on calcining tap cinder, that a portion is separated which is richer in phosphorus and more fusible than the remainder, and this points to the existence of ferrous, as distinct from infusible ferric, phosphate.

Elimination of Sulphur.—The proportion of sulphur which is present in good forge iron seldom exceeds 0.2 per cent., and is usually only about half this quantity. The amount which has to be removed is thus relatively small, though it is important that it should be almost completely eliminated, as otherwise the iron is apt to be red-short, especially if copper is also present, as is not unusual. Fortunately, in the majority of cases sulphur is thus eliminated, and with the proportions usually present no trouble is experienced. The theoretical explanation of this elimination is, however, somewhat obscure, as it is known that the sulphur in tap cinder is there as sulphide of iron, which is the form in which it exists in the original pig iron, and no sulphur passes off in the gaseous form as sulphur dioxide. It is

* *Inst. Cleveland Eng.*, 1877, p. 148.

† *Inst. Journ.*, 1891, vol. i., p. 131.

noticeable that in slags sulphide and oxide of iron exist together, without any interaction taking place.*

Other Elements in Puddling.—The majority of the solid elements, and an indefinite number of compounds, have been suggested at one time or other for adding to the charge in the puddling furnace to improve the quality of the product. Few have met with any success, and none are regularly employed on any considerable scale. When iron rails were made in large quantities, and wore very rapidly, it was desirable to obtain a hard wearing surface, and for this purpose J. D. M. Stirling in 1848 patented the use of tin; this met with some attention, but the results obtained were lacking in uniformity, and the patent was ultimately abandoned. Recently some experiments with aluminium have given remarkable results. Aluminium was added, in the form of a 7 per cent. alloy, when the charge was molting, in quantity sufficient to give 0.25 per cent. in the charge. This was then puddled in the ordinary manner, and it was found that the product was more than usually homogeneous, and had the exceptionally high tensile strength of 32 tons per square inch.†

It will, however, from the very nature of the operation of puddling, scarcely be expected that uniform results can be obtained by the addition of relatively small quantities of an oxidisable element, since with small variations in the conditions of working the percentage of the added element which would remain in the iron would be considerably affected, and the results would be lacking in that uniformity which is essential to all commercial success. For this reason it is hopeless to expect good results from the use of potassium, sodium, magnesium, zinc, tin, aluminium, and other similar metals which have been suggested for application from time to time. Possibly more uniformity might be expected from the use of copper, or nickel; but even if these metals were shown to have an advantageous influence they would require to be employed in such quantities as to render the cost prohibitive at present prices.

Use of Lime in Puddling.—Various suggestions have been made from time to time for the use of lime or limestone in the puddling furnace, the object being to substitute lime, which has a molecular weight of 56, for ferrous oxide, which has a molecular weight of 72. By this means a more strongly basic material is introduced to combine with silica and phosphoric acid, and one which is weight for weight, capable of neutralising more of these impurities. Dr. Percy records several instances in which limestone was employed for fettling, and in each case the iron produced was red-short and rotten.‡ The cause of this was

* J. E. Stead, *Inst. Journ.*, 1893, vol. i., p. 50.

† G. Allan, *Inst. Journ.*, 1893, vol. i., p. 140.

‡ *Iron and Steel*, p. 669.

doubtless due to fragments of dry lime being entangled in the metal, and producing either a dry powder or a thick slag under the hammer, and so preventing the proper welding of the iron. A. E. Tucker recommends the use of slaked lime in the condition of fine powder, equal in weight to about 7 to 10 per cent. of the fettling, and mentions instances of good results being obtained by this means.* H. A. Webb also recommends the use of lime,† and states that excellent results may be so obtained. The author has on several occasions seen splendid iron produced from very impure materials in this way, and apparently the essentials to success are finely-divided lime, plenty of fluid cinder, and a very high temperature. Good results may be obtained for a limited number of heats with common iron by sufficient cinder, and a high temperature without the use of lime, and the experiment has not been conducted sufficiently long in the author's experience to allow of a conclusion being arrived at as to the commercial advantages of the use of lime. Lime is, however, little if any cheaper than fettling, while there is always the possibility of red-shortness if sufficient care is not exercised, and the further disadvantage that a calcareous slag cannot yield iron to the charge. For these reasons, and in view of the fact that attention has been directed to the subject for half a century without the use of lime becoming at all general, it may be assumed that there is no great advantage in the use of lime in puddling.

Fuel used in the Puddling Furnace.—The fuel employed in the ordinary puddling furnace is a free-burning, bituminous coal, containing as little ash or sulphur as possible. Caking coal is not so suitable for this purpose, as it clots together and stops the draught, while anthracite is also unsuitable, as it is deficient in volatile constituents, and thus not capable of filling the furnace with flame, as is necessary at certain stages of the process. When much ash is present, there is not only the loss of heat due to the ash, but also considerable trouble, due to the "clinkering" of the firebars; while sulphurous fuel leads to the production of inferior iron.

The average consumption of coal per ton of puddled bars produced is about 26 cwts., though this will naturally vary somewhat with the nature of the coal and the construction of the furnace. For economical reasons slack furnaces are also frequently used, and give good results; when slack is burned, however, special arrangements must be made for the admission of air, either by the provision of additional firebars at the end of the furnace, or by the use of a closed grate and forced draught, the former method being, on the whole, preferable.

Gaseous fuel is also employed for puddling, particularly on the Continent, where fuel is dear. A gas furnace was used in

* *Inst. Journ.*, 1888, vol. i., p. 323.

† *Ibid.*, 1893, vol. i., p. 140.

Silesia, so far back as 1855, for this purpose,* and attempts had been made to use hydrogen, and also to employ "water gas," generated by passing steam over red-hot charcoal, at a still earlier date; numerous modifications have been since introduced, none of which have met with much favour in the United Kingdom. At Araya, in Spain, the waste gases from the blast furnace are used for puddling in Siemens furnaces, so that only some 8 cwts. of solid fuel is required to produce a ton of finished iron. The general difficulty in the successful application of gas firing to puddling furnaces arises from the fact that the operation is conducted on a relatively small scale, and the ports, valves, &c., required are very numerous. If a larger charge is employed special machinery is usually necessary to treat the larger balls so produced, or, preferably, the temperature is raised somewhat, the charge is melted, and steel is obtained. The tendency is, therefore, either to the use of ordinary puddling furnaces on the one hand, or the production of steel on the other.

The Calorific Efficiency of the Puddling Furnace.—Any method of heating by means of the reverberatory principle is necessarily extravagant in fuel, for while, as has been shown, some 70 per cent. of the available heat is utilised in a modern blast furnace, not more than one-third of this is employed in useful work, even in the Siemens furnace with regenerators, and in the ordinary reverberatory furnace it is unusual for more than one-tenth of this, or 7 per cent., to be so utilised. In the ordinary puddling furnace, on account of the relatively large hearth and small bed, the flame passes rapidly through the heating chamber, and the conditions are unfavourable to economy in fuel. A number of careful observations on this subject have been made by Major Cubillo of the Royal Spanish Arsenal at Trubia.† The furnace employed in these experiments was of the ordinary construction, but was heated by means of gas from a modified Boëtius producer, and the charge was heated by waste heat before being placed on the bed of the furnace. This gave the furnace some advantage as compared with the practice common in the United Kingdom; but, on the other hand, the pig iron employed was of hæmatite quality, and the product was best iron. As a consequence only five heats, each weighing 485 lbs. (4 cwts. 1 qr. 9 lbs.), or one heat less than usual, were worked each shift of twelve hours; the nett result was that for every ton of puddled bars produced, about 26·5 cwts. of coal were required. The coal used contained 8·71 per cent. of ash, and 4·6 per cent. of water, and with a somewhat similar coal in Staffordshire, the fuel consumption is about the same. The coal was about two-thirds fine and one-third lump. The difference in procedure, therefore, about equalised matters, so that the result is fairly comparable with

* *Useful Metals*, p. 249.

† *Inst. Journ.*, 1892, vol. i., p. 245.

Staffordshire or Cleveland practice. Major Cubillo concluded that the proportion of the heat generated which was actually used in puddling was only 2.9 per cent., while 42.14 per cent. was lost with the products of combustion, and 47.7 per cent. lost by radiation and in other similar ways. If the heat required for the fusion of the cinder, for vaporisation of water in the ore, and vaporisation of water in the gas, be all considered as necessary for the proper conduct of the operation, and be therefore added to the proportion actually employed in puddling, the conclusion

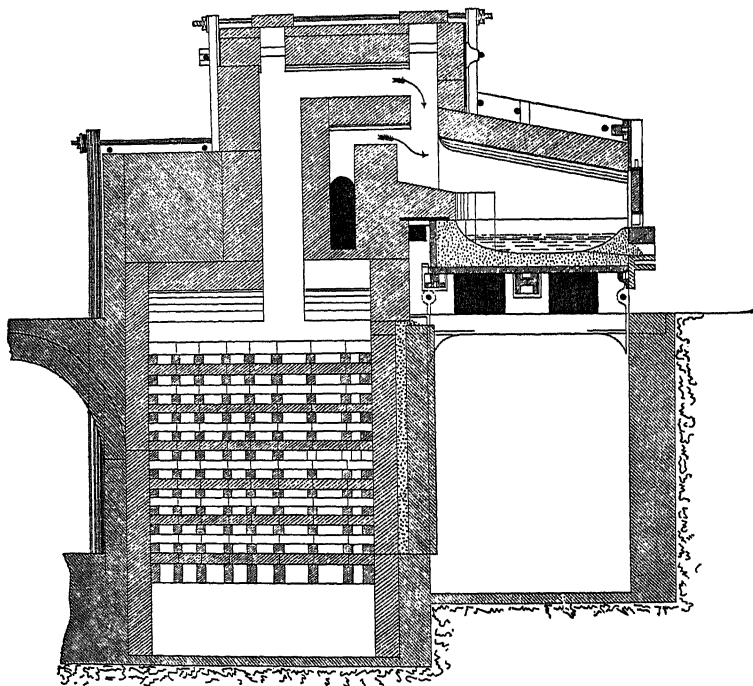

Fig. 70.—Siemens' puddling furnace.

arrived at is that 7 per cent. of the heat generated was employed in some form of useful work. Even accepting this higher value, it will be seen that in the ordinary puddling furnace, not more than one-fourteenth of the heat obtained from the fuel is usefully applied in any way in the puddling process. When boilers are attached to puddling furnaces the efficiency is of course materially increased, though it is questionable if even then it reaches one-fifth of that theoretically possible.

In these experiments the loss of iron was 11.37 per cent. of

that charged; this abnormally high loss illustrates the effect produced by the employment of specially pure pig iron, containing only 0.038 per cent. of phosphorus, and the longer time required to work such a charge.

Siemens Puddling Furnace.—A form of puddling furnace heated with producer gas and supplied with regenerators arranged close to the heating chamber has been described by the late John Head,* and is shown in the accompanying diagram (Fig. 70), the details of which will be intelligible to the student who has studied the description of the new form of Siemens furnace as applied to reheating given in Roberts-Austen's *Metallurgy*, 2nd edit., p. 213. It will be seen that the metal is melted in a fixed furnace heated with gas, and that the regenerators are close to the furnace, and though situated below the ground level, they are still arranged so as to allow of the furnace bottom being readily examined and repaired. Several such puddling furnaces are now in successful operation in South Staffordshire and elsewhere with a very low fuel consumption.

The Springer Furnace.—This is a modification of the ordinary Siemens regenerative furnace which was introduced in Germany and Austria in 1883, and which has since been somewhat extensively adopted on the Continent.

It is a quadruple puddling furnace, which consists of two double furnaces placed side by side, and separated by a water-cooled firebridge. These are worked alternately, and heated with gas, the products of combustion being passed through regenerators of the ordinary type. Each bed receives a charge of somewhat over half a ton of pig iron, and the flame passing over the charge which is being worked in the one bed heats up the iron in the other, so that by the time the one charge is balled up the other is melted down and ready for the boil. It is stated that a very high temperature is obtained in the Springer furnace, and that on this account it can be used for the puddling of highly manganiferous and other irons which do not yield a good fibrous product in the ordinary furnace. The yield of puddled iron is as much as 10 tons per day of twelve hours, the loss of metal being about 2 per cent., and the consumption of fuel from 8 to 10 cwts. per ton of puddled iron made.† Complete detailed drawings of this furnace have been given by Dr. Wedding,‡ who states that it may be used with direct firing as well as with gas firing, and has done excellent work even with lignite as a fuel. According to this authority it has but a single disadvantage, namely, the dependence of the two hearths upon one another in working, as any irregularity in working in the one hearth leads to difficulties with the other.

The Pietzka Furnace.—This furnace was introduced to

* *Inst. Journ.*, 1893, vol. i., p. 125.

† *Ibid.*, 1889, vol. ii., p. 424.

‡ *Ibid.*, 1890, vol. ii., p. 529.

overcome the difficulty above mentioned, where the hearths are fixed and the flame reversible. In this case the direction of the flame is fixed, but the positions of the two hearths are reversible, so that the hottest flame always strikes the hearth in which puddling is being conducted. The peculiarity of construction in the Pietzka furnace is that both hearths are supported on an hydraulic piston which works in a vertical direction from beneath and between the two hearths. The connections between the side walls of the hearths and the fixed fire chamber or flue are made with inclined conical surfaces. The hearths are lifted a little by the piston before they are turned, hence they turn freely until the reversed position has been reached, when they are lowered into place, and the connection is again complete. The furnace may be either direct or gas fired, and the products of combustion pass through a special form of tubular regenerator which heats the air used for combustion without any reversal being needed. The surplus heat is used for raising steam. The coal consumption with direct firing is stated to be 13·2 cwts., and with gas firing 8·4 cwts. per ton of puddled bar; while, in the latter case, if allowance be made for the steam raised, only some 5·5 cwts. of coal were used for puddling. Dr. Wedding has also given complete and detailed drawings of the Pietzka furnace.*

Mechanical Puddling.—The introduction of Bessemer steel led indirectly to the application of much inventive skill to the puddling process, the object being to counteract the growing competition of steel, and incidentally to diminish the exhausting labour of the puddler. The first patent for a puddling furnace with a revolving bottom was obtained in 1857, but it was not until the Bessemer process was well established that the applications for patents for improvements in puddling reached the high water mark.

According to J. S. Jeans,† during the ten years, 1867 to 1876 inclusive, application was made for the following patents relating to puddling:—

Furnace beds and fettling,	48	patents.
General construction of furnace,	45	"
" process of puddling,	73	"
Ordinary rabbles or puddles,	2	"
Tubular rabbles and injecting tubes,	14	"
Mechanical rabbles,	23	"
Oscillating beds and vessels, and their rabbles,	11	"
Revolving beds and pan-shaped vessels,	20	"
Revolving chambers with axes (generally horizontal),	54	"
Re-heating furnaces, balling furnaces, and blooms,	99	"
Total,	389	

* *Inst. Journ.*, 1890, vol. ii., pp. 527-532. † *Ibid.*, 1882, vol. i., p. 143.

There were thus rather more than three patents relating to suggested improvements in puddling applied for every month during the whole of the ten years above mentioned. Of these probably not a dozen are now being used, and scarcely any of them are of practical importance.

The proposals for the construction of mechanical puddling furnaces may be grouped under the three following heads:—

1. *Mechanical Stirrers or Rabbles.*—These differ in detail, but all more or less closely resemble Eastwood's rabble, in which the tool is suspended in a stirrup at the end of a lever to which a reciprocating motion is given. At the same time the lever is caused to move through an arc of a circle in a horizontal plane. A later modification of this principle, introduced by Clough, is

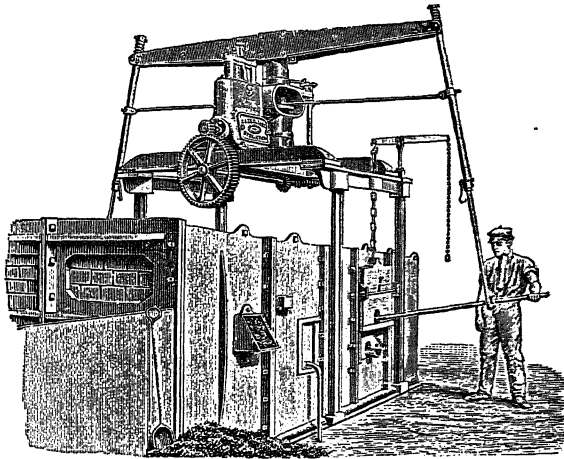

Fig. 71.—Clough's mechanical puddler.

shown in Fig. 71, the working of which will be sufficiently intelligible from the illustration. This mechanical puddler has been adapted to a number of furnaces in the West of England, in Staffordshire, and in Spain, but is not now so largely used as formerly. All such forms of apparatus suffer from the disadvantage that the balling, which is after all the hardest and most exhausting part of the work, has still to be done by hand.

2. *Furnaces, the Beds of which Rotate in a Vertical Plane.*—Of these the best known is that introduced by Danks in America, and which is shown in Fig. 72. It consists essentially of two parts, a fixed fireplace and firebridge, and a cylindrical working chamber which rotates on friction rollers.

The fireplace has a closed ashpit, the air being supplied under slight pressure through the blast-pipe B, and also in jets, c, from

the blast-pipe C, over the top of the coal. The draught is thus under control, and the flame may be varied as desired. Fuel is introduced through the firing-hole G.

The cylinder A is fitted with a movable end piece and flue, and made with some ten wedge-shaped recesses, which are employed for keeping the initial lining of fettling in position. The cylinder is supported on friction rollers, *d*, and rotated by a pinion working in the toothed segments, *f*. The flame enters the cylinder through the passage *h*, and passes out through the movable end piece which is suspended by the rod *l*. The bear-

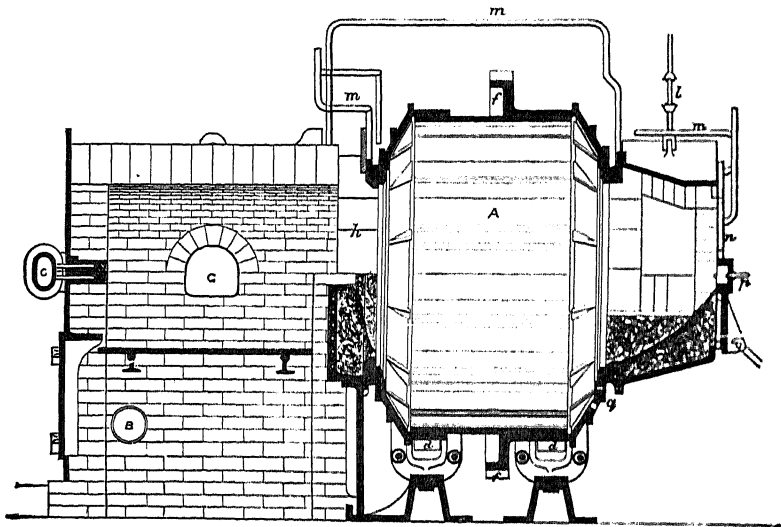

Fig. 72.—Danks' mechanical puddling furnace.

ings and end of the furnace are cooled by water circulated through *m* and *n*, while *p* is the stopper and *q* the tapping hole of the furnace.

The furnace is first lined with a mortar of non-siliceous iron ore mixed with lime, this is dried, and the fettling is then melted upon it so as to obtain a good working bottom. Oxygen is supplied for the purification of the pig iron by fettling, which is afterwards added with each charge. For this purpose best tap, together with rich iron ores, is found to answer well. The iron is generally remelted in a cupola and run into the furnace in the fluid condition, the charge used in later forms of the Danks' furnace being about 1 ton, and the time taken to work a charge being about half an hour.

The Danks' furnace was examined and reported upon favour-

ably by a Commission sent to America by the Iron and Steel Institute in 1871, and to the report of this Commission the student is referred for fuller details.* Large sums of money were expended in introducing the process into the United Kingdom, but all such attempts ended in failure, and it has been gradually abandoned both in America and in Europe, until its chief interest now lies in its history.

At the same time the favourable report of the Commission received considerable support from the fact that the process was used during twenty years or more in numerous works in America, and but for the extended use of steel might perhaps still have been so employed. In the United Kingdom, owing to the abundant supply of skilled labour at a relatively low price, the cost of repairs led to the process being commercially unsuccessful from its introduction.

3. *Furnaces, the Beds of which either Rotate in a nearly Horizontal Plane or Oscillate.*—The Pernot furnace, which was designed especially for steel melting, has also been used for puddling. The bed of the Pernot furnace is circular, and inclined at an angle of about 6° with the horizontal plane; as the bed rotates about 3 times per minute the charge is constantly agitated and brought in contact with the sides of the basin, whereby oxidation is promoted.

The Gidlow mechanical puddling furnace was constructed on the ordinary reverberatory principle, the novelty being that the furnace was mounted on an axis and caused to oscillate by means of a small engine. From 6 to 8 oscillations per minute were sufficient, and the angle which the hearth assumed with the horizon never exceeded 30° . The metal was thus caused to flow from end to end of the furnace with a wavy motion, which brought the iron and fettling into frequent contact, and allowed of 8 charges, each of 15 cwts., being worked in twelve hours. It was also claimed that the fuel consumption was less than in the ordinary furnace.†

In the Jones mechanical puddling furnace an oscillating motion is imparted to the hearth by means of a revolving cam; this cam is mounted on a vertical shaft under the hearth. When the iron begins to come to nature a ball of wrought iron is introduced to act as a nucleus and collect the young iron as it rolls about; when the ball is of sufficient size it is removed from the furnace and hammered.‡

The following papers dealing with the puddling process may be consulted with advantage by the student:—

Calvert & Johnson. *Phil. Mag.*, 1857, vol. ii., p. 165.

Benjamin Baylis. On Puddling, by a Practical Puddler. Booklet published by Taylor & Greening (London, 1866).

* *Inst. Journ.*, 1872, vol. i.; see also S. Danks, *Ibid.*, 1871, vol. ii., p. 258.

† *Inst. Journ.*, 1878, vol. i., p. 240. ‡ *Ibid.*, 1891, vol. ii., p. 255.

- G. J. Snelus. Report on Danks' Puddling Furnace. *Inst. Journ.*, 1872.
- Jeremiah Head. *Inst. M. E.*, 1876, p. 266.
- H. Louis. *Inst. Journ.*, 1879, p. 219.
- H. Kirk. Puddling in Ordinary and Rotary Furnaces. *Inst. Journ.*, 1876, vol. ii.
- H. Kirk. Homogeneous Iron. *Inst. M. E.*, Jan., 1877.
- H. Kirk. Further Improvements in Puddling. *S. Staff. Inst.*, August, 1887.
- J. E. Stead. Phosphorus in Cleveland Ore and in Iron. *Inst. Cleveland Eng.*, 1877, p. 132.
- J. E. Stead. Dephosphorisation of Iron. *Ibid.*, 1879, p. 34.
- J. E. Stead. The Chemistry of Iron Purification. *S. Staff. Inst.*, Jan., 1884.
- Sir L. Bell. Separation of Phosphorus from Pig Iron. *Inst. Journ.*, 1878, vol. i., p. 17.
- Sir L. Bell. Section Puddling: Principles of the Manufacture of Iron and Steel, 1884.
- T. Tscheuschner. *Inst. Journ.*, 1886, vol. i., p. 325.
- A. E. Tucker. Some Economics in Iron Manufacture. *S. Staff. Inst.*, Jan., 1887.
- A. E. Tucker. Valuation of Pig Iron for Forge Purposes. Privately printed. (Smethwick, Feb., 1888).
- T. Turner. Varieties of Tap Cinder. *S. Staff. Inst.*, April, 1891.
- T. Turner. Economical Puddling and Puddling Cinder.* *Inst. Journ.*, 1891, vol. i., p. 119.
- T. Turner. The Theory of Puddling. *S. Staff. Inst.*, Dec., 1891.
- T. Turner and A. E. Barrows. Slag in Wrought Iron. *Journ. Chem. Soc.*, vol. lxi., p. 551.
- John Head. Notes on Puddling Iron. *Inst. Journ.*, 1893, vol. i., p. 125.

* This paper, which was not submitted to the writer for revision, contains several misprints. The author also had no opportunity of replying to the discussion.

CHAPTER XVI.

FURTHER TREATMENT OF WROUGHT IRON.

Production of Puddled Bars.—The balls of crude wrought iron, having been produced in the puddling furnace as before described, have now to be compressed to expel the slag and render the material more uniform in character; they are afterwards rolled into bars, which receive the name of “puddled bars” in the United Kingdom, or “muck bars” in the United States. For compressing the iron various forms of hammers or squeezers are used, while for the production of bars, grooved rolls, as introduced by Cort in 1783, are generally employed, though, in a few exceptional cases, where water power is available, bars are still produced by the hammer or “battery,” as in ancient times.

Helves.—One of the simplest and most ancient forms of hammer is known as the “helve,” which is still employed, to a limited extent, in forges, though no longer used where large masses of metal have to be treated. There are several forms of helve, such as “nose,” “belly,” or “tail” helves, all of which are applications of the same general principle, that a mass of iron is raised by means of a cam attached to a revolving wheel, and is then allowed to fall, by its own weight, on to the metal to be hammered or “shingled,” as it is commonly called. The different varieties of helves may be conveniently classified according to the position at which the cam acts, which may be at the hammer end or “nose,” in the middle or “belly,” or at a lever at the other end or “tail.”

A general view of the ordinary nose helve as used in South Staffordshire is shown in Fig. 73. It consists of a T-shaped mass of grey cast iron, the cross piece and long piece being about 6 feet and 8 feet in length respectively. It is supported at the ends of the cross piece, while the nose is at the other extremity; the hammer face is recessed into the body of the casting about a foot from the nose; the total weight of the helve is usually about 6 tons. The other necessary portions of the apparatus are—

(1) A revolving shaft actuated by suitable machinery and fitted with a cam ring, and four cams or “wipers,” to lift the hammer; the cam ring and one cam are shown in the figure.

(2) An anvil block, suitably mounted on a bed plate, so as to receive the blow of the hammer.

(3) An iron stand for supporting the base of the helve. The total weight of metal in such a hammer and accessories is upwards of 40 tons.

While the helve is in use it gives a blow about once every second, or somewhat more frequently, and each blow is of the same force. When it is required to stop the helve for any reason, a piece of iron is placed on the cam as it rises, and the nose is thus raised higher than usual; at the same time a wooden prop or "gag" is introduced, so as to support the helve. The cams on the shaft thus pass without touching the helve, and it

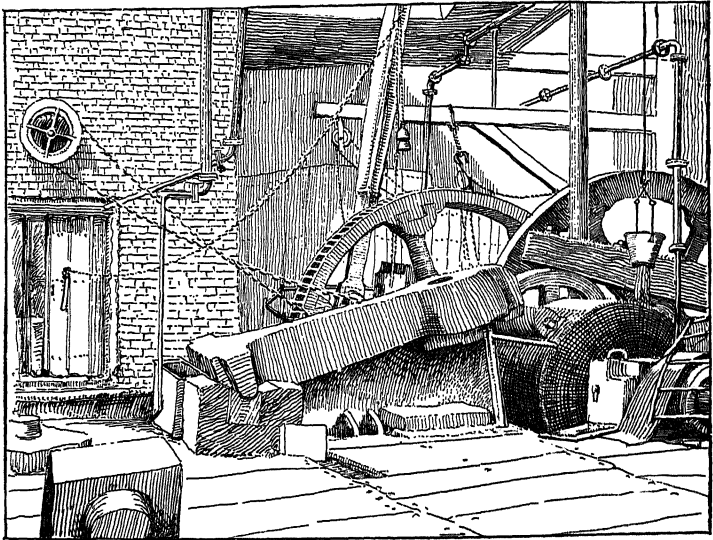

Fig. 73.—General view of Staffordshire helve.

remains at rest as shown in the illustration. When it is required to again start working, the helve is lifted by placing a bar of iron on one of the cams as it rises, the prop is then quickly removed, and the helve gives four blows with every revolution of the shaft as usual.

Squeezers.—Various forms of squeezers have been introduced from time to time, chiefly with the object of preventing the jar or shock due to the action of the hammer, though such appliances have not met with very general application. The more usual forms may be conveniently divided into two classes—

(1) Those in which compression is produced by means of a lever, as in the "alligator" or "crocodile" squeezers, which are so

called by the workmen from the resemblance between the motion of this class of squeezer and that of the mouths of the animals above mentioned.

(2) Those in which a revolving cam is employed, as in Winslow's squeezer, which is shown in end elevation in Fig. 74. A squeezer on a similar principle, but consisting of a cam moving in a horizontal plane and surrounded by a circular iron casing, has been employed in South Staffordshire for a number of years. Though squeezers appear at first sight to have many advantages over hammers, particularly on account of their even and quiet action, they do not seem to have grown in general favour in recent years, it being stated that the iron worked in squeezers is less uniform in character, and that the slag is not so completely expelled by squeezers as with hammers.

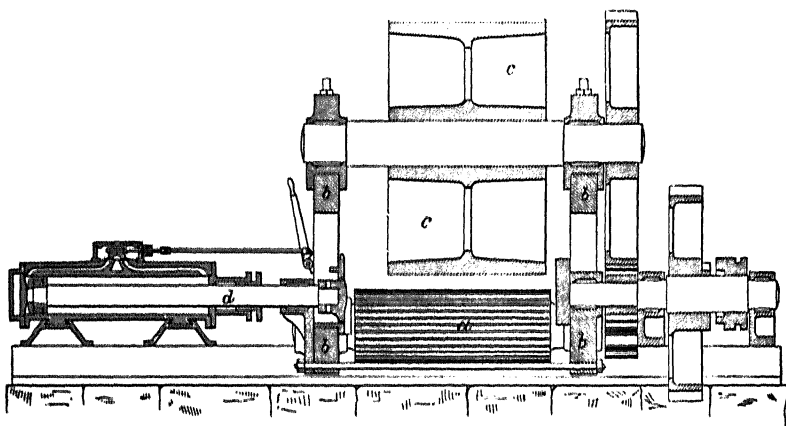

Fig. 74.—Winslow's mechanical squeezer.

a, Corrugated rollers.
b, Journal frames.

c, Revolving cam.
d, Steam ram for hammering
 end of blooms.

Steam Hammers.—Steam hammers are used for shingling puddled balls in almost all modern works, and are now always double-acting, as shown in Fig. 75. The hammer block in this instance weighs about 10 tons, and is heavier than is generally employed in forges, though lighter than is usual for manipulating large masses of steel. Forge hammers seldom exceed 3 tons in weight, while steam hammers for forgings of the largest size weigh 50 tons and upwards. Details of the construction of such hammers belong rather to the province of the engineer than the metallurgist, so they will not be here described at length; further particulars will be found in Phillips-Baerman's *Metallurgy*, p. 321, *et seq.*, whence the accompanying illustration is taken.

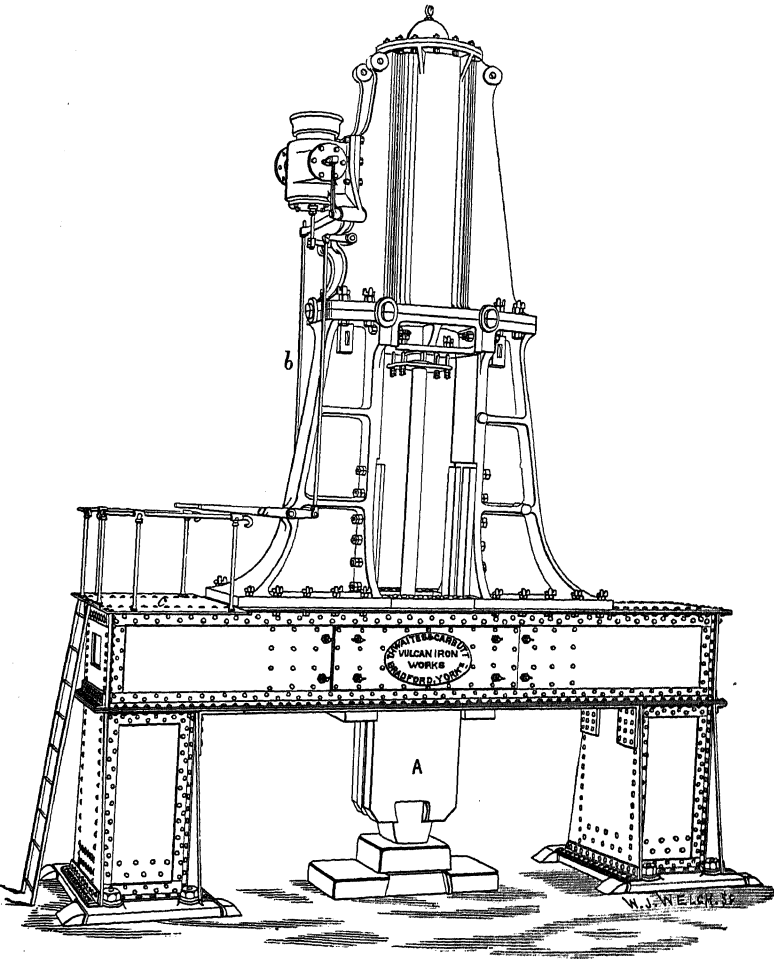

Fig. 75.—Double-acting steam hammer.

A, Hammer block.
a, Actuating lever.

b, Rod to stop valve.
c, Working platform.

As compared with helves, the steam hammer has the advantage that larger masses of metal can be treated at once, the operation is performed in a shorter time, and the slag is more perfectly expelled. On the other hand, helves involve a smaller initial cost, and require less steam. Steam hammers are always used where large outputs or large masses have to be dealt with; helves, on the other hand, are employed by makers of iron of special quality who have a reputation to maintain. The fact that the helve gives a blow of uniform force, though disadvantageous in many respects, has one advantage for the production of best iron, since red-short metal, which would be at once detected, and probably crumble to pieces under the helve, may, with careful manipulation, be worked into blooms under the steam hammer, and thus ultimately lead to the production of finished iron of an unsatisfactory quality. Where, on the other hand, common iron is being made, the readiness of manipulation of the steam hammer is a considerable advantage.

The iron, having been thus compressed and consolidated by some form of hammer or squeezer, and a considerable portion of the slag expelled, is now taken while still hot to the puddle rolls, where it is converted into bars, which differ in size and weight according to the purpose for which they are to be employed. Puddle rolls do not differ in any essential particulars from the mill rolls shown in Fig. 79. The bars are allowed to cool, and are afterwards cut up with shears into suitable lengths; these are then made into bundles, or "piles" of the required weight and size. When a specially smooth surface is required, as in the production of sheet iron, it is usual to make the top and bottom of each pile of "scrap bars;" these are made by reheating the crop ends of finished bars or other good wrought-iron scrap, and are therefore more uniform in character, and possess a smoother and cleaner surface than ordinary puddled iron.

Reheating Puddled Iron.—The puddled iron having been prepared as before described, is now taken from the forge to the other part of the works which is known as the "mill." This is usually covered with a tolerably lofty roof, but is open at the sides; it contains reverberatory furnaces for heating the piles of puddled iron, and also rolls of various sizes, with the necessary engine and connections required for producing the various "sections" of finished iron. A steam hammer is also provided if forgings are produced, but otherwise this is not required.

The ordinary direct-fired reheating or "mill furnace" is shown in Figs. 76 and 77; the former being from a photograph showing the outside of the furnace, with the two working doors (one of which is opened and the other closed in the illustration), the piles of puddled bar, the tools, and the trolley employed for charging the furnace. Fig. 77 shows a section of a furnace with one door—a being the chimney; b, the fireplace; c, the cast-iron

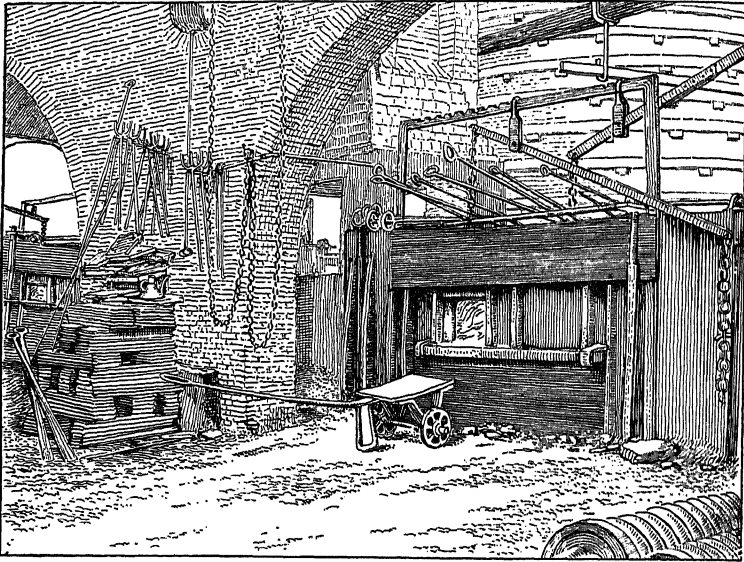

Fig. 76.—Re-heating or "mill" furnace—General view.

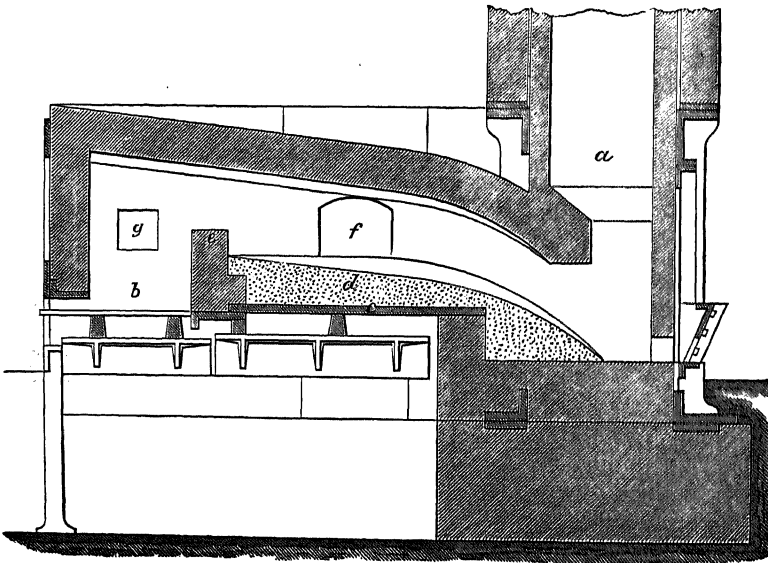

Fig. 77.—Section of mill furnace.

bottom plate; *d*, the working bottom, which may consist of sand, ferric oxide, basic slag, or burnt clay; *e*, the firebridge; *f*, the working door; and *g*, the firing hole. It will be observed that the working bottom slopes to the bottom of the flue, so that any fluid cinder that is produced runs away and flows out at the flue bottom. This slag, which consists of ferrous silicate, and which is less valuable when a sand bottom is employed, is known as "flue cinder."

Ordinary coal-fired reheating furnaces are relatively inexpensive to erect and are easily worked; they are, however, very extravagant in fuel, while the waste due to oxidation is usually considerable. On this account gas-fired reheating furnaces have met with considerable favour in recent years, as their use has led to a marked reduction in the consumption of fuel, and not unfrequently also to a diminution of waste equal to $2\frac{1}{2}$ per cent. and upwards.

The new form of Siemens furnace* (Fig. 70) has in particular been adopted for reheating iron and steel, and with this the fuel consumption is little more than one-third of that required by the direct coal-fired furnace. The temperature employed in such furnaces is a white heat, and sufficiently high to cause the metal to weld together when it is passed through the rolls, to which it is taken from the mill furnace.

Rolls.—The rolls used in iron works are classified according to their shape and the method adopted in their production. They are generally made from a strong close-grained cast iron, usually that obtained from a blast furnace in which cold blast is employed. Occasionally steel rolls are used, and these appear to be somewhat growing in favour in recent years.

Rolls may be classified according to their shape into—

(1) *Flat or Plain Rolls* which are used for rolling sheets or plates.

(2) *Grooved Rolls* which are required for the production of bars, strip, rods, angle and channel iron.

According to their method of production rolls are classified as—

(1) *Grain Rolls* which are produced in moulds of green or dry sand, and in which the surface of the roll shows the ordinary grain of the cast iron from which it is made. These are used for all roughing purposes and for sections, and in other cases if the metal is finished hot.

(2) *Chilled Rolls* which are produced in cast-iron moulds or chills. They, therefore, have a hard white surface of chilled iron, which varies in thickness from about $\frac{1}{4}$ to $\frac{3}{8}$ of an inch in thickness, according to the size of the casting and the class of work for which it is intended. Rolls of this kind are more costly, and are employed for the production of sheets, plates, or

* See Roberts-Austen's *Metallurgy*, p. 262; *Inst. Journ.*, 1890, vol. i., p. 18.

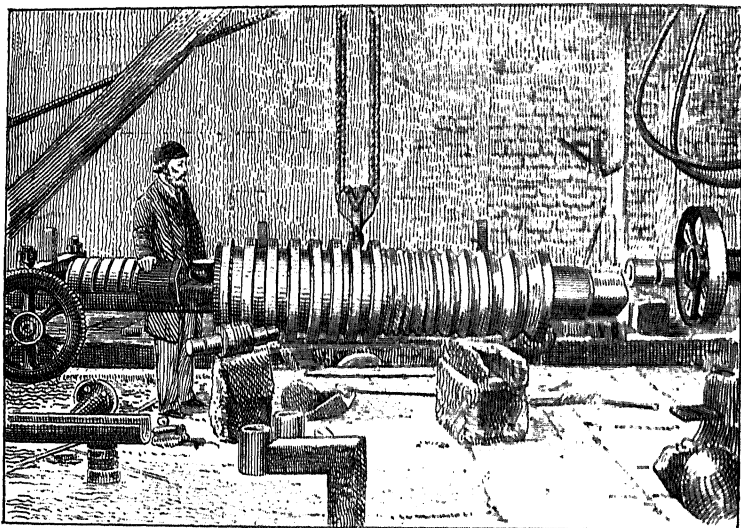

Fig. 78.—Largest and smallest rolls used in ordinary bar mills.

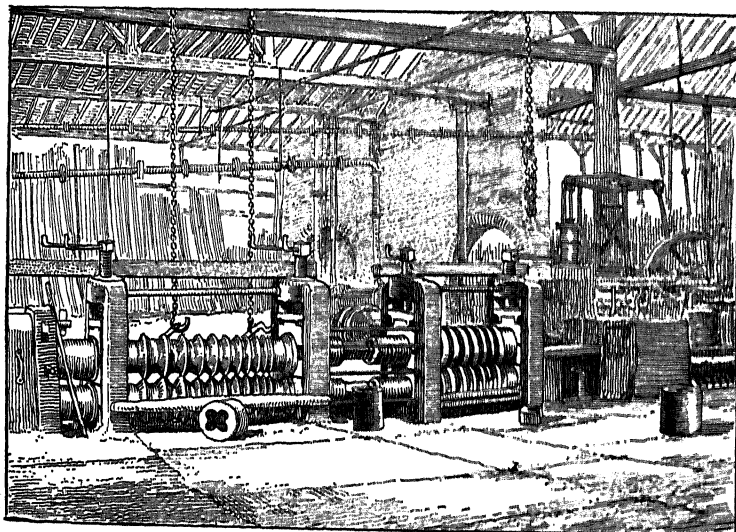

Fig. 79.—Train of two high mill rolls.

strip, or in other cases where specially fine surfaces are required. South Staffordshire has long been reputed for the manufacture of chilled rolls of the best quality, and for this purpose a mixture of several brands of cold blast pig iron is melted in the air furnace so as to obtain the greatest possible uniformity.*

The relative sizes of the largest and smallest roll employed in a Staffordshire iron works are shown in the accompanying illustration (Fig. 78) of part of the interior of a roll-turning shop attached to such an establishment. The large grooved roll in the centre is the large "roughing" roll used in the mill for

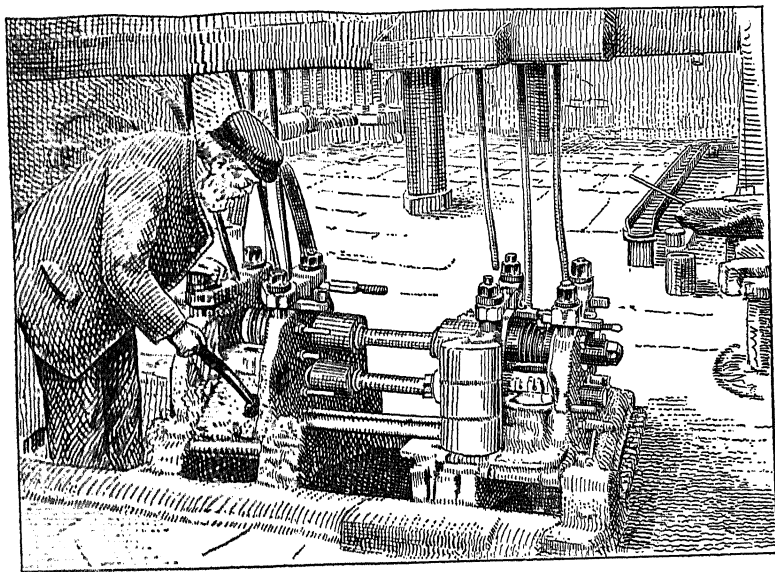

Fig. 80.—Guide rolls.

rolling the reheated piles into bars, and this is very similar to the forge rolls employed for the production of puddled bar. Resting in a block in front and on the left of the larger roll is a "guide" roll, which is the smallest roll used in an iron works; this is employed for the production of the smallest sections, which are only one size thicker than wire.

The general arrangement of a standing, and the housings, of a train of mill rolls is shown in Fig. 79. The housings are of cast iron, and are fixed to suitable foundations beneath the mill floor; the working floor consists of slabs of cast iron. In the illustration will be noticed three cylinders of iron, which were

* On the causes of fractures of chilled rolls, see *Inst. Journ.*, 1887, vol. i., p. 416; C. A. Winder, *ibid.*, 1892, vol. ii., p. 176; B. H. Thwaite, *S. S. Inst.*, 1892.

cast with a hollow cross with rounded corners throughout the length of each cylinder. These are the "wobblers" which are attached to the shanks of the rolls, and are used to connect together the two pairs of rolls, so that they may be driven from the same engine. A forge train is almost identical in appearance with the train of mill rolls shown in Fig. 79, the chief difference being that with mill rolls the surface is more carefully turned and better kept, while the shape of the second pair or "finishing" rolls in the mill will vary more than in the forge, on account of the greater variety in the sections which have to be produced.

A train of guide rolls is shown in Fig. 80. These rolls receive their name from the fact that as the iron produced in them is very thin it is very liable to twist about in all directions as it issues from the rolls. On this account it is necessary to pass the metal through holes or guides arranged in front of the rolls; two of these holes are shown in front of the right-hand pair of rolls in the illustration. These rolls are cooled by water delivered by pipes which are supplied from a channel shown at the top of the figure. An iron channel is also provided at the back of the rolls, and along this the heated rod is caused to pass as it emerges from the rolls; in this way the iron is kept much more nearly straight, and the danger of the iron suddenly twisting around and injuring the workman is minimised.*

Two high rolls, such as those previously described (p. 322), are simple and readily worked; they are, however, relatively slow, owing to the time necessary for returning the metal to the starting place after each passage of the rolls. In three high rolls much time is saved, and these are largely used in America and also in Belgium. Three high rolls are in successful operation in some British works, and it is a matter for surprise that two high rolls are still used in so many establishments. The details of rolling and rolling mills is rather a branch of engineering than metallurgy, so will not be further considered in this volume.

Waste in Reheating Iron.—During the reheating of puddled bar, and its subsequent treatment for conversion into finished iron, a variable, and frequently a considerable, waste takes place. The amount of this loss depends upon a number of circumstances, and is due to the following causes:—

1. *Crop Ends.*—The ends of finished bars and the edges of plates or sheets are always more or less ragged and irregular; they are, therefore, cropped or sheared to ensure uniformity. Not unfrequently also, in finished iron, a definite length of bar or width of sheet is required, and any deviation from the required size naturally leads to waste. The production of rough edges is reduced to a minimum by a careful arrangement of the piles, as any irregularity in the position of the bars in a pile always leads to spilly ends and rough edges. The weight of the pile, when the quality of iron is known, affords a good

* See note at end of this Chapter.

indication of the size of the finished iron, and special tables have been compiled, such as those published by J. Rose, of Bilston, or by G. Williams, of Old Hill, for the purpose of affording information on this point. The proportional loss from the causes just mentioned is greatest in plates and sheets, where it may exceed 25 per cent., and least in long bars and strips.

2. *Oxidation*.—The oxidation which takes place in the reheating furnace often leads to considerable waste. The amount of this will depend on the surface that is exposed to oxidation, and thus sheets or small piles generally lose more than large bars or big piles. Much will also depend on the nature of the furnace itself, on the draught, and on the attention of the workman in maintaining a neutral or a reducing atmosphere. Gas furnaces have met with considerably more favour for reheating purposes than for puddling, and they generally show a marked economy, not only in regard to fuel, but also on account of the more ready control of the furnace, in the waste of iron due to oxidation. When a furnace is filled too full the loss due to oxidation is increased, as one portion is exposed to the atmosphere while the iron first drawn is being worked. Accidental circumstances, such as the stoppage of machinery, also lead to considerable loss at times.

3. *Nature of Bottom*.—The loss in the reheating furnace is affected by the nature of the material that is employed for the working bottom. When this is composed of pottery mine or similar material rich in ferric oxide, the loss is greatest, though it is true that this is to some extent compensated for by the production of a form of very pure magnetic oxide, known as "best tap" (or sometimes best "flue cinder"), which is one of the very best fettlings used in the puddling furnace. Sometimes this cinder is allowed to flow away as it is formed, when the furnace is said to work with a "dry" bottom, at others the cinder forms a layer an inch or more in thickness, and is tapped off at intervals, in which case the term "fluid" bottom is generally applied. In the latter case especially it is important that the iron should not be allowed to remain in the furnace longer than is actually necessary to heat the piles uniformly through, as otherwise the lower part of the pile will be eaten away by the oxidising cinder. In any case it is necessary to turn the piles over at the proper time, or to change the position of very large piles, as otherwise they will remain colder at the bottom than at the top, and will not roll uniformly. Large piles sometimes are placed on pieces of wood of suitable size; these burn away while the iron is heating, and help to heat the bottom of the pile; in this case the piles need not be moved until the charge is withdrawn.

The most general custom is to employ sand for the working bottom of mill furnaces. A sand bottom requires to be repaired,

and to some extent renewed, after every heat, owing to the fact that a combination takes place between the sand and the oxide, which is produced on the surface of the iron with the production of acid ferrous silicate (FeO, SiO_2), which is quite fusible, and running off the sloping bed of the furnace, is collected in a hollow or in a cinder waggon at the furnace flue. The product called "mill" or "flue cinder" is too rich in silica to be of value as a fettling, though, on account of its freedom from phosphorus, it is used with advantage in the blast furnace. Sand bottoms thus tend to combine with the coating of oxide which is first produced on the iron, and, by removing this, they lead to further oxidation and greater waste; but they have the advantage of cheapness, of uniformity in heating, and in the production of clean piles for rolling.

In order to diminish the loss just referred to, Messrs. Harbord & Tucker have patented the use of basic slag for the bottoms of mill furnaces.* This slag, which is fluid at the temperature of steel melting, is sufficiently refractory to form a strong and practically permanent bottom for mill furnaces; and being itself of a neutral or somewhat basic character, it does not combine with oxide of iron. The cinder produced makes a good fettling, while the waste is less than with either of the bottoms previously mentioned. The author had an opportunity of carefully watching the first trial of this material, in 1886, at the works of the Staffordshire Steel Company, and was much impressed with the satisfactory results obtained in reheating steel ingots; it has since been largely employed for iron and steel in different parts of the country with marked success. In some cases it has been noticed that the bottom had a tendency to stick to the piles, but this is stated to be due to the use of inferior slag in some cases, and to want of care in others. Burnt fireclay, in the form of crushed pots or drain pipes, is another form of neutral material which is also used for furnace bottoms.

4. *Quality.*—When all other conditions are kept constant, so far as this is possible, it is found that the loss in reheating iron varies with the quality, *i.e.*, with the chemical composition of the puddled bar employed, and that the loss in the mill furnace increases with the proportion of phosphorus retained in the puddled bar. In conjunction with A. E. Barrows, the author has recently investigated this subject, and for the purpose of the experiments, special puddled bars were made from best and from common pig iron of known composition. This puddled iron was then reheated and rolled out into sheets in the ordinary way, except that no scrap was added to the pile as is usual. Each sample was treated in a precisely similar manner, and analyses were performed of the puddled bar and of the finished iron; the slag was also determined in each sample, in order to prove

* *Inst. Journ.*, 1887, vol. ii., p. 319.

whether the difference were due merely to a squeezing out of more intermingled slag in one case than in the other. The cast iron used in the charge for best iron did not contain more than 0·5 per cent. of phosphorus and 1·5 per cent. of silicon, while that for common iron contained 1·75 per cent. of phosphorus and about 2·5 per cent. of silicon. The average yield of common puddled iron, as determined by regular weighings at the works, was 5·7 per cent. greater than that of best; but on reheating in the mill furnace and rolling into sheets, the common iron lost between 1 and 1·5 per cent. more than the purer variety; the nett result was, therefore, some 4·5 per cent. in favour of the common iron. The analyses of the samples were as follows:—

	BEST.		COMMON.	
	Puddled Iron.	Finished Sheet.	Puddled Iron.	Finished Sheet.
Carbon,	0·06	0·035	0·045	0·032
Silicon,	0·228	0·168	0·275	0·221
Phosphorus,	0·178	0·175	0·598	0·390
Slag,	3·83	2·58	3·85	2·85

It will be seen from these figures that the loss of carbon and silicon during reheating was nearly the same in each variety of iron, but the phosphorus removed was very much greater with the more impure sample than in the other case, and amounted to nearly 0·2 per cent. If it be assumed that this phosphorus was removed in the form of ferrous phosphate ($\text{Fe}_3(\text{PO}_4)_2$), which is probable, this would correspond to an additional loss from the common iron in the mill furnace of 1·13 per cent., which agrees well with what was actually observed. The amount of slag originally present in each case was for practical purposes identical, and the common iron lost 0·25 per cent. less slag than the best. These experiments appear to show that the difference in yield noticed on reheating best and common iron is not so much due to any difference in the amount of the mechanically entangled slag, but that it is, as before stated, closely connected with the proportion of phosphorus present in the puddled iron.*

From the foregoing considerations it will be seen that the loss during reheating is less when the iron to be treated is pure, when the piles are carefully weighed, the individual pieces properly arranged, and the masses to be treated are as large as possible; while, so far as the furnace is concerned, the waste

* See *Journ. Chem. Soc.*, 1892, p. 551.

is at a minimum when a neutral bottom is employed, when the air supply is so completely under control that there is the least possible excess of free oxygen in the furnace, and when the machinery and other arrangements of the works allow of the iron being drawn as soon as it is ready.

Effect of Repeated Reheating of Iron.—As it is well recognised that puddled iron is much improved in quality by being cut up, piled, reheated, and rolled or hammered, and that the iron is further improved by repeating the operation, it might be assumed that by continuing this process the properties of the metal might be again and again further improved. In practice, however, this is not found to be the case, and it is only in special cases that it is advantageous to reheat puddled iron more than once. It has been shown by experiments, in which puddled bar was reheated and rolled as many as twelve times, that after about six workings the metal began to seriously deteriorate, and even in the earlier workings, after the third no corresponding advantage was obtained for the fuel and labour expended, and the waste incurred. The results obtained were as follows (*Useful Metals*, p. 318):—

	Tensile Strength.
Original puddled bar,	43,904 lbs. per sq. in.
2nd working,	52,864 " "
3rd "	59,585 " "
4th "	59,585 " "
5th "	57,344 " "
6th "	61,824 " "
7th "	59,585 " "
8th "	57,344 " "
9th "	57,344 " "
10th "	54,104 " "
11th "	51,968 " "
12th "	43,904 " "

If it be assumed that the result in the fifth heating was accidentally low, it will be seen that all the other tests follow in a regular succession, the maximum tensile strength being obtained with the sixth working. Probably with iron of different composition or character the maximum would be reached at a different point, but in all cases the gradual original improvement and subsequent deterioration would be observed. When the metal passes into the hands of the smith it is found that if it has been worked during its previous preparation so as to bring it to its best condition, it has a tendency to "go back" in forging; while, on the other hand, if the iron has not been unduly worked, it improves when properly smithed. For this reason also it is not advantageous to often reheat and work iron during the process of manufacture, and "best," "best best," or "treble best" irons are obtained not by frequent heatings, as is sometimes stated,

but by the careful selection of all the materials employed, and by systematic and frequent tests of the iron during the various stages of manufacture.

Sections of Finished Iron.—The shape into which finished iron is rolled varies according to the purposes for which it is designed, the chief divisions being plates, sheets, strip, bars, angle iron, and rails, the last being relatively of much less importance than formerly. Among the more usual shapes or “sections” may be mentioned the following:—Bars, including round, half-round, square, flat, round edged flats, oval, octagon, together with levelled and bulb iron, and rods; tee (or T-shaped) iron, tee with round top or edges; angle (or L-shaped) iron, angle iron with unequal sides or round back; channel iron, H iron, Z iron; rails, including single headed, double headed, and flange; and horse-shoe iron, which is rolled single grooved, double grooved, or concave. Numerous other forms are also required from time to time for various purposes, so that the number of rolls which have to be kept in stock at a large works with a general trade is very great, not unfrequently amounting to hundreds. As each pair of rolls is generally only capable of finishing one section of iron, the cost of the supply and maintenance of rolls forms a considerable item of the expenditure of an iron works.

Imperfections in Finished Iron.—The three chief varieties of imperfection in the appearance of finished iron are—rough edges, spilly places, and blisters.

(a) *Rough edges*, when not due to imperfection in the rolls or careless working, are a sign of redshortness, and are particularly noticeable in flat bars or strip. Redshortness may be due to an excess of carbon, or to the presence of sulphur, particularly if copper is also present. Usually, however, if iron has been properly puddled, practically the whole of the sulphur is eliminated, and the redshort condition is due to the “dryness” of the iron. Iron is said to be dry when it is deficient in fusible or welding cinder which may be readily squeezed out from between the particles when the iron is worked, and so enable clean surfaces to be brought together to form a good weld. A thick dry cinder, on the other hand, leads to redshortness, and a piece of brick or other foreign matter which crushes up in the rolls to form a dry powder acts in the same manner.

(b) *Spilly places* are spongy or irregularly spotted parts which are not unfrequently noticed in sheets, and which are occasionally met with in all kinds of wrought iron. They are generally due to imperfect puddling, whereby one part of the iron, when coming to nature, has been oxidised more than another. If the heat has been thoroughly well

worked, and the iron uniformly mixed, spilly places are seldom observed.

(c) *Blisters* are not unfrequently met with in sheets, and lead to considerable loss and inconvenience. They are much less common in steel sheets than in iron, and some experiments conducted in 1893 led the author to attribute the formation of blisters to a reaction between carbon and oxide of iron in wrought iron of inferior quality. This view is in accordance with the experiments of A. Friedmann, who collected and analysed the gas contained in a number of blisters. This gas was found to contain over 70 per cent. of carbon monoxide, the remainder being chiefly carbon dioxide, with some nitrogen and hydrogen. Inside the blisters a quantity of scaly matter is found, which Friedmann states to consist of about two-thirds silica, and nearly one-third iron aluminate (FeAlO_3), together with small quantities of other oxides.*

Rolling Steel.—The demand for mild steel in small sizes is steadily increasing, and in many works even where puddling is carried on a good deal of mild steel is bought in the form of billets and rolled into smaller sizes. It is found that the waste in reheating and rolling steel is less than with wrought iron, partly because in puddled bar there is a quantity of slag, which has to be squeezed out by the rolls, and thus leads to a diminution in yield. As the steel billets are cut level at each end, the loss due to crop ends in the finished state is also less, while as steel is not heated to so high a temperature the loss due to oxidation is proportionately diminished. At the same time the power required to roll steel is greater, as the two important factors which determine the power needed are the tenacity of the metal and the temperature at which it is rolled. The tenacity of mild steel is about one-third greater than that of wrought iron, and increases with the addition of carbon. The tendency to “burn” the steel also increases with the content of carbon, so the high carbon steel cannot be heated to so high a temperature as mild steel, while wrought iron will stand the highest temperature without injury. In some experiments on the rolling of deep joists 50 feet in length, it was found by F. Braune † that when the circumferences of the rolls were speeded in the proportion of 14 to 11 faster for steel than for iron, the power required for rolling mild steel is about three times that needed when rolling iron; the power required to roll high carbon steel is still greater than that used with mild steel.

Physical Properties of Wrought Iron.—The tensile strength, ductility, and other properties of wrought iron vary with the composition and method of production, though, as the percentage

* *Inst. Journ.*, 1885, vol. ii., p. 645.

† *Proceed. Inst. C.E.*, vol. lxx., p. 441.

of carbon is always tolerably low, these variations are not nearly so great as in the case of different varieties of steel. The size and shape of the piece exert a marked effect on the tenacity and ductility, it being observed that smaller bars and thinner plates possess a greater tenacity on account of the work which has been done upon them, and the fibrous texture which this work develops. On account also of this fibrous texture, which is so characteristic of good wrought iron, the tenacity, if measured in the direction of the fibre or "grain," is greater than when determined across the piece. The tensile strength of bars with the skin on, as they come from the rolls, is also greater than in the same bars when they have been turned in the lathe. The observed tenacity of wrought iron varies from about 18 to nearly 30 tons per square inch of original sectional area, and engineers specify from 17 to 26 tons, according to the size and quality required. In some cases also it is specified that the tensile strength measured across the grain shall not be more than 2 to 4 tons less than that measured with the grain. The stress necessary to produce a permanent deformation of shape, or "permanent set," is called the "limit of elasticity," and is fairly constant in different varieties of iron, being seldom less than 12 or greater than 16 tons to the square inch. Tensile tests alone are not a sufficient indication of the quality of iron for constructive purposes, as both an extremely pure or a very common material usually have a relatively low tensile strength, while the greatest tenacity is associated with an intermediate chemical composition. For many purposes the ductility of a sample of iron or steel affords more information than can be obtained by tensile tests, and it is usual to specify both classes of test in materials to be employed in construction.

Ductility is measured by means of a tensile testing machine, and is expressed in two ways—by percentage extension of original length under tension, which is generally known as "elongation;" and by the percentage difference between the original area and the area of the fractured test piece; the latter is calculated on the original area, and is known as the "contraction" or "reduction of area."

In measuring elongation it is important that the original length of the sample should be stated, as the purely local extension which takes place in ductile metal at the point of fracture will bear a larger proportion to a short than to a longer test piece. This is illustrated in the following table, showing the percentage elongation of a number of samples of iron, which were in each case tested in three different lengths; the tests were performed at University College, London. From these it will be seen that the percentage elongation is greater with short than with long test bars:—

Number of Sample.	Lengths of Test Pieces.		
	9 $\frac{1}{2}$ Inches.	6 $\frac{1}{2}$ Inches.	3 $\frac{1}{2}$ Inches.
	Per Cent.	Per Cent.	Per Cent.
1,	4.16	4.96	6.40
2,	5.12	5.92	7.04
3,	4.05	4.48	5.76
4,	6.40	7.20	8.96
5,	7.47	8.00	10.20
6,	11.20	12.50	13.80
7,	5.33	5.44	7.04
8,	8.75	9.12	10.60
9,	2.56	2.88	3.84
10,	9.39	10.13	11.2
Average,	6.4	7.0	8.5

The usual length of test piece employed by the Admiralty and other important boards for wrought iron is 8 inches. For scientific purposes a length of 10 inches is sometimes preferred.

The contraction of area of wrought iron is influenced by the shape, and to a smaller extent also by the size, of the test piece. The greatest reduction of area is obtained with round bars, flat bars are somewhat less, angle iron less again, while plates or sheets show least reduction. The contraction in iron of good quality may vary from about 3 per cent. with thin plates, to 45 per cent. or even upwards with round bars. The following figures give the result of tests of four samples of wrought iron, two of unusually good, and two of unusually bad, quality, and illustrate the fact that in each case the elastic limit is about the same, and that the tenacity of very pure Swedish iron is less than that of the very common iron tested at the same time. The contraction of area and the elongation were, however, very much greater with the Swedish and best Yorkshire iron than with the two latter inferior varieties. The great importance of ductility tests in such cases is very evident, as metal deficient in ductility, though stronger, would be very liable to fracture suddenly when subjected to strain in practice:—

Variety of Iron.	Form.	Limit of Elasticity.	Tensile Strength.	Contraction of Area.	Elongation.
Swedish charcoal,	1 in. sq. bar	Tons. 12.25	Tons. 19.6	Per Cent. 72.18	Per Ct. Ins. 56 on 3 $\frac{1}{2}$
Best Yorkshire (Bowling),	1 $\frac{1}{2}$ in. round bar	13.7	22.7	55	29 on 10
Very common,	1 in. sq. bar	13.75	20.98	5.29	1.5 on 3 $\frac{1}{2}$
Puddled iron,	$\frac{1}{2}$ -inch plate	13.8	18.6	4.5	3 on 10

FURTHER TREATMENT OF WROUGHT IRON.

In conducting experiments with a tensile testing machine will be observed that if the load be applied quickly, so as to allow little time for the metal to adjust itself to the increased stress, the tensile strength recorded will be more, and the elongation and reduction in area less, than when the tests are performed slowly. Such differences are, however, usually not great, except when extreme variations of speed are adopted. The following suggestions for a series of standard uniform tests have been made by T. Morris of Warrington, who has had considerable exceptional experience in the manufacture of wrought iron.

Form of Iron.	"BEST."		"BEST BEST."	
	Tensile, Tons per Square Inch.	Contraction of Area per Cent.	Tensile, Tons per Square Inch.	Contract of Area per Cent.
Rounds and squares, . . .	22.5	20	23.5	30
Flats,	22	15	23	20
Angles and tees,	21.5	12.5	22	17.5
Plates with grain,	21	8	22	10
„ across grain,	17	4	18	5

Morris considers that iron of the form and qualities above given may be expected to regularly conform to these tests, but that in bars if the tenacity be deficient the iron should not be deemed satisfactory if the ductility be correspondingly high, and also that in plates the iron should be deemed satisfactory if the mean tensile strength, as measured with and across the grain, be equal to that above given. By making such allowances to meet accidental variations such as are observed in iron of good quality, it is held that no results need be lower than those suggested by Morris.*

The tests and requirements of structural wrought iron and steel have also been considered at length by A. E. Hunt in a paper read before the American Institute of Mining Engineers.

* *S. Staff. Inst.*, Feb., 1893.

† *Inst. Journ.*, 1892, vol. i., p. 479.

Note.—The rolls shown in Fig. 80 consist of two sets, known respectively as the "ovals" and the "finishing" rolls. In rolling small sizes it is unusual to couple these directly together, as shown in the illustration. Both pairs then rotate in a similar manner and deliver the iron in the same direction. The iron having passed through the "ovals" is brought back and turned into the "finishing" rolls. In order to do this, before it passes into the guides proper, it is passed round the circular iron cylinders or spindles, shown in the illustration.

CHAPTER XVII.

CORROSION OF IRON AND STEEL.

THE stone bridges, buildings, and other structures erected in past ages have under favourable conditions remained unaffected by atmospheric influences for centuries. Iron, on the other hand, while it possesses great advantages in respect of strength, lightness, ductility, and convenience, is liable to deterioration by the combined action of air and water, and when continually exposed to such influences may become so rapidly weakened as to lead to serious inconvenience or to grave danger. The result of the oxidation of a boiler plate, a girder, a rivet, or a wire rope, for example, may lead to disastrous results; and it therefore becomes necessary to indicate the conditions which cause such important changes, and the methods which are adopted to preserve iron and steel from atmospheric influences.

Rusting.—It is a matter of general observation that iron rusts when exposed to moist air, and that this rusting gradually proceeds until the whole of the metal is converted into a bulky brown substance which consists of hydrated oxide of iron. Although the ultimate result of the rusting of iron is the production of ferric oxide, it was shown by Mallet that magnetic oxide is produced in the first place.* This observation is confirmed by analyses of rust given by Jamieson,† while the results of a number of analyses by Professor Liversidge have also proved that rust, whether produced naturally or artificially, almost invariably contains ferrous oxide, and is attracted by a magnet.‡

The following analyses of rust are by Crace-Calvert :—§

	Conway Bridge.	Llangollen.
Ferric oxide,	93·094	92·900
Ferrous oxide,	5·810	6·177
Ferrous carbonate,	0·900	0·617
Silica,	0·196	0·121
Ammonia,	trace	trace
Calcium carbonate,	0·295

The volume of the rust is much greater than that of the iron

* *B. A. Report*, 1838, p. 258.

† *Inst. C.E.*, vol. lxx., p. 325.

‡ *Inst. Journ.*, 1892, vol. i., p. 482.

§ *Chem. News*, vol. xxiii., p. 98.

from which it is produced, and some observations by Bauerman have shown that malleable iron produces about ten times its own volume of rust.* Like other porous substances rust has the property of condensing in its pores and absorbing various gases, particularly water vapour and ammonia.

Causes of Rust.—An interesting account of the earlier observations in connection with the causes which lead to the production of rust has been given by Mallet,† while the information has been extended by the experiments of Crace-Calvert,‡ and summarised and brought up to date by Crum Brown.§ The whole subject of corrosion has also been dealt with at considerable length by H. M. Howe, in his *Metallurgy of Steel*, 1892, p. 94.

It was shown by Marshall Hall so far back as 1818 that pure iron is not attacked at any temperature below 100° C. by pure water which had been freed from dissolved air; nor does pure air or oxygen act upon iron at ordinary temperatures. The author has hermetically sealed bright iron in glass tubes containing pure water and dry air respectively, and found the metal perfectly bright and unaltered after being so kept for seven years.

Crum Brown states that the essentials for the formation of rust are liquid water, oxygen, and carbonic acid, though under special circumstances other acids may of course take the place of carbonic. Iron remains quite free from rust in an atmosphere containing oxygen, carbonic acid, and water vapour, so long as the water does not condense on the surface of the metal. Neither does rusting take place so long as the water contains an alkali, such as lime or potash, which is capable of combining with carbonic acid; but when the alkali has by long exposure combined with the carbonic acid of the atmosphere rusting commences. The soluble carbonates and bi-carbonates of the alkali metals also prevent rusting, according to Crace-Calvert. The stages in the formation of rust are, first, the formation of ferrous carbonate; secondly, the solution of this in carbonic acid water as ferrous bi-carbonate; and thirdly, the decomposition of ferrous carbonate, in presence of air and moisture, to form hydrated ferric oxide, magnetic oxide being formed as an intermediate product, as already stated. No carbonic acid is used up in the process; but as rapidly as it is set free from the carbonate it is at liberty to attack more iron. The rust, from its hygroscopic character, favours the absorption of moisture from the air, so that iron in contact with rust will continue to oxidise in an atmosphere which is not saturated with water vapour. The presence of rust also favours further oxidation owing to its electrical action when in contact with iron.

* *Inst. Journ.*, 1888, vol. ii., p. 135. † *B. A. Report*, 1838, p. 254.

‡ *Loc. cit.*

§ *Inst. Journ.*, 1888, vol. ii., p. 129.

According to Mallet, rusting proceeds more slowly in pure than impure water; and with fresh water and air it takes place more rapidly between 175° and 190° F. than at any other temperature. Water containing putrefying organic matter acts very rapidly on iron, as might be anticipated from the presence of carbonic and other acids. Rusting is also more rapid at a river mouth than with either salt or fresh water alone, as the layers of fresh and salt water, which are met with at the mouth of a tidal river, lead to a different electrical condition in the upper and lower parts of the iron. Cast iron with the skin on, as the casting is taken out of the mould, resists oxidation much more perfectly than if the protecting surface is removed; while clean cast iron corrodes more quickly in fresh water, and more slowly in sea water than wrought iron. Of different varieties of cast iron, those which are grey and possess a close texture appear to resist corrosion best.*

In more recent experiments, conducted by Gruner in 1883, it was found that cast iron with cleaned surfaces is less attacked by air and moisture than either wrought iron or steel, though it is more rapidly acted on by sea water or diluted acids. White cast iron was also more attacked by sea water than grey iron, but less by moist air or diluted acids.†

The ironwork in railway tunnels and similar places is specially liable to rusting, as such positions are usually damp, and the drainage water frequently contains salt in solution. The sulphur dioxide in the gases evolved from the locomotives also assists in producing corrosion, and sulphuric acid to the extent of from 0.4 to upwards of 3 per cent. has been found in rust from railway tunnels.‡ Thörner has also confirmed the observation that rust in railway tunnels frequently contains sulphuric acid, and states that where much sulphur is present the parts kept wet by the dripping of water rust less rapidly than the rest of the ironwork.§

Corrosion is promoted by the presence of copper, lead, or other metals which in contact with iron and water become negative, and lead to the production of an electric couple. Hence, as pointed out by E. A. Davy,|| copper or lead should not be used in contact with iron which is exposed to the action of sea water; though it has been observed that zinc-copper alloys, when not too rich in copper, on account of the zinc they contain exert a protective action. R. Mallet states that iron is protected as completely by an alloy of twenty-three parts of zinc and eight parts of copper as by zinc itself, while the protecting metal is scarcely attacked by sea water.¶ On the other hand, alloys of tin and copper promote corrosion.

* *B. A. Report*, 1843, p. 1, *et. seq.*

† *Inst. Journ.*, 1889, vol. i., p. 390.

‡ *B. A. Report*, 1835, p. 35.

† *Compt. Rend.*, vol. xvi., p. 195.

§ *Ibid.*, 1889, vol. ii., p. 470.

¶ *Ibid.*, 1840, p. 262.

Sulphur, when in the form of sulphides, also assists in corrosion of iron, as in the case of sewage, which, especially when mixed with sea water, very rapidly attacks any unprotected surfaces of iron with the formation of ferrous sulphide. When sulphates are present together with decomposing organic matter the sulphates are reduced to sulphides, and thus lead to the production of sulphide of iron. It is probable that by an action of this character most of the native deposits of iron pyrites are of their origin.*

A new source of corrosion in underground iron pipes has arisen in recent years with the extended use of electricity for lighting and traction purposes in the streets of large towns. It is observed that a difference of merely a fraction of a volt in electric potential between pipes and the damp earth leads to an electrolytic action whereby the iron is rapidly corroded. This subject has been investigated by I. H. Farnham,† who concludes that the safest and best assured by frequent measurements of the voltage between pipes and the earth, and protecting conductors should be induced or changed as shown to be necessary. Apparently it is not practicable to properly insulate, or to effectively break the metallic conductivity of underground pipes, and hitherto the most efficient protection has been obtained by the use of large conductors extending from the grounded side of the dynamo through the danger territory and connected at every few hundred feet to such pipes as are in danger.

Varieties of Rust.—In a paper dealing with the internal corrosion of cast-iron pipes, M. J. Jamieson states that the interior of corroded pipes is generally in one of two conditions. When iron is directly exposed to the action of the water the rust is uniformly distributed, and grows rapidly. Where the iron has been protected by a coating of asphalt the rust appears in detached carbuncles or knots, where the protection is weak and gradually spreads over the whole surface, ultimately growing as rapidly as when the iron was unprotected. The corrosion appears to be proportional to the volume of water passing through the pipe. Cast-iron water pipes require to be regularly cleaned from rust when in use, as this prevents the pipes from becoming choked, and diminishes the corrosion.‡

Mallet had previously noticed that in some cases of corrosion in sea water the surface of the iron remained perfectly bright and clean though the metal was gradually dissolved. In river water it not unfrequently happens that the rust forms a firmly adherent crust, while the usual form is a loose brown or reddish-brown powder. There is, however, another variety, to which Mallet gave the name of "tubercular corrosion," and to which Jamieson

* *Journ. Soc. Chem. Indust.*, vol. x., p. 237.

† *Amer. Soc. Elec. Eng.*, April, 1894.

‡ *Inst. C. E.*, vol. lxx., p. 323.

refers above. This is due to irregularity in the composition of the original metal, or to local conditions of the metallic surface whereby the rusting is confined to special points of the surface. The result is the formation of little mounds of rust, with "pitting" of the metal underneath. This form of corrosion is not unfrequently met with in tubes, boiler and ship plates, and other iron-work, and is usually very rapid in its destructive action.

Relative Corrosion of Iron and Steel.—Great differences of opinion have been expressed on the subject of relative corrosion of iron and steel, and various experimenters have obtained results which are apparently most contradictory. These differences have arisen, the author believes, on account of conclusions being drawn from limited observation, or special circumstances; while much confusion has arisen from failing to recognise that the conditions in fresh water, salt water, the interior of a boiler, or in diluted acids are all different, and that a specimen which may very successfully resist corrosion in one of these cases may readily oxidise in another.

On account of the greater uniformity in the physical properties of steel, and the laminated character of iron, it was anticipated in the early days of the use of mild steel that it would resist corrosion much better than wrought iron. Thus Sir L. Bell expressed the opinion that the cinder in wrought-iron rails would set up galvanic currents, and thus lead to more rapid corrosion.* Experience has, however, shown that on lines where there is very little traffic, and the chief agent of destruction is corrosion, wrought-iron rails wear better than steel.

The result of the experiments of the Admiralty Committees which were appointed to consider the causes of the deterioration of boilers, and which issued reports in 1877 and 1880, led to the conclusion that in all cases wrought iron resisted corrosion better than steel. Where the conditions were not severe the differences observed were not great; but where the plates were daily dipped in water, and exposed, during the rest of the time, to the action of the atmosphere, the superiority of iron was very marked; while common iron was less affected by corrosion than best Yorkshire iron, which is in accordance with the statement of Gmelin that phosphorus diminishes corrosion in iron. The following percentages in favour of iron were obtained in these experiments:—

Common iron resisted corrosion better than Yorkshire iron 9·6 per cent.
 Yorkshire iron resisted corrosion better than mild steel 16 „

In another series of experiments, conducted by D. Phillips, in Cardigan Bay, and lasting for seven years, it was found that the average corrosion of mild steel during the whole period, was 126 per cent. more than wrought iron.† The independent ex-

* *Inst. Journ.*, 1878, vol. i, p. 97.

† *Inst. C. E.*, vol. lxx., p. 73; *Inst. Marine Eng.*, May, 1890.

periments conducted by T. Andrews* also showed that wrought iron corroded less rapidly than mild steel when the cleaned metallic surfaces were exposed to the action of sea water.

The conclusions of the Admiralty Committee and of Mr. Phillips aroused much adverse criticism, and it was shown that, though steel is more affected by ordinary atmospheric corrosion, it is not usually more affected when in the form of a steel boiler. This was stated by W. Parker,† who based his conclusions on the result of over 1,100 actual examinations of boilers; and his observations were confirmed by many experienced makers and users of boilers who took part in the discussion of his paper. Sir W. Siemens also stated that experiments at Landore had shown that though in the open air wrought iron corrodes less than mild steel, experience with the working of boilers was in favour of the latter; Sir Henry Bessemer and others likewise bore testimony to the same effect;‡ while W. John, as a result of considerable experience in the construction of ships, stated that the protection of mild steel ships from corrosion is purely a question of care and maintenance,§ and the correctness of this view has been fully proved in the interval that has since elapsed.

It is generally believed that the presence of manganese in steel increases the readiness with which it rusts or corrodes. This view was held by Sir W. Siemens, who stated that as the manganese in mild steel increased, so the tendency to corrode became greater,|| while G. J. Snelus has ascribed the "pitting" in steel to the irregular distribution of manganese in the metal.¶ The author has observed that certain samples of manganese steel rust more readily than any other variety in the collection of specimens at Mason College, while it is well known that rich ferro-manganese, when exposed to moist air, oxidises with extreme rapidity. On the other hand, the author has kept samples of 18 per cent. silicon pig exposed to the fumes of the laboratory for several years without producing any appreciable quantity of rust; it has also long been observed that meteoric iron, which always contains more or less nickel, shows but little tendency to rust in air.

The experiments of Faraday led him to the conclusion that most of the alloys of steel with other metals corrode less readily in moist air than unalloyed steel; while, according to Mallet, the alloys of potassium, sodium, barium, aluminium, manganese, silver, platinum, antimony, and arsenic, with iron corrode more rapidly than pure iron; while the presence of nickel, cobalt, tin, copper, mercury, and chromium affords protection, the effect being in each case in the order given.**

Galvanic Action of Iron and Steel.—It is important where

* *Inst. C. E.*, vol. lxxvii., p. 323; vol. lxxxii., p. 281.

† *Inst. Journ.*, 1881, vol. i., p. 39.

‡ *Inst. C. E.*, vol. lxx., p. 101.

§ *Inst. Journ.*, 1884, vol. i., p. 151.

|| *Ibid.*, 1878, vol. i., p. 44.

¶ *Ibid.*, 1881, vol. i., p. 66.

** *B. A. Report*, 1838, p. 206.

structures of iron and steel are exposed to corrosion that the materials should be as uniform in character as possible, owing to the liability of a destructive action being set up by the union of metals of different electrical character. Such an action is observed when cast iron is in contact with wrought iron, as in water heaters with wrought-iron boilers and cast-iron tubes; in such cases the wrought iron is liable to be rapidly attacked, though in this case the action is no doubt accelerated by the scale on the surface of cast iron. It has also been stated by many experienced observers that when wrought iron and steel are in contact, in the presence of water, an electrical action results whereby the steel in the vicinity of the iron is rapidly attacked. It has, however, been pointed out by D. Phillips, that while in some cases much local action has been observed when iron rivets have been used in steel boiler shells, there are numerous cases of such construction where no injurious effect has been noticed;* and some experiments communicated to the same institution by J. Farquharson, in March, 1882, showed that while steel plates, when tested alone, lost about 12 ozs. by corrosion, and iron plates when similarly tested lost about 11 ozs., if the two plates were in electric contact the steel lost only about 4 ozs., while the iron lost 21 ozs., thus showing that in this case at all events, the result of the electric action was to protect the steel at the expense of the iron. W. Denny has also recorded a case of a steel ship in which the whole of the shell plates of the vessel were perfectly free from corrosion, while the iron stern plate and rudder forgings were much attacked.† The explanation of the apparently contradictory results noticed by previous observers, is probably to be found in some observations by T. Andrews in the course of some experiments on the galvanic action between different varieties of iron and steel during exposure to sea water. In these experiments metal of known chemical composition was employed, in the form of round rods, which were carefully turned and polished before use. The rods were immersed in sea water in a standard cell, together with a standard rod of wrought iron, and frequent observations of the electro-motive force of the couple were made with a delicate galvanometer. Though it was observed that the standard wrought iron was electro-negative to all the samples tested, it was also noticed during a lengthy course of experiments that a complete interchange of electro-chemical position occurred in the case of every metal at various times during the observations. These interchanges of position sometimes took place even after very considerable intervals, and it is doubtful whether a permanent position of rest finally ensues between the two metals, though eventually the galvanic action becomes very small.‡ It

* *Inst. Mar. Eng.*, May, 1890.

† *Inst. Journ.*, 1881, vol. i., p. 63.

‡ *Inst. C. E.*, vol. lxxvii., p. 330.

may therefore be concluded that though with dissimilar metal, such as cast iron and wrought iron, the galvanic action may be considerable, in the case of materials which are more alike, such as wrought iron and mild steel, it is exceptional for the corrosion from galvanic action to be very great, although its occurrence should never be overlooked; and when this action does occur, though it usually leads to the corrosion of the steel, it not unfrequently has a contrary influence. The danger of greatly increased corrosion with dissimilar metals is much diminished by their tendency to polarise each other's action, and thus lead to an interchange of electro-chemical position. Galvanic action between wrought iron and steel also appears to be materially reduced in the course of time; otherwise the liability to destructive corrosion, though never inconsiderable, would be more formidable.*

Effect of Scale on Corrosion.—That ordinary ferric oxide or rust acts electrically on the surface of iron and steel, and thus promotes corrosion, has long been acknowledged, and the evidence that mill scale, or black oxide of iron, acts in a similar manner, is now very strong. Thus Sir N. Barnaby† has stated that the action of oxide is as strong and as continuous as that of copper, and Sir W. H. White‡ observes that the opinion is not in any way speculative, but that many careful experiments conducted at Portsmouth have proved that when black oxide was left on portions of steel plates it produced pitting. W. John has also described§ how, on examining small mounds of rust on the outside of a recently launched steel vessel, he found that under each heap of rust there was a small hole in the paint, not larger than the size of a pin's head, and that beneath each hole was embedded a small particle of black oxide in a pit in the plate. The electrical aspects of the case have also been studied by different observers. J. Farquharson has described an experiment,|| in which two plates, one of iron and one of steel, were carefully cleaned from scale, when it was found that they corroded practically alike, but on combining one plate, either of iron or steel, with the skin on, with another similar plate from which the skin had been removed, it was found that the former did not corrode, while the later corroded very rapidly, thus proving the scale to be negative to iron. In 1882 T. Andrews took eleven plates of wrought iron, which were bent over in a \cap shape, one half being covered with scale, and the other half polished bright; they were immersed in a cell with clean sea water, so as to make a battery, and the current produced passed through a galvanometer. It was observed that the bright iron was positive to the scale, and a deflection of 17° was obtained on

* T. Andrews, *Trans. R. S. E.*, vol. xxxii., I. p. 218.

† *Inst. Journ.*, 1879, p. 53.

‡ *Ibid.*, 1881, vol. i., p. 68.

§ *Ibid.*, 1884, p. 150.

|| *Inst. C. E.*, vol. lxx., p. 105.

the galvanometer; this steadily decreased during the observations, until on the fourth day it was only $0\cdot75^{\circ}$.* Professor V. B. Lewes also states† that it is a well recognised fact that magnetic oxide of iron increases the corrosion of iron by its galvanic action, and has supplied experimental proof of this fact by taking two clean plates of mild steel, separating their surfaces by a sheet of blotting-paper moistened with sea water, and connecting them through a galvanometer, which then registered a deflection of 20° ; on covering the surface of one plate with ferrous oxide, the deflection was only slightly increased to 25° ; on coating one of the surfaces with hydrated ferric oxide a deflection of 65° was obtained, while rust gave a deflection of 110° , and magnetic oxide the maximum deflection of the whole series, namely, 112° , thus showing the great galvanic activity of this oxide. In spite, however, of such apparently conclusive evidence, D. Phillips, in his paper read before the Institute of Marine Engineers in 1890, adduces reasons for believing that the scale of black oxide acts as a preservative of the iron and steel immediately underneath, and asserts that though the iron plates employed by the Admiralty are often pickled to free them from scale, it is not unfrequently found that even then the steel wears irregularly. It is possible that, as the scale in Phillips' experiments was artificially prepared, it may have partaken more of the character of the Bower-Barff oxide, which has been shown by Tweedie to have the power of confining corrosion to any spot where the scale was broken, and to prevent the "lateral" rusting observed with ordinary surfaces.‡

Corrosion in the Presence of Diluted Acids.—The resistance offered by different varieties of iron and steel to the corroding effect of diluted acids depends greatly upon the nature and quantity of the elements which are associated with the iron. Thus Faraday observed that though 0·25 per cent. of platinum greatly increased the rapidity of the action of sulphuric acid on steel, the corrosion was less powerful with 1 per cent. of platinum, was feeble with 10 per cent., while with 50 per cent. of platinum the action was the same as with the original steel, and with 90 per cent. of platinum the alloy was unattacked by sulphuric acid.§

R. A. Hadfield|| has observed an opposite effect in the case of chrome steels. The samples to be tested were immersed in 50 per cent. sulphuric acid for twenty-one days, and the following percentage loss was obtained:—

		Loss per cent.
Chromium, per cent.,	. . . 1·18	3·32
" "	. . . 5·19	4·78
" "	. . . 9·18	5·62
Mild steel,	7·48
Wrought iron,	4·47

* *Trans. R. S. E.*, vol. xxxii., I., p. 215.

† *Inst. Journ.*, 1887, vol. i., p. 461.

‡ *Ibid.*, 1881., vol. i., p. 178.

§ *B. A. Report*, 1838, p. 265.

|| *Inst. Journ.*, 1892, vol. ii., p. 92.

From this it will be seen that though the addition of a little chromium diminished the loss due to corrosion, this loss became greater as the proportion of chromium increased.

Some experiments conducted by Professor Ledebur* with various kinds of iron showed that the resistance to the action of diluted sulphuric acid increased with the proportion of carbon. The acid used had a density of 1.05; the metal was employed in the form of cubes, and was allowed to remain at rest for sixty-five days. The percentage loss of weight in each case was as follows:—

Wrought iron,	88.60
English tool steel (untempered),	66.50
Refined charcoal pig,	37.70
Grey coke pig,	27.59
White pig,	19.70
Spiegel iron,	14.15

The experiments of T. Andrews on the passive state of iron and steel, which have been previously mentioned, also showed that iron containing much carbon was less readily attacked by nitric acid than pure iron. Numerous contradictory statements have been published as to the influence of different proportions of carbon, and carbon in different states of combination, on the corrosion of iron and steel in air and water, but on this subject more definite information is still desirable.

Dr. Percy states that hardened steel is much less readily acted upon by acids than the same steel when softened, and quotes an experiment by Daniell in support of this view.† Steel when magnetised is stated to be more readily corroded by acids than when unmagnetised. It has already been mentioned that the experiments of T. Andrews have shown that magnetism diminishes the passivity of steel in nitric acid, and the same investigator has observed that magnetised steel is more corroded in a solution of cupric chloride than similar steel unmagnetised, the average difference being about 3 per cent.‡

Removal of Rust.—On the large scale, rust is generally removed by scraping the surface with a suitable tool; and such treatment before the application of a protective coat greatly assists in the preservation of the iron. On the small scale, with articles which have to be cleansed from rust, soaking the object in a solution of potash, and carefully brushing when the rust was thus softened, give satisfactory results. Vosmaer suggests for this purpose the use of a solution of stannous chloride, which dissolves the rust, but does not attack the iron underneath.§

Action of Acids on Iron and Steel.—Iron in any form, whether wrought iron, cast iron, or steel, is readily dissolved by

* *Inst. Journ.*, 1878, vol. i., p. 15. † *Iron and Steel*, p. 857.

‡ *Pro. R. S.*, vol. lii., p. 114.

§ *Inst. Journ.*, 1887, vol. i., p. 463.

diluted mineral acids, such as hydrochloric, nitric, or sulphuric, with the formation of the corresponding ferrous salts. When sulphuric or hydrochloric acids are employed, hydrogen is evolved which unites with the combined carbon, and also with the sulphur, and phosphorus, to form volatile compounds which pass away with the hydrogen and impart to it a characteristic disagreeable odour. When white cast iron is thus dissolved the gases evolved have a disgusting smell, and in addition to gaseous hydrocarbons, heavy oils, belonging to the olefine series of hydrocarbons, and boiling at upwards of 200° C., are obtained.* An insoluble residue is also produced which contains the graphitic carbon, together with the silicon in an imperfectly oxidised condition, and any other insoluble substances—such as tungsten, titanium, chromium, &c., which may be present. The nature of this residue depends not only on the composition of the original metal but also on the strength and nature of the solvent employed. When grey cast iron is dissolved in hydrochloric acid, a bulky residue is left consisting of graphite and partially oxidised silicon; if this residue be dried and gently heated a change takes place whereby hydrogen is evolved, while the temperature of the mass is considerably raised.† When the solution of the iron takes place very slowly, as in the drainage water from mines, or in pipes which have been employed for conveying acetic acid, the cast iron retains its original form, and the graphitic residue, though extremely light, is yet compact and firm. Numerous instances are recorded in which cast-iron cannon or shot, which have been immersed in sea water for centuries, have retained their original shape, though the iron was almost completely dissolved, and the residue on coming into contact with the air oxidised so rapidly as to dry spontaneously with the evolution of considerable heat.‡ The details of a number of examples of this kind have been collected by Mallet,§ while Stodart and Faraday also obtained a quantity of residue, on dissolving steel in diluted hydrochloric or sulphuric acid, which was pyrophoric when heated to a temperature of about 200° C., and which on burning left a residue of oxide of iron.||

According to Grace-Calvert, this change in the composition of cast iron, without any corresponding alteration in its bulk or appearance, is most marked with acetic acid; hydrochloric and sulphuric acids follow in order, while phosphoric acid has no similar action.¶

White cast iron resists the action of acids better than other varieties, and on this account is employed for the vessels used in

* Percy, *Iron and Steel*, p. 144.

† Jordan and Turner, *Journ. Chem. Soc.*, vol. xlix., p. 219.

‡ Percy, p. 146.

§ *B. A. Report*, 1838, p. 259.

|| *Ibid.*, p. 264.

¶ Kohn, *Iron Manufacture*, p. 65.

the refining of gold and silver, and for many similar purposes; of other varieties of cast iron those which are coarse-grained and open in texture are generally more easily affected by acids. That cast iron rich in silicon was not attacked by hydrochloric acid was noticed by R. Mallet,* and this observation has been repeatedly confirmed by the author. When iron contains 10 per cent. of silicon and upwards, it resists the action of acids so well that it has been proposed to employ this kind of metal for the production of pipes, taps, and other articles in chemical works. When cast iron containing much phosphorus is dissolved in acids, the residue generally contains phosphorus in combination with iron in some form in which it is not attacked by ordinary solvents. When estimating phosphorus in such samples it is necessary either to heat the mass to redness, or to keep it at a temperature of at least 100° C. for over an hour, in order to fully oxidise the phosphorus compound. Cast iron rich in silicon, in a similar manner, often leaves silicide of iron in the residue; from this silicide amorphous silicon has been separated by Dr. Tilden.† The residue left on dissolving grey cast iron in either diluted sulphuric or hydrochloric acid contains sulphur, so that the evolution method for the estimation of sulphur is not applicable for the analysis of grey cast iron.

Though the ordinary forms of iron and steel are thus attacked by diluted acids, and by strong hydrochloric acid, they are not dissolved by either strong sulphuric acid or by strong nitric acid. In the case of strong sulphuric acid the result of the action is the production of anhydrous ferrous sulphate; and as this salt is not soluble in sulphuric acid, a coating is produced on the surface of the metal which prevents further action. When strong nitric acid acts on iron the metal is not dissolved, but assumes what is known as the "passive" state.

The recent investigations of T. Andrews have shown that the passivity of iron is greater as the concentration of the nitric acid increases, and that the passivity in nitric acid of 1.42 density is regularly diminished as the temperature rises, until at about 90° C., the point of transition from the passive to the active state is reached. The passive state appears to be connected with magnetic influence, for even with cold nitric acid of 1.42 density the effect of magnetism is capable of being detected by means of delicate instruments; while with warm nitric acid and powerful magnetism, the temperature of transition from the passive to the active state is very materially lowered. But even with powerful magnetism, and iron in a state of fine division, the passive state cannot be fully overcome until a temperature of 51° C. is reached. It was also observed that wrought iron was less passive than most

* *B. A. Report*, 1838, p. 277.

† *Birm. Phil. Soc.*, vol. iii., p. 203.

steels, and that low carbon steels were less passive than those which contained a higher percentage of carbon.*

Protection of Iron and Steel.—The methods which have been adopted for the protection of iron and steel from corrosion may be classified as follows:—

1. The use of *wood, masonry, or other solid materials* to prevent the access of air or water. Examples of this class are to be met with in the building in of iron in brickwork or masonry in the erection of buildings; in the use of cement, which, when of good quality, affords adequate protection; and in the lining of the pipes in mines with dry wood, which when wet swells so as to completely protect the iron.†

2. The use of an adherent coating of *magnetic oxide of iron*. It was shown by Brande and Faraday in 1861, during the course of some experiments on the superheating of steam in iron tubes, that the iron became covered with a closely adherent coating of magnetic oxide, and that this covering prevented the metal underneath from oxidation.‡ A method based upon this action was introduced by Barff in 1876. In this process the iron to be protected is first carefully cleaned and then heated to redness in a retort, through which is forced a current of superheated steam. When the operation is properly performed the magnetic oxide is uniformly adherent, and affords a very efficient protection; but if the original surface is covered with rust, or the temperature not properly regulated, the coating is apt to strip off.

G. Bower shortly afterwards obtained a similar result by the use of a limited supply of air; if too much air be employed at the comparatively low temperature necessary for this action ferric oxide is obtained, which is valueless for protective purposes. Bower's process was subsequently modified, so that the articles to be coated were first heated to redness by gaseous fuel introduced into the interior of the retort, and then maintained at a red heat in an oxidising atmosphere for about half an hour; the ferric oxide so produced was subsequently reduced to magnetic oxide by heating for about a quarter of an hour in the same retort, in an atmosphere of carbon monoxide. By a series of such oxidations and reductions, lasting altogether about four hours, a covering of the necessary thickness was obtained. The Barff process is stated to be more suitable for wrought iron, but is more expensive in fuel, as the retorts are heated externally, while a separate steam boiler and superheater are also required. In the Bower process it is not necessary to so completely free the surface of the original article from rust. The processes are now frequently combined, and both possess the advantage that even the most intricate forms can be as readily protected as plane sur-

* *Pro. Royal Soc.*, 1891, p. 486. *Inst. Journ.*, 1890, vol. ii., p. 848; 1891, vol. i., p. 426; 1892, vol. ii., p. 482.

† Mallet, *E. A. Report*, 1838, p. 276. ‡ *Inst. Journ.*, 1878, vol. i., p. 13.

aces. The temperature employed is about 1,000° F., while the time of heating varies from about five to twenty hours. Articles of very large size cannot be conveniently treated by these processes on account of the expense of the furnaces required.* A special quality of sheet iron, which has long been manufactured in Russia, owes its power of resisting oxidation to the presence of a coating of closely adhering magnetic oxide, which is produced during the process of manufacture (see p. 279). A. de Meritens has also proposed to protect iron from rusting by "bronzing" with magnetic oxide, produced by electrolysis under special conditions.†

In a process recently patented by Bertrand, the iron to be coated is first carefully cleansed by immersion in dilute sulphuric acid (5 per cent.), and preferably brushed. It is then rubbed with grain sand until quite clean, and immersed for four or five seconds in a bath, consisting of 200 grams of "acid tin salts," 600 grams of sulphate of copper, and 300 grams of sulphovinic acid in 100 litres of water. The work should then have a yellowish bronze colour; it is washed in water containing $\frac{1}{2}$ per cent. of oxalic acid, dried and heated in an oven, the atmosphere of which may be either oxidising or reducing. The time required varies somewhat according to the temperature employed; but about ten minutes is stated to give a firmly adherent coating of magnetic oxide, which is capable of resisting atmospheric influences very perfectly.

3. The application of *metallic coatings*—e.g., copper, nickel, tin, and zinc.

(a) *Copper* can be readily deposited upon the surface of clean iron in the form of a firm and uniform coating by the use of the electric current and an alkaline cyanide solution. This coating has a pleasing appearance, but it is relatively expensive; and if any of the protecting surface become worn away the copper and iron form an electric couple, of which the iron is the positive element, and thus oxidises more readily than when alone.

(b) *Nickel* is now largely applied for protecting the surface of iron, on account of its silver-like appearance and power of resisting oxidation. Nickel can be electro-deposited directly upon the cleansed surface of the iron from a neutral solution of nickel ammonium sulphate; but in order to prevent the deposit scaling off when in use, a coating of copper is frequently first obtained as above described, and the nickel is then deposited on the copper. Nickel, like copper, is electro-negative to iron, and thus promotes oxidation when the iron underneath is exposed.

(c) *Tin* is employed on a very extensive scale for the protection of iron. The tinplate industry of the United Kingdom alone consumes about 10,000 tons of tin per annum, valued at nearly £1,000,000 sterling. Tinplate is specially applicable for

* *Inst. Journ.*, 1881, vol. i., p. 166.

† *Ibid.*, 1887, vol. i., p. 40; 1889, vol. i., p. 355.

the production of vessels for holding articles of food, or for cooking utensils, as tin is not readily attacked by vegetable juices; it has also a good appearance, combined with lightness and durability. Sir H. Davy originally believed that tin would act electrically in such a manner as to protect iron from oxidation; but subsequent researches proved that though tin is at first positive, it becomes negative when the action has been allowed to proceed for a short time, and the iron underneath, when exposed to atmospheric influences, oxidises more rapidly on account of the presence of the coating of tin.*

(d) *Zinc* is even more largely used than either of the foregoing metals for the protection of iron, though its introduction is of later date than that of tin. As compared with tin zinc is cheaper, and quite as easily applied; the process of coating by immersion in the molten zinc, after first removing the scale by dipping in acid, is misnamed "galvanising." It is employed chiefly for the sheets for roofing, buckets, wire, and other articles which are subjected to atmospheric influences, and owing to its electro-positive character zinc affords very efficient protection. Zinc is, however, very readily attacked by even weak vegetable acids, and thus galvanised articles should not be used for cooking utensils, or for the storage of food. Galvanised iron is used on a considerable scale in the Colonies for the storage of water, and much discussion has arisen as to its suitability for this purpose. Some waters have little or no action upon zinc, while others containing acids, chlorides, or nitrates in solution rapidly dissolve it. On this account the use of galvanised tanks for the storage of drinking water has been abandoned in the principal navies.

In addition to the use of continuous coatings of metal various suggestions have been made since the experiments of Sir H. Davy,† of E. Davy,‡ and of R. Mallet,§ for the application of strips or pieces of zinc, or other positive metal as a protection, owing to its electrical action upon the iron in its immediate vicinity. None of these proposals have, however, proved very satisfactory when applied on the large scale for the protection of ships. Zinc only protects iron which is initially free from rust; but does not afford protection when the surface is already rusted; its protecting influence is also more marked in salt than in fresh water, on account of the coating of oxide which so often forms in the latter. Hannay has suggested the use of metallic zinc for protecting boilers by suspending a ball of the metal in the water of the boiler by wires, which are fixed in metallic contact to the sides of the boiler. It is claimed by W. Thomson (*Manchester Assoc. Eng.*, Nov., 1893) that this prevents "pitting," by diminishing the action of acids or of nitrates in the feed-water, while incrustation is also greatly reduced.

* *B. A. Report*, 1838, p. 289.

† *Phil. Trans.*, 1824.

‡ *B. A. Report*, 1835, p. 34.

§ *Ibid.*, 1840, p. 246.

Zinc dust, which was employed as a protecting paint by Mallet,* has recently been re-introduced and employed on a somewhat considerable scale for the protection of ships.

4. Coating with *tar* or *pitch* is one of the cheapest, simplest, and most efficacious methods of protecting ironwork, though the tar needs to be pretty frequently renewed. A patent asphalt varnish, which was introduced by Dr. A. Smith, has been extensively employed, especially for water-pipes; it consists essentially of tar, with the addition of a small proportion of boiled linseed oil.

According to Kohn † the usual method of coating cast-iron pipes is as follows:—A composition of tar, resin, and naphtha is prepared, in such proportions that it will remain liquid at 400° F. without vaporisation or decomposition. The pipes are taken cold and dipped in this mixture, in which they are allowed to remain about twenty minutes so as to gradually acquire the temperature of the bath. This method has been found preferable to heating the pipes before dipping, as a more uniformly adherent coating is produced by proceeding as above described. As tar is frequently rich in phenols, which behave like acids in assisting corrosion, it is better either to boil the tar before use with about 3 per cent. of lime, as is done in Germany, ‡ or to thicken it with chalk, as practised by J. Head. §

Methods which are in principle akin to the use of tar are also applied, as in the production of a carbonaceous varnish on Berlin castings, by exposure to a smoky flame after the application of a combustible liquid. ||

5. The use of *oils*, *paints*, and *varnishes*. Although, on account of the expense and trouble, such preparation is often omitted, it is better, as recommended by E. Matheson, ¶ to completely remove the scale by pickling or otherwise before applying oils or paint. V. B. Lewes has classified the protective compositions which are applied to the surface of iron and steel ships as follows:—

(a) *Red lead* is converted, by treatment with linseed oil, into a lead soap; this was formerly largely used, but now meets with little application. Its protective action is asserted to depend, at least in part, on the formation of a coating of magnetic oxide by the action of the red lead on the metal underneath.

(b) *Varnishes* made of good gum, which are efficacious but expensive, and deficient in body.

(c) *Varnishes* to which *body* has been given by means of some foreign substance such as oxide of iron. These are now most largely employed, and appear likely to occupy a leading position in future. ** Finely ground ferric oxide is generally added to give

* *B. A. Report*, 1840, p. 241.

† *Inst. Journ.*, 1892, vol. ii., p. 480.

‡ *B. A. Report*, 1840, p. 245.

** *Inst. Journ.*, 1887, vol. i., p. 462.

† *Iron Manufacture*, p. 61.

§ *Ibid.*, 1881, vol. i., p. 177.

¶ *Inst. C. E.*, vol. lxx., p. 114.

body and the desired shade of colour; titanitic iron ore has also been successfully employed for this purpose on a number of important structures, particularly for grey or neutral tints.

For smaller articles in iron and steel Sohler & Bürger have patented the use of a mixture of 5.5 parts of chemically pure bleached bees-wax and 1 part of wool grease, dissolved in oil of turpentine, and spread in a thin layer; this is stated as the result of years of experience to have given excellent protection from the effects of air and moisture (Eng. Pat., 13,702, 1893). The author has found a mixture of 1 part of white hard varnish with about ten times its volume of turpentine, when applied to the clean and warmed surface of iron and steel, afford a cheap and efficient protection to samples, such as test bars, &c., which are required to be kept for purposes of reference.

6. *Enamels.*—The process of enamelling has in recent years come into extensive use for the protection of sheet iron, and for culinary utensils. The metal to be enamelled is first carefully cleaned from scale, and the mixture for producing the enamel is applied in the form of a wash; the articles are then dried in a hot room and heated in a muffle furnace to a temperature of about 700° C., to fuse the enamel. Usually more than one coating of enamel is applied, the desired colour being imparted with the last wash. Very mild steel, or wrought iron, is more easily enamelled than harder varieties, while a close-grained clean running grey iron is preferred for castings which have to be enamelled. One of the troubles met with in this industry is the occasional production of spots on the surface of the enamel, owing to imperfect union of the enamel with the iron. The cause of these imperfections is not well understood, though any dirt might be expected to contribute to the result; and it appears to be connected not unfrequently with the composition of the metal employed, as the trouble disappears on changing the mixture used in the foundry. For common purposes the glaze is produced by the use of lead compounds, but on account of the poisonous character of such materials, culinary articles should be glazed with enamels which are free from lead; and in the leading establishments in the trade lead is not allowed to be used in any form for best work.

The following mixture, recommended by Raetz, will serve to illustrate the materials employed for enamelling:—30 parts of powdered felspar and 25 of borax are fused together, and the powdered mass is mixed with 10 parts of kaolin, 6 of felspar, and 1.75 of magnesium carbonate; this is mixed with water to a paste, which is spread over the iron, and upon this is applied a fusible powder, made by fusing 37.5 of quartz, 27.5 of borax, 50 of stannic oxide, 15 of carbonate of soda, and 10 of nitre. The object thus treated is carefully dried and fired in a muffle furnace.*

*Thorpe, *Dict.*, vol. ii., p. 9.

7. *Japans.*—Japanning may be regarded as occupying an intermediate position between varnishing and enamelling; it is largely applied for the production of a cheap protective coating in the sheet iron, bedstead, and allied trades. The clean iron surface is covered with a special variety of varnish, and is afterwards baked in an oven so as to render the coating smooth, hard, and closely adherent. For most purposes a black japan is employed, but for numerous ornamental applications various coloured japans are also prepared. The carbonaceous vapours given off during japanning are readily inflammable, and fires originating from the overheating of the japanning oven are not uncommon.

INDEX.

- Abel, Sir F., sulphur in cast iron, 200.
- Acids, action on iron and steel, 336, 343.
- Adams' process, 258.
- Adamson, D., uses steel boiler plates, 41.
- Addie, ammonia recovery process, 155.
- Addie, J., on sulphury iron, 202.
- Admiralty committee on corrosion, 338.
- Ainslies' Ulverston furnaces, 161.
- Air, effect of excess in blast furnace, 169.
- Air furnace, 221.
- Akerman, Prof., on fusion of slag, 184.
- Alabama blast furnaces, 93; ores, 55; pig iron from, 213.
- Albizzia, Amara, 250.
- Alexander and M'Cosh process, 154.
- Alger's elliptical furnace, 93.
- Alkalies in blast furnace, 98, 141; removal of sulphur by, 201.
- Allevard, treatment of ores at, 84.
- Alligator, 316.
- All Mine pig iron, 203, 212.
- Alloys of iron, corrosion of, 339.
- Alumina in slags, 183.
- Aluminium in cast iron, 198; in puddling, 305.
- Aluminous ore, use of, 184.
- American blast furnaces, development of, 32; blast furnace, section of, 90, 93; bloomery, 246; coke, analyses of, 158; furnace practice, 105; pig iron, grading of, 213; twyer, 131.
- Ammonia from furnace gases, 154.
- Amnsden, F. F., calculations of slags, 182.
- Analyses of American coke, 158; of best tap, 287; of blast-furnace slag, 178; of ferro-chromes, 207; of gases in blast-furnace hearth, 135; of Indian iron, 251; of Indian magnetite, 249; of Indian slag, 252; of iron during puddling, 294; of iron during refining, 274; of iron ores, 55, 60, 63, 67; of limestone, 185; of pig iron, 212; of pig iron for puddling, 288, 302; of refined iron and cinder, 273; of remelted cast iron, 224, 225; of rust, 334; of special irons, 214; of splint coal, 159; of strong cast iron, 238; of Styrian ore, 108; of Styrian white cast iron, 109; of tap cinder, 297; of titanic pig iron, 209; of titanium nitride, 208; of Yorkshire iron, 279; of waste gases, 153; of wrought iron, 327.
- Anderson's puddling furnace, 284.
- Andrews, T., corrosion of wrought iron and steel, 339, 340, 341; on the passive state, 343, 345.
- Angle of bosh, 94.
- Annealing malleable cast iron, 242; sheet iron, 280.
- Anthracite, 159; use of, with hot blast, 22.
- Anvil block, 316.
- Apatite in iron ores, 66.
- Araya, puddling at, 307.
- Armstrong and Jones' patent, 105.
- Armstrong's, Lord, hydraulic lift, 99.
- Arsenic in cast iron, 210.
- Assyria, bronze and iron in, 2.
- Attwood, melts steel in Siemens furnace, 44.
- Aubertot, M., use of blast furnace gases, 26.
- Australia, ores of, 68.
- Austrian open hearths, 267.
- Automatic pyrometer, 127.
- Avicula seams in Cleveland ironstone, 59.

- Bagley, J. G., 107.
 Baird, pistol pipe stove, 118.
 Baldwin, M., circular stove, 118.
 Ball and Wingham on desulphurisation, 201.
 Balling up, 291, 301.
 Balling's method, 180.
 Ball's process, 346.
 Bar mill, French, in 1760, 14.
 Barnby, Sir N., scale and corrosion, 311.
 Barrow, furnaces at, 28.
 Barrow haematite mines, 70.
 Barrows, A. E., on best Staffordshire iron, 292; slag in wrought iron, 326.
 Bars, puddled, 315.
 Basic process, 45.
 Basic slag bottoms, 326.
 Bauernan, H., on puddling, 303; volume of rust, 335.
 Bauxite used as flux, 184.
 Baxter House, Bessemer's experiments at, 37.
 Beam engine, 110.
 Beckton, J. G., 107.
 Behrens and Van Linge on ferrochromium, 207.
 Belfast ore, 184.
 Bell, C., on irregular filling, 169.
 Bell, effect of diameter of, 145.
 Bell, Sir L., advantages of coal and coke, 160; analyses of Yorkshire iron, 279; calculation of fuel used in blast furnace, 164; carbon and oxygen in blast furnace, 139; on corrosion, 338; on descent of charge, 145; on direct reduction, 259; duty of fuel, 166; on furnace coke, 158; on fusion of slag, 184; geology of iron ores, 63; on hot blast, 114; hydrogen in blast furnace, 140; on moisture in blast, 132; on phosphorus in iron ores, 65; on rate of carbon deposition, 138; ratio of CO to CO₂, 164; on separation of phosphorus, 47; slag without lime, 178; temperature of reduction, 144; use of lime in blast furnace, 187; utilising heat of slag, 176; "washing" process, 46; on waste gases, 153; on "waste of heat, &c.," 174; on working Lake Superior ores, 71.
 Bellows, early forms of, 13; leather, 110.
 Bergman on carbon in steel, 35.
 Berlin castings, 340.
 Berthelot on carbonyl, 137.
 Bertrand, protection of iron, 347.
 Bessemer, Sir H., 35; on corrosion, 339; difficulties of, 38; mixture for castings, 221; success of, 39.
 Bessemer process, history of, 35.
 Bessemer steel used for ships, boilers, and rails, 41.
 Bessemer vessel, early form of, 36.
 Best best iron, 328.
 Best tap, 287.
 Best Yorkshire iron, 278.
 Bilbao, iron ores of, 66.
 Bituminous coal, 159.
 Black-band ironstone, 59.
 Black-band ores, roasting of, 80.
 Black-band, smelting with hot blast, 21.
 Blackwell, S. H., and Northampton ore, 27; on use of waste gases, 27.
 Blaenavon, basic process at, 47.
 Blair-Adams process, 258.
 Blair process, 257.
 Blast engine, 106, 110; beam, 110; vertical, 111.
 Blast furnace, American development, 32; arrangement of works, 85; ascending current, 136; at Dowlais, 95; at Eston, 95; at Lowmoor, 95; barrows, 100; boshes, 94; capacity of, 29, 94; charcoal for use in, 161; charcoal reduction in, 142; close top of, 27, 100; coal, use of, 158; combustion in hearth, 134; cyanides in, 141; descent of charge, 144, 145; details of American, 91; details of Cleveland, 89; details of construction, 95; dust, analysis of, 104; dust, 102; duty of fuel, 166; effect of working conditions, 169; excess of air, 169; fuel consumption, 163; fuel used, 157; gases, utilisation of, 26; hearths, 96; height of, 29, 94; hydrogen in, 139; improved shape of, 22; increased capacity of, 29; increased production in America, 33; introduction of, 7; lifts, 86, 88, 93, 99; linings, 98; low fuel consumption in, 167; materials used, 133; plan of American, 88; plan of Cleveland, 86; plant in Alabama, 93; practice, English and American, 105; practice in Styria, 108; practice in 1686 and in 1825, 10, 16; production in 1825, 17; production of, 91; reactions of, 133; scaffolds, 147; section of Cleveland, 89; section of Edgar Thom-

- son, 90; selection of site, 85; shape of, 93; slag, analyses of, 177; slags, 175; small Indian, 249; speed and economy, 33, 170; Staffordshire in 1686 and in 1854, 10, 24; subsidiary improvements in, 30; tall, for wrought iron, 252; tar and ammonia from gases, 154; temperatures of, 143; thermochemical calculation of fuel, 164; Turner's patent, 162; use of gaseous fuel, 162; use of lime in, 186.
- Blast, moisture in, 132.
 Blast pressure, 106.
 Blazed iron, 105, 197.
 Bliss, F. J., early copper tools, 3; furnace at Tel-el-Hesy, 20.
 Blisters in wrought iron, 330.
 Bloomery, American, 246.
 Bloomfield Iron Works, 24.
 Blowing cylinders, introduction of, 12.
 Blowing engines, 112.
 Blowing in and out, 105.
 Blue billy, 286.
 Böcker on Cowper stoves, 120.
 Boëtius producer, 307.
 Bog ores, 57; formation of, 62; smelting of, 248.
 Boilers, Bessemer steel, 41.
 Boiling cinder, 297, 298.
 Boil, the, in puddling, 291.
 Bolekow and Vaughan open up Cleveland, 27.
 Boshes of blast furnace, 94.
 Bottom of mill furnace, 325.
 Bottom-plate, wear of, 289.
 Boucau, ferro-chromes, 207.
 Bower-Barff process, 346.
 Bowling iron works, 278.
 Brabant, F., on distribution of charge, 145.
 Brande and Faraday, magnetic oxide, 346.
 Brandis, Sir Deitrich, on Indian iron making, 253.
 Braune, rolling of steel, 330.
 Brick, honeycomb, 120; slag, 178.
 Bridgenorth, iron trade of, 17.
 Brine, evaporated by hot slag, 176.
 Briquettes, from fine ore, 73.
 Britain, early iron making in, 5.
 British Association, Bessemer's paper at, 38.
 British Museum, iron and bronze in, 2.
 Bromford, refined iron at, 273; refinery at, 272.
 Bronze Age, 1.
- Bronzes, early, 2.
 Brough, B. H., on use of magnetic needle, 71.
 Brown coal, 160.
 Brown, Crum, formation of rust, 335.
 Brown hæmatite, calcination of, 80.
 Budd, J. P., patent for use of waste gases, 26; use of waste gases, 154.
 Bull-dog, 275, 286.
 Bunsen and Playfair, on cyanides, 141.
 Burden, 133.
- Calcination**, effect on magnetic properties of ores, 75; of iron ores, 78.
 Calcining kilns, 81; introduced, 30; Davis-Colby, 83; Taylor-Langdon, 84.
 Calcining iron ores in kilns, 80.
 Calcium phosphate in ores, 65;
 Calculation of furnace charges, 180.
 Callendar, H. L., on platinum pyrometers, 126.
 Calorific, efficiency of puddling furnace, 307.
 Calvert & Johnson on puddling, 293.
 Calvert, Prof., analyses by, 224.
 Canada, ores of, 53, 54, 68.
 Capacity of blast furnace, 29, 94.
 Carbide of chromium, 207; of silicon, 198; of titanium, 210.
 Carbides in cast iron, 190.
 Carbolates from furnace tars, 156.
 Carbonate ores, 57, 58.
 Carbon in cast iron, 189; in foundry iron, 191; linings for furnace hearths, 98; reduction by solid, 171.
 Carbon dioxide, proportion of, in charcoal furnaces, 171.
 Carbon monoxide, decomposition of, 98, 136, 137, 139, 140; dissociation of, 113, 138; reactions of, 137.
 Carbon silicide, 198; sub-oxide of, 138; transfer, C. Cochrane, on, 168.
 Cardiff, Roman forges at, 5.
 Carinthia, early iron making, 4.
 Carnelly, Dr., on melting points, 125.
 Carpenter, S. M., steel scrap for foundry mixtures, 220.
 Carron, blowing cylinders at, 12; iron works, gases at, 154.
 Castings, advantages of iron, 216.
 Cast iron, action of acids on, 343, 344; aluminium in, 198; arsenic in, 210; carbon in, 189; changes during the remelting of, 224;

- chromium in, 205; condition of silicon, 197; crushing strength, 194, 234; deflection of, 196; density of, 195; depth of chill, 240; effect of size and shape, 229; fluidity of, 240; grain of fracture, 240; hardness, 195, 232, 241; introduction of, 6, 7; malleable, 241; manganese in, 204; modulus of elasticity, 194; phosphorus in, 202; properties of, 189, 216; shrinkage of, 230, 240; silicon in, 192; Styrian, 107; Styrian, analyses of, 109; sulphur in, 200; tensile strength, 194, 234, 236; titanium in, 208; toughened, 218; transverse strength, 194, 217, 235; vanadium in, 207.
- Catalan process, 245.
- Causes of loss in puddling, 301.
- Causes of rust, 335.
- Central tube for blast furnaces, 101.
- Chumplain, Lake, ores of, 64.
- Chance, Messrs., patent for slag, 179.
- Charcoal, 161; growing scarcity of, 8; preparation of, 161; use of, in blast furnace, 161.
- Charcoal blast furnace, last in Sussex, 17.
- Charcoal furnaces, capacity of, 94; consumption of fuel, 170; in Great Britain, 161; reduction in, 142.
- Charcoal iron, best, 269, 272; shrinkage of, 232.
- Chatelier, H. le, temperature of blast furnace, 144.
- Chenot on magnetic concentration, 73.
- Chenot process, 256.
- Chilled rolls, 321; production of, 228.
- Chill in cast iron, measurement of, 240.
- Chilling cast iron, 190.
- Chills, 226.
- Chrome iron ore (chromite), 53; reduction of, 206.
- Chrome ore used for fettling, 302.
- Chrome steel, corrosion of, 342.
- Chromium in cast iron, 205; oxidation of, 206.
- Cinder, blast furnace, analyses of, 177; deficiency of, 277, 302; saturated, 300; tap, varieties of, 297.
- Cinder notch, 97.
- Cinder pig, 149; manganese and sulphur in, 188; production of, 188.
- Clare, T. D., ilmenite paint, 53; on Mushet's patents, 39.
- Clarence furnace and Edgar Thomson compared, 167.
- Clarence Works, evaporating brine at, 176.
- Classification of ores, 50.
- Clay, W. N., direct process, 260.
- Clearing in puddling, 275, 291.
- Cleveland blast furnace, plan of, 86; section of, 89.
- Cleveland calciner, 81; grading of pig iron, 211; increased capacity of furnaces, 29; ironstone, 58; limestone, 185; opening of district, 27; pig iron, analyses of, 212; slag, 176; utilisation of slag, 180.
- Clinton formation, unity of, 55, 64.
- Closed blast-furnace hearths, 97.
- Close top of blast furnace, 27, 100.
- Clough's mechanical puddler, 311.
- Clyde Works, stoves at, 116.
- Coal, bituminous, 159; used in blast furnaces, 158.
- Coating iron and steel, 346.
- Cochrane, C., 107, 113; on carbon transfer, 168; on use of lime in blast furnace, 186, 188.
- Coke, analyses of American, 158; blast furnace, 157; consumption of, in blast furnace, 91; good, properties of, 157; soft, 157; use of, by Darby, 10; use of, by Dud Dudley, 9.
- Cold blast furnaces, Yorkshire, 278.
- Collection of waste gases, 100.
- Collyer, Dr., on phosphorus in Bessemer process, 38.
- Colonies, iron ores of, 68.
- Combined carbon in cast iron, 190, 191.
- Combustion in hearth of blast furnace, 134.
- Composition of iron ores, 59.
- Concentration of iron ores, 72.
- Condie introduces water twyers, 128.
- Constitution of tap cinder, 299.
- Consumption of fuel in charcoal furnaces, 170.
- Contraction of cast iron, 230; of wrought iron, 331.
- Conversion of malleable cast iron, 242.
- Cook, E. S., unreduced ore, 134.
- Cooling, effect of rate of, 190.
- Coppee coke oven, 157.
- Copper assists corrosion of iron, 336, 347.
- Copper deposited, 347.

- Cornwall Banks ore, calcination of, 79, 82.
 Cornwall Banks, ores at, 70.
 Corrosion, 334; from electric currents, 337; effect of scale, 341; relative, of iron and steel, 338.
 Cort, H., introduces puddling, 271; inventor of puddling, 15; patents grooved rolls, 1783, 15.
 Cost of Cleveland furnaces, 87; magnetic concentration, 75.
 Cowper, E., hot-blast stove, 30, 118; unreduced ore, 134.
 Cowper stove, bricks for, 119.
 Cowper stoves at blast furnace, 87, 91.
 Crace-Calvert, analyses of rust, 334; on rusting, 335, 344.
 Crocodile, 316.
 Crop ends, 325.
 Crucible furnace, 221.
 Crucible steel, invention of, 11.
 Crushing strength of cast iron, 194, 234.
 Cubillo, Major, efficiency of puddling furnace, 307.
 Cumberland central tube arrangement, 102; hæmatite, 55, 70; ore suited for Bessemer steel, 39.
 Cup and cone, 100.
 Cupolas, 222.
 Current, gaseous in blast furnace, 136.
 Cyanides in the blast furnace, 141.
 Cyano-nitride of titanium, 208, 210.
- Dachel**, 266.
 Dam-plate, 97.
 Daniell, corrosion of steel, 343.
 Dank's furnace, 311.
 Dannemora, iron ore of, 52; ore concentrated at, 74; production of iron at, 268.
 Davis-Colby kiln, 83.
 Davis, G., iron furnace in Mashonaland, 251.
 Davy, E. A., corrosion in sea water, 336, 348.
 Davy, Sir H., on hardening steel, 35; protecting iron with zinc, 348.
 Decomposition of carbon monoxide, 98, 136, 137, 139, 140; of limestone, 140.
 Deficiency of cinder, effect of, 277, 302.
 Deflection of cast iron, 196.
 Delhi, iron pillar of, 4.
 Dempster process, 155.
- Denny, W., on corrosion of iron and steel, 340.
 Density of cast iron, 195; of coke, 158.
 Descending current in blast furnace, 140.
 Descent of charge, 144.
 Desfosses on cyanides, 141.
 Desulphurisation of cast iron, 151, 188, 201.
 Details of blast furnace, 89, 91, 95; puddling furnace, 284.
 Direct process, advantages of, 253; reactions of, 247; Siemens', 44.
 Direct production of wrought iron, 244.
 Disposal of slag, 175.
 Dissociation of carbon monoxide, 113, 138.
 Distribution of silicon in pig iron, 198; of sulphur in cast iron, 202.
 Dolomite, 185.
 Double puddling furnaces, 285.
 Dougal, Mrs., analyses of Scottish iron, 8.
 Dowlais blast engine, 112; blast furnace at, 95; composition of slag at, 177; machine for handling pig iron, 104; pyrometer at, 126.
 Down-comer, 90, 93, 103.
 Dredging iron ores, 70.
 Driving, rapid furnace, 32, 106.
 Dry bottom, 325; puddling, 271; sand moulds, 226.
 Ductility of wrought iron, 330.
 Dud Dudley, uses coke in blast furnace, 9.
 Dufrenoy, on saving by hot blast, 22.
 Dust catchers, 102; in furnace gases, 102, 104, 121.
 Duty of fuel used in blast furnace, 166.
- Eames'** direct process, 261.
 Earthy Cumberland hæmatite, 55.
 Eastwood's rabble, 311.
 Ebbw Vale, use of waste gases at, 27.
 Ebelmen, blast furnace reactions, 139, 142; temperature of waste gases, 143.
 Economy and speed in the blast furnace, 33, 170.
 Edgar Thomson and Clarence furnaces compared, 167.
 Edgar Thomson furnaces, 32, 90; model of, 145.
 Edgar Thomson works, treatment of slag at, 179.

- Edward II., iron scarce in reign of, 6.
- Edwards, R., on puddling furnace, 284.
- Effect of scale on corrosion, 341.
- Eggertz test, 191.
- Eglinton pig iron, remelting of 224.
- Egypt, bronze and iron in, 2.
- Eisenerz, 107.
- Electricity and underground corrosion, 337.
- Electro-motive force of iron and steel, 340.
- Elliptical blast furnaces, 93.
- Elongation of wrought iron, 331.
- Enamelling, 350.
- Enamels, 350.
- Engine, blast, 106, 110.
- Erzberg, early working of, 4; formation of, 62; ores of, 107.
- Eaton blast furnace, 95.
- Exploring for iron ores, 71.
- Extraction of iron ores, 70.
- Fairbairn, Sir W.**, on remelting cast iron, 224.
- Faraday and Brande, magnetic oxide, 346.
- Faraday, M., corrosion of steel alloys, 339, 342, 344; researches on steel, 35.
- Farnham, I. H., electricity and corrosion, 337.
- Farquharson, J., electric action in corrosion, 340, 341.
- Faur, Faber du, hot-blast stove, 118.
- Ferric oxide, artificial, 54.
- Ferric oxide decomposed by heat, 206; fuel for reduction of, 163; hydrated, 56; theory, 206.
- Ferris's blast furnace, 160.
- Ferro-aluminium, 199.
- Ferro-carbonyl 137.
- Ferro-chrome, 206; analyses of, 207.
- Ferro-manganese, 150, 204, 215.
- Ferro-silicon, 149, 192, 214; melted with scrap, 220.
- Ferrous oxide, 50; and corrosion, 342; in slag, 182.
- Ferrous silicate, 273, 285, 296, 299.
- Ferry Hill, blast furnace at, 94.
- Fettling, 285; consumption of, 203.
- Fibrous texture of wrought iron, 331.
- Finely-divided ores, treatment of, 76.
- Fine ore, smelting of, 76.
- Finery, 264, 269.
- Finished iron, imperfections of 329; sections of, 329.
- Finishing rolls, 324.
- Finland, iron furnace used in, 248.
- Fire-brick stoves, 30.
- Fire bridge of puddling furnace, 282.
- Flossengarbe, 266.
- Floten, W. van, on combustion in hearth, 134; on scaffolds, 148.
- Fluid bottom, 325.
- Fluidity of cast iron, measurement of, 240.
- Fluid oxide in puddling, 295, 303.
- Flux, calculation of, 182; in puddling, 285.
- Fluxes and slags in smelting, 175.
- Ford and Moncur stove, 124.
- Forehearth, 97.
- Forest of Dean, early ironmaking, 5; ores of, 56.
- Forge, arrangement of, 231; hammers, 316; machinery, 316.
- Formation of iron ores, 61; of slags, 140.
- Formzacken, 265.
- Forquignon on malleable cast iron, 243.
- Forth Bridge, 45.
- Foundry iron, carbon in, 191.
- Foundry mixtures, 217, 221.
- Foundry practice, 216; influence of phosphorus, 203; silicon in, 195.
- Franche-Comté process, 268.
- Francis, C., malleable cast iron, 243.
- Franklinite, 52.
- Frew's pyrometer, 125.
- Friedmann, A., blisters in wrought iron, 330.
- Frischen processes, 264.
- Frisch-oven, 264.
- Fryer, W. H., on moisture in blast, 132.
- Fuel consumption, high, in American furnaces, 33; in blast furnace, 163; in charcoal furnaces, 170; in puddling, 306; reduced in American furnaces, 33; theoretical minimum, 172.
- Fuel, duty of, in blast furnace, 166; low consumption of, in blast furnace, 167; used in blast furnace, 157; used in Indian blast furnace, 249.
- Funnels in furnace hearth, 148.
- Furnace charges, calculation of, 180.
- Furnace hearths, 23, 96; closed, 97.
- Fusible fettling, 285.
- Gag**, 316.
- Galvanic action of iron and steel, 339.
- Galvanising, 348.
- Gangue, 49.

- Garnier, on carbonyl, 137.
 Garrison, J. L., on Husgafvel process, 254; on Russian sheet iron, 280.
 Gartsherrie, treatment of gases at, 154, 156.
 Gas calciners, 79, 82.
 Gaseous fuel, for puddling, 306; used for calcining ores, 82; use of, in blast furnace, 162.
 Gases, analyses of, in hearth, 135.
 Gas fired stoves, 30, 118.
 Gautier, F., use of siliceous iron 196; use of steel scrap, 220.
 Gayley, J., American furnace practice, 106; on blowing in a furnace, 105; fine ores in America, 77; patent for carbon linings, 99.
 Geology of hæmatite ores, 55.
 German metallurgy in middle ages, 6.
 Germany, basic process in, 47; development of iron trade, 34.
 Gibbons, B., cinder pig, 149.
 Gibbons, J., improves shape of blast furnace, 23.
 Gidlow's furnace, 313.
 Gilchrist, P. C., inventor of basic process, 46; ores of colonies, 68.
 Gill, W., on iron ores of Bilbao, 66.
 Gjers, John, 107; calciner, 81; on capacity of blast furnaces, 29.
 Gladstone, Dr., analyses of ancient tools, 3.
 Glazed iron, 105, 197.
 Gleiwitz, remelting at, 225.
 Gloucester, early iron trade, 5.
 Goëthite, 56.
 Gordon-Cowper-Whitwell stove, 124.
 Gordon, F. W., excessive fuel consumption, 169.
 Gouvy, M. A., varieties of cupola, 223.
 "Grade" of iron, 181.
 Grading of pig iron, 211.
 Grain rolls, 321.
 Granulation of slag, 176.
 Graphite, separation of, 191.
 Great Exhibition building, 23.
 Gredt, P., on alumina in slags, 183.
 Greece, iron in, 4.
 Green sand moulds, 226.
 Greiner and Erpf cupola, 222.
 Grey cast iron, action of acids on, 344.
 Grooved rolls, 321.
 Grüner, rate of descent of charge, 134; on rusting, 336.
 Guide rolls, 15, 323.
 Hæmatite, brown, 56; mining, 70; pig iron, analyses of, 212; red, 54.
 Hadfield, R. A., corrosion of chrome steel, 342; on ferro-chromes, 207; history of crucible steel, 12.
 Hahn, graphitic silicon, 197.
 Hall, J., directions for puddling, 275; introduces pig boiling, 25, 274.
 Hall, Marshall, on corrosion, 335.
 Hamelius, M., cupola, 222.
 Hammer slag used as flux, 275, 285; use of, in puddling, 275.
 Hammers, steam, 317; used before rolls, 14.
 Hanbury, Major, introduces rolls, 14.
 Handling pig iron, 104.
 Hannay, protecting boilers, 348.
 Harbord and Hutchinson, patent, 76.
 Harbord and Tucker, patent, 326.
 Hardened steel, corrosion of, 343.
 Hardness of cast iron, 195, 232, 233, 241.
 Hardness tests, 241.
 Harris, H., analyses of Indian iron, 251; analysis of Indian magnetite, 249; analysis of Indian slag, 252; experiments on iron ores, 75.
 Hautmont, Chenot process at, 257.
 Hawdon and Howson's form of blast furnace, 93.
 Hawdon, W., English and American practice, 105; on gas for Cowper stove, 121; on slag, 179; on waste gases, 153.
 Hay, Sir G., iron works at Loch Maree, 8.
 Head, Jer., on Cleveland slag, 180; protecting iron, 349; on Scandinavian ores, 52.
 Head, John, on puddling furnace, 309.
 Hearth of blast furnace, square, 23.
 Hearths, double, 267; for direct production of wrought iron, 245; for indirect production of wrought iron, 264.
 Heath, J. M., history of, 25.
 Heath, R., & Son, ammonia recovery, 155.
 Heating the blast, 114.
 Heaton's process, 46.
 Height of blast furnace, 29, 94.
 Helves, 315; advantages of, 319.
 Hempel, W., on cyanides, 141.
 Henderson, ammonia recovery process, 155.
 Hertzberg cupola, 223.

- Heycock and Neville on pyrometers, 126.
- Hilgenstock on sulphur and silicon, 151.
- Hodgkinson, crushing tests of cast iron, 231.
- Hoerde, furnace hearth at, 97.
- Hoffman, G. C., on meteoric iron, 69.
- Hogge, Ralph, produced cast-iron cannon, 7.
- Hogg, T. W., cyano nitride of titanium, 210.
- Hoists, 99.
- Holgate, T. E., on manganese and sulphur, 152; on silicon pig, 150; on special irons, 214.
- Holland, T. H., on Indian iron working, 249, 253.
- Hollow fire, 270.
- Homfray, S., introduces refinery, 16.
- Honeycomb brick, 120.
- Hot blast, advantages of, 113; invention of, 20; saving of fuel by, 20; theory of, 112; use of anthracite, 22.
- Hot-blast stoves, 115; at Clyde Works, 116; circular, 117; cleaning, 121; Cowper, 118; Ford and Moneur, 124; Gordon-Cowper-Whitwell, 123; long, 117; Mas-sick and Crookes, 124; original form, 21; pistol pipe, 118; Whitwell, 122.
- Hot-blast valves, 121.
- Hot *a.* cold blast iron, 218.
- Howe, H. M., on American bloomery, 247; on corrosion, 335; on direct production, 254.
- Huddleston, W. H., ores of United Kingdom, 65.
- Hudson, W. J., 169; on Cowper stove, 120; on use of waste gases, 27.
- Hungry iron, 288.
- Hunt, A. E., on Fames' process, 261; tests for wrought iron, 333.
- Hunt, T. Sterry, geology of American ores, 65.
- Huntsman, invention of crucible steel, 11.
- Husgafvel process, 254.
- Hutchinson and Harbord patent, 76.
- Hydrated oxides, 56.
- Hydraulic lift, 99.
- Hydrochloric acid, action on iron, 191, 343.
- Hydrogen in the blast furnace, 139.
- Ilmenite**, 53.
- Ilsele, blast furnace output at, 34.
- Importation of iron ore, 31.
- Impregnation, carbon, 98, 136, 144.
- Inclined plane, 99.
- India, iron in, 4; magnetic ores of, 51; small blast furnaces in, 249.
- Infusible fettling, 286.
- Ireland, bog ores of, 57.
- Ireland, J., on Blair's process, 258.
- Ireland's cupola, 222.
- Iron and Steel Institute, puddling commission, 313.
- Ironbridge, bridge at, 16.
- Iron, corrosion of, 334-345; early and modern history of, 1-34; in Britain, 5; in Egypt and Assyria, 2; in prehistoric times, 1; in Scotland, 8. See also *Cast Iron, Finished Iron, Meteoric Iron, Native Iron, Pig Iron, Plate Iron, Puddled Iron, Sheet Iron, Wrought Iron, &c.*
- Iron ore, what constitutes workable, 49.
- Iron ores, analysis of, 108; calcination of, 78; carbonates, 57; classification of, 50; extraction of, 70; formation of, 61; geology of, 63; preparation of, 70; unsuitable for weathering, 77.
- Iron pyrites removed by roasting and by weathering, 77.
- Ironstone, 58.
- Jacobsson**, C. A., on Austrian open hearths, 267.
- Jamieson, M. J., composition of rust, 334; varieties of rust, 337.
- Japanning, 351.
- Japans, 351.
- Jeaus, J. S., on mechanical puddling, 310.
- Jenkins, H. C., on furnace charges, 181.
- Jerking a furnace, 147.
- John, W., protection from corrosion, 339, 341.
- Jones, C., ores magnetised at red heat, 75.
- Jones' furnace, 313.
- Jones, W., on waste gases, 155.
- Jordan, A. E., condition of silicon, 197.
- Jünger, on remelting in cupola, 225; on siliceous iron, 196.
- Jung, T., on carbon linings, 98.
- Keep's tests**, 195.
- Keep, W. J., on Alabama ores, 55; aluminium in cast iron, 199; ferro-silicon and economy, 196; hard-

- ness of cast iron, 233; manganese in cast iron, 205; phosphorus in cast iron, 203; shrinkage of cast iron, 232; sulphur in cast iron, 200; tests for foundry iron, 239.
- Kendall, J. D., on Spanish ores, 66.
- Kennedy, Prof. A. B. W., crushing tests for cast iron, 234; tests of cast iron, 192.
- Kent, early iron trade, 6.
- Ketley, T. Oakes' experiments at, 169.
- Khasi Hills, ore washing in, 72.
- Kidney ore, 55.
- Kilns, calcining, 30; advantages of, 80.
- Kirk, H., iron for puddling, 288; on puddling, 284.
- Kish, 190.
- Kjellberg, N., on phosphorus in cast iron, 203; reduction of phosphorus, 149.
- Koenig and Pforten, composition of ilmenite, 53.
- Kohu on moulding sand, 229; protecting iron pipes, 349.
- Korb, F., on Styrian iron, 109; on Styrian open hearth, 264.
- Lake Superior**, iron ores of, 51, 55.
- Lancashire hearth, 268.
- Landore Steel Works started, 44.
- Langloan, treatment of gases at, 155.
- Laterite, 57, 64.
- Layard, iron and bronze from Nimrod, 3.
- Ledebur and Borsig, aluminium in cast iron, 200.
- Ledebur, Prof. A., corrosion of iron and steel, 343; on malleable cast iron, 243; on silicon in grey iron, 192; on strong cast iron, 238; sulphur from cast iron, 200.
- Lewes, Prof. V. B., oxide and corrosion, 342; protecting iron, 340.
- Lias, ores of Middle, 59.
- Lifts, 99.
- Lignite, 160.
- Lime in puddling, 305; in slags, 182; suggested by Collyer for dephosphorising, 38, 45; use of, in blast furnace, 186.
- Limestone, 185; analyses of, 185; decomposition of, 140, 168.
- Limonite, 56.
- Lincolnshire, ores of, 56.
- Linings of blast furnace, carbon, 98; wear of, 98.
- Lister's hot blast valves, 121, 124.
- Liversidge, Prof., on rust, 334.
- Lloyd, F. H., open twyers, 130.
- Loam moulds, 226.
- Lodge and Richards, descent of charge, 145.
- Lösche, 236.
- Lower zone of reduction, 138.
- Lowmoor blast furnace, 95.
- Lowmoor Iron Works, 278.
- Luetcher, G. L., analyses of American iron, 213.
- Luftfrischen, 277.
- Lührman, history of firebrick stoves, 119.
- Lürmann on blast furnace hoshes, 96; on wear of linings, 98; on closed hearths, 97.
- Luxembourg Lorraine, ores of, 56.
- Lyell, Sir C., 2.
- Maadam, W. J.**, early Scottish iron, 8; on charcoal furnaces, 161.
- Madras, iron ores of, 51, 63; iron working in, 249.
- Magnesia in slags, 183, 185.
- Magnetic concentration of hematites, &c., 75.
- Magnetic concentrators, 73.
- Magnetic needle, use of, in iron mining, 71.
- Magnetic ores, properties of, 52.
- Magnetic oxide and corrosion, 342; as fettling, 286, 296, 299; protection by means of, 342, 346; theory, 295.
- Magnetites, concentration of, 73; impure, 52; pure, 51; used in India, 249, 253.
- Malabar, ore washing in, 72; tall furnaces in, 252.
- Malleable cast iron, 241; metal used for, 242.
- Mallet, R., on rust and corrosion, 334, 335, 336, 337, 344, 348.
- Mander and Vernon, patent for slag, 179.
- Manganese in Bessemer steel, 39; in cast iron, 204; in steel melting, 25; loss in furnace slag, 150; reduction of, 150; removal of sulphur by, 201.
- Manganese and corrosion, 339.
- Manganese and sulphur in cinder pig, 188; in iron, 151.
- Manganese dioxide, used for physic, 292.
- Marten, H., on hot-blast stoves, 116.

- Martin, E. P., experiments at Blaenavon, 47; on pyrometers, 126.
 Martin, P. and E., introduce Siemens-Martin steel, 44.
 Mason, Sir J., 42.
 Massel, 266.
 Massencz, J., on desulphurisation, 151; process for desulphurisation, 188, 201.
 Massick and Crookes' stove, 124.
 Mass, influence of, 138.
 Mather, on best Yorkshire iron, 278.
 Matheson, E., protecting iron, 349.
 Matrix, 49.
 Mechanical puddling, 310, 313.
 Mechanical rubbles, 311.
 Melting point of slags, 181.
 Menden, water-cooled screen at, 282.
 Metallic coatings, 347.
 Meteoric iron, 69; analyses of, 69.
 Micaceous iron ore, 54.
 Mild steel, corrosion of, 338.
 Mill, arrangement of, 281; French, for bars, in 1760, 14; furnace, 319; iron, 319; rolls, 323.
 Millard, M., on deficiency of cinder, 302.
 Minette, 57.
 Mingayo, on meteoric iron, 69.
 Minimum fuel consumption, 172.
 Mixer and desulphuriser, 152.
 Mixtures for smelting, 183.
 Modern furnace practice in America, 32.
 Modulus of elasticity of cast iron, 194.
 Moffart, E., fine ores in America, 77.
 Moissau, H., carbide of chromium, 207; carbon silicide, 197.
 Moisture in blast, 132.
 Monarch ore concentrator, 74.
 Mond, L., on ferro-carbonyl, 137.
 Morris, T., tests for wrought iron, 330.
 Morton, graphitic silicon, 197.
 Morton's, H., pyrometer, 126.
 Mottled iron, 190.
 Moulding boxes, 226; machines, 227; sand, 226, 228.
 Moulds, 226.
 Muck bars, 315.
 Mulhauser, carbon silicide, 197.
 Mumbles Head, ore worked at, 70.
 Mushet, D., patents for use of ilmenite, 53.
 Mushet, R., makes first Bessemer rail, 41; patents for use of manganese, 39; uses manganese with Bessemer steel, 39.
 Mycenæ, iron discovered by Schlie-
 mann, 4.
 Nasmyth, J., patent for purifying
 iron, 36.
 Native iron, 69.
 Natural gas used in direct process,
 262.
 Neilson, ammonia recovery process,
 155.
 Neilson, J. B., improved stove, 115;
 invents hot blast, 20; original hot-
 blast stove, 115; patent, 114.
 Nellumboor, iron making at, 253.
 New Jersey, ores of, 53, 64.
 New South Wales, ores of, 68.
 Nickel in meteoric iron, 69.
 Nickel plating, 347.
 Nimrod, iron from, 3.
 Nitric acid, action on iron, 191, 345.
 Noblins, 278.
 Norberg, ore concentrated at, 73.
 Northamptonshire, calcining ores in,
 80; early iron making, 6; ores of,
 56.
 North Chicago double-double fur-
 nace, 285.
 North Staffordshire calcined ore,
 287.
 Oakes, T., on blast furnace near
 Clee Hills, 17; experiment at
 Ketley, 169; improved shape of
 blast furnace, 23.
 Oils for protecting iron, 349.
 Oolitic ores, 56, 59.
 Open hearths, iron used in, 109, 267.
 Open mining of ores, 70.
 Ore mixtures, 183.
 Ore washers, 73.
 Ores, chief iron, 49.
 Original hot-blast apparatus, 21.
 Ormesby, blast-furnace charge at,
 133; Iron Works, 102.
 Osmund furnace, 248.
 Outerbridge, A. E., manganese in
 cast iron, 205.
 Ovens, long, 107; round, 117.
 Overhang of twyer, 131.
 Oxidation in puddling, 276, 300, 301,
 in reheating, 325.
 Oxygen in hearth of blast furnace
 134.
 Paints for protecting iron, 349.
 Parker, W., on corrosion, 339.
 Park mines, 70.
 Parliament restricts number of iron
 works, 9.

- Parry, G., introduces cup and cone, 27, 100.
- Passive state, 343, 345.
- Patent, Chance, Messrs., for slag, 179; Cort's, seized, 15; Heath's litigation, 25; Mander & Vernon's, for slag, 179; Payne's, J., for slag, 179; Price & Nicholson's, 218; refused to Bessemer, 40; refused to Siemens, 43; Turner's, 162.
- Paul, H., on siliceous iron, 196.
- Paving blocks from slag, 180.
- Payne, J., patent for slag, 179.
- Pechin, E. C., on descent of charge, 147.
- Pecten seams in Cleveland iron stone, 59.
- Pennsylvania, anthracite, 159; anthracite iron of, 22.
- Percy, Dr., on Abraham Darby, 11; on blast-furnace slag, 178; changes in ferrous carbonate, 62; corrosion of steel, 343; cyanides, 141; graphitic silicon, 197; lime in puddling, 305; phosphorus in puddling, 303; refinery at Bromford, 272; Russian sheet iron, 280; use of lime in blast furnace, 186.
- Pernot furnace, 313.
- Phenols from furnace tars, 156.
- Phillips, D., on corrosion, 338, 340, 342.
- Phillips, J. A., on hematite deposits, 71.
- Phosphates in iron ores, 66.
- Phosphorus, content of, in iron ores, 61; elimination in puddling, 303; geological age of, 65; in cast iron, 202; in ores, not removed by calcining, 79; in puddling, 289; in tap cinder, 304; not removed by Bessemer, 38; reduction of, 148; removal by magnetic concentration, 74.
- Physic, 292.
- Pietzka furnace, 309.
- Pig boiling, 271; introduced, 25; analyses of, 212; for puddling, 288; grading of, 211; handling of, 104.
- Piles, 319.
- Pilkington, H., 107; on American twyer, 130; analyses of limestone, 185; analysis of slag from Tipton, 178; blast-furnace equipment, 87; gas burners for boilers, 154; on sulphury iron, 202.
- Pilot Knob, Missouri, 64.
- Pipes, protection of, 349.
- Pistol pipe stove, 118.
- Pitch, coating with, 349.
- Pitting, 338, 339, 341, 348.
- Pittsburg, Blair-Adams' process at, 258; Eames' process at, 261.
- Plate iron, 269, 273.
- Playfair and Bunsen on cyanides, 141.
- Pliny on steel and iron, 4.
- Plot, Dr., Staffordshire blast furnace in 1686, 10.
- Plum, T. W., open twyers, 130.
- Polarisation, electric, of iron and steel, 341.
- Potter, J., 107.
- Pottery mine, 287.
- Practice, blast furnace, in England and America, 105.
- Preparation of fine ore, 76; of iron ores, 70.
- Pressure of blast, 33, 95, 106.
- Price & Nicholson's patent, 36, 218.
- Protection from rust, 346.
- Prus, G., on magnetic concentration, 75.
- Prussian patent refused to Bessemer, 40.
- Puddled bar, 292; production of, 315.
- Puddled iron, reheating, 319.
- Puddler's candles, 291.
- Puddling, details of working, 290; dry, 271; elimination of phosphorus, 303; elimination of sulphur, 304; fuel consumption, 306; gaseous fuel, 306; improvements in, 24; invented by Cort, 15; iron used for, 277; mechanical, 310; modern process invented by Hall, 24; other elements in, 305; oxidation in, 276, 300; pig iron for, 287; process, 281; process, modern, 274; reactions of, 293; reactions, thermal aspect, 296; theories of, 295; use of aluminium, 305; use of lime, 305.
- Puddling cinder, smelting of, 188.
- Puddling furnace, 281; Anderson's, 284; calorific efficiency, 307; Dank's mechanical, 311; details of, 284; Pietzka's, 309; preparation of, 289; Siemens, 308; Springer's, 309; double, 285; rotating, 311.
- Purple ore, 45, 286; use of, in blast furnace, 76.
- Pyrenees, Eastern, ores of, 66.
- Pyrometers, 125.

- Rabbles**, mechanical, 311.
Rabbling, 275.
Rachette furnace, 93.
Raetz, composition of enamel, 350.
Rails, iron, production of, 28, 41, 305.
Rajdoha, iron making at, 249.
Raström, iron for open hearth 267.
Reactions of carbon monoxide, 137 ; of direct processes, 247 ; of puddling, 293 ; of tap cinder, 299.
Read, A. A., decomposition of ferric oxide by heat, 296.
Reaumur describes crucible steel, 11, 35 ; on malleable cast iron, 241.
Red fossil ore, 55, 64.
Red-lead paint, 349.
Red-shortness caused rough edges, 329 ; due to lime, 305 ; due to sulphur, 289, 304.
Reduction by means of carbon, 171 ; heat evolved by, 136 ; in blast furnace, 135 ; lower zone of, 138 ; of area, 331 ; of manganese, 150 ; of phosphorus, 148 ; of silicon, 149 ; of sulphur, 150 ; temperature of, 142, 144 ; upper zone of, 135.
Refined iron, 273.
Refinery, 269, 272 ; introduced by Homfray, 16 ; reactions of, 274.
Refinery cinder, analysis of, 273.
Regenerative furnace, Siemens', 43.
Regenerative stoves, 30, 118.
Relative corrosion of iron and steel, 338.
Remelting cast iron, 221 ; changes during, 224.
Removal of rust, 343.
Renton, J., direct process, 260.
Retorts for direct production, 256.
Reverberatory furnace, 221 ; for direct reduction, 260 ; for indirect production of iron, 271.
Reynolds, W., patent for use of manganese, 39.
Rhine, ores carried on, 57.
Richards and Lodge, descent of charge, 145.
Richards, E. W., basic process at Middlesbrough, 47 ; on Bilbao ores, 67 ; use of lime at Eston, 187.
Richter, R., graphitic silicon, 197.
Ridsdale, C. H., analyses of pig iron, 212 ; on composition of slags, 183 ; on furnace barrows, 100 ; manganese in slag, 150.
Riley, E., analyses of blast furnace slag, 177 ; of slag, 175, 177 ; and of titanite iron, 209 ; chromium in puddled bar, 207 ; ores of Colonies, 68 ; use of tar in basic process, 47.
Riley, J., cupola with gaseous fuel, 224.
Ring scaffold, 147.
Rivets, iron, and corrosion, 340.
Roasting between closed walls, 80 ; in open heaps, 79.
Roberts-Austen, Prof., on cyanides, 141 ; on furnace charges, 180 ; recording pyrometer, 126.
Roberts, J., sample of titanite pig, 209.
Roberts, W. L., analysis of limestone, 185.
Rockingham Forest, iron manufacture of, 6.
Rogers, E., South Wales process, 270.
Rolls, 321 ; introduced by Major Hanbury, 14 ; grooved, patented by Cort, 15 ; guide, invented by Shinton, 15 ; plain, 321.
Rome, iron in, 4.
Roots' blower, 222.
Roscoe, Sir H., on carbonyl, 137.
Rose, H., decomposition of ferric oxide by heat, 296.
Rosebank foundry, experiments at, 237.
Rossie, A. J., reduction of titanite ore, 208.
Rossignaux, M. P., on furnace coke, 158.
Rotating furnaces, 311 ; Siemens', 260.
Rouge, 54.
Roughing rolls, 323.
Rubio, Spanish ore, 56, 66.
Rubricius, H., distribution of silicon, 198.
Running out fire, 269, 272.
Russian sheet iron, 279, 347.
Rust, analyses of, 334 ; causes of, 335 ; composition of, 334 ; formation of, 335 ; removal of, 343 ; varieties of, 337.
Rusting, 334.
Salem district, blast furnaces of, 250 ; ores of, 63.
Samuelson, Sir B., details of Cleveland furnaces, 87, 89 ; disposal of slag, 176.
Sand for mill furnace bottoms, 326 ; moulding, 228.
Saniter, E. H., process for desulphurisation, 188, 201.

- Scaffolds, 147.
 Scale, effect on corrosion, 341.
 Scarf, F., on loss in puddling, 301.
 Schinz, C., on use of lime, 186.
 Scotch foundry irons, 192.
 Scotch twyer, 129.
 Scotland, black-band of, 59; early iron working in, 8; special advantage from hot blast, 21.
 Scouring slag, 78, 149, 175.
 Scrap bars, 321.
 Scrubbers, 155.
 School of Mines, Thomas and Gilchrist at, 46.
 Sea water and corrosion, 337.
 Sefström on silicon in grey iron, 192.
 Self-fluxing ores, 183.
 Shale, removal of, by weathering, 77.
 Shape of blast furnace, 93; Hawdon and Howson's, 93; improved, 22; effect of, on castings, 229.
 Shaw, J. L., geology of hæmatite ores, 55.
 Sheet iron, Russian, 279.
 Sheffield and Birmingham Iron Co., 93.
 Shimer, P. W., carbide of titanium, 210.
 Shingling, 315.
 Ship, steel, superior to iron, 42.
 Shrunk lime used in basic process, 47.
 Siemens-Martin process, 44.
 Siemens, Sir W., corrosion of steel boilers, 339; direct process, 44, 260; history of, 42; regenerative system, 30; theory of puddling, 295.
 Siemens' mill furnace, 321; puddling furnace, 308; pyrometer, 125; regenerative furnace, 260; steel melting furnace, 44.
 Silica in slags, 181; reduction of, 139.
 Silicates in furnace mixtures, 180.
 Silicide of carbon, 198.
 Silicon and sulphur in iron, 150.
 Silicon, condition in cast iron, 197; distribution of, in pig iron, 198; ferro-manganese, 204, 215; in cast iron, 192; in foundry practice, 195; reduction of, 149; removal of, in puddling, 291, 295.
 Silicon iron, made when blowing in, 105.
 Silicon pig, 149, 192; not readily corrodable, 339, 345; spiegel, 204, 215.
 Silvester, H., analysis of titanic pig iron, 209.
 Simmersbach, analyses of coke, 158.
 Simon-Carve's coke, 158.
 Sinterblech, 265.
 Size, effect of, on castings, 229.
 Sizing iron ores, 72.
 Sjogren, H., on use of magnetic needle, 71.
 Skull scaffold, 147.
 Slack furnaces, 306.
 Slag, disposal of, 175; granulation of, 176, 179; heat of fusion of, 184; in wrought iron, 327; "scouring," 78, 149, 175; utilisation of, 178; without lime, 178.
 Slag blocks, 180.
 Slag, Cleveland, 176.
 Slag wool, 179.
 Slags, accumulations of ancient, 5, 6; alumina in, 183; and fluxes in smelting, 175; appearance of, 175; for different kinds of iron, 183; formation of, 140; magnesia in, 183; melting point of, 181; silica in, 181.
 Slips, 147.
 Smethwick, experiments at, 205.
 Smith, Dr. A., protecting water pipes, 349.
 Smith Watson, on Gartsherrie tar, 156.
 Snelus, G. J., ferric oxide theory, 296; on graphite from cast iron, 191; graphitic silicon, 197; on manganese and corrosion, 339; patent lime lining, 46; on silicon in grey iron, 192.
 Sodium nitrate, use of, by Heaton, 46.
 Softeners, 192, 205.
 Soft mixtures, 221.
 Sohler and Bürger, protecting iron, 350.
 Sorby, Dr., crystallised silicon 198.
 South Staffordshire Institute, Sub Committee, 284.
 South Wales, indirect process, 269.
 Spanish ore, imported, 31.
 Spanish ores, 66, 67.
 Spathic iron ore, 57.
 Spathic ores in Bilbao, 67.
 Specular iron ore, 54.
 Spiegel-eisen, 150, 204.
 Splint coal, 159.
 Springer's puddling furnace, 309.
 Squeezers, 316.

- Staffordshire ack band ironstone, 59; blast furnace in 1854, 24, 29; calcining ores in, 79; cinder pig, 188; early iron trade, 9; helve, 315; iron, best, 292; make of pig iron in 1825, 18; puddling furnace, 283; rolls, 323; Steel Company, 326; twyer, 129.
- Staffordshire All Mine iron, analyses of, 212; pig iron, 203, 212.
- Stalls used for roasting, 81.
- Stead, J. E., chromium in pig iron, 206; distribution of sulphur in pig iron, 202; phosphorus in iron ores, 65; phosphorus in puddling, 304; silicon in cast iron, 196; slag, 179; vanadium in pig iron, 208; waste gases, 153.
- Stead and Pattinson, arsenic in cast iron, 210.
- Steam hammers, 317.
- Steel alloys, corrosion of, 339, 342.
- Steel Company of Scotland, 45.
- Steel known to Romans, 4; hardened, corrosion of, 343; melting, use of manganese, 25; rolling of, 330.
- Stephenson, R., on foundry mixtures, 217.
- Stewart's rapid cupola, 223.
- Stirling, Dr., regenerative engine, 43.
- Stirling, J. D. M., tin in puddling, 305; toughened cast iron, 36, 218.
- Stone Age, 1.
- Storrie, J., Roman iron near Cardiff, 5.
- Stoves, hot-blast, 30, 115.
- Stridsberg, four-twyer hearth, 268.
- Stückofen, 6, 252.
- Styria, early iron industry of, 4; open hearth of, 264; production of cast iron in, 107.
- Sulphide of iron, production of, 337.
- Summerlee, treatment of gases at, 155.
- Sulphur assists corrosion, 337; distribution of, 202; elimination in puddling, 304; in cast iron, 200; in limestone, 186; reduction of, 150; removal of, by weathering, 77; so-called, 291.
- Sulphur and manganese in iron, 151.
- Sulphur and silicon in cast iron, 150.
- Sulphuric acid, action on iron, 191, 343.
- Sussex, early iron trade, 6.
- Swank, J. M., iron in all ages, 19.
- Swedish iron, production in open hearth, 268; used for steel making, 26.
- Swedish-Lancashire hearth, 268.
- Swedish magnetites, 51.
- Swiss Lake dwellings, 2.
- Tap cinder, analyses of, 297; calcined by Hall, 25; phosphorus in, 304; reactions and constitution, 299; varieties of, 297.
- Tapping cinder, 297, 298.
- Tar, coating with, 349; composition of, from waste gases, 154, 155.
- Taylor-Langdon kiln, 84.
- Temperature of blast, 125; of blast furnace, 143, 144; of reduction, 142; of waste gases, 143, 144.
- Tenacity of wrought iron, 330.
- Tensile strength of cast iron, 194, 234, 236.
- Test bars, shape and size of, 234, 235, 240.
- Tests for foundry iron, 239.
- Theories of puddling, 295.
- Theory of hot blast, 112.
- Thermal calculations of puddling reactions, 296.
- Thermo-chemical calculation of fuel used in blast furnace, 164.
- Thermo-electric pyrometer, 126.
- Thielen, A., smelting fine ores in Germany, 76.
- Thomas, S. G., announces success of basic process, 47; inventor of basic process, 46.
- Thomas ore washer, 73.
- Thomson, W., prevention of pitting, 348.
- Thornaby Iron Works, 102.
- Thürner, rust in tunnels, 336.
- Thorne, T. L., on carbonyl, 137.
- Thorpe, Dr., sample of early Scottish iron, 8.
- Thwaite, B. H., early French bar mill, 14.
- Tiglatb-Pileser, 3.
- Tilden, Dr. W. A., on amorphous silicon, 345; graphitic silicon, 197; sample of early Scottish iron, 8.
- Tinplate, 347.
- Tin used in puddling, 305.
- Tipton Green, slag and iron at, 178.
- Tipton, iron made at, 178, 274, 292.
- Titanic iron ore, 53; composition of, 53; reduction of, 208.
- Titanic paint, 350.
- Titanium in cast iron, 208.
- Titanium, nitride of, 208.
- Tondü, use of ilmenite at, 53.
- Towcester, Siemens' works at, 45.

- Treble best iron, 328.
 Trompe, 246.
 Tubal-Cain, 2.
 Tube, central, for blast furnaces, 101.
 Tubercular corrosion, 337.
 Tucker, A. E., analyses of pig iron, 212; analyses of refined iron, 274; iron for puddling, 288; lime in puddling, 306; reactions of puddling, 294.
 Tucker & Harbord, basic bottoms, 326.
 Tunnels, rusting of iron in, 336.
 Tunner, Prof., on German hearths, 264; reduction in charcoal furnaces, 142, 170; temperature of blast furnace, 143; use of brown coal, 160.
 Turner, T., on Alabama ores, 55; analyses of remelted samples, 224; condition of silicon, 197; hardness of cast iron, 232; oxidation in puddling, 276; patent for gaseous fuel, 162; sclerometer, 241; silicon and sulphur in cast iron, 170; silicon in cast iron, 192; on Styrian iron, 107; on Styrian open hearth, 264; use of steel scrap, 220; varieties of cinder, 297.
 Turner, T., and Barrows, slag in wrought iron, 326.
 Turner, T., and Jordan, condition of silicon, 197.
 Tweedie, on corrosion, 342.
 Twyer, American open, 131; open, 130; overhang of, 131; Scotch, 129; spray, 130; Staffordshire, 129.
 Twyers, 17, 23, 115, 128.
 Tymp-plate, 97.
- Underhand**, puddlers, 284, 291.
 United States, distribution of iron ores, 65; iron ores of, 55, 64.
 Unwin, Prof., samples from, 224.
 Utilisation of slag, 178.
- Valentine**, S. G., experiments on calcination, 78.
 Valves, hot-blast, 121; Lister's, 121, 124.
 Vanadium in cast iron, 207.
 Varieties of rust, 337; of tap cinder, 297.
 Varnishes for protecting iron, 349.
 Vaughan, J., ore worked by, 59.
 Vein-stuff, 49.
 Veley, V. H., properties of dry lime, 187.
- Venström magnetic concentrator, 74.
 Vertical blast engine, 111.
 Volklinger Works, granulation of slag, 176.
 Vosmaer, removal of rust, 343.
- Wainwright**, J. T., gaseous fuel in blast furnace, 162.
 Walloon process in Sweden, 268.
 Walton, J. P., analyses of cast iron, 192.
 Washing iron ores, 72.
 Wassiac, strong cast iron from, 238.
 Waste in reheating iron, 324.
 Waste gases, collection of, 100; composition of, 152; from blast furnaces, 27; temperature of, 143, 144; used for steam, 27; 154.
 Waste of heat, Sir L. Bell, on, 174.
 Water-balance lift, 99.
 Water blocks in blast furnace lining, 93.
 Water, storage of, in galvanised iron, 348.
 Watt, J., steam engines, 12, 111.
 Weathering, 77.
 Webb, H. A., lime in puddling, 306.
 Wedding, Dr., on carbon linings, 99; on puddling furnaces, 309; on special charging apparatus, 102; on twyer at Hoerde, 130.
 Wednesday, use of waste gases at, 26.
 Weight of materials, 100.
 West of Scotland, splint coal, 160.
 Westray and Copeland's hot-blast valve, 125.
 West, T. D., use of steel scrap, 220.
 Wheel, casting of, 231.
 White cast iron, action of acids on, 344.
 White iron, 190; ore mixtures producing, 184; slag from, 177.
 White, J. L., 107.
 White, Sir W. H., scale and corrosion, 341.
 Whiting, J., on ratio of CO to CO₂, 168.
 Whitwell stove, 30, 122.
 Whitwell, T., 107; on removal of scaffolds, 147.
 Wiborgh, W., pyrometer, 125.
 Widmannstätten figures, 69.
 Wilkie, early form of blast furnace, 93.
 Wilson, A. P., ores of south of Spain, 67.

- Wipers, 315.
- Winchell, H. V., geology of iron ores, 63.
- Windzacken, 265.
- Wingham, A., on furnace charges, 181.
- Wingham and Ball, on desulphurisation, 201.
- Winslow's squeezer, 317.
- Wishaw, Ferrie's furnace at, 160.
- Wobblers, 324.
- Wöhler, graphitic silicon, 197; titanium nitride, 208.
- Wollaston, titanium nitride, 208.
- Wood, C., calcining ore and limestone, 188; on dust in Cowper stoves, 121; use of siliceous iron, 196; on utilisation of slag, 179.
- Woodhouse, J., analysis of best tap, 287.
- Woodward cupola, 223.
- Wool, slag, 179.
- Woolwich, experiments in 1858, 204, 234, 238.
- Working conditions, effect of, in blast furnace, 169.
- Wrought iron, best Yorkshire, 279; blisters on, 330; corrosion of, 338; definition, 244; direct production, 244; extended application of, 27; further treatment, 315; indirect production of, 263; physical properties, 330; properties of best Yorkshire, 279; slag in, 327; used for foundry mixtures, 218; used for ships, 28.
- Yates, direct process, 258.
- Yorkshire, early iron trade, 9; iron ores of, 53.
- Yorkshire iron, analyses of, 279; best, 278.
- Ystalyfera, use of waste gases at, 27.
- Zinc, coating iron with, 348; for protecting iron, 348; in blast furnace dust, 102.
- Zinc dust, for protecting iron, 349.
- Zincite, 52.
- Zsigmondy, R., on slag, 179.

A SELECTION
FROM THE
SCIENTIFIC AND TECHNICAL WORKS

PUBLISHED BY

CHARLES GRIFFIN & COMPANY, LIMITED.

(Being Sections 4-10 from Messrs. Griffin's "General Catalogue.")

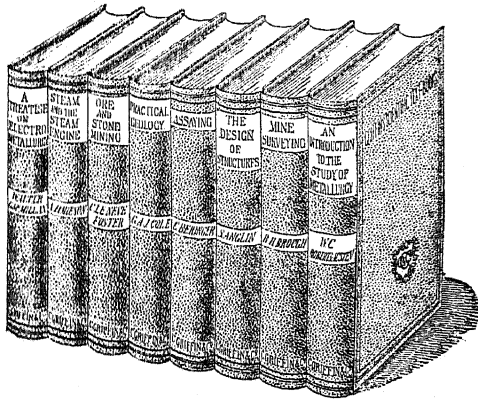

MESSRS. CHARLES GRIFFIN & COMPANY'S PUBLICATIONS may be obtained through any Bookseller in the United Kingdom, or will be sent post free on receipt of remittance to cover published price. To prevent delay, Orders should be accompanied by a Remittance. Cheques and Postal Orders to be crossed "SMITH, PAYNE & SMITHS."

*** For INDEX, see next page.*



 **MEDICAL, and GENERAL CATALOGUES** forwarded Post-free on Application.

LONDON:
EXETER STREET, STRAND.

INDEX.

	PAGE
ALLINGHAM (W.), Navigation,	45, 47
— Meteorology,	45
ANGLIN (S.), Design of Structures,	26
BARKER (D. WILSON-), Navigation and Seamanship,	45, 47
BERINGER (J. J. & C.), Assaying,	66
BILES (Prof. J. H.), Construction of Ships,	38
BLACKMORE (E.), British Mercantile Marine,	45-46
BLOUNT (B.) and BLOXAM (A. G.), Chemistry for Engineers and Manufacturers,	27, 71
BLYTH (A. Wynter), Foods and Poisons,	72
BORCHERS (Dr.), Electric Smelting,	67
BROTHERS (A.), Photography,	73
BROUGH (B. H.), Mine-Surveying,	59
BROWNE (W. R.), Works by,	27
BRUCE (Robt.), Food Supply,	54
BUCK (R. C.), Algebra and Trigonometry,	45, 46
BUTTERFIELD (W. J. A.), Gas Manufacture,	74
CASTELL-EVANS (Prof.), Tables for Chemists,	75
COLE (Prof. G. A. J.), Practical Geology, — Open Air Studies in Geology,	53 86
COLE (W. H.), Light Railways,	41
COX (S. H.), Prospecting for Minerals,	55
CRIMP (W. S.), Sewage Disposal Works,	28
DONKIN (Bryan), Gas and Oil Engines, — Efficiency of Steam Boilers,	29 29
DUERR (Geo.), Bleaching and Calico-Printing,	83
DUPRE & HAKE, Manual of Chemistry,	70
ETHERIDGE (R.), Stratigraphical Geology,	52
FIDLER (Prof.), Bridge-Construction,	30
FOSTER (Prof. C. le Neve), Ore and Stone Mining, — Elementary Mining,	56 56
GINSBURG (Dr.), Legal Duties of Shipmasters,	45, 49
GRIFFIN (J. J.), Chemical Recreations,	75
GRIFFIN'S Electrical Price-Book,	43
GRIFFIN'S ENGINEERING PUBLICATIONS,	25
GRIFFIN'S GEOLOGICAL and METALLURGICAL SERIES,	51
GRIFFIN'S NAUTICAL SERIES,	45
GRIFFIN'S NEW LAND SERIES,	54
GRIFFIN'S CHEMICAL AND TECHNOLOGICAL PUBLICATIONS,	69
GURDEN (R.), Traverse Tables,	31
GUTTMANN (O.), Blasting,	59
HARBORD (F. W.), Steel,	65
HUGHES (H. W.), Coal Mining,	57
HURST (Chas.), Valves and Valve-Gearing,	31
HURST (G. H.), Painters' Colours, — Garment Dyeing and Cleaning	76 83
JAMIESON (Prof.), MANUALS, Advanced and Elementary,	32
— Steam Engine,	32
— Applied Mechanics,	32
— Magnetism and Electricity,	32
JENKINS (H. C.), Metallurgical Machinery,	62
JOHNSON (J. C. F.), Getting Gold,	55
KNECHT & RAWSON, Dyeing,	81
LAFAR and SALTER, Technical Mycology,	79
LAWN (J. G.), Mine Accounts,	60

	PAGE
LIVERSIDGE (J. G.), Engine-Room Practice,	34
MACKENZIE (T.), Mechanics for Sailors,	45, 48
M' MILLAN (W. G.), Electro-Metallurgy, 68 — & BORCHERS, Electric Smelting,	67
MILLAR (W. J.), Latitude and Longitude: How to find them,	45, 48
MUNRO & JAMIESON'S Electrical Pocket-Book,	43
MUNRO (Dr.), Agricultural Chemistry,	75
MUNRO (R. D.), Steam-Boilers, — Kitchen Boiler Explosions,	33 33
NYSTROM'S Pocket-Book for Engineers,	33
PEARCE (W. J.), Painting and Decorating,	77
PETTIGREW (W. F.), Manual of the Locomotive,	34
PHILLIPS & BAUERMAN, Metallurgy,	61
POYNTING (Prof.), Mean Density of the Earth,	44
PRAEGER (R. L.), Open Air Botany,	86
RANKINE'S Applied Mechanics, — Civil Engineering, — Machinery and Millwork, — Steam Engine and other Prime Movers, — Useful Rules and Tables, — A Mechanical Text-Book, — Miscellaneous Scientific Papers,	35 35 35 36 36 36
REDGRAVE (G. R.), Cements,	76
REDWOOD (Boverton), Petroleum,	58
REED (Sir E. J.), Stability of Ships,	38
REID (Geo. M.D.), Practical Sanitation,	85
RICHMOND (H. D.), Dairy Chemistry,	25
RIDDELL (Dr. Scott), Ambulance Manual,	85
ROBERTS-AUSTEN (Prof.), Metallurgy and Alloys,	62, 63
ROBINSON (Prof.), Hydraulics,	37
ROSE (T. K.), Gold, Metallurgy of,	64
ROTHWELL, (C. F. Seymour), Textile Printing,	82
SCHWACKHÖFER and BROWNE, Fuel and Water,	27
SEATON (A. E.), Marine Engineering,	39
SEATON & ROUNTHWAITE, Marine Engineers' Pocket-Book,	39
SEELEY (Prof.), Physical Geology,	52
SEXTON (Prof.), Elementary Metallurgy, — Quantitative & Qualitative Analysis,	66 70
SHELTON (W. V.), Mechanic's Guide,	36
SMITH, (Johnson), Shipmaster's Medical Help,	49
SMITH (Prof. R. H.), Calculus for Engineers, — Measurement Conversions,	40 40
SYKES (Dr. W. J.), Brewing,	78
THOMSON & POYNTING (Profs.) Text-Book of Physics,	44
TRAILL (T. W.), Boilers, Land and Marine,	41
TURNER (Thos.), Iron, Metallurgy of,	65
WALTON (T.), Know Your Own Ship,	41, 50
WATKINSON (Prof. W. H.), Gas and Oil Engines,	42
WELLS (S. H.), Engineering Drawing,	42
WIGLEY (T. B.), Goldsmith and Jeweller's Art,	68
WRIGHT (Dr. Alder), The Threshold of Science, — Oils and Fats, Soaps and Candles,	80 80
YEAMAN (C. H.), Elec. Measurements,	43
YEAR-BOOK of Scientific Societies,	84

§§ 4-5. Griffin's Standard Publications

FOR		PAGE
ENGINEERS, ELECTRICIANS, ARCHITECTS, BUILDERS, NAVAL CONSTRUCTORS, AND SURVEYORS.		
Applied Mechanics,	RANKINE, BROWNE, JAMIESON,	35, 27, 32
Civil Engineering,	PROF. RANKINE,	35
Bridge-Construction,	PROF. FIDLER,	30
Design of Structures,	S. ANGLIN,	26
Sewage Disposal Works,	SANTO CRIMP,	28
Traverse Tables,	R. L. GURDEN,	31
Light Railways,	W. H. COLE,	41
Marine Engineering,	A. E. SEATON,	39
Engine-Room Practice,	J. G. LIVERSIDGE,	34
Design and Construction of Ships,	} PROF. HARVARD BILES,	38
Stability of Ships,		
The Steam-Engine,	RANKINE, JAMIESON,	35, 32
The Locomotive,	W. F. PETTIGREW,	34
Valves and Valve-Gearing,	CHAS. HURST,	31
Gas, Oil, and Air-Engines,	BRYAN DONKIN,	29
Boilers: Construction,	T. W. TRAILL,	41
„ Management,	R. D. MUNRO,	33
„ Heat Efficiency,	BRYAN DONKIN,	29
Chemistry for Engineers,	BLOUNT & BLOXAM,	27
Fuel and Water (for Steam Users),	{ SCHWACKHÖFER AND BROWNE, }	27
Machinery and Millwork,	PROF. RANKINE,	35
Hydraulic Machinery,	PROF. ROBINSON,	37
Metallurgical Machinery,	H. C. JENKINS,	62
Nautical Text-Books,	Ed. by CAPT. BLACKMORE,	45
Useful Rules and Tables for Engineers, &c.,	{ PROFS. RANKINE AND JAMIESON, }	36
Electrical Pocket-Book,	MUNRO AND JAMIESON,	43
Electrical Price-Book,	H. J. DOWSING,	43
The Calculus for Engineers,	PROF. ROBT. H. SMITH,	40
Graphic Tables for Con- version of Measurements,	PROF. ROBT. H. SMITH,	40
Marine Engineers' Pocket- Book,	SEATON AND ROUNTHWAITE,	39
Nystrom's Pocket-Book,	DENNIS MARKS,	33

THE DESIGN OF STRUCTURES:

A Practical Treatise on the Building of Bridges, Roofs, &c.

By S. ANGLIN, C.E.,

Master of Engineering, Royal University of Ireland, late Whitworth Scholar &c.

With very numerous Diagrams, Examples, and Tables.

Large Crown 8vo. Cloth.

SECOND EDITION, Revised. 16s.

The leading features in Mr. Anglin's carefully-planned "Design of Structures" may be briefly summarised as follows:—

1. It supplies the want, long felt among Students of Engineering and Architecture, of a concise Text-book on Structures, requiring on the part of the reader a knowledge of ELEMENTARY MATHEMATICS only.

2. The subject of GRAPHIC STATICS has only of recent years been generally applied in this country to determine the Stresses on Framed Structures; and in too many cases this is done without a knowledge of the principles upon which the science is founded. In Mr. Anglin's work the system is explained from FIRST PRINCIPLES, and the Student will find in it a valuable aid in determining the stresses on all irregularly-framed structures.

3. A large number of PRACTICAL EXAMPLES, such as occur in the every-day experience of the Engineer, are given and carefully worked out, some being solved both analytically and graphically, as a guide to the Student.

4. The chapters devoted to the practical side of the subject, the Strength of Joints, Punching, Drilling, Rivetting, and other processes connected with the manufacture of Bridges, Roofs, and Structural work generally, are the result of MANY YEARS' EXPERIENCE in the bridge-yard; and the information given on this branch of the subject will be found of great value to the practical bridge-builder.

"Students of Engineering will find this Text-Book INVALUABLE."—*Architect*

"The author has certainly succeeded in producing a THOROUGHLY PRACTICAL Text-Book."—*Builder*.

"We can unhesitatingly recommend this work not only to the Student, as the BEST TEXT-BOOK on the subject, but also to the professional engineer as an EXCEEDINGLY VALUABLE book of reference."—*Mechanical World*.

"This work can be CONFIDENTLY recommended to engineers. The author has wisely chosen to use as little of the higher mathematics as possible, and has thus made his book of REAL USE TO THE PRACTICAL ENGINEER. . . . After careful perusal, we have nothing but praise for the work."—*Nature*.

LONDON: CHARLES GRIFFIN & CO., LIMITED, EXETER STREET, STRAND.

In Large 8vo. Handsome Cloth. 10s. 6d.

CHEMISTRY FOR ENGINEERS.

BY
BERTRAM BLOUNT, AND **A. G. BLOXAM,**
 F.I.C., F.C.S., A.I.C.E., F.I.C., F.C.S.,
 Consulting Chemist to the Crown Agents for Consulting Chemist, Head of the Chemistry
 the Colonies. Department, Goldsmiths' Inst.,
 New Cross.

GENERAL CONTENTS.—Introduction—Chemistry of the Chief Materials of Construction—Sources of Energy—Chemistry of Steam-raising—Chemistry of Lubrication and Lubricants—Metallurgical Processes used in the Winning and Manufacture of Metals.

"The authors have succeeded beyond all expectation, and have produced a work which should give FRESH POWER to the Engineer and Manufacturer."—*The Times*.

"PRACTICAL THROUGHOUT . . . AN ADMIRABLE TEXT-BOOK, useful not only to Students, but to ENGINEERS and MANAGERS OF WORKS IN PREVENTING WASTE and IMPROVING PROCESSES."—*Newtonian*

"A book worthy to take HIGH RANK . . . treatment of the subject of GASEOUS FUEL particularly good. . . . WATER GAS and its production clearly worked out. . . . We WARMLY RECOMMEND the work."—*Journal of Gas Lighting*.

For Companion Volume by the same Authors, "CHEMISTRY FOR MANUFACTURERS," see p. 71.

WORKS BY **WALTER R. BROWNE, M.A., M.INST.C.E.,**
 Late Fellow of Trinity College, Cambridge.

THE STUDENT'S MECHANICS: An Introduction to the Study of Force and Motion.

With Diagrams. Crown 8vo. Cloth, 4s. 6d.

"Clear in style and practical in method, 'THE STUDENT'S MECHANICS' is cordially to be commended from all points of view."—*Athenaeum*.

FOUNDATIONS OF MECHANICS.

Papers reprinted from the *Engineer*. In Crown 8vo, 1s.

Demy 8vo, with Numerous Illustrations, 9s.

FUEL AND WATER:

A Manual for Users of Steam and Water.

BY PROF. FRANZ SCHWACKHÖFER OF VIENNA, AND
 WALTER R. BROWNE, M.A., C.E.,

GENERAL CONTENTS.—Heat and Combustion—Fuel, Varieties of—Firing Arrangements: Furnace, Flues, Chimney—The Boiler, Choice of—Varieties—Feed-water Heaters—Steam Pipes—Water: Composition, Purification—Prevention of Scale, &c., &c.

"The Section on Heat is one of the best and most lucid ever written."—*Engineer*.
 "Cannot fail to be valuable to thousands using steam power."—*Railway Engineer*.

LONDON: CHARLES GRIFFIN & CO., LIMITED, EXETER STREET, STRAND.

SEWAGE DISPOSAL WORKS:

A Guide to the Construction of Works for the Prevention of the Pollution by Sewage of Rivers and Estuaries.

BY

W. SANTO CRIMP, M. INST. C. E., F. G. S.,

Late Assistant-Engineer, London County Council

With Tables, Illustrations in the Text, and 37 Lithographic Plates. Medium 8vo. Handsome Cloth.

SECOND EDITION, REVISED AND ENLARGED. 30s.

PART I.—INTRODUCTORY.

Introduction.

Details of River Pollutions and Recommendations of Various Commissions.
Hourly and Daily Flow of Sewage.
The Pail System as Affecting Sewage.
The Separation of Rain-water from the Sewage Proper.

Settling Tanks.
Chemical Processes.
The Disposal of Sewage-sludge.
The Preparation of Land for Sewage Disposal.
Table of Sewage Farm Management.

PART II.—SEWAGE DISPOSAL WORKS IN OPERATION—THEIR CONSTRUCTION, MAINTENANCE, AND COST.

Illustrated by Plates showing the General Plan and Arrangement adopted in each District.

Map of the LONDON Sewage System.
Crossness Outfall.
Barking Outfall.
Doncaster Irrigation Farm.
Beddington Irrigation Farm, Borough of Croydon.
Bedford Sewage Farm Irrigation.
Dewsbury and Hitchin Intermittent Filtration.
Merton, Croydon Rural Sanitary Authority.
Swanwick, Derbyshire.
The Ealing Sewage Works.
Chiswick.
Kingston-on-Thames, A. B. C. Process.
Salford Sewage Works.

Bradford, Precipitation.
New Malden, Chemical Treatment and Small Filters.
Friern Barnet.
Acton, Ferozone and Polarite Process.
Ilford, Chadwell, and Dagenham Works.
Coventry.
Wimbledon.
Birmingham.
Margate.
Portsmouth.
BERLIN Sewage Farms.
Sewage Precipitation Works, Dortmund (Germany).
Treatment of Sewage by Electrolysis

* * * From the fact of the Author's having, for some years, had charge of the Main Drainage Works of the Northern Section of the Metropolis, the chapter on LONDON will be found to contain many important details which would not otherwise have been available.

"All persons interested in Sanitary Science owe a debt of gratitude to Mr. Crimp. . . . His work will be especially useful to SANITARY AUTHORITIES and their advisers. . . . EMINENTLY PRACTICAL AND USEFUL. . . . gives plans and descriptions of MANY OF THE MOST IMPORTANT SEWAGE WORKS of England. . . . with very valuable information as to the cost of construction and working of each. . . . The carefully-prepared drawings permit of an easy comparison between the different systems."—*Lancet*.

"Probably the MOST COMPLETE AND BEST TREATISE on the subject which has appeared in our language. . . . Will prove of the greatest use to all who have the problem of Sewage Disposal to face."—*Edinburgh Medical Journal*.

LONDON: CHARLES GRIFFIN & CO., LIMITED, EXETER STREET, STRAND.

Works by BRYAN DONKIN, M.Inst.C.E., M.Inst.Mech.E., &c.

GAS, OIL, AND AIR ENGINES:

A Practical Text-Book on Internal Combustion Motors
without Boiler.

BY BRYAN DONKIN, M.Inst.C.E., M.Inst.Mech.E.

SECOND EDITION, Revised throughout and Enlarged. With numerous additional Illustrations. Large 8vo. 25s.

GENERAL CONTENTS.—Gas Engines:—General Description—History and Development—British, French, and German Gas Engines—Gas Production for Motive Power—Theory of the Gas Engine—Chemical Composition of Gas in Gas Engines—Utilisation of Heat—Explosion and Combustion. Oil Motors:—History and Development—Various Types—Priestman's and other Oil Engines. Hot-Air Engines:—History and Development—Various Types: Stirling's, Ericsson's, &c., &c.

"The BEST BOOK NOW PUBLISHED on Gas, Oil, and Air Engines."—*The Engineer*.

"We HEARTILY RECOMMEND Mr. Donkin's work. . . . A monument of careful labour. . . . Luminous and comprehensive."—*Journal of Gas Lighting*.

In Quarto, Handsome Cloth. With Numerous Plates. 25s.

STEAM BOILERS: LAND AND MARINE

(The Heat Efficiency of).

With many Tests and Experiments on different Types of Boilers, as to the Heating Value of Fuels, &c., with Analyses of Gases and Amount of Evaporation, and Suggestions for the Testing of Boilers.

BY BRYAN DONKIN, M.Inst.C.E.

GENERAL CONTENTS.—Classification of different Types of Boilers—425 Experiments on English and Foreign Boilers with their Heat Efficiencies shown in Fifty Tables—Fire Grates of Various Types—Mechanical Stokers—Combustion of Fuel in Boilers—Transmission of Heat through Boiler Plates, and their Temperature—Feed Water Heaters, Superheaters, Feed Pumps, &c.—Smoke and its Prevention—Instruments used in Testing Boilers—Marine and Locomotive Boilers—Fuel Testing Stations—Discussion of the Trials and Conclusions—On the Choice of a Boiler, and Testing of Land, Marine, and Locomotive Boilers—Appendices—Bibliography—Index.

"Very large sums of money, representing many millions sterling, have been invested in Steam Boilers, and many Engineers are continually studying economy in Coal. The question of HEAT EFFICIENCY is, therefore, not a small one. . . . We shall not be far wrong in estimating that 200 million tons of coal are used annually in generating Steam, of which MUCH IS WASTED. Putting the cost per ton at the low average price of 10s., we get about 100 MILLION POUNDS STERLING OR ABOUT THE ANNUAL VALUE OF the fuel consumed under Stationary, Semi-portable, Locomotive, and Marine Boilers. If 10 per cent. or 15 per cent. could be economised, a very moderate estimate, it would represent a GREAT GAIN to the world at large."

—Extract from Author's Preface.

LONDON: CHARLES GRIFFIN & CO., LIMITED, EXETER STREET, STRAND.

WORKS BY
ANDREW JAMIESON, M.INST.C.E., M.I.E.E., F.R.S.E.,
*Professor of Electrical Engineering, The Glasgow and West of Scotland
 Technical College.*

PROFESSOR JAMIESON'S ADVANCED MANUALS.

In Large Crown 8vo. Fully Illustrated.

1. STEAM AND STEAM-ENGINES (A Text-Book on).

For the Use of Students preparing for Competitive Examinations. With over 200 Illustrations, Folding Plates, and Examination Papers. TWELFTH EDITION. Revised and Enlarged, 8/6.

"Professor Jamieson fascinates the reader by his CLEARNESS OF CONCEPTION AND SIMPLICITY OF EXPRESSION. His treatment recalls the lecturing of Faraday."—*Athenaeum*.

"The BEST BOOK yet published for the use of Students."—*Engineer*.

"Undoubtedly the MOST VALUABLE AND MOST COMPLETE Hand-book on the subject that now exists."—*Marine Engineer*.

2. MAGNETISM AND ELECTRICITY (An Advanced Text-Book on). Specially arranged for Advanced and "Honours" Students.

3. APPLIED MECHANICS (An Advanced Text-Book on).

Vol. I.—Comprising Part I.: The Principle of Work and its applications; Part II.: Gearing. Price 7s. 6d. SECOND EDITION.

"FULLY MAINTAINS the reputation of the Author—more we cannot say."—*Pract. Engineer*.

Vol. II.—Comprising Parts III. to VI.: Motion and Energy; Graphic Statics; Strength of Materials; Hydraulics and Hydraulic Machinery. Price 7s. 6d.

"WELL AND LUCIDLY WRITTEN."—*The Engineer*.

PROFESSOR JAMIESON'S INTRODUCTORY MANUALS.

With numerous Illustrations and Examination Papers.

1. STEAM AND THE STEAM-ENGINE (Elementary Text-Book on). For First-Year Students. SIXTH EDITION. 3/6.

"Quite the RIGHT SORT OF BOOK."—*Engineer*.

"Should be in the hands of EVERY engineering apprentice."—*Practical Engineer*

2. MAGNETISM AND ELECTRICITY (Elementary Text-Book on). For First-Year Students. FOURTH EDITION. 3/6.

"A CAPITAL TEXT-BOOK . . . The diagrams are an important feature."—*Schoolmaster*.

"A THOROUGHLY TRUSTWORTHY Text-book . . . Arrangement as good as well can be. . . Diagrams are also excellent. . . The subject throughout treated as an essentially PRACTICAL one, and very clear instructions given."—*Nature*.

3. APPLIED MECHANICS (Elementary Text-Book on).

Specially arranged for First-Year Students. THIRD EDITION, Revised and Enlarged. 3/6.

"Nothing is taken for granted. . . . The work has VERY HIGH QUALITIES, which may be condensed into the one word 'CLEAR.'"—*Science and Art*.

A POCKET-BOOK of ELECTRICAL RULES and TABLES.

FOR THE USE OF ELECTRICIANS AND ENGINEERS.

Pocket Size. Leather, 8s. 6d. *Thirteenth Edition.*

LONDON: CHARLES GRIFFIN & CO., LIMITED, EXETER STREET, STRAND.

SECOND EDITION. *Enlarged, and very fully Illustrated. Cloth, 4s. 6d.*

STEAM - BOILERS :

THEIR DEFECTS, MANAGEMENT, AND CONSTRUCTION.

By R. D. MUNRO,

Chief Engineer of the Scottish Boiler Insurance and Engine Inspection Company.

GENERAL CONTENTS.—I. EXPLOSIONS caused (1) by Overheating of Plates—(2) By Defective and Overloaded Safety Valves—(3) By Corrosion, Internal or External—(4) By Defective Design and Construction (Unsupported Flue Tubes; Unstrengthened Manholes; Defective Staying; Strength of Rivetted Joints; Factor of Safety)—II. CONSTRUCTION OF VERTICAL BOILERS: Shells—Crown Plates and Uptake Tubes—Man-Holes, Mud-Holes, and Fire-Holes—Fireboxes—Mountings—Management—Cleaning—Table of Bursting Pressures of Steel Boilers—Table of Rivetted Joints—Specifications and Drawings of Lancashire Boiler for Working Pressures (a) 80 lbs.; (b) 200 lbs. per square inch respectively.

This work contains information of the first importance to every user of Steam-power. It is a PRACTICAL work written for PRACTICAL men, the language and rules being throughout of the simplest nature.

"A valuable companion for workmen and engineers engaged about Steam Boilers, ought to be carefully studied, and ALWAYS AT HAND."—*Coll. Guardian.*

"The book is VERY USEFUL, especially to steam users, artisans, and young engineers."—*Engineer.*

BY THE SAME AUTHOR.

KITCHEN BOILER EXPLOSIONS: Why they Occur, and How to Prevent their Occurrence. A Practical Handbook based on Actual Experiment. With Diagrams and Coloured Plate, Price 3s.

NYSTROM'S POCKET-BOOK OF MECHANICS AND ENGINEERING. Revised and Corrected by W. DENNIS MARKS, Ph. B., C. E. (YALE S.S.S.), Whitney Professor of Dynamical Engineering, University of Pennsylvania. Pocket Size. Leather, 15s. TWENTIETH EDITION, Revised and greatly enlarged.

LONDON: CHARLES GRIFFIN & CO., LIMITED, EXETER STREET, STRAND.

In Large Svo., Handsome Cloth. With numerous Plates reduced from Working Drawings and Illustrations in the Text.

THE DESIGN AND CONSTRUCTION
OF
LOCOMOTIVE ENGINES.
WITH AN HISTORICAL INTRODUCTION.
A PRACTICAL TEXT-BOOK

For the Use of Engine Builders, Designers, and Draughtsmen,
Railway Engineers, and Students.

BY

WILLIAM FRANK PETTIGREW, M.INST.C.E.

With a Section on American and Continental Engines.

BY

ALBERT F. RAVENSHEAR, B.Sc.,

Of Her Majesty's Patent Office.

Large Crown Svo. With numerous Illustrations.

ENGINE-ROOM PRACTICE:
A HANDBOOK FOR

Engineers and Officers in the Royal Navy and
Mercantile Marine:

INCLUDING THE MANAGEMENT OF THE MAIN AND
AUXILIARY ENGINES ON BOARD SHIP.

BY

JOHN G. LIVERSIDGE,

Engineer, R. N., A.M.I.C.E., Instructor in Applied Mechanics at the Royal Naval
College, Greenwich.

LONDON: CHARLES GRIFFIN & CO., LIMITED, EXETER STREET, STRAND.

WORKS BY

W. J. MACQUORN RANKINE, LL.D., F.R.S.,

Late Regius Professor of Civil Engineering in the University of Glasgow.

THOROUGHLY REVISED BY

W. J. MILLAR, C.E.,

late Secretary to the Institute of Engineers and Shipbuilders in Scotland.

I. A MANUAL OF APPLIED MECHANICS :

Comprising the Principles of Statics and Cinematics, and Theory of Structures, Mechanism, and Machines. With Numerous Diagrams. Crown 8vo, cloth, 12s. 6d. FIFTEENTH EDITION.

II. A MANUAL OF CIVIL ENGINEERING :

Comprising Engineering Surveys, Earthwork, Foundations, Masonry, Carpentry, Metal Work, Roads, Railways, Canals, Rivers, Waterworks, Harbours, &c. With Numerous Tables and Illustrations. Crown 8vo, cloth, 16s. TWENTIETH EDITION.

III. A MANUAL OF MACHINERY AND MILLWORK :

Comprising the Geometry, Motions, Work, Strength, Construction, and Objects of Machines, &c. Illustrated with nearly 300 Woodcuts. Crown 8vo, cloth, 12s. 6d. SEVENTH EDITION.

IV. A MANUAL OF THE STEAM-ENGINE AND OTHER
PRIME MOVERS :

With a Section on GAS, OIL, and AIR ENGINES. By BRYAN DONKIN, M.Inst.C.E. With Folding Plates and Numerous Illustrations. Crown 8vo, cloth, 12s. 6d. FOURTEENTH EDITION.

PROF. RANKINE'S WORKS—(*Continued*).

V. USEFUL RULES AND TABLES :

For Architects, Builders, Engineers, Founders, Mechanics, Shipbuilders, Surveyors, &c. With APPENDIX for the use of ELECTRICAL ENGINEERS. By Professor JAMIESON, F.R.S.E. SEVENTH EDITION. 10s. 6d.

VI. A MECHANICAL TEXT-BOOK :

A Practical and Simple Introduction to the Study of Mechanics. By Professor RANKINE and E. F. BAMBER, C.E. With Numerous Illustrations. Crown 8vo, cloth, 9s. FOURTH EDITION.

*. The "MECHANICAL TEXT-BOOK" was designed by Professor RANKINE as an INTRODUCTION to the above Series of Manuals.

VII. MISCELLANEOUS SCIENTIFIC PAPERS.

Royal 8vo. Cloth, 31s. 6d.

Part I. Papers relating to Temperature, Elasticity, and Expansion of Vapours, Liquids, and Solids. Part II. Papers on Energy and its Transformations. Part III. Papers on Wave-Forms, Propulsion of Vessels, &c.

With Memoir by Professor TAIT, M.A. Edited by W. J. MILLAR, C.E. With fine Portrait on Steel, Plates, and Diagrams.

"No more enduring Memorial of Professor Rankine could be devised than the publication of these papers in an accessible form. . . . The Collection is most valuable on account of the nature of his discoveries, and the beauty and completeness of his analysis. . . . The Volume exceeds in importance any work in the same department published in our time."—*Architect*.

SHELTON-BEY (W. Vincent, Foreman to the Imperial Ottoman Gun Factories, Constantinople) :

THE MECHANIC'S GUIDE: A Hand-Book for Engineers and Artizans. With Copious Tables and Valuable Recipes for Practical Use. Illustrated. *Second Edition*. Crown 8vo. Cloth, 7/6.

LONDON : CHARLES GRIFFIN & CO., LIMITED, EXETER STREET, STRAND.

SECOND EDITION, Revised and Enlarged.
In Large 8vo, Handsome cloth, 34s.

HYDRAULIC POWER

AND

HYDRAULIC MACHINERY.

BY

HENRY ROBINSON, M. INST. C.E., F.G.S.,

ELLOW OF KING'S COLLEGE, LONDON; PROF. OF CIVIL ENGINEERING,
KING'S COLLEGE, ETC., ETC.

With numerous Woodcuts, and Sixty-nine Plates.

GENERAL CONTENTS.

Discharge through Orifices—Gauging Water by Weirs—Flow of Water through Pipes—The Accumulator—The Flow of Solids—Hydraulic Presses and Lifts—Cyclone Hydraulic Baling Press—Anderton Hydraulic Lift—Hydraulic Hoists (Lifts)—The Otis Elevator—Mersey Railway Lifts—City and South London Railway Lifts—North Huddon County Railway Elevator—Lifts for Subways—Hydraulic Ram—Pearsall's Hydraulic Engine—Pumping Engines—Three-Cylinder Engines—Brotherhood Engine—Rigg's Hydraulic Engine—Hydraulic Capstans—Hydraulic Traversers—Movable Jigger Hoist—Hydraulic Waggon Drop—Hydraulic Jack—Duckham's Weighing Machine—Shop Tools—Tweddell's Hydraulic Rivetter—Hydraulic Joggling Press—Tweddell's Punching and Shearing Machine—Flanging Machine—Hydraulic Centre Crane—Wrightson's Balance Crane—Hydraulic Power at the Forth Bridge—Cranes—Hydraulic Coal-Discharging Machines—Hydraulic Drill—Hydraulic Manhole Cutter—Hydraulic Drill at St. Gothard Tunnel—Motors with Variable Power—Hydraulic Machinery on Board Ship—Hydraulic Points and Crossings—Hydraulic Pile Driver—Hydraulic Pile Screwing Apparatus—Hydraulic Excavator—Ball's Pump Dredger—Hydraulic Power applied to Bridges—Dock-gate Machinery—Hydraulic Brake—Hydraulic Power applied to Gunnery—Centrifugal Pumps—Water Wheels—Turbines—Jet Propulsion—The Gerard-Barré Hydraulic Railway—Greathead's Injector Hydrant—Snell's Hydraulic Transport System—Greathead's Shield—Grain Elevator at Frankfurt—Packing—Power Co-operation—Hull Hydraulic Power Company—London Hydraulic Power Company—Birmingham Hydraulic Power System—Niagara Falls—Cost of Hydraulic Power—Meters—Schönheyder's Pressure Regulator—Deacon's Waste-Water Meter.

"A Book of great Professional Usefulness."—*Iron.*

* * The SECOND EDITION of the above important work has been thoroughly revised and brought up to date. Many new full-page Plates have been added—the number being increased from 48 in the First Edition to 69 in the present.

LONDON: CHARLES GRIFFIN & CO., LIMITED, EXETER STREET, STRAND.

Royal 8vo, Handsome Cloth, 25s.

THE STABILITY OF SHIPS.

BY

SIR EDWARD J. REED, K.C.B., F.R.S., M.P.,

KNIGHT OF THE IMPERIAL ORDERS OF ST. STANILAUS OF RUSSIA; FRANCIS JOSEPH OF AUSTRIA; MEDJIDIE OF TURKEY; AND RISING SUN OF JAPAN; VICE-PRESIDENT OF THE INSTITUTION OF NAVAL ARCHITECTS.

With numerous Illustrations and Tables.

THIS work has been written for the purpose of placing in the hands of Naval Constructors, Shipbuilders, Officers of the Royal and Mercantile Marines, and all Students of Naval Science, a complete Treatise upon the Stability of Ships, and is the only work in the English Language dealing exhaustively with the subject.

In order to render the work complete for the purposes of the Shipbuilder, whether at home or abroad, the Methods of Calculation introduced by Mr. F. K. BARNES, Mr. GRAY, M. REECH, M. DAYMARD, and Mr. BENJAMIN, are all given separately, illustrated by Tables and worked-out examples. The book contains more than 200 Diagrams, and is illustrated by a large number of actual cases, derived from ships of all descriptions, but especially from ships of the Mercantile Marine.

The work will thus be found to constitute the most comprehensive and exhaustive Treatise hitherto presented to the Profession on the Science of the STABILITY OF SHIPS.

"Sir EDWARD REED'S 'STABILITY OF SHIPS' is INVALUABLE. In it the STUDENT, new to the subject, will find the path prepared for him, and all difficulties explained with the utmost care and accuracy; the SHIP-DRAUGHTSMAN will find all the methods of calculation at present in use fully explained and illustrated, and accompanied by the Tables and Forms employed; the SHIPOWNER will find the variations in the Stability of Ships due to differences in forms and dimensions fully discussed, and the devices by which the state of his ships under all conditions may be graphically represented and easily understood; the NAVAL ARCHITECT will find brought together and ready to his hand, a mass of information which he would otherwise have to seek in an almost endless variety of publications, and some of which he would possibly not be able to obtain at all elsewhere."—*Steamship*.

"This IMPORTANT AND VALUABLE WORK . . . cannot be too highly recommended to all connected with shipping interests."—*Iron*.

"This VERY IMPORTANT TREATISE, . . . the MOST INTELLIGIBLE, INSTRUCTIVE, and COMPLETE that has ever appeared."—*Nature*.

"The volume is an ESSENTIAL ONE for the shipbuilding profession."—*Westminster Review*.

COMPANION-WORK.

THE DESIGN AND CONSTRUCTION OF SHIPS.

By JOHN HARVARD BILES, M.Inst.N.A.,

Professor of Naval Architecture in the University of Glasgow.

In Active Preparation.

LONDON: CHARLES GRIFFIN & CO., LIMITED, EXETER STREET, STRAND.

Thirteenth Edition. Price 21s.

Demy 8vo, Cloth. With Numerous Illustrations, reduced from Working Drawings.

A MANUAL OF MARINE ENGINEERING:

COMPRISING THE DESIGNING, CONSTRUCTION, AND
WORKING OF MARINE MACHINERY.

By A. E. SEATON, M. Inst. C. E., M. Inst. Mech. E.,
M. Inst. N. A.

GENERAL CONTENTS.

Part I.—Principles of Marine Propulsion.	Calculations for Cylinders, Pistons, Valves, Expansion Valves, &c.
Part II.—Principles of Steam Engineering.	Part IV.—Propellers.
Part III.—Details of Marine Engines: Design and Cal-	Part V.—Boilers.
	Part VI.—Miscellaneous.

. The THIRTEENTH EDITION includes a Chapter on WATER-TUBE BOILERS, with Illustrations of the leading Types.

"In the three-fold capacity of enabling a Student to learn how to design, construct, and work a Marine Steam-Engine, Mr. Seaton's Manual has NO RIVAL."—*Times*.

"The important subject of Marine Engineering is here treated with the THOROUGHNESS that it requires. No department has escaped attention. . . . Gives the results of much close study and practical work."—*Engineering*.

"By far the BEST MANUAL in existence. . . . Gives a complete account of the methods of solving, with the utmost possible economy, the problems before the Marine Engineer."—*Athenæum*.

"The Student, Draughtsman, and Engineer will find this work the MOST VALUABLE HANDBOOK of Reference on the Marine Engine now in existence."—*Marine Engineer*.

FOURTH EDITION. With Diagrams. Pocket-Size, Leather. 8s. 6d.

A POCKET-BOOK OF

MARINE ENGINEERING RULES AND TABLES,

FOR THE USE OF

Marine Engineers, Naval Architects, Designers, Draughtsmen,
Superintendents and Others.

BY

A. E. SEATON, M. I. C. E., M. I. Mech. E., M. I. N. A.,

AND

H. M. ROUNTHWAITE, M. I. Mech. E., M. I. N. A.

"ADMIRABLY FULFILLS its purpose."—*Marine Engineer*.

LONDON: CHARLES GRIFFIN & CO., LIMITED, EXETER STREET, STRAND.

WORKS BY PROF. ROBERT H. SMITH, Assoc.M.I.C.E.,
M.I.M.E., M.I.E.I.E., M.Fed.I.M.I.E., Whit. Sch., M.Ord.Meiji.

THE CALCULUS FOR ENGINEERS AND PHYSICISTS,

Applied to Technical Problems.

WITH EXTENSIVE

CLASSIFIED REFERENCE LIST OF INTEGRALS.

By PROF. ROBERT H. SMITH.

ASSISTED BY

R. F. MUIRHEAD, M.A., B.Sc.,

Formerly Clark Fellow of Glasgow University, and Lecturer on Mathematics at
Mason College.

In Crown 8vo, extra, with Diagrams and Folding-Plate. 8s. 6d.

"Prof. R. H. SMITH's book will be serviceable in rendering a hard road as easy as PRACTICABLE for the non-mathematical Student and Engineer."—*Athenæum*.

"Interesting diagrams, with practical illustrations of actual occurrence, are to be found here in abundance. THE VERY COMPLETE CLASSIFIED REFERENCE TABLE will prove very useful in saving the time of those who want an integral in a hurry."—*The Engineer*.

MEASUREMENT CONVERSIONS

(English and French):

28 GRAPHIC TABLES OR DIAGRAMS.

Showing at a glance the MUTUAL CONVERSION of MEASUREMENTS
in DIFFERENT UNITS

Of Lengths, Areas, Volumes, Weights, Stresses, Densities, Quantities
of Work, Horse Powers, Temperatures, &c.

For the use of Engineers, Surveyors, Architects, and Contractors.

In 4to, Boards. 7s. 6d.

* * Prof. SMITH'S CONVERSION-TABLES form the most unique and comprehensive collection ever placed before the profession. By their use much time and labour will be saved, and the chances of error in calculation diminished. It is believed that henceforth no Engineer's Office will be considered complete without them.

"The work is INVALUABLE."—*Colliery Guardian*.

"Ought to be in EVERY office where even occasional conversions are required. . . . Prof. SMITH'S TABLES form very EXCELLENT CHECKS on results."—*Electrical Review*.

"Prof. Smith deserves the hearty thanks, not only of the ENGINEER, but of the COMMERCIAL WORLD, for having smoothed the way for the ADOPTION of the METRIC SYSTEM of MEASUREMENT, a subject which is now assuming great importance as a factor in maintaining our HOLD upon FOREIGN TRADE."—*The Machinery Market*.

LONDON: CHARLES GRIFFIN & CO., LIMITED, EXETER STREET, STRAND.

THIRD EDITION, Revised and Enlarged. Pocket-Size, Leather, 12s 6d.; also Larger Size for Office Use, Cloth, 12s. 6d.

Boilers, Marine and Land:

THEIR CONSTRUCTION AND STRENGTH.

A HANDBOOK OF RULES, FORMULÆ, TABLES, &C., RELATIVE TO MATERIAL, SCANTLINGS, AND PRESSURES, SAFETY VALVES, SPRINGS, FITTINGS AND MOUNTINGS, &C.

FOR THE USE OF ENGINEERS, SURVEYORS, BOILER-MAKERS, AND STEAM USERS.

BY T. W. TRAILL, M. INST. C. E., F. E. R. N.,
Late Engineer Surveyor-in-Chief to the Board of Trade.

* * TO THE SECOND AND THIRD EDITIONS MANY NEW TABLES FOR PRESSURES up to 200 LBS. per SQUARE INCH have been added.

"THE MOST VALUABLE WORK ON Boilers published in England."—*Shipping World*.

"Very unlike any of the numerous treatises on Boilers which have preceded it. . . . Really useful. . . . Contains an ENORMOUS QUANTITY OF INFORMATION arranged in a very convenient form. . . . Those who have to design boilers will find that they can settle the dimensions for any given pressure with almost no calculation with its aid. . . . A MOST USEFUL VOLUME . . . supplying information to be had nowhere else."—*The Engineer*.

"As a handbook of rules, formulæ, tables, &c., relating to materials, scantlings, and pressures, this work will prove MOST USEFUL. The name of the Author is a sufficient guarantee for its accuracy. It will save engineers, inspectors, and draughtsmen a vast amount of calculation."—*Nature*.

"By such an authority cannot but prove a welcome addition to the literature of the subject. . . . We can strongly recommend it as being the MOST COMPLETE, eminently practical work on the subject."—*Marine Engineer*.

"To the engineer and practical boiler-maker it will prove INVALUABLE. The tables in all probability are the most exhaustive yet published . . . Certainly deserves a place on the shelf in the drawing office of every boiler shop."—*Practical Engineer*.

LIGHT RAILWAYS

AT HOME AND ABROAD.

BY WILLIAM HENRY COLE, M. INST. C. E.,
Late Deputy-Manager, Eastern Bengal and North-Western State Railways, P. W. D., India.

In Large 8vo. Handsome Cloth. With Illustrations.

[Griffin's Engineering Series.]

LONDON: CHARLES GRIFFIN & CO., LIMITED, EXETER STREET, STRAND.

In Crown 8vo, extra, with Numerous Illustrations. [Shortly

GAS AND OIL ENGINES:

AN INTRODUCTORY TEXT-BOOK

On the Theory, Design, Construction, and Testing of Internal
Combustion Engines without Boiler.

FOR THE USE OF STUDENTS.

BY

PROF. W. H. WATKINSON, WHIT. SCH., M. INST. MECH. E.,
Glasgow and West of Scotland Technical College.

Engineering Drawing and Design

(A TEXT-BOOK OF).

SECOND EDITION. In Two Parts, Published Separately.

VOL. I.—PRACTICAL GEOMETRY, PLANE, AND SOLID. 3s.

VOL. II.—MACHINE AND ENGINE DRAWING AND DESIGN. 4s. 6d.

BY

SIDNEY H. WELLS, WH. SC.,

A. M. INST. C. E., A. M. INST. MECH. E.,

Principal of, and Head of the Engineering Department in, the Battersea Polytechnic Institute,
formerly of the Engineering Departments of the Yorkshire College, Leeds;
and Dulwich College, London.

*With many Illustrations, specially prepared for the Work, and numerous
Examples, for the Use of Students in Technical Schools and Colleges.*

"A THOROUGHLY USEFUL WORK, exceedingly well written. For the many Examples and Questions we have nothing but praise."—*Nature*.

"A CAPITAL TEXT-BOOK, arranged on an EXCELLENT SYSTEM, calculated to give an intelligent grasp of the subject, and not the mere faculty of mechanical copying. . . . Mr. Wells shows how to make COMPLETE WORKING-DRAWINGS, discussing fully each step in the design."—*Electrical Review*.

"The first book leads EASILY and NATURALLY towards the second, where the technical pupil is brought into contact with large and more complex designs."—*The Schoolmaster*.

LONDON: CHARLES GRIFFIN & CO., LIMITED, EXETER STREET, STRAND.

MUNRO & JAMIESON'S ELECTRICAL POCKET-BOOK.

THIRTEENTH EDITION, Revised and Enlarged.

A POCKET-BOOK

OF

ELECTRICAL RULES & TABLES

FOR THE USE OF ELECTRICIANS AND ENGINEERS.

BY JOHN MUNRO, C.E., & PROF. JAMIESON, M.Inst.C.E., F.R.S.E.

With Numerous Diagrams. Pocket Size. Leather, 8s. 6d.

GENERAL CONTENTS.

UNITS OF MEASUREMENT.
MEASURES.
TESTING.
CONDUCTORS.
DIELECTRICS.
SUBMARINE CABLES.
TELEGRAPHY.
ELECTRO-CHEMISTRY.

ELECTRO-METALLURGY.
BATTERIES.
DYNAMOS AND MOTORS.
TRANSFORMERS.
ELECTRIC LIGHTING.
MISCELLANEOUS.
LOGARITHMS.
APPENDICES.

"WONDERFULLY PERFECT. . . . Worthy of the highest commendation we can give it." *Electrician*.

"THE STERLING VALUE of Messrs. MUNRO and JAMIESON'S POCKET-BOOK."—*Electrical Review*.

Electrical Measurements & Instruments.*A Practical Hand-book of Testing for the Electrical Engineer.*

BY CHARLES H. YEAMAN,

Assoc. Inst. E.E., formerly Electrical Engineer to the Corporation of Liverpool.

SECOND EDITION, 8s. 6d. Leather, for the Pocket, 8s. 6d.

GRIFFIN'S ELECTRICAL PRICE-BOOK.

For Electrical, Civil, Marine, and Borough Engineers, Local Authorities, Architects, Railway Contractors, &c., &c.

EDITED BY H. J. DOWSING,

Member of the Institution of Electrical Engineers; of the Society of Arts; of the London Chamber of Commerce, &c.

"THE ELECTRICAL PRICE-BOOK REMOVES ALL MYSTERY about the cost of Electrical Power. By its aid the EXPENSE that will be entailed by utilising electricity on a large or small scale can be discovered."—*Architect*.

"THE VALUE of this Electrical Price-Book CANNOT BE OVER-ESTIMATED. . . . Will save time and trouble both to the engineer and the business man."—*Machinery*.

LONDON: CHARLES GRIFFIN & CO., LIMITED, EXETER STREET, STRAND.

By PROFESSORS J. J. THOMSON & POYNTING.

In Large 8vo. Fully Illustrated.

A TEXT-BOOK OF PHYSICS :

COMPRISING

*PROPERTIES OF MATTER; SOUND; HEAT; MAGNETISM
AND ELECTRICITY; AND LIGHT.*

BY

J. H. POYNTING,

Sc.D., F.R.S.,

Late Fellow of Trinity College, Cambridge;
Professor of Physics, Mason College,
Birmingham.

AND

J. J. THOMSON,

M.A., F.R.S.,

Fellow of Trinity College, Cambridge; Prof.
of Experimental Physics in the University
of Cambridge.

* * *Publishers' Note.*—It is intended that this IMPORTANT and LONG-EXPECTED TREATISE shall be issued in separate Volumes, each complete in itself, and published at regular intervals, beginning with SOUND, now at Press.

In large 8vo, with Bibliography, Illustrations in the Text, and seven
Lithographed Plates. 12s. 6d.

THE MEAN DENSITY OF THE EARTH :

An Essay to which the Adams Prize was adjudged in 1893 in
the University of Cambridge.

BY

J. H. POYNTING, Sc.D., F.R.S.,

Late Fellow of Trinity College, Cambridge; Professor of Physics, Mason
College, Birmingham.

"An account of this subject cannot fail to be of GREAT and GENERAL INTEREST to the scientific mind. Especially is this the case when the account is given by one who has contributed so considerably as has Prof. Poynting to our present state of knowledge with respect to a very difficult subject. . . . Remarkably has Newton's estimate been verified by Prof. Poynting."—*Athenæum*.

LONDON: CHARLES GRIFFIN & CO., LIMITED, EXETER STREET, STRAND.

§ 6. GRIFFIN'S NAUTICAL SERIES.

EDITED BY EDW. BLACKMORE,
Master Mariner, First Class Trinity House Certificate, Assoc. Inst. N.A. ;
AND WRITTEN, MAINLY, by SAILORS for SAILORS.

"This ADMIRABLE SERIES."—*Fairplay*. "A VERY USEFUL SERIES."—*Nature*.
"The volumes of MESSRS. GRIFFIN'S NAUTICAL SERIES may well and profitably be
read by ALL interested in OUR NATIONAL MARITIME PROGRESS."—*Marine Engineer*.
"EVERY SHIP should have the WHOLE SERIES as a REFERENCE LIBRARY. HAND-
SOMELY BOUND, CLEARLY PRINTED and ILLUSTRATED."—*Liverpool Journ. of Commerce*.

The Legal Duties of Shipmasters. By BENEDICT WM. GINSBURG,
M.A., LL.D., of the Inner Temple and Northern Circuit: Barrister-at-Law.
Price 4s. 6d. Postage 4d. [Just Published.]

**The British Mercantile Marine: An Historical Sketch of its Rise
and Development.** By the EDITOR, CAPT. BLACKMORE. 3s. 6d. Postage 4d.
"This ADMIRABLE book . . . TERMS with useful information. Should be in
the hands of every Sailor."—*Western Morning News*.

Elementary Seamanship. By D. WILSON-BARKER, Master Mariner,
F.R.S.E., F.R.G.S. With numerous Plates, two in Colours, and Frontispiece. 5s.
Postage 4d.
"This ADMIRABLE MANUAL, by CAPT. WILSON BARKER, of the 'Worcester,' seems
to us PERFECTLY DESIGNED."—*Athenæum*.

**Know Your Own Ship: A Simple Explanation of the Stability, Con-
struction, Tonnage, and Freeboard of Ships.** By THOS. WALTON, Naval Architect.
With numerous Illustrations. THIRD EDITION. 5s. Postage 4d.
"MR. WALTON'S book will be found VERY USEFUL."—*The Engineer*.

The Construction and Maintenance of Vessels built of Steel.
By THOS. WALTON, Naval Architect. [Shortly.]

Navigation: Theoretical and Practical. By D. WILSON-BARKER,
Master Mariner, &c., and WILLIAM ALLINGHAM. 3s. 6d. Postage 3d.
"PRECISELY the kind of work required for the New Certificates of competency.
Candidates will find it INVALUABLE."—*Dundee Advertiser*.

Latitude and Longitude: How to find them. By W. J. MILLAR,
C.E., late Sec. to the Inst. of Engineers and Shipbuilders in Scotland. 2s.
Postage 3d.
"Cannot but prove an acquisition to those studying Navigation."—*Marine Engineer*.

Practical Mechanics: Applied to the requirements of the Sailor.
By THOS. MACKENZIE, Master Mariner, F.R.A.S. 3s. 6d. Postage 3d.
"WELL WORTH the money . . . EXCEEDINGLY HELPFUL."—*Shipping World*.

Ocean Meteorology: For Officers of the Merchant Navy. By
WILLIAM ALLINGHAM, First Class Honours, Navigation, Science and Art Department.
[Shortly.]

Trigonometry: For the Young Sailor, &c. By RICH. C. BUCK, of the
Thames Nautical Training College, H.M.S. "Worcester." Price 3s. 6d. Postage 3d.
"This EMINENTLY PRACTICAL and RELIABLE volume."—*Schoolmaster*.

Practical Algebra. By RICH. C. BUCK. [Shortly.]

A Medical and Surgical Help for Shipmasters. Including "First
Aid at Sea. By WM. JOHNSON SMITH, F.R.C.S., Principal Medical Officer, Seaman's
Hospital, Greenwich. 6s. Postage 4d.
"SOUND, JUDICIOUS, REALLY HELPFUL."—*The Lancet*.

LONDON: CHARLES GRIFFIN & CO., LIMITED, EXETER STREET, STRAND.

GRIFFIN'S NAUTICAL SERIES.

Crown 8vo, with Numerous Illustrations. Handsome Cloth. 3s. 6d

Practical Mechanics :

Applied to the Requirements of the Sailor.

BY THOS. MACKENZIE,

Master Mariner, F.R.A.S.

GENERAL CONTENTS.—Resolution and Composition of Forces—Work done by Machines and Living Agents—The Mechanical Powers: The Lever; Derricks as Bent Levers—The Wheel and Axle: Windlass; Ship's Capstan; Crab Winch—Tackles: the "Old Man"—The Inclined Plane; the Screw—The Centre of Gravity of a Ship and Cargo—Relative Strength of Rope: Steel Wire, Manilla, Hemp, Coir—Derricks and Shears—Calculation of the Cross-breaking Strain of Fir Spar—Centre of Effort of Sails—Hydrostatics: the Diving-bell; Stability of Floating Bodies; the Ship's Pump, &c.

"THIS EXCELLENT BOOK . . . contains a LARGE AMOUNT of information."
—*Nature*.

"WELL WORTH the money . . . will be found EXCEEDINGLY HELPFUL."
Shipping World.

"NO SHIPS' OFFICERS' BOOKCASE will henceforth be complete without CAPTAIN MACKENZIE'S 'PRACTICAL MECHANICS.' Notwithstanding my many years' experience at sea, it has told me *how much more there is to acquire*."
(Letter to the Publishers from a Master Mariner).

"I must express my thanks to you for the labour and care you have taken in 'PRACTICAL MECHANICS.' . . . IT IS A LIFE'S EXPERIENCE. . . . What an amount we frequently see wasted by rigging purchases without reason and accidents to spars, &c., &c.! 'PRACTICAL MECHANICS' WOULD SAVE ALL THIS."—(Letter to the Author from another Master Mariner).

Crown 8vo, with Diagrams. 2s.

Latitude and Longitude :**How to Find them.**

BY W. J. MILLAR, C.E.,

Late Secretary to the Inst. of Engineers and Shipbuilders in Scotland.

"CONCISELY and CLEARLY WRITTEN . . . cannot but prove an acquisition to those studying Navigation."—*Marine Engineer*.

"Young Seamen will find it HANDY and USEFUL, SIMPLE and CLEAR."—*The Engineer*.

* * For Complete List of GRIFFIN'S NAUTICAL SERIES, see p. 4b.

LONDON: CHARLES GRIFFIN & CO., LIMITED, EXETER STREET, STRAND.

GRIFFIN'S NAUTICAL SERIES.

In Crown 8vo. Handsome Cloth. 4s. 6d.

THE LEGAL DUTIES OF SHIPMASTERS.

BY

BENEDICT WM. GINSBURG, M.A., LL.D. (CANTAB.);
Of the Inner Temple and Northern Circuit; Barrister-at-Law.

General Contents.—The Qualification for the Position of Shipmaster—The Contract with the Shipowner—The Master's Duty in respect of the Crew: Engagement: Apprentices; Discipline; Provisions, Accommodation, and Medical Comforts: Payment of Wages and Discharge—The Master's Duty in respect of the Passengers—The Master's Financial Responsibilities—The Master's Duty in respect of the Cargo—The Master's Duty in Case of Casualty—The Master's Duty to certain Public Authorities—The Master's Duty in relation to Pilots, Signals, Flags, and Light Dues—The Master's Duty upon Arrival at the Port of Discharge—Appendices relative to certain Legal Matters: Board of Trade Certificates, Dietary Scales, Stowage of Grain Cargoes, Load Line Regulations, Life-saving Appliances, Carriage of Cattle at Sea, &c., &c.—Copious Index.

"No Intelligent Master should fail to add this to his list of useful and necessary books. The price (4s. 6d.) cannot be quoted as an excuse for non-possession, and a few lines of it may SAVE A LAWYER'S FEE, BESIDES ENDLESS WORRY."—*Liverpool Journal of Commerce.*

"SENSIBLE, plainly written, in CLEAR and NON-TECHNICAL LANGUAGE, and will be found of MUCH SERVICE by the Shipmaster."—*British Trade Review.*

FIRST AID AT SEA.

With Coloured Plates and Numerous Illustrations. 6s.

**A MEDICAL AND SURGICAL HELP
FOR SHIPMASTERS AND OFFICERS
IN THE MERCHANT NAVY.**

BY

WM. JOHNSON SMITH, F.R.C.S.,
Principal Medical Officer, Seamen's Hospital, Greenwich.

"* * The attention of all interested in our Merchant Navy is requested to this exceedingly useful and valuable work. It is needless to say that it is the outcome of many years PRAGMATICAL EXPERIENCE amongst Seamen.

"SOUND, JUDICIOUS, REALLY HELPFUL."—*The Lancet.*

**OCEAN METEOROLOGY
FOR OFFICERS OF THE MERCHANT NAVY.**

BY

WILLIAM ALLINGHAM,
Joint-Author of "Navigation, Theoretical and Practical."

* * For Complete List of GRIFFIN'S NAUTICAL SERIES, see p. 45.

LONDON: CHARLES GRIFFIN & CO., LIM.TED, EXETER STREET, STRAND.

Demy 8vo, Handsome cloth, 18s.

Physical Geology and Palæontology,

ON THE BASIS OF PHILLIPS.

BY

HARRY GOVIER SEELEY, F. R. S.,
PROFESSOR OF GEOGRAPHY IN KING'S COLLEGE, LONDON.

With Frontispiece in Chromo-Lithography, and Illustrations.

"It is impossible to praise too highly the research which PROFESSOR SEELEY'S 'PHYSICAL GEOLOGY' evidences. IT IS FAR MORE THAN A TEXT-BOOK—it is a DIRECTORY to the Student in prosecuting his researches."—*Presidential Address to the Geological Society, 1885, by Rev. Prof. Bonney, D.Sc., LL.D., F.R.S.*

"PROFESSOR SEELEY maintains in his 'PHYSICAL GEOLOGY' the high reputation he already deservedly bears as a Teacher."—*Dr. Henry Woodward, F.R.S., in the "Geological Magazine."*

"PROFESSOR SEELEY'S work includes one of the most satisfactory Treatises on Lithology in the English language. . . . So much that is not accessible in other works is presented in this volume, that no Student of Geology can afford to be without it."—*American Journal of Engineering.*

Demy 8vo, Handsome cloth, 34s.

Stratigraphical Geology & Palæontology,

ON THE BASIS OF PHILLIPS.

BY

ROBERT ETHERIDGE, F. R. S.,

OF THE NATURAL HIST. DEPARTMENT, BRITISH MUSEUM, LATE PALÆONTOLOGIST TO THE
GEOLOGICAL SURVEY OF GREAT BRITAIN, PAST PRESIDENT OF THE
GEOLOGICAL SOCIETY, ETC.

With Map, Numerous Tables, and Thirty-six Plates.

"No such compendium of geological knowledge has ever been brought together before."—*Westminster Review.*

"If PROF. SEELEY'S volume was remarkable for its originality and the breadth of its views, MR. ETHERIDGE fully justifies the assertion made in his preface that his book differs in construction and detail from any known manual. . . . Must take HIGH RANK AMONG WORKS OF REFERENCE."—*Athenæum.*

LONDON: CHARLES GRIFFIN & CO., LIMITED, EXETER STREET, STRAND.

Works by **GRENVILLE A. J. COLE, M.R.I.A., F.G.S.**,
 Professor of Geology in the Royal College of Science for Ireland.

PRACTICAL GEOLOGY (AIDS IN):

WITH A SECTION ON PALÆONTOLOGY.

By PROFESSOR GRENVILLE COLE, M.R.I.A., F.G.S.

THIRD EDITION, Revised and in part Re-written. With Frontispiece
 and Illustrations. Cloth, 10s. 6d.

GENERAL CONTENTS.—

PART I.—SAMPLING OF THE EARTH'S CRUST.

PART II.—EXAMINATION OF MINERALS.

PART III.—EXAMINATION OF ROCKS.

PART IV.—EXAMINATION OF FOSSILS.

"Prof. Cole treats of the examination of minerals and rocks in a way that has never been attempted before . . . DESERVING OF THE HIGHEST PRAISE. Here indeed are 'Aids' INNUMERABLE and INVALUABLE. All the directions are given with the utmost clearness and precision."—*Athenæum*.

"To the younger workers in Geology, Prof. Cole's book will be as INDISPENSABLE as a dictionary to the learners of a language."—*Saturday Review*.

"That the work deserves its title, that it is full of 'AIDS,' and in the highest degree 'PRACTICAL,' will be the verdict of all who use it."—*Nature*.

"This EXCELLENT MANUAL . . . will be a VERY GREAT HELP. . . . The section on the Examination of Fossils is probably the BEST of its kind yet published. . . . FULL of well-digested information from the newest sources and from personal research."—*Annals of Nat. History*.

OPEN-AIR STUDIES:

An Introduction to Geology Out-of-doors.

By PROFESSOR GRENVILLE COLE, M.R.I.A., F.G.S.

With 12 Full-Page Illustrations from Photographs.
 Cloth, 8s. 6d.

For details, see p. 86.

Edited by PROFESSOR COLE.

The "New Land" Series for Colonists and Prospectors

(See next page).

LONDON: CHARLES GRIFFIN & CO., LIM.TED, EXETER STREET, STRAND.

The "New Land" Series

OF

Practical Hand-Books

For the Use of Prospectors, Explorers, Settlers,
Colonists, and all interested in the opening
up and Development of New Lands.

EDITED BY

GRENVILLE A. J. COLE, M.R.I.A., F.G.S.,
Professor of Geology in the Royal College of Science for Ireland.
In large Crown 8vo, with Illustrations.

VOL. 1.—PROSPECTING FOR MINERALS. By S.
HERBERT COX, Assoc.R.S.M., M.Inst.M.M., F.G.S. (p. 55).

VOL. 2.—FOOD SUPPLY. By ROBERT BRUCE, Agricultural
Superintendent to the Royal Dublin Society. With many
Engravings from Photographs illustrating the chief Breeds
of Cattle, Sheep, Pigs, Poultry, &c. 4s. 6d.

GENERAL CONTENTS.—Climate and Soil—Drainage and Rotation of
Crops—Seeds and Crops—Vegetables and Fruits—Cattle and Cattle-
Breeding—Sheep and Sheep-Rearing—Pigs—Poultry—Horses—The Dairy
—The Farmer's Implements—The Settler's Home.

' A Practical Hand-book for the use of Colonists and Farmers, by one of the ABLEST,
BEST-KNOWN, and MOST EXPERIENCED AGRICULTURAL WRITERS of the day.'—*North British
Agriculturist*.

" BRISTLES with much PRACTICAL and CONCISELY-PUT information."—*Farmer's Gazette*.

VOL. 3.—NEW LANDS AND THEIR PROSPECTIVE
ADVANTAGES. By HUGH ROBERT MILL, D.Sc.,
F.R.S.E., Librarian to the Royal Geographical Society.

VOL. 4.—BUILDING CONSTRUCTION IN WOOD, STONE,
AND CONCRETE. By JAS. LYON, M.A., Professor of
Engineering in the Royal College of Science for Ireland;
sometime Superintendent of the Engineering Department in
the University of Cambridge; and J. TAYLOR, A.R.C.S.I.

* * * Other Volumes will follow, dealing with subjects of
PRIMARY IMPORTANCE in the EXAMINATION and UTILISATION of
Lands which have not as yet been fully developed.

LONDON: CHARLES GRIFFIN & CO., LIMITED, EXETER STREET, STRAND.

GRIFFIN'S "NEW LAND" SERIES.

Now Ready. With Illustrations. Price in Cloth, 5s.; strongly bound in Leather, 6s. 6d.

**PROSPECTING FOR MINERALS:
A PRACTICAL HANDBOOK**

For Prospectors, Explorers, Settlers, and all interested in the
Opening up and Development of New Lands,

BY

S. HERBERT COX, Assoc.R.S.M., M.Inst. M.M., F.G.S., &c.

GENERAL CONTENTS.—Introduction and Hints on Geology—The Determination of Minerals: Use of the Blow-pipe, &c.—Rock-forming Minerals and Non-Metallic Minerals of Commercial Value: Rock Salt, Borax, Marbles, Lithographic Stone, Quartz and Opal, &c., &c.—Precious Stones and Gems—Stratified Deposits: Coal and Ores—Mineral Veins and Lodes—Irregular Deposits—Dynamics of Lodes: Faults, &c.—Alluvial Deposits—Noble Metals: Gold, Platinum, Silver, &c.—Lead—Mercury—Copper—Tin—Zinc—Iron—Nickel, &c.—Sulphur, Antimony, Arsenic, &c.—Combustible Minerals—Petroleum—General Hints on Prospecting—Glossary—Index.

"His ADMIRABLE LITTLE WORK . . . written with SCIENTIFIC ACCURACY in a CLEAR and LUCID style. . . . The Author has had GREAT EXPERIENCE, and his work is undoubtedly an IMPORTANT ADDITION to technical literature . . . will be of value not only to the Student, but to the experienced Prospector."—*Mining Journal*.

SECOND EDITION. *With Illustrations. Cloth, 3s. 6d.*

**GETTING GOLD:
A GOLD-MINING HANDBOOK FOR PRACTICAL MEN.**

BY J. C. F. JOHNSON, F.G.S., A.I.M.E.,
Life Member Australasian Mine-Managers' Association.

GENERAL CONTENTS.—Introductory: Getting Gold—Gold Prospecting (Alluvial and General)—Lode or Reef Prospecting—The Genesis of Gold—Auriferous Lodes—Auriferous Drifts—Gold Extraction—Secondary Processes and Lixiviation—Calcination or "Roasting" of Ores—Motor Power and its Transmission—Company Formation and Operations—Rules of Thumb: Mining Appliances and Methods—Selected Data for Mining Men—Australasian Mining Regulations.

"PRACTICAL from beginning to end . . . deals thoroughly with the Prospecting, Sinking, Crushing, and Extraction of gold."—*Brit. Australasian*.

"Directors and those interested in the formation of companies would do well to purchase Mr. Johnson's book."—*Mining Journal*.

"The reader, be he miner or novice, will gain from Mr. Johnson's book a GRIP of the gold industry."—*African Critic*.

"Should be specially commended to all who have any idea of proceeding to the gold fields."—*Financial Truth*.

"The most striking elements are the numerous 'TIPS' and USEFUL WRINKLES given."
—*Standard*.

LONDON: CHARLES GRIFFIN & CO., LIMITED, EXETER STREET, STRAND.

ORE & STONE MINING.

BY

C. LE NEVE FOSTER, D.Sc., F.R.S.,

PROFESSOR OF MINING, ROYAL COLLEGE OF SCIENCE H.M. INSPECTOR OF MINES.

SECOND EDITION. With Frontispiece and 716 Illustrations. 34s.

"Dr. Foster's book was expected to be EPOCH-MAKING, and it fully justifies such expectation. . . . A MOST ADMIRABLE account of the mode of occurrence of practically ALL KNOWN MINERALS. Probably stands UNRIVALLED for completeness."—*The Mining Journal*.

GENERAL CONTENTS.

INTRODUCTION. Mode of Occurrence of Minerals: Classification: Tabular Deposits, Masses—Examples: Alum, Amber, Antimony, Arsenic, Asbestos, Asphalt, Barytes, Borax, Boric Acid, Carbonic Acid, Clay, Cobalt Ore, Copper Ore, Diamonds, Flint, Freestone, Gold Ore, Graphite, Gypsum, Ice, Iron Ore, Lead Ore, Manganese Ore, Mica, Natural Gas, Nitrate of Soda, Ozokerite, Petroleum, Phosphate of Lime, Potassium Salts, Quicksilver Ore, Salt, Silver Ore, Slate, Sulphur, Tin Ore, Zinc Ore. **Faults.** **Prospecting:** Chance Discoveries—Adventitious Finds—Geology as a Guide to Minerals—Associated Minerals—Surface Indications. **Boring:** Uses of Bore-holes—Methods of Boring Holes: i. By Rotation, ii. By Percussion with Rods, iii. By Percussion with Rope. **Breaking Ground:** Hand Tools—Machinery—Transmission of Power—Excavating Machinery: i. Steam Diggers, ii. Dredges, iii. Rock Drills, iv. Machines for Cutting Grooves, v. Machines for Tunnelling—Modes of using Holes—Driving and Sinking—Fire-setting—Excavating by Water. **Supporting Excavations:** Timbering—Masonry—Metallic Supports—Watertight Linings—Special Processes. **Exploitation:** Open Works:—Hydraulic Mining—Excavation of Minerals under Water—Extraction of Minerals by Wells and Bore-holes—Underground Workings—Beds—Veins—Masses. **Haulage or Transport:** Underground: by Shoots, Pipes, Persons, Sledges, Vehicles, Railways, Machinery, Boats—Conveyance above Ground. **Hoisting or Winding:** Motors, Drums, and Pulley Frames—Ropes, Chains, and Attachments—Receptacles—Other Appliances—Safety Appliances—Testing Ropes—Pneumatic Hoisting. **Drainage:** Surface Water—Dams—Drainage Tunnels—Siphons—Winding Machinery—Pumping Engines above ground—Pumping Engines below ground—Co-operative Pumping. **Ventilation:** Atmosphere of Mines—Causes of Pollution of Air—Natural Ventilation—Artificial Ventilation: i. Furnace Ventilation, ii. Mechanical Ventilation—Testing the Quality of Air—Measuring the Quantity and Pressure of the Air—Efficiency of Ventilating Appliances—Resistance caused by Friction. **Lighting:** Reflected Daylight—Candles—Torches—Lamps—Wells Light—Safety Lamps—Gas—Electric Light. **Descent and Ascent:** Steps and Slides—Ladders—Buckets and Cages—Man Engine. **Dressing:** i. Mechanical Processes—ii. Processes depending on Physical Properties—iii. Chemical Processes—Principles of Employment of Mining Labour—Legislation affecting Mines and Quarries. Condition of the Miner—Accidents.

"This EPOCH-MAKING work . . . appeals to MEN OF EXPERIENCE no less than to students."—*Berg- und Hüttenmännische Zeitung*.

"This SPLENDID WORK."—*Oesterr. Zeitschrift für Berg- und Hüttenwesen*.

ELEMENTARY MINING AND QUARRYING

(An Introductory Text-book).

BY PROF. C. LE NEVE FOSTER, F.R.S.

In Crown 8vo. With Illustrations.

[Shortly.]

LONDON: CHARLES GRIFFIN & CO., LIMITED, EXETER STREET, STRAND.

COAL-MINING (A Text-Book of):

FOR THE USE OF COLLIERY MANAGERS AND OTHERS
ENGAGED IN COAL-MINING.

BY

HERBERT WILLIAM HUGHES, F.G.S.,

Assoc. Royal School of Mines, General Manager of Sandwell Park Colliery.

THIRD EDITION. *In Demy 8vo, Handsome Cloth. With very Numerous Illustrations, mostly reduced from Working Drawings. Price 18s.*

"The details of colliery work have been fully described, on the ground that collieries are more often made REMUNERATIVE by PERFECTION IN SMALL MATTERS than by bold strokes of engineering. . . . It frequently happens, in particular localities, that the adoption of a combination of small improvements, any of which viewed separately may be of apparently little value, turns an unprofitable concern into a paying one."—*Extract from Author's Preface.*

GENERAL CONTENTS.

Geology: Rocks—Faults—Order of Succession—Carboniferous System in Britain. **Coal:** Definition and Formation of Coal—Classification and Commercial Value of Coals. **Search for Coal:** Boring—various appliances used—Devices employed to meet Difficulties of deep Boring—Special methods of Boring—Mather & Platt's, American, and Diamond systems—Accidents in Boring—Cost of Boring—Use of Boreholes. **Breaking Ground:** Tools—Transmission of Power: Compressed Air, Electricity—Power Machine Drills—Coal Cutting by Machinery—Cost of Coal Cutting—Explosives—Blasting in Dry and Dusty Mines—Blasting by Electricity—Various methods to supersede Blasting. **Sinking:** Position, Form, and Size of shaft—Operation of getting down to "Stone-head"—Method of proceeding afterwards—Lining shafts—Keeping out Water by Tubbing—Cost of Tubbing—Sinking by Boring—Kind—Chaudron, and Lippmann methods—Sinking through Quicksands—Cost of Sinking. **Preliminary Operations:** Driving underground Roads—Supporting Roof: Timbering, Chocks or Cogs, Iron and Steel Supports and Masonry—Arrangement of Inset. **Methods of Working:** Shaft, Pillar, and Subsidence—Bord and Pillar System—Lancashire Method—Longwall Method—Double Stall Method—Working Steep Seams—Working Thick Seams—Working Seams lying near together—Spontaneous Combustion. **Haulage:** Rails—Tubs—Haulage by Horses—Self-acting Inclines—Direct-acting Haulage—Main and Tail Rope—Endless Chain—Endless Rope—Comparison. **Winding:** Pit Frames—Pulleys—Cages—Ropes—Guides—Engines—Drums—Brakes—Counterbalancing—Expansion—Condensation—Compound Engines—Prevention of Overwinding—Catches at pit top—Changing Tubs—Tub Controllers—Signalling. **Pumping:** Bucket and Plunger Pumps—Supporting Pipes in Shaft—Valves—Suspended lifts for Sinking—Cornish and Bull Engines—Davey Differential Engine—Worthington Pump—Calculations as to size of Pumps—Draining Deep Workings—Dams. **Ventilation:** Quantity of air required—Gases met with in Mines—Coal-dust—Laws of Friction—Production of Air-currents—Natural Ventilation—Furnace Ventilation—Mechanical Ventilators—Efficiency of Fans—Comparison of Furnaces and Fans—Distribution of the Air-current—Measurement of Air-currents. **Lighting:** Naked Lights—Safety Lamps—Modern Lamps—Conclusions—Locking and Cleaning Lamps—Electric Light Underground—Delicate Indicators. **Works at Surface:** Boilers—Mechanical Stoking—Coal Conveyors—Workshops. **Preparation of Coal for Market:** General Considerations—Tippers—Screens—Varying the Sizes made by Screens—Belts—Revolving Tables—Loading Shoots—Typical Illustrations of the arrangement of Various Screening Establishments—Coal Washing—Dry Coal Cleaning—Briquettes.

"Quite THE BEST BOOK of its kind . . . as PRACTICAL in aim as a book can be . . . touches upon every point connected with the actual working of collieries. The illustrations are EXCELLENT."—*Athenaeum.*

"A Text-book on Coal-Mining is a great desideratum, and Mr. HUGHES possesses ADMIRABLE QUALIFICATIONS for supplying it. . . . We cordially recommend the work."—*Colliery Guardian.*

"Mr. HUGHES has had opportunities for study and research which fall to the lot of but few men. If we mistake not, his text-book will soon come to be regarded as the STANDARD WORK of its kind."—*Birmingham Daily Gazette.*

LONDON: CHARLES GRIFFIN & CO., LIMITED, EXETER STREET, STRAND.

PETROLEUM

AND ITS PRODUCTS:

A PRACTICAL TREATISE.

BY

BOVERTON REDWOOD,
F.R.S.E., F.I.C., ASSOC. INST. C.E.,

Hon. Corr. Mem. of the Imperial Russian Technical Society; Mem. of the American Chemical Society; Consulting Adviser to the Corporation of London under the Petroleum Acts, &c., &c.

ASSISTED BY GEO. T. HOLLOWAY, F.I.C., ASSOC. R.C.S.,
And Numerous Contributors.

In Two Volumes, Large 8vo. Price 45s.

With Numerous Maps, Plates, and Illustrations in the Text.

GENERAL CONTENTS.

- | | |
|--------------------------------------------------------------------------------------------------------------------------------------------------------------------------------------------------------------------------------------------------------------------------------------------------------------------------------------------------------------------------------------------------------------------|--------------------------------------------------------------------------------------------------------------------------------------------------------------------------------------------------------------------------------------------------------------------------------------------------------------------------------------------|
| <p>I. General Historical Account of the Petroleum Industry.</p> <p>II. Geological and Geographical Distribution of Petroleum and Natural Gas.</p> <p>III. Chemical and Physical Properties of Petroleum.</p> <p>IV. Origin of Petroleum and Natural Gas.</p> <p>V. Production of Petroleum, Natural Gas, and Ozokerite.</p> <p>VI. The Refining of Petroleum.</p> <p>VII. The Shale Oil and Allied Industries.</p> | <p>VIII. Transport, Storage, and Distribution of Petroleum.</p> <p>IX. Testing of Petroleum.</p> <p>X. Application and Uses of Petroleum.</p> <p>XI. Legislation on Petroleum at Home and Abroad.</p> <p>XII. Statistics of the Petroleum Production and the Petroleum Trade, obtained from the most trustworthy and official sources.</p> |
|--------------------------------------------------------------------------------------------------------------------------------------------------------------------------------------------------------------------------------------------------------------------------------------------------------------------------------------------------------------------------------------------------------------------|--------------------------------------------------------------------------------------------------------------------------------------------------------------------------------------------------------------------------------------------------------------------------------------------------------------------------------------------|

"THE MOST COMPREHENSIVE AND CONVENIENT ACCOUNT that has yet appeared of a gigantic industry which has made incalculable additions to the comfort of civilised man. . . . The chapter dealing with the arrangement for STORAGE and TRANSPORT OF GREAT PRACTICAL INTEREST. . . . THE DIGEST OF LEGISLATION on the subject cannot but prove of the GREATEST UTILITY."—*The Times*.

"A SPLENDID CONTRIBUTION to our technical literature."—*Chemical News*.

"THIS THOROUGHLY STANDARD WORK . . . in every way EXCELLENT . . . most fully and ably handled . . . could only have been produced by a man in the very exceptional position of the Author. . . . INDISPENSABLE to all who have to do with Petroleum, its APPLICATIONS, MANUFACTURE, STORAGE, or TRANSPORT."—*Mining Journal*.

"WE MUST concede to Mr. Redwood the distinction of having produced a treatise which must be admitted to the rank of THE INDISPENSABLES. It contains THE LAST WORD that can be said about Petroleum in any of its SCIENTIFIC, TECHNICAL, and LEGAL aspects. It would be difficult to conceive of a more comprehensive and explicit account of the geological conditions associated with the SUPPLY of Petroleum and the very practical question of its AMOUNT and DURATION."—*Journal of Gas Lighting*.

LONDON: CHARLES GRIFFIN & CO., LIMITED, EXETER STREET, STRAND.

MINE-SURVEYING (A Treatise on):

*For the use of Managers of Mines and Collieries, Students
at the Royal School of Mines, &c.*

BY BENNETT H. BROUGH, F.G.S., ASSOC.R.S.M.,
Formerly Instructor of Mine Surveying, Royal School of Mines.

With Diagrams. SIXTH EDITION, Enlarged and Revised. Cloth, 7s. 6d.

GENERAL CONTENTS.

General Explanations—Measurement of Distances—Miner's Dial—Variation of the Magnetic Needle—Surveying with the Magnetic-Needle in presence of Iron—Surveying with the Fixed Needle—German Dial—Theodolite—Traversing Underground—Surface Surveys with Theodolite—Plotting the Survey—Calculation of Areas—Leveling—Connection of Underground- and Surface-Surveys—Measuring Distances by Telescope—Setting-out—Mine-Surveying Problems—Mine Plans—Applications of Magnetic Needle in Mining—Photographic Surveying—*Appendices.*

"Has PROVED ITSELF A VALUABLE Text-book; the BEST, if not the only one, in the English language on the subject." *Mining Journal.*

"No English speaking Mine Agent or Mining Student will consider his technical library complete without it." *Nature.*

A valuable accessory to Surveyors in every department of commercial enterprise. Fully deserves to hold its position as a STANDARD."—*Colliery Guardian.*

In Large 8vo, with Illustrations and Folding-Plates. 10s. 6d.

BLASTING:**AND THE USE OF EXPLOSIVES.**

A Handbook for Engineers and others Engaged in Mining,
Tunnelling, Quarrying, &c.

By OSCAR GUTTMANN, ASSOC. M. INST. C.E.

*Member of the Societies of Civil Engineers and Architects of Vienna and Budapest,
Corresponding Member of the Imp. Roy. Geological Institution of Austria, &c.*

GENERAL CONTENTS.—Historical Sketch—Blasting Materials—Blasting Powder—Various Powder-mixtures—Gun-cotton—Nitro-glycerine and Dynamite—Other Nitro-compounds—Sprengel's Liquid (acid) Explosives—Other Means of Blasting—Qualities, Dangers, and Handling of Explosives—Choice of Blasting Materials—Apparatus for Measuring Force—Blasting in Fiery Mines—Means of Igniting Charges—Preparation of Blasts—Bore-holes—Machine-drilling—Charter Mines—Charging of Bore-holes—Determination of the Charge—Blasting in Bore-holes—Firing—Straw and Fuze Firing—Electrical Firing—Substitutes for Electrical Firing—Results of Working—Various Blasting Operations—Quarrying—Blasting Masonry, Iron and Wooden Structures—Blasting in earth, under water, of ice, &c.

"This ADMIRABLE work."—*Colliery Guardian.*

"Should prove a *valde* *medium* to Mining Engineers and all engaged in practical work."
Iron and Coal Trades Review.

LONDON: CHARLES GRIFFIN & CO., LIMITED, EXETER STREET, STRAND.

NEW VOLUME OF GRIFFIN'S MINING SERIES.

Edited by C. LE NEVE FOSTER, D.Sc., F.R.S.,
H.M. Inspector of Mines, Professor of Mining, Royal School of Mines.

Mine Accounts and Mining Book-keeping,

A Manual for the Use of Students, Managers of Metalliferous
Mines and Collieries, Secretaries of Mining Companies,
and others interested in Mining.

WITH NUMEROUS EXAMPLES TAKEN FROM THE ACTUAL PRACTICE
OF LEADING MINING COMPANIES THROUGHOUT THE WORLD.

BY

JAMES GUNSON LAWN, Assoc. R. S. M., Assoc. Mem. Inst. C. E., F. G. S.,
Professor of Mining at the South African School of Mines, Capetown,
Kimberley, and Johannesburg.

In Large 8vo. Price 10s. 6d.

GENERAL CONTENTS.—Introduction. Part I. Engagement and Payment of Workmen—Data Determining Gross Amount due to Workmen—A. Length of Time Worked—Overtime—B. Amount of Work done—Sinking and Driving—Exploitation—Sliding Scales—Modifications—C. Value of Mineral gotten—Deductions—Pay-Sheets, Due-Bills, and Pay-Tickets. Part II. Purchases and Sales—Purchase and Distribution of Stores—Books and Forms Relating thereto—Sales of Product—Methods of Sale—Contract—Tender—Delivery of, and Payment for, Mineral—Tin Ore—Coal—Silver Ore—Gold Ore. Part III. Working Summaries and Analyses—Summaries of Minerals Raised, Dressed, and Sold; and of Labour—Analyses of Costs—Accounts Forwarded to Head Office. Part IV. Ledger, Balance Sheet, and Company Books—Head Office Books—Ledger—Principal Accounts of a Mining Company—Capital Account—Sale and Purchase Accounts—Capital Expenditure—Personal—Stores—Wages Account—Bad Debts Account—Cash Account—Bills Receivable and Payable Account—Discount and Interest Account—Product Account—Working Accounts—Profit and Loss Account—Journal—Inventory—Balance Sheet—Bibliography—Redemption of Capital—1. Debentures—2. Sinking Fund—A. By Equal Annual Sums—B. By Annual Sum varying according to a Formula—C. By Annual Sum depending on Mineral worked—3. Enlarged Dividends or Bonuses—Depreciation—Reserve Fund—Bibliography—General Considerations and Companies Books—Private Individuals—Private Partnership Companies—Cost-book Companies—Limited Liability Companies—Stocks and Shares—Debentures—Books connected with Shares—Miscellaneous Books—Bibliography. Part V. Reports and Statistics—Inspections of Workings and Machinery—A. Colliery Reports, &c.—Inspections—Report Books—Measurement of Ventilating Current—Permits to fire Shots and carry Safety Lamp Key—B. Ore Mine Reports, &c.—C. Miscellaneous Reports, &c.—Reports of Mining Companies—Managers' Reports—Diagrams—Tabular Statements—Reports of Directors—Reports of Cost-book Mines—Mining Statistics—Great Britain—Other Countries—Bibliography.

"It seems impossible to suggest how Mr. LAWN's book could be made more COMPLETE or more VALUABLE, careful, and exhaustive."—*Accountants' Magazine.*

"Mr. LAWN's book should be found of GREAT USE by MINE SECRETARIES and MINE MANAGERS. It consists of five Parts. PART 1 is devoted to the engagement and payment of workmen, and contains forms of contracts and pay sheets of various descriptions in use by Mining Companies in England and South Africa. Special reference is made to pay sheets and forms employed by the DE BEERS CONSOLIDATED MINES, to the General Manager and the late Secretary of which Company the author is indebted for the particulars given. PART 2 is taken up by a description of books and forms relating to the purchases of Stores, &c., and to sales of the Products of the mines. PART 3 is the most important section of the book, containing instructive details of the manner of obtaining summaries of Working Expenditure and Analyses of Costs. The forms used in this connection by the De Beers Company are shown *in extenso*. PART 4 consists of the Bookkeeping, properly so-called, of a mining company. All details concerning the ledger, journal, and other books, and the principal working accounts of a mine are given. There are some very interesting formulæ in this section, showing the manner in which the CAPITAL of a company should be REDEEMED and REPAID to its Shareholders. According to this manual there are three ways in which this extremely desirable end may be arrived at. The book is published at half a guinea, a price low enough considering the amount of information and instruction set forth."—*Johannesburg Star.*

LONDON: CHARLES GRIFFIN & CO., LIMITED, EXETER STREET, STRAND.

THIRD EDITION. With Folding Plates and Many Illustrations.
Large 8vo. Handsome Cloth. 36s.

ELEMENTS OF METALLURGY:

A PRACTICAL TREATISE ON THE ART OF EXTRACTING METALS
FROM THEIR ORES.

BY

J. ARTHUR PHILLIPS, M. INST. C.E., F.C.S., F.G.S., &c.

AND

H. BAUERMAN, V.P.G.S.

GENERAL CONTENTS.

Refractory Materials.
Fire Clays.
Fuels, &c.
Aluminium.
Copper.
Tin.

Antimony.
Arsenic.
Zinc.
Mercury.
Bismuth.
Lead.

Iron.
Cobalt.
Nickel.
Silver.
Gold.
Platinum.

* Many NOTABLE ADDITIONS, dealing with new PROCESSES and DEVELOPMENTS, will be found in the Third Edition.

"Of the THIRD EDITION, we are still able to say that, as a Text-book of Metallurgy, it is THE BEST with which we are acquainted."—*Engineer*.

"The value of this work is almost *inestimable*. There can be no question that the amount of time and labour bestowed on it is enormous. . . . There is certainly no Metallurgical Treatise in the language calculated to prove of such general utility."—*Mining Journal*.

"In this most useful and handsome volume is condensed a large amount of valuable practical knowledge. A careful study of the first division of the book, on Fuels, will be found to be of great value to every one in training for the practical applications of our scientific knowledge to any of our metallurgical operations."—*Athenæum*.

"A work which is equally valuable to the Student as a Text-book, and to the practical Smelter as a Standard Work of Reference. . . . The Illustrations are admirable examples of Wood Engraving."—*Chemical News*.

LONDON: CHARLES GRIFFIN & CO., LIMITED, EXETER STREET, STRAND.

Griffin's Metallurgical Series.

STANDARD WORKS OF REFERENCE

FOR

Metallurgists, Mine-Owners, Assayers, Manufacturers,
and all interested in the development of
the Metallurgical Industries.

EDITED BY

W. C. ROBERTS-AUSTEN, C.B., D.C.L., F.R.S.,
CHEMIST AND ASSAYER TO THE ROYAL MINT; PROFESSOR OF METALLURGY IN
THE ROYAL COLLEGE OF SCIENCE.

In Large 8vo, Handsome Cloth. With Illustrations.

1. **INTRODUCTION to the STUDY of METALLURGY.**
By the EDITOR. FOURTH EDITION. 15s. (See p. 63.)
2. **GOLD (The Metallurgy of).** By THOS. KIRKE ROSE,
D.Sc., Assoc. R.S.M., F.I.C., of the Royal Mint. THIRD EDITION,
21s. (See p. 64.)
3. **IRON (The Metallurgy of).** By THOS. TURNER,
Assoc. R.S.M., F.I.C., F.C.S. 16s. (See p. 65.)

Will be Published at Short Intervals.

4. **STEEL (The Metallurgy of).** By F. W. HARBORD,
Assoc. R.S.M., F.I.C.
5. **SILVER AND LEAD (The Metallurgy of).** By H. F.
COLLINS, Assoc. R.S.M., M.Inst.M.M. [At Press.]
6. **METALLURGICAL MACHINERY:** the Application of
Engineering to Metallurgical Problems. By HENRY CHARLES JENKINS,
Wh.Sc., Assoc. R.S.M., Assoc. M.Inst. C.E., of the Royal College of
Science.
7. **ALLOYS.** By the EDITOR.

* * Other Volumes in Preparation.

LONDON: CHARLES GRIFFIN & CO., LIMITED, EXETER STREET, STRAND.

GRIFFIN'S METALLURGICAL SERIES.

FOURTH EDITION, Revised and Enlarged. Price 15s.

AN INTRODUCTION TO THE STUDY

OF

METALLURGY.

BY

W. C. ROBERTS-AUSTEN, C.B., D.C.L., F.R.S.,

Associate of the Royal School of Mines; Chemist and Assayer of the Royal Mint;
Professor of Metallurgy in the Royal College of Science.In Large 8vo, with numerous Illustrations and Micro-Photographic Plates
of different varieties of Steel.

GENERAL CONTENTS.

The Relation of Metallurgy to Chemistry.
Physical Properties of Metals.
Alloys.
The Thermal Treatment of Metals.
Fuel and Thermal Measurements.
Materials and Products of Metallurgical Processes

Furnaces.
Means of Supplying Air to Furnaces.
Thermo-Chemistry.
Typical Metallurgical Processes.
The Micro-Structure of Metals and Alloys.
Economic Considerations.

"No English text-book at all approaches this in the COMPLETENESS with which the most modern views on the subject are dealt with. Professor Austen's volume will be INVALUABLE, not only to the student, but also to those whose knowledge of the art is far advanced."—*Chemical News*.

"INVALUABLE to the student. . . . Rich in matter not to be readily found elsewhere."—*Athenæum*.

"This volume amply realises the expectations formed as to the result of the labours of so eminent an authority. It is remarkable for its ORIGINALITY of conception and for the large amount of information which it contains. . . . We recommend every one who desires information not only to consult, but to STUDY this work."—*Engineering*.

"Will at once take FRONT RANK as a text-book."—*Science and Art*.

"Prof. ROBERTS-AUSTEN's book marks an epoch in the history of the teaching of metallurgy in this country."—*Industries*.

LONDON: CHARLES GRIFFIN & CO., LIMITED, EXETER STREET, STRAND.

GRIFFIN'S METALLURGICAL SERIES.

THIRD EDITION. Revised and Enlarged. Handsome Cloth. 21s.

THE METALLURGY OF GOLD.

BY

T. KIRKE ROSE, D.Sc.Lond., Assoc.R.S.M.,
Assistant Assayer of the Royal Mint.

Revised and partly Re-written. Including the most recent Improvements in the Cyanide Process. With Frontispiece and numerous Illustrations.

GENERAL CONTENTS.

<p>The Properties of Gold and its Alloys. Chemistry of the Compounds of Gold. Mode of Occurrence and Distribution of Gold. Placer Mining. Shallow Deposits. Deep Placer Mining. Quartz Crushing in the Stamp Battery. Amalgamation in the Stamp Battery. Other Forms of Crushing and Amalgamating Machinery. Concentration in Stamp Mills. Stamp Battery Practice in particular Localities.</p>	<p>Chlorination: The Preparation of Ore for Treatment. Chlorination: The Vat Process. Chlorination: The Barrel Process. Chlorination: Practice in particular Mills. The Cyanide Process. Chemistry of the Cyanide Process. Pyritic Smelting. The Refining and Parting of Gold Bullion. The Assay of Gold Ores. The Assay of Gold Bullion. Economic Considerations.</p>
-----------------------------------------------------------------------------------------------------------------------------------------------------------------------------------------------------------------------------------------------------------------------------------------------------------------------------------------------------------------------------------------------------------------------------------------	----------------------------------------------------------------------------------------------------------------------------------------------------------------------------------------------------------------------------------------------------------------------------------------------------------------------------------------------------------------------------------------------------------------

Bibliography.

"A COMPREHENSIVE PRACTICAL TREATISE ON this important subject."—*The Times*.

"THE MOST COMPLETE description of the CHLORINATION PROCESS which has yet been published."—*Mining Journal*.

"Dr. Rose gained his experience in the Western States of America, but he has secured details of gold-working from ALL PARTS of the world, and these should be of GREAT SERVICE to practical men. . . . The four chapters on *Chlorination*, written from the point of view alike of the practical man and the chemist, THEM WITH CONSIDERATIONS HITHERTO UNRECOGNISED, and constitute an addition to the literature of Metallurgy, which will prove to be of classical value."—*Nature*.

"Adapted for all who are interested in the Gold Mining Industry, being free from technicalities as far as possible, but is more particularly of value to those engaged in the industry—viz., mill-managers, reduction-officers, &c."—*Cape Times*.

LONDON: CHARLES GRIFFIN & CO., LIMITED, EXETER STREET, STRAND.

GRIFFIN'S METALLURGICAL SERIES.

THE METALLURGY OF IRON.

BY

THOMAS TURNER, ASSOC.R.S.M., F.I.C.,

Director of Technical Instruction to the Staffordshire County Council.

IN LARGE 8VO, HANDSOME CLOTH, WITH NUMEROUS ILLUSTRATIONS
(MANY FROM PHOTOGRAPHS). PRICE 16s.

GENERAL CONTENTS.

Early History of Iron.	Slags and Fluxes of Iron Smelting.
Modern History of Iron.	Properties of Cast Iron.
The Age of Steel.	Foundry Practice.
Chief Iron Ores.	Wrought Iron.
Preparation of Iron Ores.	Indirect Production of Wrought Iron.
The Blast Furnace.	The Puddling Process.
The Air used in the Blast Furnace.	Further Treatment of Wrought Iron.
Reactions of the Blast Furnace.	Iron.
The Fuel used in the Blast Furnace.	Corrosion of Iron and Steel.

"A MOST VALUABLE SUMMARY of useful knowledge relating to every method and stage in the manufacture of cast and wrought iron down to the present moment . . . particularly rich in chemical details. . . . An EXHAUSTIVE and REALLY NEEDED compilation by a MOST CAPABLE and THOROUGHLY UP-TO-DATE metallurgical authority."—*Bulletin of the American Iron and Steel Association.*

"This is a DELIGHTFUL BOOK, giving, as it does, reliable information on a subject becoming every day more elaborate. . . . The account of the chief iron ores is, like the rest of this work, RICH in detail. . . . Foundry Practice has been made the subject of considerable investigation by the author, and forms an interesting and able chapter."—*Colliery Guardian.*

"Mr. Turner's work comes at an opportune moment and in answer to a REAL DEMAND. . . . A THOROUGHLY USEFUL BOOK, which brings the subject UP TO DATE. The author has produced an EMINENTLY READABLE BOOK. . . . What ever he describes, he describes well. . . . There is much in the work that will be of GREAT VALUE to those engaged in the iron industry."—*Mining Journal.*

IN PREPARATION.

COMPANION-VOLUME ON

THE METALLURGY OF STEEL.

By F. W. HARBORD, ASSOC.R.S.M., F.I.C.

LONDON: CHARLES GRIFFIN & CO., LIMITED, EXETER STREET, STRAND.

ASSAYING (A Text-Book of):*for the use of Students, Mine Managers, Assayers, &c.*

By J. J. BERINGER, F.I.C., F.C.S.,

Public Analyst for, and Lecturer to the Mining Association of, Cornwall.

AND C. BERINGER, F.C.S.,

Late Chief Assayer to the Rio Tinto Copper Company, London.

With numerous Tables and Illustrations. Crown 8vo. Cloth, 10/6.
FOURTH EDITION; Revised.

GENERAL CONTENTS. PART I. INTRODUCTORY: MANIPULATION: Sampling; Drying; Calculation of Results. Laboratory books and Reports. METHODS: Dry Gravimetric; Wet Gravimetric. Volumetric Assays: Titrimetric, Colorimetric, Gasometric—Weighing and Measuring. Reagents. Formulae, Equations, &c. Specific Gravity.

PART II.—METALS: Detection and Assay of Silver, Gold, Platinum, Mercury, Copper, Lead, Thallium, Bismuth, Antimony, Iron, Nickel, Cobalt, Zinc, Cadmium, Tin, Tungsten, Titanium, Manganese, Chromium, &c. Earths, Alkalies.

PART III. NON-METALS: Oxygen and Oxides; The Halogens—Sulphur and Sulphates. Arsenic, Phosphorus, Nitrogen. Silicon, Carbon, Boron—Useful Tables.

"A REALLY MERITORIOUS WORK, that may be safely depended upon either for systematic instruction or for reference."—*Nature*

"This work is one of the best of its kind. . . . Contains all the information that the Assayer will find necessary in the examination of minerals."—*Engineer*

*Handsome Cloth. With Numerous Illustrations. 6s.***ELEMENTARY METALLURGY**

(A TEXT BOOK OF).

Including the Author's PRACTICAL LABORATORY COURSE.

By A. HUMBERT SEXTON, F.I.C., F.C.S.,

Professor of Metallurgy in the Glasgow and West of Scotland Technical College.

GENERAL CONTENTS. Introduction. Properties of the Metals. Combustion. Fuels. Refractory Materials. Furnaces. Occurrence of the Metals in Nature. Preparation of the Ore for the Smelter. Metallurgical Processes. Iron; Preparation of Pig Iron—Malleable Iron. Steel. Mild Steel. Copper. Lead. Zinc and Tin. Silver. Gold. Mercury. Alloys. Applications of ELECTRICITY to Metallurgy.—LABORATORY COURSE WITH NUMEROUS PRACTICAL EXERCISES.

"Just the kind of work for Students commencing the study of Metallurgy, or for ENGINEERING Students requiring a GENERAL KNOWLEDGE of it, or for ENGINEERS in practice who like a HANDY WORK of REFERENCE. To all three classes we HEARTILY commend the work."—*Practical Engineer*.

"EXCELLENTLY got up and WELL ARRANGED. . . . Iron and copper well explained by EXCELLENT diagrams showing the stages of the process from start to finish. . . . The most NOVEL chapter is that on the many changes wrought in Metallurgical Methods by ELECTRICITY."—*Chemical Trade Journal*.

"Possesses the GREAT ADVANTAGE of giving a COURSE OF PRACTICAL WORK."—*Mining Journal*.

LONDON: CHARLES GRIFFIN & CO., LIMITED, EXETER STREET, STRAND.

In large 8vo. With Numerous Illustrations and Three Folding-Plates.
Price 21s.

ELECTRIC SMELTING & REFINING:

A PRACTICAL MANUAL OF

THE EXTRACTION AND TREATMENT OF METALS
BY ELECTRICAL METHODS.

Being the "ELEKTRO-METALLURGIE" of
DR. W. BORCHERS.

Translated from the Second German Edition

BY WALTER G. McMILLAN, F.I.C., F.C.S.,
*Secretary to the Institution of Electrical Engineers; late Lecturer in Metallurgy
at Mason College, Birmingham.*

* * * THE PUBLISHERS beg to call attention to this valuable work. DR. BORCHERS' treatise is PRACTICAL throughout. It confines itself to ONE branch of Electro-Chemistry, viz.—ELECTROLYSIS, a subject which is daily becoming of more and more importance to the Practical Metallurgist and Manufacturer. Already in the extraction of Aluminium, the refining of Copper, the treatment of Gold and other metals, electrical processes are fast taking the place of the older methods. DR. BORCHERS' work is acknowledged as the standard authority on the subject in Germany.

CONTENTS.

PART I.—ALKALIES AND ALKALINE EARTH METALS: Magnesium, Lithium, Beryllium, Sodium, Potassium, Calcium, Strontium, Barium, the Carbides of the Alkaline Earth Metals.

PART II.—THE EARTH METALS: Aluminium, Cerium, Lanthanum, Didymium.

PART III.—THE HEAVY METALS: Copper, Silver, Gold, Zinc and Cadmium, Mercury, Tin, Lead, Bismuth, Antimony, Chromium, Molybdenum, Tungsten, Uranium, Manganese, Iron, Nickel, and Cobalt, the Platinum Group.

"COMPREHENSIVE and AUTHORITATIVE . . . not only FULL of VALUABLE INFORMATION, but gives evidence of a THOROUGH INSIGHT into the technical VALUE and POSSIBILITIES of all the methods discussed."—*The Electrician*.

"DR. BORCHERS' WELL-KNOWN WORK . . . must of NECESSITY BE ACQUIRED by every one interested in the subject. EXCELLENTLY put into English with additional matter by MR. M'MILLAN . . . the PHENOMENAL RAPIDITY with which the practical applications of ELECTRO-METALLURGY are advancing in Germany and in America, affords much material for reflection to Engineers in England."—*Nature*.

"Will be of GREAT SERVICE to the practical man and the Student."—*Electric Smelting*.

LONDON: CHARLES GRIFFIN & CO., LIMITED, EXETER STREET, STRAND.

SECOND EDITION in Preparation.

ELECTRO-METALLURGY

(A TREATISE ON) :

Embracing the Application of Electrolysis to the Plating, Depositing, Smelting, and Refining of various Metals, and to the Reproduction of Printing Surfaces and Art-Work, &c.

BY

WALTER G. McMILLAN, F.I.C., F.C.S.

With numerous Illustrations. Large Crown 8vo. Cloth.

"This excellent treatise, . . . one of the BEST and MOST COMPLETE manuals hitherto published on Electro-Metallurgy."—*Electrical Review*.

"This work will be a STANDARD."—*Jeweller*.

"Any metallurgical process which REDUCES the COST of production must of necessity prove of great commercial importance. . . . We recommend this manual to ALL who are interested in the PRACTICAL APPLICATION of electrolytic processes."—*Nature*.

The Art of the Goldsmith and Jeweller

(A Manual for Students and Practical Men).

BY THOS. B. WIGLEY,

Headmaster of the Jewellers and Silversmiths' Association Technical School, Birmingham.

ASSISTED BY

J. H. STANSBIE, B.Sc. (LOND.), F.I.C.,

Lecturer at the Birmingham Municipal Technical School.

In Large Crown 8vo. With Numerous Illustrations.

LONDON: CHARLES GRIFFIN & CO., LIMITED, EXETER STREET, STRAND.

§9. Griffin's Chemical and Technological Publications.

	PAGE
Inorganic Chemistry, . . .	PROFS. DUPRÉ AND HAKE, 70
Quantitative Analysis, . . .	PROF. HUMBOLDT SEXTON, 70
Qualitative . . .	70
Chemical Experiments, . . .	DR. ALDER WRIGHT, . 80
,, Recreations, . . .	J. J. GRIFFIN, . . . 75
Chemistry for Engineers, . . .	M.M. BLOUNT AND BLOXAM, 71
,, ,, Manufacturers, . . .	" " " " 71
Tables for Chemists and Manufacturers, . . .	} PROF. CASTELL-EVANS, . 75
Metallurgy and Electro- Metallurgy, . . .	} <i>See Previous Section.</i>
Agricultural Chemistry, . . .	PROF. J. M. MUNRO, . 75 "
Dairy . . .	H. D. RICHMOND, . 75
Foods, Analysis of, . . .	A. WYNTER BLYTH, . 72
Poisons, Detection of, . . .	" " " " 72
Technical Mycology (The Fermentation Industries) } . . .	LAFAR AND SALTER, . 79
Brewing, . . .	DR. W. J. SYKES, . 78
Cements, . . .	G. R. REDGRAVE, . 76
Gas Manufacture, . . .	W. ATKINSON BUTTERFIELD, 74
Petroleum, . . .	M.M. REDWOOD AND HOLLOWAY, 58
Oils, Soaps, Candles, . . .	DR. ALDER WRIGHT, . 80
Painters' Colours, Oils, and Varnishes, . . .	} G. H. HURST, . . . 76
Painting and Decorating, Colour Theory.	W. J. PEARCE, . . . 77
Pharmacy,	G. H. HURST, . . . 76
Photography,	WM. ELBORNE, . . . 75
	A. BROTHERS, . . . 73
The Textile Industries :	
Dyeing,	M.M. KNECHT AND RAWSON, 81
,, and Cleaning, . . .	G. H. HURST, . . . 83
Bleaching and Calico- Printing,	GEO. DUERR, . . . 83
Textile Printing,	SEYMOUR ROTHWELL, . 82

INORGANIC CHEMISTRY

(A SHORT MANUAL OF).

BY

A. DUPRÉ, Ph.D., F.R.S.,

AND

WILSON HAKE, Ph.D., F.I.C., F.C.S.,

Of the Westminster Hospital Medical School.

SECOND EDITION, Revised. Crown 8vo. Cloth, 7s. 6d.

"A well-written, clear and accurate Elementary Manual of Inorganic Chemistry. . . . We agree heartily in the system adopted by Drs. Dupré and Hake. WILL MAKE EXPERIMENTAL WORK TREBLY INTERESTING BECAUSE INTELLIGIBLE."—*Saturday Review*.

"There is no question that, given the PERFECT GROUNDING of the Student in his Science, the remainder comes afterwards to him in a manner much more simple and easily acquired. The work is AN EXAMPLE OF THE ADVANTAGES OF THE SYSTEMATIC TREATMENT of a Science over the fragmentary style so generally followed. BY A LONG WAY THE BEST of the small Manuals for Students."—*Analyst*.

LABORATORY HANDBOOKS BY A. HUMBOLDT SEXTON,

Professor of Metallurgy in the Glasgow and West of Scotland Technical College.

Sexton's (Prof.) Outlines of Quantitative Analysis.

FOR THE USE OF STUDENTS.

With Illustrations. FOURTH EDITION. Crown 8vo, Cloth, 3s.

"A COMPACT LABORATORY GUIDE for beginners was wanted, and the want has been WELL SUPPLIED. . . . A good and useful book."—*Lancet*.

Sexton's (Prof.) Outlines of Qualitative Analysis.

FOR THE USE OF STUDENTS.

With Illustrations. THIRD EDITION. Crown 8vo, Cloth, 3s. 6d.

"The work of a thoroughly practical chemist."—*British Medical Journal*.

"Compiled with great care, and will supply a want."—*Journal of Education*.

Sexton's (Prof.) Elementary Metallurgy:

Including the Author's Practical Laboratory Course. With many Illustrations, 6s. [See p. 66.

"Just the kind of work for students commencing the study of metallurgy."—*Practical Engineer*.

LONDON: CHARLES GRIFFIN & CO., LIMITED, EXETER STREET, STRAND.

CHEMISTRY FOR ENGINEERS AND MANUFACTURERS.

A PRACTICAL TEXT-BOOK.

BY

BERTRAM BLOUNT, AND
F.I.C., F.C.S., Assoc. Inst. C.E.,
Consulting Chemist to the Crown Agents for
the Colonies.

A. G. BLOXAM,
F.I.C., F.C.S.,
Consulting Chemist, Head of the Chemistry
Department, Goldsmiths' Inst.,
New Cross.

With Illustrations. In Two Vols., Large Svo. Sold Separately.

"The authors have succeeded beyond all expectations, and have produced a work which should give fresh power to the Engineer and Manufacturer." *The Times*.

VOLUME I. Price 10s. 6d.

CHEMISTRY OF ENGINEERING, BUILDING, AND METALLURGY.

General Contents. INTRODUCTION Chemistry of the Chief Materials
of Construction Sources of Energy Chemistry of Steam-raising—Chemistry
of Lubrication and Lubricants Metallurgical Processes used in the
Winning and Manufacture of Metals.

"PRACTICAL THROUGHOUT . . . AN ADMIRABLE TEXT BOOK, useful not only to Students, but to ENGINEERS and MANAGERS OF WORKS IN PREVENTING WASTE and IMPROVING PROCESSES."—*Scotiana*.

"EMINENTLY PRACTICAL."—*Glasgow Herald*.
"A book worthy of HIGH RANK . . . Its merit is great . . . treatment of the subject of WATER-GAS, particularly good . . . WATER-GAS and the production clearly worked out. Altogether a most creditable production. We warmly recommend it, and look forward with keen interest to the appearance of Vol. II." *Journal of the Lighting*.

VOLUME II. Price 16s.

THE CHEMISTRY OF MANUFACTURING PROCESSSES.

General Contents. Sulphuric Acid Manufacture Manufacture of Alkali,
&c.—Destructive Distillation Artificial Manure Manufacture Petroleum
Lime and Cement—Clay Industries and Glass Sugar and Starch—Brewing
and Distilling Oils, Resins, and Varnishes Soap and Candles—Textiles
and Bleaching Colouring Matters, Dyeing, and Printing—Paper and
Pasteboard Pigments and Paints Leather, Glue, and Size—Explosives
and Matches—Minor Chemical Manufactures.

"Certainly a good and useful book, constituting a PRACTICAL GUIDE for students by affording a clear conception of the numerous processes as a whole."—*Chemical Trade Journal*.

"We confidently recommend this volume as a PRACTICAL, and not overloaded, TEXT BOOK, of GREAT VALUE to students." *The Builder*.

LONDON: CHARLES GRIFFIN & CO., LIMITED, EXETER STREET, STRAND.

WORKS BY A. WYNTER BLYTH, M.R.C.S., F.C.S.,

Barrister-at-Law, Public Analyst for the County of Devon, and Medical Officer of Health for St. Marylebone.

FOODS:

THEIR COMPOSITION AND ANALYSIS.

In Demy 8vo, with Elaborate Tables, Diagrams, and Plates. Handsome Cloth. **FOURTH EDITION.** Price 21s.

GENERAL CONTENTS.

History of Adulteration—Legislation, Past and Present—Apparatus useful to the Food-Analyst—"Ash"—Sugar—Confectionery—Honey—Treacle—Jams and Preserved Fruits—Starches—Wheaten-Flour—Bread—Oats—Barley—Rye—Rice—Maize—Millet—Potato—Peas—Chinese Peas—Lentils—Beans—MILK—Cream—Butter—Oleo-Margarine—Butterine—Cheese—Lard—Tea—Coffee—Cocoa and Chocolate—Alcohol—Brandy—Rum—Whisky—Gin—Arrack—Liqueurs—Absinthe—Principles of Fermentation—Yeast—Beer—Wine—Vinegar—Lemon and Lime Juice—Mustard—Pepper—Sweet and Bitter Almond—Annatto—Olive Oil—WATER—Standard Solutions and Reagents. *Appendix:* Text of English and American Adulteration Acts.

PRESS NOTICES OF THE FOURTH EDITION.

"Simply **INDISPENSABLE** in the Analyst's laboratory."—*The Lancet.*

"THE **STANDARD WORK** on the subject. . . . Every chapter and every page gives abundant proof of the strict revision to which the work has been subjected. . . . The section on MILK is, we believe, the most exhaustive study of the subject extant. . . . **AN INDISPENSABLE MANUAL** for Analysts and Medical Officers of Health."—*Public Health.*

"A new edition of Mr. Wynter Blyth's Standard work, **ENRICHED WITH ALL THE RECENT DISCOVERIES AND IMPROVEMENTS**, will be accepted as a boon."—*Chemical News.*

POISONS:

THEIR EFFECTS AND DETECTION.

THIRD EDITION. In Large 8vo, Cloth, with Tables and Illustrations. Price 21s.

GENERAL CONTENTS.

I.—Historical Introduction. II.—Classification—Statistics—Connection between Toxic Action and Chemical Composition—Life Tests—General Method of Procedure—The Spectroscope—Examination of Blood and Blood Stains. III.—Poisonous Gases. IV.—Acids and Alkalies. V.—More or less Volatile Poisonous Substances. VI.—Alkaloids and Poisonous Vegetable Principles. VII.—Poisons derived from Living or Dead Animal Substances. VIII.—The Oxalic Acid Group. IX.—Inorganic Poisons. *Appendix:* Treatment, by Antidotes or otherwise, of Cases of Poisoning.

"Undoubtedly **THE MOST COMPLETE WORK** on Toxicology in our language."—*The Analyst (on the Third Edition).*

"As a **PRACTICAL GUIDE**, we know no better work."—*The Lancet (on the Third Edition).*

***In the THIRD EDITION**, Enlarged and partly Re-written, **NEW ANALYTICAL METHODS** have been introduced, and the **CADAVERIC ALKALOIDS**, or **PTOMAINES**, bodies playing so great a part in Food-poisoning and in the Manifestations of Disease, have received special attention.

LONDON: CHARLES GRIFFIN & CO., LIMITED, EXETER STREET, STRAND.

SECOND EDITION, in Active Preparation.

PHOTOGRAPHY:

ITS HISTORY, PROCESSES, APPARATUS, AND MATERIALS.

A PRACTICAL MANUAL.

Comprising Working Details of all the More
Important Methods.

BY

A. BROTHERS, F.R.A.S.

WITH NUMEROUS FULL PAGE PLATES BY MANY OF THE PRO-
CESSES DESCRIBED, AND ILLUSTRATIONS IN THE TEXT.

In Large 8vo, Handsome Cloth.

GENERAL CONTENTS.

PART I.—INTRODUCTORY: His-
torical Sketch; Chemistry and
Optics of Photography; Arti-
ficial Light.PART II.—Photographic Pro-
cesses.

PART III.—Apparatus.

PART IV.—Materials.

PART V.—Applications of Photo-
graphy; Practical Hints.

"Mr. Brothers has had an experience in Photography so large and varied that any work by him cannot fail to be interesting and valuable. . . . A MOST COMPREHENSIVE volume, entering with full details into the various processes, and VERY FULLY illustrated. The PRACTICAL HINTS are of GREAT VALUE. . . . Admirably got up."—*Brit. Jour. of Photography*.

"For the illustrations alone, the book is most interesting; but, apart from these, the volume is valuable, brightly and pleasantly written, and MOST ADMIRABLY ARRANGED."—*Photographic News*.

"Certainly the FINEST ILLUSTRATED HANDBOOK to Photography which has ever been published. Should be on the reference shelves of every Photographic Society."—*Amateur Photographer*.

"A handbook so far in advance of most others, that the Photographer must not fail to obtain a copy as a reference work."—*Photographic Work*.

"The COMPLETEST HANDBOOK of the art which has yet been published."—*Scotsman*.

* * The New Edition will include all the NEWER DEVELOPMENTS in Photographic Methods, together with Special Articles on RADIOGRAPHY (the X Rays), COLOUR PHOTOGRAPHY, and many New Plates.

LONDON: CHARLES GRIFFIN & CO., LIMITED, EXETER STREET, STRAND.

SECOND EDITION, Revised and Enlarged, with NEW SECTION
ON ACETYLENE.

GAS MANUFACTURE

(THE CHEMISTRY OF).

*A Hand-Book on the Production, Purification, and Testing
of Illuminating Gas, and the Assay of the Bye-
Products of Gas Manufacture. For the
Use of Students.*

BY

W. J. ATKINSON BUTTERFIELD, M.A., F.I.C., F.C.S.,
Formerly Head Chemist, Gas Works, Beckton, London, E.

With Numerous Illustrations. Handsome Cloth.

"The BEST WORK of its kind which we have ever had the pleasure of re-
viewing."—*Journal of Gas Lighting.*

"Amongst works not written in German, WE RECOMMEND BEFORE ALL OTHERS,
BUTTERFIELD'S CHEMISTRY OF GAS MANUFACTURE."—*Chemiker Zeitung.*

GENERAL CONTENTS.

- | | |
|------------------------------------------|----------------------------------------|
| I. Raw Materials for Gas
Manufacture. | VI. Final Details of Manu-
facture. |
| II. Coal Gas. | VII. Gas Analysis. |
| III. Carburetted Water Gas. | VIII. Photometry. |
| IV. Oil Gas. | IX. Applications of Gas. |
| V. Enriching by Light Oils. | X. Bye-Products. |
| XI. Acetylene. | |

* * This work deals primarily with the ordinary processes of GAS MANUFACTURE employed in this country, and aims especially at indicating the *principles* on which they are based. The more modern, but as yet subsidiary, processes are fully treated also.

The Chapters on Gas Analysis and Photometry will enable the consumer to grasp the methods by which the quality of the gas he uses is ascertained, and in the Chapter on The Applications of Gas, not only is it discussed as an illuminant, but also as a ready source of heat and power.

The Incandescent Gas Light is dealt with in an exhaustive manner, and the latest theories of its physical basis, as well as the practical developments of lighting by Incandescence, are thoroughly discussed.

In Chapter X. an attempt has been made to trace in a readily-intelligible manner the extraction of the principal derivatives from the crude BYE-PRODUCTS.

The work deals incidentally with the most modern features of the industry, including *inter alia* the commercial production and uses of Acetylene, to which a special Chapter is devoted in the new Edition, and the application of compressed gas for Street Traction. The needs of the Students in Technical Colleges and Classes have throughout been kept in view.

LONDON: CHARLES GRIFFIN & CO., LIMITED, EXETER STREET, STRAND.

CASTELL-EVANS (Prof. J., F.I.C., F.C.S.,
Finsbury Technical College):

TABLES AND DATA for the use of ANALYSTS, CHEMICAL
MANUFACTURERS, and SCIENTIFIC CHEMISTS. In Large
8vo. Strongly Bound. [Shortly.]

** This important Work will comprehend as far as possible ALL RULES AND TABLES
required by the Analyst, Brewer, Distiller, Acid- and Alkali-Manufacturer, &c. &c.; and
also the principal data in THERMO-CHEMISTRY, ELECTRO-CHEMISTRY, and the various
branches of CHEMICAL PHYSICS which are constantly required by the Student and Worker in
Original Research.

Every possible care has been taken to ensure perfect accuracy, and to include the results
of the most recent investigations.

ELBORNE (Wm., B.A., F.L.S., F.C.S.):

PRACTICAL PHARMACY. (See p. 106 *General Catalogue*).

GRIFFIN (John Joseph, F.C.S.):

CHEMICAL RECREATIONS: A Popular Manual of Experimental
Chemistry. With 540 Engravings of Apparatus. *Tenth Edition*. Crown
8vo. Cloth. Complete in one volume, Parts I. and II. Cloth, gilt
top, 12/6.

Part II.—The Chemistry of the Non-Metallic Elements, 10/6.

MUNRO (J. M. H., D.Sc., Professor of Chemistry,
Downton College of Agriculture):

AGRICULTURAL CHEMISTRY AND ANALYSIS: A PRACTICAL
HAND-BOOK for the Use of Agricultural Students. (*Griffin's
Technological Manuals*.)

RICHMOND (H. Droop, F.C.S., Chemist to the
Aylesbury Dairy Company):

DAIRY CHEMISTRY FOR DAIRY MANAGERS, CHEMISTS,
and ANALYSTS: A Practical Handbook. (*Griffin's Technological
Manuals*.)

LONDON: CHARLES GRIFFIN & CO., LIMITED, EXETER STREET, STRAND.

Painters' Colours, Oils, & Varnishes: A PRACTICAL MANUAL.

By GEORGE H. HURST, F.C.S.,

Member of the Society of Chemical Industry; Lecturer on the Technology of Painters' Colours, Oils, and Varnishes, the Municipal Technical School, Manchester.

SECOND EDITION, Revised and Enlarged. With Illustrations. 12s. 6d.

GENERAL CONTENTS.—Introductory—THE COMPOSITION, MANUFACTURE, ASSAY, and ANALYSIS of PIGMENTS, White, Red, Yellow and Orange, Green, Blue, Brown, and Black—LAKES—Colour and Paint Machinery—Paint Vehicles (Oils, Turpentine, &c., &c.)—Driers—VARNISHES.

"This useful book will prove MOST VALUABLE."—*Chemical News*.

"A practical manual in every respect . . . EXCEEDINGLY INSTRUCTIVE. The section on Varnishes the most reasonable we have met with."—*Chemist and Druggist*.

"VERY VALUABLE information is given."—*Plumber and Decorator*.

"A THOROUGHLY PRACTICAL book, . . . the ONLY English work that satisfactorily treats of the manufacture of oils, colours, and pigments."—*Chemical Trades' Journal*.

"Throughout the work are scattered hints which are INVALUABLE."—*Invention*.

* * For Mr. HURST'S GARMENT DYEING AND CLEANING, see p. 83.

In Crown 8vo, Extra. With Illustrations. 8s. 6d.

CALCAREOUS CEMENTS: THEIR NATURE, PREPARATION, AND USES.

With some Remarks upon Cement Testing.

BY

GILBERT R. REDGRAVE, Assoc. Inst. C.E.

GENERAL CONTENTS.—Introduction—Historical Review of the Cement Industry—The Early Days of Portland Cement—Composition of Portland Cement—PROCESSES OF MANUFACTURE—The Washmill and the Backs—Flue and Chamber Drying Processes—Calcination of the Cement Mixture—Grinding of the Cement—Composition of Mortar and Concrete—CEMENT TESTING—CHEMICAL ANALYSIS of Portland Cement, Lime, and Raw Materials—Employment of Slags for Cement Making—Scott's Cement, Selenitic Cement, and Cements produced from Sewage Sludge and the Refuse from Alkali Works—Plaster Cements—Specifications for Portland Cement—Appendices (Gases Evolved from Cement Works, Effects of Sea-water on Cement, Cost of Cement Manufacture, &c., &c.)

"A work calculated to be of GREAT and EXTENDED UTILITY."—*Chemical News*.

"INVALUABLE to the Student, Architect, and Engineer."—*Building News*.

"A work of the GREATEST INTEREST and USEFULNESS, which appears at a very critical period of the Cement Trade."—*Brit. Trade Journal*.

"Will be useful to ALL interested in the MANUFACTURE, USE, and TESTING of Cements."—*Engineer*.

LONDON: CHARLES GRIFFIN & CO., LIMITED, EXETER STREET, STRAND.

Painting and Decorating :

*A Complete Practical Manual for House
Painters and Decorators.*

Embracing the Use of Materials, Tools, and Appliances; the
Practical Processes involved; and the General Principles
of Decoration, Colour, and Ornament.

BY

WALTER JOHN PEARCE,

LECTURER AT THE MANCHESTER TECHNICAL SCHOOL FOR HOUSE-PAINTING AND DECORATING.

In Crown Svo. extra. With Numerous Illustrations and Plates
(some in Colours), including Original Designs. 12s. 6d.

GENERAL CONTENTS.

Introduction—Workshop and Stores—Plant and Appliances—Brushes and
Tools—Materials: Pigments, Driers, Painters' Oils—Wall Hangings—Paper
Hanging—Colour Mixing—Distemping—Plain Painting—Staining—Varnish
and Varnishing—Imitative Painting—Graining—Marbling—Gilding—Sign-
Writing and Lettering—Decoration: General Principles—Decoration in Dis-
temper—Painted Decoration—Relievo Decoration—Colour—Measuring and
Estimating—Gouache-Painting—Ship-Painting.

"A THOROUGHLY USEFUL BOOK . . . gives GOOD, SOUND, PRACTICAL
INFORMATION in a CLEAR and CONCISE FORM. . . . Can be confidently
recommended alike to Student and Workman, as well as to those carrying on
business as House-Painters and Decorators."—*Plumber and Decorator*.

"A THOROUGHLY GOOD AND RELIABLE TEXT-BOOK. . . . So FULL and
COMPLETE that it would be difficult to imagine how anything further could be
added about the Painter's craft."—*Builders' Journal*.

* * * MR. PEARCE'S work is the outcome of many years' practical ex-
perience, and will be found invaluable by all interested in the subjects
of which it treats. It forms the Companion-Volume to MR. GEO. HURST'S
well-known work on "PAINTERS' COLOURS" (see p. 76).

LONDON: CHARLES GRIFFIN & CO., LIMITED, EXETER STREET, STRAND.

In Large 8vo. Handsome Cloth. Price 21s.

BREWING:

THE PRINCIPLES AND PRACTICE OF.

FOR THE USE OF STUDENTS AND PRACTICAL MEN.

BY

WALTER J. SYKES, M.D., D.P.H., F.I.C.,
EDITOR OF "THE ANALYST."

With Plate and Illustrations.

"A volume of Brewing Science, which has long been awaited. . . . We consider it one of the most complete in contents and novel in arrangement that has yet been published. . . . Will commend a large sale." *The Brewer's Journal*.

"The appearance of a work such as this serves to remind us of the ENORMOUS RAPID ADVANCES made in our knowledge of the Scientific Principles underlying the Brewing Process. . . . Dr. Sykes' work will undoubtedly be of the GREATEST ASSISTANCE, not merely to Brewers, but to all Chemists and Biologists interested in the problems which the Fermentation Industries present." *The Analyst*.

"The publication of Dr. SYKES' MASTERLY TREATISE on the art of Brewing is quite an event in the Brewing World. . . . Deserves our warmest praise. . . . A better guide than Dr. Sykes could hardly be found." *County Brewer's Gazette*.

GENERAL CONTENTS.

I. Physical Principles Involved in Brewing Operations: Heat: The Thermometer Specific Heat Latent Heat Evaporation Density and Specific Gravity Hydro-meters. Chemistry, with special reference to the materials used in Brewing.

II. The Microscope: General Description of the Microscopical Manipulation Examination of Yeast Hanging Drop Method Examination of Bacteria Microscopical Preparations Bacteriological Methods—Bacteriological Examination of Water Hansen's Method Wiedemann's Method Bacteriological Examination of Air Vegetable Biology: The Living Cell: Osmosis The Yeasts The Mycelium The Torula, &c. The Bacteria. Fermentation and Putrefaction Bacterium termo Butyric Acid Bacteria, &c. The Mould Fungi Mucor mucedo, &c. Simple Multicellular Organisms Penicillium glaucum, &c. Mould Fungi Dangerous on Brewing Premises.—The Higher Plants Germination of Barley—Structure of Barleycorn Fermentation: Ancient Views of Lactic Acid The Physiological Theory Doctrine of Spontaneous Evolution Sterilisation of Organic Fluids Competition amongst Micro-organisms Distribution of Atmospheric Germs—Hansen's Investigations on the Air of Breweries Pasteur's Experiments and Theory Other Theories of Fermentation—Investigations of Hansen Pure Cultures from a Single Cell Introduction of Pure Yeast Cultures into the Brewery Hansen's and other Pure Yeast Cultivation Apparatus Advantages of Hansen's Pure Single Cell Yeast Differences in the Action of the various Yeasts.

III. Water: Occurrence and Composition of Results of Analysis of Hardness—Waters Suitable for the Production of Different Classes of Ale—Artificial Treatment of Waters Kahlst Influence of Boiling—Organic Constitution Effect of Filtration Methods of Water Analysis Microscopical Examination of Water Sediments Barley and Malt: Barley Choice of Vitality Age Malting Steeping Steep-Water Germination of Barley—Flooring Sprinkling Withering Pneumatic Malting Galloway System Saladin's Hemming's Drying Kiln Changes Effected in Drying Storage Chemical Examination of Barley Malt Substitutes Quality of Malt Chemical Examination of Malt Ready formed Sugars Malted Brewery Plant: Gravitation Brewery Cold and Hot Liquor Backs Malt Mill Malt Tun, &c. Coppera Coolers Refrigerators Collecting and Fermenting Vessels Burton Union System Atmosphere Parachutes Racking Squares Vats and Conks Brewing: Estimation of Quantities for the Brew Amount of Liquor Required Hardening Materials Mashing Use of Subsidiary Apparatus Black Beers Scouring Boiling Action of Hop tannin Bodies Cooling Refrigerating Collection of Wort Extract Yielded—Fermentation Addition of Yeast Change of Yeast Fermentation Temperatures Dressing—Appearance of Heads Cleansing System Stone Squares System Settling and Racking Dry Hopping Secondary Fermentation Priming Antiseptic Fining Bottled Ales and Bottling Beer and its Diseases: Flavour and Aroma Condition of Salts Fulness Head Brightness Turbidity Opiness Bibliography Appendices: Solution Weight and Solution Factor—Specific Rotatory Power The Law of Definite Relation—Alcoholic Fermentation without Yeast-Cells Fermentation in a Vacuum Index.

LONDON: CHARLES GRIFFIN & CO., LIMITED, EXETER STREET, STRAND.

Vol. I. now Ready. Complete in Itself. Price 15s.

In large 8vo. Handsome Cloth. With numerous Illustrations.

TECHNICAL MYCOLOGY:

THE UTILIZATION OF MICRO-ORGANISMS IN THE ARTS AND MANUFACTURES.

A Practical Handbook on Fermentation and Fermentative Processes for the Use of Brewers and Distillers, Analysts, Technical and Agricultural Chemists, and all interested in the Industries dependent on Fermentation.

BY DR. FRANZ LAFAR,

Professor of Fermentation-Physiology and Bacteriology in the Technical High School, Vienna.

With an Introduction by DR. EMIL CHR. HANSEN, Principal of the Carlsberg Laboratory, Copenhagen.

TRANSLATED BY CHARLES T. C. SALTER.

In Two Volumes, sold Separately.

"AN EXCEEDINGLY USEFUL WORK, which deals in a thoroughly scientific spirit with TECHNICAL BACTERIOLOGY."—*Nature*.

"WE MOST CORDIALLY recommend Dr. Lafar's work to the members of our profession. . . . Must have cost its author an ENORMOUS AMOUNT OF LABOUR AND RESEARCH. No one will fail to observe how well Mr. Salter has done his part."—*The Brewer's Journal*.

"THE CHAPTERS TREAT with INTERESTING MATTER from beginning to end. . . . The plan is ADMIRABLE, the classification simple, the style good, and the tendency of the whole work to convey BUREAU INFORMATION to the reader."—*The Lancet*.

"SHOULD prove of the UTMOST VALUE to Pharmacists, Chemists, Agriculturists, and many others directly or indirectly concerned in the utilisation of Micro-organisms in the Arts and Manufactures. It is difficult to conceive of a more satisfactory practical handbook."—*Pharmaceutical Journal*.

"The extraordinary rôles played by Micro-organisms in Brewing and Distilling—in the manufacture of Sugar, of Vinegar, and Acetic Acid—in Tanning and Tobacco Manufacture—in Agricultural Industries and the Processes connected with the Dairy: Souring of Cream, Cheese-Ripening, &c., &c.—combine to make Dr. Lafar's Text-Book one of great value and interest to a very wide circle of readers. It is hoped that both Volumes of the English version will be issued during 1898.

LONDON: CHARLES GRIFFIN & CO., LIMITED, EXETER STREET, STRAND.

WORKS BY DR. ALDER WRIGHT, F.R.S.

Fixed Oils, Fats, Butter and Waxes:

THEIR PREPARATION AND PROPERTIES,
AND THE
MANUFACTURE THEREFROM OF CANDLE
SOAPS, AND OTHER PRODUCTS.

BY

C. R. ALDER WRIGHT, D.Sc., F.R.S.

Late Lecturer on Chemistry, St. Mary's Hospital Medical School; Examiner in "S
to the City and Guilds of London Institute.

In Large 8vo. Handsome Cloth. With 144 Illustrations. 28s.

"Dr. WRIGHT'S work will be found ABSOLUTELY INDISPENSABLE by every CHEMIST
TEEMS with information valuable alike to the Analyst and the Technical Chemist.
The Analyst.

"Will rank as the STANDARD ENGLISH AUTHORITY on OILS and FATS for
years to come."—*Industries and Iron.*

* * For other Works on OILS, consult REDWOOD on PETROLEUM (1
and HURST on PAINTERS' COLOURS, OILS, and VARNISHES (p. 76).

SECOND EDITION. With very Numerous Illustrations. Handsome Cloth
Also Presentation Edition, Gilt and Gilt Edges, 7s. 6d.

THE THRESHOLD OF SCIENCE

Simple and Amusing Experiments (over 400) in
Chemistry and Physics.

By C. R. ALDER WRIGHT, D.Sc., F.R.S.,
Late Lecturer on Chemistry, St. Mary's Hospital Medical School.

"Any one who may still have doubts regarding the value of Elementary
Science as an organ of education will speedily have his doubts dispelled
takes the trouble to understand the methods recommended by Dr.
Wright."—*Nature.*

"Step by step the learner is here gently guided through the paths of Science
made easy by the perfect knowledge of the teacher, and made flowery
most striking and curious experiments. Well adapted to become the FRIEND
FRIEND of many a bright and promising lad."—*Manchester Examiner.*

LONDON: CHARLES GRIFFIN & CO., LIMITED, EXETER STREET, STR

§ 10. THE TEXTILE INDUSTRIES.

"The MOST VALUABLE and USEFUL WORK on Dyeing that has yet appeared in the English language . . . likely to be THE STANDARD WORK OF REFERENCE for years to come."—*Textile Mercury*.



In Two Large 8vo Volumes, 920 pp., with a SUPPLEMENTARY Volume, containing Specimens of Dyed Fabrics. 45s.

A

MANUAL OF DYEING:

FOR THE USE OF PRACTICAL DYERS, MANUFACTURERS, STUDENTS,
AND ALL INTERESTED IN THE ART OF DYEING.

BY

E. KNECHT, Ph.D., F.I.C.,

Head of the Chemistry and Dyeing Department of the Technical School, Manchester; Editor of "The Journal of the Society of Dyers and Colourists;"

CHR. RAWSON, F.I.C., F.C.S.,

Late Head of the Chemistry and Dyeing Department of the Technical College, Bradford; Member of Council of the Society of Dyers and Colourists;

And RICHARD LOEWENTHAL, Ph.D.

GENERAL CONTENTS.—Chemical Technology of the Textile Fabrics—Water—Washing and Bleaching—Acids, Alkalies, Mordants—Natural Colouring Matters—Artificial Organic Colouring Matters—Mineral Colours—Machinery used in Dyeing—Tinctorial Properties of Colouring Matters—Analysis and Valuation of Materials used in Dyeing, &c., &c.

"This MOST VALUABLE WORK . . . will be widely appreciated."—*Chemical News*.

"This authoritative and exhaustive work . . . the MOST COMPLETE we have yet seen on the subject."—*Textile Manufacturer*.

"The MOST EXHAUSTIVE and COMPLETE WORK on the subject extant."—*Textile Recorder*.

"The distinguished authors have placed in the hands of those daily engaged in the dye-house or laboratory a work of EXTREME VALUE and UNDOUBTED UTILITY . . . appeals quickly to the technologist, colour chemist, dyer, and more particularly to the rising dyer of the present generation. A book which it is refreshing to meet with."—*American Textile Record*.

LONDON: CHARLES GRIFFIN & CO., LIMITED, EXETER STREET, STRAND.

Companion-Volume to MM. Knecht and Rawson's "Dyeing."

TEXTILE PRINTING:

A PRACTICAL MANUAL.

Including the Processes Used in the Printing of
COTTON, WOOLLEN, SILK, and HALF-
SILK FABRICS.

BY

C. F. SEYMOUR ROTHWELL, F.C.S.,

*Mem. Soc. of Chemical Industries; late Lecturer at the Municipal Technical School,
Manchester.*

In Large 8vo, with Illustrations and Printed Patterns. Price 21s.

GENERAL CONTENTS.

Introduction.	Padding Style.
The Machinery Used in Textile Printing.	Resist and Discharge Styles.
Thickeners and Mordants.	The Printing of Compound Colcurings, &c.
The Printing of Cotton Goods.	The Printing of Woollen Goods.
The Steam Style.	The Printing of Silk Goods.
Colours Produced Directly on the Fibre.	Practical Recipes for Printing.
Dyed Styles.	Appendix.
	Useful Tables.
	Patterns.

"BY FAR THE BEST and MOST PRACTICAL BOOK ON TEXTILE PRINTING which has yet been brought out, and will long remain the standard work on the subject. It is essentially practical in character."—*Textile Mercury*.

"THE MOST PRACTICAL MANUAL OF TEXTILE PRINTING which has yet appeared. We have no hesitation in recommending it."—*The Textile Manufacturer*.

"UNDOUBTEDLY MR. ROTHWELL'S book is THE BEST which has appeared on TEXTILE PRINTING, and worthily forms a Companion-Volume to 'A Manual on Dyeing.'"—*The Dyer and Calico Printer*.

LONDON: CHARLES GRIFFIN & CO., LIMITED, EXETER STREET, STRAND.

Large 8vo. Handsome Cloth. 12s. 6d.

BLEACHING & CALICO-PRINTING.

A Short Manual for Students and Practical Men.

BY GEORGE DUERR,

Director of the Bleaching, Dyeing, and Printing Department at the Accrington and Bacup Technical Schools; Chemist and Colourist at the Irwell Print Works.

ASSISTED BY WILLIAM TURNBULL

(of Turnbull & Stockdale, Limited).

With Illustrations and upwards of One Hundred Dyed and Printed Patterns designed specially to show various Stages of the Processes described.

GENERAL CONTENTS.—COTTON, Composition of; BLEACHING, New Processes; PRINTING, Hand-Block; Flat-Press Work; Machine Printing—MORDANTS—STYLES OF CALICO-PRINTING: The Dyed or Madder Style, Resist Padded Style, Discharge and Extract Style, Chromed or Raised Colours, Insoluble Colours, &c.—Thickeners—Natural Organic Colouring Matters—Tannin Matters—Oils, Soaps, Solvents—Organic Acids—Salts—Mineral Colours—Coal Tar Colours—Dyeing—Water, Softening of—Theory of Colours—Weights and Measures, &c.

"When a READY WAY out of a difficulty is wanted, it is IN BOOKS LIKE THIS that it is found."—*Textile Recorder*.

"MR. DUERR'S WORK will be found MOST USEFUL. . . . The information given of GREAT VALUE. . . . The Recipes THOROUGHLY PRACTICAL."—*Textile Manufacturer*.

GARMENT DYEING AND CLEANING.

A Practical Book for Practical Men.

BY GEORGE H. HURST, F.C.S.,

Member of the Society of Chemical Industry.

With Numerous Illustrations. 4s. 6d.

GENERAL CONTENTS.—Technology of the Textile Fibres—Garment Cleaning—Dyeing of Textile Fabrics—Bleaching—Finishing of Dyed and Cleaned Fabrics—Scouring and Dyeing of Skin Rugs and Mats—Cleaning and Dyeing of Feathers—Glove Cleaning and Dyeing—Straw Bleaching and Dyeing—Glossary of Drugs and Chemicals—Useful Tables.

"AN UP-TO-DATE hand book has long been wanted, and Mr. Hurst has done nothing more complete than this. An important work, the more so that several of the branches of the craft here treated upon are almost entirely without English Manuals for the guidance of workers. The price brings it within the reach of all."—*Dyer and Calico-Printer*.

"MR. HURST'S WORK DECIDEDLY FILLS A WANT . . . ought to be in the hands of EVERY GARMENT DYER and cleaner in the Kingdom"—*Textile Mercury*.

LONDON: CHARLES GRIFFIN & CO., LIMITED, EXETER STREET, STRAND.

Fifteenth Annual Issue. Handsome cloth, 7s. 6d.

THE OFFICIAL YEAR-BOOK

OF THE

SCIENTIFIC AND LEARNED SOCIETIES OF GREAT BRITAIN AND IRELAND.

COMPILED FROM OFFICIAL SOURCES.

Comprising (together with other Official Information) LISTS of the PAPERS read during 1897 before all the LEADING SOCIETIES throughout the Kingdom engaged in the following Departments of Research:—

- | | |
|------------------------------------------------------------------------------------------------------------------------------------------------|--------------------------------------------------------|
| § 1. Science Generally: <i>i.e.</i> , Societies occupying themselves with several Branches of Science, or with Science and Literature jointly. | § 6. Economic Science and Statistics. |
| § 2. Mathematics and Physics. | § 7. Mechanical Science, Engineering, and Architecture |
| § 3. Chemistry and Photography. | § 8. Naval and Military Science. |
| § 4. Geology, Geography, and Mineralogy. | § 9. Agriculture and Horticulture. |
| § 5. Biology, including Microscopy and Anthropology. | § 10. Law. |
| | § 11. Literature. |
| | § 12. Psychology. |
| | § 13. Archæology. |
| | § 14. MEDICINE. |

“‘The Year-Book of Societies’ FILLS A VERY REAL WANT.”—*Engineering.*

“INDISPENSABLE to any one who may wish to keep himself abreast of the scientific work of the day.”—*Edinburgh Medical Journal.*

“THE YEAR-BOOK OF SOCIETIES is a Record which ought to be of the greatest use for the progress of Science.”—*Lord Playfair, F.R.S., K.C.B., M.P., Past-President of the British Association.*

“It goes almost without saying that a Handbook of this subject will be in time one of the most generally useful works for the library or the desk.”—*The Times.*

“British Societies are now well represented in the ‘Year-Book of the Scientific and Learned Societies of Great Britain and Ireland.’”—(Art. “Societies” in New Edition of “Encyclopædia Britannica,” vol. xxii.)

Copies of the FIRST ISSUE, giving an Account of the History, Organization, and Conditions of Membership of the various Societies, and forming the groundwork of the Series, may still be had, price 7/6. *Also Copies of the following Issues.*

The YEAR-BOOK OF SOCIETIES forms a complete INDEX TO THE SCIENTIFIC WORK of the year in the various Departments. It is used as a ready HANDBOOK in all our great SCIENTIFIC CENTRES, MUSEUMS, and LIBRARIES throughout the Kingdom, and has become an INDISPENSABLE BOOK OF REFERENCE to every one engaged in Scientific Work.

FOURTH EDITION, REVISED. With Additional Illustrations. Price 6s.

PRACTICAL SANITATION:

A HAND-BOOK FOR SANITARY INSPECTORS AND OTHERS INTERESTED IN SANITATION.

By GEORGE REID, M.D., D.P.H.,

*Fellow, Mem. Council, and Examiner, Sanitary Institute of Great Britain,
and Medical Officer to the Staffordshire County Council.*

With an Appendix on Sanitary Law.

By HERBERT MANLEY, M.A., M.B., D.P.H.,

Medical Officer of Health for the County Borough of West Bromwich.

GENERAL CONTENTS.—Introduction—Water Supply: Drinking Water, Pollution of Water—Ventilation and Warming—Principles of Sewage Removal—Details of Drainage; Refuse Removal and Disposal—Sanitary and Insanitary Work and Appliances—Details of Plumbers' Work—House Construction—Infection and Disinfection—Food, Inspection of; Characteristics of Good Meat; Meat, Milk, Fish, &c., unfit for Human Food—Appendix: Sanitary Law; Model Bye-Laws, &c.

"A VERY USEFUL HANDBOOK, with a very useful Appendix. We recommend it not only to SANITARY INSPECTORS, but to HOUSEHOLDERS and ALL interested in Sanitary matters."—*Sanitary Record*.

THIRD EDITION, REVISED. *Large Crown 8vo. Handsome Cloth. 4s.*

A MANUAL OF AMBULANCE.

By J. SCOTT RIDDELL, C.M., M.B., M.A.,

Senior Asst.-Surgeon, Aberdeen Royal Infirmary; Lecturer and Examiner to the Aberdeen Ambulance Association; Examiner to the St. Andrew's Ambulance Association, Glasgow, and the St. John Ambulance Association, London.

With Numerous Illustrations and Full Page Plates.

General Contents.—Outlines of Human Anatomy and Physiology—The Triangular Bandage and its Uses—The Roller Bandage and its Uses—Fractures—Dislocations and Sprains—Hæmorrhage—Wounds—Insensibility and Fits—Asphyxia and Drowning—Suffocation—Poisoning—Burns, Frost-bite, and Sunstroke—Removal of Foreign Bodies from (a) The Eye; (b) The Ear; (c) The Nose; (d) The Throat; (e) The Tissues—Ambulance Transport and Stretcher Drill—The After-treatment of Ambulance Patients—Organisation and Management of Ambulance Classes—Appendix: Examination Papers on First Aid.

"A CAPITAL BOOK. . . . The directions are SHORT and CLEAR, and testify to the hand of an able surgeon."—*Edin. Med. Journal*.

"This little volume seems to us about as good as it could possibly be. . . . Contains practically every piece of information necessary to render First aid. . . . Should find its place in EVERY HOUSEHOLD LIBRARY."—*Daily Chronicle*.

"SO ADMIRABLE is this work, that it is difficult to imagine how it could be better."—*Colliery Guardian*.

LONDON: CHARLES GRIFFIN & CO., LIMITED, EXETER STREET, STRAND.

"Boys COULD NOT HAVE A MORE ALLURING INTRODUCTION to scientific pursuits than these charming-looking volumes."—Letter to the Publishers from the Head master of one of our great Public Schools.

OPEN-AIR STUDIES IN BOTANY:

SKETCHES OF BRITISH WILD FLOWERS IN THEIR HOMES.

BY

R. LLOYD PRAEGER, B.A., M.R.I.A.

Illustrated by Drawings from Nature by S. Rosamond Praeger,
and Photographs by R. Welch.

Handsome Cloth, 7s. 6d. Gilt, for Presentation, 8s. 6d.

GENERAL CONTENTS.—A Daisy-Starred Pasture—Under the Hawthorns—By the River—Along the Shingle—A Fragrant Hedgerow—A Commemara Bog—Where the Sapphire grows—A Flowery Meadow—Among the Corn (a Study in Weeds)—In the Home of the Alpines—A City Rubbish-Heap—Glossary.

"A FRESH AND STIMULATING book . . . should take a high place . . . The illustrations are drawn with much skill."—*The Times*.

"BEAUTIFULLY ILLUSTRATED. . . . One of the MOST ACCURATE as well as INTERESTING books of the kind we have seen."—*Athenaeum*.

"Redolent with the scent of woodland and meadow."—*The Standard*.

"A Series of STIMULATING and DELIGHTFUL Chapters on Field-Botany."—*The Scotsman*.

"A work as FRESH in many ways as the flowers themselves of which it treats. The RICH STORE of information which the book contains."—*The Gardener*.

OPEN-AIR STUDIES IN GEOLOGY:

An Introduction to Geology Out-of-doors.

BY

GRENVILLE A. J. COLE, F.G.S., M.R.I.A.,

Professor of Geology in the Royal College of Science for Ireland.

With 12 Full-Page Illustrations from Photographs. Cloth. 8s. 6d.

GENERAL CONTENTS.—The Materials of the Earth—A Mountain Hollow—Down the Valley—Along the Shore—Across the Plains—Dead Volcanoes—A Granite Highland—The Annals of the Earth—The Surrey Hills—The Folds of the Mountains.

"The FASCINATING 'OPEN-AIR STUDIES' of PROF. COLE give the subject a glow of ANIMATION . . . cannot fail to arouse keen interest in geology."—*Geological Magazine*.

"EMINENTLY READABLE . . . every small detail in a scene touched with a sympathetic kindly pen that remind one of the lingering brush of a Constable."—*Nature*.

"The work of Prof. Cole combines ELEGANCE of STYLE with SCIENTIFIC THOROUGHNESS."—*Petermann's Mittheilungen*.

"The book is worthy of its title: from cover to cover it is strong with bracing freshness of the mountain and the field, while its ACCURACY and THOROUGHNESS show that it is the work of an earnest and conscientious student. . . . Full of picturesque touches which are most welcome."—*Natural Science*.

"A CHARMING BOOK, beautifully illustrated."—*Athenaeum*.

LONDON: CHARLES GRIFFIN & CO., LIMITED, EXETER STREET, STRAND.