

# 4. P.C.B Diagrams

## 4-1 P.C.B Diagrams

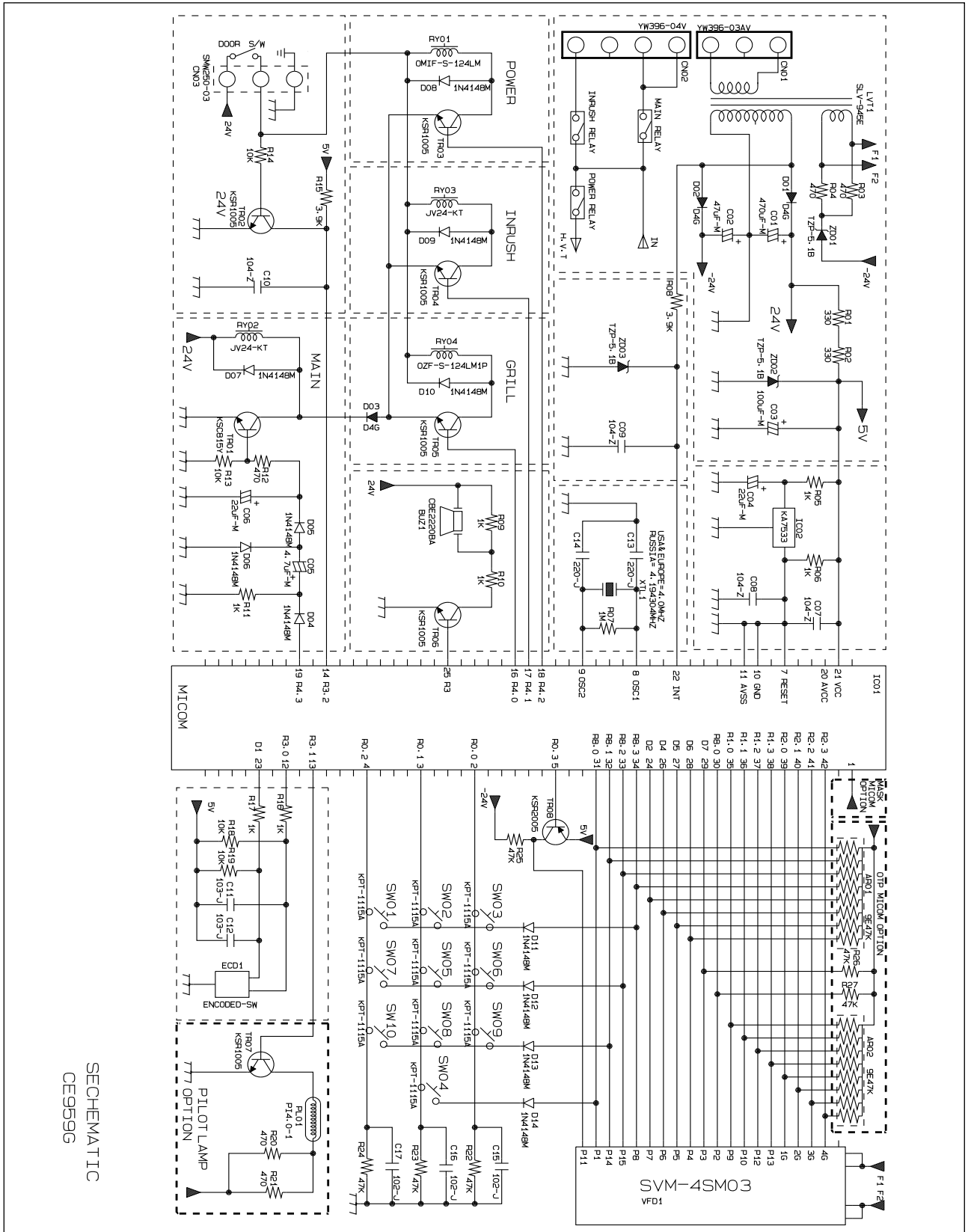

# 5. Schematic Diagrams

## 5-1 Schematic Diagrams

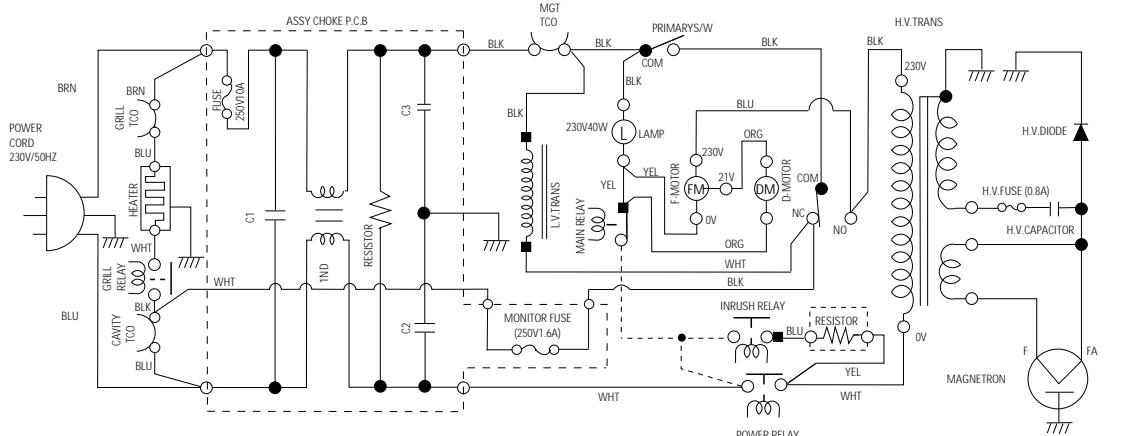

**CONDITION OF OVEN**

DOOR IS OPENED  
COOK OFF

**WIRING COLOR**

BRN : BROWN    BLU : BLUE  
WHT : WHITE    ORG : ORANGE  
RED : RED       YEL : YELLOW  
BLK : BLACK  
Y/G : YELLOW GREEN

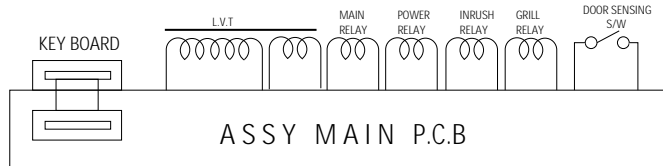

- 1.INPUT : 230V
- 2.DOOR : OPEN
- 3.LAMP : ON
4. --- : P.C.B PATTERN
5. ■ : P.C.B IN/OUT POINT

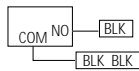

PRIMARY LATCH SWITCH

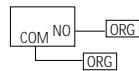

DOOR SENSING SWITCH

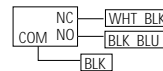

MONITOR SWITCH

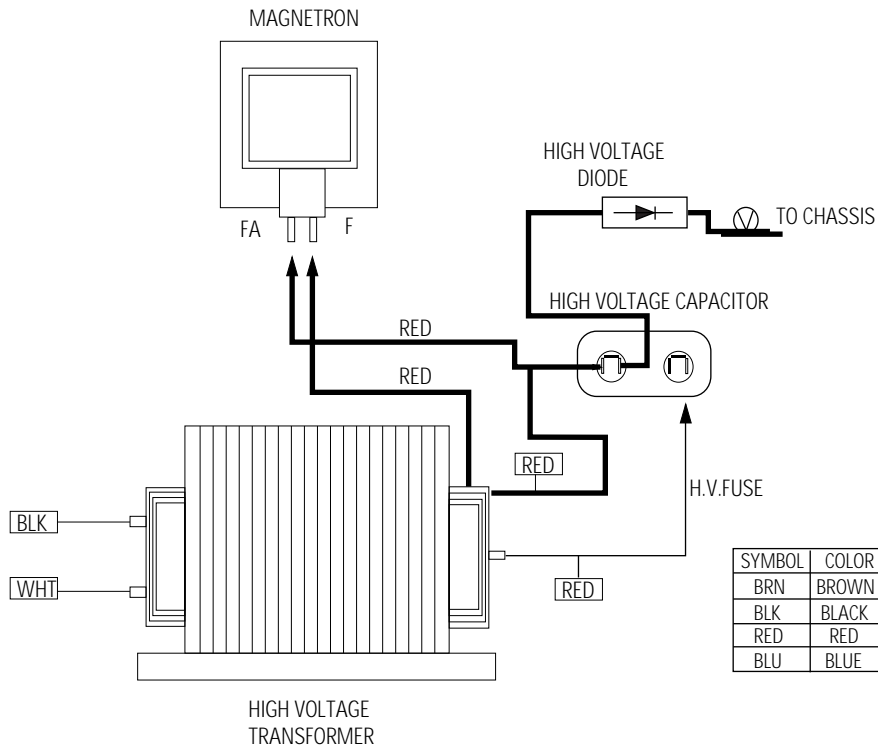

SYMBOL	COLOR
BRN	BROWN
BLK	BLACK
RED	RED
BLU	BLUE