

MAQUET

SERVO VENTILATOR 900 C OPERATING MANUAL

CRITICAL CARE

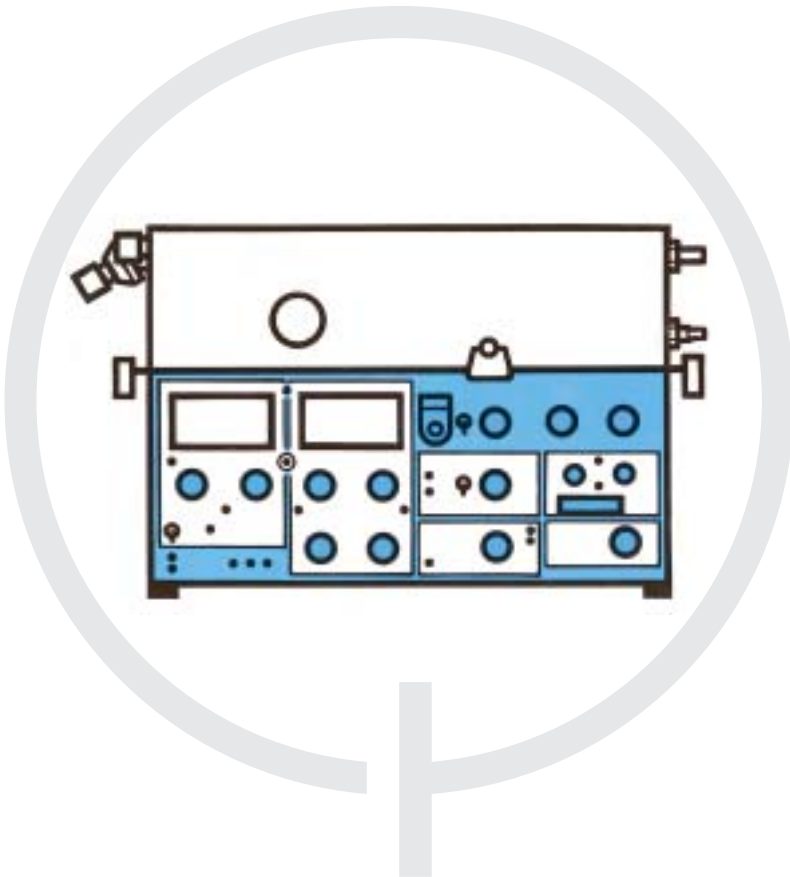

Important



General information

- Servo Ventilator 900 C must be operated only by authorized personnel who are well trained in its use. It must be operated according to the instructions in this Operating Manual.
- After unpacking, the ventilator must be checked and, if necessary, calibrated.
- All data on pressures for Servo Ventilator 900 C are given in cm H₂O.
1 kPa (kilopascal) ≈ 10 cm H₂O
100 kPa = 1 bar ≈ 1 atm ≈ 1 kgf/cm² (kp/cm²)
100 kPa ≈ 15 psi
- Responsibility for the safe functioning of the equipment reverts to the owner or user in all cases in which service or repair has been done by a non-professional or by persons who are not employed or authorized by MAQUET, and when the equipment is used for other than its intended purpose.
- A full technical description – including circuit diagrams, parts list and service data – is contained in the service documentation, copies of which are held by your supplier.

Connection

- When connected to a patient, the ventilator must never be left unattended.
- A check on functions must be done before a patient is connected to the ventilator.
- When anaesthetic gas is metered via a flow meter on the low pressure inlet, compressed air must not be connected at the same time.
- To avoid explosion hazards, flammable agents such as ether and cyclopropane must not be used in this machine. Only agents which comply with the requirements on non-flammable agents in the IEC standard "Particular requirements for electrical safety of anaesthetic machines" are suitable in this machine.
- As this machine is not suitable for use with flammable agents such as ether and cyclopropane, the use of antistatic breathing tubes and face masks is not necessary. The use of antistatic or electrically conductive breathing tubes when using high frequency electric surgery equipment, may cause burns and is therefore not recommended in any application of this machine.
- Never connect or disconnect auxiliary equipment to the outlet on the rear of the ventilator when the ventilator is connected to mains.
- All gases must fulfill the specifications for medical grade gas. The gases supplied must be dry and free from oil and dust.

Air	H ₂ O	< 5 g/m ³
	Oil	< 0.5 mg/m ³
Oxygen	H ₂ O	< 20 mg/m ³
Nitrous oxide/gaseous phase)	H ₂ O	< 58 ppm

Operation

- The APNEA ALARM is not intended to and will not monitor for disconnections.
- The APNEA ALARM is not functional in VOL. CONTR., VOL. CONTR. + SIGH, PRESS. CONTR. or MAN.
- In the case of a power failure, manual ventilation using a Servo Ventilator 900 C is possible only with the help of power supply from external battery. A resuscitator should always be available, however, as an extra safety measure.
- The SV 900 C is certified, with regard to safety, to be compatible with electromagnetic environments complying with IEC 601-1-2. It is the responsibility of the user to take necessary measures in order to ascertain that the specified limits are not exceeded as this may impair the safety of the ventilator.

Such measures should include, but are not limited to:

– normal precautions with regard to relative humidity and conductive characteristics of clothing in order to minimize the build-up of electrostatic charges.

– avoiding the use of radio emitting devices in close

proximity of the ventilator, such as high-frequency surgery apparatus or cordless (mobile) telephones, resulting in a field level exceeding 3 V/m (IEC 601-1-2).

Magnetic fields of MR equipment having flux densities above 20 mT may cause deactivation of the ventilator functions and may result in permanent damage to the Servo Ventilator.

- To protect the patient against high pressures, the WORKING PRESSURE and UPPER PRESS. LIMIT must always be set at suitable values.
- Do not forget to set the manual ventilation valve to position AUT after completed manual ventilation. Otherwise the patient may be hypoventilated without any alarm from the ventilator. (Not applicable to manual ventilation accessory with motor).
- When mains supply is switched off or in the case of a mains power failure, the inspiratory and expiratory valves will automatically open. This may also occur in the case of an internal electronic failure. Thus, if the WORKING PRESSURE is set too high and the gas supply through the gas supply unit continues, this may result in increased airway pressure.
- When excess gas is being scavenged, the scavenging system must meet the following requirements:
 - At the point at which the scavenging system is connected to the ventilator, the sub-atmospheric pressure must not exceed 0.5 cm H₂O or cause an induced flow from the breathing system greater than 0.5 l/min.
 - With continuous air flows of 30 l/min and 90 l/min for not less than 5 seconds at the inlet of the anaesthetic gas scavenging system, the resistance in the system shall not exceed 0.25 cm H₂O and 2.5 cm H₂O, respectively. The Servo Evac 180 basic evacuation unit meets these requirements.
- If the ventilator is equipped with electronic gas supply unit, the following applies:
 - When mains supply is switched off or in the case of power failure, the gas supply is automatically blocked.

Cleaning

- The ventilator must not be gas sterilized.
- The flow transducers must not be cleaned in a dish washing machine, by ultrasonic methods or by using agents that contain aldehydes.
- Agents used for cleaning must have a pH value between 4–8.5.
- Complete cleaning should be done after every 1000 hours of operation or, at the latest, after every six months.

Service

- The Servo Ventilator 900 C must be serviced at regular intervals by specially trained personnel. Any maintenance must be noted in the log book provided for that purpose, in accordance with national regulations. We recommend that service is done as a part of a service contract with MAQUET.
- The 1000 hours overhaul shall be done after every 1000 operating hours or, at the latest, every six months. In addition, the ventilator shall undergo a technical safety check twice a year, at six months intervals, according to national regulations.
- Service and repairs on the ventilator may be done only by MAQUET authorized personnel.
- Only original parts from MAQUET must be used in the ventilator.

Equipment combinations

- Only MAQUET-approved accessories and auxiliary equipment may be connected to the ventilator.
- In order to maintain system safety and integrity only accessories complying with IEC 601-1, or the safety of which has been verified in another way must be connected to the signal outputs on the rear of the ventilator. For details on connections and allowed voltages, please see Circuit Diagram.

Product information program

This Operating Manual is a part of a comprehensive information program for Servo Ventilator 900 C. The program is planned to contain the following:

Promotional and Scientific Publications

Brochure	Servo Ventilator Concept	Application Brochures: Intensive Care Anesthesia Transportation	Product Leaflet	Reprints
----------	--------------------------	--	-----------------	----------

Operating and Service Instructions

Operating Manual	Brief Operating Instructions	Wall Diagram with Cleaning Instructions	Service Manual	Circuit Diagram
------------------	------------------------------	---	----------------	-----------------

Product Training Material

Training Instructions	Advisory Booklet for Instructors	Slide Series including Textbook	"I am breathing through a ventilator" Film and Booklet	The Patient's ABSee® Cards and Poster
Front Panel Flip-chart	Panel Block	Trainee's set	Video programs Video guide Video news	

Servo Ventilator 900 C-Front



SIEMENS



EXPIRED MINUTE VOLUME POWER ON **AIRWAY PRESSURE**

MIN. VOL. ALARM 2 min

LOWER ALARM LIMIT **TRIGG SENSITIVITY BELOW PEEP** **UPPER PRESS. LIMIT**

INFANTS 0-43 ml/min **ADULTS** 0-40 l/min

APNEA ALARM **PEEP** **INSP. PRESS. LI ABOVE PEEP**

GAS SUPPLY ALARM **INSP. PAUSE HOLD** **EXPR. PAUSE HOLD** **GAS CHANGE**



PRESET WORKING PRESSURE

PRESET INSP. MIN. VOL. l/min



BREATHS / min



INSP. TIME %



PAUSE TIME %

LOW RATE 8-4

HIGH RATE 4-8



SIMV BREATHS / min

SET O₂ ALARM



LOWER ALARM LIMIT



UPPER ALARM LIMIT



O₂ CONC. %

VOL. CONTR.
 VOL. CONTR.+SIGH
 PRESS. CONTR.
 PRESS. SUPPORT

SIMV + PRESS. SUPPORT
 CRAP
 MAN.

INSP. TIDAL VOL. ml
 EXP. TIDAL VOL. ml
 EXP. MIN. VOL. l/min
 PEAK PRESS. cm H₂O
 PAUSE PRESS. cm H₂O
 MEAN AIRWAY PRESS. cm H₂O

BREATHS / min

SIEMENS

Servo Ventilator 900 C

Operating instructions

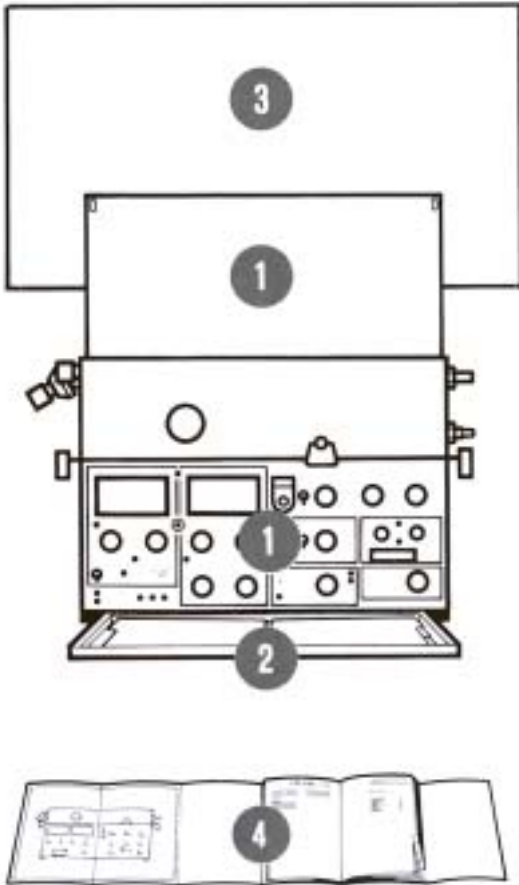

Servo Ventilator 900 C is simple to operate. Operating instructions are found:

①

On the ventilator in the form of a panel and cleaning instructions on the lid of the pneumatic unit.

“Normal” settings are indicated in green on the front panel. Settings indicated in red should be used with caution, since these settings may involve a certain risk for the patient.

②

In the Brief Operating Instructions in the drawer under the ventilator.

A log sheet is available with the Brief Operating Instructions. After certain routines, e. g. cleaning etc., the person responsible for the work should complete and sign the log sheet. The log sheet can then be filed.

③

On a separate wall poster with cleaning instructions.

④

In this Operating Manual.

The inside of the cover shows a picture of the ventilator. This picture can be used as a foldout when reading the manual.

The following information is found in the corresponding chapters:

Description	1-3
Operating	4-9
Maintenance	10-13
Technical specifications	14

Contents

1. Basic principles

2. Control panel and ventilation modes

3. Patient safety

4. Set-ups

5. Preparations

6. Check on functions

7. Connection to patient

8. Clinical judgement and troubleshooting

9. Recording

10. Routine cleaning

11. 1000 hours overhaul with complete cleaning

12. Replacement of O₂ cell

13. Calibration

14. Technical specifications

Chapter 1

Basic principles

In this chapter:

General design 1:2

Pneumatic unit..... 1:3

Rear 1:4

General design

1
2

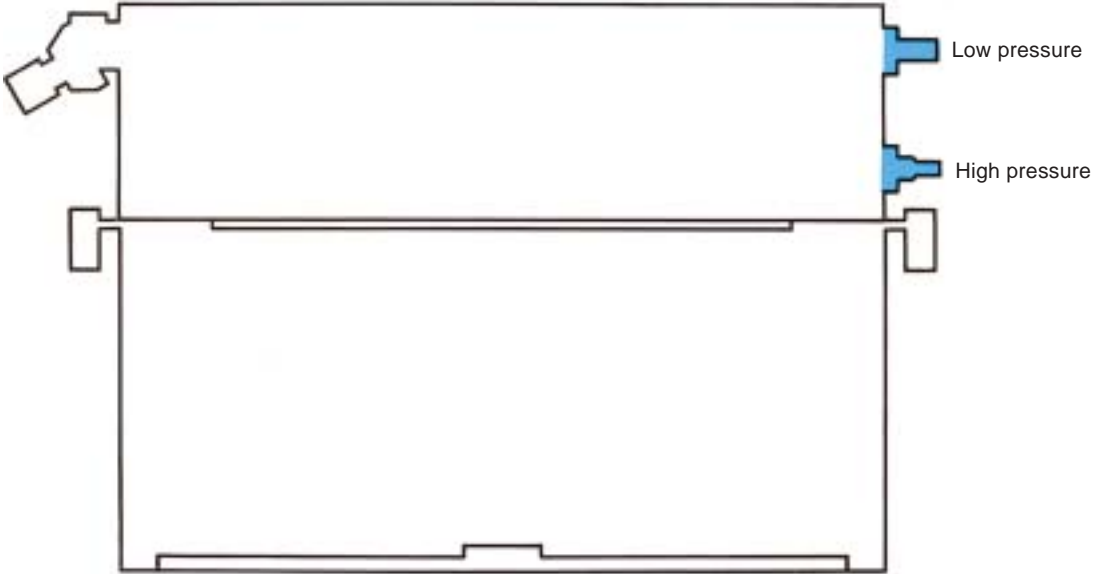

Pneumatic unit

The pneumatic unit comprises the gas conduction system, pressure and flow transducers and control valves.

The control of flow and pressure is done by a feed-back system. The transducers continually measure the flow and pressures. The information is compared with the panel settings and a difference between the actual and the preset values results in correction signals to the control valves.

For detailed description, see chapter "Basic principles" in the Training Instructions.

Electronic unit

The electronic unit contains a number of plug-in PC-boards with the circuits for regulation, alarms and monitoring.

The unit effects the electronic control of the pneumatic unit.

Servicing of the ventilator is facilitated by the spare parts exchange system. The faulty parts are replaced by factory trimmed exchange parts.

Service on the electronic unit must be done by MAQUET, or by MAQUET authorized personnel only.

Pneumatic unit

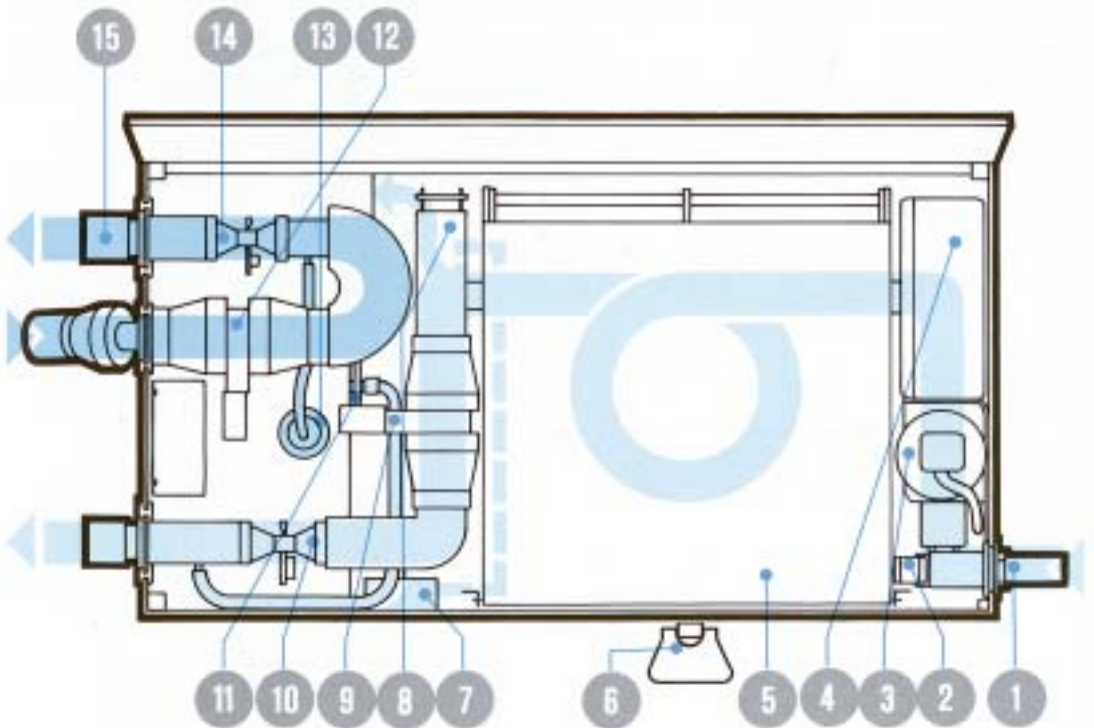

1 Gas connection. The upper inlet, not visible in the picture, is used for low pressure gas and the lower inlet is used for high pressure gas. For anaesthesia, a gas supply unit with three inlets is available.

2 The gas supply is regulated by a valve so that a constant pressure is maintained in the bellows.

3 The O₂ cell measures the O₂ concentration in the gas.

4 The gas flows through a bacteria filter.

5 The respiratory gases are mixed and stored at a constant pressure in the bellows.

6 The working pressure is set with an adjustment screw.

7 A manometer shows the working pressure.

8 A safety valve opens if the bellows is overfilled, or if the pressure exceeds approx. 120 cm H₂O.

9 The flow transducer on the inspiration side measures the gas flow to the patient.

10 The inspiration valve regulates the inspiratory gas flow. It is closed during the pause and expiratory parts of the respiratory cycle.

11 The pressure transducer on the inspiration side measures the airway pressure.

12 The flow transducer on the expiration side measures the gas flow from the patient.

To prevent condensation, the transducer is heated to approx. 60°C.

13 The pressure transducer on the expiration side measures the airway pressure.

14 The expiration valve is closed during inspiration. During the expiratory phase it is either fully open or regulating the PEEP level.

15 The flap valve prevents a back flow of exhaled gases. It is also necessary for the trigger function.

Rear

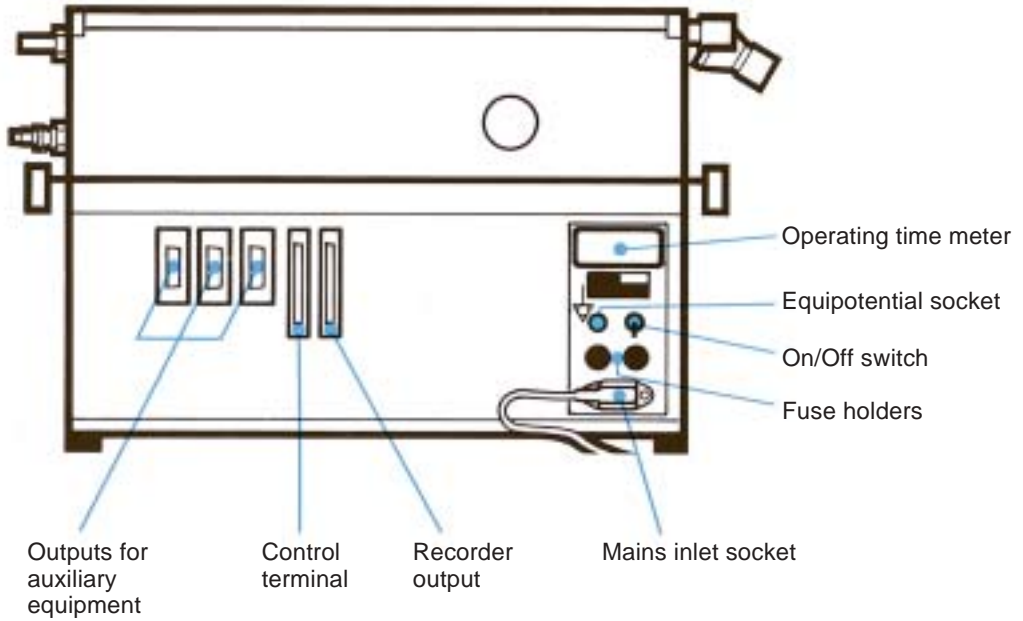

Rear of Servo Ventilator 900 C

To the right on the electronic unit are the mains inlet socket, fuse holders, On/Off switch, voltage rating, equipotential socket and operating time meter.

To the left on the electronic unit are three 15-pole sockets for auxiliary equipment.

The 37-pole socket is used for recording of pressure and flow curves.

There are labels with the serial number of the apparatus on both the pneumatic unit and the electronic unit.

Control terminal

Under the secured lid, there is a connector for external control of ventilation.

For details see separate Operating Manual.

Control panel and ventilation modes

In this chapter:

Panel design and symbols	2:2
Panel functions	2:3
Working pressure	2:3
Mode selection	2:3
Respiratory pattern	2:4
I:E ratio	2:5
Expired minute volume ..	2:6
Special functions	2:7
Airway pressure	2:8
SIMV	2:10
O ₂ alarm	2:11
Parameter selection	2:11
Controlled ventilation	2:12
Supported ventilation	2:13
Spontaneous ventilation.	2:15
Manual ventilation	2:16

Panel design and symbols

2
2

For easy operation, the panel is divided into fields. Each field is described in this chapter.

“Normal” settings are indicated in green on the front panel. Settings indicated in red should be used with caution since these settings may involve a certain risk for the patient.

A number of knobs and the EXPIRED MINUTE VOLUME meter have dual scales.

The blue scale is always to be used when the low range is selected.

Power on is indicated by a green lamp.

A yellow lamp is either an indication of a certain setting or a reminder to set an alarm limit.

A red lamp always indicates an alarm.

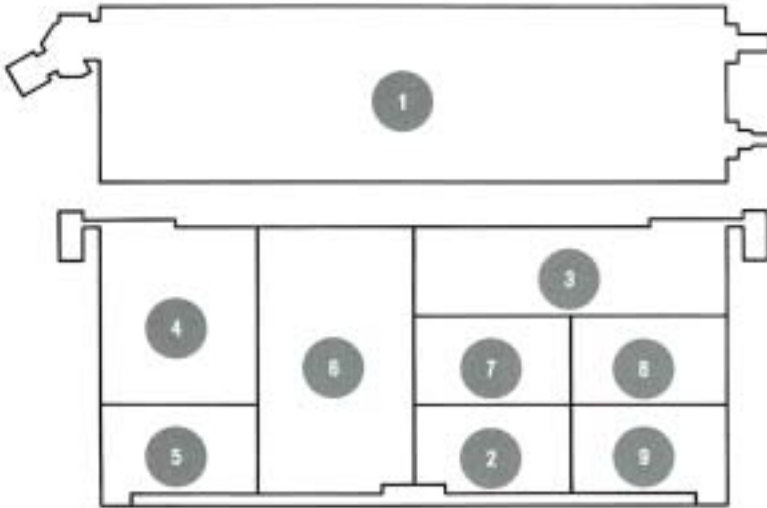

- ① Working Pressure
- ② Mode Selection
- ③ Respiratory Pattern
- ④ Expired Minute Volume
- ⑤ Special Functions
- ⑥ Airway Pressure
- ⑦ SIMV
- ⑧ O₂ Concentration Alarm
- ⑨ Monitoring

Panel functions

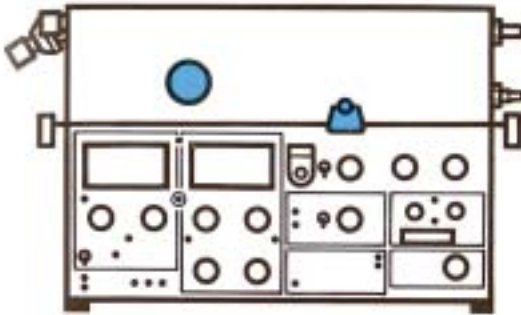

Working pressure

The working pressure is set with an adjustment screw and is read on the manometer **WORKING PRESSURE**.

The working pressure must always be set at a value somewhat higher than the highest airway pressure.

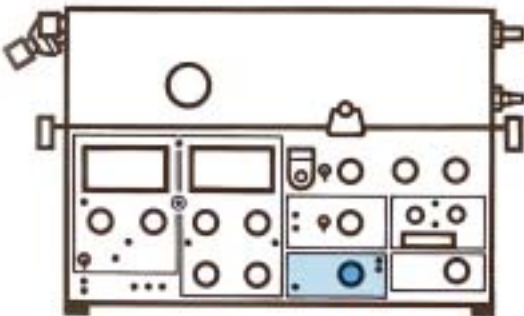

Mode selection

The Servo Ventilator 900 C can be operated in 8 different modes, which are selected by means of the mode selector.

The modes are described in special sections in this chapter.

Controlled ventilation

Volume controlled ventilation (VOL. CONTR.)

Volume controlled ventilation + sigh (VOL. CONTR. + SIGH)

Pressure controlled ventilation (PRESS. CONTR)

Supported ventilation

Pressure supported ventilation (PRESS. SUPPORT)

SIMV (Synchronized Intermittent Mandatory Ventilation)

SIMV + Pressure support (SIMV + PRESS. SUPPORT)

Spontaneous ventilation

CPAP (Continuous Positive Airway Pressure)

Manual ventilation

MAN

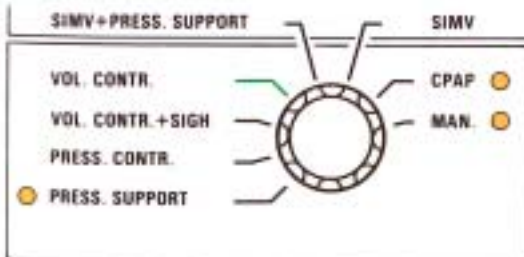

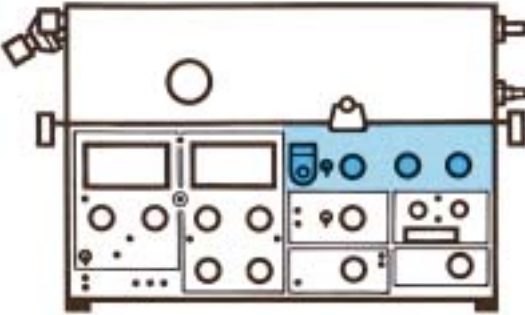

Respiratory pattern

Preset inspiratory minute volume

The inspiratory minute volume is set with the knob PRESET INSP. MIN.VOL. l/min. The knob has a locking button on the underside.

A suitable initial value can be calculated by, for instance, using a Radford nomogram. The minute volume can be readjusted after indication from a CO₂ Analyzer 930, which is auxiliary equipment for the Servo Ventilator.

The setting range is 0.4-40 l/min.

The tidal volume =
 $\frac{\text{PRESET INSP. MIN. VOL. l/min}}{\text{BREATHS/min}}$

The tidal volume can be read on the digital display.

At extremely high flows it may be necessary to increase the working pressure in order to obtain the desired minute volume.

Flow pattern switch

During VOL. CONTR. and VOL. CONTR. + SIGH, a constant or an accelerating inspiratory flow can be selected. Constant flow gives a lower peak pressure and is the pattern normally used.

A decelerating flow will be obtained in PRESS. CONTR.

Breaths per minute

The respiratory rate is steplessly adjustable within the range of 5 to 120 BREATHS/min.

Inspiration time %

There are 6 fixed inspiration times, 20, 25, 33, 50, 67 and 80% of the breathing cycle.

Pause time %

There are 5 fixed pause times, 0, 5, 10, 20 and 30% of the breathing cycle.

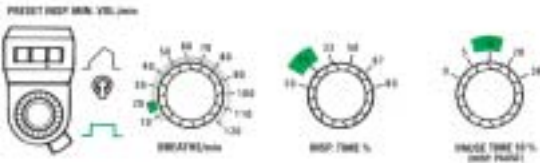

I:E ratio

Insp. time %	Pause	I:E ratio time %
20	0	1:4
20	5	1:3
25	0	1:3
20	10	1:2.3
25	5	1:2.3
33	0	1:2
25	10	1:1.9
33	5	1:1.6
20	20	1:1.5
33	10	1:1.3
25	20	1:1.2
20	30	1:1
50	0	1:1
33	20	1.1:1
25	30	1.2:1
50	5	1.2:1
50	10	1.5:1
33	30	1.7:1
67	0	2:1
50	20	2.3:1
67	5	2.6:1
67	10	3.4:1
67	20*	4:1
80	0	4:1

* Reduced to 13%

To the left is a conversion table for INSP. TIME % and PAUSE TIME % to I:E ratio for those who are more used to working with the latter.

On the basis of an I:E ratio, i.e. the relation of inspiration time to expiration time, the pause is allocated to inspiration time.

For example, insp. time 25% and pause time 10% = I:E ratio 35/65 = approx. 1:1.9.

If the ventilator has been set so that insp. time + pause time exceeds 80%, then expiration automatically begins when 20% of the respiratory cycle remains (safety function). The pause time is then reduced.

Example 1:

Preset insp. time = 67% → 67% inspiration
 Preset pause time = 20% → 13% pause
 20% expiration

Example 2:

Preset insp. time = 80% → 80% inspiration
 Preset pause time = 30% → 0% pause
 20% expiration

The settings are independent of changes in the patient's compliance and resistance.

Inspiration time settings of 33%, 67% or 80% should be avoided in volume-controlled respiration with accelerating flow patterns. With these settings patient triggering may cause the temporary partial blocking of the inspiration valve which, however, would be indicated by a minute volume alarm. Should the valve be blocked, the situation can be remedied immediately by switching over to a constant flow.

Inspiratory flow

In mode VOL. CONTR. (constant flow) or SIMV the inspiratory flow is calculated by:

$$\frac{\text{PRESET INSP. MIN. VOL. l/min}}{\text{INSP./TIME \%}}$$

Example:

PRESET INSP. MIN. VOL. l/min = 8 l/min
 INSP. TIME % = 25%
 Results in an inspiratory flow: = $8 \times 100/25$
 = 32 l/min

Or

Adjustment of INSP. TIME% (use reverse value)

20% = $1/5$ = 5
 25% = $1/4$ = 4
 33% = $1/3$ = 3
 50% = $1/2$ = 2
 67% = $2/1.5$ = 1.5
 80% = $4/1.25$ = 1.25

× PRESET INSP. MIN. VOL = inspiratory flow (l/min)

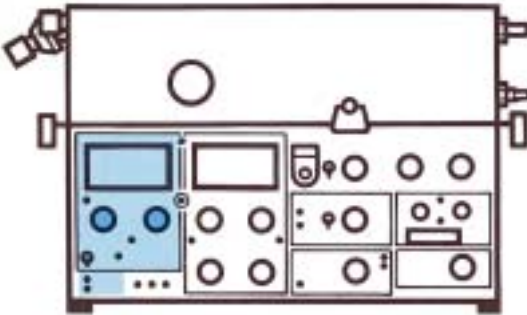

Expired minute volume

EXPIRED MINUTE VOLUME is indicated on a meter which has dual scales: 0-40 l/min and 0-4 l/min.

The scale 0-4 l/min is intended for use when greater accuracy, e. g. for infants, is needed.

The knobs for LOWER ALARM LIMIT and UPPER ALARM LIMIT also have the same dual scales.

The end stop positions for the knobs do not coincide with the end positions on the scale. This is correct and no attempt should be made to alter the range.

The desired scale is selected with the switch INFANTS/ADULTS.

The alarm limits for expired minute volume must always be set. If either of the knobs has been set in end position (out of scale), the yellow lamp SET MIN. VOL. ALARM flashes. The alarm limits are normally set at approx. 20% below and above the selected minute volume. The upper limit may be set at approx. 30% above the selected minute volume in the mode VOL. CONTR. + SIGH.

The APNEA ALARM is activated with audible signals and flashing light if the time between any two consecutive breaths, spontaneous or mandatory or a combination of the two, is greater than approximately 15 seconds (4 breaths per minute or less). The APNEA ALARM is not intended to and will not monitor for disconnections. The APNEA ALARM is operative in CPAP, PRESS. SUPPORT, SIMV and SIMV + PRESS. SUPPORT.

Failure of gas supply to the ventilator will result in visual and audible GAS SUPPLY ALARM signals. The GAS SUPPLY ALARM is not operative at respiratory rates over 80 breaths/min., and INSP. TIME % 20 or 25.

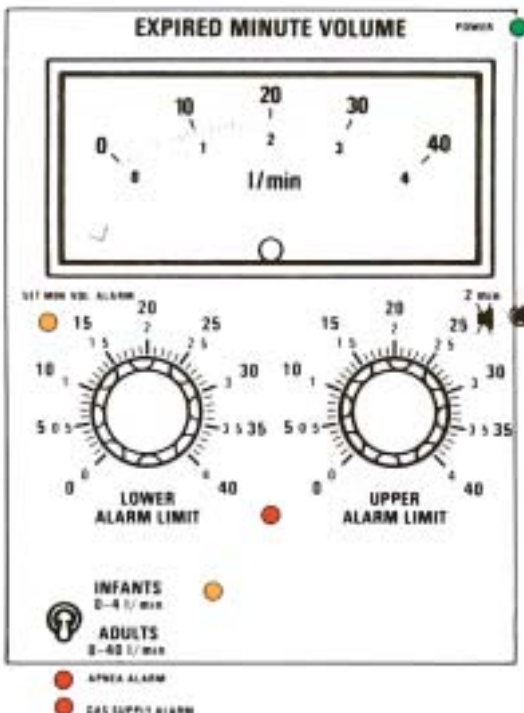

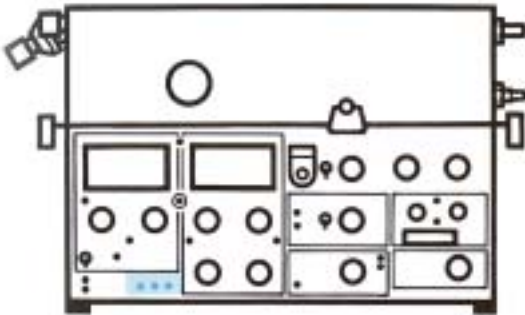

**INSP.
PAUSE
HOLD**



**EXP.
PAUSE
HOLD**



**GAS
CHANGE**

Special functions

Under the small hood below the UPPER ALARM LIMIT knob are three pushbuttons for special functions.

Inspiratory pause hold

When the pushbutton INSP. PAUSE HOLD is depressed, the valves close after inspiration and the pause is prolonged as long as the pushbutton is depressed.

This provides an exact measurement of the end inspiratory lung pressure. It may also give time for an equilibration of the blood gas and alveolar pressures.

Expiratory pause hold

The valves are closed, after the expiration, as long as the pushbutton EXP. PAUSE HOLD is depressed, i.e. a prolonged expiratory pause. This provides an exact measurement of the end expiratory lung pressure.

EXP. PAUSE HOLD must not be used in SIMV or SIMV + PRESS. SUPPORT mode. Two inspirations may occur at the same time. However, the UPPER PRESS. LIMIT is still functional.

Gas Change

The pushbutton GAS CHANGE is used, for instance, when it is desirable to rapidly alter the gas mixture to the patient. The concentration setting on the vaporizer/gas mixer/flowmeters must be altered first.

The inspiration and expiration valves open so that the pressure in the patient circuit is max. 20 cm H₂O.

During the gas changing time, the EXPIRED MINUTE VOLUME meter is zeroed automatically.

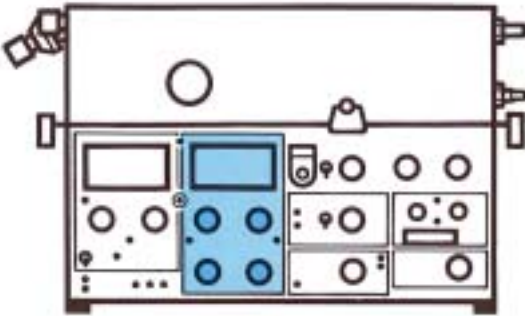

Airway Pressure

Airway pressure meter

The meter continually indicates the airway pressure reading.

Upper pressure limit

The knob UPPER PRESS. LIMIT is used to set the upper limit for airway pressure. When this pressure limit has been reached, inspiration is immediately discontinued and there is a change over to the expiratory phase. Visual and audible alarms are activated.

Since the inspiration is discontinued, the complete tidal volume will not be delivered and, consequently, the LOWER ALARM LIMIT for EXPIRED MINUTE VOLUME may be activated.

Upper pressure limit is connected in all modes.

There are safety catches on the knob at 80 and 100 cm H₂O.

PEEP

PEEP is the setting of a Positive End Expiratory Pressure, e.g. used to counteract the formation of atelectasis.

The PEEP range is from 0 to 50 cm H₂O.

There are safety catches on the PEEP knob at 0 and at 20 cm H₂O.

In case of a leakage, e.g. if a tracheal tube without cuff is being used, the PEEP-setting may cause self-triggering. To avoid this, the TRIG. SENSITIVITY should be set at a somewhat lower value.

The PEEP knob is prepared for NEEP (Negative End Expiratory Pressure). In order to use NEEP, it is necessary to connect auxiliary equipment to the expiration outlet. The NEEP range is from 0 to -10 cm H₂O.

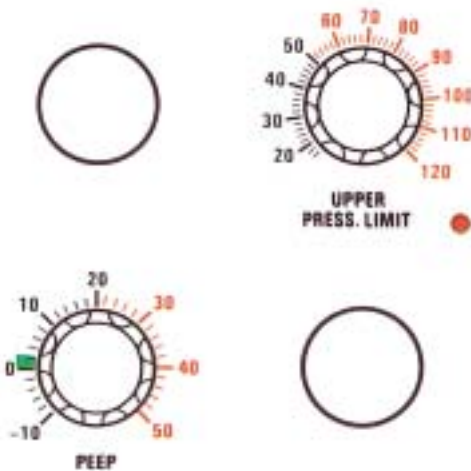

Trig. sensitivity

The knob TRIG. SENSITIVITY is used to set the value of negative pressure that the patient must produce in order to trigger a breath.

The TRIG. SENSITIVITY is relative to PEEP. For instance, PEEP +10 and TRIG. SENSITIVITY -2 cm H₂O mean that the patient must produce a pressure of -2 cm H₂O relative to the setting to trigger a breath.

This corresponds to a pressure of +8 cm H₂O relative to atmospheric pressure in the patient's airways.

The airway pressure, measured on the expiration side, is compared with the preset TRIG. SENSITIVITY + PEEP. If the airway pressure drops below TRIG. SENSITIVITY + PEEP, a breath is triggered.

If it is desirable for the patient to be able to easily trigger the ventilator, the knob is set at green value.

If it is undesirable for the patient to be able to trigger the ventilator, the knob is set at -20 cm H₂O.

Trig. sensitivity is connected in all modes except MAN. For further details, see description on different modes.

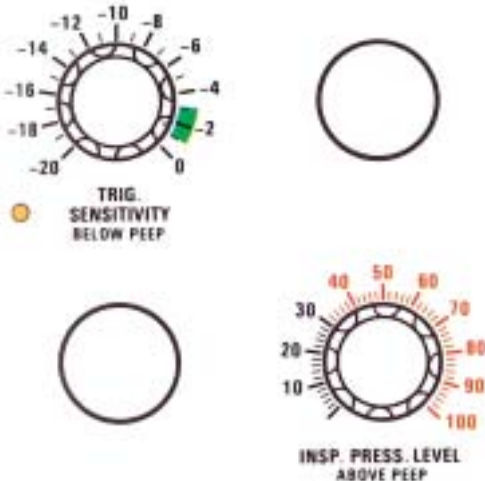

Inspiratory pressure level

The knob INSP. PRESS. LEVEL is used to set the constant inspiratory pressure, relative to PEEP, when any of the following modes of ventilation are used: PRESS. CONTR., PRESS. SUPPORT, SIMV + PRESS. SUPPORT.

A safety catch is located at 30 cm H₂O.

The total inspiratory pressure level also includes PEEP. This is why there is a marking under the PEEP knob leading to the INSP. PRESS. LEVEL knob. At a PEEP of +5 cm H₂O and an INSP. PRESS. LEVEL of +15 cm H₂O, the total inspiratory pressure level would be +20 cm H₂O, relative to atmospheric pressure.

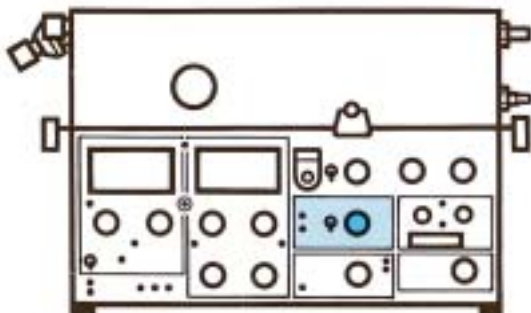

SIMV

SIMV (Synchronized Intermittent Mandatory Ventilation) means that the patient gets mandatory breaths controlled by the ventilator, and that he also has the possibility of breathing spontaneously.

The mandatory breaths are synchronized with the breaths of the patient so that he need not breathe against the ventilator.

SIMV-rate (SIMV BREATHS/min) is the rate of the mandatory breaths per minute. The rate is set between 0.4 and 4 breaths per minute on the LOW RATE scale, and between 4 and 40 breaths/min on the HIGH RATE scale. The desired rate is selected by means of a switch. There are two indicating lamps, one for each rate.

The tidal volume and the frequency can be read on the digital display.

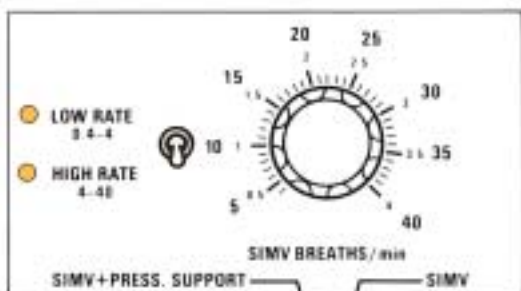

Minute volume, respiratory rate, inspiration time and pause time must be set for the SIMV mode. These functions determine the respiratory pattern of the mandatory breaths. The BREATHS/min must always be set higher than the SIMV BREATHS/min to allow time for the spontaneous period.

The SIMV cycle is divided into SIMV period and spontaneous period. See page 2:14.

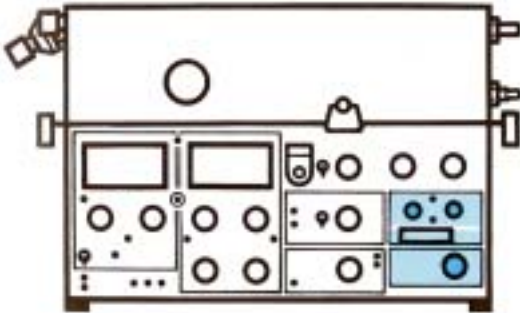

O₂ alarm

Alarm limits for O₂ concentration are set with the knobs UPPER ALARM LIMIT and LOWER ALARM LIMIT. The SET O₂ ALARM flashes if the alarm limits have not been set.

The end stop positions for the knobs do not coincide with the end positions on the scale. This is correct and no attempt should be made to alter the range.

The alarm limits are set as follows:

- Set O₂ concentration on the gas mixer/flowmeters.
- Set the parameter selector at O₂ CONC. % and read the value.
- Set the alarm limits at approx. 6% by volume (3 scale divisions) below and above the O₂ concentration reading on the digital display.

Visual and audible alarms are activated when any of the alarm limits is exceeded.

If the O₂ cell is expended but still mounted in the ventilator, the O₂ cell has to be disconnected. If not, the LOWER ALARM LIMIT will activate alarm.

If no O₂ cell is mounted, neither digital displays nor alarm is activated when the parameter selector is set at O₂ CONC. %.

Parameter selection

A digital display of the O₂ concentration is given when the selector is set in position O₂ CONC. %.

Other displayable parameters are:

INSPIRED TIDAL VOLUME ml—the volume provided by the ventilator at each breath.

EXPIRED TIDAL VOLUME ml—the volume produced by the patient at each breath (with no leakage in the patient circuit).

EXPIRED MINUTE VOLUME l/min—(also indicated on the EXPIRED MINUTE VOLUME meter).

PEAK PRESSURE cm H₂O—the pressure at the end of the inspiration phase.

PAUSE PRESSURE cm H₂O—the pressure at the end of the pause. This pressure normally corresponds to the maximal alveolar pressure in the lungs.

MEAN AIRWAY PRESSURE cm H₂O—the mean value in the patient circuit, continually measured.

BREATHS/min—the respiratory rate of the patient. In controlled ventilation, this value equals the set respiratory rate plus eventual patient triggered breaths. In the SIMV mode, it is the sum of the spontaneous and the mandatory breaths. In the CPAP and PRESSURE SUPPORT modes, the value represents the spontaneous breaths/min of the patient.

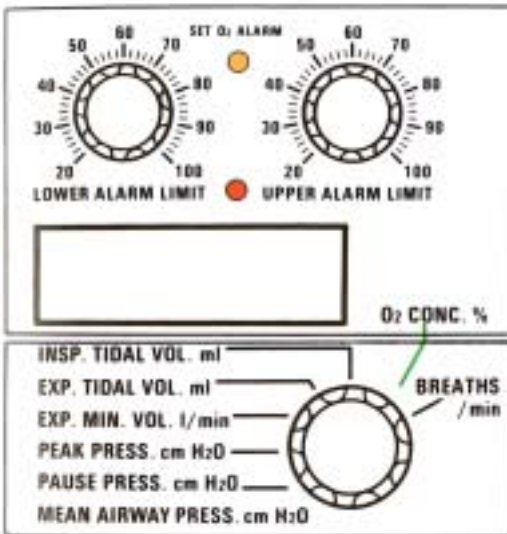

Controlled ventilation

2
12

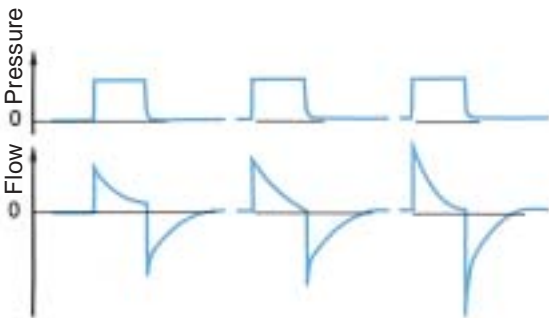
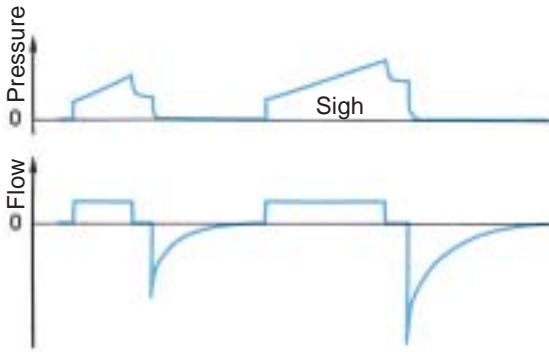
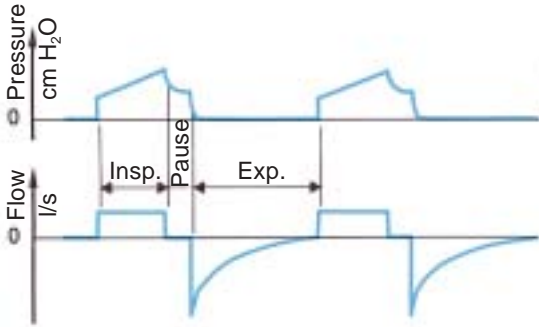

Volume controlled ventilation

Volume controlled ventilation (VOL. CONTR.) ensures that the patient receives a certain preset tidal volume.

Servo Ventilator 900 C delivers a specific tidal volume at a specific rate during a specific time (preset values).

If the patient makes inspiratory efforts so that the airway pressure falls below the triggering level, a preset tidal volume will be delivered earlier and the expired minute volume will increase.

A constant or an accelerating flow can be selected.

A patient trigger initiates a breath with the preset values.

Volume controlled ventilation + sigh

In this mode of operation, the Servo Ventilator 900 C delivers a sigh every hundredth breath. At sigh, double tidal volume is delivered since the flow is constant and the inspiration time is doubled.

The first sigh will occur at the second inspiration after setting the mode selector to VOL. CONTR. + SIGH.

The UPPER ALARM LIMIT for EXPIRED MINUTE VOLUME may have to be set somewhat higher in this mode.

Pressure controlled ventilation

In the mode PRESS. CONTR., gas is delivered at a constant pressure during the set inspiration time.

The pressure is set with the knob INSP. PRESS. LEVEL.

The flow is decelerating in this mode.

The set inspiratory pressure, respiratory rate, and inspiration time determine the volume the patient will receive.

Servo Ventilator 900 C works with a constant pressure during the entire inspiration.

The minute volume can be read on the EXPIRED MINUTE VOLUME meter.

Tidal volume can be read on the digital display with the parameter selector in position INSP. TIDAL VOLUME or EXP. TIDAL VOLUME.

In case of leakage in the system, e.g. due to the use of a tracheal tube without cuff, a pause time of 0% is recommended to ensure that the measurement of the expired minute volume will be as correct as possible.

A patient trigger initiates a breath with the preset values.

WORKING PRESSURE and UPPER PRESS. LIMIT must always be set at adequate values. This is extremely important when treating infants.

Supported ventilation

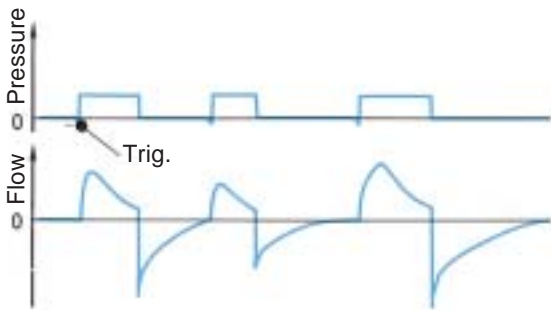

Pressure supported ventilation

PRESS. SUPPORT is a spontaneous breathing mode in which the patient must trigger breaths.

Some applications for PRESS. SUPPORT are: weaning, patients suffering from asthma or, in post-operative use, when the patient's own breathing efforts are insufficient.

When the patient triggers the ventilator, an inspiration pressure support is given at a preset constant pressure.

The ventilator regulates the pressure during inspiration so that it corresponds to preset INSP. PRESS. LEVEL + PEEP.

The pressure during expiration drops to 0 cm H₂O, or alternatively to PEEP-level.

The change from inspiration to expiration occurs when the flow decreases to 25% of the peak inspiratory flow.

There are also safety functions to control the change from inspiration to expiration, for instance in the case of a leakage.

Expiration will then start when the step motor has closed the inspiratory valve and the airway pressure has increased to +3 cm H₂O above the preset INSP. PRESS. LEVEL + PEEP or after 80% of the preset respiratory cycle.

Because of this safety function the respiratory rate should always be set with the knob BREATHS/min.

Supported ventilation

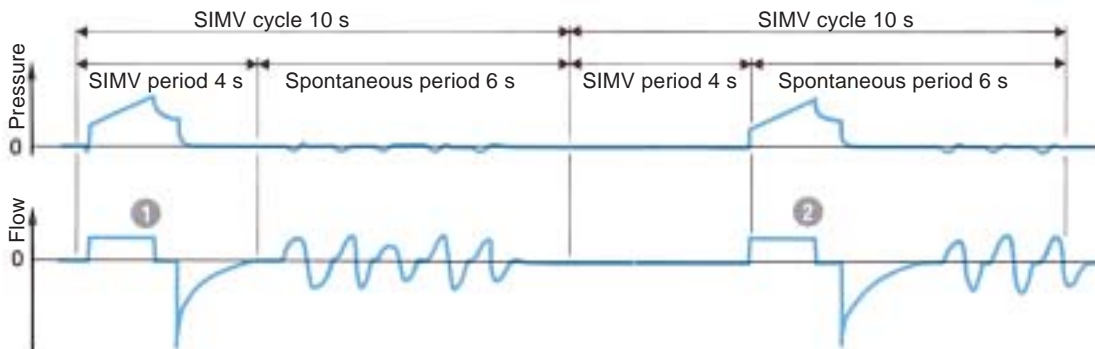

① A patient trig. during the SIMV period initiates a mandatory breath. After that, spontaneous breathing.

② During the SIMV period no breath has been triggered. The next period begins with a mandatory breath. After that, spontaneous breathing.

SIMV

SIMV (Synchronized Intermittent Mandatory Ventilation) means that a preset number of breaths are ventilator controlled, mandatory breaths (SIMV BREATHS/min). The patient may breathe spontaneously between those breaths.

Breathing pattern and tidal volume for the mandatory breaths are selected with the knobs PRESET INSP. MIN. VOL., BREATHS/min, INSP. TIME % and PAUSE TIME %.

The time in seconds for one SIMV cycle is calculated from the formula

$$\frac{60}{\text{preset SIMV freq.}}$$

prescribed SIMV freq.

The SIMV cycle is divided into SIMV period and spontaneous period.

The spontaneous period consists of spontaneous breathing time if the patient has triggered a mandatory breath during the previous SIMV period.

If the patient has insufficient spontaneous breathing, the maximum time between two mandatory breaths is just over one SIMV cycle, (cp 1 to 2 in the picture above).

To ensure adequate ventilation, apnea alarm is activated if the time between two breaths exceeds approx. 15 sec., and the minute volume alarm is activated if any of the preset alarm limits is exceeded.

Either of these alarms is a command to take the necessary action (e.g. clinical judgement of the patient, increased SIMV frequency, altered trig. sensitivity).

The SIMV period is approx. equal to one respiratory cycle.

The spontaneous period is calculated as SIMV cycle-SIMV period.

Example:

$$\text{BREATHS/min } 15 \rightarrow \text{SIMV period} = \frac{60}{15} = 4 \text{ s}$$

$$\text{SIMV BREATHS/min } 6 \rightarrow \text{SIMV cycle} = \frac{60}{6} = 10 \text{ s}$$

$$\text{Spontaneous period} \rightarrow 10 - 4 = 6 \text{ s}$$

A patient trig during the SIMV period initiates a breath with the preset values. A patient trig during the spontaneous period opens the inspiratory valve, and the patient can breathe through the ventilator.

Supported and spontaneous ventilation

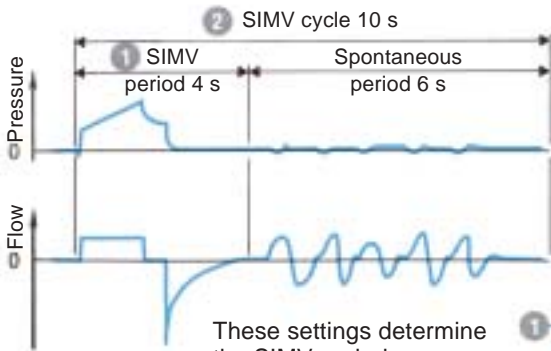

These settings determine the SIMV period. This setting determines the SIMV cycle.

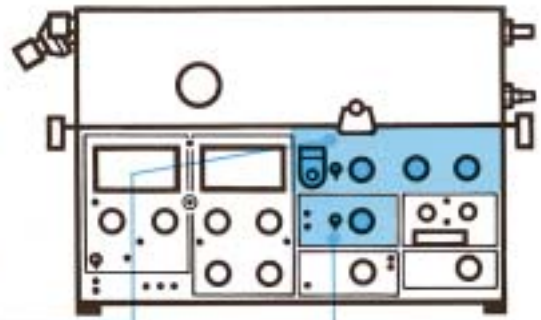

SIMV + pressure support

The main difference between this mode and the SIMV mode is that the spontaneous, triggered breaths are pressure supported.

The level of support is set with the control INSP. PRESS. LEVEL. The level also includes PEEP.

See also description of pressure support on page 2:13.

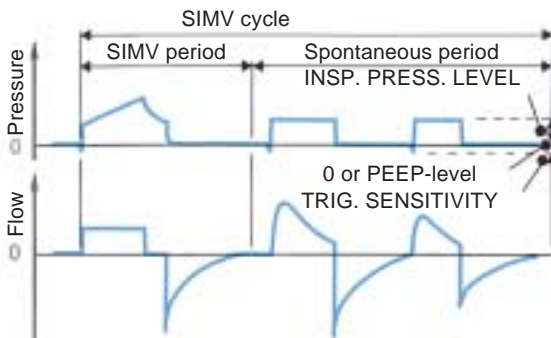

Mandatory breath Pressure supported spontaneous breaths

Care should be taken in setting the preset BREATHS/min, so that the spontaneous pressure-supported breaths are not prematurely time-cycled rather than flow-cycled to expiration.

Spontaneous ventilation CPAP

In this mode, CPAP (Continuous Positive Airway Pressure), the patient breathes spontaneously through the ventilator at an elevated pressure level. The positive pressure is set with the PEEP control.

The TRIG. SENSITIVITY control must be set at a position which allows the patient to trigger the ventilator. Upon triggering, the inspiration valve opens, and the patient can inspire through the ventilator and control the tidal volume and respiratory rate.

To avoid self-triggering due to leakage, the trig. level should be set at a low value.

If CPAP (PEEP) = 0, it will be possible to check the patient's ability to breathe spontaneously without help from the ventilator.

The minute volume, tidal volume and respiratory rate can be monitored.

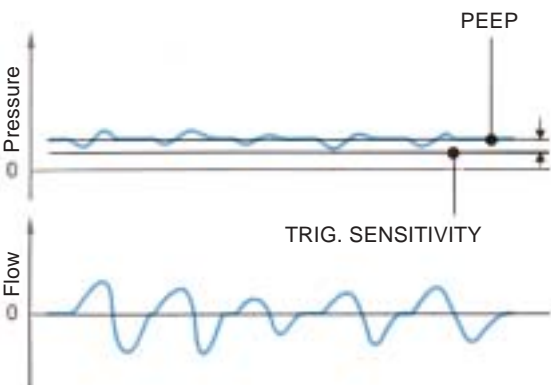

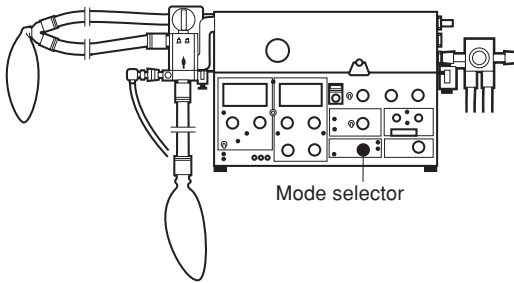
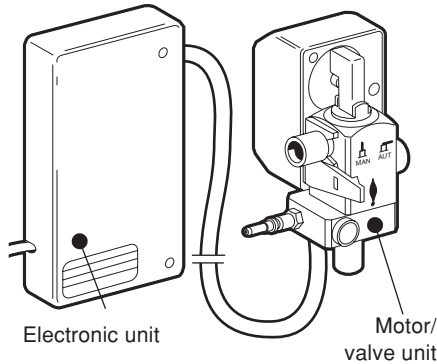

If the breathing bag becomes overfilled, the expiratory valve in the ventilator may go to a locked position.

To unlock the valve:

- Set UPPER PRESS. LIMIT below 20 cm H₂O.
- Squeeze the breathing bag and check that the pressure in the bag is lowered.
- Set UPPER PRESS. LIMIT back to the lowest possible value for normal operation.

If the breathing bag becomes overfilled with the manual ventilation valve in position AUT:

- Remove the breathing bag.
- Exchange the manual ventilation valve.

Manual ventilation

The Manual Ventilation Accessory with Motor consists of two units:

- Electronic unit
- Motor/valve unit

With this accessory switching between manual ventilation and other modes is done with the mode selector.

The valve is automatically set to the correct position by a motor. The switch-over time is about 5 seconds. An alarm with audible signals and red light is activated if the positions of the valve and mode selector are not the same.

In position MAN., the breathing bag is filled to a pressure of about 4 cm H₂O, then the inspiratory valve closes.

When the breathing bag is squeezed, the gas flows to the patient via a non-return valve.

Always set UPPER PRESS. LIMIT at the lowest possible value for normal operation.

The APNEA alarm is inoperative during manual ventilation.

In the case of a power failure, manual ventilation is not possible unless an external power pack is connected.

PEEP cannot be used in manual ventilation mode.

Set the mode selector to VOL. CONTR. immediately before connecting the ventilator to a patient. The reason is to zero the gas flow reading.

At spontaneous breathing during manual ventilation the following readings will be incorrect.

- the displayed values for BREATHS/min., EXP. TIDAL VOLUME and EXP. MINUTE VOLUME.
- the alarm monitoring instrument EXPIRED MINUTE VOLUME.

The accuracy of the EXPIRED MINUTE VOLUME meter reading decreases. After about 5 minutes, the accuracy is about ± 2 l/min. To get a correct meter reading, the breathing bag should be squeezed at least every 5 minutes.

For spontaneous breathing, the PRESSURE SUPPORT mode is recommended. The INSP. PRESS. LEVEL should be set at zero or at a low value. This enables continuous monitoring of pressure and volume.

Patient safety

In this chapter:

Protective devices 3:2

Alarm schedule 3:4

Protective devices

Alarms

There are a number of alarms on the ventilator which protect the patient by alerting ward personnel to any malfunctions. Alarms are given with audible signals and flashing red lights. An audible signal only is given as alarm for power failure and certain technical malfunctions.

Some audible alarms can be switched off for a period of approximately 2 minutes. For details see the alarm schedule on page 3:4.

In addition there are panel indicators with fixed or flashing yellow lights.

Examples are given in chapter 8, Troubleshooting, regarding actions for various alarms.

The patient is protected against high pressure by an electronic limiter, which is controlled by the knob UPPER PRESS. LIMIT.

If the value set with this knob is too high or if the limiting function should fail, the pressure is limited to the set WORKING PRESSURE.

The WORKING PRESSURE is prevented from exceeding the set value by a safety valve and cannot be set at values exceeding 120 cm H₂O.

As an extra patient safety protection against too high an airway pressure, there is a HIGH PRESSURE PROTECTION circuit incorporated when either of the modes CPAP, PRESS. CONTR. or PRESS. SUPPORT is selected. This protection circuit functions when the airway pressure in the inspiration channel for some reason, e.g. coughing, exceeds 30 cm H₂O above INSP. PRESS. LEVEL/PEEP level.

Important!

The SV 900 is not designed to withstand severe negative pressures, which, if applied to the system may damage the internal pressure transducers rendering the unit inoperable.

Transducer pressure range

SV 900 up to and including SIN 188499 are factory equipped with pressure transducers that will tolerate pressures down to -100 cm H₂O(mbar), whereas units from S/N 188500 are factory equipped with pressure transducers that will tolerate pressures ranging from -500 cm H₂O(mbar) to +500 cm H₂O(mbar).

Earlier units may have been retrofitted with Transducer Upgrade EM12102/I featuring the same pressure tolerance as units with S/N \geq 188500. Upgraded units are identified with a label '!Upgrade EMO12/02/I' attached to the inside of the pneumatic unit lid.

If closed system suctioning is applied, the following must be considered:

A suctioning flow exceeding the flow delivered by the ventilator will result in a negative pressure affecting the patients airways as well as the ventilators breathing system.

Do not use the "Pause hold" function during the procedure.

All audible alarms, with the exception of upper pressure limit for airway pressure and alarm for mains power failure, are switched off for a period of 2 minutes when the button  2 min is depressed, while the red light continues flashing. This means that no new audible alarm will be possible during approximately 2 minutes.

To switch off the power failure alarm, the button must be depressed until the audible alarm stops.

The APNEA ALARM is not intended to and will not monitor for disconnections.

Protective devices

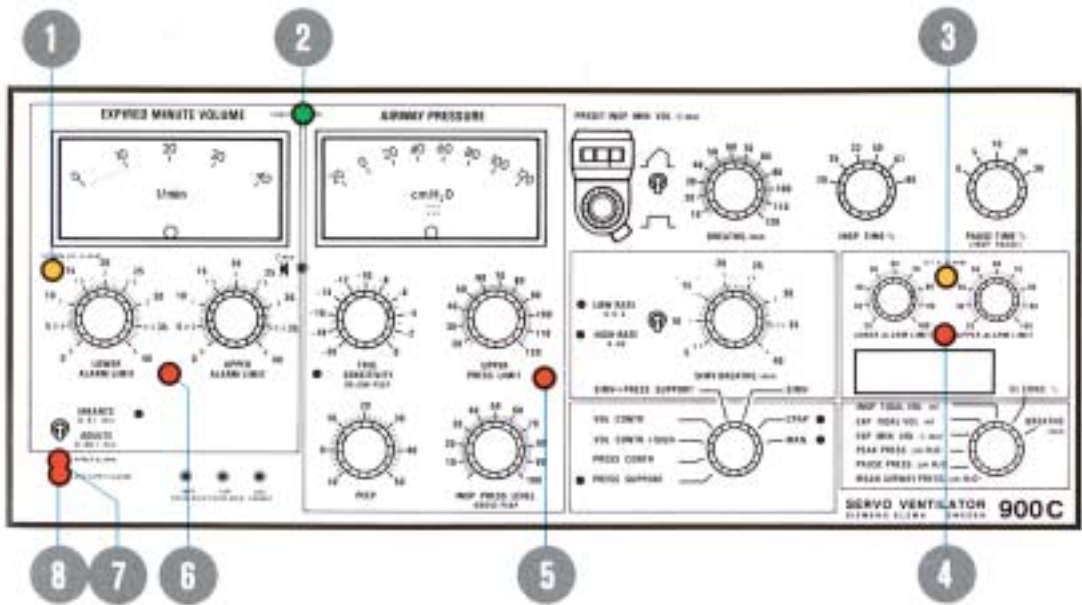

1 Set minute volume alarm

Indicates that the alarm limits for expired minute volume have not been set.

2 Mains power failure

The green lamp for POWER ON goes out. Slow audible signals which stop after 5-10 minutes.

3 Set O₂ alarm

Indicates that the alarm limits for O₂ concentration have not been set.

4 Alarm limit, O₂ concentration

Upper or lower alarm limit has been exceeded. If no O₂ cell is mounted, neither digital displays nor alarm is given.

A deterioration in the linearity and/or a rapid fall in the values of O₂ concentration, despite adequate O₂ supply, indicates that the O₂ cell is exhausted.

5 Upper pressure limit, airway pressure

The airway pressure exceeds the preset upper pressure limit. When the alarm is activated, inspiration and/or pause in progress is immediately terminated and changed to

expiration. The alarm is given as a single audible signal and a visual flashing signal.

6 Alarm limit, expired minute volume

Upper or lower alarm limit has been exceeded. There are two alarm limit settings:

UPPER ALARM LIMIT	3-43 l/min (adults) 0-4.3 l/min (infants)
LOWER ALARM LIMIT	0-37 l/min (adults) 0-3.7 l/min (infants)

7 Apnea alarm

The APNEA ALARM is activated with audible signals and flashing light if the time between any two consecutive breaths, spontaneous or mandatory or a combination of the two, is greater than approximately 15 seconds (4 breaths per minute or less). The APNEA ALARM is not intended to and will not monitor for disconnections. The APNEA ALARM is operative in CPAP, PRESS. SUPPORT, SIMV and SIMV + PRESS. SUPPORT.

8 Gas supply alarm

This alarm is inoperative if the respiratory rate exceeds 80 breaths/min (with inspiration time 20 or 25%).

In the CPAP and PRESS. SUPPORT modes, a patient trig is required to activate the alarm.

Alarm schedule

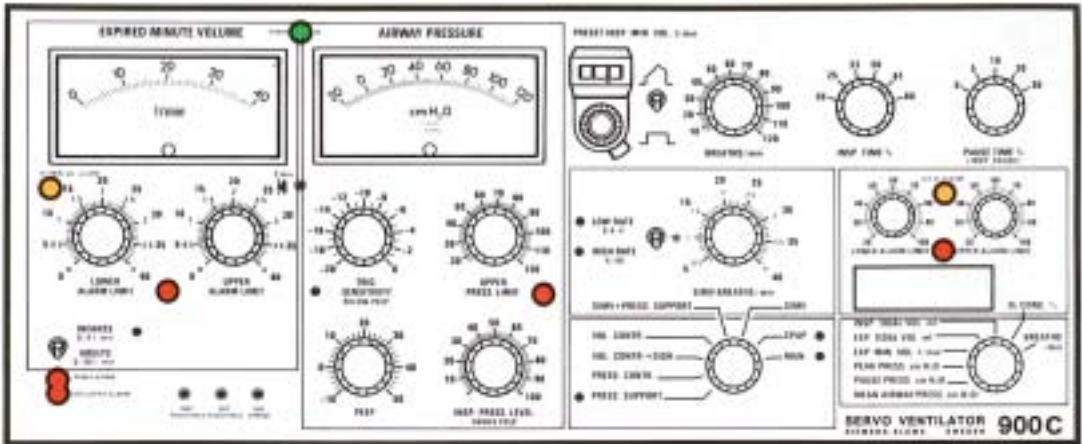

2 min

Alarm	Visible	Audible	
SET. MIN. VOL. ALARM	●		🔊
SET O ₂ ALARM	●		🔊
GAS SUPPLY ALARM	●	🔊	🔊
Mains power failure	● *	🔊	🔊 **
Alarm limit, EXP. MIN. VOL.	●	🔊	🔊
UPPER PRESS. LIMIT	●	🔊	🔊
APNEA ALARM	●	🔊	🔊
Alarm limit, O ₂ CONC. %	●	🔊	🔊

*The green lamp goes out

**The button must be depressed until the alarm stops

Set-ups

The Servo Ventilator 900 C is designed for several different applications.

It can be positioned in many different ways, e.g. on a cart, on an anesthesia table, on a wall rail, or in an ambulance or a helicopter.

In this chapter:

Intensive care	4:2
Anesthesia	4:4
Patient transportation ...	4:6

Intensive care 1

Two proposals are given regarding the set-up of Servo Ventilator 900 C in intensive care.

This is only an example of a possible set-up. Some of the equipment shown is available in

different versions, e.g. for adults and children. For details, please see "Products and Accessories" catalogue and, for patient tubing, "Assembling instructions with order form".

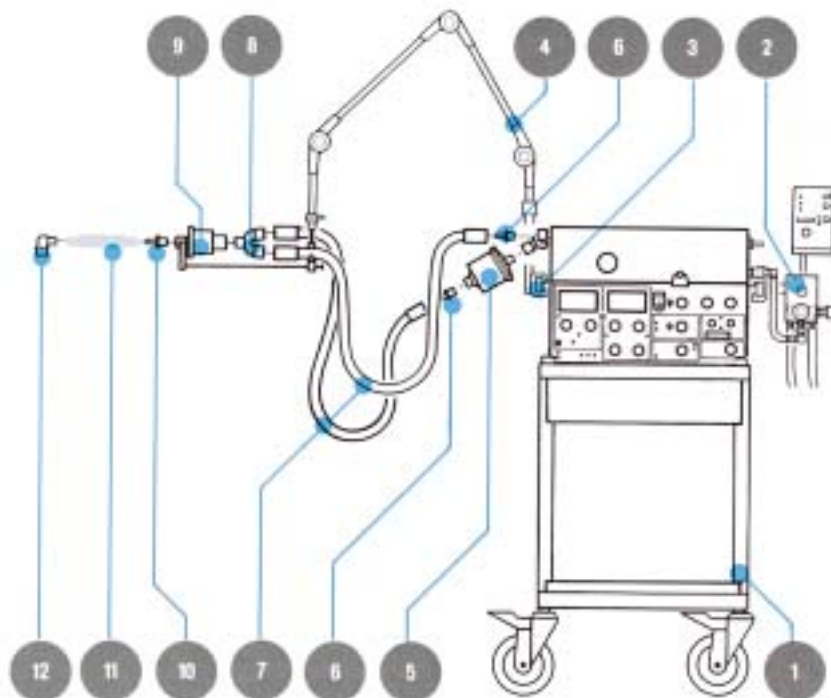

Basic equipment

Servo Ventilator 900 C

- ① Mobile cart
- ② Mixer
- ③ Clamp
- ④ Support arm
- ⑤ Bacteria filter
- ⑥ Nipple connector
- ⑦ Patient tubes
- ⑧ Y-piece
- ⑨ Servo Humidifier
- ⑩ Nipple connector
- ⑪ Flex tube
- ⑫ Angled connector

Extra equipment

CO₂ Analyzer 930

Lung Mechanics Calculator 940

Mingograf Recorder

Recorder Cable for Servo Ventilator 900 C

Manual ventilation accessory

Intensive care 2

This is only an example of a possible set-up. Some of the equipment shown is available in different versions, e.g. for adults and children.

For details, please see "Products and Accessories" catalogue and, for patient tubing, "Assembling instructions with order form."

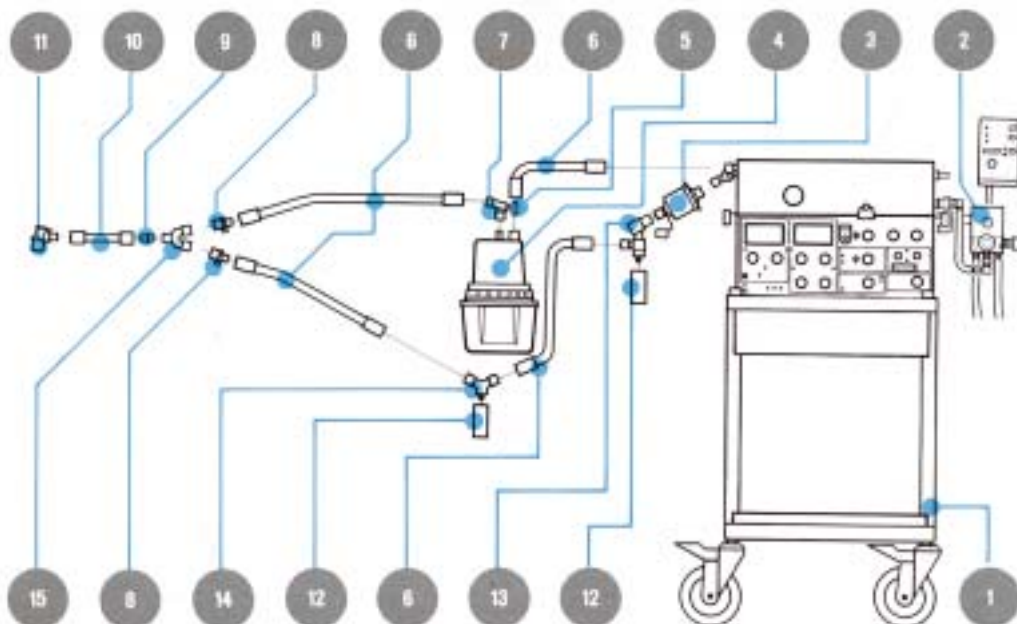

Basic equipment

Servo Ventilator 900 C

- ① Mobile cart
- ② Mixer
- ③ Bacteria filter
- ④ Humidifier
- ⑤ Nipple connector
- ⑥ Patient tubes
- ⑦ Muff, angled
- ⑧ Nipple
- ⑨ Nipple
- ⑩ Flex tube
- ⑪ Angled connector
- ⑫ Cup for water trap

⑬ Exp. water trap

⑭ Water trap

⑮ Y-piece

Extra equipment

CO₂ Analyzer 930

Lung Mechanics Calculator 940

Mingograf Recorder

Recorder Cable for Servo Ventilator 900 C

Manual ventilation accessory

Anesthesia 1

Two proposals are given regarding the set-up of Servo Ventilator 900 C in anesthesia applications.

This is only an example of a possible set-up. Some of the equipment shown is available in

different versions, e.g. for adults and children. For details, please see "Products and Accessories" catalogue and, for patient tubing "Assembling instructions with order form".

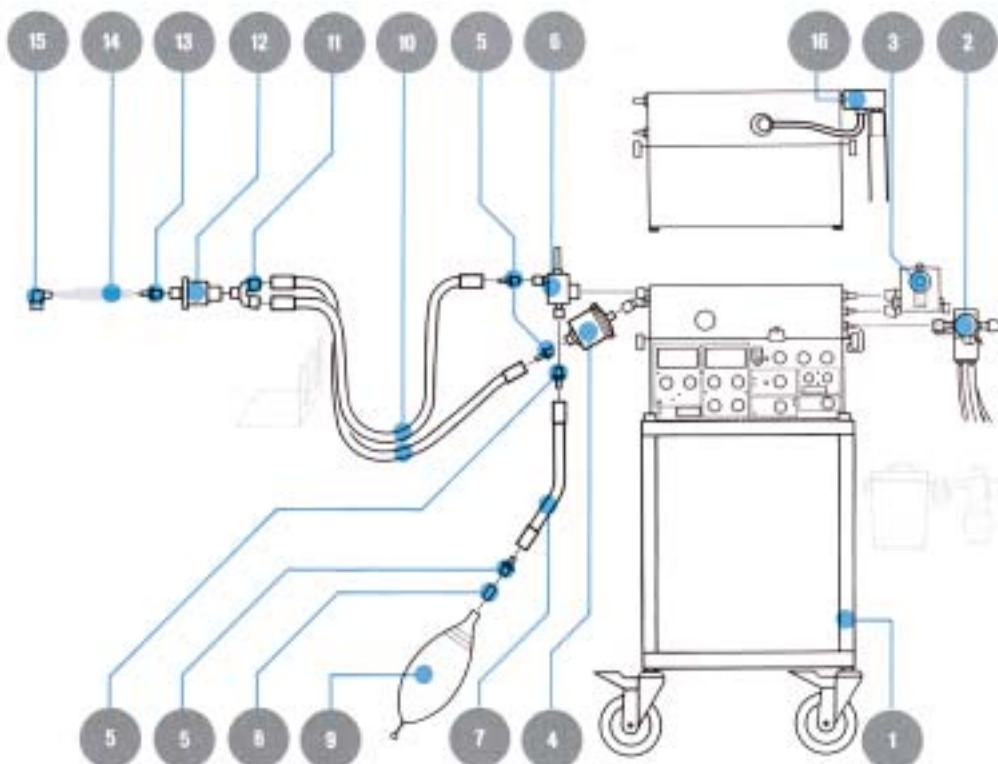

Basic equipment

Servo Ventilator 900 C

- ① Mobile cart
- ② Mixer
- ③ Vaporizer
- ④ Bacteria filter
- ⑤ Nipple connector
- ⑥ Manual ventilation accessory
- ⑦ Tube
- ⑧ Tube joint
- ⑨ Breathing bag
- ⑩ Patient tubes
- ⑪ Y-piece
- ⑫ Servo Humidifier

- ⑬ Nipple connector
- ⑭ Flex tube
- ⑮ Angled connector
- ⑯ Gas evacuation equipment

Extra equipment

- CO₂ Analyzer 930
- Lung Mechanics Calculator 940
- Mingograf Recorder
- Recorder Cable for Servo Ventilator 900 C

Anesthesia 2

This is only an example of a possible set-up. Some of the equipment shown is available in different versions, e.g. for adults and children.

For details, please see "Products and Accessories" catalogue and, for patient tubing, "Assembling instructions with order form."

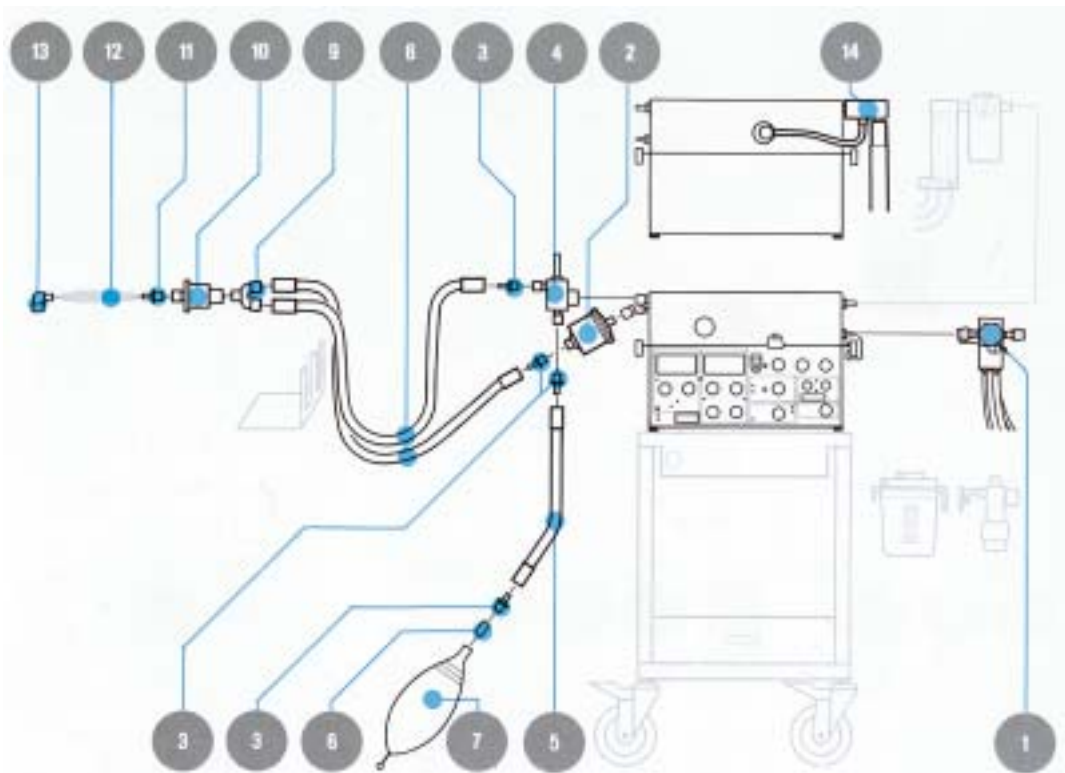

Basic equipment

Servo Ventilator 900 C

Anesthesia table

Rotameter box

- ① Mixer
- ② Bacteria filter
- ③ Nipple connectors
- ④ Manual ventilation accessory
- ⑤ Tube
- ⑥ Tube joint
- ⑦ Breathing bag
- ⑧ Patient tubes
- ⑨ Y-piece

- ⑩ Servo Humidifier
- ⑪ Nipple connector
- ⑫ Flex tube
- ⑬ Angled connector
- ⑭ Gas evacuation equipment
Suction equipment

Extra equipment

CO₂ Analyzer 930

Lung Mechanics Calculator 940

Mingograf Recorder

Recorder Cable for Servo Ventilator 900 C

Patient transportation

A proposal is given regarding the set-up of Servo Ventilator 900 C during patient transportation within the hospital, in an ambulance or a helicopter. This is only an example of a possible set-up.

Some of the equipment shown is available in different versions, e.g. for adults and children. For details, please see "Products and accessories" catalogue and, for patient tubing "Assembling instructions with order form".

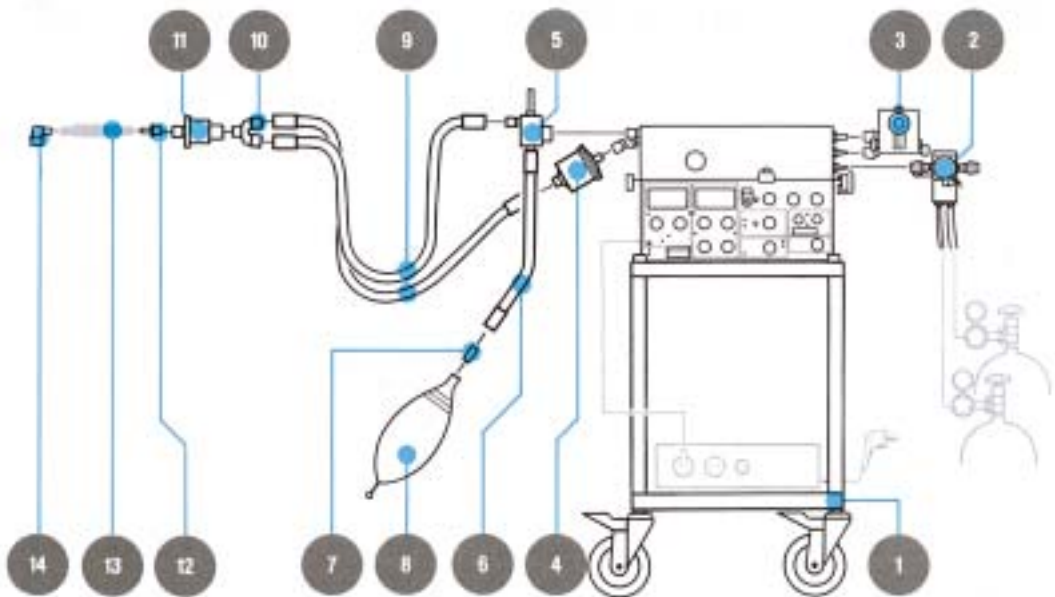

Basic equipment

Servo Ventilator 900 C

- ① Mobile cart
- ② Mixer
- ③ Vaporizer
- ④ Bacteria filter
- ⑤ Manual ventilation accessory
- ⑥ Tube
- ⑦ Tube joint
- ⑧ Breathing bag
- ⑨ Patient tubes
- ⑩ Y-piece

- ⑪ Servo Humidifer
- ⑫ Nipple connector
- ⑬ Flex tube
- ⑭ Angled connector

Power pack
Gas cylinders

Extra equipment

CO₂ Analyzer 930

Lung Mechanics Calculator 940

Preparations

If any malfunction is detected during the preparations, see chapter 8, Troubleshooting, or chapter 13, Calibration.

In this chapter:

Prechecks and presettings	5:2
Connections	5:3

Prechecks and presettings

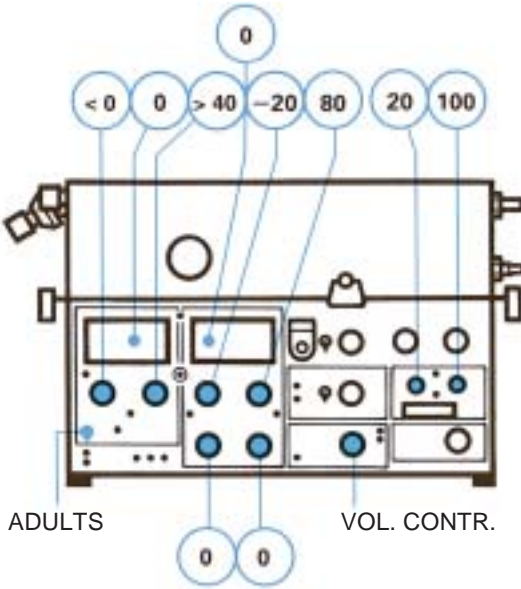

1

Make sure that the ventilator has been cleaned (see the log sheet).

2

Set the following on the ventilator:

- Mode selector at VOL. CONTR.
- Alarm limits to end positions, according to the picture.
- Scale range for ADULTS.
- TRIG. SENSITIVITY to -20 cm H₂O.
- UPPER PRESS. LIMIT to 80 cm H₂O.
- PEEP and INSP. LEVEL to 0 cm H₂O.

3

Make sure that the meters for EXPIRED MINUTE VOLUME and AIRWAY PRESSURE give a zero reading. If not, see Calibration, chapter 13.

Connections

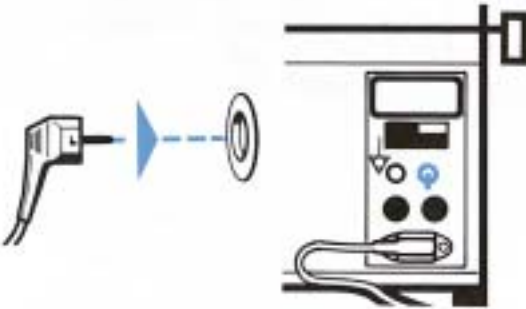

1

Connect patient tubes, holder arm, humidifier, test lung and, if required, manual ventilation accessory and gas evacuation accessory. For details, see previous chapter.

The Manual Ventilation Accessory 963 must not be connected to Servo Ventilator 900 C. Always use the manual ventilation accessory intended for Servo Ventilator 900 C only.

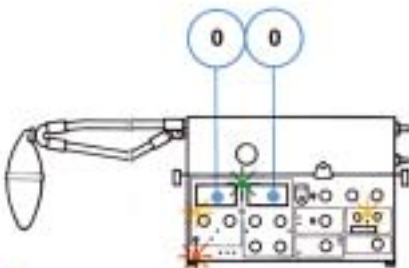

- POWER ON
- GAS SUPPLY ALARM
- SET MIN. VOL. ALARM
- SET O₂ ALARM

2

If required, connect CO₂ Analyzer 930 and Lung Mechanics Calculator 940.

3

- Connect the ventilator to mains.
- Set the mains switch on the rear of the ventilator to on. The switch has to be pulled out before switching.
- Make sure that the green lamp lights up when you switch on.
- Make sure that the meters for EXPIRED MINUTE VOLUME and AIRWAY PRESSURE still give a zero reading. If not, see Calibration, chapter 13.
- Make sure that the GAS SUPPLY ALARM activates.
- Make sure that the SET MIN. VOL. ALARM and SET O₂ ALARM flash.

4

Connect gases:

Alternative 1, via O₂-air mixer or via O₂-N₂O/ O₂-air mixer

- Set the desired O₂ concentration.

At extremely high flows it may be necessary to increase the working pressure, in order to obtain the desired minute volume.

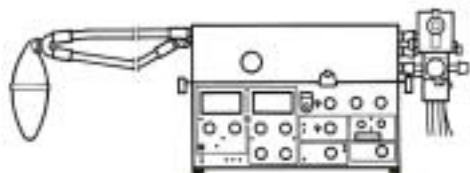

Alternative 2, via O₂-N₂O/O₂-air mixer and vaporizer

- Connect a Halothane, Enflurane or Isoflurane vaporizer.
- Set the desired O₂ concentration.

Alternative 3, via low-pressure flowmeters

- Connect O₂-N₂O (air) via low-pressure flowmeters, necessary pressures at least equal to WORKING PRESSURE.
- Set the desired flow proportions of O₂ and N₂O on the flowmeters, so that the total gas flow exceeds PRESET INSP. MIN. VOL. of the ventilator by 10-20%. The working pressure will be constant and the flow pattern unchanged in mode VOL. CONTR. In other ventilation modes, only breaths with limited tidal volumes can be maintained. The limitation is shown by falling WORKING PRESSURE.

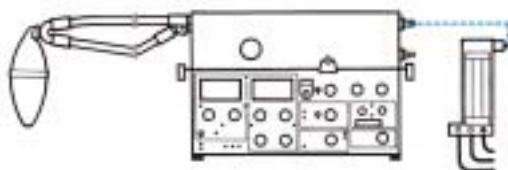

Alternative 4, compressed air

- Connect compressed air.

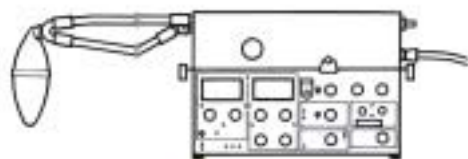

Check on functions

- Carry out a check on functions according to chapter 6.

Check on functions

A check on functions must always be carried out after cleaning and before connecting a patient.

Accessories: Patient tubes, Y-piece, test lung and manual ventilation accessory. If any malfunction is detected during the check, see chapter 8, Troubleshooting, or chapter 13, Calibration.

In this chapter:

1. Checks prior to connection of power and gas 6:2
2. Start-up 6:2
3. Check for leakages 6:3
4. Check, manual ventilation 6:3
5. Upper pressure limit alarm 6:4
6. Minute volume 6:4
7. Minute volume alarm . 6:4
8. O₂ alarm 6:5
9. Apnea alarm 6:5
10. Digital display 6:6
11. Check on pressure levels 6:6
12. Mains supply failure .. 6:6
13. Log sheet..... 6:6

Prechecks

If preparation and prechecks, according to chapter 5, have been done, start from para. 3.

1. Checks prior to connection of power and gas

- Connect patient tubes, Y-piece, holder arm and humidifier.
- Make sure that the meters for AIRWAY PRESSURE and EXPIRED MINUTE VOLUME give a zero reading.
- Set the mode selector at VOL. CONTR.
- Set alarm limits to end positions, according to the picture.
- Set the scale range for ADULTS.
- Set the TRIG SENSITIVITY to -20 cm H₂O.
- Set the UPPER PRESS. LIMIT to 80 cm H₂O.
- Set PEEP and INSP. PRESS. LEVEL to 0 cm H₂O.

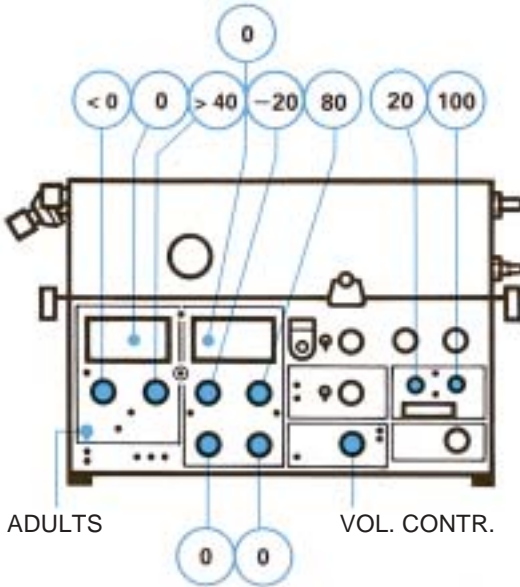

2. Start-up

- Connect the ventilator to mains.
- Set the mains switch on the rear of the ventilator to on.
- Make sure that the green lamp lights up when you switch on.
- Make sure that the meters for AIRWAY PRESSURE and EXPIRED MINUTE VOLUME still give a zero reading.
- Make sure that GAS SUPPLY ALARM activates.
- Make sure that SET MIN. VOL. ALARM and SET O₂ ALARM flash.

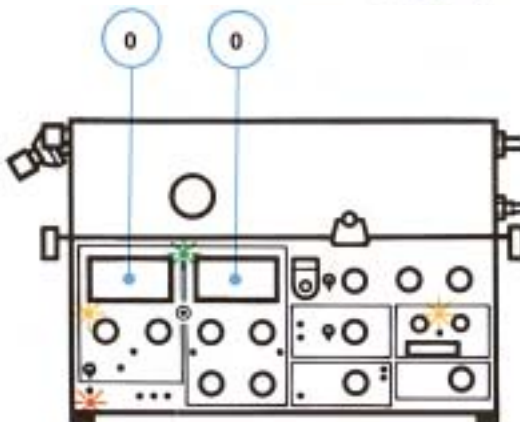
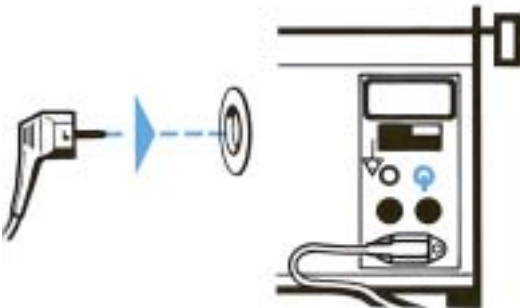

- POWER ON
- SET MIN. VOL. ALARM
- SET O₂ ALARM
- GAS SUPPLY ALARM

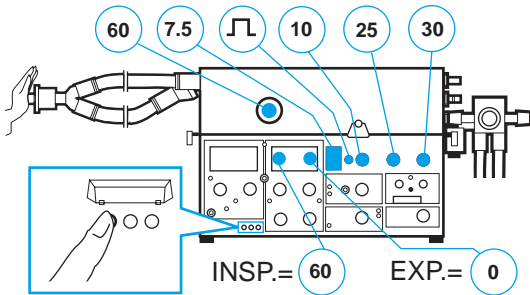

3. Check for leakage

- Connect gases according to chapter 5.
- Set the following: WORKING PRESSURE: 60 cm H₂O, PRESET INSP. MIN. VOL.: 7.5 l/min., BREATHS/min.: 10, PAUSE TIME: 30%, constant flow and INSP. TIME: 25%.
- Cover the Y-piece/Servo Humidifier and make sure that AIRWAY PRESSURE and the manometer WORKING PRESSURE show the same reading during inspiration and pause.
- Press and hold the INSP. PAUSE HOLD button and make sure that the AIRWAY PRESSURE reading does not drop more than 3 cm H₂O during 5 seconds.
- Release INSP. PAUSE HOLD and make sure that the AIRWAY PRESSURE reading falls to 0 during expiration.
- If AIRWAY PRESSURE drops more than allowed, block the outlet pipe on the insp. side and repeat as described. If the pressure drop is within the allowed limit, the leakage is to be found in the breathing system or the exp. channel.

4. Check of manual ventilation accessory

Applicable to manual ventilation accessory with motor.

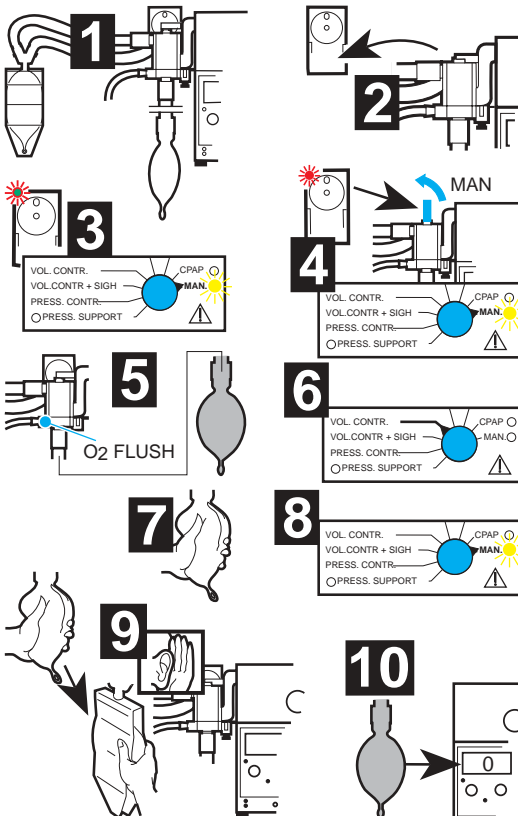

1. Attach a test lung.
2. Separate the valve and the motor units and make sure that alarm is activated.
3. Set mode selector to MAN and make sure that alarm is activated.
4. Set the valve arm to MAN and attach the valve unit to the motor unit.
5. Push O₂ FLUSH and make sure that the breathing bag fills.
6. Set VOL. CONTR.
7. Compress the breathing bag and make sure that there is no leakage (the gas remains in the breathing bag).
8. Set MAN.
9. Compress the breathing bag with one hand to fill the test lung. With the other hand, immediately compress the test lung and make sure that the expiration valve opens.
10. Let the breathing bag hang loose and be filled. Then make sure that the EXPIRED MINUTE VOLUME meter drops to 0.

Alarms

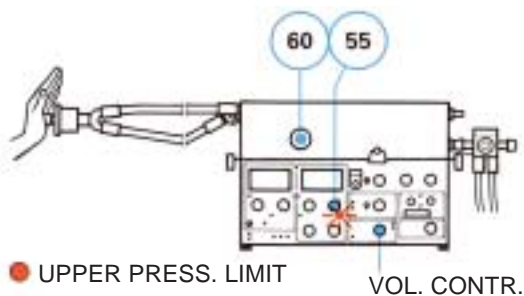

5. Upper pressure limit alarm

- Set the mode selector at VOL. CONTR.
- Block the Y-piece/Servo Humidifier.
- Turn the knob UPPER PRESS. LIMIT to 55 cm H₂O.
- Make sure that inspiration is terminated and the alarm is activated.
- Turn the knob back to 80 cm H₂O.

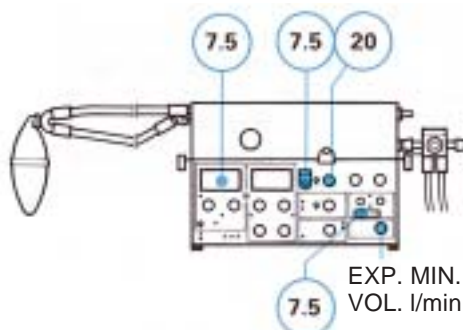

6. Minute volume

- Set the respiratory rate at 20 BREATHS/min.
- Connect a test lung.
- Set the parameter selector at EXP. MIN. VOL. l/min.
- Make sure that the digital display and the meter EXPIRED MINUTE VOLUME read 7.5 ± 0.5 l/min after a few minutes.

7. Minute volume alarm

Lower alarm limit

- Turn the knob LOWER ALARM LIMIT to 7.5 l/min and make sure that the alarm is activated at 7.5 ± 0.5 l/min.
- Turn the knob LOWER ALARM LIMIT to 0 l/min.

If gas evacuation should be used:

- Connect the gas evacuation accessory.
- Set the LOWER ALARM LIMIT to the value which is to be used during the treatment.
- Remove the test lung ("disconnect").
- Make sure that the LOWER ALARM LIMIT is activated.
- Make sure that the EXPIRED MINUTE VOLUME meter reading is at least 25% below the alarm limit setting.
- If the alarm is not activated:
 - Set PEEP to 1 cm H₂O
 - Check the alarm and meter reading as described above

or

—Decrease the evacuation flow until the alarm is activated. Also check the meter reading as described above.

Upper alarm limit

- Turn the knob UPPER ALARM LIMIT to 7.5 l/min and make sure that the alarm is activated at 7.5 ± 0.5 l/min.
- Turn the knob UPPER ALARM LIMIT to 40 l/min.

8. O₂ alarm

When checking the O₂ alarm, the working pressure must be 60 cm H₂O since the O₂ cell is calibrated at this pressure.

If there is no O₂ cell, no digital display is given when O₂ CONC. % is set on the parameter selector.

If the O₂ cell is expended but still mounted, it has to be disconnected. If not, the LOWER ALARM LIMIT will be activated.

A deterioration in the linearity and/or a rapid fall in the values of O₂ concentration, despite adequate O₂ supply, indicates that the O₂ cell is exhausted.

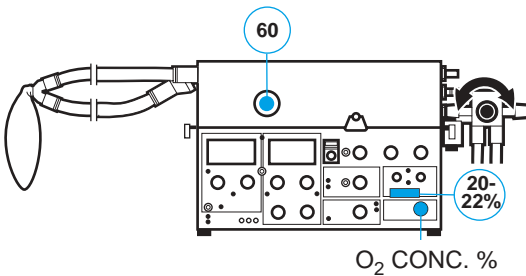

- Set the parameter selector at O₂ CONC. %.
- Set the gas mixer at the lowest O₂ concentration value (air) and make sure that the digital display shows 20-22%.
- Set the gas mixer so that 40% is read on the digital display.

Lower alarm limit

- Turn LOWER ALARM LIMIT clockwise and make sure that alarm is activated when the knob setting corresponds to the digital display (± 1 scale division).
- Turn LOWER ALARM LIMIT to 18%.

Upper alarm limit

- Turn UPPER ALARM LIMIT counter-clockwise and make sure that alarm is activated when the knob setting corresponds to the digital display (± 1 scale division).
- Turn UPPER ALARM LIMIT to 100%.

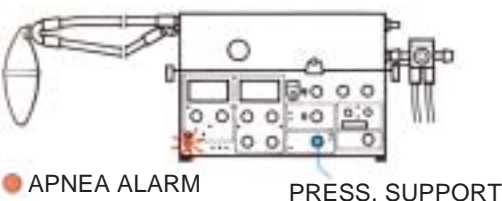
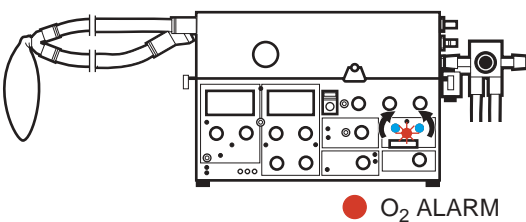

9. Apnea alarm

- Set TRIG. SENSITIVITY at -10.
- Set the mode selector at PRESS. SUPPORT.
- Make sure that the APNEA ALARM is activated approx. 15 s after the mode change.

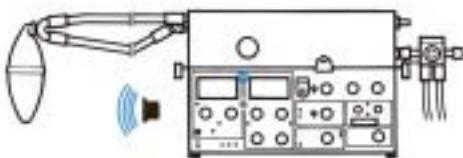
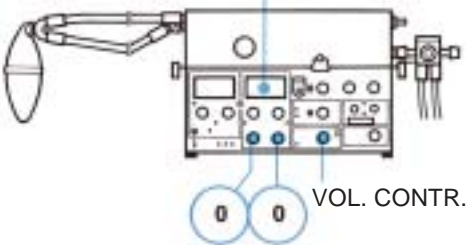
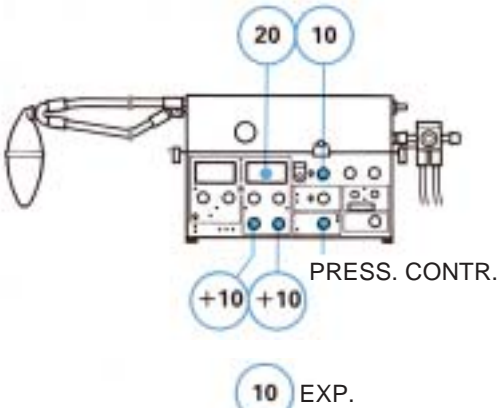
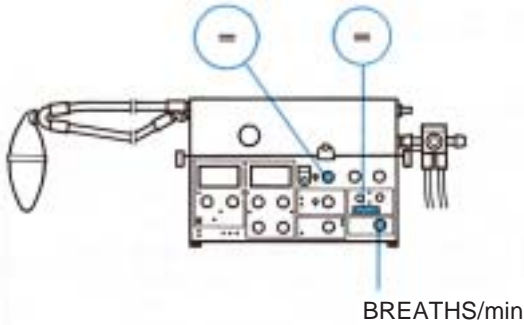

10. Digital display

- Set the parameter selector at BREATHS/min.
- Make sure that the value set with the BREATHS/min knob corresponds to the BREATHS/min value read on the digital display.

11. Check on pressure levels

- Set the mode selector at PRESS. CONTR.
- Set BREATHS/min. to lowest value.
- Set PEEP at +10 cm H₂O.
- Set INSP. PRESS. LEVEL at +10 cm H₂O.
- Make sure that the reading on the AIRWAY PRESSURE meter remains at +20 ± 2 cm H₂O during inspiration.
- Make sure that a PEEP level of 10 ± 2 cm H₂O is maintained on the AIRWAY PRESSURE meter at the end of expiration.
- Set PEEP and INSP. PRESS. LEVEL at 0 cm H₂O.
- Set the mode selector at VOL. CONTR.

12. Mains supply failure alarm

- Switch off the ventilator with the mains switch on the rear.
- Make sure that the green lamp POWER ON goes out and the audible alarm sounds.

13. Log sheet

- Note on the log sheet that a check on functions has been carried out.

If any malfunctions are detected during the check, see chapter 8, Troubleshooting, or chapter 13, Calibration.

Connection to patient

Be careful when moving the ventilator from the preparation room to the operating theatre. If you bump into something, it may be necessary to check the functions before connection to patient.

For detailed description of the functions, see chapter 2.

Always start with ventilator checked according to chapter 6.

In this chapter:

Compressible volume and dead space 7:2

Controlled ventilation

VOL. CONTR. or

VOL. CONTR. + SIGH 7:4

PRESS. CONTR. 7:5

Supported ventilation

PRESS. SUPPORT 7:6

SIMV 7:7

SIMV + PRESS. SUPPORT 7:8

Spontaneous ventilation

CPAP 7:9

Manual ventilation

MAN 7:10

Compressible volume and dead space

Compensation for compressible volume

Some of the preset minute volume does not reach the patient because it is needed for compression of gas in tubes and humidifier. The compressible volume of the Servo Ventilator itself is negligible.

When setting the preset insp. minute volume, the compressible volume must be compensated for by adding a corresponding minute volume to the minute volume for the patient.

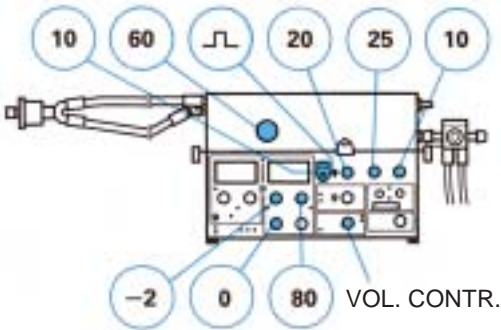

Compensation procedure

- 1 Connect the complete breathing system with patient tubes and Servo Humidifier or heater humidifier to the Servo Ventilator.
- 2 Set WORKING PRESSURE at 60 cm H₂O.
- 3 Set the front panel values as shown. (Values marked in green).
- 4 Set PRESET INSP. MIN. VOL. at 10 l/min.
- 5 Set UPPER PRESS. LIMIT for AIRWAY PRESSURE at 80 cm H₂O.
- 6 Set the parameter selector at INSP. TIDAL VOLUME.
- 7 Block the opening of the Y-piece/Servo Humidifier.
- 8 Note the reading on the INSP. TIDAL VOLUME (ml) display.

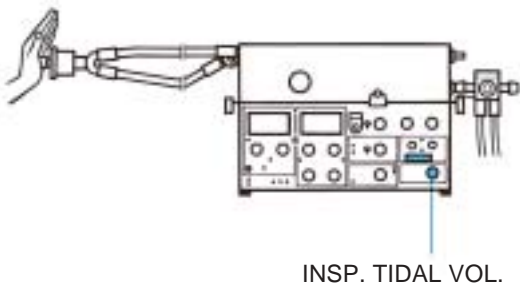

Compressible volume and dead space

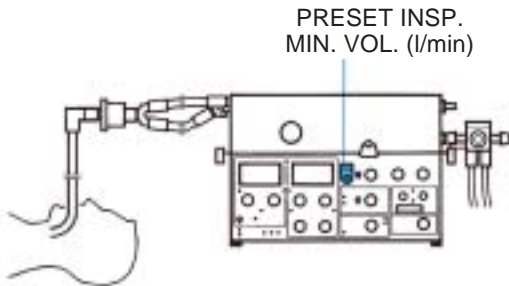
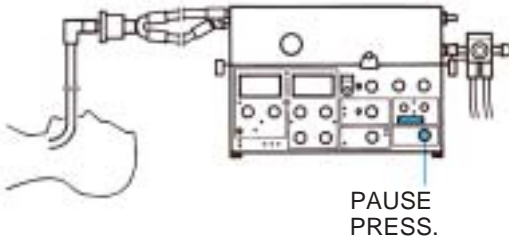

9 Set the Servo Ventilator as desired for the patient (including the desired minute volume for the patient) and connect the patient. See pages 7:4 to 7:10.

10 Set the parameter selector at PAUSE PRESSURE and read actual pause pressure when the patient is connected.

11 Calculate compensation (l/min) for compressible volume =

$$= \frac{\text{read INSP. TIDAL. VOLUME (ml) according to item 8 above}}{1000 \text{ (ml/l)}} \times \frac{\text{read PAUSE PRESSURE (cm H}_2\text{O) according to item 10 above}}{60 \text{ (cm H}_2\text{O)}} \times \text{set BREATHS/min according to item 9 above}$$

12 Set PRESET INSP. MIN. VOL. = desired minute volume for the patient + compensation (l/min) for compressible volume (calculated in item 11 above).

$$= 54 \text{ ml (at pause pressure 60 cm H}_2\text{O).}$$

$$= 7.5 \text{ l/min.}$$

$$= 15.$$

$$= 22 \text{ cm H}_2\text{O.}$$

$$= \frac{54}{1000} \times \frac{22}{60} \times 15 = 0.3 \text{ l/min.}$$

$$7.5 + 0.3 = 7.8 \text{ l/min.}$$

$$= 88 \text{ ml (at pause pressure 60 cm H}_2\text{O).}$$

$$= 9.0 \text{ l/min.}$$

$$= 17.$$

$$= 24 \text{ cm H}_2\text{O.}$$

$$= \frac{88}{1000} \times \frac{24}{60} \times 17 = 0.6 \text{ l/min.}$$

$$9.0 + 0.6 = 9.6 \text{ l/min.}$$

Example 1 (Servo Humidifer):

Read INSP. TIDAL VOLUME (item 8)

Desired minute volume for the patient

Set BREATHS/min (item 9)

Read PAUSE PRESSURE (item 10)

Compensation for compressible volume (item 11)

PRESET INSP. MIN. VOL. (item 12)

Example 2 (Heater humidifier):

Read INSP. TIDAL VOLUME (item 8)

Desired minute volume for the patient

Set BREATHS/min (item 9)

Read PAUSE PRESSURE (item 10)

Compensation for compressible volume (item 11)

PRESET INSP. MIN. VOL. (item 12)

- Servo Humidifier 151:	35 ml
- Servo Humidifier 152:	55 ml
- Servo Humidifier 153 (incl. flex tube):	70 ml
- CO ₂ cuvette adult (for CA 930/CM 130):	5 ml
- CO ₂ cuvette infant (for CA 930/CM 130):	2.5 ml

Compensation for dead space

When setting PRESET INSP. MINUTE VOLUME, dead space in the breathing system between the Y-piece and the patient should also be compensated for.

Dead space for some accessories is shown in the table to the left.

Controlled ventilation

VOL. CONTR. or VOL. CONTR. + SIGH

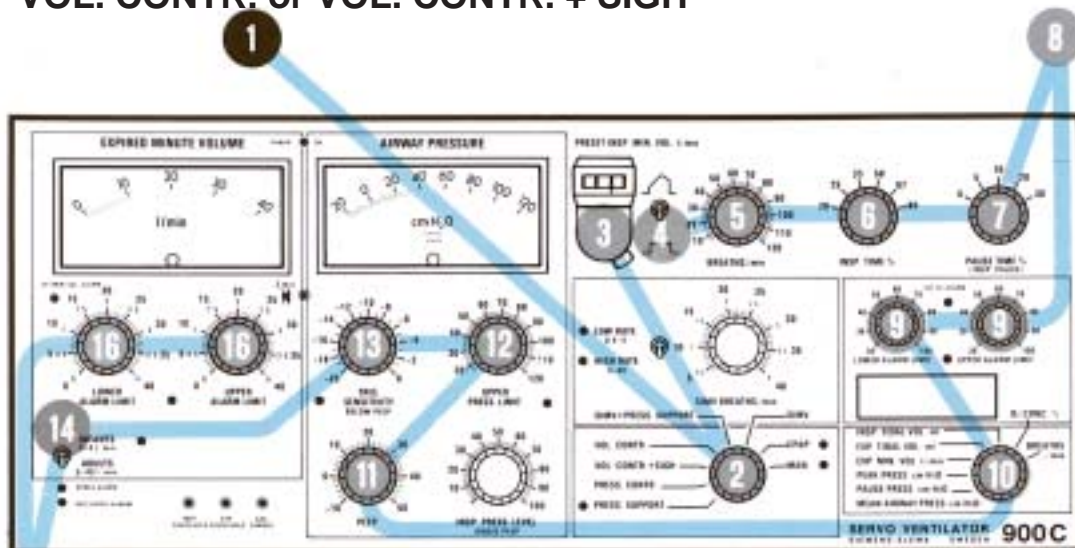

15 Connect the patient

- 1 Set the WORKING PRESSURE.
- 2 Set the mode selector at VOL. CONTR. or VOL. CONTR. + SIGH.
- 3 Set the desired minute volume (e.g. by means of a Radford nomogram).
- 4 Select the curve shape for the inspiration flow.
- 5 Set the respiratory rate, BREATHS/min.
- 6 Set the INSP. TIME %.
- 7 Set the PAUSE TIME %.
- 8 Set the mixer.
- 9 Set the LOWER ALARM LIMIT and UPPER ALARM LIMIT for O₂ CONC. %.
- 10 Set the parameter selector.
- 11 Set the PEEP-level.

12 To protect the patient against high pressures, always start from a low value.

- 12 Set the UPPER PRESS. LIMIT for AIRWAY PRESSURE to approximately 10 cm H₂O above the patient's airway pressure.
- 13 Set the TRIG. SENSITIVITY.
- 14 Set the scale INFANTS/ADULTS.
- 15 Connect the ventilator to the patient and check:
 - that the patient's chest rises and falls in time with the preset respiratory rate.
 - the tidal volumes on the digital display and the reading on the EXPIRED MINUTE VOLUME meter.
 - that the AIRWAY PRESSURE meter gives a reading during inspiration, and that the reading falls to 0 cm H₂O or, alternatively, to PEEP-level during expiration.
- 16 Set the LOWER ALARM LIMIT and UPPER ALARM LIMIT for EXPIRED MINUTE VOLUME. If the VOL. CONTR. + SIGH mode is selected, it may be necessary to increase the UPPER ALARM LIMIT for EXPIRED MINUTE VOLUME as well as the UPPER PRESS. LIMIT for AIRWAY PRESSURE. This is done in order to avoid activating the alarms when the sigh occurs.

In VOL. CONTR. or VOL. CONTR. + SIGH mode with respiratory rate above 80 BREATHS/min, INSP. TIME % should be set at 33 or 50%. Otherwise the ventilator may give incorrect minute volumes and incorrect EXPIRED MINUTE VOLUME meter readings.

Controlled ventilation

PRESS. CONTR.

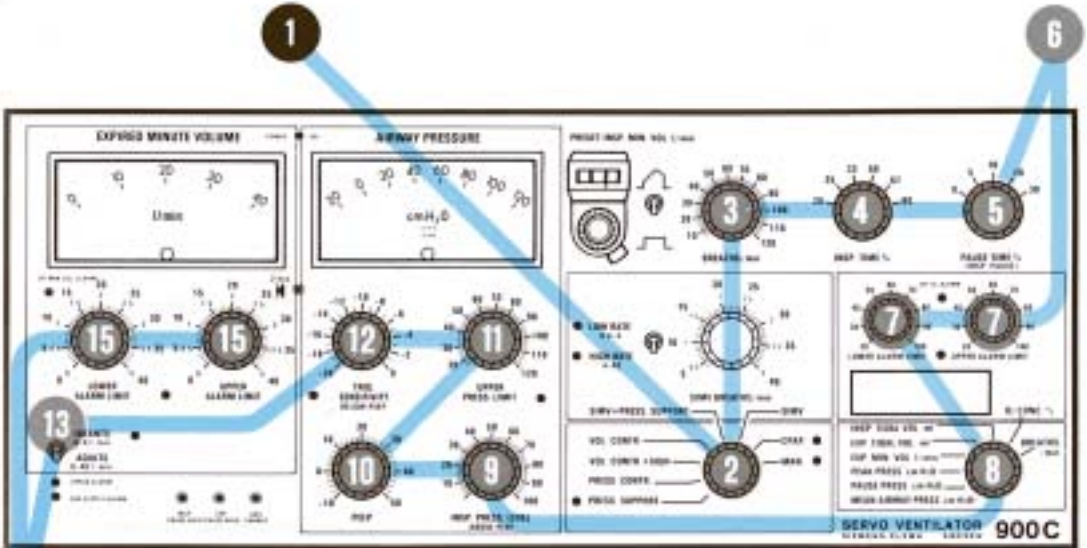

14 Connect the patient.

1 Set the WORKING PRESSURE.

2 Set the mode selector at PRESS. CONTR.

3 Set the respiratory rate, BREATHS/min.

4 Set the INSP. TIME %.

5 Set the PAUSE TIME %.

6 Set the mixer.

7 Set the LOWER ALARM LIMIT and UPPER ALARM LIMIT for O₂ CONC. %.

8 Set the parameter selector.

9 Set the INSP. PRESS. LEVEL.

10 Set the PEEP-level.

11 To protect the patient against high pressures, always start from a low value.

11 Set the UPPER PRESS. LIMIT for AIRWAY PRESSURE.

12 Set the TRIG. SENSITIVITY.

13 Set the scale INFANTS/ADULTS.

14 Connect the patient and adjust the INSP. PRESS. LEVEL so that the patient receives decided tidal volumes and check:
– the reading on the EXPIRED MINUTE VOLUME meter.
– that the AIRWAY PRESSURE meter gives a reading during inspiration, and that the reading falls to 0 cm H₂O, or alternatively, to PEEP-level, during expiration.

15 Set the LOWER ALARM LIMIT and UPPER ALARM LIMIT for EXPIRED MINUTE VOLUME.

Supported ventilation

PRESS. SUPPORT

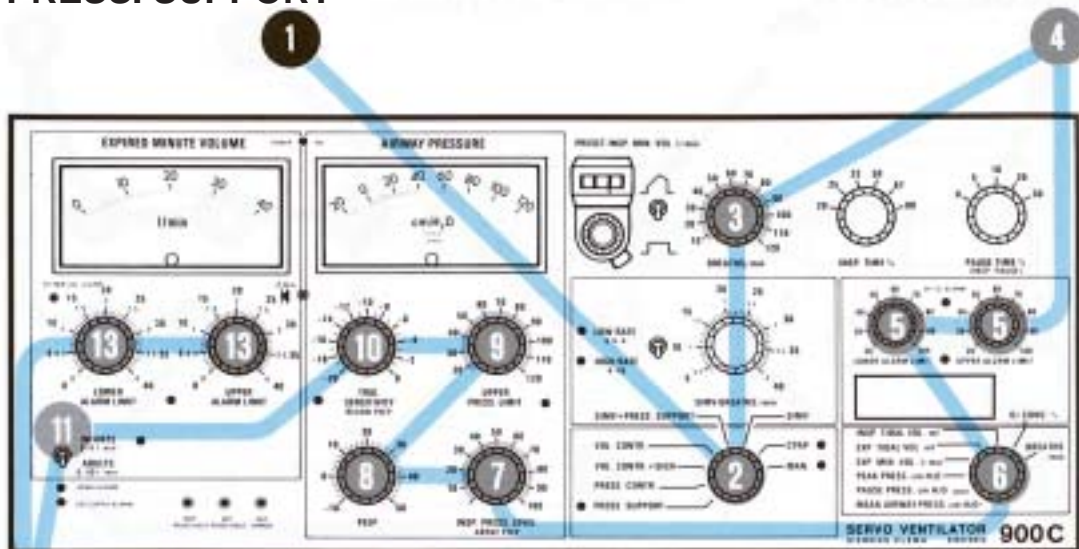

12 Connect the patient

1 Set the WORKING PRESSURE.

2 Set the mode selector at PRESS. SUPPORT.

3 Set the respiratory rate, BREATHS/min.
(determines the length of inspiration time).

4 Set the mixer.

5 Set the LOWER ALARM LIMIT and UPPER ALARM LIMIT for O₂ CONC. %.

6 Set the parameter selector.

7 Set the INSP. PRESS. LEVEL.

8 Set the PEEP-level.

9 To protect the patient against high pressures, always start from a low value.

9 Set the UPPER PRESS. LIMIT for AIRWAY PRESSURE.

10 Set the TRIG. SENSITIVITY.

11 Set the scale INFANTS/ADULTS.

12 Connect the patient and check that he can trigger the ventilator. Adjust the INSP. PRESS. LEVEL so that the patient receives decided tidal volumes and check:
– the reading on the EXPIRED MINUTE VOLUME meter.
– that the AIRWAY PRESSURE meter gives a reading during inspiration, and that the reading falls to 0 cm H₂O or, alternatively, to PEEP-level during expiration.

13 Set the LOWER ALARM LIMIT and UPPER ALARM LIMIT for EXPIRED MINUTE VOLUME.

Supported ventilation

SIMV

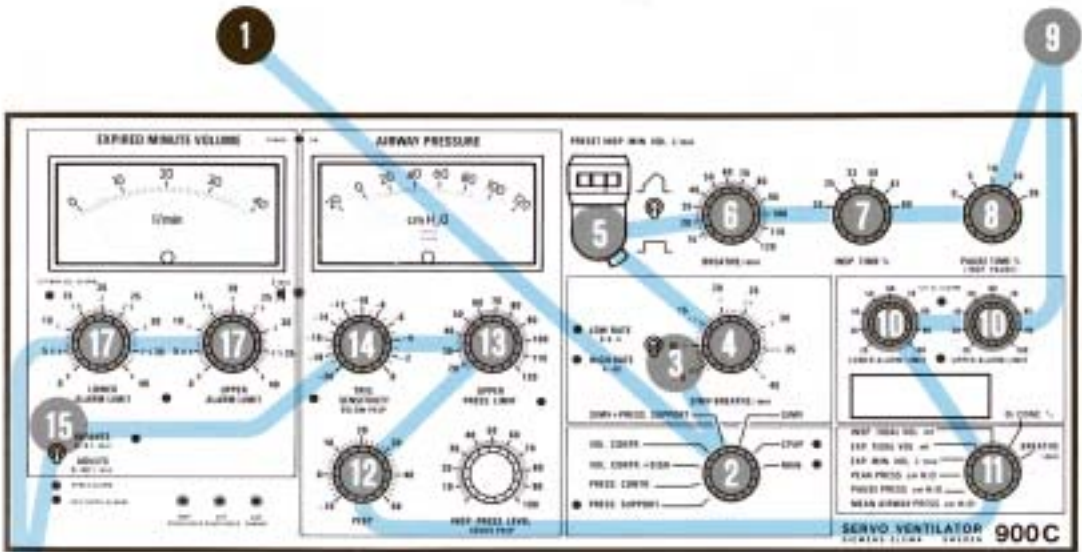

16 Connect the patient.

- 1 Set the WORKING PRESSURE.
- 2 Set the mode selector at SIMV.
- 3 Set the rate, LOW RATE/HIGH RATE.
- 4 Set the SIMV BREATHS/min.
- 5 Set the PRESET INSP. MIN. VOL. l/min.
- 6 Set the respiratory rate, BREATHS/min.
- 7 Set the INSP. TIME %.
- 8 Set the PAUSE TIME %.
- 9 Set the mixer.
- 10 Set the LOWER ALARM LIMIT and UPPER ALARM LIMIT for O₂ CONC. %.

13 To protect the patient against high pressures, always start from a low value.

- 11 Set the parameter selector.
- 12 Set the PEEP-level.
- 13 Set the UPPER PRESS. LIMIT for AIRWAY PRESSURE.
- 14 Set the TRIG. SENSITIVITY.
- 15 Set the scale INFANTS/ADULTS.
- 16 Connect the patient and check:
 - that the patient can trigger the ventilator.
 - the tidal volumes on the digital display and the reading on the EXPIRED MINUTE VOLUME meter.
 - that the AIRWAY PRESSURE meter gives a reading during inspiration, and that the reading falls to 0 cm H₂O or, alternatively, to PEEP-level, during expiration.
- 17 Set the LOWER ALARM LIMIT and UPPER ALARM LIMIT for EXPIRED MINUTE VOLUME.

Supported ventilation

SIMV + PRESS. SUPPORT

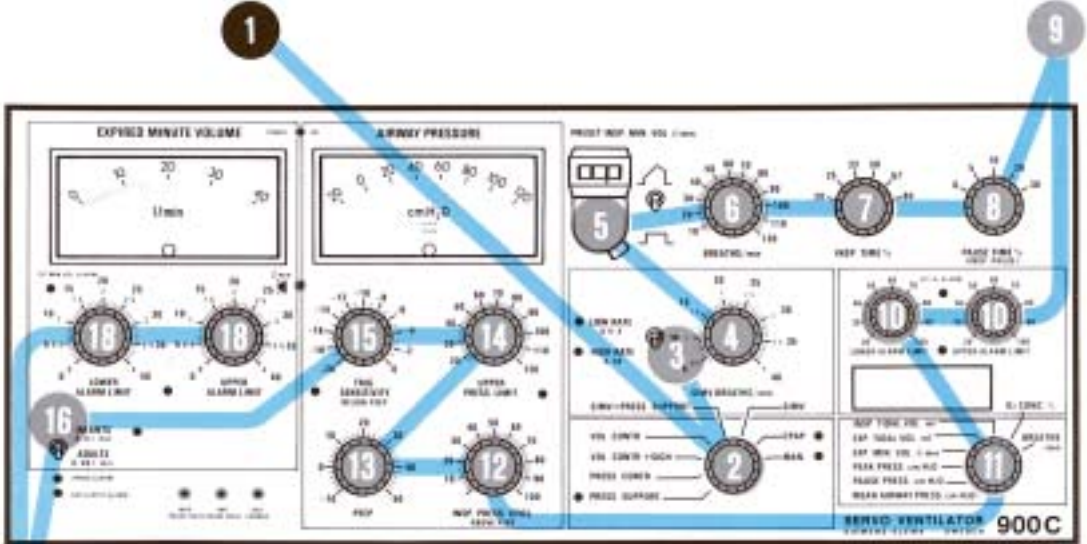

7
8

17 Connect the patient.

1 Set the WORKING PRESSURE.

2 Set the mode selector at SIMV + PRESS. SUPPORT.

3 Set the rate, LOW RATE/HIGH RATE.

4 Set the SIMV BREATHS/min.

5 Set the PRESET INSP. MIN. VOL. l/min.

6 Set the respiratory rate, BREATHS/min.

7 Set the INSP. TIME %.

8 Set the PAUSE TIME %.

9 Set the mixer.

10 Set the LOWER ALARM LIMIT and UPPER ALARM LIMIT for O₂ CONC. %.

11 Set the parameter selector.

14

To protect the patient against high pressures, always start from a low value.

12 Set the INSP. PRESS. LEVEL.

13 Set the PEEP-level.

14 Set the UPPER PRESS. LIMIT for AIRWAY PRESSURE.

15 Set the TRIG. SENSITIVITY.

16 Set the scale INFANTS/ADULTS.

17 Connect the patient and check that he can trigger the ventilator. Adjust the INSP. PRESS. LEVEL so that the patient receives the decided tidal volumes and check:
– the reading on the EXPIRED MINUTE VOLUME meter.
– that the AIRWAY PRESSURE meter gives a reading during inspiration, and that the reading falls to 0 cm H₂O or, alternatively, to PEEP-level during expiration.

18 Set the LOWER ALARM LIMIT and UPPER ALARM LIMIT for EXPIRED MINUTE VOLUME.

Spontaneous ventilation

CPAP

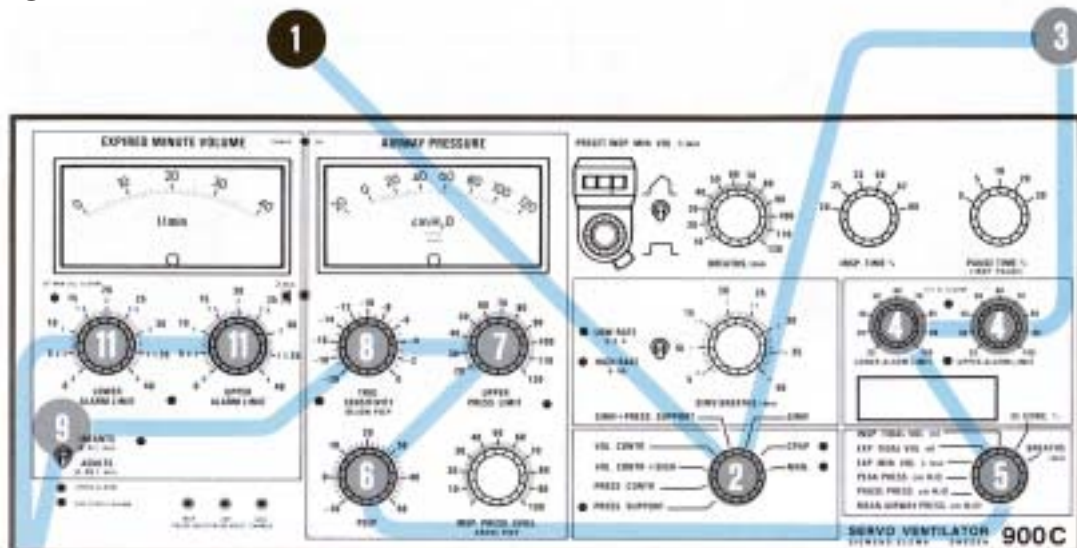

10 Connect the patient.

1 Set the WORKING PRESSURE.

2 Set the mode selector at CPAP.

3 Set the mixer.

4 Set the LOWER ALARM LIMIT and UPPER ALARM LIMIT for O₂ CONC. %.

5 Set the parameter selector.

6 Set the PEEP-level.

7 Set the UPPER PRESS. LIMIT for AIRWAY PRESSURE.

7 To protect the patient against high pressures, always start from a low value.

8 Set the TRIG. SENSITIVITY.

9 Set the scale INFANTS/ADULTS.

10 Connect the patient and check:
 – that he can trigger the ventilator.
 – the tidal volumes on the digital display and the reading on the EXPIRED MINUTE VOLUME meter.
 – that the AIRWAY PRESSURE meter gives a reading during inspiration, and that the reading falls to 0 cm H₂O or, alternatively, to PEEP-level during expiration.

11 Set the LOWER ALARM LIMIT and UPPER ALARM LIMIT for EXPIRED MINUTE VOLUME.

Manual ventilation

MAN

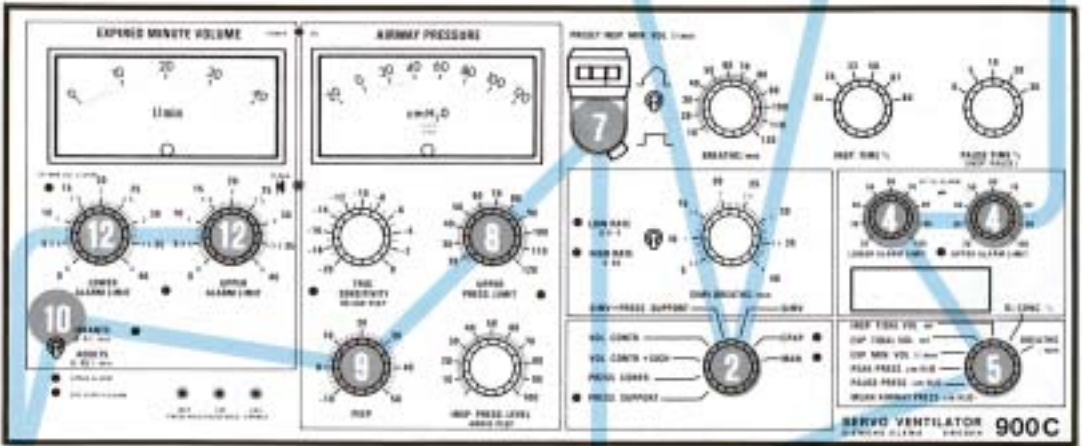

11 Connect the patient.

6 Manual ventilation valve in position MAN.

7
10

Set the values to be used after completed manual ventilation.

- 1 Set the WORKING PRESSURE.
- 2 Set the mode selector at MAN.
- 3 Set the mixer.
- 4 Set the LOWER ALARM LIMIT and UPPER ALARM LIMIT for O₂ CONC. %.
- 5 Set the parameter selector.
- 6 Make sure that the manual ventilation valve is in position MAN.
- 7 Set the PRESET INSP. MIN. VOL. /min. (Set the value so that the breathing bag becomes satisfactorily filled).
- 8 Set the UPPER PRESS. LIMIT for AIRWAY PRESSURE.
- 9 Set the PEEP-level.

8

To protect the patient against high pressures, always start from a low value.

- 10 Set the scale INFANTS/ADULTS.
- 11 Connect the patient and check:
 - that the patient's chest rises and falls when manual ventilation is performed.
 - the tidal volumes on the digital display and the reading on the EXPIRED MINUTE VOLUME meter.
 - that the AIRWAY PRESSURE meter gives a reading during inspiration, and that the reading falls to 0 cm H₂O or, alternatively, to PEEP-level during expiration.
- 12 Set the LOWER ALARM LIMIT and UPPER ALARM LIMIT for EXPIRED MINUTE VOLUME.

Always set UPPER PRESS. LIMIT during manual ventilation.

In the case of a power failure, manual ventilation is not possible with Servo Ventilator 900 C.

The Manual Ventilation Accessory 963 must not be connected to Servo Ventilator 900 C.

Chapter 8

Clinical judgement and Troubleshooting

Clinical judgement when an alarm indicates that preset ventilation can no longer be maintained. If possible, try to first eliminate technical faults by carrying out a check on functions.

In this chapter:

Clinical judgement 8:2

Technical troubleshooting 8:6

Clinical judgement — Minute volume

LOWER ALARM LIMIT for EXPIRED MINUTE VOLUME has activated an alarm

Cause	Symptoms and diagnostic aids	Suggested treatment
Leakage between the tracheal wall and tracheostomy tube or cannula.	An air leakage may be detected by palpation or auscultation over the trachea.	Correct cuff pressure. If the leakage cannot be sealed, increase the PRESET INSP. MIN. VOL. so that expired minute volume settles at a suitable level. Leakages mainly occur during the inspiration phase and the pause at the end of inspiration when the pressure in the trachea is high. Prolonged inspiration time.
Temporary increase of lung volume.	Variations in measured expired minute volume (spontaneous breaths or sigh).	
Ventilation obstruction, resulting in a pressure activated interruption of inspiration.	UPPER PRESS. LIMIT for AIRWAY PRESSURE has also activated an alarm.	See UPPER PRESS. LIMIT for AIRWAY PRESSURE.
Insufficient patient respiration during SIMV, CPAP, PRESS. SUPPORT.	Variations in the measured expired minute volume.	Revert to normal ventilation, or SIMV-position which gives an increased, controlled ventilation. In SIMV, increase the SIMV BREATHS/min. or the preset tidal volume. In PRESS. SUPPORT, increase the INSP. PRESS.LEVEL if the tidal volume is too small but the patient has adequate respiratory rate.

UPPER ALARM LIMIT for EXPIRED MINUTE VOLUME has activated an alarm

Cause	Symptoms and diagnostic aids	Suggested treatment
Temporary decrease in lung volume.	Variations in measured expired minute volume (spontaneous breaths, compression of the lungs during thoracic surgery).	
Increase in respiration rate.	<p>A signal is also given by the yellow lamp below TRIG. SENSITIVITY, indicating that the patient triggers breaths at a faster rate than the preset basic rate of the ventilator. However, in volume controlled ventilation the patient can also be breathing at the same rate as the preset rate on the ventilator. In assisted ventilation, check the BREATHS/min. on the digital display.</p>	<p>In conjunction with suction of the trachea and other measures, and also due to a number of other factors (hypoxia, rise in temperature, pain, restlessness, physical activity, physiotherapy, etc.) increased ventilation may be necessary. The patient can compensate for an increased demand on ventilation by using the patient-triggering system, if it is set at a suitable level.</p> <p>If the necessity of increased ventilation is long-term, this indicates some action (like increasing the ventilation volume, but with increased oxygen supply, reduction of oxygen consumption by sedatives, analgesics and antipyretics).</p>

Clinical judgement — Pressures

UPPER PRESSURE LIMIT for AIRWAY PRESSURE has activated an alarm

(Combined with an interruption of inspiration, in which case LOWER ALARM for EXPIRED MINUTE VOLUME may also have been activated.)

Cause	Symptoms and diagnostic aids	Suggested treatment aids
Airways obstructions	In cases of substantial obstructions, recordings of flow and airway pressure indicate increased airway resistance. Increased elastic resistance (low compliance) may also occur at the same time. When the UPPER PRESS. LIMIT for AIRWAY PRESSURE is repeatedly exceeded and, at the same time, accompanied by interruptions of inspiration, the expired minute volume falls, and an alarm is activated.	
a) Accumulation of mucus in airways.	Auscultatory rales, Rhoncal fremitus on parts of the chest.	Suction, Expectorants, Physiotherapy.
b) Bronchospasm. Bronchit.	Whistling or wheezing respiratory sounds during auscultation.	Bronchodilator drugs, etc.
c) Tracheostomy tube or cannula has slipped out of the trachea, or has been kinked or twisted, so that the opening is blocked. The cuff protrudes over the opening of the tube or cannula. Coagulate or dried mucus block the airway.	Often occurs suddenly and with variations. Difficult to insert a suction catheter. Resistance is felt when ventilating manually with a breathing bag.	Removal of kinks or correction of position. Possibly a reduction of pressure in the cuff, and possibly a replacement of tracheostomy tube or cannula. In case of an absolute blockage, it may be necessary to withdraw the cannula or tube. The blockage can often be located in the orifice of the tube.

Clinical judgement — Pressures

Cause	Symptoms and diagnostic aids	Suggested treatment
Reduced elasticity of the respiratory organs.	Recordings of flow and pressure indicate a high elastic resistance (low compliance).	
a) Increased muscular tonus in the patient. Coughing.	Sometimes caused by mucus, often after suction. The patient works against the ventilator.	Temporary increase of minute volume and BREATHS/min. Often more convenient for the patient if the inspiratory flow is increased by reducing INSP. TIME %, until negative airway pressure caused by spontaneous breathing ceases. Consider administering analgesics and sedatives. Blood gas tests. Adjustment of ventilator settings and alarm limits.
b) Atelectasis, pneumonia, pulmonary edema.	Reduced respiratory sounds over affected sections of the lungs. Possible rales during auscultation. Roentgenologic changes. Often accompanied by hypoxia.	Check of blood gases. PEEP, physiotherapeutic treatment, change of patient's position, postural drainage, sigh function.
c) Blockage of main bronchus.	The cause is often that the tracheal or the tracheostomy tube has slipped too far down. Reduced respiratory sounds. Roentgenologic changes. Irregular movements of the thorax. Hypoxia, increased resistance and reduced compliance.	Adjustment of tube position.
d) Pneumothorax.	Often occurs suddenly. Reduced respiratory sounds, and increased percussive tone over the affected side. Sometimes followed by subcutaneous emphysema. Roentgenologic changes.	Out-suction of air in pleura.

TRIG. SENSITIVITY lamp flashes

Cause	Symptoms and diagnostic aids	Suggested treatment
Patient triggers spontaneous breaths.	The airway pressure (SIMV not used) is usually negative (or under preset PEEP-level) only at the start of inspiration. Negative pressure (or pressure under preset PEEP-level) during the whole inspiration indicates a considerable deviation between preset minute volume and the minute volume the patient needs.	SIMV treatment normally. Patient triggering is more often acceptable and suitable. Usually the patient requires a larger gas volume than that supplied by the controlled breaths. In cases of unexpected patient triggering, an increase of preset minute volume should be considered.

Technical trouble — Power

Ventilator does not start

Malfunction	Possible cause	Action
	Power cable not connected.	Connect power cable.
	Blown fuse in ventilator.	Replace fuse.
	On-Off switch in the Off-position.	Switch to On.

Ventilator stops during operation

Malfunction	Possible cause	Action
Green lamp goes out, ventilator stops, audible alarm.	No mains supply.	Ventilate patient manually. <div style="border: 1px solid black; background-color: yellow; padding: 5px; margin-top: 10px;">Manual ventilation accessory on Servo Ventilator 900 C cannot be used during a power failure.</div>
Green lamp goes out at intervals + simultaneous stop of ventilator.	Loose connection.	Insert the power cable in wall socket or ventilator socket properly.

Technical trouble — Pressures

Fault in working pressure

Malfunction	Possible cause	Action
Working pressure varies.	Pressure/flow from gas source not enough. Fault in gas supply.	Low-pressure connection: increase gas volume/pressure. High-pressure connection: check gas source/mixer.
	Large tidal volumes and short inspiration times set on ventilator. Incorrectly adjusted inlet valve in gas supply unit.	Change respiratory pattern or gas volume. To be dealt with by service technician.
WORKING PRESSURE reading is 0, but GAS SUPPLY ALARM not activated.	Tube connection is loose between the safety valve and the manometer for WORKING PRESSURE.	Connect tube connections.
WORKING PRESSURE reading is 0. GAS SUPPLY ALARM is activated. (Alarm is also activated for the LOWER ALARM LIMIT for EXPIRED MINUTE VOLUME).	Working pressure not set. Insufficient gas supply. Deformed valve arm on gas supply unit.	Set working pressure. Check gas connections/gas mixers/flowmeters. To be dealt with by service technician.

No airway pressure

Malfunction	Possible cause	Action
AIRWAY PRESSURE reading is 0.	Loose tube between inspiration channel and pressure transducer.	Attach the tube.

UPPER PRESS. LIMIT ALARM for AIRWAY PRESSURE has been activated

Malfunction	Possible cause	Action
	Accumulation of secretion.	Suction of trachea
	Kink in tracheal tube.	Remove the kink or replace the tube.
	Patient tries to breathe, increased muscle-tonus.	Clinical judgement.
	The tracheal tube has slipped down into a bronchus.	Correct the tube position.
	Spasms in respiratory airways.	Medicaments.
	Change in patient's positioning e.g. on operation table.	Possible change of respiratory pattern.
	Pneumothorax.	Suction drainage.
	Sigh.	Set the UPPER PRESS. LIMIT alarm somewhat higher.

Technical trouble — Minute volume

LOWER ALARM LIMIT for EXPIRED MINUTE VOLUME has been activated

Malfunction	Possible cause	Action
	Connection between patient and ventilator has loosened.	Reconnect the connections, e.g. Y-piece, trach. tube, patient tube, water trap.
	Leakage in trach. tube/cannula cuff.	Adjust the cuff, or change trach tube/cannula cuff.
	Changes in upper airway pressure so that the expiration valve opens at attained upper pressure limit.	Same action as for UPPER PRESS. LIMIT alarm for airway pressure.
	Insufficient patient respiration, during SIMV, SIMV + PRESS. SUPPORT, PRESS. SUPPORT or CPAP.	Change SIMV-rate, INSP. PRESS. LEVEL, or change to controlled ventilation.
	Working pressure too low (lower than the airway pressure needed to provide preset ventilation).	Increase working pressure, or change respiratory pattern.
	Insufficient gas supply, e.g. from flowmeters.	At low pressure: increase gas flow. At high pressure: check gas source/mixer.
	Leakage due to poor assembling of parts of inspiration channel or expiration channel.	Assemble correctly.
Leakage in ventilator	Safety valve out of position.	Put the valve in position.
	Connection to one of the pressure transducers has loosened.	Reconnect.
	Rubber valve defect on insp./exp. side.	Replace rubber valve.

Technical trouble — Minute volume

UPPER ALARM LIMIT for EXPIRED MINUTE VOLUME has been activated

Malfunction	Possible cause	Action
	Deeper breaths in VOL. CONTR. + SIGH, increase in expired minute volume (every hundredth breath).	Set the UPPER ALARM LIMIT somewhat higher.
	Patient breathes more than expected during SIMV, SIMV + PRESS. SUPPORT, CPAP, PRESS. SUPPORT.	Clinical judgement.
	Condensation in exp. flow transducer.	Empty water trap if necessary. Protect exp. inlet by an angled humidity trap or a bacteria filter. Dry run the ventilator with a test lung if these actions are not enough.
	Particles of medicines in exp. flow transducer.	Replace exp. flow transducer (or try to clean the transducer according to chapter 10).
	Flow transducer is defective.	Replace exp. flow transducer.

Technical trouble—Others

O₂ cell

Malfunction	Possible cause	Action
No digital display when O ₂	O ₂ cell not inserted. CONC. % is selected.	Insert an O ₂ cell (see chapter 12).
Rapidly falling O ₂ CONC. % values. LOWER ALARM LIMIT activates an alarm.	a) Insufficient O ₂ supply. b) O ₂ cell exhausted. c) O ₂ cell not properly inserted.	a) Regulate O ₂ supply. b) Replace O ₂ cell (see chapter 12) c) Insert properly.
UPPER ALARM LIMIT activates an alarm.	Insufficient air/N ₂ O supply.	Regulate gas supply.

Leakage detected in ventilator during check on functions

Malfunction	Possible cause	Action
	Connection between safety valve and manometer has loosened.	Reconnect.
	Leakage at inlet valve of gas supply unit.	Replace gas supply unit.
	Leakage in non-return valve of gas supply unit.	Replace gas supply unit.
	Leakage in bellows.	Replace bellows (see chapter 11).
	Overfilling of bellows, safety valve opens (caused by deformed valve arm on gas supply unit).	Valve arm to be adjusted by service technician.
	Leakage in bacteria filter.	Replace gas supply unit.
	Bad connections in the inspiratory or expiratory channel.	Connect properly.

Incorrect values/readings during check on functions

Malfunction	Possible cause	Action
	Ventilator not calibrated.	Calibrate ventilator (see chapter 13).

Noises

Malfunction	Possible cause	Action
Rattle from step motor.		Must be dealt with by service technician as soon as possible.
“Singing” noise from springs under the bellows.	Springs hook into one another. Not dangerous and does not interfere with function of ventilator.	Dealt with by service technician, when convenient.

Trig sensitivity flashes without activity from the patient

Malfunction	Possible cause	Action
	Leakage in the expiratory channel which causes spontaneous triggering (when PEEP is used in the presence of leakages).	

Recording

The ventilator can be connected to a recorder, e.g. a Siemens-Elema Mingograf.

In this chapter:

Connection.....	9:2
Calibration.....	9:3
Curves	9:4

Connection

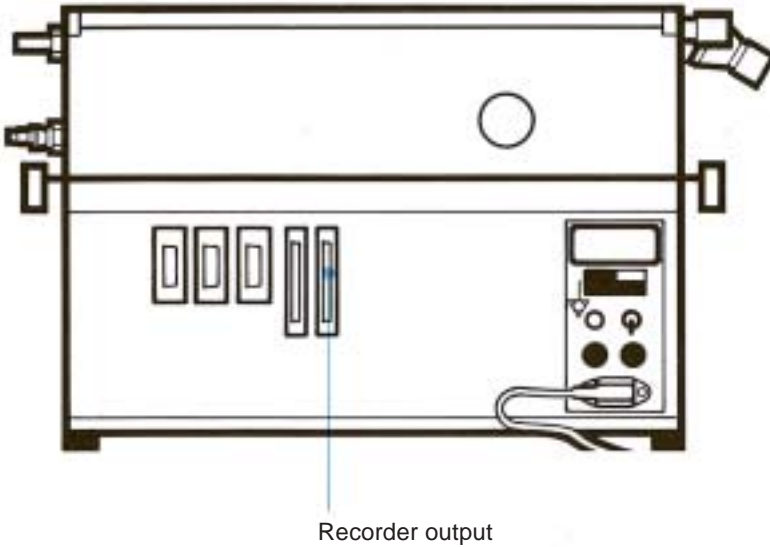

Recorder output

- Connect the recorder cable to the 37-pin socket at the rear of the ventilator. The cable has two connections to the Mingograf Recorder, i.e. one for recording of pressure curves and one for recording of flow curves.
- The output signals from the recorder cable are adapted to the inputs of Siemens-Elema's Mingograf Recorders.

Use only the recorder cable intended for Servo Ventilator 900 C.

Never connect or disconnect auxiliary equipment while the ventilator is connected to a patient.

Calibration

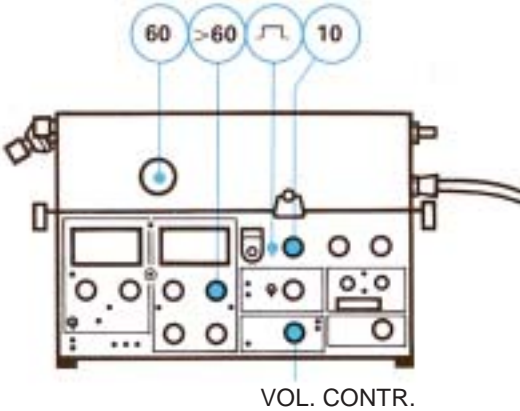

a) Flow

- ① Adjust the 0-line on the recorder.
- ② Set WORKING PRESSURE to 60 cm H₂O.
- ③ Set the UPPER PRESS. LIMIT higher than the WORKING PRESSURE.
- ④ Select constant flow.
- ⑤ Set the respiratory rate to 10 BREATHS/min.
- ⑥ Set the mode selector at VOL. CONTR.
- ⑦ Calculate inspiratory flow as follows:
Insp. flow (l/s) =

$$\frac{\text{PRESET INSP. MIN. VOL. (l/min)}}{60} \times \frac{100}{\text{INSP. TIME (\%)}}$$

- ⑧ A suitable calibration level for normal conditions is to allow 0.5 l/s correspond to 1 cm deflection on the recorder paper. 0.5 l/s corresponds to a setting of 7.5 l/min for PRESET INSP. MIN. VOL. and 25% INSP. TIME.
- ⑨ After this, adjust the recorder to desired reading.

b) Pressure

- ① Adjust the 0-line on the recorder.
- ② Block the inspiration outlet during the inspiration phase, or connect the inspiration outlet to the expiration inlet with a patient tube.
- ③ A suitable calibration level for normal conditions is to allow 20 cm H₂O correspond to 1 cm deflection on the recorder paper. The preset WORKING PRESSURE should then, temporarily, be set to 20 cm H₂O.
- ④ Adjust the recorder to desired reading.

Pressure and flow curves

If the flow curve is square-shaped and an inspiratory pause is used, it will be possible to calculate, from the pressure curve, airway resistance and the elasticity of the lungs and rib cage, i.e. compliance. It is possible to continuously follow changes in these values in patients with obstructive lung diseases and also when ventilating patients for prolonged periods.

For all measurements, it is assumed that the patient makes no breathing attempts.

It is possible to read the effects from the changes in the ventilation, e.g. optimal PEEP or broncho-dilating agents, which give a direct change in resistance.

Assessment of curves

Volume controlled ventilation and constant flow, in order to calculate resistance

Resistance is indicated by a pressure drop that occurs during the pause.

- Big amplitude of pressure drop indicates high airway resistance.

Resistance is calculated according to the formula:

$$\begin{aligned} \text{Resistance (cm H}_2\text{O/l/s)} &= \\ &= P_{\text{res.}} \text{ (cm H}_2\text{O)} \times \frac{60}{\text{PRESET INSP. MIN. VOL. (l/min)}} \times \\ &\quad \times \frac{\text{Insp. \%}}{100} \end{aligned}$$

Volume controlled or pressure controlled ventilation, in order to calculate compliance

Compliance is indicated by a pressure drop during the expiration phase.

- Big drop in pressure (P_{compl}) indicates low compliance, i.e. poor elasticity in lungs and chest, i.e. high elastic resistance.

Compliance is calculated according to the following formula:

$$\begin{aligned} \text{Compliance (ml/cm H}_2\text{O)} &= \\ &= \frac{\text{PRESET INSP. MIN. VOL. (l/min)}}{\text{BREATHS/min}} \\ &\quad \times \frac{1000}{P_{\text{compl.}} \text{ (cm H}_2\text{O)}} \end{aligned}$$

Not valid if the flow has not reached zero when the next expiration starts or if the patient makes breathing efforts.

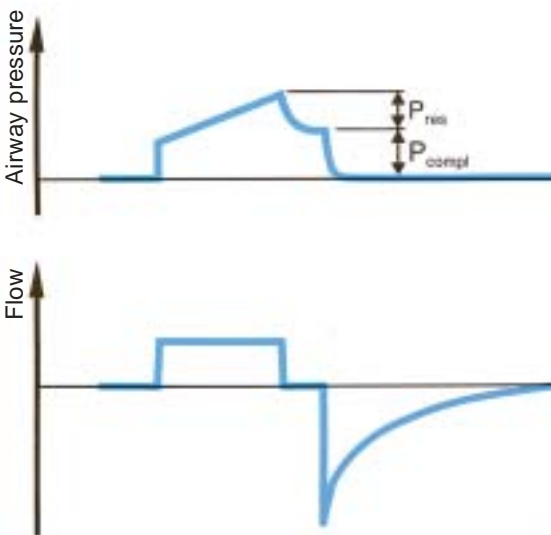
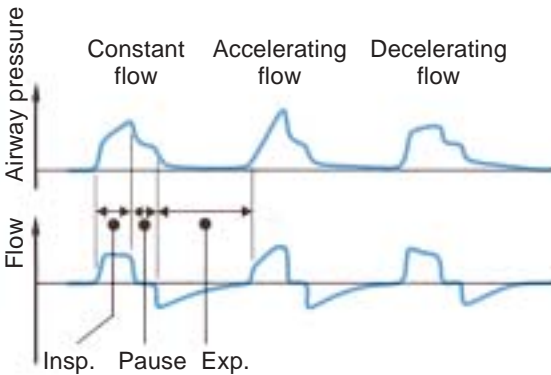

Routine cleaning

Servo Ventilator 900 C has been constructed so that the cleaning and sterilizing of contaminated parts can be carried out simply and rapidly.

Routine cleaning should be carried out after every patient or daily, according to the hospital routines.

In this chapter:

Hygiene	10:2
Dismantling	10:2
Cleaning	10:4
Assembling	10:6

Hygiene

The gas, which passes the ventilator's inspiration system and is supplied to the patient is usually clean and dry. It also passes a bacteria filter.

The dry environment gives unfavorable conditions for bacterial growth, and bacteria spreading against the gas flow is considered virtually impossible.

Bacteria from the patient will, on the other hand, appear in the moist environment of the expiration side. By attaching a disposable bacteria filter to the expiratory inlet of the ventilator, the transmission of bacteria to the expiratory channel and out into the room is reduced. This reduces the risks of infections being spread to the staff as well as cross infections between patients.

Exchange or cleaning of patient tubes and the parts of the expiratory channel and exchange of expiratory bacteria filter is recommended after each patient or according to the hospital routines. The bacteria filter should be replaced according to manufacturer recommendations.

The gas conveying parts of the expiration system can be decontaminated and sterilized.

The parts of the inspiration system should be sterilized or replaced by clean parts after an operating time of 1000 hours or, at the latest, half-yearly, according to chapters 10 and 11 in this manual.

All personnel should be aware of the risk of parts being infected when disassembling and cleaning the ventilator.

Dismantling

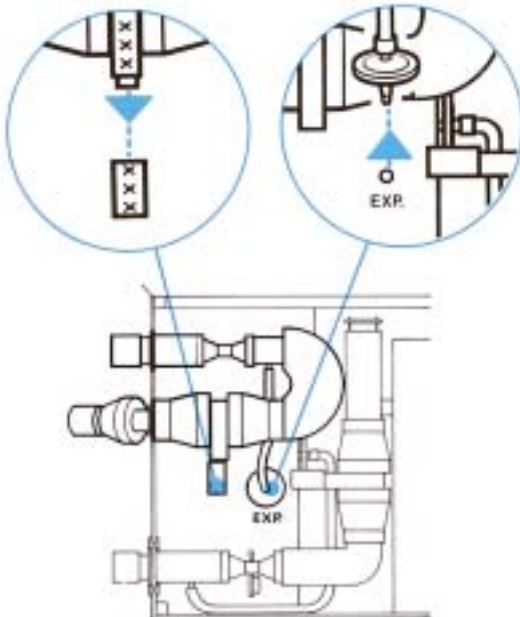

- 1
 - Remove gas connections.
 - Disconnect the power cable.
 - Remove patient tubes, humidifier and manual ventilation accessory.
 - Remove the O₂FLUSH quick-coupling (if used).
 - Wipe the outside of the ventilator with a cloth moistened in a disinfectant.

- 2
 - Open the lid on the pneumatic unit.
 - Disconnect the connector from the flow transducer on the expiration side.
 - Remove the bacteria filter from the pressure transducer marked EXP.

Dismantling



3

- Lift the whole expiration channel upwards.

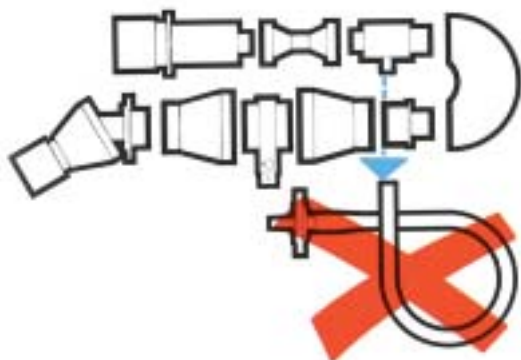
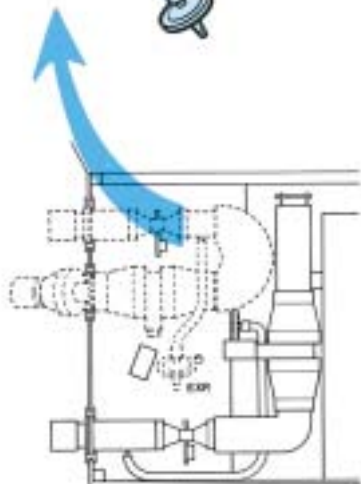

- Dismantle the different parts.
- Discard the tube and bacteria filter for the pressure transducer.

Cleaning

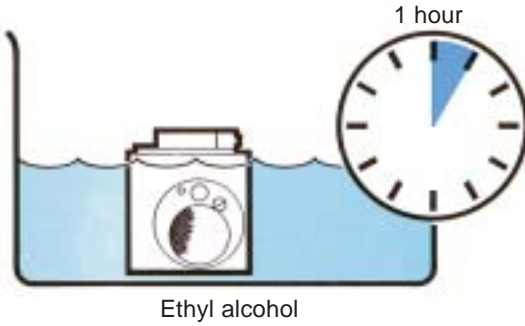

1

- Let the flow transducer lie in a 70% ethyl alcohol solution for about one hour.

The flow transducer is a precision instrument and must be handled carefully. The metal disc in the small channel of the transducer is very fragile and may break if it is handled carelessly.

Do not poke at the metal disc in the small transducer channel.

Do not flush the channel with water.

The flow transducer must not be cleaned in a dish washing machine, by ultrasound or by using agents which contain aldehydes.

Solutions other than ethyl alcohol may give rise to disturbances in the function of the flow transducer.

If agents other than ethyl alcohol are used for disinfection, the cleaning routines should be carried out according to the instructions of the respective manufacturers.

The agents used for cleaning and disinfection must have a pH between 4 and 8.5.

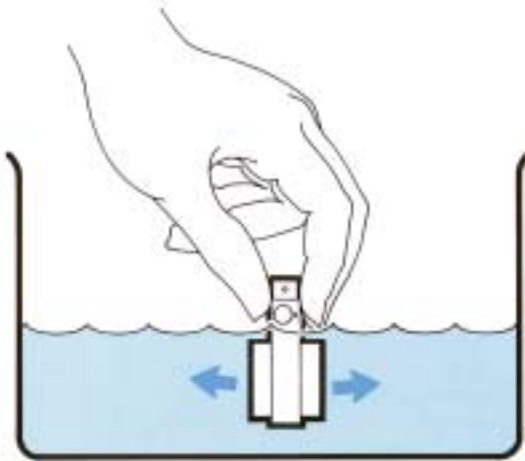

- If solutions other than ethyl alcohol are used, rinse the solution from the flow transducer by carefully moving the transducer to and fro in a bowl containing distilled water.

Let the water run off the flow transducer after rinsing.

- Make sure that the fine mesh net in the transducer is not blocked or damaged, and that the disc in the small channel is in position.



Cleaning

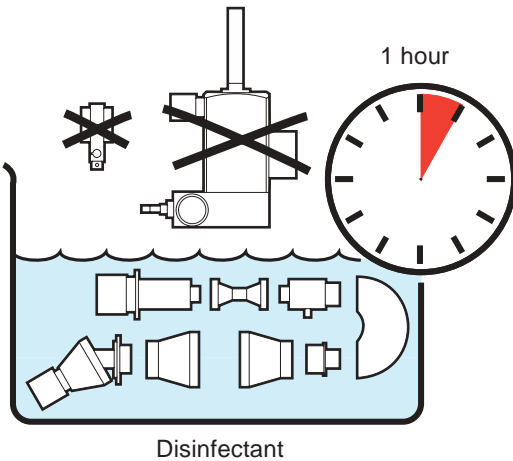
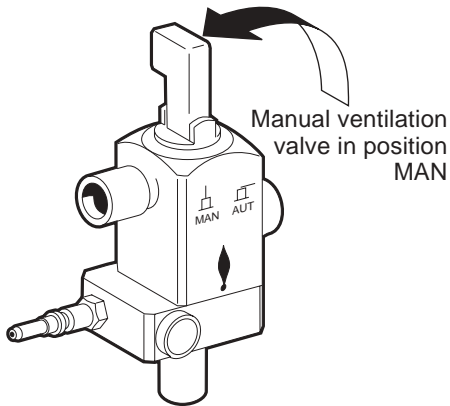

2

- If the manual ventilation valve should be cleaned, do as follows:
- Set the valve in the MAN position, and let it lie in a 70% ethyl alcohol solution for about one hour.

3

- Let the other parts (NOTE! *not* the flow transducer and manual ventilation valve) lie in a disinfectant for about one hour.
- After this, rinse the parts in water to remove the disinfectant.

4

- Autoclave all parts, including the flow transducer and manual ventilation valve at a maximum temperature of 150°C (300°F).

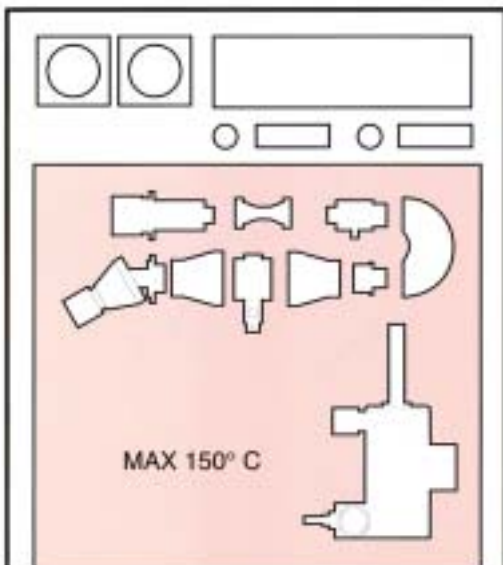

Assembling

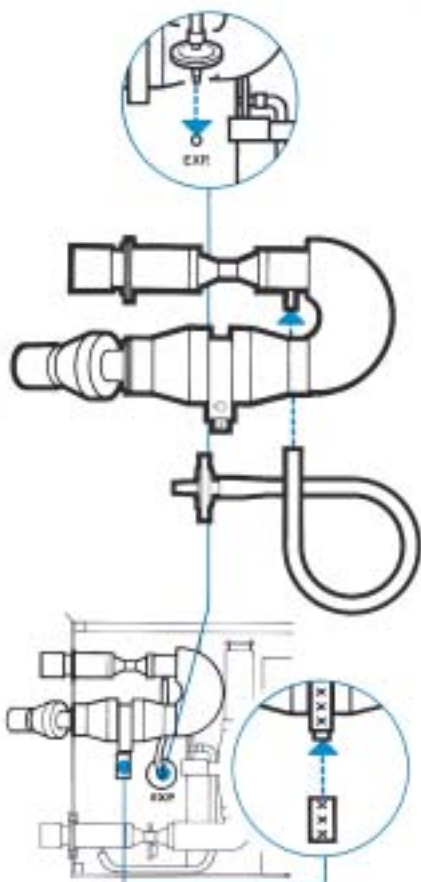

- 1
 - Put a new bacteria filter with tube on the pressure transducer marked EXP.

Make sure that the bacteria filter (without caps) is properly connected to the pressure transducer. Otherwise, the expiration could be blocked.

- 2
 - Assemble the expiration channel.
 - Connect the tube from the pressure transducer on the expiration side to the metal pipe. Make sure that the pressure transducer tube is not bent or pinched. The tube should be placed below the silicone rubber muff.
 - Push the expiration channel down into position.
 - Make sure that the expiration valve is not bent or twisted.

- 3
 - Connect the connector to the flow transducer.
 - Make sure that the serial numbers on the transducer and on the connector agree.

- 4
 - Fit the manual ventilation accessory, O₂FLUSH quick-coupling (if required) and new patient tubes.

- 5
 - Note on the log sheet that routine cleaning has been carried out.

- 6
 - Carry out a check on functions after cleaning (see chapter 6).

After autoclaving in certain autoclaves, the flow transducer may be somewhat damp, and this may give rise to incorrect readings on the EXPIRED MINUTE VOLUME meter.

The moisture is removed in the following way:

- Connect the power cable.
- Connect a test lung to the Y-piece.
- Connect compressed air to the ventilator and let it run for about 15 minutes with a PRESET INSP. MIN. VOLUME of 7.5 l/min.
- Store the ventilator under a cover in normal room temperature and humidity.

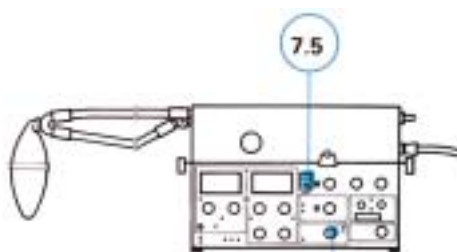

VOL. CONTR.

1000 hours overhaul with complete cleaning

After every 1000 hours of operation or after every six months, at the latest, a 1000 hours overhaul should be carried out.

In this chapter:

Dismantling	11:2
Cleaning	11:4
Assembling	11:6

Dismantling

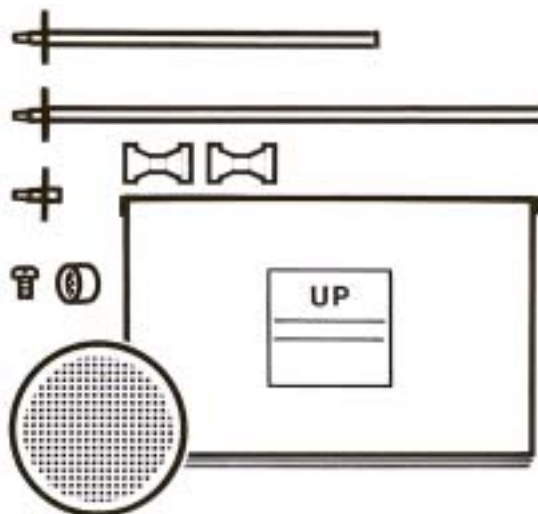

Disposable parts

- 3 bacteria filters (2 with tubes for pressure transducers + 1 without tube for WORKING PRESSURE manometer),
- 1 blue main flow bacteria filter (for gas supply unit),
- Bellows,
- 2 rubber valves (insp. and exp.),
- Net for exp. flow transducer.

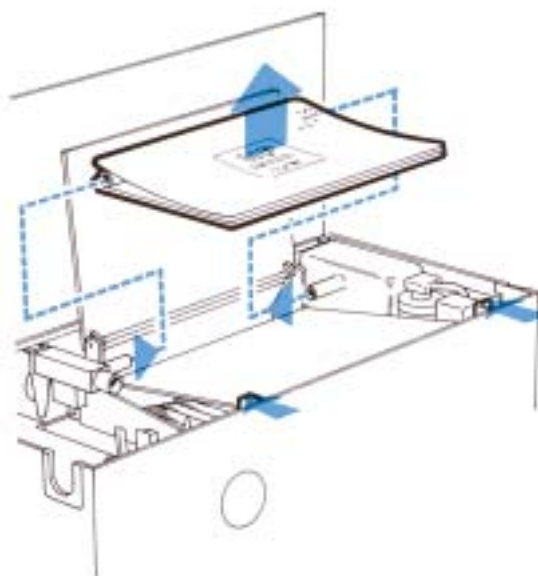

- 1

 - Remove the gas connections.
 - Disconnect the power cable.
 - Remove the patient tubes, humidifier and manual ventilation accessory. Also disconnect the O₂FLUSH quick-coupling (if used).
 - Wipe the outside of the ventilator with a cloth moistened in a disinfectant.
- 2

 - Open the lid on the pneumatic unit.
- 3

 - Open the lid over the bellows by releasing the locking pawls on the front edge of the lid.
 - Remove the bellows.
 - Discard the bellows.

Dismantling

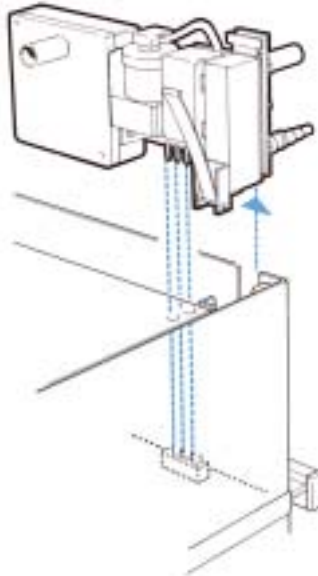
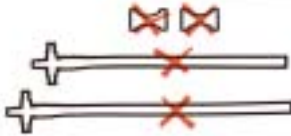

- 4
 - Disconnect the connectors to the flow transducers.
 - Remove the bacteria filters from the pressure transducers marked INSP. and EXP.
 - Lift the inspiration channel, excluding the safety valve, straight upwards.
- 5
 - Remove the safety valve.
 - Remove the bacteria filter of the manometer tube from the safety valve (Luer-lock adapter).
 - Discard the filter.
- 6
 - Lift the expiration channel straight upwards.
- 7
 - Dismantle the parts in the inspiration and expiration channels.
 - Discard the rubber valve in the inspiration and expiration channels.
 - Discard the tubes and bacteria filters for the pressure transducers.
- 8
 - Grasp the gas connection nipples and lift the gas supply unit straight upwards.
- 9
 - Unscrew the filter container with a hexagonal spanner 5 mm.
 - Discard the blue bacteria filter.
- 10
 - Remove the connector at the top of the O₂ cell.
 - Remove the O₂ cell by turning it counter-clockwise.
 - Discard the O₂ cell if it is exhausted.

Cleaning

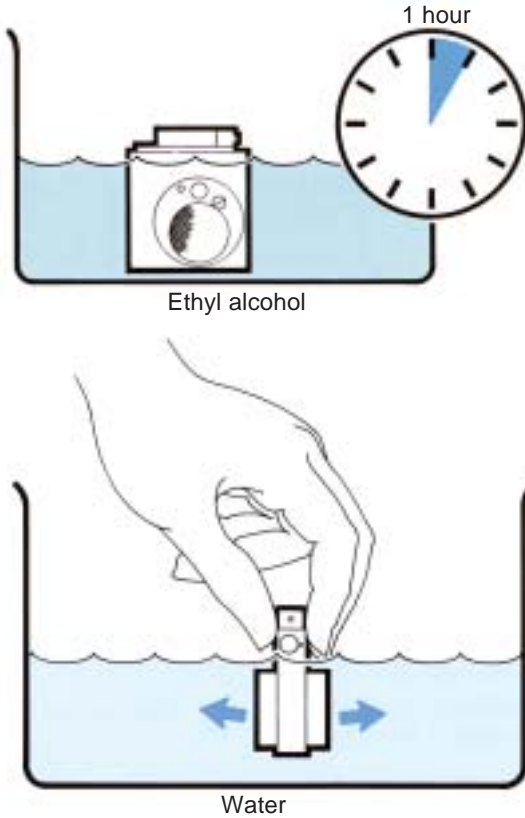

- 1 Let the flow transducers lie in a 70% ethyl alcohol solution for about one hour.

The flow transducers are precision instruments and must be handled with care. The metal disc in the small channel of the transducer is very fragile and may break if it is handled carelessly.

Do not poke at the metal disc in the small transducer channel.

Do not flush the channel with water.

The flow transducers must not be cleaned in a dish washing machine, by ultrasound or by using agents which contain aldehydes.

Solutions other than ethyl alcohol may give rise to disturbances in the function of the flow transducers.

If agents other than ethyl alcohol are used for disinfection, the cleaning routines should be carried out according to the instructions of the respective manufacturers.

The agents used for cleaning and disinfection must have a pH between 4 and 8.5.

- 2 If solutions other than ethyl alcohol are used, rinse the solution from the flow transducers by carefully moving the transducer to and fro in a bowl containing distilled water.

Let the water run off the flow transducers after rinsing.

- 2 Make sure that the fine mesh nets in the transducers are not blocked or damaged, and that the disc in the small channel is in position.

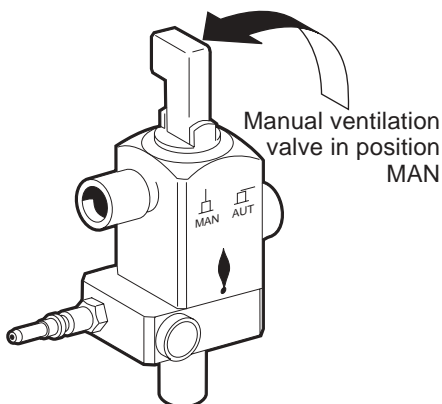

- 2 Clean the manual ventilation valve:

- 2 Set the valve in the MAN position, and let it lie in a 70% ethyl alcohol solution for about one hour.

Cleaning

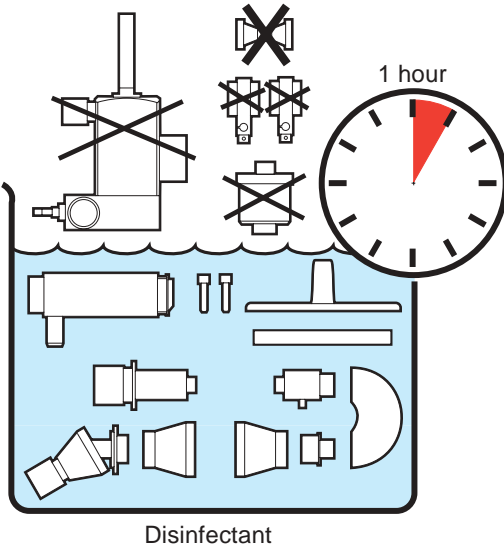

3

- Clean the gas supply unit.

The gas supply unit must not be immersed in any liquid.

The gas supply unit must not be autoclaved.

Only the lid and the gasket can be cleaned and autoclaved.

- Open the gas supply unit.
- Put the lid, gasket and screws in a disinfectant for about one hour.
- Wipe the outside of the gas supply unit with a soft cloth moistened in a disinfectant.

4

- Let the other parts lie in a disinfectant solution for about one hour. (NOTE! *Not* the flow transducers, manual ventilation valve, O₂ cell and gas supply unit).

5

- After cleaning and rinsing, all parts (*not* the O₂ cell and gas supply unit) can be autoclaved at a maximum temperature of 150°C (300°F).

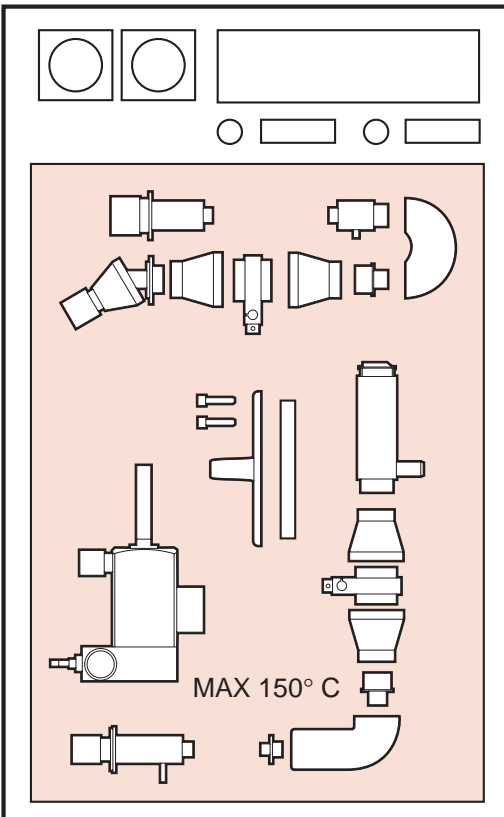

Assembling

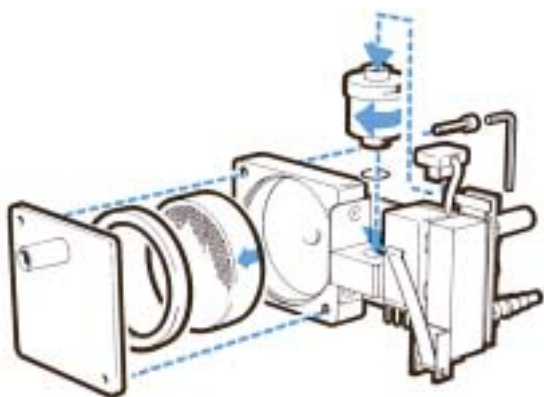

- 1
 - Insert a new blue filter in the filter container.
 - Ensure that the filter is positioned correctly, i.e. with the indicating arrow in the flow direction.
 - Tighten the filter container.

- 2
 - Put, if required, a new O₂ cell with O-ring in place by turning it clockwise.
 - Connect the connector to the top of the O₂ cell.

- 3
 - Place the gas supply unit in the ventilator.

- 4
 - Put a new bacteria filter on the manometer tube.
 - Connect the bacteria filter to the safety valve.
 - Mount the safety valve in position in the ventilator.

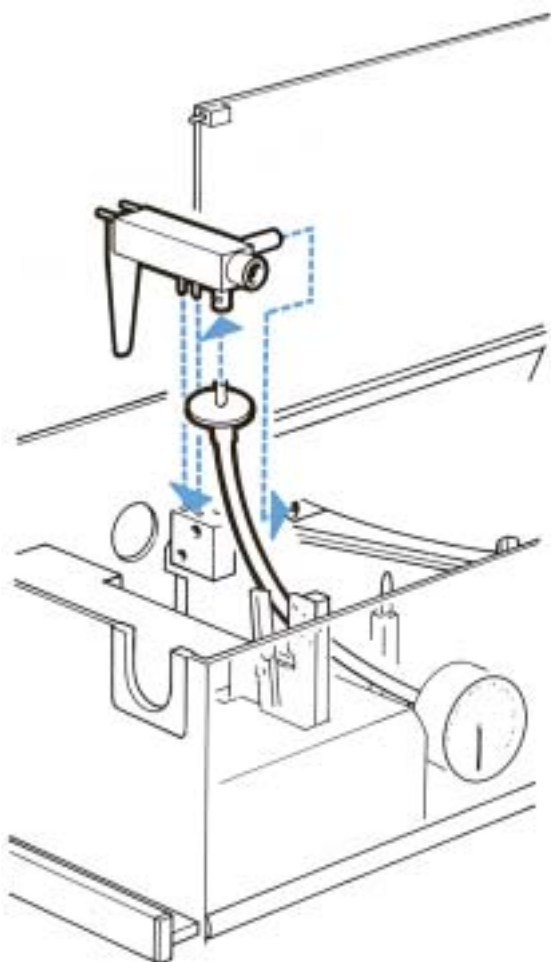

Assembling

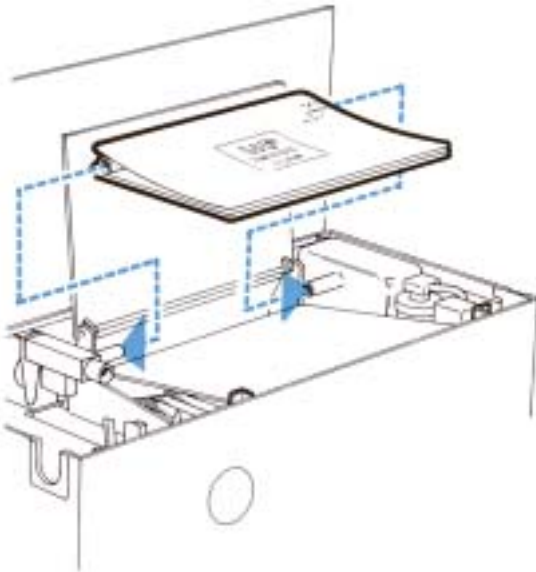

- 5
- Put in a new bellows. Make sure it is right side up, i.e. upper side marked UP.
 - Push the bellows onto the connection tubes.
 - Make sure that the bellows is centered.
 - Shut the lid over the bellows and secure the locking pawls on the front edge of the lid.

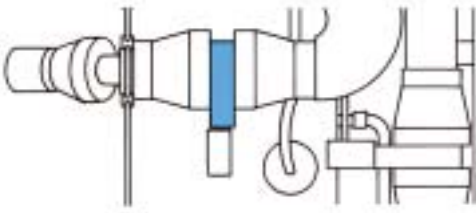

- 6
- Replace the fine mesh net in the expiratory flow transducer as follows:

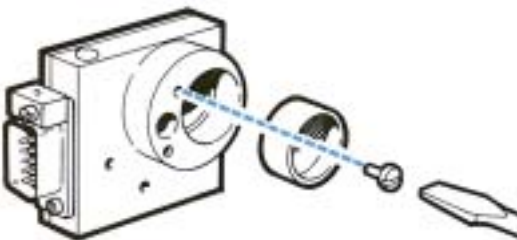

- Loosen the screw.
- Shake the flow transducer gently until the net loosens.
- Insert and secure the new net.

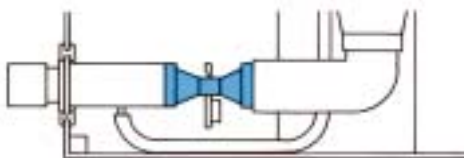

- 7
- Replace the rubber valve in the inspiration channel.

Assembling

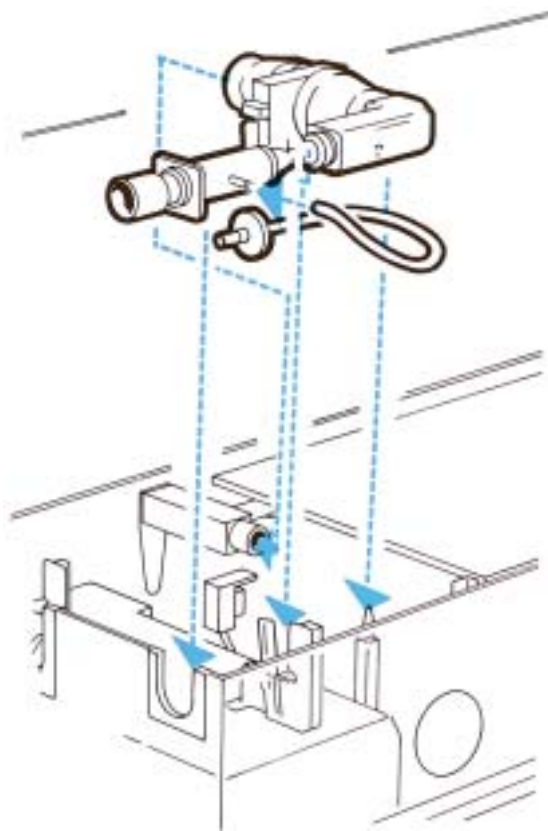

- 8
- Assemble the parts of the inspiration channel.
 - Put a new pressure transducer tube and bacteria filter on the pipe of the inspiration channel (see picture).

- 9
- Push the inspiration channel down into position and thread the silicone rubber bend onto its supporting pin.
 - Make sure that the inspiration valve is correctly positioned and that it is not bent or twisted.

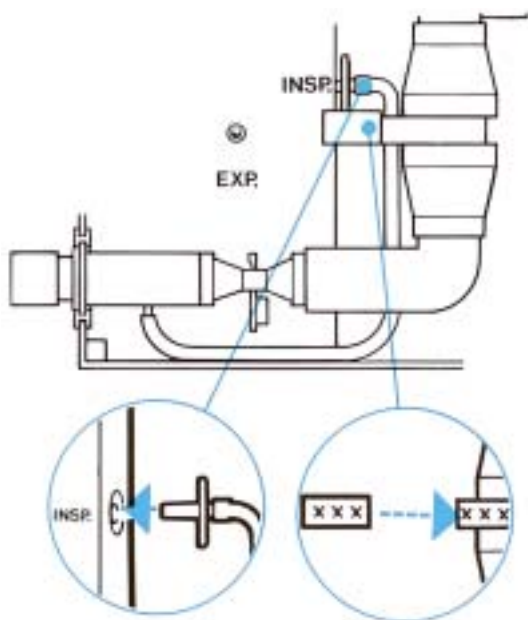

- Connect the filter to the pressure transducer marked INSP.
- Make sure that the pressure transducer tube is not bent or pinched.

- 10
- Connect the connector to the flow transducer.
 - Make sure that the serial numbers on the transducer and on the connector agree.

Assembling

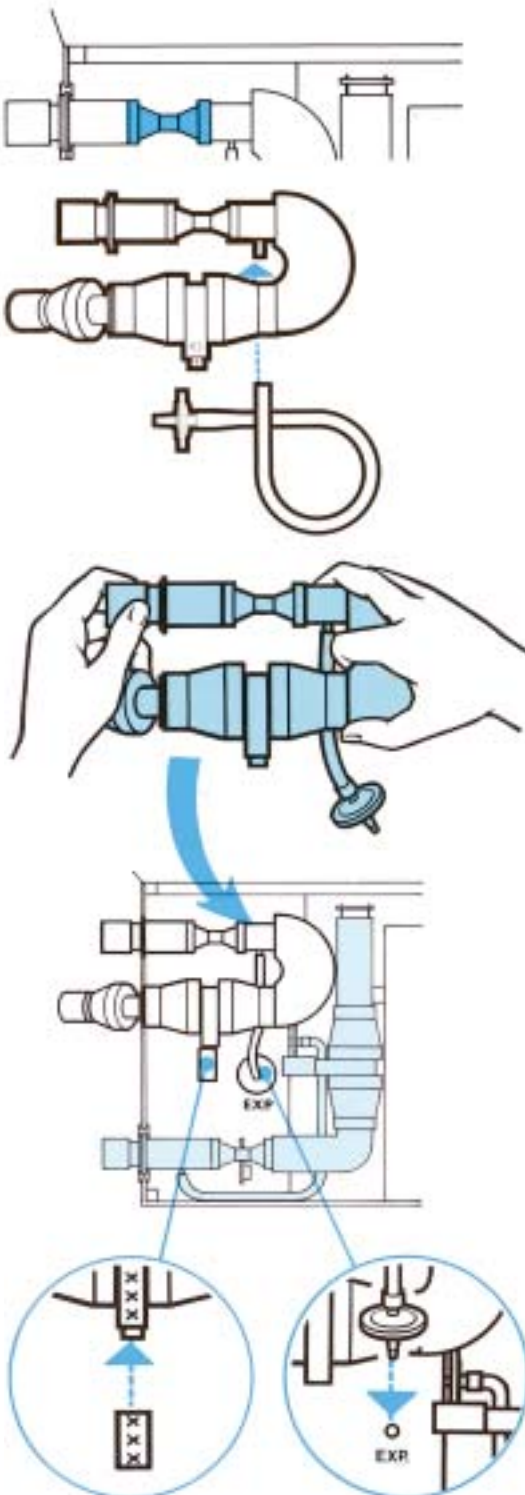

11

- Replace the rubber valve in the expiration channel.

12

- Assemble the parts of the expiration channel.
- Put a new pressure transducer tube and bacteria filter on the pipe of the expiration channel.
- Connect the filter to the pressure transducer marked EXP.

13

- Push the expiration channel into position. Thread the silicone rubber bend onto its supporting pin.
- Make sure that the expiration valve is not bent or twisted.
- Make sure that the pressure transducer tube is not bent or pinched.

Make sure that the bacteria filter is properly connected to the pressure transducer. Otherwise, the expiration could be blocked.

14

- Connect the connector to the flow transducer.
- Make sure that the serial numbers on the transducer and on the connector agree.

15

- Connect manual ventilation accessory, O₂FLUSH quick-coupling (if required) and new patient tubes.

16

- Note on the log sheet that a complete cleaning has been carried out.

17

- Calibrate the ventilator (see chapter 13).

18

- Check/Calibrate the O₂ cell (see chapter 12).

19

- Carry out a check on functions (see chapter 6).

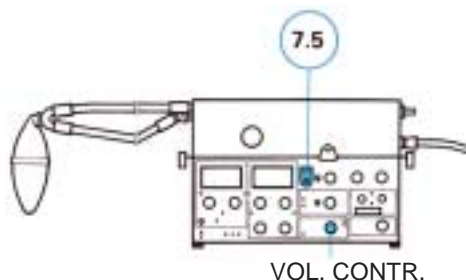

After autoclaving in certain autoclaves, the flow transducers may be somewhat damp, and this may give rise to incorrect readings on the EXPIRED MINUTE VOLUME meter.

The moisture is removed in the following way:

- Connect the ventilator to mains.
- Connect a test lung to the Y-piece.
- Connect compressed air to the ventilator and let it run for about 15 minutes with a PRESET INSP. MIN. VOLUME of 7.5 l/min.
- Store the ventilator under a cover in normal room temperature and humidity.

Replacement of O₂ cell

The O₂ cell is an expendable item. An indication of an expended O₂ cell is a deterioration of the linearity and/or a rapid drop in the O₂ concentration readings on the digital display. To avoid alarm when the O₂ cell is exhausted, the connector at the top of the O₂ cell must be disconnected. If the O₂ cell is removed, a plastic cover with an O-ring has to be put in its place.

Sealed unit contains caustic. Leaked liquid may cause severe burns to skin and eyes. In case of contact, immediately flush with plenty of water for at least 15 minutes. For eyes, get medical attention.

In this chapter :

Replacement	12:2
Calibration.....	12:2
Log sheet	12:2

Replacement and calibration

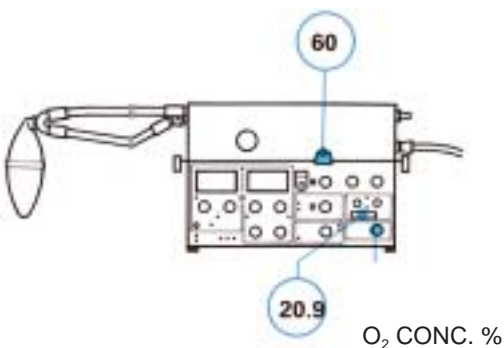
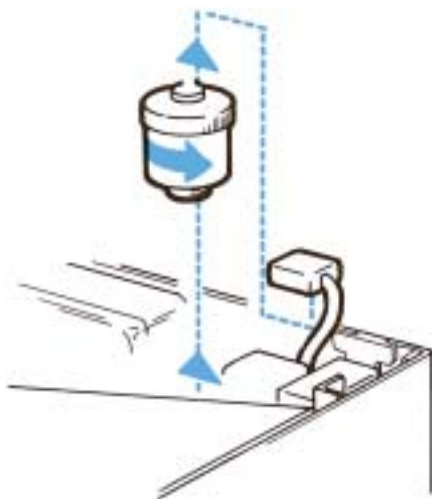

Replacement

- 1 Unpack the O₂ cell at least 30 minutes before replacement/calibration.
- 2 Disconnect mains supply and compressed air.
- 3 Disconnect the connector at the top of the O₂ cell.
- 4 Remove the O₂ cell by turning it counter-clockwise.
- 5 Connect the ventilator to mains supply and let it run for about 15 minutes.
- 6 Set the parameter selector at O₂ CONC. %.
- 7 Depress the pushbutton and adjust with trimmer 10 until the display reads 00.0.
- 8 Put the new O₂ cell in place by turning it clockwise. Do not forget the O-ring at the bottom of the O₂ cell.
- 9 Connect the connector at the top of the O₂ cell.

Calibration of O₂ cell

- 1 Connect compressed air.
- 2 Set WORKING PRESSURE to 60 cm H₂O.
- 3 The digital display should read 20.9%. If not, adjust with trimmer 9.
- 4 After about 24 hours, make sure that the O₂ cell gives a stable reading (20.9% with compressed air connected). If the reading is not 20.9%, calibrate as described above.

Log sheet

- Note on the log sheet that the O₂ cell has been replaced and calibrated.

Calibration

The calibration must be carried out after the 1000 hours overhaul and after complete cleaning.

In this chapter:

1. Basic setting for calibration 13:2
2. Check on mechanical zeroing of instruments . 13:3
3. Balancing of flow transducers 13:3
4. Electric zeroing 13:4
5. Gas supply and working pressure 13:4
6. Check of manometer and for internal leakage 13:5
7. Pressure transducers ... 13:5
8. Upper pressure limit, airway pressure 13:6
9. Triggering level 13:6
10. Flow, inspiration side ... 13:6
11. Check for leakage, (external) 13:7
12. Flow, expiration side 13:7
13. Volume alarms 13:7
14. O₂ cell 13:8
15. Log sheet 13:8

Preparations

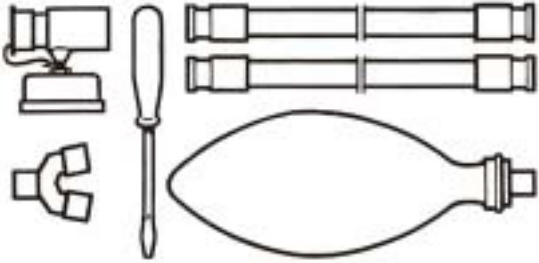

Equipment

- Calibration manometer
- Screwdriver
- 2 patient tubes
- Y-piece
- Test lung

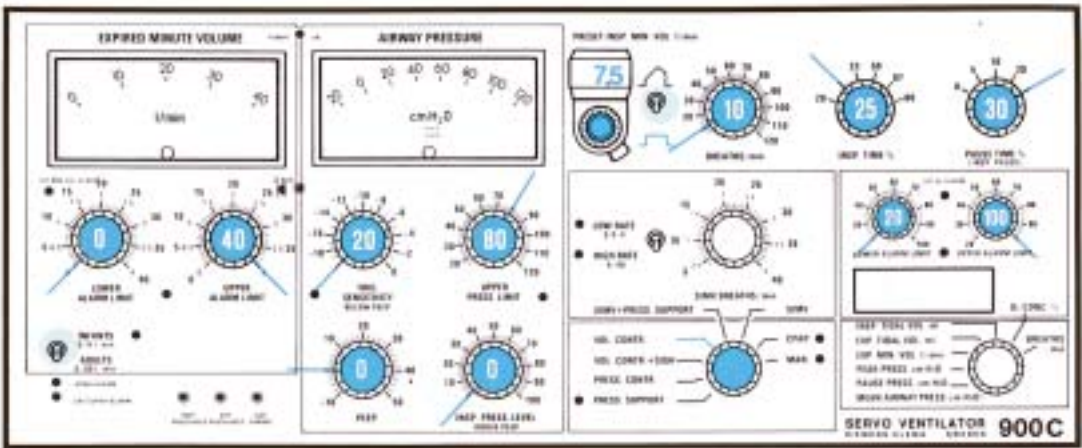

1. Basic settings for calibration

Set the following on the ventilator:

Mode VOL. CONTR.

Respiratory pattern

PRESET INSP. MIN. VOLUME . 7.5 (l/min)
 Flow pattern
 BREATHS/min 10 (breaths/min)
 INSP. TIME % 25 (%)
 PAUSE TIME % 30 (%)

Airway pressure

TRIG. SENSITIVITY -20 (cm H₂O)
 PEEP 0 (cm H₂O)
 UPPER PRESS. LIMIT 80 (cm H₂O)
 INSP. PRESS. LEVEL 0 (cm H₂O)

O₂ Concentration

LOWER ALARM LIMIT 20 (%)
 UPPER ALARM LIMIT 100 (%)

Expired minute volume

Measuring range ADULTS
 LOWER ALARM LIMIT 0 (l/min)
 UPPER ALARM LIMIT 40 (l/min)

Calibration

2. Check on mechanical zeroing of instruments

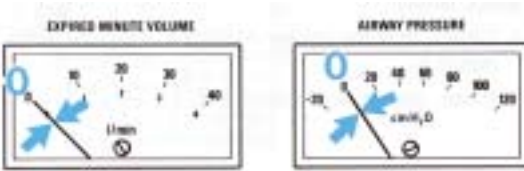

- During this check, the ventilator must not be connected to mains or to a gas supply.
- Check that the meters EXPIRED MINUTE VOLUME and AIRWAY PRESSURE read 0.
- If not, adjust the meters.

3. Balancing of flow transducers

- Open the lid on the pneumatic unit. Open the lid above the trimmers (variable resistors).

NOTE! The adjustment of trimmers is very sensitive. When adjusting, turn the trimmers very slowly while watching the lamp.

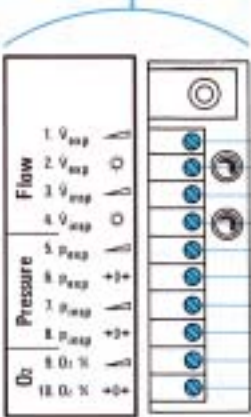
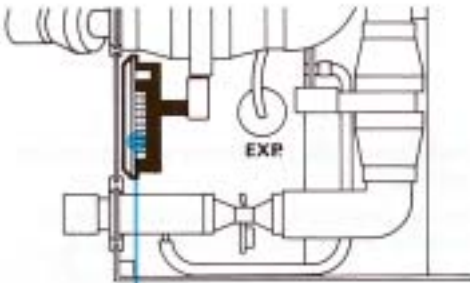

List of trimmers

1. Exp. flow. Gain
2. Exp. flow. Lamp
3. Insp. flow. Gain
4. Insp. flow. Lamp
5. Exp. pressure. Gain
6. Exp. pressure. 0-setting
7. Insp. pressure. Gain
8. Insp. pressure. 0-setting
9. O₂ %
10. O₂, 0 volt

- Connect the ventilator to mains.
- Set the mains switch on the rear of the ventilator to on. Make sure that the green lamp POWER ON lights up when you switch on.

- Let the ventilator run at least 15 minutes. Then adjust:

- a) Flow transducer on insp. side: Adjust trimmer 4 until the lamp at trimmer 4 lights up.
- b) Flow transducer on exp. side: Adjust trimmer 2 until the lamp at trimmer 2 lights up.

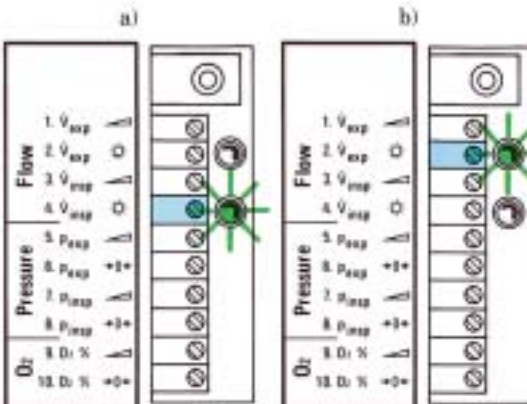

4. Electric zeroing

a) Airway pressure (pressure transducer of insp. side)

- Check that the meter AIRWAY PRESSURE reads 0.
- If not, adjust with trimmer 8.

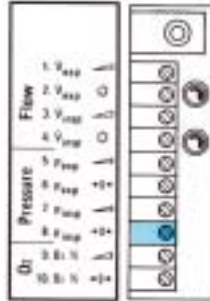
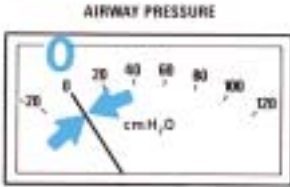

b) Airway pressure (pressure transducer of exp. side)

- Keep the pushbutton depressed and at the same time check that the meter reads 0.
- If not, adjust the reading (with pushbutton depressed) with trimmer 6.

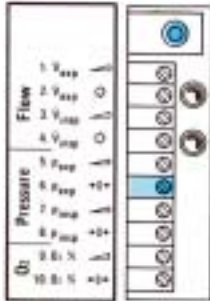

c) Expired minute volume

- Set the parameter selector at EXP. MIN. VOL l/min.
- Check that the digital display and the meter EXPIRED MINUTE VOLUME read 0. If not, the electronic unit is faulty and must be repaired by a service technician.

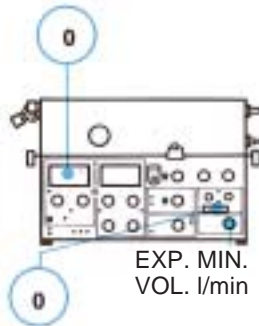
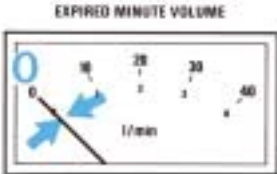

EXP. MIN.
VOL. l/min

5. Gas supply and working pressure

- Connect compressed air.
- Set the WORKING PRESSURE to 60 cm H₂O.

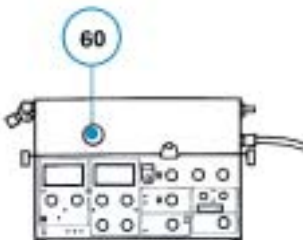

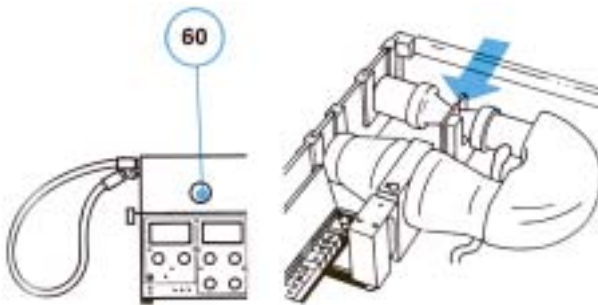
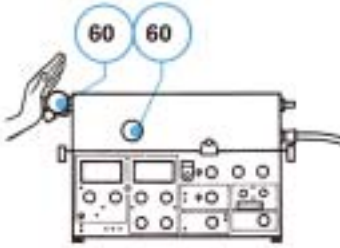

6. Check of manometer and for internal leakage

- Connect a calibration manometer to the inspiration outlet pipe.
- Block the calibration manometer.
- Check that the meter WORKING PRESSURE gives the same reading as the calibration manometer (60 ± 2 cm H₂O). If not, replace the WORKING PRESSURE manometer.
- The reading on the meter AIRWAY PRESSURE should not fall more than a few cm H₂O during the time the inspiration valve is closed. If the reading falls more, look for leakage.
- Remove the calibration manometer.
- Connect a patient tube from the inspiration outlet to the expiration inlet.
- Keep the expiration valve closed.
- The reading on the meter AIRWAY PRESSURE should not fall more than a few cm H₂O during the time the inspiration valve is closed. If the reading falls more, look for leakage in the expiration channel.

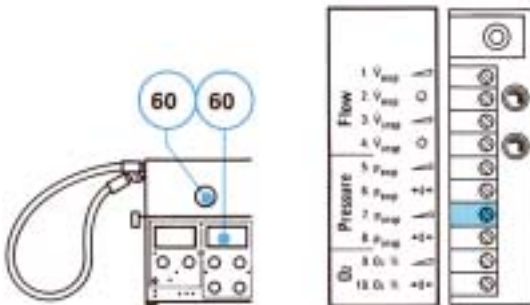

7. Pressure transducers

a) Inspiration side

- Keep the expiration valve closed.
- Check that the meter AIRWAY PRESSURE gives the same reading as the manometer WORKING PRESSURE (60 ± 1 cm H₂O).
- If not, adjust with trimmer 7.

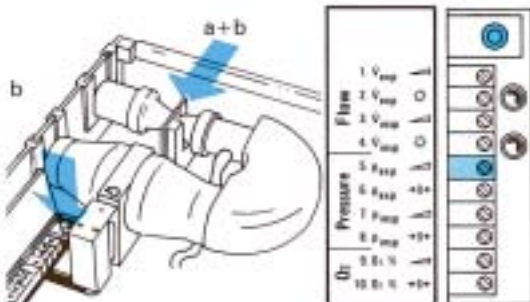

b) Expiration side

- Keep the expiration valve closed and depress the pushbutton.
- Check that the meter AIRWAY PRESSURE gives the same reading as the manometer WORKING PRESSURE (60 ± 1 cm H₂O).
- If not, adjust with trimmer 5.

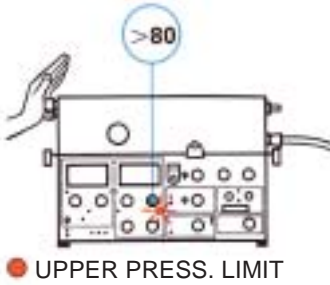

8. Upper pressure limit, airway pressure

- Block the inspiration outlet.
- Turn the knob UPPER PRESS. LIMIT slowly counter-clockwise from the position 80 cm H₂O until you reach the exact position where the alarm lamp for UPPER PRESS. LIMIT flashes. At this instant, the readings for WORKING PRESSURE and AIRWAY PRESSURE should agree with the knob setting ± 3 cm H₂O. If not, the electronic unit is faulty and must be repaired by a service technician.
- Turn the knob back to 80 cm H₂O.

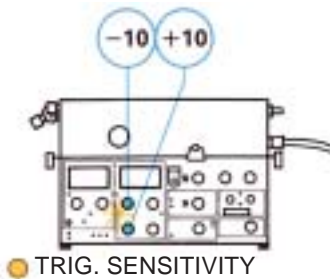

9. Triggering level

- Remove your hand from the inspiration outlet.
- Set the TRIG. SENSITIVITY to -10 cm H₂O.
- Turn the PEEP knob and check that the TRIG. lamp lights up when $+10 \pm 2$ cm H₂O is passed. If not, the electronic unit is faulty and must be repaired by a service technician.
- Reset TRIG. SENSITIVITY to -20 cm H₂O and PEEP to 0 cm H₂O.

10. Flow, inspiration side

- Set BREATHS/min to 5.
- Connect a calibration manometer to the inspiration outlet.
- Let compressed air blow through the calibration manometer for a few minutes.
- Check that the reading on the calibration manometer is 45 ± 5 cm H₂O during inspiration.
- If not, adjust with trimmer 3.
- Check that the lamp at trimmer 4 lights up at pause and expiration. If not, repeat calibration according to 3a.
- After 6-8 breaths, make sure that the calibration manometer reading is stable (45 ± 5 cm H₂O).
- Remove the calibration manometer.

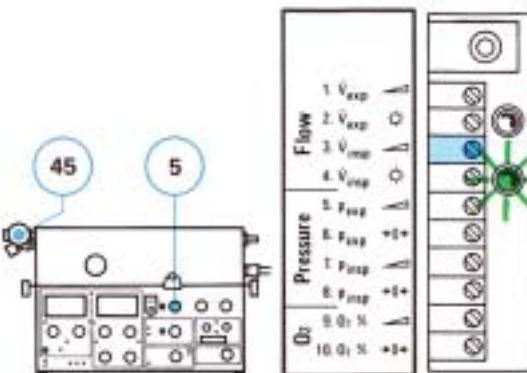

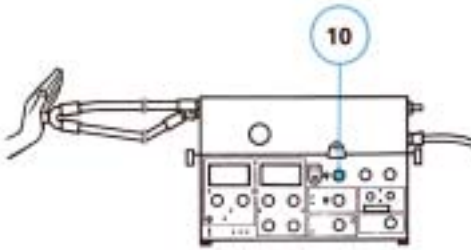

11. Check for leakage (external)

- Set BREATHS/min to 10.
- Connect tubes and Y-piece.
- Block the Y-piece.
- Make sure that the AIRWAY PRESSURE does not fall more than a few cm H₂O during pause.

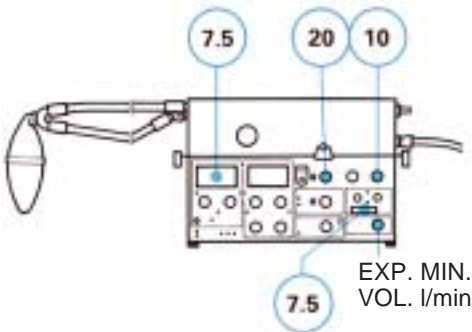

12. Flow, expiration side

- Set the respiratory rate at 20 BREATHS/min and PAUSE TIME at 10%.
- Connect a test lung.
- Set the parameter selector at EXP. MIN. VOL. l/min.
- Let the ventilator run for a few minutes.
- Check that the digital display shows 7.5 ± 0.1 l/min.
- If not, adjust with trimmer 1.
- The difference between the digital display and the meter EXPIRED MINUTE VOLUME must not be more than ± 0.5 l/min.
- Check that the lamp at trimmer 2 lights up at inspiration and pause. If not, repeat calibration according to 3B.
- After 6-8 breaths, make sure that the reading is stable.

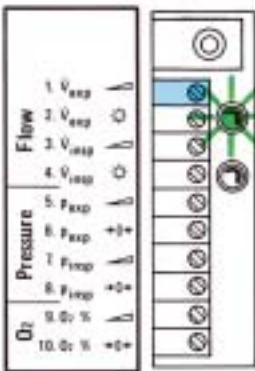

13. Volume alarms

Lower alarm limit

- Turn the knob LOWER ALARM LIMIT to 7.5 l/min and make sure that the alarm is activated at 7.5 ± 0.5 l/min.
- Turn the knob LOWER ALARM LIMIT to 0 l/min.

Upper alarm limit

- Turn the knob UPPER ALARM LIMIT to 7.5 l/min and make sure that the alarm is activated at 7.5 ± 0.5 l/min.
- Turn the knob UPPER ALARM LIMIT to 40 l/min.

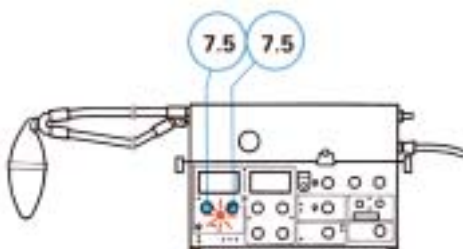

● MIN. VOL. ALARM LIMITS

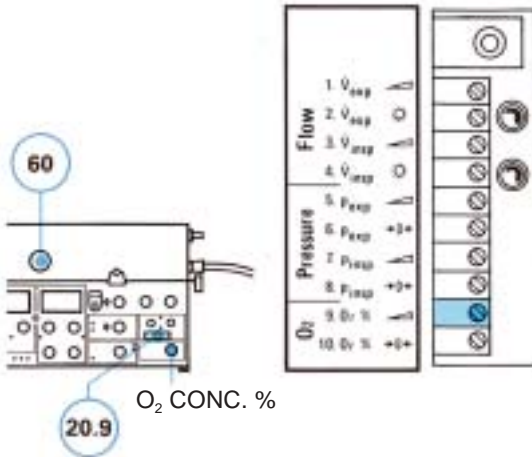

14. O₂ cell

- Set the parameter selector at O₂ CONC. %.
- The digital display should read 20.9% (with compressed air connected and WORKING PRESSURE 60 cm H₂O).
- If not, adjust with trimmer 9.
- Normally, trimmer 10 needs not to be adjusted. If necessary, see chapter 12.
- Make sure that the UPPER ALARM LIMIT and LOWER ALARM LIMIT are functioning correctly.

15. Log sheet

- Note on the log sheet that the ventilator has been calibrated.

Technical specifications

In this chapter:

Gas and power supply ..	14:2
Ventilation parameters and controls	14:2
Special functions	14:2
Monitoring	14:2
Alarm and indicators	14:3
General	14:4

Technical specifications

Gas and power supply

Gas	Must fulfill specifications for medical gases.
Gas consumption	Approximately equal to preset inspiratory minute volume or equal to flow meter setting.
Gas supply via high pressure inlet	From central gas supply, compressor or gas cylinder.
Electronic gas supply unit, inlet pressure	2.5-5 bar (250-500 kPa).
Other gas supply unit, inlet pressure	2.5-7 bar (250-700 kPa).
Gas supply via low pressure inlet	From flowmeter(s).
Power supply	(100), 110 120 220 240 V $\pm 10\%$, 50 or 60 Hz.
Power consumption	Approximately 40 W.

Ventilation controls, control ranges

Working pressure	Up to 120 cm H ₂ O.
Modes	VOL. CONTR. (Volume controlled). VOL. CONTR. + SIGH (Volume controlled with sigh). PRESS. CONTR. (Pressure controlled). PRESS. SUPPORT (Pressure support). SIMV (Synchronized Intermittent Mandatory Ventilation). SIMV + PRESS. SUPPORT. CPAP (Continuous Positive Airway Pressure). MAN. (Manual ventilation—auxiliary equipment necessary).
Preset inspiratory minute volume	0.5-40 l/min. With sufficient working pressure. Accuracy (for momentary insp. flow up to 1.6 l/s): $\pm 10\%$ or 0.2 l/min.
Flow pattern	Constant or accelerating.
Respiratory rate	5-120 breaths/minute.
Inspiration time	20, 25, 33, 50 or 80% of the respiratory cycle.
Pause time	0, 5, 10, 20 or 30% of the respiratory cycle.
Inspiratory pressure (above PEEP)	0-100 cm H ₂ O.
PEEP	0-50 cm H ₂ O.
Upper pressure limit	15-120 cm H ₂ O.
Trig sensitivity (below PEEP)	-20-0 cm H ₂ O.
SIMV-rate	HIGH RATE (4-40 SIMV breaths/min). LOW RATE (0.4-4 SIMV breaths/min.).
Sigh	Double tidal volume every hundredth breath.
Compressible volume (internal)	0.075 l.

Special functions

Inspiratory pause hold
Expiratory pause hold
Gas change

Monitoring

Analog presentation

Airway pressure	Range -20-120 cm H ₂ O. Accuracy: $\pm 5\%$ or ± 2 cm H ₂ O.
-----------------------	---

Technical specifications

Expired minute volume ADULTS range 0-40 l/min. Accuracy (for momentary exp. flow up to 1.6 l/s): $\pm 5\%$ or ± 0.5 l/min. INFANTS range 0-4 l/min. Accuracy (for momentary exp. flow up to 1.6 l/s): $\pm 5\%$ or ± 0.2 l/min.

Digital presentation

Respiratory rate Range 5-120 breaths/min. Accuracy (in controlled ventilation): $\pm 10\%$ or ± 1 breath/min. Presented in % by volume; Range 20-100%. Accuracy (applying for the barometric pressure and working pressure at which the O₂ cell is calibrated): $\pm 5\%$ of read value.

O₂ concentration Range 0-1999 ml. Accuracy (for momentary insp flow up to 1.6 l/s): $\pm 10\%$ or 0.2 l/min. resp. rate.

Inspired tidal volume Range 0-1999 ml. Accuracy (for momentary exp, flow up to 1.6 l/s): $\pm 5\%$ or 0.2 l/min. resp. rate.

Expired tidal volume ADULTS range 0-40 l/min. INFANTS range 0-4 l/min. Accuracy (for momentary exp. flow up to 1.6 l/s): $\pm 5\%$ or ± 0.2 l/min.

Expired minute volume Range 0-120 cm H₂O. Accuracy: $\pm 5\%$ or ± 2 cm H₂O.

Peak pressure Range 0-120 cm H₂O. Accuracy: $\pm 5\%$ or ± 2 cm H₂O.

Pause pressure Range 0-120 cm H₂O. Accuracy: $\pm 5\%$ or ± 2 cm H₂O.

Mean airway pressure Range 0-120 cm H₂O. Accuracy: $\pm 5\%$ or ± 2 cm H₂O.

Alarms and indicators

Push button 2 min. Audible signals, below marked *, muted for 2 minutes. (max).

Alarms



Gas supply alarm Flashing red light, audible * signal. Inoperative at respiratory rates higher than 80 breaths/minute and INSP. TIME % 20 or 25.

Apnea alarm The APNEA ALARM is activated with audible * signals and flashing light if the time between any two consecutive breaths, spontaneous or mandatory or a combination of the two, is greater than approximately 15 seconds (4 breaths/min or less). The APNEA ALARM is not intended to and will not monitor for disconnections. The APNEA ALARM is operative in CPAP, PRESS. SUPPORT, SIMV, and SIMV + PRESS. SUPPORT.

Expired minute volume Flashing red light, audible * signal.

O₂ concentration Flashing red light, audible * signal.

Upper pressure limit Red light, audible * signal.

Power failure Green light POWER ON goes out, audible signal for approximately 5 minutes.

Technical specifications

Indicators

Set minute volume alarm	Alarm limit unset: Flashing yellow light.
Set O ₂ alarm	Alarm limit unset: Flashing yellow light.
Pressure support	Mode indication: Yellow light.
CPAP	Mode indication: Yellow light.
MAN	Mode indication: Yellow light.
SIMV, HIGH/LOW RATE	Mode and range indication: Two yellow lights.
Expired minute volume INFANTS	Range indication: Yellow light.
Patient trig	Trig indication: Yellow light.

General

Maximum working pressure	120 cm H ₂ O.
Dimensions	W50 × D23 × H32 cm.
Weight	Approximately 19 kg.

Specified accuracies apply for medical air and imply that the ventilator is calibrated according to the Operating Manual. For accuracies specified in more than one way, the highest value applies.

- SV 900 is an intensive care/anesthetic ventilator intended for adults, pediatric and neonates.

-  The device, if marked with the CE-symbol (including the number of the notified body) shown to the left, complies with the requirements of the Medical Device Directive 93/42/EEC.

- Classification according to IEC 601:

Class I equipment



Type B

Continuous operation

- Symbols on the equipment:



Type B according to IEC 601.



Attention, consult Operating Manual



Alternating current



On (Power: Connection to mains)



Off (Power: Disconnection from mains)

- A device to monitor the concentration of anesthetic agents in the inspiratory gas shall be used during anesthesia.

- All measured and set parameters are referenced to ATP (Ambient Temperature and Pressure).



- Old non-functioning O₂ cells must be returned to the place of purchase or to a place where they can be disposed of properly. O₂ cells must not be disposed of with ordinary waste.

Servo Ventilator 900 C – Operating Manual.

Order No.: 69 78 761 E313E.

© Maquet Critical Care AB, 1997-2001. All rights reserved. No part of this publication may be reproduced, stored in a retrieval system, or transmitted in any form or by any means, electronic, mechanical, photocopying, recording, or otherwise, without the prior permission of the copyright owner in writing. Subject to alterations without prior notice.
Issued by Maquet Critical Care AB, SE-171 95 SOLNA, Sweden.

Printed in Sweden
Price: Group 0
0803.0.6
9th English edition, August 1997

MAQUET

SERVO VENTILATOR 900 C – OPERATING MANUAL