

SIEMENS

Servo*i* Service Manual

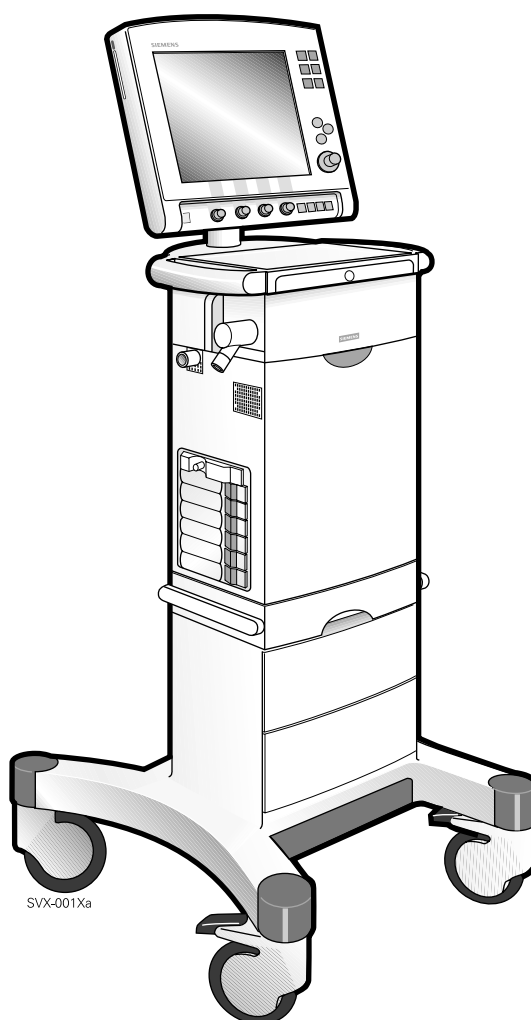

Notes

Contents

| | |
|---------------------------------------|---|
| 1. Important | 1 |
| 2. Introduction | 2 |
| 3. Description of functions | 3 |
| 4. Disassembling and assembling | 4 |
| 5. Service procedures | 5 |
| 6. Troubleshooting | 6 |
| 7. Preventive maintenance | 7 |
| 8. Index | 8 |
| 9. Diagrams | 9 |

Important

General



- Service documentation for the Servoⁱ™ Ventilator System consists of:
 - User's manual
 - Service Manual
 - Spare Parts List.
- Documentation for all optional equipment included in the Servoⁱ System is also available.
- The User's manual is an indispensable complement to the Service Manual for proper servicing.
- Serial number of the unit is found on a label attached to the Patient Unit close to the supply gas inlets.
- System version number can be found in the Status window on the User Interface. Make sure that the version of the User's manual corresponds to this system version.

Text inside a box is used to highlight important information.

- In addition to the Important information given here and in the related documents (e. g. in the User's manual), always pay attention to applicable local and national regulations.
- Responsibility for the safe functioning of the equipment reverts to the owner or user in all cases in which service or repair has been done by a non-professional or by persons who are not employed by or authorized by Siemens, and when the equipment is used for other than its intended purpose.
- Data on internal pressures in the Servoⁱ System are given in Pa (bar).
Airway pressures are given in cm H₂O (Pa).

| | |
|----------------------------------|---------------------------------|
| 1 hPa = 1 mbar | 1 mbar = 1 hPa |
| 1 kPa = 10 mbar | 1 mbar = 0.1 kPa |
| 1 kPa = 0.01 bar | 1 bar = 100 kPa |
| 1 kPa ≈ 10 cm H ₂ O | 1 cm H ₂ O ≈ 0.1 kPa |
| 1 kPa ≈ 0.01 at | 1 at ≈ 100 kPa |
| 1 kPa ≈ 0.01 kgf/cm ² | 1 kgf/cm ² ≈ 100 kPa |
| 1 kPa ≈ 0.01 kp/cm ² | 1 kp/cm ² ≈ 100 kPa |
| 1 kPa ≈ 0.145 psi | 1 psi ≈ 6.9 kPa |

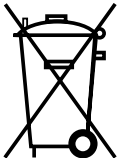
Symbols used in this manual

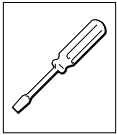
- **ESD sensitive components.** Make sure to take precautions to avoid damaging ESD sensitive components. 
- **Special waste.** Make sure to discard worn-out batteries and other disposable parts according to local regulations and in an environmentally acceptable way. 
- **Recycling.** Recycle if possible. Recycling facilities may not be available in all areas. 
- **Technical training.** Refers to the Servoⁱ Technical training supplied by Siemens. 
- **Service contract.** Refers to the Servoⁱ Service contract supplied by Siemens. 

Hazard notices

- Before disassembling or assembling the Servoⁱ System, make sure that the:
 - Gas supply is disconnected.
 - Mains power cable is disconnected.
 - On/Off switch is set to Off.
 - Battery modules are disconnected.
 - The Servoⁱ System is cleaned according to instructions in the User's manual, chapter Routine cleaning and chapter Regular maintenance, section Extended cleaning of insp. channel.
- With power supply connected to the Servoⁱ System, there are energized electrical components inside the unit. All personnel must exercise extreme caution if fault tracing or adjustments are performed with power supply connected and with user interface and patient unit covers removed.

Important

Installation

- Only personnel trained and authorized by Siemens shall be permitted to install the Servoⁱ System. The installation and handing over procedures are described in the "Servoⁱ Ventilator System – Installation Instructions".



Functional check

- After any installation, maintenance or service intervention in the Servoⁱ System, perform a Pre-use check according to instructions in the Servoⁱ Ventilator System – User's manual.

Service

- The Servoⁱ System must be serviced at regular intervals by personnel trained and authorized by Siemens. Any maintenance or service must be noted in a log book provided.
- It is recommended that maintenance and service is done as a part of a service contract with Siemens.

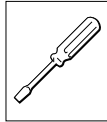

- Preventive maintenance must be performed at least once every year as long as the unit is not used more than normal. Normal operation is estimated to correspond to approx. 5.000 hours of operation. Details are found in this Service Manual, chapter "Preventive maintenance".
- Worn-out batteries must be recycled or disposed of properly according to local regulations. Recycle facilities may not be available in all areas.
- Batteries must not be disposed of with ordinary waste. All other disposable parts shall be discarded according to local regulations and in an environmentally acceptable way.
- When working with ESD sensitive components, always use a grounded wrist band and a grounded work surface. Adequate service tools must always be used.

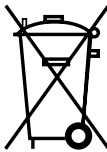

To the responsible service personnel

- The contents of this document are not binding. If any significant difference is found between the product and this document, please contact Siemens for further information.
- We reserve the right to modify products without amending this document or advising the user.
- Only personnel trained and authorized by Siemens shall be permitted to perform installation, service or maintenance of the Servoⁱ System. Only Siemens genuine spare parts must be used. PC boards (spare parts) must always be kept in a package for sensitive electronic devices. Siemens will not otherwise assume responsibility for the materials used, the work performed or any possible consequences of same.
- The device complies to standards and requirements as stated in the Servoⁱ Ventilator System – User's manual.



Important

Environmental declaration

Purpose

This environmental declaration is for a Servo^o basic unit including the carrier and one battery.

Letters codes within brackets refers to the Functional Block Diagram in chapter Diagrams.

Components with special environmental concern

Components listed below shall be disposed of in an environmentally safe way.

Printed circuit boards

- PC 1770 Main back-plane
- PC 1771 Control, including a Lithium battery (C)
- PC 1772 Monitoring, including Lithium battery (M)
- PC 1775 Plug-and-Play back-plane (P)
- PC 1777 Panel (U)
- PC 1778 Standard connectors & DC/DC (P)
- PC 1780 Pneumatic back-plane (I)
- PC 1781 Pressure transducer, 2 pcs (T)
- PC 1784 Expiratory channel (F)
- PC 1785 Exp. channel connector (E)
- PC 1786 Exp. channel cassette (E)

Other electronics

- TFT assembly including backlight (U)
- Touch screen (U)
- O₂ cell, containing Pb (I)
- Air module, containing multiple PC boards (I)
- O₂ module, containing multiple PC boards (I)
- AC/DC Converter, containing PC boards (P)
- Exp. valve coil (E)
- Safety valve pull magnet (I)

Construction materials

The construction materials used in Servo^o in % of the total weight.

Metal – total 77%

- Aluminium 70%
- Steel, zink, brass 8%

Polymeric material – total 9%

- PA (Polyamide)
- POM (Polyoxymethylene)
- SI (Silicone)
- TPE (Thermoplastic elastomer)
- PUR (Polyurethane)
- ABS (Acrylonitrilebutadienstyrene)
- EPDM (Ethylenepropylenedienemonomer)
- PTFE (Polytetrafluoroethylene)
- FPM (Fluororubber)
- NBR (Nitrilerubber)
- PP (Polypropylene)
- PVC (Polyvinyl chloride)
- PS (Polystyrene)

Electronics – total 14%

- Accumulators Nickel Metalhydride
- Printed circuit boards, cables etc.

Others – very small amounts

- Sterile filter paper of glass fibre

Important

Articles of consumption

1. Bacteria filter
2. Filters for the gas modules
3. Filter for the inspiration pressure transducer
4. Filter for the O₂ cell
5. Nozzle units for the gas modules
6. Expiratory cassette.

Item 1: Consumption approximately 250 pcs/year.

Items 2 – 5: Changed every 5000 hours.

Item 6: Changed when needed.

Power consumption

Normal use (no extra internal or external devices used).

- On 60 W
- Stand-By 42 W

Noise level

Less than 50 dBA.

Packing materials

The amounts of packing materials will vary depending on customer adaptation.

Siemens-Elema is a member of the Swedish REPA register (No. 5562378850).

Materials for packing:

- Loading pallet. Fulfils the USA requirements 7 CFR 319.40 May 25'th 1995.
- Corrugated cardboard
- Stretch film of Polyethylene, PE.
- Shock-absorbing material of expanded polyethylene, EPE, or expanded polypropylene, EPP.
- Clamps of Polyethylene, PE.

2. Introduction

| | |
|---|-------|
| Main units | 2 - 2 |
| User Interface | 2 - 3 |
| Patient Unit | 2 - 4 |
| Servo ⁱ software structure | 2 - 7 |
| General | 2 - 7 |
| Breathing | 2 - 7 |
| Monitor | 2 - 7 |
| Panel | 2 - 7 |
| System ID | 2 - 7 |



Only personnel trained and authorized by Siemens shall be permitted to perform installation, service or maintenance of the Servoⁱ System. 

Make sure that the Servoⁱ System is properly cleaned before performing any service or maintenance; routine cleaning as well as extended cleaning. For cleaning procedures, refer to the "Servoⁱ Ventilator System – User's manual".

Any service or maintenance must be noted in a log book.

All disposable parts must be discarded according to local regulations and in an environmentally acceptable way.

After any service or maintenance of the Servoⁱ System, perform a "Pre-use check". Refer to the "Servoⁱ Ventilator System – User's Manual" for details.

Main units

The Servoⁱ System is available in different main configurations:

- Infant
- Adult
- Universal

These main configurations are as standard equipped with a number of ventilation modes suitable for each patient category. Further ventilation modes can be installed via software option upgrades.

The Servoⁱ System can be divided into the following main units:

- User Interface
- Patient Unit

The Control cable connects the User Interface and the Patient Unit.

These main units are mounted onto the Servoⁱ Mobile cart which is the main body of the system.

A number of optional equipment can also be incorporated in the Servoⁱ System. Examples on such optional equipments are:

- Servo Ultra Nebulizer, Servoⁱ.
- Servoⁱ Holder for the Patient Unit.
- Gas trolley for backup gas cylinders.
- Gas cylinder restrainer for backup gas cylinders.
- IV Pole, Servoⁱ.
- User Interface panel cover.
- Battery module, Servoⁱ.
- Support Arm 177.
- Servo Humidifier.
- Humidifier Holder, Servoⁱ.

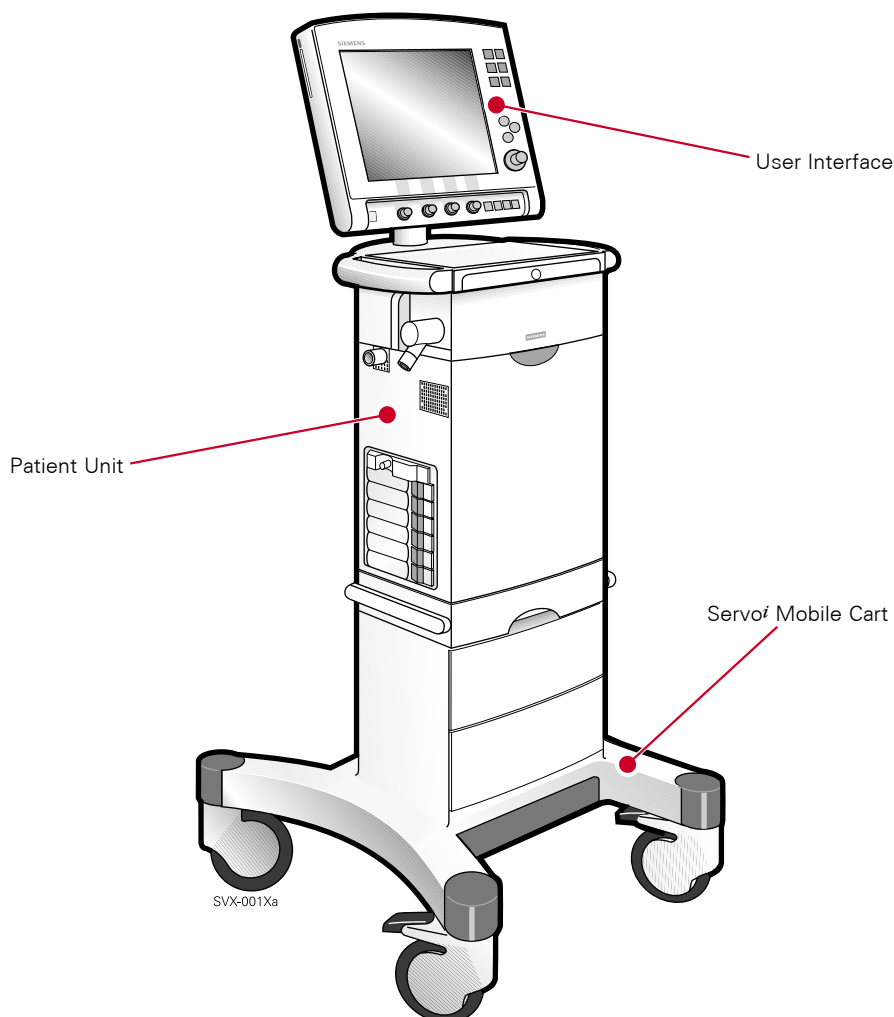

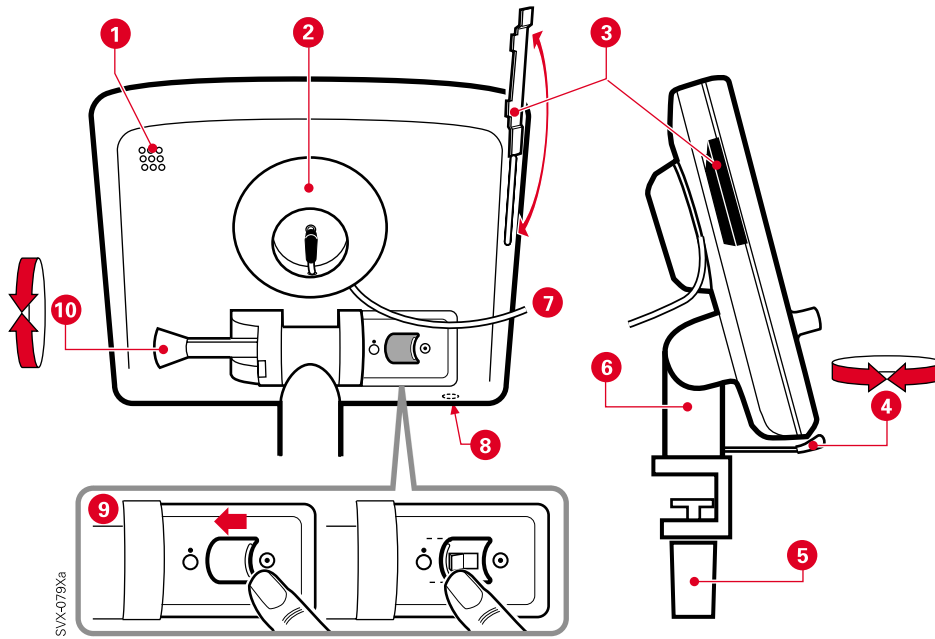

User Interface

The User Interface can be mounted onto the Mobile cart but can also easily be removed from the cart and mounted on the bed post or table/shelf. The User Interface can be rotated and tilted into a suitable position. Locking levers, mounting devices and some other items are shown in the illustration above.

1. Loudspeaker
2. Cable reel
3. PC Card slot with slot cover
4. Locking arm, rotation
5. Locking screw, alternative mounting
6. Panel holder
7. Control cable
8. Connection for PC, service port
9. On/Off switch
10. Locking arm, tilting.

For further information regarding the User Interface controls, refer to the User's manual.

When the front panel section is removed from the rear cover, the following parts are accessible:

- Touch screen assembly, front cover frame included.
- TFT Display including lamps.
- PC board Backlight inverter.
- PC 1777 Panel including PC Card slot.
- Loudspeaker.
- Main rotary dial (rotary encoder with switch).
- Direct access controls (rotary encoder).

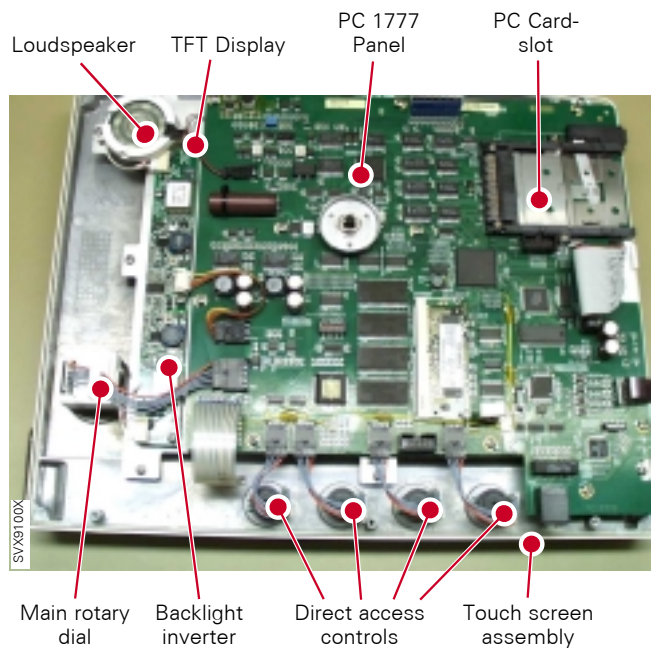

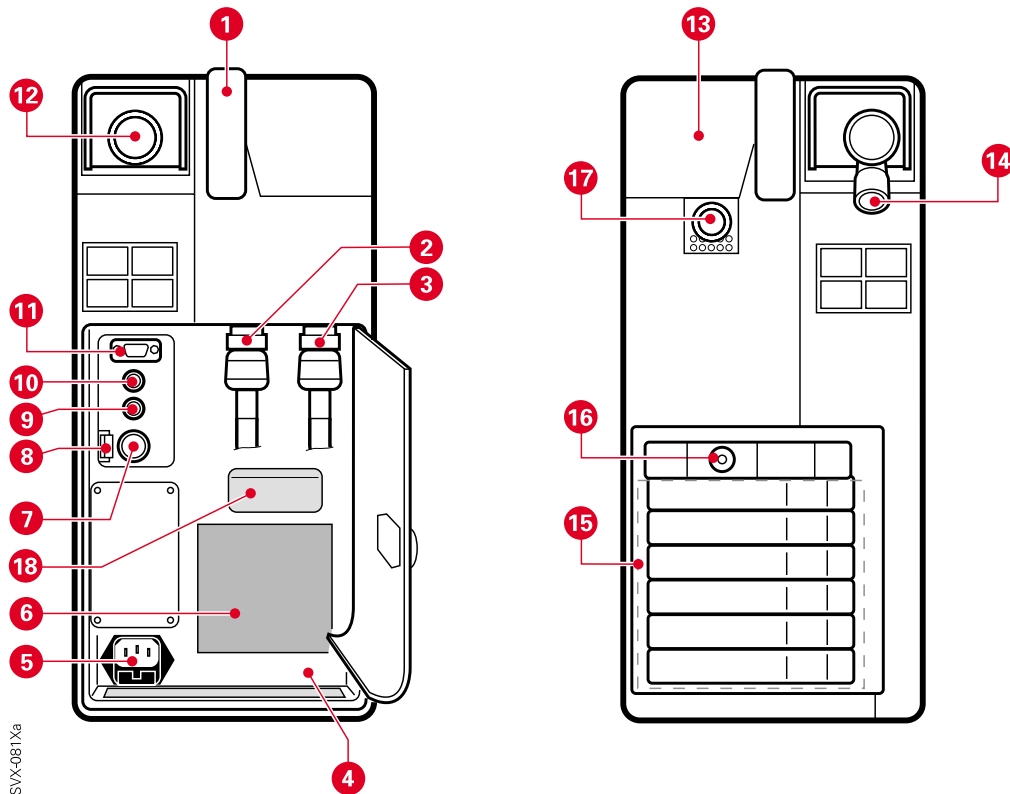

Patient Unit

The Patient Unit can be rotated on and pulled out of the Servoⁱ Mobile cart. It can also be removed from the Mobile cart and mounted onto a Servoⁱ Holder.

Items accessible from the outside of the Patient Unit are shown in the illustration above.

1. Handle.
2. Gas inlet for Air.
3. Gas inlet for O₂.
4. Equipotentiality terminal.
5. Mains supply connector incl. fuses F11 and F12.
6. Internal fan with filter.
7. Connector for external +12V DC power supply.
8. Fuse F1 for external +12V DC power supply.
9. Optional connector.
10. Connection to the User Interface control cable.
11. 9-pole serial port for data communication (RS 232).
12. Expiratory outlet.
13. Inspiratory section cover.
14. Expiratory inlet.
15. Module unit for connecting optional modules, e. g. up to six Battery modules, Servoⁱ.
16. Connector for Servo Ultra Nebulizer Servoⁱ.
17. Inspiratory outlet.
18. Serial number label. The serial number stated on this label is the ID number of the unit. This serial number must always be referred to when ordering service, spare parts, software updates/upgrades, etc.

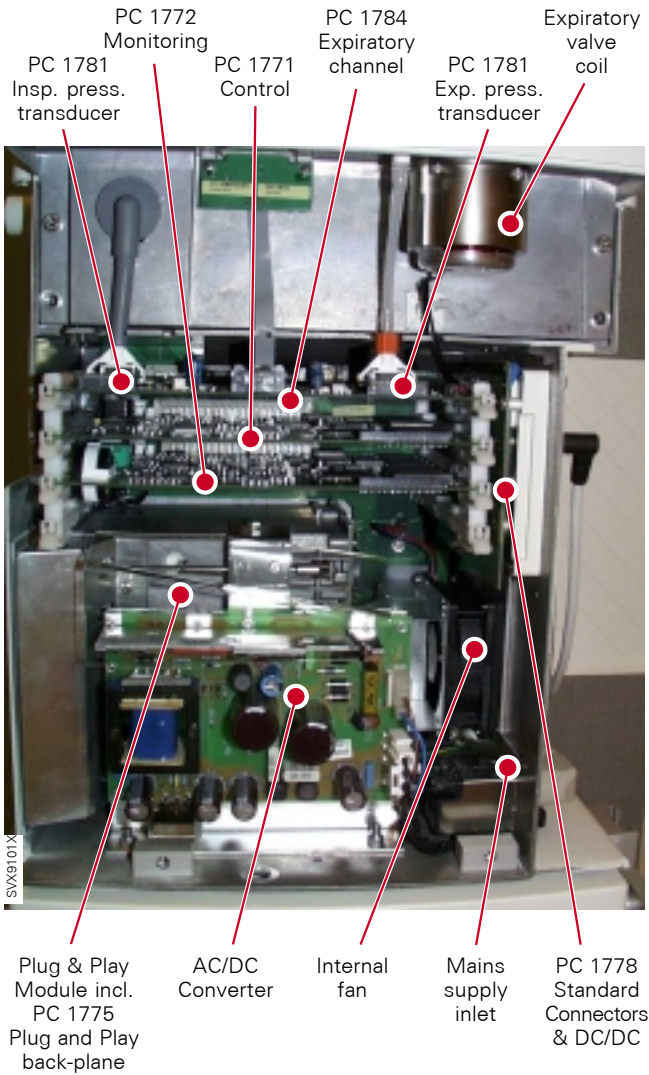

When the Patient Unit front cover is removed, the following parts are accessible:

- PC 1772 Monitoring.
- PC 1771 Control.
- PC 1784 Expiratory channel with the two connected PC 1781 Inspiratory and Expiratory Pressure Transducers.
- Expiratory valve coil.
- Plug-and-Play Module incl. PC 1775 Plug-and-Play back-plane.
- AC/DC Converter.
- Internal fan.
- Mains supply inlet.
- PC 1778 Standard connectors & DC/DC.

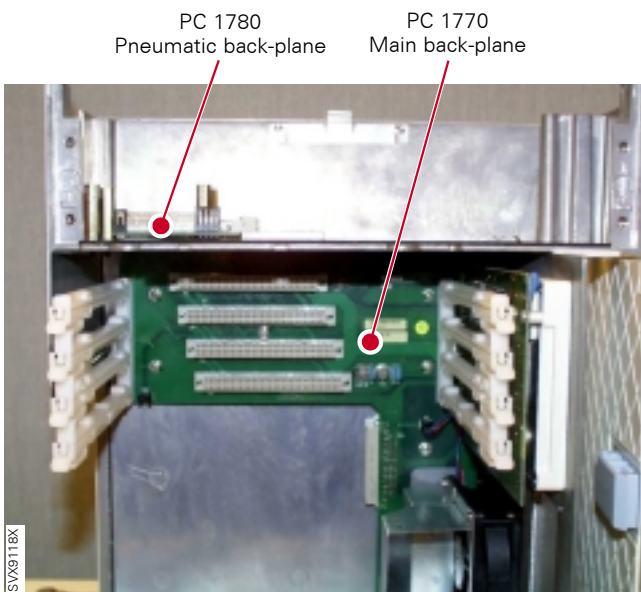

- The PC boards, as listed above, are connected to the PC 1770 Main back-plane.
- The gas modules, the O₂ cell and the safety valve pull magnet are connected to the PC 1780 Pneumatic back-plane.

2

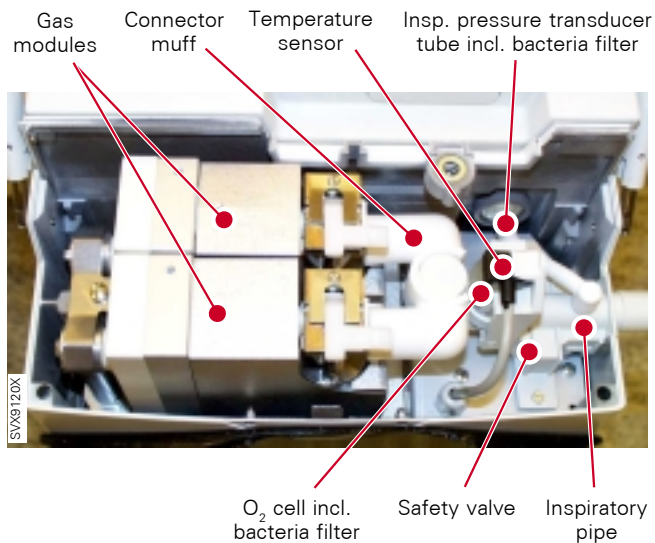

The upper part of the Patient Unit contains the inspiratory section and the expiratory section.

The main parts of the inspiratory section are the:

- Two gas modules, Air and O₂, for regulation of the inspiratory gas.
- Connector muff.
- Inspiratory pipe with housings for the O₂ cell and for the safety valve.
- O₂ cell incl. bacteria filter.
- Temperature sensor.
- Inspiratory pressure transducer tube incl. bacteria filter, to connect the inspiratory pressure transducer.

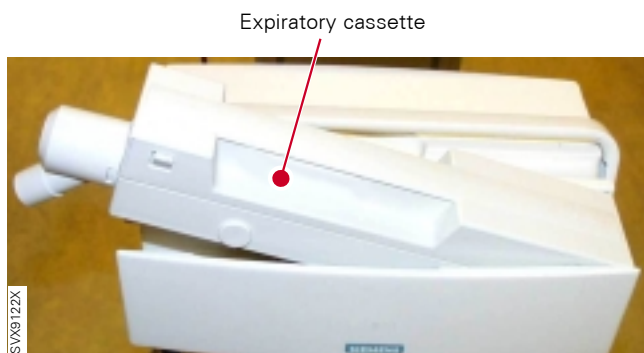

The main parts of the expiratory section are the:

- Expiratory cassette.
- Expiratory valve coil.

The expiratory cassette is a complete unit and must not be disassembled. It contains the following parts:

- Expiratory inlet with moisture trap.
- Ultrasonic flowmeter.
- Heating foil to keep a stable temperature in the expiratory gas.
- Pressure transducer connection, incl. bacteria filter, to connect the expiratory pressure transducer.
- Expiratory valve incl. valve membrane.
- Expiratory one-way valve.

The expiratory valve coil, mounted under the expiratory cassette compartment, controls the valve membrane in the cassette.

Servoⁱ software structure

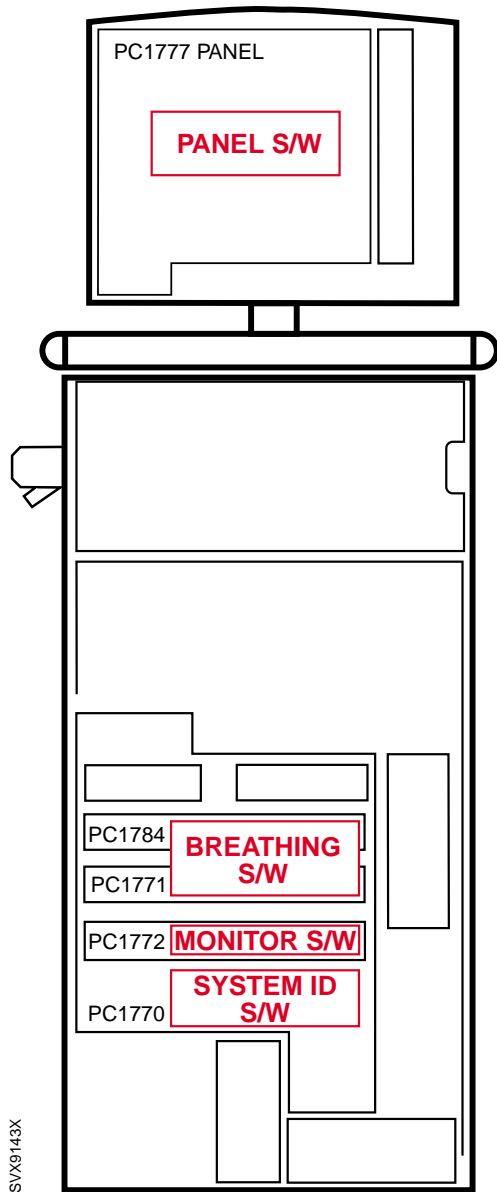

General

The Servoⁱ software installed in the ventilator will contain all available system functionality. The software is separated into different subsystems and stored on some of the PC boards. The separation of the software is handled by the installation program.

The Servoⁱ software is divided into the following software subsystems:

- Breathing
- Monitor
- Panel
- System ID

Breathing

The Breathing S/W controls the delivery of gases to the patient. This subsystem is responsible for the breathing system, that is:

- Ventilation control and regulation
- Inspiratory channel
- Expiratory channel
- Nebulizer control (software option)

The Breathing S/W is stored on PC 1771 CONTROL and PC 1784 EXPIRATORY CHANNEL. New software can be installed via a System software update. The system software must be re-installed if PC 1771 or PC 1784 is replaced.

The Breathing S/W is executed by microprocessors on PC 1771 and PC 1784.

Monitor

The Monitor S/W controls all monitoring and alarm functions in the system, including trends of measured values. Events, such as alarms and change of settings will also be logged.

The Monitor S/W is stored on PC 1772 MONITORING. New software can be installed via a System software update. The system software must be re-installed if PC 1772 is replaced.

The Monitor S/W is executed by the microprocessor on PC 1772.

Panel

The Panel S/W controls all user interaction, as well as software updating to all subsystems via the PC Card-interface.

The Panel S/W is stored on PC 1777 PANEL. New software can be installed via a System software update. The system software must be re-installed if PC 1777 is replaced.

The Panel S/W is executed by the microprocessor on PC 1777.

System ID

A configuration file, the System ID S/W that is unique for each ventilator, will enable the functions selected for this ventilator. The System ID S/W will be upgraded if the configuration of the ventilator is changed.

The System ID S/W is stored on PC 1770 MAIN BACK-PLANE. New System ID S/W can be installed via an Option upgrade.

3. Description of functions

About this chapter 3 - 2

Memory types used in the Servoⁱ 3 - 2

User Interface 3 - 2

 User Interface controls 3 - 2

 PC 1777 Panel 3 - 2

 Loudspeaker 3 - 2

 Backlight Inverter 3 - 2

 Front panel screen 3 - 2

Patient unit 3 - 3

 Inspiratory section 3 - 3

 Expiratory section 3 - 6

 PC 1770 Main back-plane 3 - 7

 Pressure transducers 3 - 7

 PC 1784 Expiratory Channel 3 - 8

 PC 1771 Control 3 - 8

 PC 1772 Monitoring 3 - 8

 Power supply 3 - 9

 Module unit 3 - 9

 Internal fan 3 - 9

 Optional PC board slots 3 - 10

Control cable 3 - 10



Only personnel trained and authorized by Siemens shall be permitted to perform installation, service or maintenance of the Servoⁱ System. 

Make sure that the Servoⁱ System is properly cleaned before performing any service or maintenance; routine cleaning as well as extended cleaning. For cleaning procedures, refer to the "Servoⁱ Ventilator System – User's manual".

Any service or maintenance must be noted in a log book.

All disposable parts must be discarded according to local regulations and in an environmentally acceptable way.

After any service or maintenance of the Servoⁱ System, perform a "Pre-use check". Refer to the "Servoⁱ Ventilator System – User's Manual" for details.

About this chapter

This text refers to the Functional Main Blocks diagram in chapter "Diagrams". Text written in SMALL CAPS refers to block names in the Main Blocks diagram.

Memory types used in the Servoⁱ

There are four different types of memories used in the Servoⁱ:

- Flash memory. For software storage. Can be upgraded / updated via Option card or S/W version update card. Present on PC 1771, PC 1772, PC 1777 and PC 1784.
- RAM. For temporary storage of software and data. Present on PC 1772 and PC 1777.
- Non-volatile memory. RAM with battery back-up. For settings, trends and logs. Present on PC 1771 and PC 1772.
- EEPROM. For PC board information, configuration, calibration data, etc. Present on almost all PC boards and in the O₂ cell.

User Interface

Functional Main Blocks diagram marking: "U"

User Interface controls

Setting of different parameter input values is made with the help of the following different interface devices:

- Main Rotary Dial (rotary encoder with switch).
- Direct Access Control, 4 each (rotary encoders).
- Membrane buttons. Integrated parts of the Touch screen assembly.
- Touch screen.

PC 1777 Panel

Some features included on PC 1777 PANEL are:

- SIMM (Single In-line Memory Module) mounted on its connector P77. Memory type: SDRAM
- PC CARD SLOT intended for connection/insert of a PC Card. PC Cards are used to:
 - Download software into the different flash memories situated on PC-boards marked **μP** and into the EEPROM on PC 1770 MAIN BACK-PLANE.
 - Transfer patient and system data for further transfer to a computer.
 - Service purpose.

- Microprocessor on this board includes control of the functions of the USER INTERFACE.
- ID-PROM: The ID information can be read by the Servoⁱ System.
- On/Off switch: Switch to Power up or Power down the Servoⁱ System. Refer to section "Power supply".
- Connection for PC (P86): Ethernet port intended for test and service purpose. Connected via a service cable. For future options.
- Microphone used to monitor of sounds from the Loudspeaker.

Loudspeaker

For generation of sound, e.g. alarm. Connected to P72 on PC 1777 PANEL.

The loudspeaker generates different tones with overtones, at different sound volume. The loudspeaker is continuously supervised by the microphone on PC 1777 PANEL.

Backlight Inverter

PC board with driving stage for backlight (lamps) mounted behind the TFT Display. The supply voltage delivered by the Backlight Inverter is 660 V.

The Backlight Inverter is connected to P73 on PC 1777 PANEL.

Front panel screen

The front panel screen comprises:

- Touch screen assembly
- TFT Display
- Backlight.

The Touch screen implies the touch function of the front panel screen and is interactive with information displayed on the TFT Display. The front panel frame with the touch screen, membrane buttons and DIM sensor forms the Touch screen assembly and must be handled as one complete part. The DIM sensor measures the ambient light and the screen brightness is automatically adjusted.

The TFT Display is a Thin Film Transistor Screen for color display of picture- and alphanumeric data.

The Backlight consists of two fluorescent tubes (lamps) mounted behind the TFT Screen. They are driven from the BACKLIGHT INVERTER. Estimated lifetime (with acceptable brightness level) for the lamps is 30.000 hours.

Patient unit

Inspiratory section

Functional Main Blocks diagram marking: "I"

The main block INSPIRATORY SECTION conveys the breathing gas from its gas inlets for Air and O₂ supply to the patient breathing system. It comprises the following main functions:

- GAS MODULES – AIR AND O₂.
- CONNECTOR MUFF.
- INSPIRATORY PIPE.
- O₂ CELL.
- TEMPERATURE SENSOR.
- INSPIRATORY PRESSURE TUBE.
- SAFETY VALVE.
- INSPIRATORY OUTLET.
- PC 1780 PNEUMATIC BACK-PLANE.

Gas modules – Air and O₂

The Air and O₂ GAS MODULES regulates the inspiratory gas flow and gas mixture.

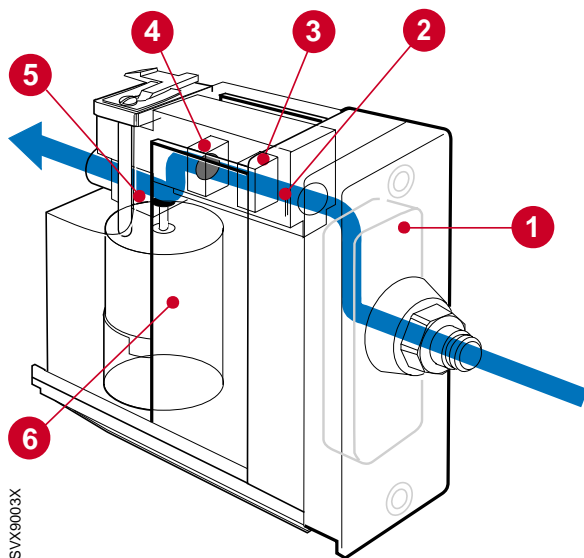

1. Filter
2. Inspiratory valve temperature sensor
3. Supply pressure transducer
4. Flow transducer (Delta pressure transducer and net)
5. Nozzle unit with valve diaphragm
6. Inspiratory solenoid

The GAS MODULES are factory calibrated. Each GAS MODULE must not be disassembled further than described in chapter "Preventive maintenance".

Gas inlet

The gas inlet nipples are quick-couplings where gas supply is connected to the ventilator. The design of the inlet nipples and their color markings vary according to the standard chosen.

Gas is to be connected from hospital central gas supply or from gas cylinders. The Air supply may be connected from a compressor for medical air.

Filter

The FILTER protects the ventilator from particles in the gas delivered to the GAS MODULES. The filter must be replaced during the "Preventive maintenance".

The filter housing and the filter cover are provided with matching guide pins. These guide pins prevent mounting of the filter cover (with gas inlet nipple) on the wrong module.

A non-return valve for the gas inlet is located in the filter cover. This valve will suppress short pressure drops in the gas supply.

The non-return valve is also designed to slowly evacuate compressed gas from the module, if the gas supply to the module is disconnected.

Inspiratory valve temperature sensor

The temperature of the supplied gas is measured by the INSPIRATORY VALVE TEMPERATURE SENSOR. This sensor is situated in the gas flow.

The output signal from this sensor is used to compensate for the gas density variations due to temperature.

Supply pressure transducer

The pressure of the supplied gas is measured by the SUPPLY PRESSURE TRANSDUCER.

The output signal from this transducer is amplified. It is then used to calculate the absolute pressure of the gas to compensate for gas density variations due to pressure.

Flow transducer

The gas flows through a net (resistance) which causes a pressure drop. The pressure is measured on both sides of this net and the differential pressure value is then amplified.

Nozzle unit

The plastic NOZZLE UNIT contains a valve diaphragm. The valve diaphragm, controlled by the INSPIRATORY SOLENOID, regulates the gas flow through the GAS MODULE.

The complete plastic nozzle unit must be replaced during the "Preventive maintenance".

After replacement, allow the diaphragm to settle during approx. 10 minutes before gas pressure is connected to the GAS MODULE.

Inspiratory solenoid

The gas flow through the GAS MODULE is regulated by the INSPIRATORY SOLENOID via the NOZZLE UNIT.

The current supplied to the solenoid is regulated so that the gas module will deliver a gas flow according to the settings on the User Interface.

Gas module key

The GAS MODULES are provided with a mechanical key to prevent that the module is mounted in the wrong slot.

The key consists of a plastic guide mounted underneath the module and a corresponding guide mounted in the patient unit.

Connector muff

The CONNECTOR MUFF connects the GAS MODULE outlets to the INSPIRATORY PIPE inlet.

Inspiratory pipe

The INSPIRATORY PIPE leads the gas from the CONNECTOR MUFF to the INSPIRATORY OUTLET.

The INSPIRATORY PIPE comprises:

- Housing and locking lever for the O₂ CELL with its bacteria filter.
- Housing for the SAFETY VALVE.
- Connection for measurement of inspiratory pressure.

The pipe is provided with internal flanges with the purpose to improve mixing of O₂ and Air.

O₂ cell

The O₂ CELL is mounted in a housing on the INSPIRATORY PIPE and is protected by a bacteria filter.

Maintenance including exchange of bacteria filter according to the User's manual. The bacteria filter must also be replaced during the "Preventive maintenance".

The O₂ cell gives an output voltage proportional to the partial pressure of oxygen inside the Inspiratory pipe. At constant ambient pressure this output is proportional to the O₂ concentration in percent. In each O₂ cell, the output signal will stay at a fairly constant level usually within 10–17 mV in normal air and at standard barometric pressure during the life time of the cell. The cell should be replaced when the output level has started to decrease. In this situation, repeated calibration (i. e. Pre-use check) of the O₂ concentration is required. The life time of the cell is affected by the O₂ concentration. With a concentration (at the cell) in % and expected cell life time in hours the following applies at 25°C (77°F):

$$\text{O}_2 \text{ Conc.} \times \text{Expected cell life} = 500\,000\% \text{ hours.}$$

The O₂ cell is automatically calibrated each time a Pre-use check is performed (if O₂ is connected to the ventilator).

An ID PROM is integrated into each O₂ cell. Its ID information and remaining lifetime can be read by the Servoⁱ System.

Temperature sensor

A TEMPERATURE SENSOR is integrated into the connector on top of the O₂ CELL. This sensor measures the temperature inside the INSPIRATORY SECTION.

The output signal, corresponding to the temperature in the INSPIRATORY SECTION, is used for regulation of the INTERNAL FAN.

Inspiratory pressure tube

The INSPIRATORY PRESSURE TUBE connects the INSPIRATORY PIPE with the INSPIRATORY PRESSURE TRANSDUCER.

A bacteria filter protects the pressure transducer on PC 1781 PRESSURE TRANSDUCER from contamination.

Maintenance including exchange of bacteria filter according to User's manual. The bacteria filter must also be replaced during the "Preventive maintenance".

Safety valve

The movable axis of the SAFETY VALVE PULL MAGNET controls the opening and closing of the safety valve membrane in the INSPIRATORY PIPE. The pull magnet is electrically activated (closed) from the main block EXPIRATORY CHANNEL.

When the SAFETY VALVE is not activated, the weight of the pull magnet axis, in combination with the design of the valve membrane, pushes the pull magnet axis downwards. This actuates the SAFETY VALVE to be opened and the inspiratory gas is let out from the INSPIRATORY PIPE via the SAFETY OUTLET thus enabling a decrease in the inspiratory pressure. The SAFETY OUTLET is covered by a plastic grid. This is normal safety (pop-off) function.

The opening conditions for the safety valve are:

- The ventilator is switched Off or Standby.
- The pressure inside the inspiratory pipe is 5 cm H₂O above the preset Upper Pressure Alarm limit. This condition is controlled by the Monitor subsystem.
- The pressure inside the inspiratory pipe is 7 cm H₂O above the preset Upper Pressure Alarm limit. This condition is controlled by the Breathing subsystem.
- The pressure inside the inspiratory pipe is above 117 cm H₂O. This is an extra safety function and this situation will normally not occur.
- The safety valve will also be opened by some other alarms, e. g. the Out of gas-alarm.

During startup, the pull magnet is electrically activated so that the pull magnet axis is pushed up (with a clicking sound). This is the normal operational position of the pull magnet; the SAFETY VALVE is normally kept closed.

Inspiratory outlet

22 mm / 15 mm tube connector for the inspiratory tube of the patient breathing system.

PC 1780 Pneumatic back-plane

Interconnecting board including connectors for cables to the GAS MODULES as well as to the SAFETY VALVE and to the O₂ CELL and the TEMPERATURE SENSOR.

Expiratory section

Functional Main Blocks diagram marking: "E"

The main block EXPIRATORY SECTION conveys the breathing gas from the patient breathing system to the EXPIRATORY OUTLET. It comprises:

- Measurement of expiratory flow
- Connection for measurement of expiratory pressure.
- Controlling element for the regulation of expiratory pressure.

3

Expiratory cassette

The expiratory gas conveying parts and PC 1786 EXPIRATORY CHANNEL CASSETTE are integrated into one part – the EXPIRATORY CASSETTE – which can be easily removed for cleaning or exchange. See Servoⁱ Ventilator System – User's manual.

The expiratory cassette can be interchanged between different Servoⁱ systems. Always perform a Pre-use check after exchanging the expiratory cassette.

An ID PROM is integrated into each expiratory cassette. Its ID information and remaining lifetime can be read by the Servoⁱ System.

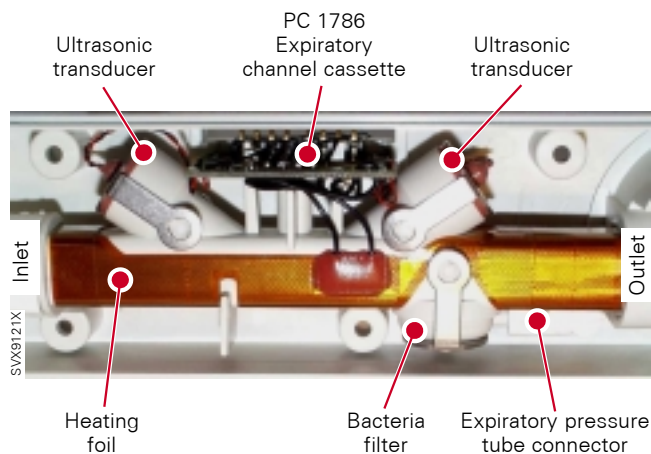

Expiratory inlet

22 mm / 10 mm tube connector for the expiratory tube of the patient breathing system. The inlet is designed to make condensed water drip out and allow use of a water trap for such water to be collected. Expiratory inlet bacteria filter can be connected to protect the cassette from contamination.

Heating foil

An electrical HEATING FOIL applied on the outside of the expiratory pipe where the ULTRASONIC FLOWMETER is situated. The purpose of the HEATING FOIL to reduce condensation and maintain a stable temperature in the expiratory gas.

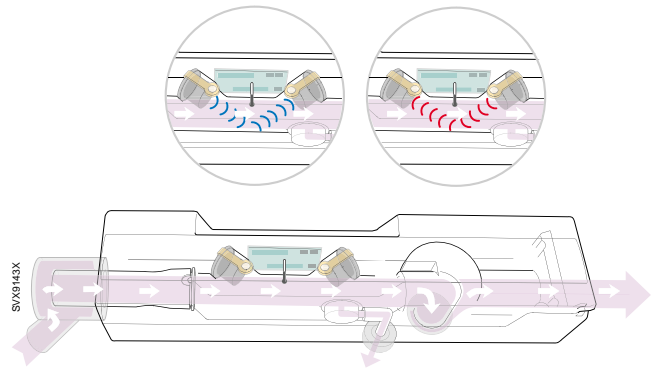

Ultrasonic flowmeter

The ULTRASONIC FLOWMETER is a measuring device for the expiratory gas flow, using ultrasound technique with two ultrasonic transducers/receivers.

The measuring process is controlled from the main block PC 1784 EXPIRATORY CHANNEL.

The left hand side transducer is sending out ultrasonic sound that is reflected against the inner wall of the expiratory channel. The ultrasonic sound is received by the right hand side transducer now acting as a receiver. The time from sending to receiving ultrasonic sound in downstream expiratory gas flow is measured.

Then the right hand side transducer (earlier receiving) is sending out ultrasonic sound upstream the expiratory gas flow. The ultrasonic sound is received by the left hand side transducer now acting as a receiver. The time from sending to receiving ultrasonic sound in upstream expiratory gas flow is measured.

The time difference between the downstream and the upstream time measurements provides flow information.

A temperature sensor inside the cassette measures the expiratory gas temperature. This temperature measurement is also used when calculating the expiratory flow.

Bacteria filter and expiratory pressure tube

Via a BACTERIA FILTER inside the cassette, the EXPIRATORY PRESSURE TUBE connects the cassette to the EXPIRATORY PRESSURE TRANSDUCER. The filter and the connector are integrated parts of the cassette. The filter protects the transducer on PC 1781 PRESSURE TRANSDUCER from contamination.

Expiratory valve

The EXPIRATORY VALVE consists of a membrane in the cassette that is operated by the axis of the EXPIRATORY VALVE COIL. The valve is fully open as long as no power is supplied to the coil.

During normal conditions, the membrane will not need replacement during the lifetime of the expiratory cassette. However, if the membrane for some reason has become defective, it can be replaced. Refer to instructions in chapter "Service procedures".

Before replacing the membrane, check the remaining operating time for the expiratory cassette. If less than 10–15% operating time remains, it is recommended to replace the complete expiratory cassette.

Expiratory valve coil

The movable axis of the EXPIRATORY VALVE COIL controls the opening of the EXPIRATORY VALVE by pushing the valve membrane into desired position. The power supply to the coil is regulated so that the remaining pressure in the patient system, towards the end of the expiration time, is kept on the PEEP level according to front panel setting.

Expiratory outlet with expiratory one-way valve

The gas from the patient system leaves the ventilator via this EXPIRATORY OUTLET. Backflow via the cassette is prevented by the EXPIRATORY ONE-WAY VALVE. Its rubber membrane and valve seat are integrated parts of the EXPIRATORY OUTLET.

PC 1786 Expiratory channel cassette

The PC 1786 EXPIRATORY CHANNEL CASSETTE is a connection board, integrated into the EXPIRATORY CASSETTE, for the ULTRASONIC FLOWMETER and for the HEATING FOIL. It connects to PC 1785 mounted in the expiratory cassette compartment.

Includes also an ID PROM. The ID information can be read by the Servoⁱ System.

PC 1785 Expiratory channel connector

The PC 1785 EXPIRATORY CHANNEL CONNECTOR is a connector board including signal filters that is mounted in the expiratory cassette compartment. It connects to PC 1786 mounted in the EXPIRATORY CASSETTE when the cassette is docked to the expiratory cassette compartment.

PC 1770 Main back-plane

Interconnection board for the PC boards in the lower part of the patient unit.

The ventilators ID (Serial No.), configuration, time stamp for preventive maintenance, etc, is stored in an EEPROM on PC 1770. Thus, PC 1770 can only be replaced by a factory preset PC board.

As the preventive maintenance time stamp will be reset when replacing PC 1770, a new time stamp must be set via the Biomed menu. In order to make this new time stamp correct, the preventive maintenance must be performed. Refer to chapter "Preventive maintenance".

Pressure transducers

Functional Main Blocks diagram marking: "T"

PC 1781 Inspiratory pressure transducer

The pressure, conveyed via the pressure tube connected to this block, is led to and measured by its differential pressure transducer. With differential reference to the ambient pressure, the output signal is proportional to the measured pressure thus giving a linear measurement in the range -40 cm H₂O to +160 cm H₂O.

Technical limitation: Pressure exceeding 200 cm H₂O must be avoided.

PC 1781 Expiratory pressure transducer

Function identical to PC 1781 INSPIRATORY PRESSURE TRANSDUCER.

PC 1784 Expiratory Channel

Functional Main Blocks diagram marking: "F"

The main block EXPIRATORY CHANNEL comprises microprocessor control to achieve measurement of expiratory flow. The output signal EXP. FLOW is used in the main block CONTROL.

Electronics including microprocessor (μ P) for handling of:

- All electronic connections to and from the EXPIRATORY SECTION functions.
- Measurement of airway pressures in both INSPIRATORY SECTION and EXPIRATORY SECTION.
- Control of the SAFETY VALVE functions in the INSPIRATORY SECTION.

Includes also an ID PROM. The ID information can be read by the Servoⁱ System.

PC 1771 Control

Functional Main Blocks diagram marking: "C"

The main block CONTROL comprises microprocessor control of Breathing pattern for all different ventilation modes.

Electronics including microprocessor (μ P) control to achieve:

1. Regulation of Inspiratory flow which is used during inspiration time in Volume Control (VC) mode.
2. Regulation of Inspiratory pressure which can be used during inspiration time in any mode.
3. Regulation of a constant Inspiratory flow which is used during expiration time in all modes.
4. Respiratory timing pattern including frequency as well as distribution of the duration for Inspiration time, Pause time and Expiration time according to front panel settings.
5. Regulation of Inspiratory flow during inspiration time. The desired total Inspiratory flow value according to front panel settings is used to generate the flow reference signals INSP FLOW REF 1 and INSP FLOW REF 2. The level relation between these two flow reference signals depends on the desired O₂ concentration according to front panel setting. INSP FLOW REF 1 and INSP FLOW REF 2 are used for the control of its respective GAS MODULE (Air and O₂).

Regulation of a constant Inspiratory flow during expiration time: The desired constant Inspiratory flow value is the default or preset Bias flow value (see User's manual).

This desired constant Inspiratory flow value is used to generate the flow reference signals INSP FLOW REF 1 and INSP FLOW REF 2 with the same relation and same handling as described above under "Regulation of Inspiratory flow..." except this occurs during expiration time.

Includes also an ID PROM. The ID information can be read by the Servoⁱ System.

PC 1772 Monitoring

Functional Main Blocks diagram marking: "M"

The main block MONITORING comprises microprocessor calculation of parameters and monitoring of alarm limits with control of alarms (as well as back-up alarm). The main block MONITORING cooperates with the LOUDSPEAKER in the User Interface.

The PC 1772 MONITORING handles all supervision and alarms in the system. It activates pressure reducing mechanisms, including activation of the safety valve, in case of excessive breathing system pressure.

All alarms are conveyed and displayed on the front panel and the alarm sound is also generated. In case of malfunction in the loudspeaker, located in the User Interface, a back-up sound generating device on PC 1772 will be activated automatically.

The following voltages are supervised :

- +24 V
- +12 V
- -12 V
- +5 V
- +3.3 V.

A buzzer on PC 1772 MONITORING generates the alarm signal in case of +5 V or +3.3 V power failure. The buzzer and +5 V / +3.3 V failure logic is powered by back-up capacitors in case of power failure.

PC 1772 also contains a barometric transducer and the measured barometric pressure is supplied to the other units in the system.

Trending of measured parameters are performed by MONITORING.

Power supply

Functional Main Blocks diagram marking: "P"

The main block POWER SUPPLY comprises conversion of mains power to internal power supply as well as the Module unit-connections for optional Battery modules and/or other optional modules.

The power modes in the Servoⁱ System are:

- At Power up, i. e. when the On/Off switch is turned On, all internal voltages will be enabled.
- At Power down, the Power supply system will deactivate the hardware signal POWER_GOOD.H, and at the same time keep the internal voltages +5 V and +3.3 V for at least 1 ms, in order to let the different subsystems save their current settings in non-volatile memory. Power down can be caused by:
 - Turning the On/Off switch Off.
 - Mains failure and no back-up battery connected.
 - The system is powered from a battery, but the battery voltage is too low for proper operation of the system.

In this Off mode, only charging of Battery modules is enabled (if the system is connected to mains). All other circuitry is un-powered.

- In Standby all circuitry is powered from the Power supply, but no breathing will be active. The operator can set all parameters, including breathing mode, during Standby.

Mains inlet

Appliance inlet for mains power supply including grounding connection.

The Servoⁱ System will automatically adjust to the connected mains power if the mains power is within specified range. No voltage or frequency setting is required.

The mains inlet is equipped with two mains power fuses, F11 and F12, rated 2.5 A.

AC/DC Converter

Converts the connected AC Power to the internal DC supply voltage +12 V_UNREG.

PC 1778 Standard connectors & DC/DC

Converts the internal DC supply voltage +12 V_UNREG into the following internal DC supply voltages:

- +3.3 V
- +5 V
- ±12 V
- +24 V

All standard connectors are located on this board. The connectors are the following:

- N26 – External +12 V DC supply input. The connectors is equipped with a fuse F1, rated 10 A.
- N27 – Optional equipment.
- N28 – Control cable.
- N29 – RS232.

Pin configuration and signal names can be found in chapter "Diagrams".

Includes also an ID PROM. The ID information can be read by the Servoⁱ System.

PC 1775 Plug-and-play back-plane

Connects the Optional Modules that are inserted in the Module Unit. Controls charging of the Battery modules.

Includes also an ID PROM. The ID information can be read by the Servoⁱ System.

Module unit

Connection slots for 6 optional modules, e. g. Battery modules.

Internal fan

The INTERNAL FAN forces cooling air through the patient unit. The air inlet is protected by a filter that must be cleaned or replaced during the "Preventive maintenance". The cooling air outlets are located in the expiratory section.

The INTERNAL FAN is controlled by the TEMPERATURE SENSOR in the INSPIRATORY SECTION. The fan will start with half effect at approx. 33 °C and with full effect at approx. 43 °C.

Optional PC board slots

Functional Main Blocks diagram marking: "X"

For future options, the Servo² System is equipped with two optional PC-board slots.

Control cable

This CONTROL CABLE connects the PATIENT UNIT and the USER INTERFACE. The cable can be partly winded up under a rubber cover on the rear of the USER INTERFACE.

4. Disassembling and assembling

| | |
|-----------------------------|-------|
| General | 4 - 2 |
| Preparations | 4 - 2 |
| Handling PC boards | 4 - 2 |
| Replacing PC boards | 4 - 2 |
| Assembling guidelines | 4 - 2 |
| User Interface | 4 - 3 |
| Patient Unit | 4 - 4 |

Only personnel trained and authorized by Siemens shall be permitted to perform installation, service or maintenance of the Servoⁱ System.



Make sure that the Servoⁱ System is properly cleaned before performing any service or maintenance; routine cleaning as well as extended cleaning. For cleaning procedures, refer to the "Servoⁱ Ventilator System – User's manual".

Any service or maintenance must be noted in a log book.

All disposable parts must be discarded according to local regulations and in an environmentally acceptable way.

After any service or maintenance of the Servoⁱ System, perform a "Pre-use check". Refer to the "Servoⁱ Ventilator System – User's Manual" for details.

General

Disassembling of the main units in the Servoⁱ System is described in this chapter. If not stated otherwise, the assembling procedure is the reverse of the described disassembling procedure.

The illustrations in the Servoⁱ Spare Parts List are very useful as a guide when disassembling and assembling the Servoⁱ System.

Preparations

Before disassembling or assembling the Servoⁱ System:

- Set the On / Off switch on the control unit to **Off**.
- Disconnect the mains power cable.
- Disconnect the gas supplies (wall and/or tank).
- Disconnect Battery modules.
- Make sure that all gas conveying parts are cleaned according to instructions in the "Servoⁱ – User's manual".

After any service intervention in the Servoⁱ System, perform a "Pre-use check" according to instructions in the "Servoⁱ Ventilator System – User's manual".

Handling PC boards

The PC boards contain components that are highly sensitive to static electricity.

Those who come into contact with circuit boards containing sensitive components must take certain precautions to avoid damaging the components (ESD protection).

When working with ESD sensitive components, always use a grounded wrist band and grounded work surface. Adequate service tools must also be used.

PC boards (spare parts) must always be kept in protective packaging for sensitive electronic device.

PC boards must not be inserted or removed while the mains power or battery power is applied to the PC boards.

Remove and insert the PC boards very carefully to avoid damage to the connectors.



Replacing PC boards

The Servoⁱ system software is distributed on different subsystems, located on the following PC boards:

- PC 1771 Control
- PC 1772 Monitoring
- PC 1771 Expiratory Channel
- PC 1777 Panel.

When delivered as spare parts, these PC boards are equipped with the latest version of the system software.

However, if during a service intervention, any of the above PC boards need to be replaced, it is recommended that the system software version used prior to the PC board replacement is kept. Thus, a "S/W version update card" with the applicable system software version must be available for re-installation purposes.

Assembling guidelines

The Servoⁱ System specifications allow unit operation also during patient transportation. All parts of the User Interface and the Patient Unit assembled with screws and nuts are therefore tightened with a specified torque and secured with threadlocking adhesives.

In order to maintain these specifications over time, it must be ensured that after any service intervention removed parts are re-assembled and secured according to instructions. Make sure to follow the guidelines stated below.

Tightening torque

- Thread size M3: 0.95 ±0.05 Nm
- Thread size M4–M6: 3.1 ±0.1 Nm.

Threadlocking adhesives

- Electrolube Bloc'Lube BLV15ML[®] on threads in contact with PC boards.
- Loctite 243[®] on all other threads.

Note: Threadlocking adhesive is not required on Heli-Coil[®] screw thread inserts as these screw thread inserts have a self-locking function.

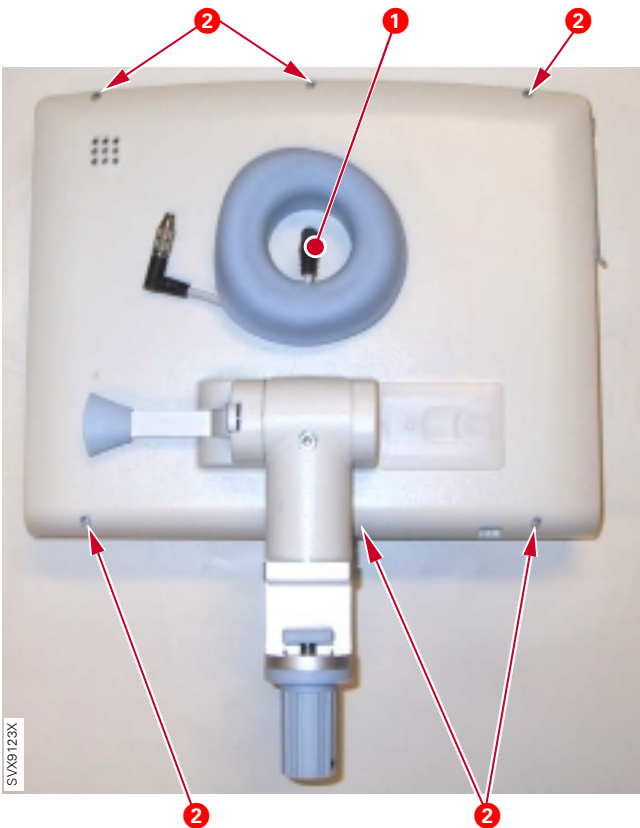

User Interface

To separate the front panel section from the rear cover:

- Disconnect the control cable (1).
- Remove the screws (2).
- Lift off the rear cover from the front panel section.

- All parts inside the front panel section are now accessible.

Note

When replacing PC 1777 Panel, it can be necessary to re-install the system software. For further information refer to section "Replacing PC boards" in this chapter.

With power supply connected to the Servoⁱ System, there are energized electrical components inside the unit, e. g. the backlight lamps that are supplied with 660 V by the Backlight Inverter. All personnel must exercise extreme caution if fault tracing or adjustments are performed with power supply connected and with the user interface rear cover removed.

Patient Unit

To remove the patient unit front cover (1):

- Remove the screw covers and the screws (2).

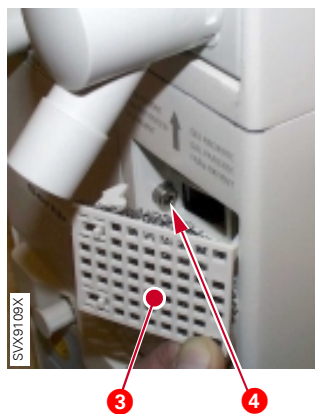
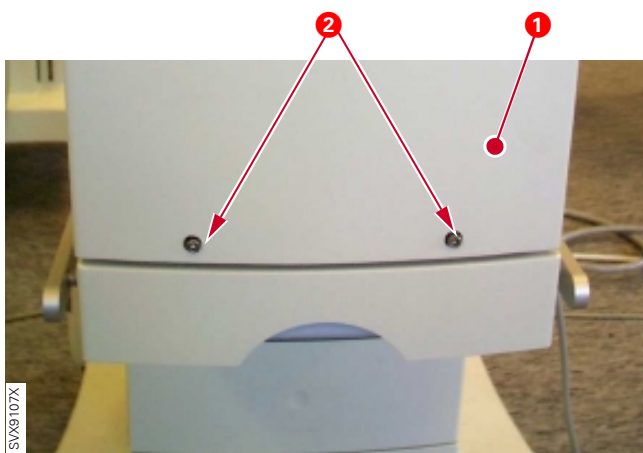

- Remove the two ventilation covers (3).
- Remove the two screws (4).

4



- Carefully lift off the patient unit front cover (1).



- All parts behind the patient unit front cover are now accessible.

Note

When replacing PC 1771 Control, PC 1772 Monitoring and PC 1784 Expiratory Channel, it can be necessary to re-install the system software. For further information refer to section "Replacing PC boards" in this chapter.

With power supply connected to the Servoⁱ System, there are energized electrical components inside the unit, e. g. 150 V at the AC/DC Converter. All personnel must exercise extreme caution if fault tracing or adjustments are performed with power supply connected and with the patient unit covers removed.

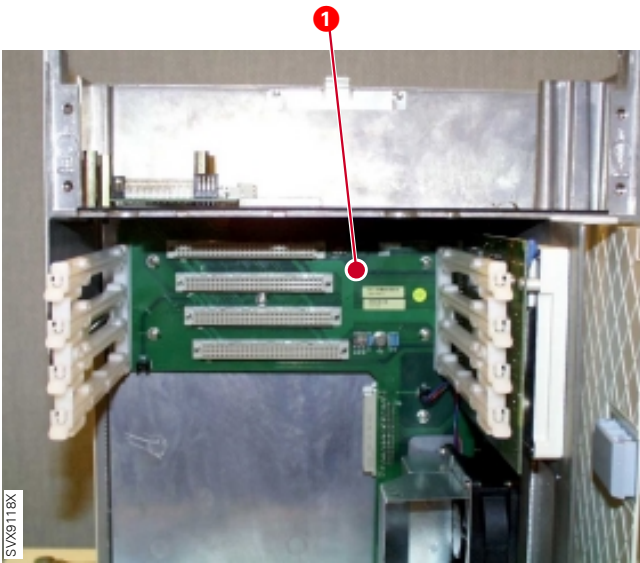

Note

When replacing PC 1770 (1): The ventilators ID (Serial No.), configuration, time stamp for preventive maintenance, etc, is stored in an EEPROM on PC 1770. Thus, PC 1770 can only be replaced by a factory preset PC board. For further information refer to chapter "Description of functions".

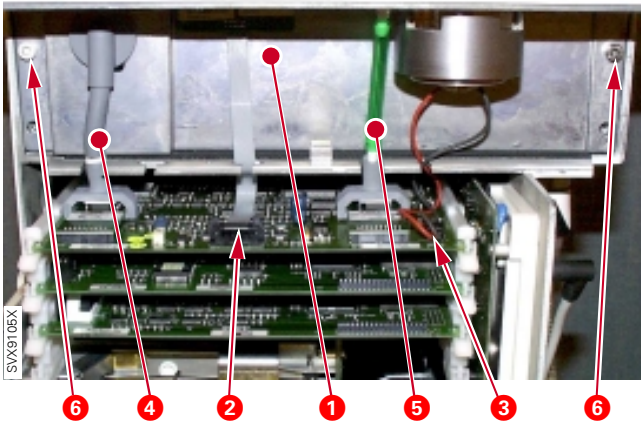

- To remove the expiratory cassette compartment (1):
- Disconnect the connectors (2 and 3) from PC 1784.
 - Disconnect the tubes (4 and 5) from PC 1784.
 - Disconnect the inspiratory pressure tube from the inspiratory pipe inside the inspiratory section (not visible in this illustration).
 - Remove the two screws (6).
 - Lift off the cassette compartment (1).

4

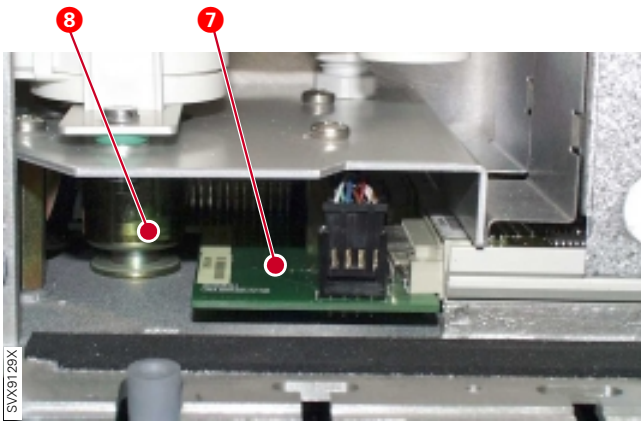

- All parts behind the cassette compartment are now accessible, e. g. the:
- PC 1780 Pneumatic back-plane (7).
 - Safety valve pull magnet (8).

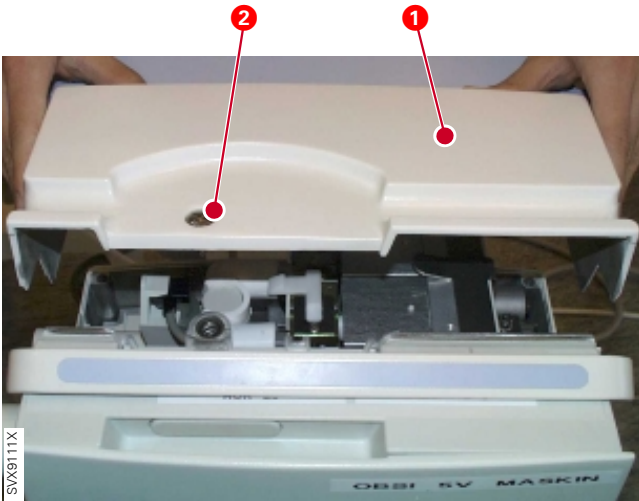

To remove the inspiratory section cover (1):

- Loosen the screw (2).
- Lift off the cover (1).

All parts in the inspiratory section are now accessible.

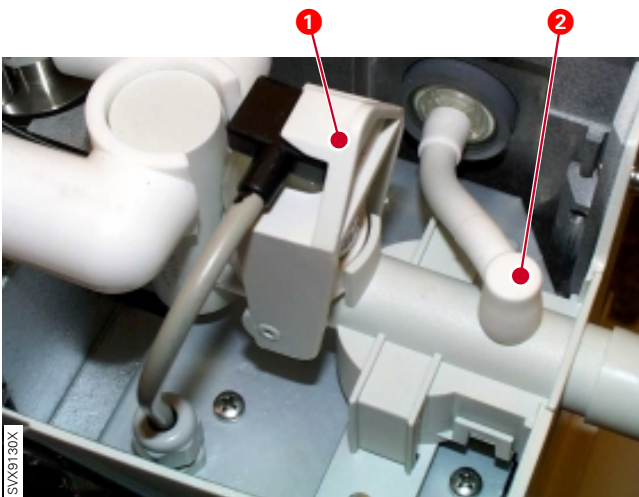

To remove the inspiratory pipe:

- Lower the locking catch (1) and lift off the O₂ cell.
- Disconnect the inspiratory pressure tube (2).

4

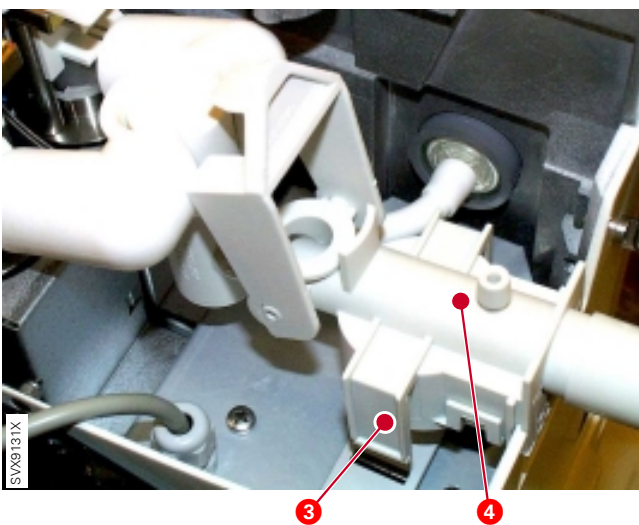

- Depress the two catches (3), one at each side of the safety valve housing, and lift off the inspiratory pipe (4).

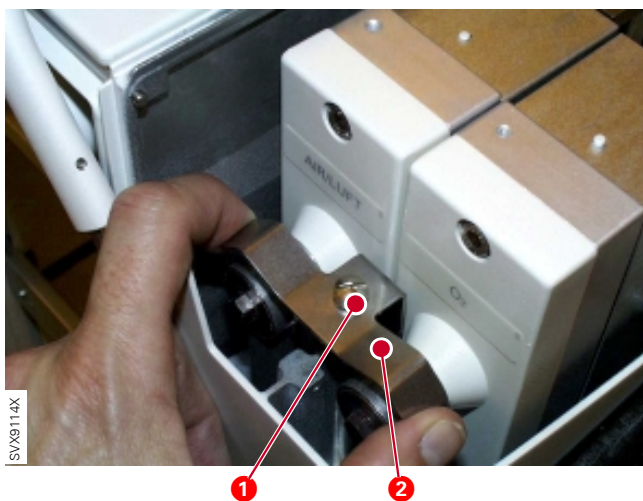

To remove the gas modules:

- Loosen the screw (1).
- Lift off the gas module bracket (2).

4

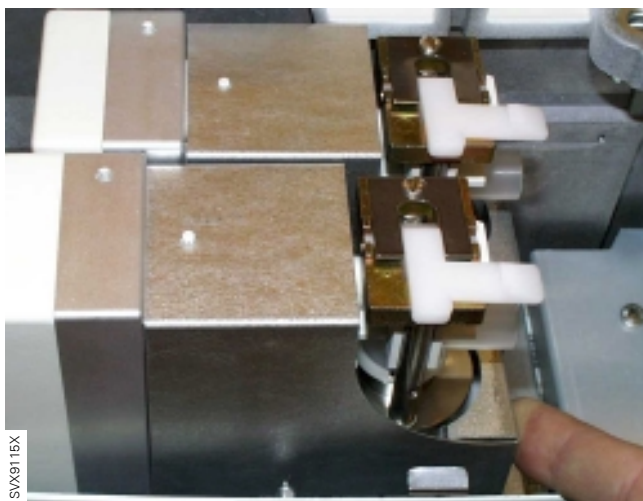

- Pull out and lift off both gas modules.

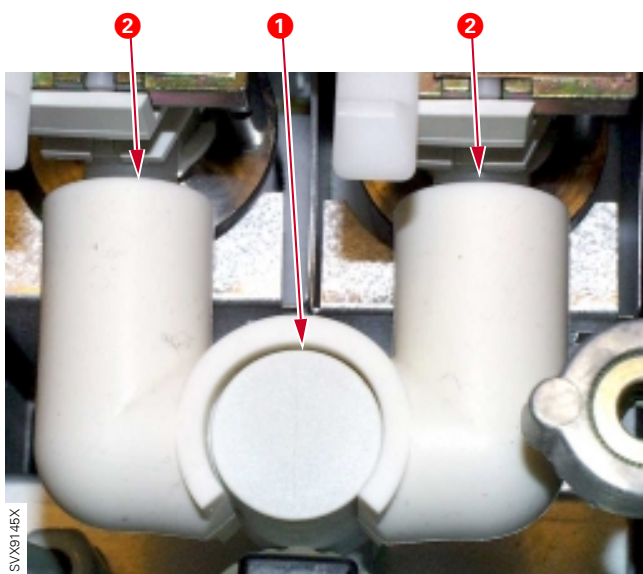

Note 1

When assembling, make sure that the connector muff properly seals around the inspiratory pipe (1). The connector muff must not be pushed too far onto the nozzle units (2).

Note 2

The gas modules used in Servoⁱ are factory adjusted for this purpose. When replacing gas modules, make sure to use only Servoⁱ gas modules. Similar gas modules intended for the Siemens SV 300/300A or KION Systems must not be used.

5. Service procedures

Software installation 5 - 2

Checking the Battery modules 5 - 4

Replacing the lithium batteries on
PC 1771 and PC 1772 5 - 5

Replacing the membrane in the
expiratory cassette 5 - 6

Menu key 5 - 9

Only personnel trained and authorized by Siemens shall be permitted to perform installation, service or maintenance of the Servoⁱ System.



Make sure that the Servoⁱ System is properly cleaned before performing any service or maintenance; routine cleaning as well as extended cleaning. For cleaning procedures, refer to the "Servoⁱ Ventilator System – User's manual".

Any service or maintenance must be noted in a log book.

All disposable parts must be discarded according to local regulations and in an environmentally acceptable way.

After any service or maintenance of the Servoⁱ System, perform a "Pre-use check". Refer to the "Servoⁱ Ventilator System – User's Manual" for details.

Software installation

General

- Before starting any software upgrade or update, check the version of the installed Servoⁱ system software (see System version in the Status window) and the version of the Servoⁱ system software stored on the PC Card. It is not recommended to install Servoⁱ system software with lower version number than already installed in the Servoⁱ.
- After any installation, maintenance or service intervention in the Servoⁱ Ventilator System, perform a "Pre-use check" according to instructions in the Servoⁱ Ventilator System – User's manual.
- To insert / remove the PC Card:

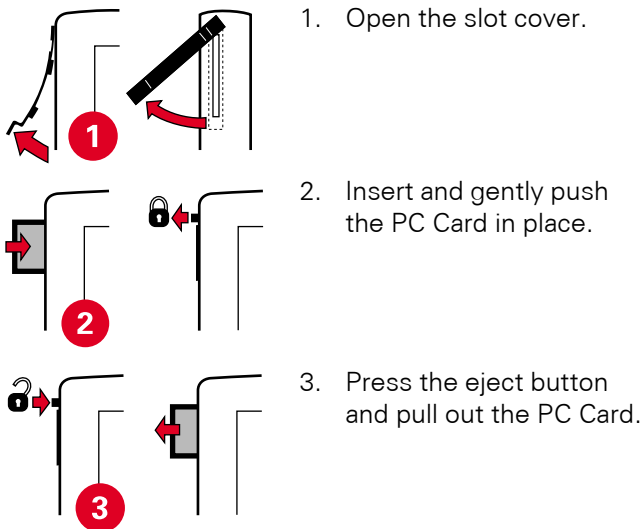

5

Software information

There are two different intentions for software installation:

Option upgrade

An option upgrade will change the function of the Servoⁱ Ventilator System, e. g. change patient category configuration and/or add new ventilation modes. An option upgrade is individually created for each ventilator and can only be installed on this ventilator. Serial number of the ventilator must be stated when ordering an option upgrade.

Option upgrade is distributed on an Option card. As the option upgrade will change the functions of the ventilator, a new Servoⁱ Ventilator System – User's manual will be enclosed. Option upgrades for several Servoⁱ can be distributed on one Option card. If so, a corresponding number of User's manuals will be enclosed.

System software update

A system software update will install a new system software version in the Servoⁱ Ventilator System. It will not change the configuration of the ventilator. System software updates are not dependent on the serial number of the ventilator.

System software update is distributed on an S/W version update card.

Note: As an option upgrade may require a new system software version, the Option card will also contain this system software. A system software update will then be performed during the option upgrade.

Option upgrade – Installation procedure

- Set the On/Off switch to **Off**.
- Insert the Option card.
- Set the On/Off switch to **On**. The installation window will now appear on the screen and the semi-automatic installation procedure will start. Follow instructions given on the screen.
- Press the Main Rotary Dial to start the upgrade (or switch the system **Off** to cancel).
- The installation program will now check the versions of the system software and hardware installed in the Servoⁱ. This check is done to detect :
 - If a new system software installation is required prior to the option upgrade
and/or
 - If the upgrade must be terminated due to hardware incompatibility (see Note 1 below).
- If detected that a system software update is required, this installation will start. The installation may take up to 15 minutes.
- When the system software update is completed (or found not required), press the Main Rotary Dial to restart the Servoⁱ as instructed on the screen. Do not remove the Option card.
- The option upgrade will now start. This installation of the new configuration will take only a few seconds. Information on the screen will state if the upgrade was successful (see Note 2 below).
- Remove the Option card and close the slot cover.
- Restart the system with the **On/Off** switch.
- Perform a "Pre-use check" according to instructions in the new Servoⁱ Ventilator System – User's manual.
- Hand-over the new User's manual to the customer. Make sure that the old User's manual is deleted.

Note 1:

If detected by the installation program that the update/upgrade cannot be installed due to hardware incompatibility, the installation will be terminated. A message will occur on the screen. Remove the PC card and restart the Servoⁱ.

System software update – Installation procedure

- Set the On/Off switch to **Off**.
- Insert the S/W version update card.
- Set the On/Off switch to **On**. The installation window will now appear on the screen and the semi-automatic installation procedure will start. Follow instructions given on the screen.
- Press the Main Rotary Dial to start the update (or switch the system **Off** to cancel).
- The installation program will now check the versions of the system software and hardware installed in the Servoⁱ. This check is done to detect:
 - If a new system software installation is required
and/or
 - If the update must be terminated due to hardware incompatibility (see Note 1 below).
- If a system software update is required, this installation will start. The installation may take up to 15 minutes. However, if an update is not required, the installation is terminated. A message will occur on the screen.
- When the installation is completed (or found not required), press the Main Rotary Dial to restart the Servoⁱ as instructed on the screen. Do not remove the S/W version update card.
- The system will start-up in standby mode. Remove the S/W version update card and close the slot cover when the "Do you want to start Pre-use check?"-window appears on the screen.
- Perform a "Pre-use check" according to instructions in the Servoⁱ Ventilator System – User's manual.

Note 2:

The option upgrade is possible only if the new configuration on the Option card matches the serial number of the Servoⁱ. If not, the option upgrade will not be installed and the system will start-up in standby mode. Remove the Option card when the "Do you want to start Pre-use check?" -window appears on the screen. Such installation is equal to a system software update.

Checking the Battery modules

Check the manufacturing date of the Battery module. Manufacturing date is printed on the battery label.

The batteries must be replaced after 3 years.

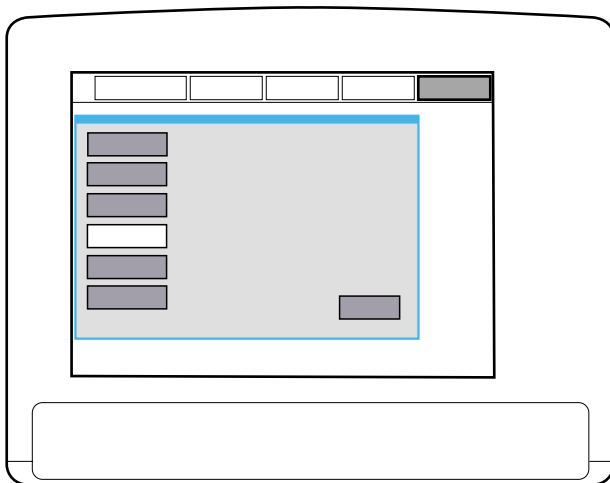
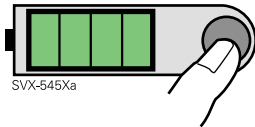

5

- Allow the Battery module to charge until it is fully charged. To display battery status:
 - Press the battery power symbol button on the battery to be checked. All four LEDs must be lit.
 - and*
 - Select Status / Modules on the User Interface. Check that remaining time is more than 30 minutes on the battery to be checked.
 - With gas, patient tubes and test lung connected, let the Servoⁱ System run in a ventilation mode.
 - Disconnect mains power to the Servoⁱ System to allow battery operation.
 - Let the Servoⁱ System run in battery operation and check that the "**No battery capacity**"- alarm is not activated within the specified time. The Operating time is dependent on the number of Battery modules connected, refer to the "Servoⁱ Ventilator System – User's manual".
 - Check that the time between the "**Limited battery capacity**"- alarm and the "**No battery capacity**"- alarm is more than 7 minutes.
- Note:** All alarms are time-stamped and stored in the Servoⁱ System. This alarm information can be displayed in the Event log.

- Allow the backup battery to recharge before clinical use of the Servoⁱ System. The Charging time is dependent on the number of Battery modules connected, refer to the "Servoⁱ Ventilator System – User's manual".

After any maintenance or service of the Servoⁱ System, perform a "Pre-use check". Refer to the "Servoⁱ Ventilator System – User's manual".

Replacing the lithium batteries on PC 1771 and PC 1772

The lithium batteries must be replaced after 5 years. A Technical error message will appear on the screen if the battery voltage level is too low.

Always replace both batteries at the same time to keep the same replacement date for both batteries.

Preparations

- Set the On/Off switch on the control unit to **Off**.
- Disconnect the mains power cable.
- Disconnect the gas supplies (wall and/or cylinder).
- Remove patient tubing.

Replacing the lithium battery

- The lithium batteries are mounted ESD sensitive PC boards. Refer to chapter "Disassembling and assembling", section "Handling PC boards" for further information regarding ESD sensitive components.
- Remove the patient unit front cover. Refer to chapter "Disassembling and assembling", section "Patient unit".
- Carefully pull out the PC board (PC 1771 or PC 1772) containing the lithium battery to be replaced.

Note: Do not remove the cable connector (1). Information stored in the PC board memory will be erased if the connector is removed:

- If the battery on PC 1771 is disconnected; user default configurations made via the Field Service System (FSS) and Pre-use check results including transducer calibrations will be erased.
- If the battery on PC 1772 is disconnected; all trends, all logs and Pre-use check results including transducer calibrations will be erased.

- There are two equal battery connectors (2 and 3) on the PC boards. Connect the new battery to the unused connector. The memory functions are now secured by the new battery.
- Cut the cable ties holding the old battery (4) to the PC board.
- Disconnect and remove the old battery.
- Mount the new battery onto the PC board using new cable ties as shown in the illustration.
- Insert the PC board into the correct PC-board slot and reassemble the patient unit.

After any maintenance or service of the Servoⁱ System, perform a "Pre-use check". Refer to the "Servoⁱ Ventilator System – User's manual".

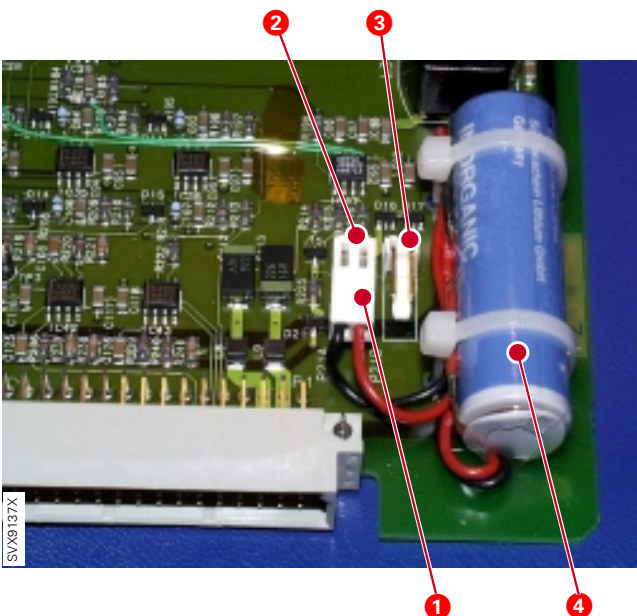

Replacing the membrane in the expiratory cassette

The expiratory cassette is a complete unit and must not be disassembled. The only part that can be replaced is the valve membrane.

Before replacing the membrane, check the remaining operating time for the expiratory cassette. If less than 10–15% operating time remains, it is recommended to replace the complete expiratory cassette.

It is very important for the function of the expiratory valve that the valve membrane is removed and mounted correctly as described below.

To remove the valve membrane from the cassette:

- Carefully remove the membrane including retaining ring using a suitable retaining ring pliers.



SVX9135X

5

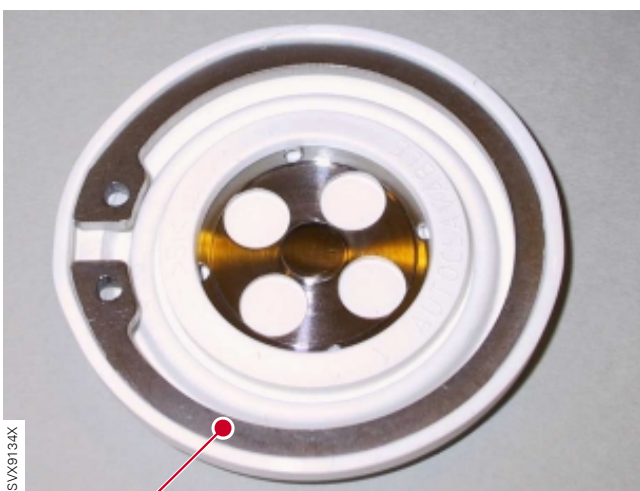

SVX9134X

To mount the valve membrane into the cassette:

- Place the retaining ring (1) correctly into the membrane.

It is very important that the valve membrane and the membrane seat in the cassette is clean. Dirt particles can create leakage in the cassette.



- Place the membrane onto the cassette as shown in the illustration.

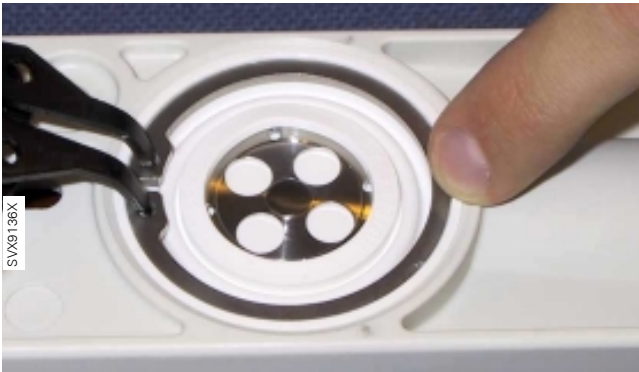

- Squeeze the retaining ring pliers and carefully press the membrane in place into the cassette as shown in the illustration.



- Carefully release and remove the retaining ring pliers.
- Check that the membrane is not deformed by the retaining ring. If necessary, remove the membrane and redo the complete mounting procedure.

- Mount the expiratory cassette onto the Patient Unit.

After any maintenance or service of the Servoⁱ System, perform a "Pre-use check". Refer to the "Servoⁱ Ventilator System – User's manual".

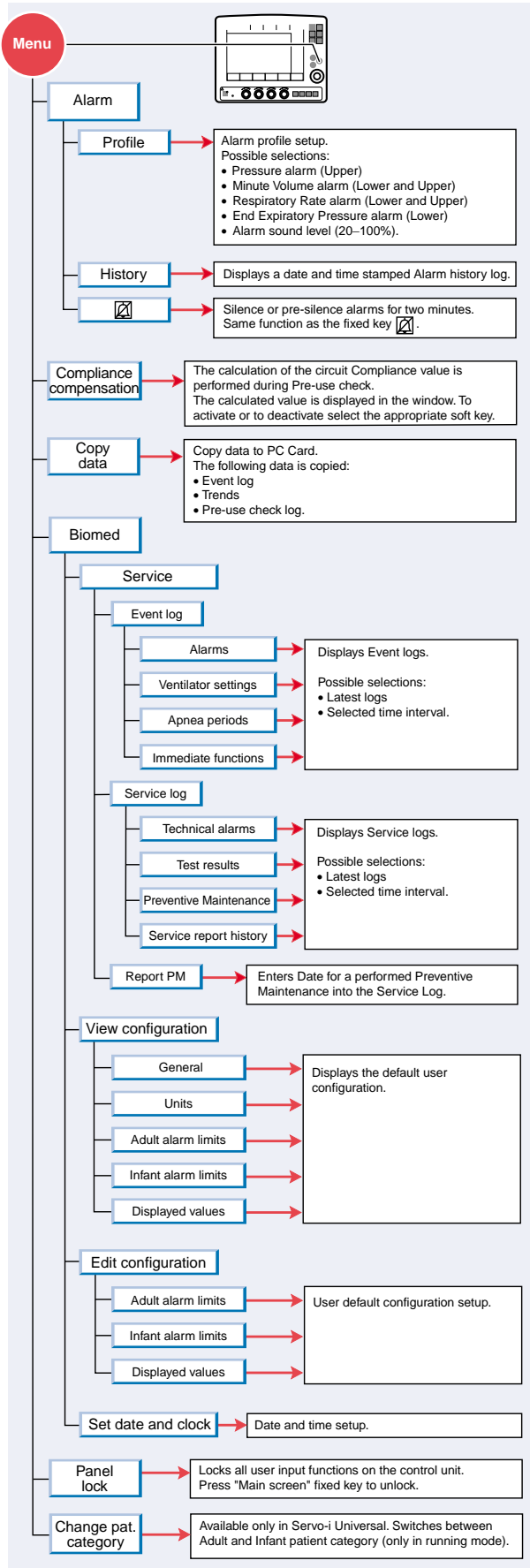

Menu key

The "Menu" function is a useful tool for the hospital Biomed as well as for the Siemens CSE (Customer Service Engineer). There are no locked functions within the Menu, all users have access to all functions. However, the "Biomed" submenu is intended only for Technical Personnel.

Menu flowchart

Pressing the fixed key "Menu" will open the "Menu" window on the User Interface. Possible selections in this window, as described in the flowchart, are:

- Alarm
- Compliance compensation
- Copy data
- Biomed
- Panel lock
- Change patient category (available only in ventilation mode).

Biomed

Of the possible selections in the "Menu" window, the "Biomed" menu will be of main interest for the hospital Biomed and for the Siemens CSE.

Service

Event Log:

Displays log lists. Useful during troubleshooting.

Service Log:

Displays log lists. Useful during troubleshooting.

Report PM:

This button must be pressed when a Preventive Maintenance has been performed. This will reset the timer that indicates operating hours until next Preventive Maintenance.

View configuration

Displays the user default configuration.

There are three different configuration levels:

- Options. This level controls if the ventilator is configured as for Adult, Infant or Universal. It also controls options such as Ventilation modes, Automode and Nebulizer. Options can only be installed/changed with an Option card, a PC Card that is individually created for each ventilator.
- Locked user default configurations. This level controls user default configurations such as default Patient range, Language and Units. The Field Service System (FSS) is required to change the locked user default configurations. With the FSS it is also possible to import user default configurations, e. g. configurations specified for all Servoⁱ in one department or hospital.
- Open user default configurations. This level controls user default configurations such as Alarm Limits and Displayed Values. The open user default configurations can be changed via the Menu key (see Edit configurations below).

Edit configuration

Open user default configurations such as Alarm Limits and Displayed Values can be changed in this window.

Locked user default configurations such as General parameters (Patient range, Language, etc) and Units can only be changed via the Field Service System (see View configuration above).

Set date and clock

Date and time setting can be changed in this window.

6. Troubleshooting

General 6 - 2
Pre-use check 6 - 3
Technical error codes 6 - 7

Only personnel trained and authorized by Siemens shall be permitted to perform installation, service or maintenance of the Servoⁱ System.



Make sure that the Servoⁱ System is properly cleaned before performing any service or maintenance; routine cleaning as well as extended cleaning. For cleaning procedures, refer to the "Servoⁱ Ventilator System – User's manual".

Any service or maintenance must be noted in a log book.

All disposable parts must be discarded according to local regulations and in an environmentally acceptable way.

After any service or maintenance of the Servoⁱ System, perform a "Pre-use check". Refer to the "Servoⁱ Ventilator System – User's Manual" for details.

Possible causes to malfunction not mentioned in the following troubleshooting guides are:

- The system has not been correctly assembled after cleaning, maintenance or service.
- Disconnection or bad connection in cable connectors, PC board connectors, and inter-connection boards.
- Disconnected or defective gas tubes.

These possible causes to malfunction must always be considered during troubleshooting.

General

Before starting troubleshooting, try to eliminate all possibilities of operational errors. If the malfunction remains, use the troubleshooting guides below as well as the information in chapter "Description of functions" to locate the faulty part. Perform actions step by step and check that the malfunction is eliminated.

When the fault is corrected, carry out a complete "Pre-use check" as described in the Servoⁱ Ventilator System – User's manual.

The troubleshooting guides below are focused only on technical problems. Information about clinical related problems can be found in the Servoⁱ Ventilator System – User's manual.

Pre-use check

The Servo*i* System demands the user to start the automatic Pre-use check at every start-up of the system. It is also possible to select the Pre-use check via the Standby menu.

The Servo*i* Ventilator System – User's Manual describes how to perform this Pre-use check. The Pre-use check-description on the following pages gives a more detailed information about the Pre-use check. This information can be used e. g. during troubleshooting of the Servo*i* System.

| Test | Test description * | Recommended action if the test fails |
|-----------------------|--|--|
| During system startup | Internal technical tests: <ul style="list-style-type: none"> • S/W download • S/W check • Reading EEPROM • Checksum EEPROM | <ol style="list-style-type: none"> 1. Restart the Servo<i>i</i>. 2. Reinstall the system software. |

Start Pre-use check

| | | |
|--------------------------|---|--|
| Internal tests | Audio test. (PAN + MON) | <p>Make sure that the Patient Unit front cover and the User Interface rear cover are correctly mounted, otherwise these tests may fail.</p> <p>Check in the Test log if it is the Panel or the Monitoring test that have failed (requires FSS-card):</p> <ul style="list-style-type: none"> – If Monitoring test fails: replace PC1772 Monitoring. – If Panel test fails: replace loudspeaker or PC1777 Panel. |
| Barometer test | <p>Checks that the barometric pressure measured by the internal barometer is within 630–1080 hPa.</p> <p>Checks that the measured barometric pressure values differs less than 8 hPa between MON and BRE.</p> <p>(BRE + MON)</p> | <p>Check the Barometric pressure value in the Status window:</p> <ol style="list-style-type: none"> 1. If that value is within 630–1080 hPa, replaced the PC 1771 Control. 2. If that value is outside 630–1080 hPa, replaced the PC 1772 Monitoring. |
| Gas supply pressure test | <p>Checks that the gas supply pressures (Air and O₂) measured by the internal gas supply pressure transducers are within 2–6.5 kPa x 100 (2.0–6.5 bar).</p> <p>Checks that the measured supply gas pressure values differs less than 20 mbar between MON and BRE.</p> <p>(BRE + MON)</p> | <ol style="list-style-type: none"> 1. Check that the connected gas supply pressure (Air and O₂) is within the specified range. 2. Start the Servo-i in a ventilation mode and check the alarms: <ul style="list-style-type: none"> – If an Air supply pressure-alarm is activated, replace the Gas module Air. – If an O₂ supply pressure-alarm is activated, replace the Gas module O₂. |

* Text within brackets refers to the tested subsystem; BRE = Breathing, MON = Monitor, PAN = Panel.

| | | |
|------------------------------|---|---|
| <p>Internal leakage test</p> | <p>Checks the internal leakage, with test tube connected, using the inspiratory and expiratory pressure transducers.</p> <p>Checks that the leakage is less than 11 ml/min at 80 cm H₂O.</p> <p>Checks that the measured pressure values differs less than 5 cm H₂O between insp. and exp.</p> <p>(BRE)</p> | <p>If message "Leakage" or "Excessive leakage" appears:</p> <ol style="list-style-type: none"> 1. Check that the test tube is correctly connected. 2. Check the expiratory cassette: Check that the expiratory valve membrane is correctly seated in the cassette. Check that the cassette is correctly seated in the cassette compartment. If possible, replace the expiratory cassette and check if the new cassette is accepted by the Pre-use check. 3. Check the inspiratory section: Check that the safety valve membrane is correctly seated in the inspiratory pipe. Check that the inspiratory pipe is correctly mounted in inspiratory section. Check that the safety valve closes properly when the Pre-use check is started (distinct clicking sound from the valve) 4. Check that the pressure transducer tubes/filter are correctly mounted. 5. Clean the expiratory cassette and the inspiratory pipe, in order to remove possible dirt particles on the membrane. <p>If message "Pressure Transducer difference > 5 cm H₂O" appears:</p> <ol style="list-style-type: none"> 1. Check the test tube. 2. Check that the pressure transducer tubes/filter are correctly mounted. 3. If the Pressure transducer test also fails (see below), check the pressure transducers (Insp. and Exp.). |
|------------------------------|---|---|

6

| | | |
|---------------------------------|--|--|
| <p>Pressure transducer test</p> | <p>Calibrates and checks the inspiratory and expiratory pressure transducers.</p> <p>The new zero value for the pressure transducers may not differ more than ± 6 hPa from factory calibration.</p> <p>With the inspiratory pressure transducers used as a reference, a new gain factor is set for the expiratory pressure transducer. The new gain factor may not differ more than $\pm 5\%$ from factory calibration.</p> <p>During this test, the different subsystems concerned are compared. The difference between the subsystems must not be more than ± 1 cm H₂O at 60 cm H₂O.</p> <p>(BRE + MON)</p> | <p>If the Internal leakage test passed (see above), check/replace Insp. or Exp. pressure transducer. To locate the faulty pressure transducer, replace one transducer at a time and re-run Pre-use check (or pressure transducer test in FSS).</p> |
| <p>Safety valve test</p> | <p>Checks and if necessary adjusts the opening pressure for the safety valve to 117 ± 3 cm H₂O.</p> <p>Checks the hardware signals related to the safety valve functions.</p> <p>(BRE + MON)</p> | <ol style="list-style-type: none"> 1. Check the inspiratory section: Check that the safety valve membrane is correctly seated in the inspiratory pipe. Check that the inspiratory pipe is correctly mounted in inspiratory section. 2. Check that the safety valve closes properly when the Pre-use check is started (distinct clicking sound from the valve). 3. Replace PC 1784 Expiratory channel. |
| <p>O₂ cell test</p> | <p>Calibrates and checks the O₂ cell at 21% O₂ and 100% O₂.</p> <p>Checks if the O₂ cell is worn out.</p> <p>As different gas mixtures are used during this test, calibration and check of O₂ cell will not be performed if one gas is missing.</p> <p>(BRE + MON)</p> | <ol style="list-style-type: none"> 1. Check that the connected gas supply pressure (Air and O₂) is within the specified range. 2. Replace the O₂ cell. 3. Replace gas modules (Air and O₂). 4. Replace PC 1771 Control. 5. Replace PC 1772 Monitoring. |

| | | |
|-------------------------------------|---|--|
| <p>Flow transducer test</p> | <p>Checks the inspiratory flow transducer. Calibrates and checks the expiratory flow transducer.</p> <p>Calibrates at 60% O₂ and checks at 100% and 21% O₂. As different gas mixtures are used during this test, calibration of the expiratory flow transducer will not be performed if one gas is missing.</p> <p>The new calibration factor for the expiratory flow transducer may not differ more than -10% to +15% from factory calibration.</p> <p>During this test, the different subsystems concerned are compared. The difference between the subsystems must not be more than ±0.3 l/min.</p> <p>(BRE + MON)</p> | <ol style="list-style-type: none"> 1. Check that the connected gas supply pressure (Air and O₂) is within the specified range. 2. Check that the cassette is correctly seated in the cassette compartment. If possible, replace the expiratory cassette and check if the new cassette is accepted by the Pre-use check. 3. Replace gas modules (Air and O₂). 4. Replace PC 1771 Control. 5. Replace PC 1772 Monitoring. |
| <p>Battery switch test</p> | <p>If Battery modules are connected:</p> <ul style="list-style-type: none"> • Checks that the power supply switches to battery when mains power is disconnected. • Checks that the power supply switches back to mains power when main is re-connected. <p>(MON)</p> | <ol style="list-style-type: none"> 1. Check that the total remaining time for the connected battery modules are >10 min. If not, replace the empty battery with a charged battery and repeat the test. 2. Replace PC1775 Plug-and-play back-plane. |
| <p>Patient circuit leakage test</p> | <p>Checks the patient circuit leakage, with patient tubing connected, using the inspiratory and expiratory pressure transducers.</p> <p>Checks that the leakage is less than 81 ml/min at 50 cm H₂O.</p> <p>Checks that the measured pressure values differs less than 7 cm H₂O between insp. and exp.</p> <p>Will allow the system to calculate a compensation for circuit compliance (if the leakage requirements are met).</p> <p>(BRE)</p> | <p>If the internal leakage test (see above) has passed, the leakage is to be located to the patient circuit. Check for leakage or replace the patient circuit.</p> |
| <p>Alarm state test</p> | <p>Checks that no Technical error alarms are active during the Pre-use check.</p> <p>(MON)</p> | <p>Refer to section regarding Technical error alarms for further information.</p> |

Technical error codes

The table below shows recommended actions in case of Technical error alarms.

Some of the Error codes are intended only for R&D, not for field service. If so, the text "N/A" is stated in the "Recommended action"-column.

| Error code | Error message / Possible cause | Recommended action |
|-------------------|--|---|
| Monitoring | | |
| 1 | POWER_FAILURE_MINUS_12_VOLTS_TOO_LOW | <ol style="list-style-type: none"> 1. Check status of external battery (if connected). 2. Replace PC1778 Standard connectors & DC/DC. |
| 2 | POWER_FAILURE_MINUS_12_VOLTS_TOO_HIGH | <ol style="list-style-type: none"> 1. Replace PC1778 Standard connectors & DC/DC. |
| 3 | POWER_FAILURE_12_VOLTS_TOO_LOW | <ol style="list-style-type: none"> 1. Check status of external battery (if connected). 2. Replace PC1778 Standard connectors & DC/DC. |
| 4 | POWER_FAILURE_12_VOLTS_TOO_HIGH | <ol style="list-style-type: none"> 1. Replace PC1778 Standard connectors & DC/DC. |
| 5 | POWER_FAILURE_24_VOLTS_TOO_LOW | <ol style="list-style-type: none"> 1. Replace PC1778 Standard connectors & DC/DC. 2. Replace gas modules. |
| 6 | POWER_FAILURE_24_VOLTS_TOO_HIGH | <ol style="list-style-type: none"> 1. Replace PC1778 Standard connectors & DC/DC. |
| 7 | INSP_VALVE_RANGE_ERR | <ol style="list-style-type: none"> 1. Replace PC1771 Control. 2. Replace PC1772 Monitoring. 3. Replace gas modules. |
| 8 | TECH_ERR_INSP_PAUSE_HOLD_TIME_EXCEEDED | <ol style="list-style-type: none"> 1. Replace PC1771 Control. |
| 9 | TECH_ERR_EXP_PAUSE_HOLD_TIME_EXCEEDED | <ol style="list-style-type: none"> 1. Replace PC1771 Control. |
| 10 | VALVES_DISABLED | <ol style="list-style-type: none"> 1. Replace PC1784 Expiratory channel. 2. Replace PC1771 Control. 3. Replace PC1778 Standard connectors & DC/DC. |
| 11 | SAFETY_VALVE_OPEN | <ol style="list-style-type: none"> 1. Check inspiratory channel 2. Replace safety valve pull magnet. 3. Replace PC1784 Expiratory channel. |
| 12 | BRE_NODE_DISCON | <ol style="list-style-type: none"> 1. Replace PC1771 Control. |
| 13 | BRE_NODEID_CONFLICT | N/A |
| 14 | PANEL_NODE_DISCON | <ol style="list-style-type: none"> 1. Check control cable 2. Replace PC1777 Panel. |
| 15 | PANEL_NODEID_CONFLICT | N/A |

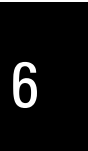

| | | |
|----|-------------------------------------|--|
| 16 | EXP_FLOW_MTR_NODE_DISCON | 1. Replace PC1784 Expiratory channel. |
| 17 | EXP_FLOW_MTR_NODEID_CONFLICT | N/A |
| 18 | EXT_COM_DISCON | N/A |
| 19 | EXT_COM_NODEID_CONFLICT | N/A |
| 22 | BUZZER_SILENCER | 1. Replace PC1772 Monitoring. |
| 24 | BACKUP_CAP_ERR_MON | 1. Replace PC1772 Monitoring |
| 25 | TECH_MON_DEVICE_COMM_ERR # | <p>Depending on #.</p> <p>If repeated, replace parts as follows:</p> <p>0: PC 1770 Main back-plane.</p> <p>1: PC 1772 Monitoring.</p> <p>2: PC 1775 Plug-and-play back plane.</p> <p>3: PC 1778 Standard connectors & DC/DC.</p> <p>4: PC 1781 Inspiratory pressure transducer.</p> <p>5: PC 1781 Expiratory pressure transducer.</p> <p>6: O₂ cell or O₂ cell cable or PC 1772 Monitoring.</p> <p>32: PC 1784 Expiratory channel or PC 1772 Monitoring.</p> <p>33: Gas module Air or PC 1772 Monitoring.</p> <p>34: Gas module O₂ or PC 1772 Monitoring.</p> <p>35: PC1772 Monitoring.</p> <p>256: PC1771 Control.</p> <p>512: PC 1777 Panel.</p> <p>784: N/A</p> <p>1024: PC 1784 Expiratory channel.</p> <p>1025: PC 1786 Expiratory channel cassette.</p> |
| 26 | TECH_ERR_INCONSISTENT_MAINS_FAILURE | N/A |
| 27 | TECH_ERR_BUZZER_FAILURE | <p>1. Replace PC1772 Monitoring.</p> <p>Note: If the Patient Unit front cover is removed, this error may be activated.</p> |

| | | |
|----|-----------------------------------|--|
| 28 | PANEL_AUDIO_FAIL | <ol style="list-style-type: none"> 1. Replace loudspeaker. 2. Replace PC1777 Panel. <p>Note: If the User Interface rear cover is removed, this error may be activated.</p> |
| 29 | LITHIUM_BATTERY_LOW | <ol style="list-style-type: none"> 1. Replace battery on PC1772 Monitoring. |
| 30 | BARO_PRESS_TOO_LOW | <ol style="list-style-type: none"> 1. Check/calibrate barometer. 2. Replace PC 1772 Monitoring. <p>Note: This alarm will be activated if the ambient pressure is below 650 hPa, e.g. on a high altitude.</p> |
| 31 | BARO_PRESS_TOO_HIGH | <ol style="list-style-type: none"> 1. Check/calibrate barometer. 2. Replace PC1772 Monitoring. |
| 32 | ALARM_ID_MISMATCH | N/A |
| 33 | BRE_NODE_CONNECT_TIMEOUT | <ol style="list-style-type: none"> 1. Replace PC1771 Control. |
| 34 | PANEL_NODE_CONNECT_TIMEOUT | <ol style="list-style-type: none"> 1. Check control cable. 2. Replace PC1777 Panel. |
| 35 | EXP_FLOW_MTR_NODE_CONNECT_TIMEOUT | <ol style="list-style-type: none"> 1. Replace PC1784 Expiratory channel. |
| 37 | EXP_FLOW_MTR_RANGE_ERR | N/A |
| 38 | BARO_UPPER_LIMIT_EXCEEDED | <ol style="list-style-type: none"> 1. Technical error code corresponding to error code 30. |
| 39 | BARO_LOWER_LIMIT_EXCEEDED | <ol style="list-style-type: none"> 1. Technical error code corresponding to error code 31. |
| 40 | INVALID_METRIC | N/A |
| 41 | REAL_TIME_CLOCK_ERR | <ol style="list-style-type: none"> 1. Replace PC1772 Monitoring. |
| 42 | PERSISTENT_CHECKSUM_ERR | <ol style="list-style-type: none"> 1. Restart the Servoⁱ. 2. Replace 1772 Monitoring (if not LITHIUM_BATTERY_LOW). |
| 43 | POWER_COMM_ERR | <ol style="list-style-type: none"> 1. Check battery modules (if connected). 2. Replace PC1778 Standard connectors & DC/DC |
| 44 | ALARM_LIM_XOR_ERR | <ol style="list-style-type: none"> 1. Restart the Servoⁱ. 2. Replace 1772 Monitoring (if not LITHIUM_BATTERY_LOW). |

| Breathing | | |
|------------------|------------------------|---|
| 10001 | BATTERY_MIN_VOLTAGE | 1. Replace battery on PC1771 Control. |
| 10002 | BRE_I2C_ERROR | 1. Replace PC1771 Control. |
| 10003 | BRE_FATAL_MEMORY_ERROR | 1. Restart the Servo ⁱ . 2. Replace PC1771 Control. |

| Panel | | |
|--------------|------------------------|---|
| 20001 | PANEL_DEVICE_ERROR | 1. Replace PC1777 Panel. |
| 20002 | PANEL_BACKLIGHT_BROKEN | 1. Replace backlight lamps 2. Replace PC board Backlight Inverter |
| 20003 | PANEL_BUTTON_STUCK | 1. Check user interface membrane buttons. 2. Replace the touch screen. 3. Replace PC1777 Panel. |
| 20004 | PANEL_AUDIO_FAILED | 1. Replace the loudspeaker 2. Replace PC1777 Panel. |

| Exp Flow Meter | | |
|-----------------------|--|---|
| 40001 | Technical error in Exp flow meter (More details in the log) | 1. Replace the expiratory cassette 2. Replace PC1784 Expiratory channel. |

7. Preventive maintenance

- General 7 - 2
- Preparations 7 - 2
- Equipment 7 - 2
- Preventive maintenance 7 - 3
 - Preventive maintenance kit 7 - 3
 - Performing the Preventive maintenance 7 - 3

Only personnel trained and authorized by Siemens shall be permitted to perform installation, service or maintenance of the Servoⁱ System.



Make sure that the Servoⁱ System is properly cleaned before performing any service or maintenance; routine cleaning as well as extended cleaning. For cleaning procedures, refer to the "Servoⁱ Ventilator System – User's manual".

Any service or maintenance must be noted in a log book.

All disposable parts must be discarded according to local regulations and in an environmentally acceptable way.

After any service or maintenance of the Servoⁱ System, perform a "Pre-use check". Refer to the "Servoⁱ Ventilator System – User's Manual" for details.



General

A "Preventive maintenance" must be performed at least once every year as long as the unit is not used more than normal. Normal operation is estimated to correspond to approx. 5.000 hours of operation.

In some parts of the Preventive maintenance, as described in this chapter, the software Field Service System (FSS) is a requirement.

Some optional equipment used in the Servoⁱ System, but not covered by this Service Manual, may also demand maintenance actions. Refer to the equipments documentation. These units can e. g. be:

- Humidifier equipment.
- Other optional equipment.

Preparations

- Make sure that the Servoⁱ System is properly cleaned before performing any maintenance; routine cleaning as well as extended cleaning. For cleaning procedures, refer to the "Servoⁱ Ventilator System – User's manual".
- Make sure that the Servoⁱ System works properly before performing any maintenance.
- Set the On/Off switch on the User Interface to **Off**.
- Disconnect the mains power cable.
- Disconnect the gas supplies (wall and/or cylinder).
- Remove patient tubing.
- Remove Servo Guard bacteria filter from the expiratory inlet.

Equipment

- Standard service tools.
- Barometer (or information about the actual barometric pressure).
- Field Service System (FSS). Recommended but not required.
- Preventive maintenance-kit containing all parts needed during the maintenance.

Preventive maintenance

Preventive maintenance-kit

Only original parts from Siemens must be used in the Servoⁱ System. Spare parts and maintenance kits can be ordered from your local Siemens representative.

When performing this maintenance, a "Preventive maintenance-kit for Servoⁱ" should be used.

The following parts shall be replaced and they are included in the "Preventive maintenance-kit for Servoⁱ":

- A. Filters for the gas modules
- B. Bacteria filter for the inspiratory pressure transducer
- C. Bacteria filter for the O₂ cell
- D. Nozzle units for the gas modules

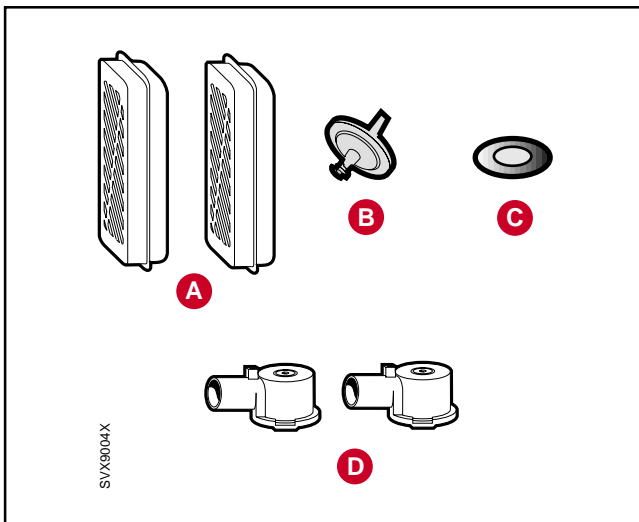

Performing the Preventive maintenance

- Prepare the unit as described in section "Preparations" in this chapter.

Inspiratory section

- Loosen the screw (1) and lift off the inspiratory section cover (2).

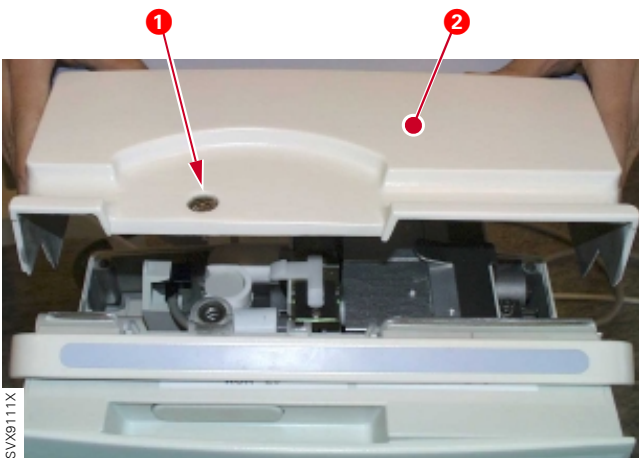

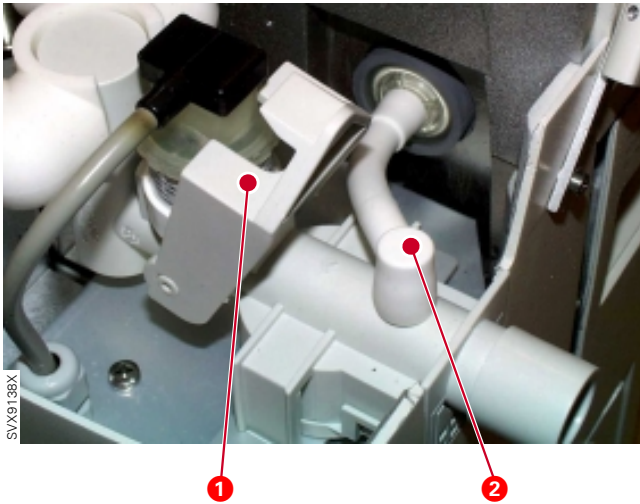

- Lower the locking catch (1) and lift off the O₂ cell.
- Disconnect and lift off the inspiratory pressure tube (2).

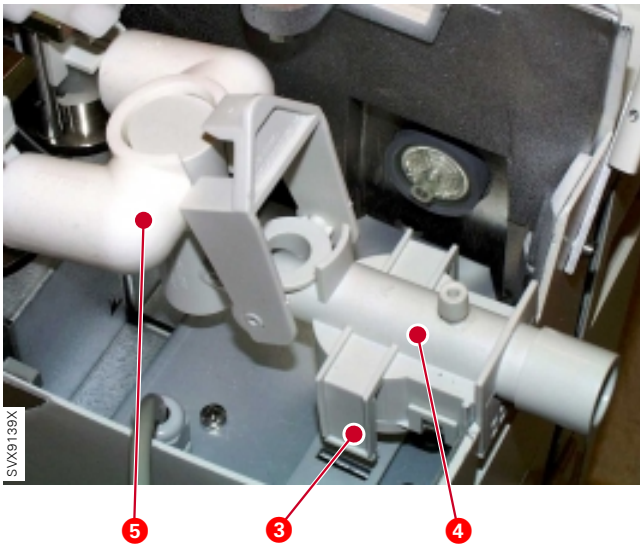

- Press the two latches (3), one at each side of the safety valve housing, and lift off the inspiratory pipe (4) including the connector muff (5).

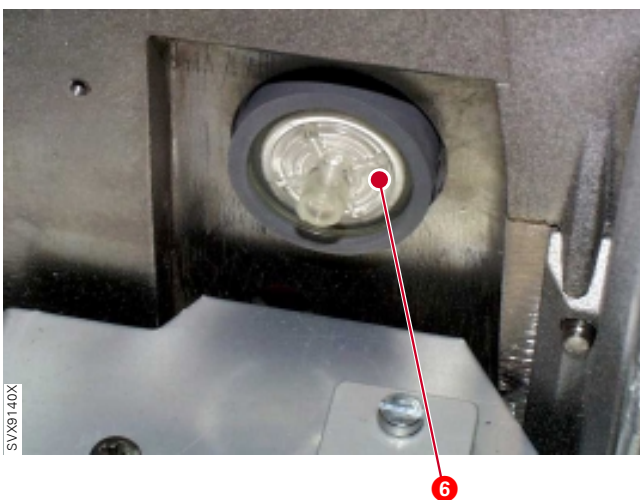

- Replace the filter (6) for the inspiratory pressure transducer. Make sure that the filter is correctly seated into the rubber ring.

Note: This filter may already be replaced as a part of the "Extended cleaning of Inspiratory channel" performed prior to the Preventive maintenance.



- Replace the bacteria filter (1) for the O₂ cell.

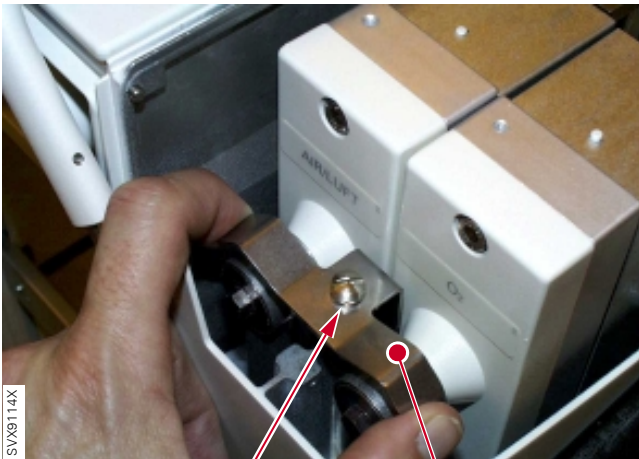

- Loosen the screw (1).
- Lift off the gas module bracket (2).

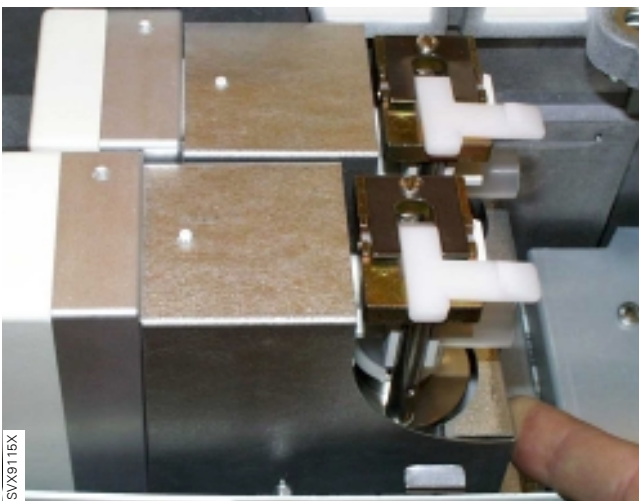

- Pull out and lift off both gas modules.

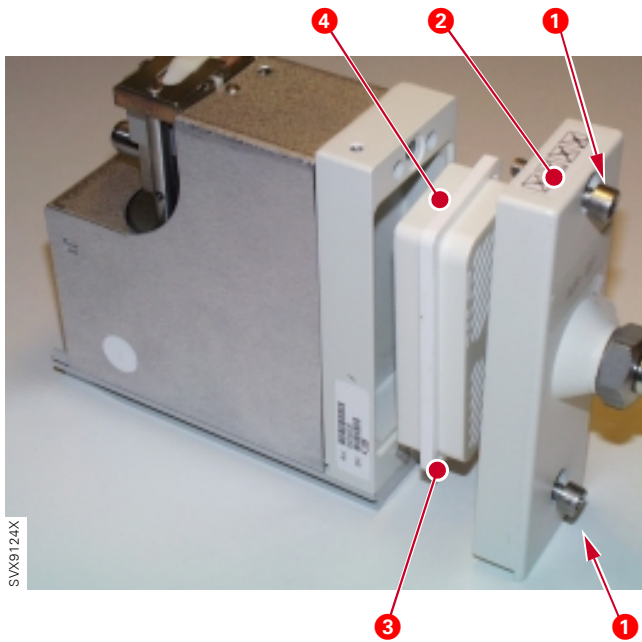

On each one of the two gas modules:

- Unscrew the two screws (1) and lift off the cover (2).
- Remove the rubber sealing (3) from the old filter (4) and discard the old filter.
- Mount the rubber sealing on the new filter and put the new filter into the cover (2).
- Mount the cover on the gas module.

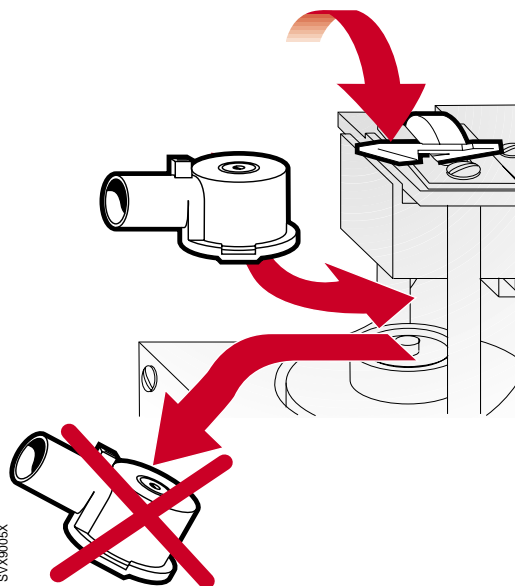

On each one of the two gas modules:

- Open the hatch and pull out the nozzle unit.
- Carefully put the new plastic nozzle unit in position into the gas module and close the hatch.
- Discard the old nozzle unit.

Wait 10 minutes before connecting pressure to the gas modules.

- Re-assemble all parts inside the inspiratory section. Do not mount the inspiratory section cover.

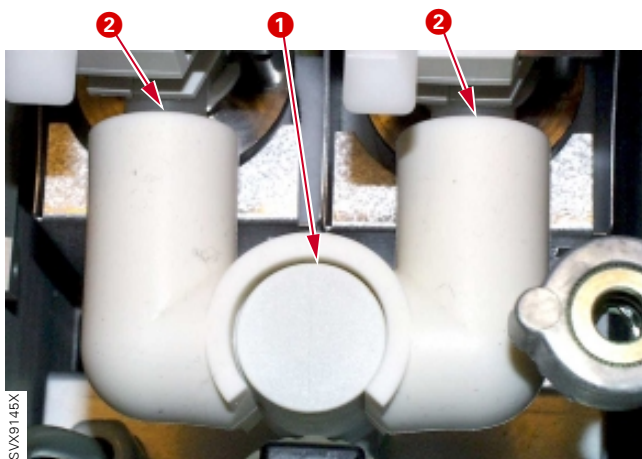

Note: When assembling, make sure that the connector muff seals around the inspiratory pipe (1). The connector muff must not be pushed too far onto the nozzle units (2).

All disposable parts must be discarded according to local regulations and in an environmentally safe way.



Internal fan filter

- Remove the internal fan filter (1).
- Check if the filter is damaged. Replace damaged filter.
- If not damaged, clean the filter. The filter can be rinsed in water. Shake out and make sure that the filter is free from excess water.
- Mount the new/cleaned filter.
- Connect the mains power cable.
- Set the On/Off switch to Standby.

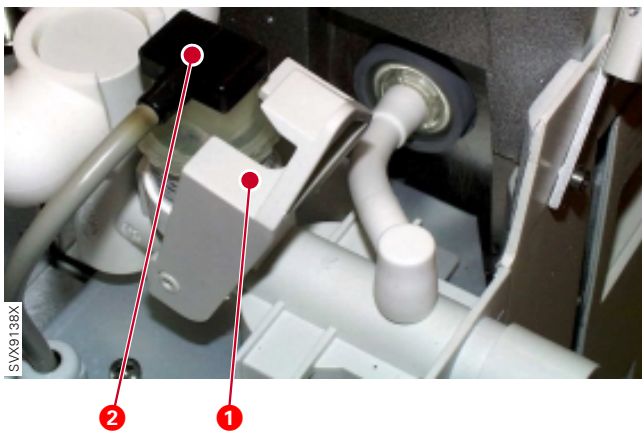

Internal fan

- Lower the locking catch (1) and disconnect the connector (2). This is done to protect the O₂ cell during the Internal fan-test.
- Carefully warm-up the cable connector (2) and check that the Internal fan starts. Use e. g. a light bulb or a heat fan to warm the connector. The temperature must not exceed 70 °C. The Internal fan will start with half effect at approx. 33 °C and with full effect at approx. 43 °C.
- Re-connect the connector (2) and mount the inspiratory section cover.

User Interface

- Check the touch screen readability:
 - Brightness (backlight)
 - Transparency
 - Surface.
- Check if pixels on the touch screen are defective. Open the Status window. A few defective pixels can be accepted. Check that defective pixels are not concentrated to a small area thus reducing the readability in this area. FSS is recommended but not required.
- Perform the checks listed below and make sure that the software responds to these actions. FSS is recommended but not required.
 - Check the touch screen functions. Press buttons on different parts of the touch screen.
 - Check the Main Rotary Dial. Turn and press the Main Rotary Dial.
 - Check the Direct Access Knobs. Turn and press all Direct Access Knobs.
 - Check the membrane buttons. Press all membrane buttons.

Expiratory cassette

- Select Status / Exp. cassette on the User Interface. Check the status of all expiratory cassettes used on the Servoⁱ System to be maintained. Inform the customer if less than 10% of the cassettes expected life length remains.

Barometric pressure

- Select Status / General on the User Interface. Check that the Barometric pressure value shown on the User Interface corresponds to the actual Barometric pressure value at the local site. The value shown on the User Interface may not differ more than $\pm 5\%$ from the actual barometric pressure.
- If the value shown on the User Interface differs more than $\pm 5\%$ from the actual barometric pressure, the barometer in Servoⁱ must be calibrated. FSS is required, contact personnel authorized by Siemens that have access to the FSS.

Gas supply pressure transducers

- Connect the gas supplies (Air and O₂).
- Select Status / General on the User Interface.
- Disconnect the gas supply, one gas at the time.
- Check that the corresponding supply pressure value in the Status-window drops.

Battery modules

- Check the status of the Battery modules used:
 - Check the manufacturing date of the Battery module. Manufacturing date is printed on the battery label. The battery must be replaced after 3 years.
 - Check that the battery housing is not damaged.
 - Press the battery power symbol button and check that the green LEDs are lit. All 4 LEDs must be lit if the battery is fully charged.

If required, an extended check of the Battery modules can be performed. This extended check is described in chapter "Service procedures".

Lithium batteries

- Check manufacturing date for the lithium batteries mounted onto PC 1771 and PC 1772. The batteries must be replaced after 5 years. Replacement is described in chapter "Service procedures".

Safety inspection

- Make a visual inspection of the Servoⁱ System for external defects or damages. Replace defective or damaged parts.
- Check the mains power cable and control cable and their connections for damage.
- Perform a leakage current test. The leakage current test is a standard procedure regulated by IEC 60 601-1 or corresponding national standards. Allowable values and test methods are defined in the standard. The use of a leakage tester, e. g. Bender Safety Tester 601/751 or equivalent is recommended.
- Check that a "Servoⁱ Ventilator System – User's manual" and a "Servoⁱ Ventilator System – Brief instructions" corresponding to the installed software version is present. Also check that operating manuals for all optional equipment connected to the Servoⁱ System are present.

Completing the Preventive maintenance

- Perform a "Pre-use check". Refer to the "Servoⁱ Ventilator System – User's manual".
- Perform "Function checks" on the optional equipments connected to the Servoⁱ System. Refer to the operating manuals for these optional equipments.
- Note in the Servoⁱ System software (Biomed) and also in a Servoⁱ System log book that a Preventive maintenance has been performed.

Notes

7

8. Index

Alphabetic index 8 - 2

- AC/DC Converter 2-5, 3-9
- Assembling guidelines 4-2
- Backlight inverter 2-3, 3-2
- Bacteria filter for the inspiratory pressure transducer 7-3
- Bacteria filter for the O₂ cell 7-3
- Barometric pressure 7-8
- Battery modules 5-4, 7-8
- Biomed 5-9
- Block diagram 9-3
- Breathing 2-7
- Cable reel 2-3
- Configuration 5-10
- Connector for external +12V DC 2-4
- Connector for nebulizer 2-4
- Connector for PC 2-3
- Connector muff 2-6, 3-4
- Control cable 2-2, 2-3, 3-10
- Control cable connector 2-4
- Direct access controls 2-3
- EEPROM 3-2
- Equipotentiality terminal 2-4
- Error code 6-7
- Error message 6-7
- Expiratory cassette 2-6, 3-6, 7-8
- Expiratory cassette compartment 4-6
- Expiratory cassette membrane 5-6
- Expiratory inlet 2-4
- Expiratory outlet 2-4
- Expiratory section 3-6
- Expiratory valve coil 2-5, 2-6
- Field Service System 7-2
- Filters for the gas modules 7-3
- Flash memory 3-2
- Front panel screen 3-2
- FSS 7-2
- Functional main blocks diagram 9-3
- Fuse F1 for external +12V DC 2-4
- Gas inlet for Air 2-4
- Gas inlet for O₂ 2-4
- Gas modules 2-6, 3-3, 4-8
- Gas supply pressure transducers 7-8
- Handling PC boards 4-2
- Inspiratory outlet 2-4 3-5
- Inspiratory pipe 2-6, 3-4, 4-7
- Inspiratory pressure transducer tube 2-6, 3-4
- Inspiratory section 3-3
- Inspiratory section cover 2-4, 4-7
- Internal fan 2-4, 2-5, 3-9, 7-7
- Internal fan filter 7-7
- Lithium batteries 5-5, 7-9
- Lithium batteries
- Locking arm 2-3
- Locking screw 2-3
- Loudspeaker 2-3, 3-2
- Main rotary dial 2-3
- Main units 2-2
- Mains inlet 2-5, 3-9
- Mains supply connector incl. fuses F11 and F12 2-4
- Memory types 3-2
- Menu flowchart 5-9
- Menu key 5-9
- Module unit 2-4, 3-9
- Monitor 2-7
- Non-volatile memory 3-2
- Nozzle units for the gas modules 7-3
- O₂ cell 2-6, 3-4
- On/Off switch 2-3
- Option upgrade 5-2
- Optional connector 2-4
- Optional equipment 2-2
- Optional PC board slots 3-10
- Panel 2-7
- Patient Unit 2-2, 2-4, 3-3, 4-4
- PC 1770 Main back-plane 2-5, 3-7, 4-5
- PC 1771 Control 2-5, 3-8, 4-5
- PC 1772 Monitoring 2-5, 3-8, 4-5
- PC 1775 Plug-and-Play back-plane 2-5, 3-9
- PC 1777 Panel 2-3, 3-2, 4-3
- PC 1778 Standard connectors & DC/DC 2-5, 3-9
- PC 1780 Pneumatic back-plane 2-5, 3-5, 4-6
- PC 1781 Expiratory pressure transducer 2-5, 3-7
- PC 1781 Inspiratory pressure transducer 2-5, 3-7
- PC 1784 Expiratory channel 2-5, 3-8, 4-5
- PC 1785 Expiratory channel connector 3-7
- PC Card slot 2-3
- Power supply 3-9
- Preparations, disassembling and assembling 4-2
- Pressure transducers 3-7
- Pre-use check 6-3
- Preventive maintenance-kit 7-3
- RAM 3-2
- Replacing PC boards 4-2
- Safety inspection 7-9
- Safety valve 2-6, 3-5
- Safety valve pull magnet 4-6
- Serial number label 2-4
- Serial port (RS 232) 2-4
- Software information 5-2
- Software installation 5-2
- Software structure 2-7
- Standard connectors 9-2
- System ID 2-7
- System software update 5-2
- Technical error codes 6-7
- Temperature sensor 2-6, 3-4
- Threadlocking adhesives 4-2
- Tightening torque 4-2
- User Interface 2-2, 2-3, 3-2, 4-3, 7-7
- User Interface controls 3-2

9. Diagrams

| | |
|--------------------------------------|-------|
| Standard connectors | 9 - 2 |
| Functional Main Blocks diagram | 9 - 3 |

Standard connectors

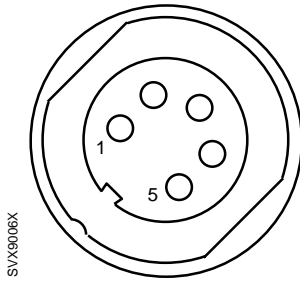

N26 – External +12 V DC supply input

1. +12V_UNREG_EXT_DC
2. +12V_UNREG_EXT_DC
3. –
4. GND
5. GND

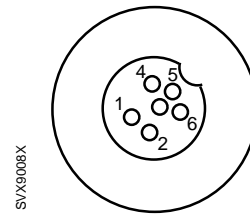

N28 / N70 – Control cable

1. +12V_UNREG_PANEL
2. GND
3. LED_CONTROL
4. ON_OFF_CONTROL
5. CAN_PANEL.H
6. CAN_PANEL.L

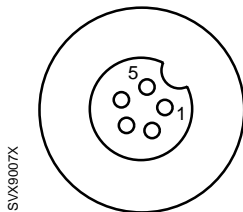

N27 – Optional equipment

1. GND
2. DISABLE_VALVES_EXT.L
3. CAN_EXPANSION.H
4. CAN_EXPANSION.L
5. +12V_UNREG_EXPANSION

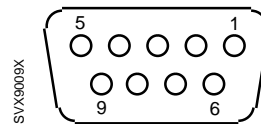

N29 – RS232

1. –
2. CI_RDX_ISO
3. CI_TDX_ISO
4. CI_DTR_ISO
5. GND_ISO
6. –
7. –
8. –
9. –

Functional Main Blocks diagram

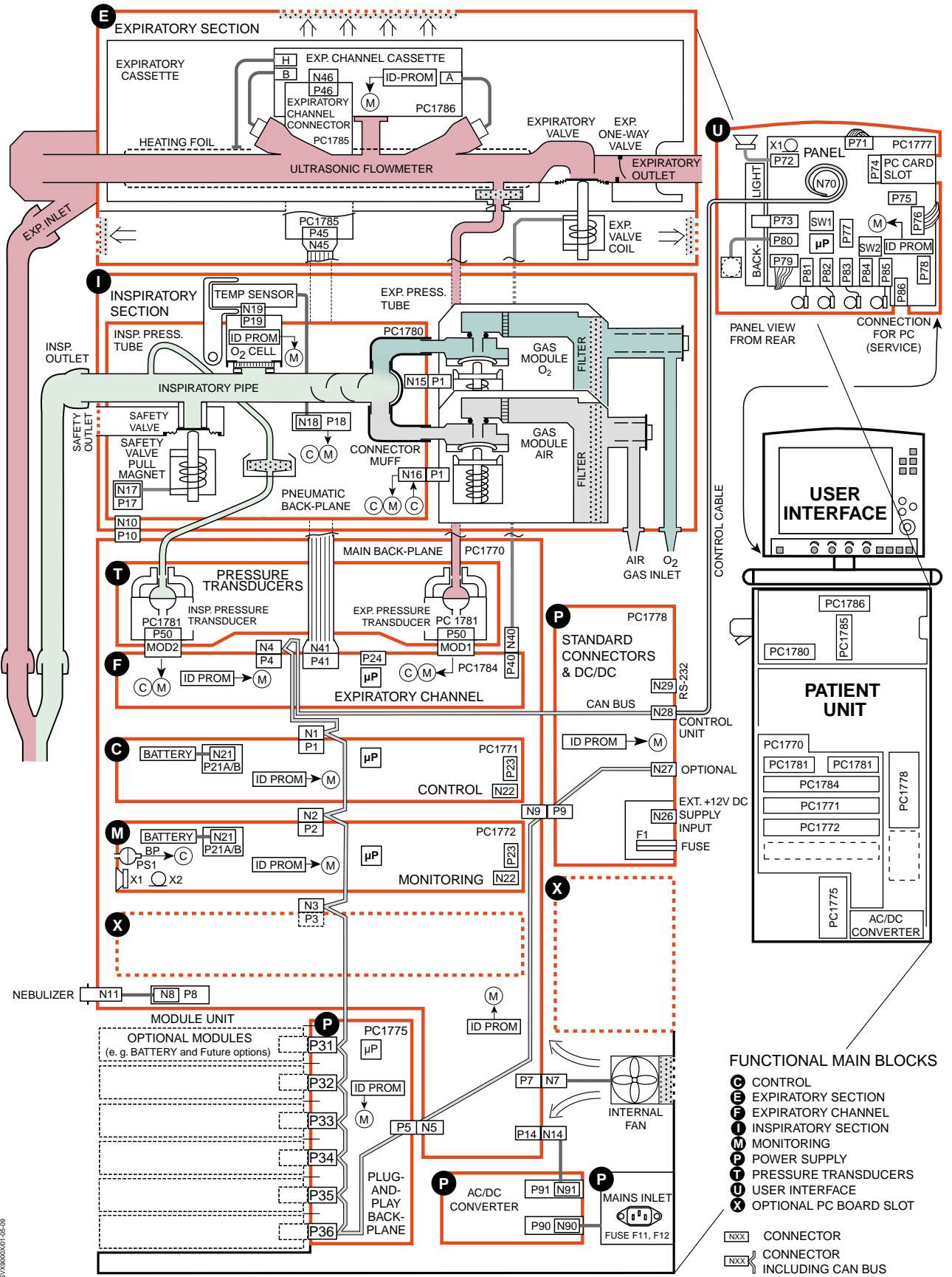

Servo^t – Service Manual
Order No.: 65 43 230 E407E

E382 E407E 061 01 01 02

© Siemens-Elema AB, Electromedical Systems Division, 2001. All rights reserved. No part of this publication may be reproduced, stored in a retrieval system, or transmitted in any form or by any means, electronic, mechanical, photocopying, recording, or otherwise, without the prior permission of the copyright owner in writing.
Subject to alterations without prior notice.
Issued by Siemens-Elema AB, Electromedical Systems Division, SE-171 95 Solna, Sweden.

Printed in Sweden
Price group: 7
0501 0.5
1st English edition,
May 2001