

Low-voltage a.c. amplifier

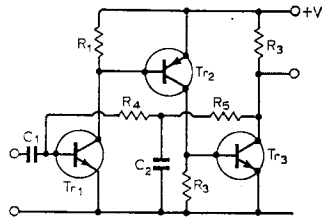

Typical performance
 R_1 100k Ω , R_2 22k Ω
 R_3 4.7k Ω , R_4 , R_5 470k Ω
 C_1 , C_2 10 μ F
 Tr_1 , Tr_3 BC125
 Tr_2 BC126
 Supply +1.5V
 Voltage gain 2100
 Output impedance 3k Ω

Input impedance 150k Ω
 (all at 1kHz)
 With $R_1 = pR_2$, $R_2 = pR_3$ etc.
 and with equal h_{fe}
 Voltage gain $\approx \frac{20h_{fe}}{h_{fe} + 20p}$
 ignoring h_{oe} , h_{re} effects.

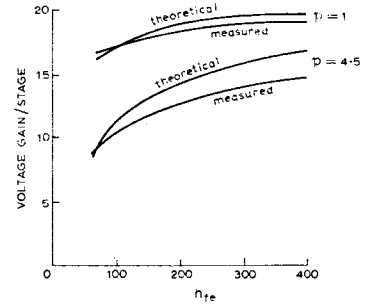

Circuit description

At very low supply voltages the base-emitter p.d. of each transistor becomes the limiting factor. For silicon this p.d. is around 0.6V and design is difficult at supply voltages below 1V. This circuit operates from single cells (mercury, Ni-Cd or dry cells) down to 1.0V though the gain increases at higher voltages. In a directly-coupled n-p-n amplifier the p.d. across each collector load is supply dependent as the p.d. is the difference between supply voltage and the V_{be} of the following transistor. This results in varying collector current for each transistor, and hence a large variation in gain is possible.

Here, the current in Tr_1 is determined by the p.d. across R_1 which is in turn fixed by the V_{be} requirements of Tr_2 . The V_{be} of a silicon transistor has a typical variation of <10% for normal ambient temperature, supply and tolerance effects and so Tr_1 current is well-defined. The same argument applies to Tr_2 current in terms of Tr_3 V_{be} . In each case a further

advantage of this circuit is that the voltage gain of each stage can be made to depend largely on the well-defined exponential V_{be} characteristics, rather than the widely varying h_{fe} . As h_{fe} increases so does the input impedance of a common emitter stage operating at constant emitter current. Where the transistor is fed from a relatively low impedance there is a corresponding fall in base current helping to offset the increase in current gain. A compromise is reached between the two extremes of (a) equal resistors throughout, wasting power in the earlier stages with relatively low input impedance and current gain but high voltage gain and (b) current levels increasing progressively from input to output, maximizing the input impedance and current gain but with lower voltage gain that is more dependent on h_{fe} .

Low-voltage astable circuit

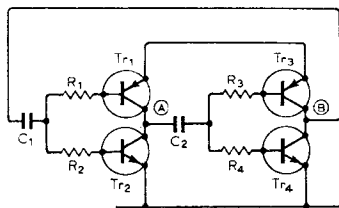

Typical performance ▶
 Tr_1 , Tr_3 BC126
 Tr_2 , Tr_4 BC125
 R_1 to R_4 1k Ω
 C_1 , C_2 10nF
 Supply 1.2V
 f 14.1kHz
 R_L (A-B) 470 Ω

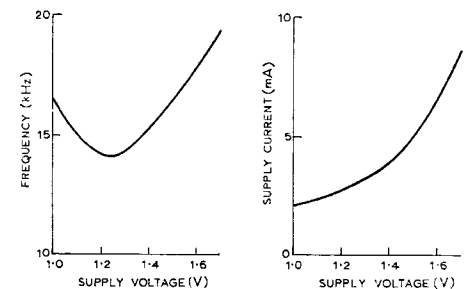

Circuit description

The conventional two-transistor astable circuit is difficult to design for very low voltages. The collector load resistance places a severe limit on the current that can be delivered to an external load. In addition, the rise-time of the output waveform, being controlled by the passive components, is much greater than the fall-time, while the rise-time improvement methods that have been devised are not readily applicable as they introduce additional diode drops. The circuit shown is a complementary astable that can operate to as low as 1V using silicon transistors, has equal rise and fall times and gives an output voltage swing almost equal to the supply voltage. It is thus ideally suited for dc to dc convertors and has high efficiency, because of the low standby power and the high utilization of the very low supply voltage. If the voltage exceeds 1.5V the advantages are lost and the current increases sharply. Frequency and mark-space ratios are most easily controlled by C_1 , C_2 while the resistance

values can be raised if the load resistance is high. Using germanium transistors the minimum and maximum supply voltages are more than halved. Leakage currents prevent the use of germanium transistors at very low current, but good efficiency is possible at higher currents.

Component changes

Tr_1 , Tr_3 : Any p-n-p silicon transistor for given supply voltage range. For higher currents use BFR81.
 Tr_2 , Tr_4 : n-p-n, otherwise as above (BFR41). For lower supply voltages substitute germanium complementary pairs 2N1302/03 or 2N1304/05.
 R_1 to R_4 : 100 Ω to 100k Ω . Use lower values with high current transistors and low load resistance. High resistance minimizes off-load current but suitable for high load resistances.
 C_1 , C_2 : 100pF to 100 μ F depending on frequency required. At high frequencies charge storage effects increase no-load current.

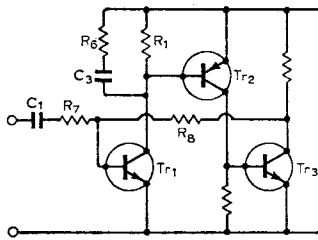

Component changes

Tr_1 , Tr_3 can be n-p-n small-signal transistor, particularly those with high current gain at low currents e.g. 2N2484, BC109, etc.

Tr_2 : p-n-p complement to above.

R_1 , R_2 , R_3 : see circuit description for ratios. Resistor R_3 determines output current ($\approx V_+/2R_3$), and R_1 indirectly the input current ($\approx V_{be}/h_{fe}R_1$). R_1 : 4.7 to 470k Ω , R_2 : 4.7 to 100k Ω ; R_3 : 1 to 47k Ω .

R_4 , R_5 should be $<10R_1$ if Tr_1 base current is not to develop too large a p.d. across R_4 , R_5 pushing output voltage towards $+V$.

C_1 , C_2 determine lower frequency cut-off. Capacitor C_2 decouples negative feedback, gives rise to inductive term in input impedance at low frequencies. C_1 , C_2 : 0.1 to 500 μ F.

Supply: circuit operates down to 1.0V with reasonable gain, to 0.85V with reduced gain and output swing. Upper limit set by transistor V_{ce} ratings—increase R_3 to limit Tr_3 current.

Circuit modifications

- Negative feedback can be used to control gain, define

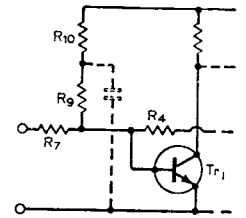
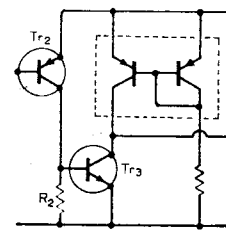

input impedance, lower output impedance. Phase shift over three stages allows oscillation unless $R_8 \gg R_7$ when n.f.b. may be too small to be of value. Feedback can be increased if dominant CR lag (R_6 , C_3) cuts gain before phase shift reaches 180° . Resistor $\approx 0.1R_1$ to $0.01R_1$. C_3 R_1 time constant sets open-loop 3-dB point—may need to bring upper 3-dB point down to <100 Hz on open-loop for stability with heavy feedback.

- Output swing can be increased by replacing R_3 by constant-current load provided by current mirror.
- Direct-coupling possible to sources with near-zero direct voltage if R_9 , R_{10} chosen in conjunction with R_7 (typically $R_9 + R_{10} \approx R_7$ for supply of 1.0V). Decoupling required if supply impedance is significant.

Further reading

Meindl, J. D., & Hudson, P. H., Low-power linear circuits, *IEEE J. Solid-State Circuits*, vol. 1, 1966, pp. 100–11.

Meindl, J. D., *Micropower Circuits*, Wiley, 1969, pp. 45–50 & 67–81.

Grebene, A. B., *Analog Integrated Circuit Design*, Van Nostrand, 1972, pp. 255–60.

© 1973 IPC Business Press Ltd.

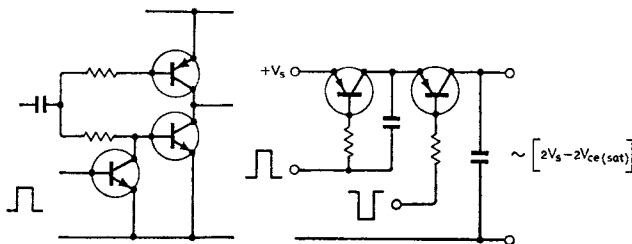

Circuit modifications

- By adding Tr_5 , which may be an n-p-n device fed with a positive-going pulse with respect to the zero line or a p-n-p device driven negative with respect to positive line, the circuit may be either inhibited if the pulse is of long duration or synchronized if the pulse is of short duration and repetitive.

● The circuit is ideally suited to dc-dc convertor applications and efficiency can be high. One possible configuration is shown making use of antiphase outputs of the oscillator to switch transistors in and out of conduction.

● As with other dual inverter astables, alternative circuits can be produced (see series 1 cards in which a single capacitor controls both parts of the cycle. One output waveform A is

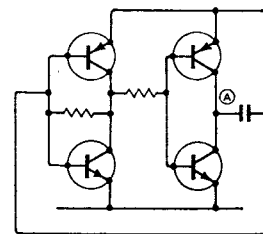

normally distorted by the unbalanced loading. As shown, the upper voltage limit is restricted to $\approx 1.2V$.

Further reading

Poirier, N., Cochrun, B. L., *et al*, Unique hybrid transformerless dc-to-dc converter suitable for biomedical applications, *IEEE International Solid-state Circuits Conference Digest* 1971, pp. 110/1.

Ho, C.f., Zero quiescent current monostable multivibrator, *Radio and Electronic Engineer*, 1969, pp. 22–4.

Cross references

Series 10, cards 4 & 8.

Low-voltage regulators

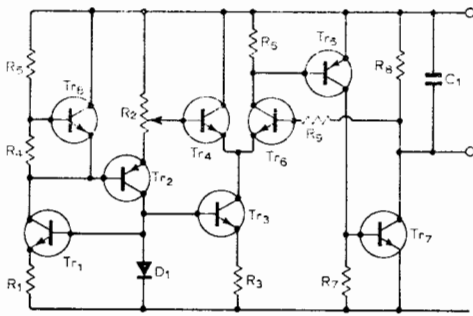

Typical performance

- R_1, R_2, R_3 1k Ω
- R_4 12k Ω
- R_5, R_6 3.3k Ω
- R_7, R_8, R_9 1k Ω
- C_1 100 μ F
- Tr_1, Tr_3 2N1302
- Tr_2 2N1303
- Tr_4, Tr_5, Tr_8 B2125
- Tr_6 BC126
- Tr_7 MJE521
- Supply 2V
- R_L 2 Ω
- V_L 400mV
- Output res. 0.01 Ω
- For $\Delta V_S/R_L \pm 20\%$,
- $\Delta R_L/R_L \pm 20\%$,
- $\Delta V_L/V_L \approx \pm 0.5\%$

Circuit description

This circuit is relatively complex because the problems of voltage regulation at very low voltages are severe. Transistors Tr_1, Tr_2 form a low-voltage ring-of-two reference (see series 6 card 9) providing the dual function of a variable temperature-stabilized reference voltage for the base of Tr_4 , with a bias voltage for Tr_3 . This latter provides a constant current for the long-tailed pair Tr_4, Tr_5 , which compare the reference voltage with the regulator output. Transistors Tr_6, Tr_7 amplify

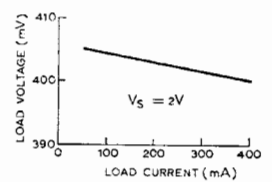
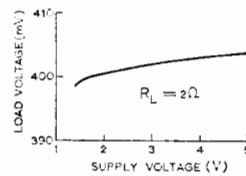

any imbalance controlling the output. It is important that the output transistor operates in common-emitter to minimize the wasted p.d. For low $V_{ce(sat)}$ -transistors the regulated output can be maintained for supply voltages down to a few tens of millivolts above the required output. Choice of reference circuit limits the minimum supply voltage; if D_1, Tr_1, Tr_3 are replaced by a current mirror (series 6 card 4) supply voltages down to 1V can be accommodated. At slightly higher supply voltages a monolithic micropower op-amp may be used with one or more addition at output transistors to increase the current capabilities. In principle circuits such as this are able to operate at supply voltages up to the breakdown voltages of the transistors as each stage is designed to work at a current that is largely independent of the supply voltage. The circuit as shown is capable of handling relatively large currents but may be used at currents down to <1mA if required.

Optical link with low standby power

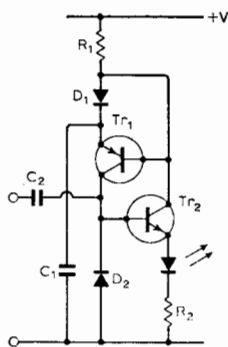

Circuit description

One method for minimizing power in systems is to have as many circuits as possible working close to zero quiescent current, conducting only on the appearance of some signal it is desired to detect. For example, the c.m.o.s. Schmitt trigger of series 2 has virtually zero quiescent current but can deliver a sharp transition to a load or hold that load on until the disappearance of the signal. The present circuit uses complementary bipolar transistors with D_1 holding the circuit in the non-conducting state and with C_1 storing charge. On receipt of a positive-going transition Tr_2 begins to conduct, pulling the base potential of Tr_1 below the emitter potential as stored on C_1 . The cumulative increase in current in Tr_1

Typical performance

- R_1 47 Ω, R_2 10 Ω
- R_2, C_1 470nF, C_2 2.2nF
- D_1, D_2 1N914
- Tr_1 , BC126
- Tr_2 BC125
- Supply +10V, 5.4mA
- f 1kHz
- Standby current <0.1 μ A

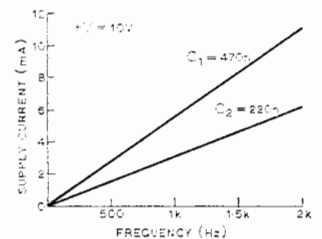

and Tr_2 discharges C_1 (with D_1 reverse-biased) through the transistors and the l.e.d. The short duration pulse may be at a relatively high current ensuring high intensity from the l.e.d., without excessive mean dissipation. After C_1 has discharged to the level at which Tr_1, Tr_2 come out of conduction it is recharged through D_1, R_1 and is ready to detect the next positive transition. D_2 absorbs the intervening negative transition. The charge lost by C_1 is $C_1 V$ for each pulse and with a repetition frequency f , the supply current is around $f C_1 V$ (V is the supply voltage).

Component changes

- R_1 : This limits rate of recharge of C_1 and hence recovery time. Typically 39 to 150 Ω with higher value better at low repetition rates.
- R_2 : Limits peak current in l.e.d. may be lowered to 3 Ω for l.e.d.s capable of >1A peak current. If high intensity not required may be increased to >100 Ω .

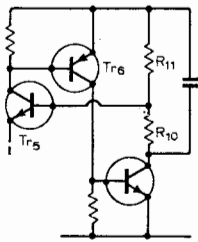

Component changes

R_{1-3} , R_{7-9} : Not critical but should be comparable in value and depend on output current required. Typical range 330Ω to $2.2k\Omega$.

R_4 , R_5 : Ratio used to adjust temperature coefficient of reference voltage. Keep ratio R_5/R_4 low to minimize supply voltage e.g. $R_5 \rightarrow 0$, $R_4 \infty$ leading to temperature drift of $+0.1\%$ deg. C.

Tr_{1-3} : Must be germanium for these low voltages. Any general-purpose complementary germanium transistors with Tr_4 , Tr_5 at equal temperature for low drift.

$Tr_{4,5,6}$, Tr_8 : General-purpose silicon e.g. 2N2926, ME4103 for n-p-n; ME0413, 2N3702 for p-n-p.

Tr_7 : High current n-p-n for low saturation voltage; voltage rating unimportant.

C_1 : $> 10\mu F$.

D_1 : General-purpose silicon diode.

Circuit modifications

● For output voltages greater than the reference voltage, the reference is compared with a fraction of the output i.e.

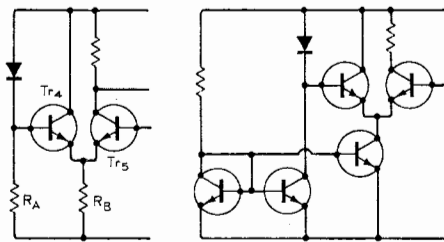

$V_1 = (R_{10}/R_{11} + 1)V_{ref}$. Generally the reference voltage must be significantly less than the minimum supply voltage, so that the current in the reference element may be sustained with some accuracy. The output may need to be close to the supply minimum.

● The circuit may be simplified where the output is required to have a negative temperature coefficient, as for card 9. It becomes more susceptible to supply changes but by returning R_A (and R_B if possible) to the stabilized line.

● An alternative method for improving stability against supply variations while minimizing the required supply voltage, is to use matched transistors to form current mirrors, defining both the reference current and that for the long-tailed pair.

Further reading

Widlar, R. J., New developments in i.c. voltage regulators, *IEEE I.S.S.C. Digest*, 1970, pp. 158/9.

Williams, P., D.C. regulator for low voltages, *Electronic Engineering*, March 1970, pp. 41-3.

© 1973 IPC Business Press Ltd.

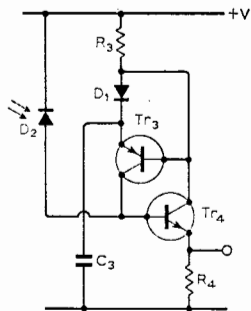

D_1 , D_2 : Not critical, any general-purpose Si diode, though high-speed preferable for short pulses.

Tr_1 , Tr_2 : Complementary n-p-n/p-n-p silicon transistors. Parameters not critical but peak current rating must be sufficient for required i.e.d. peak current.

Supply: $+5$ to $+20V$. At low voltages, high-intensity light pulses difficult to achieve.

L.e.d.: Any low-cost l.e.d. may be used, but optical coupling between l.e.d. and detector must be good, as light intensity is relatively low and spectrum differs from that of standard silicon photodetectors. Alternatives include infra-red emitters (TIL31/32 etc.).

Circuit modifications

● An identical circuit may be used as the detector, again with monostable characteristics, such that an output pulse is delivered to a load on receipt of a short duration optical pulse. Detector and l.e.d. may be optically linked by light fibres, but R_3 , R_4 may have to be one or more orders of magnitude higher than R_1 , R_2 with inefficient coupling.

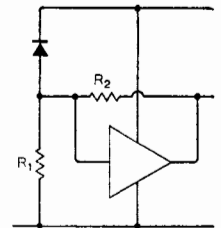
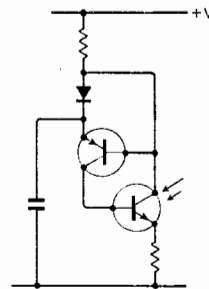

● Alternatively a phototransistor may replace Tr_4 and the photodiode D_2 (above). This applies equally if the l.e.d. and phototransistor form an opto-isolator. Standby current remains low in each of these circuits.

● The low-power characteristics of c.m.o.s. provide an alternative solution. Using one non-inverting buffer (or two inverters) with positive feedback through R_2 a Schmitt trigger action is obtained as on Circards series 2 card 3. Sensitivity is set by R_1 , hysteresis by the ratio of R_2/R_1 and the output has good rise- and fall-times for operating following circuits.

Further reading

Van der Geer, C. A. J., Optical-trigger-link scheme minimizes stand by power, *Electronic Design*, ref. 18, 2 september 1972, p. 62.

Cross references

Series 9, cards 3, 4 & 11.

© 1973 IPC Business Press Ltd.

Signal-powered circuits

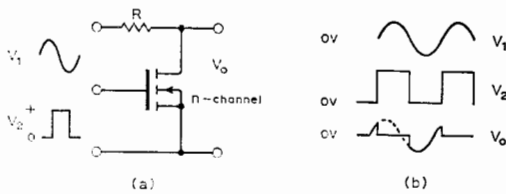

Circuit description—1

Chopper circuits, phase detectors and wave-shaping circuits are among the types that can be designed without a separate d.c. supply. They are not intrinsically micropower circuits though they can be, but are useful in locations where the provision of a separate supply voltage is difficult. Any amplifying device (bipolar, j.f.e.t. or m.o.s.f.e.t.) can be switched into and out of its conducting state by application of a square/rectangular waveform to its control electrode. An enhancement-mode m.o.s.f.e.t. can be driven from near open-circuit down to an on-resistance $\ll 1k\Omega$ by a square-wave applied to its gate. When fed via resistor R with a sine-wave of the same frequency, the output appears only for $V_2 \neq 0$, $V_1 \neq 0$. Applying this output to a high-impedance meter, e.g. a sensitive moving-coil instrument, gives a mean reading dependent on the phase-difference of the signals. It is also proportional to the amplitude of V_1 which needs to be controlled if the output is to indicate phase difference accurately (see circuit 4). The m.o.s.f.e.t. may be a single device from an existing c.m.o.s. i.c. such as CD4007.

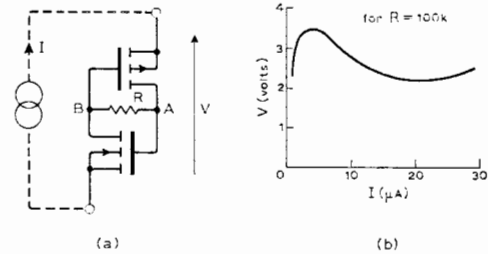

Circuit description—2

Devices may be combined to give non-linear V/I characteristics which may be used for wave-shaping. A particular example is the generation of a controlled negative-resistance region. This may be used in both astable and sinusoidal oscillators as well as in amplifiers. The major difficulty is the accurate control of the slope and end-points of the negative resistance region. In the circuit shown, the use of enhancement-mode m.o.s.f.e.t.s (again from CD4007 or similar for economy) ensures that gate-current effects can be ignored even where negative resistance is required at micropower levels. At low currents the total p.d. is of the order of the sum of the device threshold voltages ($\approx 3.4V$), while at higher currents this is reduced by the resulting p.d. developed across R. Similar circuits using bipolar transistors have been developed which can also operate without a separate power supply provided they are embedded in a system that can bias them into the negative-resistance region.

Micropower d.c. amplifier

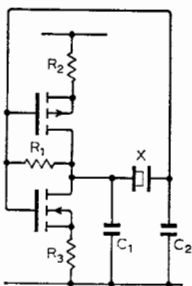

Circuit description

High-frequency oscillators present particular problems at low currents and voltages. In general, the gain of the active device falls, while the shunt reactance of stray capacitance becomes more important as the load impedance has to rise to maximize the gain at low currents. For the best frequency stability quartz crystal oscillators are obligatory and a convenient configuration is a π -network containing the crystal and two capacitors, interconnected with an amplifier having high input and output impedances. A c.m.o.s. inverter meets the requirements for the amplifier, particularly with resistors R_2 , R_3 providing series-derived series-applied negative feedback. The loading on the π -network is controlled by R_1 and the voltage gain of the inverter via the Blumlein (Miller) effect. The quiescent current is very low, limited further by R_2 , R_3 , and at low frequencies the current necessary to charge and

Typical performance

IC $1/3 \times CD4007AE$
 R_1 $15M\Omega$
 R_2, R_3 $100k\Omega$
 C_1 $15pF$, C_2 $10pF$
 Crystal $256kHz$ nom.
 Supply $+5V$, $2.8\mu A$

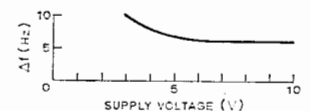
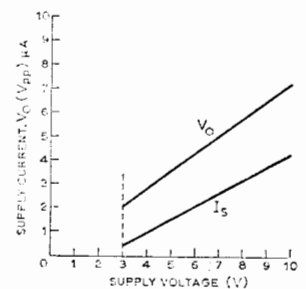

discharge the capacitors is minimal. At higher frequencies this effect dominates and the consumption becomes an almost linear function of frequency. Fine trimming of frequency is achieved by varying C_1 , and while the precise temperature coefficient is thereby adjusted the effect is dominated by the cut of the crystal in use. Where high stability is not required C_1 and C_2 may be omitted with oscillation being dependent on the presence of stray/circuit capacitance. The data is based on an industrial grade i.c., but specially developed circuits are available for supply voltages down to 1.5V or less.

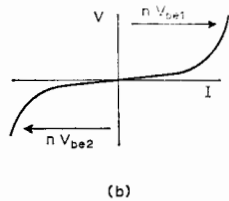
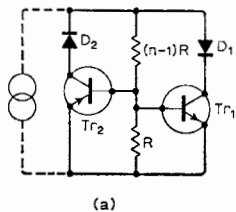

Circuit description—3

Other non-linear devices have application to a.c. systems, where it is required for example to change a sinusoidal waveform into an approximate square-wave without providing a d.c. supply to the shaping device. Simple passive components such as zener diodes offer one solution, but circuits such as the "amplified-diode", current-mirror may be used, if complementary-pairs of transistors are used. As shown, Tr_1 conducts for positive currents with the terminal p.d. being an amplified version of its V_{be} . The potential divider resistances are a compromise, minimizing current flow at low-terminal p.d.s while avoiding excessive loading by base currents at higher levels. Diodes D_1 and D_2 prevent conduction via the collector-base paths of Tr_1 , Tr_2 respectively when the applied polarity is that intended to bring the other device into conduction. The complete circuit approximates to a two-terminal a.c. zener of variable breakdown voltage, though with limited accuracy.

Circuit description—4

If a low-impedance alternating voltage is available in a system it can be used to provide a low-power d.c. supply via a voltage doubler such as that formed by C_1 , D_1 , D_2 and smoothed by C_3 . The voltage may then be processed in any way desired

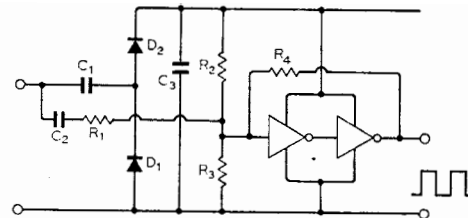

provided that the circuit used to do this can operate from this supply voltage while consuming the minimum power. The example shows a pair of inverters (as in card 10) connected as a Schmitt trigger circuit, giving an output square-wave whose amplitude could be stabilized if the supply voltage is large enough to be fed via a zener diode or other voltage regulator. Similarly micropower op-amps can be used in any of their normal measurement or signal-processing configurations. A second voltage-doubler giving a negative supply voltage may be required.

Further reading

Worstell, G., Phase-lock detector requires no external power supply, in 400 Ideas for Design, Hayden vol. 2, 1971, p. 223. Williams, P., The Amplified Diode, *Design Electronics*, Jan. 1968, pp. 26-9. Hart, B. L. & Barker, R. W. J., Minimum-power waveform generation circuit technique, *Electronics Letters*, vol. 8, pp. 585/6. Grothe, L. E., Sine-to square-wave converter is self-powered, in 400 Ideas for Design, Hayden vol. 2, 1971, p. 78.

Cross references

Series 10, cards 3, 7 & 10.

© 1973 IPC Business Press Ltd.

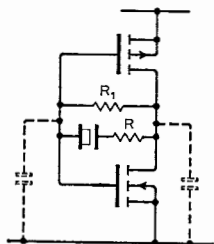

Component changes

R_2 , R_3 : should be equal. Max. value 470k Ω ; minimizes current drain, makes circuit more critical of loading, applicable only at frequencies \ll 1MHz. Can be reduced to zero with waveform distortion, frequency shift, higher current.

R_1 : not critical. Determines bias voltage condition but input current >0 so R_1 may be very large. Lowering R_1 to 10 to 100k Ω controls amplitude of oscillation at expense of loading π -network.

C_1 , C_2 : 1 to 100pF. Varies considerably with crystal used; may be eliminated if stability not critical and significant strays present. Varying C_1 gives fine frequency control for optimum stability.

Crystal: Oscillators possible from <100 kHz to >2.5 MHz. Reduced amplitude at high frequencies. If R_2 , R_3 too low, second or higher harmonic may be excited. Use passive LC circuit to select fundamental/harmonic.

Supply: As low as 3V with CD4007AC, down to 1.1V with TA6178 development type.

Circuit modifications

● The simplest circuit eliminates R_2 , R_3 retaining R_1 for bias with possibly a series resistor R to control the amplitude of

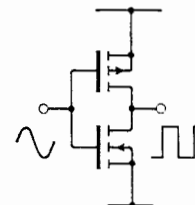
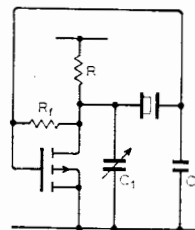

oscillation. Amplifier characteristics are no longer controlled by series negative feedback and performance is not as good. As before stray capacitance may be sufficient to allow oscillation, but not recommended for good stability.

● Still simpler circuits using a single m.o.s. inverter gives reasonable performance. Using depletion mode device, R_f may be replaced by gate resistor to ground with series resistor in source to limit gain.

● For coupling to following logic circuits a single inverter may suffice. At 5V and with total load capacitance of ≈ 20 pF, the current consumption at 250kHz is $\approx 60\mu$ A and rise and fall-times $\approx 0.3\mu$ s. For sharper transitions at low frequencies, replace single inverter by Schmitt trigger.

Further reading

Eaton, S. S., Timekeeping advances through c.o.s.m.o.s. technology, RCA application note ICAN-6086. Meindl, J. D., *Micropower Electronics*, Wiley, 1969, p. 94.

Cross references

Series 10, cards 2 & 8.

© 1973 IPC Business Press Ltd.

Micropower crystal oscillator

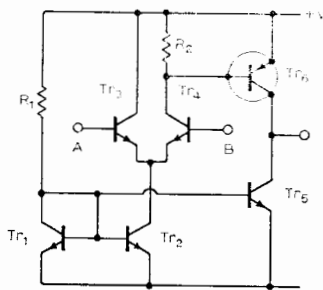

Typical performance
 Tr₁ to Tr₅ CA3046
 Tr₆ BC126
 R₁ ≈ 47kΩ (vary for minimum offset)
 Supply +1.5V
 Input current 0.13μA
 Common-mode range 0.8 to 1.3V used as voltage follower with A to output and B to input.

Circuit description

Monolithic i.c. micropower amplifiers are becoming increasingly available. They have performance comparable with conventional designs but at supply voltages down to ±1V and with currents presettable to very low values. For still lower voltages, to ±0.75V with restricted performance variants of the circuit shown may be used. Transistors Tr₁ to Tr₅ are from a general-purpose i.c. CA3046; Tr₁, Tr₂ and Tr₅ constitute a current mirror system that define the currents in the long-tailed pair Tr₃, Tr₄ and the output stage Tr₆ in terms of the current in R₁. At low supply voltages the p.d. across R₁ will be little greater than that across R₂ (≈0.6V) while R₂ should carry rather less current. Hence R₁ = R₂ is a reasonable compromise. The quiescent current in the output stage is low, and the circuit as it stands is suitable for use with grounded

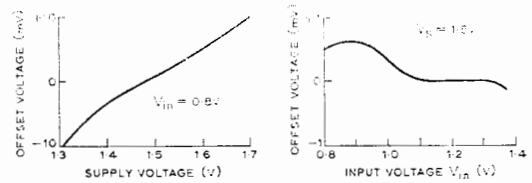

loads—with a centre tapped supply, the negative load current would be restricted to the quiescent current. This amplifier may be used as a d.c. amplifier, comparator, etc. just as a normal op-amp but with restricted performance. In particular, the loop gain parameters are such that with heavy feedback the frequency response is restricted by the compensation required to avoid oscillation. A second disadvantage is that there is no current regulation against supply voltage changes, though this is shared by some micropower op-amps. The amplifier is indicative of low-cost micropower design.

Component changes

Tr₃, Tr₄: Any matched pair of silicon n-p-n transistors—preferably on a single monolithic chip for best matching (at low currents).
 Tr₁, Tr₂, Tr₅: Matched triple as above. All five are conveniently available in i.c.s such as CA3045, CA3046. Alternatively, resistors inserted in emitters of Tr₁, Tr₂, Tr₅ dropping 50 to 500mV equalize and define currents at expense of increased minimum supply voltage.

Wireless World Circard Series 10: Micropower Circuits 8

RC oscillator for low voltages

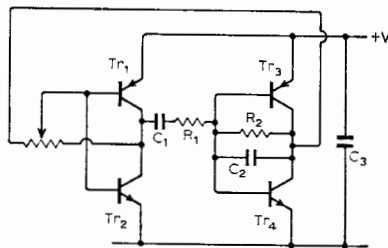

Typical performance

R₁ 4.7kΩ
 R₂, R 10kΩ
 C₁ 22nF, C₂ 10nF
 C₃ 100μF (optional)
 Tr₁, Tr₃ matched p-n-p pair from CA3084
 Tr₂, Tr₄ matched n-p-n pair from CA3046
 I_s 1mA
 R set for 0.4Vpk-pk at A
 f 1.77kHz

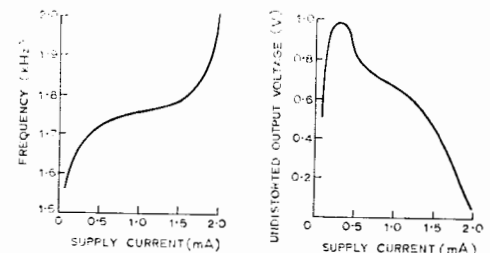

Circuit description

The same inverting stages are used as in the astable oscillator but they are now operated in the linear mode as with the output stage of the class B amplifier. Careful biasing is again necessary to minimize distortion without excessive quiescent current. This may be achieved by supplying from a voltage source having a negative temperature coefficient of ≈ -4mV/deg. C i.e. two p-n junctions. A novel alternative is possible for equal swings at A and B which for high gain transistors will result when R₁ = R₂/2, C₁ = 2C₂. Then R is centre tapped for oscillation to just commence. Under these conditions and with class A operation Tr₁, Tr₃ and Tr₂, Tr₄ can be considered as long-tailed pairs receiving antiphase signals and a constant-current supply can act as the "tail" i.e. this is a circuit that can work from either a constant voltage or a constant current source. The RC network is a Wien network, and finite gains in the transistors prevent the ideal balance

conditions applying, with some resulting distortion and a frequency of oscillation that departs from the ideal value $f = 1/(2\pi R_1 C_1 R_2 C_2)$. R is adjusted to sustain oscillations at the required amplitude.

With the circuit as described antiphase outputs are available at A and B which may also be used to drive a load connected between them.

Component changes

R₁, R₂: 100Ω to 100kΩ, R₁ = R₂/2.
 C₁, C₂: 1nF to 10μF, C₁ = 2C₂.
 Frequency of oscillation that can be sustained falls with falling current. Setting of R controls the onset of oscillation. R ≈ R₁.
 Tr₁ to Tr₄: Choice restricted to pairs from same monolithic chip or matched pairs kept at equal temperature.

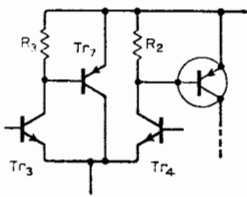

R_1, R_2 : These will be comparable in value, with R_1 increased at higher supply voltages such that the current in R_2 is $\frac{1}{2} \times$ current in R_1 .

Supply voltage range: May be as low as 1V with increased drift via R_1 . See Circards series 6, constant-current circuits.

Circuit modifications

- There are many complete i.cs appearing capable of operating down to $\pm 1V$ or less. These will give better performance than the simple circuit shown. The advantage of flexibility and even lower supply voltages can be enhanced by additional transistor(s) to improve equality of currents in Tr_3, Tr_4 . In circuit left Tr_7 absorbs much of the current from Tr_2 , leaving smaller and more nearly equal currents in R_2, R_3 and hence in Tr_3, Tr_4 .

- Middle circuit shows how a p-n-p current mirror may be used if matched pairs are available. Similar techniques are

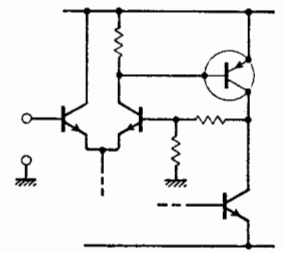
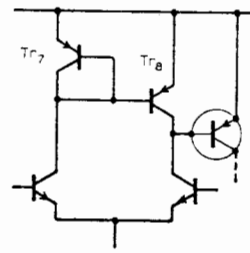

commonplace in the monolithic i.cs mentioned above. As Tr_7 and Tr_8 carry the same current, then provided Tr_8 base current remains small, so also must Tr_3 and Tr_4 .

- As with any other d.c. amplifier negative or positive feedback can be applied to define the gain or the hysteresis if used as a level sensing circuit (Circards series 2).

Further reading

Harden, W. R. & Hellstrom, M. J., Triple-channel micro-power operational amplifier, *IEEE J. Solid State Circuits*, vol. SC-4 1969, pp. 236-40.

Bittmann, C. A. *et al*, Technology for the design of low-power circuits, *IEEE J. Solid State Circuits*, vol. SC-5, 1970, pp. 29-37.

Cross references

Series 10, cards 1, 3 & 9.

© 1973 IPC Business Press Ltd.

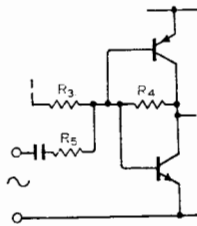
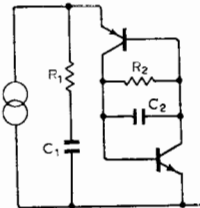
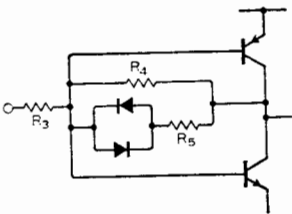

Circuit modifications

- By adding a non-linear network to the feedback path the loop gain may be reduced as the oscillation amplitude exceeds a given level. With the low supply voltage and current lamp/thermistor methods are inappropriate but germanium or Schottky diodes can be used. The non-linear transconductance of the transistors together with the collector-emitter saturation characteristics complicate the design.

- An alternative low-voltage oscillator uses a complementary pair as a unity negative-impedance-converter. To ensure oscillation $C_1 > 2C_2$ and $R_1 < R_2/2$. Fixing C_2 at $0.01\mu F$, C_1 at $0.022\mu F$ for example allows R_1 to be varied about $R_2/2$ as required. The supply is from a constant-current generator.

- As with other oscillators, by setting just below oscillation a band-pass filter can be obtained (see Circards series 1). The signal should be injected from a reasonably high impedance as the input point is an imperfect virtual earth in this particular case.

Further reading

Williams, P., Wien oscillators, *Wireless World*, Nov. 1971, pp. 541-7.

Hachtel, G. D., & Pepper, R. S., Synthesis of integrable nearly-sinusoidal potentially bistable oscillators, *IEEE Journal of Solid State Circuits*, vol. SC-1, 1966, pp. 111-17.

Cross references

Series 10, cards 1, 2 & 9.

© 1973 IPC Business Press Ltd.

Class B low-voltage amplifier

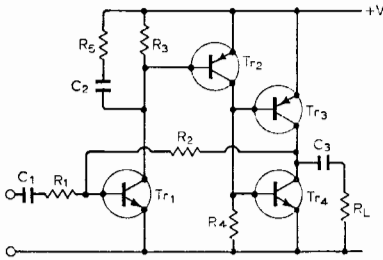

Typical performance
 R_1, R_2, R_3 100k Ω
 R_4 4.7k Ω , R_5 560 Ω
 C_1 1 μ F, C_2 3.6nF
 C_3 100 μ F
 Tr_1 BC125, Tr_2 BC126
 Tr_3 BFR81, Tr_4 BFR41

Supply 1.2V, 2.1mA
 R_L 100 Ω
 V_O 370mV r.m.s. (1kHz)
 Distortion 5%
 Efficiency 51%
 Quiescent power 0.43mW

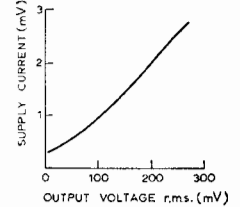
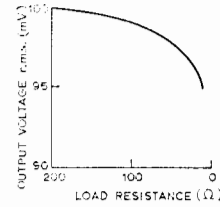

Circuit description

This circuit has strong similarities with the standard "complementary emitter-follower" output amplifiers used for audio systems. The difference is critical. By changing the output transistors into the common-emitter mode the output swing and efficiency at low supply voltages dramatically improve. This is because the output can swing to within $V_{ce(sat)}$ of each supply line while the common base drive voltage is small and restricted to the mid-supply region. With emitter follower output, saturation of the output transistors would require a base drive voltage extending by $\approx 0.6V$ above and below the supply lines i.e. an auxiliary supply would be needed. There remains a serious disadvantage to this form of circuit. For high efficiency class-B operation demands that the supply voltage be fixed at $2V_{be}$, and more particularly at a value of V_{be} that keeps the transistors just on the edge of

conduction. If higher crossover distortion is permissible supply voltages down to 1.1V are possible. Where the temperature and/or supply voltage is variable the circuit quiescent current may increase too greatly. One solution is to provide a simple voltage regulator whose temperature coefficient matches that of the transistor V_{be} 's (see card 3). The preceding stages are basically those of the amplifier of card 1 and the same constraints on feedback/compensation apply.

Component changes

Tr_1, Tr_2 : Any general-purpose n-p-n/p-n-p silicon planar transistors preferably with high h_{fe} at low currents.
 Tr_1 : ME4103, BC109, 2N2926, 2N930, 2N3707, etc.
 Tr_2 : ME0413, BC179, 2N2904 etc.
 Tr_3 : Low saturation voltage p-n-p: BFR80, BFR81 etc.

Low-voltage d.c. converter

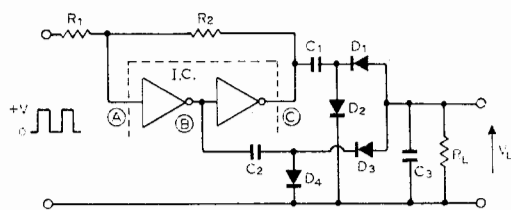

Typical performance
 R_1 470k Ω , R_2 1M Ω
 C_1, C_2, C_3 22 μ F
 IC $1/3 \times$ CD4009AE
 D_1 to D_4 bridge rectifier
 R_L 10k Ω
 f 100Hz
 Supply 5V
 V_L -3.8V
 Open-circuit current 1.6 μ A

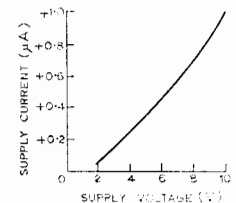
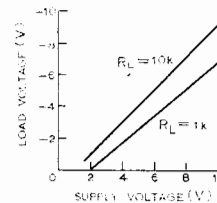

Circuit description

The circuit is used where a supply of given polarity is available, and a reverse polarity is required e.g. for biasing op-amps or m.o.s. logic circuitry. It simplifies the problems of battery operation by removing the need for a separate negative rail, but efficiency is a key parameter particularly for micropower operations and/or low supply voltages. Basically the circuit is related to the diode pump, with antiphase square waves generated at B and C, with R_1 and R_2 providing hysteresis to speed up the transitions and make them less dependent on input amplitude and wave shape. For micropower applications c.m.o.s. inverters are the obvious choice as standby power is minimal, with a high ratio of available loadpower to standby power.

As point B switches positive C_2 is charged via D_4 to a p.d. less than the supply voltage by one diode forward voltage.

When the B returns to zero, the output of C_2 tries to swing negative bringing D_3 into conduction and transferring charge from C_2 to C_3 . At low repetition rates the continuous loss of charge to R_2 prevents a significant accumulation of charge in C_3 . As the repetition rate increases (or C_3 increases) the p.d. across C_3 approaches a magnitude of $|V_s - 2V_f|$ where V_f is the forward voltage across each diode. Output polarity depends only on the diode configuration and not on the original supply voltage. By adding the inverted output at C and a second diode pump the output capability is increased and ripple reduced (equivalent to full-wave rectification). The output is unregulated but the drift is largely that due to the diode losses i.e. the output change is $\ll 1V$ for temperatures between say 20 and 50°C. Minimum supply voltage is dictated by that of the c.m.o.s. stages, and by the proportionally larger diode losses.

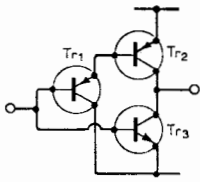

Tr_4 : Low saturation voltage n-p-n: BFR40, BFY50 etc.
 R_1, R_2 : Set gain and input impedance. Increasing R_2/R_1 increases gain, reduces feedback upsets output quiescent if taken too far. R_1, R_2, R_3 : 10 to 470k Ω .
 R_4 : Typically $R_3/5$ to $R_3/50$.
 C_1, C_3 : Standard input/output coupling. C_1 : 0.1 to 10 μ F, C_2 : 10 to 500 μ F.
 R_5, C_2 : Depends on open and closed-loop gains as well as transistor types. More complex CR networks necessary to maximize bandwidth and ensure stability.

Circuit modifications

- An alternative output stage applicable at slightly higher voltages has been published as the basis of a monolithic i.c. hearing aid amplifier. Tr_2 can only be produced in the standard i.c. as a "lateral" transistor, having low gain. Tr_1 having its collector to the most negative supply line i.e. a "vertical p-n-p" has higher gain, and the combination is a reasonable match to Tr_3 . Supply voltage required is raised to $\approx 1.5V$ compatible with single dry cells.
- Additional bias networks may be added (such as amplified diode) if of low dynamic resistance and/or suitably bypassed so that output bases receive some a.c. drive. These networks

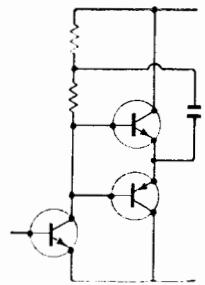
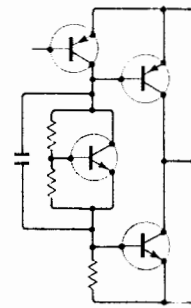

should ideally have a positive temperature coefficient, and to avoid excessive quiescent current under adverse conditions the bias may have to be set into the class C region with exaggerated crossover distortion prior to the application of feedback.

- Some improvement in the output capabilities for the emitter-follower output circuits can be obtained by bootstrapping the preceding collector load. This allows the base drive to be taken past the positive supply voltage and halves the wasted voltage.

Further reading

Getreu, I. E., Integrated class-B hearing-aid amplifier, *ISSCC Digest*, 1971, pp. 182/3.
 Meindl, J. D., *Micropower Circuits*, Wiley, 1969, pp. 59-61.

Cross references

Series 10, cards 1 & 8.

© 1973 IPC Business Press Ltd.

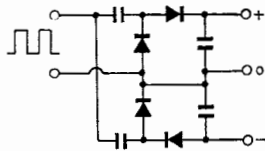

Component changes

Supply: +3 to +15V (for AE series)
 R_L : 470 Ω upwards
 D_{1-4} : Bridge rectifier or 4 \times 1N914, etc.
 R_1 : 10k Ω to 10M Ω .
 R_2 : 22k Ω to 22M Ω .
 C_1, C_2 : 100nF to 100 μ F.
 C_3 : 1 to 100 μ F.
 IC: Any c.m.o.s. containing 2 inverters (CD4009, CD4049) or nand/nor gates used as inverters (CD4001).
 f: 10Hz to 100kHz.
 At low values of R_L , the on-resistances of the m.o.s. devices within c.m.o.s. inverters limit output. Choose R_1, R_2 high to minimize standby current or with high load resistance. Too high values allow possibility of hum pickup. High frequencies simplify smoothing, allow lower C values, but increase standby current.

Circuit modifications

- Only one of the diode/capacitor networks need be used where max. output not required. If c.m.o.s. output already available in system only one inverter needed for full-wave system.
- Both positive and negative outputs can be obtained simultaneously, each approaching pk to pk input less diode

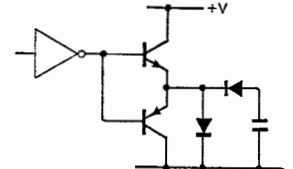
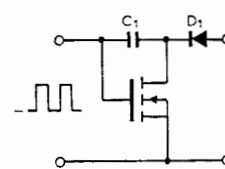

losses (Fig. 1). Similarly voltage multiplier circuits may be used to obtain increased voltage outputs, but method is difficult to apply as supply voltage becomes comparable with diode p.d.s. Germanium or Schottky-barrier diodes give smaller losses, increasing efficiency at low supply voltages.

- One diode may be replaced by n-channel enhancement mode m.o.s. device Fig. 2. For low on-resistance device, one diode-loss is eliminated. Method is not applicable to devices within normal c.m.o.s. package as these have in-built protection diodes which prevent negative output swings.
- Output currents can be increased by buffer stages such as emitter followers, but with increased voltage losses.

Further reading

Poirier, N., Unique hybrid transformerless d.c.-to-d.c. converter suitable for biomedical applications. *ISSCC Digest* 1971, pp. 110/1.
 Kauffman, R., Transformerless converter yields plus/minus voltages, in *400 Ideas for Design*, Hayden, 1971.

Cross references

Series 10, cards 2, 5 & 12.

© 1973 IPC Business Press Ltd.

Low-current use of diodes

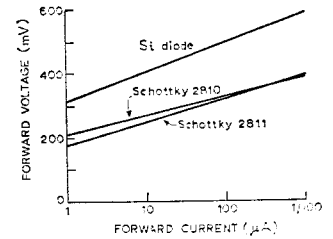
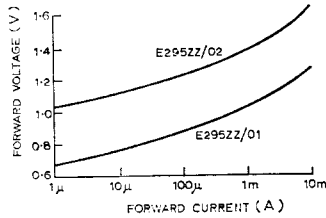

Zener diode

1. These are normally silicon diodes processed to have a reverse breakdown voltage in the range 2 to 100V (though most lie between 3V and 15V). In addition the base-emitter junction of silicon planar transistors have very sharp breakdown characteristics that make them suitable for micropower applications. Broadly the higher the breakdown the sharper the knee with a low slope resistance, together with a positive temperature coefficient of up to $+0.1\%/deg. C$. Low-voltage zeners have poor low-current stability and a temperature coefficient of $\approx -2mV/deg. C$. The second graph shows that those diodes breaking down in the 5 to 7V region may have positive or negative temperature drifts depending on current. Some planar transistors exhibit stable base-emitter breakdown characteristics at currents below $1\mu A$.

Schottky diode

2. A metal-semiconductor junction has a diode characteristic similar to that of silicon p-n junction, but for a given p.d. the current flow may be two orders of magnitude greater. While developed for their low charge-storage characteristics, this low p.d. makes them useful in low-voltage rectifiers and as temperature compensation elements. The p.d. is intermediate between Si and Ge diodes and the temperature drift comparable at $\approx -2mV/deg. C$, increasing in magnitude at lower current densities.

Wireless World Circard Series 10: Micropower Circuits 12

Micropower active devices

Operational amplifiers

It is difficult to define the operating currents of micropower op-amps by internal circuitry. It is advantageous to be able to control the currents by an external setting. Recent designs ($\mu A722$, UC4250, ICL8021C, CA3060) have internal currents controlled by a single external resistor. Quiescent current is the dominant factor in controlling many amplifier parameters; input bias currents, slew rate and output currents are broadly proportional to the quiescent current, while input and output impedances fall at higher currents though not as sharply.

The minimum level of supply voltage at which satisfactory performance is sustained is determined by the amplifier configuration, and supply voltages to $\pm 1V$ or even less may be used. Output voltage swing into high resistance loads is to within 0.7V of each supply line with types listed.

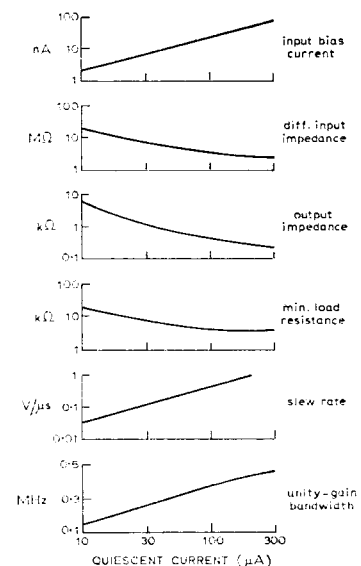

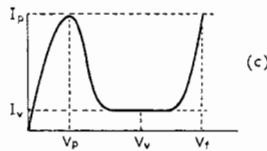
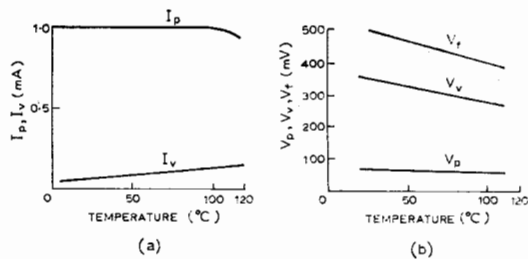

Tunnel diode

3. Tunnel diodes have a non-linear V/I characteristic with a pronounced negative resistance region. The voltage levels are low and currents may also be low. Because of their intrinsically high switching speed they are useful in applications where high-speed sensitive triggering is necessary. This is facilitated by the high temperature-stability possible for the peak-current, I_p (drift of $<1\%$ over a wide temperature range possible with selected devices). The ratio I_p/I_v worsens with temperature rise, reducing the output swing available when used as oscillator. Devices have been produced with I_p values below 1mA to above 100mA. Now a limited production device for special applications only.

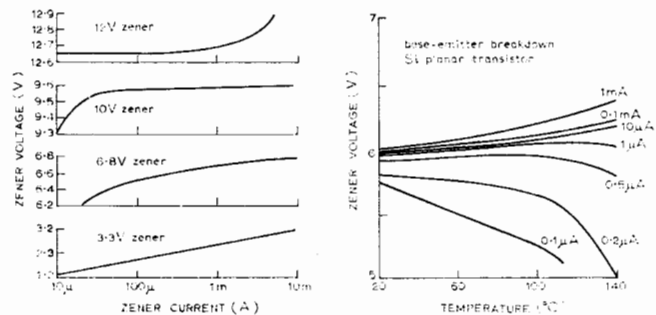

Assymmetric voltage-dependent resistor

4. Certain polycrystalline materials have non-linear V/I characteristics resulting in zener-like behaviour but with breakdown-voltage intermediate between silicon diodes and zener diodes i.e. in the region 0.6 to 1.6V depending on type and current. Temperature coefficient of the types shown is positive, but the devices are only specified for temperatures up to 40 to 50°C. Voltage stability even at currents below those for which the devices are specified is generally adequate for biasing transistors.

Further reading

Ferranti, Use of the base-emitter junction of the ZTX300 as a zener diode, E-Line Transistor Manual, 1969.
Preis Joachim, High-performance low-cost "active zener" regulators, *Wireless World*, vol. 1969, pp. 484-6.

Cross references

Series 10, cards 3, 5 & 12.

© 1973 IPC Business Press Ltd.

Silicon transistors

At low currents the relationship between V_{be} and I_c for fixed V_{ce} is very accurately defined for silicon planar transistors: $I_c = I_s \exp(qV_{be}/kT)$ where q is the charge on an electron, k Boltzmann's constant, and T the absolute temperature. The collector current increases tenfold for an increase in V_{be} of just short of 60mV at room temperature (doubling for collector current increases tenfold for an increase in V_{be} of $\approx +18mV$). The temperature drift in V_{be} is around $-2mV/deg$. C being greater in magnitude at lower values of V_{be} . Again the relationship is well defined and is given by $dV_{be}/dT = (V_{be} - 1.2)/T$. Hence transistors operating at the same V_{be} have the same temperature drift in V_{be} .

The current gain of a silicon planar transistor including those in monolithic integrated circuits is sustained to currents in the nA region though the frequency response tends to be inverse to the current because the capacitive element of the output/load is independent of current. Because the base current falls almost as rapidly as does collector current, the input resistance rises at low currents. While the current gain varies, the transconductance is defined by qI_c/kT .

The characteristics of germanium transistors are similar but the corresponding values of V_{be} are 300 to 500mV below those of silicon transistors operating at comparable currents. When the V_{be} s differ by $\approx 430mV$ the temperature drifts cancel. This is the basis of a number of low-voltage reference circuits for voltage regulators.

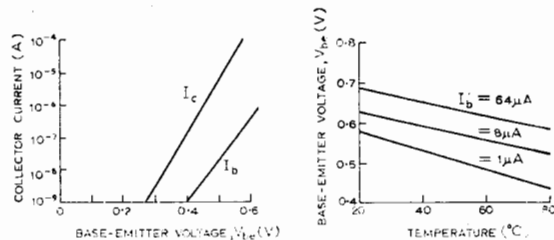

The collector saturation voltage of small-signal transistors at low currents varies widely but is within the range 10 to 200mV, and depends largely on the I_c/I_b ratio rather than the currents and temperature.

Further reading

Sah, Chik-Tang, Effect of surface recombination and channel on p-n junction and transistor characteristics, *IRE Trans. on Electron Devices*, 1962.
Wittlinger, H. A., Applications of the CA3080 and CA3080A high-performance operational transconductance amplifiers, RCA application note ICAN-6668.

Cross references

Series 10, cards 7 & 11.