

Constant-current use of voltage regulators

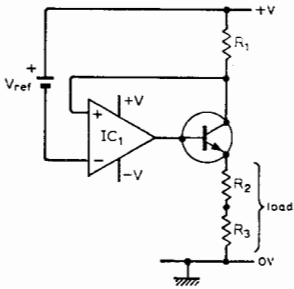

**Typical data**  
 Supply:  $\pm 15V$   
 IC<sub>1</sub>: 741; Tr<sub>1</sub>: BFR41  
 R<sub>1</sub>:  $1k\Omega \pm 5\%$   
 R<sub>2</sub>:  $680\Omega \pm 5\%$   
 R<sub>3</sub>:  $100\Omega \pm 0.05\%$   
 Maximum current: 8mA.  
 Note: Careful layout required to avoid r.f.

oscillation. Absolute measurement of current obtained using accurate digital voltmeter across R<sub>3</sub>. Variation of load current with reference supply shown opposite.

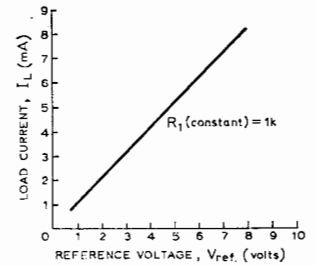

Circuit description

This circuit permits high currents through the load (R<sub>2</sub> + R<sub>3</sub> in series), depending on the current capability of the bipolar transistor used. Negative feedback is applied via the operational-amplifier IC<sub>1</sub>, the feedback being applied to the non-inverting terminal and being derived from the collector of transistor Tr<sub>1</sub>, where inversion has occurred. Load current is essentially defined by V<sub>ref</sub>/R<sub>1</sub>, because the potential difference between inverting and non-inverting inputs of the operational amplifier when the gain is high, is very small. This reference voltage, symbolised by an ideal battery, may simply be a reverse biased zener diode in series with a resistor connected across the d.c. supply, the inverting input being connected to the junction. This has the disadvantage of being uncompensated for temperature variations. If the zener diode has a positive temperature coefficient, this can be offset by con-

necting a forward-biased silicon diode with a negative temperature coefficient in series. Such a combination is available in a single package to provide a temperature-compensated zener diode.

If the current through R<sub>1</sub> increases, the potential difference across R<sub>1</sub> increases, and the voltage applied at the non-inverting terminal decreases. This change is amplified by the operational-amplifier, and hence the base drive to Tr<sub>1</sub> is reduced, tending to compensate the original increase of the collector current which is approximately equal to the load current. As the gain of IC<sub>1</sub> is high, the input current demanded by this operational amplifier is extremely small, and the feedback also increases the effective output impedance of Tr<sub>1</sub>.

Hybrid constant-current circuit

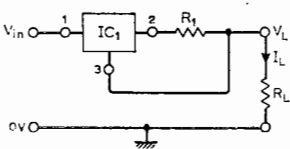

**Typical data**  
 V<sub>IN</sub>: +15V  
 V<sub>L</sub>: 3V  
 IC: LM309H  
 R<sub>1</sub>:  $245\Omega \pm 1\%$   
 R<sub>L</sub>:  $120\Omega \pm 5\%$   
 I<sub>L</sub>: 25mA

For 1.5V pk-pk input ripple at 100Hz, load current ripple is approx. 16μA pk-pk.  
 Dynamic output res: 90kΩ

Dynamic to static output resistance ratio:  $\approx 220$   
 For 25mA < I<sub>L</sub> < 200mA, I<sub>L</sub> changes less than 3% for a 100% increase in R<sub>L</sub>.

Circuit description

A very simple constant-current generator can be produced by placing a sufficiently large resistance between a constant voltage source and a load. This leads to a requirement of very high source voltages to supply constant currents of only a few mA. This simple approach is normally unacceptable. However, a constant-voltage regulator can be made to provide a constant current into a load, at reasonable voltages, while only carrying a relatively small standing current. The diagram above shows a monolithic voltage regulator connected as a two-terminal constant-current generator. This regulator was designed primarily as a fixed 5-V voltage regulator to supply the widely varying currents in logic circuitry. In the constant-voltage mode, R would be set to zero and terminal 3 connected to ground instead of the output terminal. The circuit thus provides a regulated output voltage between terminals 2 and 3. Inclusion of R between these terminals as shown ensures that it receives a constant voltage from the regulator and therefore carries a constant current which is supplied to the load

resistance. (The stability of R determines the stability of I<sub>L</sub>.) The load will also carry the quiescent current from terminal 3 but this will normally be much smaller than the current in R<sub>1</sub>. This quiescent current places a lower limit on the available output constant current. The voltage regulator chip incorporates a temperature regulator to provide thermal, rather than current, protection. This technique allows a considerable increase in the maximum allowable output current, the device being protected against almost any overload condition.

Component changes

Useful range of V<sub>IN</sub> + 6 to +35V.  
 I<sub>L</sub> (min)  $\approx 10mA$ : lower limitation due to quiescent current at regulator terminal 3.  
 I<sub>L</sub> (max)  $\approx 200mA$ : power dissipation limitation of 2W in regulator without heat sink.  
 For I<sub>L</sub> values of 50, 100 and 200mA typical values of R with V<sub>L</sub> = 3V are 109, 51.35 and 25.2Ω respectively.

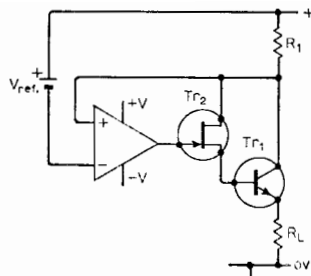

### Component changes

- IC<sub>1</sub>: LM101, Tr<sub>1</sub>: 2N2219, Tr<sub>2</sub>: 2N3456.
- Supply: useful range down to  $\pm 9V$ . Typically variations of current better than 0.05% over this range, when  $V_{ref}$  is independent of the supply.
- If oscillation exists, connect a capacitor across  $R_1$ .
- Useful range of  $R_2$ : 330 $\Omega$  to 3.3k $\Omega$ . At 2mA load current variations less than 0.05%.
- At 2mA, variations are less than -2% with BFR41  $h_{fe}$  in the range 90 to 220.
- Absolute measurement of current through  $R_1$  and emitter current indicated a variation of around 1.5%.

### Circuit modifications

Current through  $R_1$  is defined by  $V_{ref}$  in circuit shown left. However in this circuit, the current shunted from the collector to the non-inverting input of the operational-amplifier is considerably less than the original circuit, as the output current demanded from the op-amp is only the gate current of the f.e.t.  $Tr_2$ . The f.e.t.-bipolar compound pair has a much higher current gain and the load current is more nearly equal to that defined by  $V_{ref}/R_1$ .

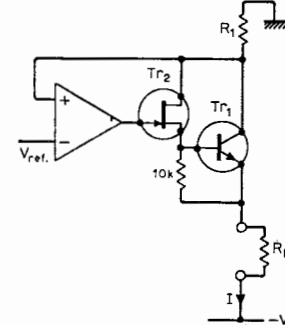
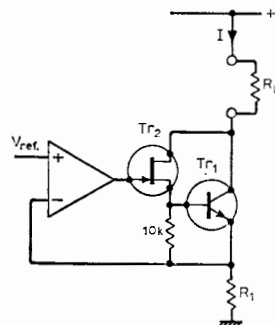

- Use f.e.t. 2N5457 to drive the bipolar transistor. Absolute measurement of current through  $R_1$  and emitter currents of  $Tr_1$  now indicate a variation of less than 1%.  $R_1$ : 1.1k $\Omega$ ,  $R_2$ : 100.  $V_{ref}$  adjusted to give load current of 2mA.  $R_2$  varied from 4.7k $\Omega$  (max) down to 10. Current change within 0.01%.
- Alternative arrangement of feedback connection shown centre and right. Circuit in centre uses the output stage as a non-inverting follower allowing feedback to be returned to the inverting terminal of the op-amp. This arrangement is sometimes known as a current sink. Circuit right shows the corresponding current source. This may have both the reference voltage and reference resistor returned to ground or the positive supply rail with the load returned to the negative rail for increased load potential difference.

### Further reading

National Semiconductor Linear Applications AN-20.  
Hart, B., Current generators using unipolar-bipolar transistor hybrids. *Electronic Applications* 1966 vol. 27, pp. 30-7.  
Silicon Zener Diode and Rectifier Handbook, Motorola.

© 1973 IPC Business Press Ltd.

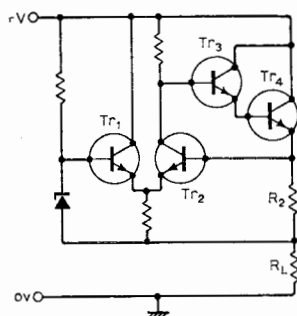

If regulator is placed some distance from the d.c. supply filter, a capacitor of about 0.1 $\mu F$  may be required between terminal 1 and ground to prevent h.f. oscillation.  
For higher output currents, up to about 1A, the LM309H can be replaced by an LM309K.

### Circuit modifications

Any voltage regulator that can sustain a constant load voltage at a high current compared with its standing current may be used as a constant-current generator. Circuit shown left is a standard form of voltage regulator using  $Tr_1$  and  $Tr_2$  as a long-tailed pair with  $Tr_3$  and  $Tr_4$  forming a Darlington-connected output transistor. The long-tailed pair compares the reference voltage from the zener diode with the output voltage across a dummy load  $R_2$ . If the voltage regulation is good and  $R_2$  is constant then the current in it is constant. The current in the real load  $R_L$  is this current plus the currents in the long-tailed pair and reference diode, both of which can be made very much less than the dummy load current. If the "free" collector of  $Tr_3$  and  $Tr_4$  is accessible in the voltage

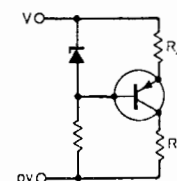
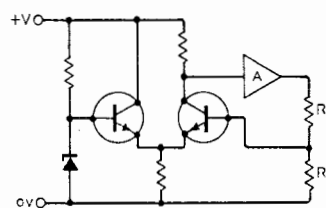

regulator,  $R_1$  may be placed between it and the positive supply, although  $R_L$  will not then be referred to ground.  
Another floating-load constant-current generator is shown, middle, which applies the principle of series feedback. The p.d. across  $R_3$  is a defined constant voltage and so also is the current in it. This current is virtually identical with that flowing in  $R_L$ . Amplifier could be a Darlington-connected pair.  
Existing voltage regulators, even of the poorest kind, can be used to provide a constant current, one example being shown right. The zener diode fixed the p.d. across the emitter resistor  $R_4$  and hence the current in  $R_L$ . This circuit suffers from the usual problems of matching up the temperature coefficients of the zener diode and transistor.

### Further reading

Linear Applications Handbook, National Semiconductor, AN 42-1 to 42-6, 1972.  
Nowicki, J. R., Power Supplies for Electronic Equipment, vol. 2, chapter 1, Leonard Hill Books 1971.

### Cross references

Series 6, cards 13, 10 & 11.

© 1973 IPC Business Press Ltd.

## Simple current limiting circuits

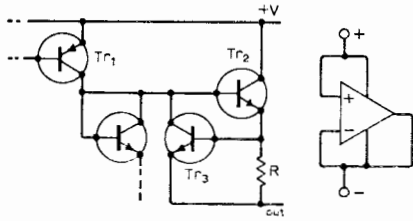

### Circuit description

Many i.c. op-amps have protection circuits at their output which limit the current that can flow, even into a short-circuit of the output to either supply line, and regardless of the condition of the input terminals. The current is not defined as precisely as with the other constant-current circuits described on these cards; the limiting action is only intended to be approximate, and generally uses the base-emitter junction of a transistor as the sensing element (e.g. with  $Tr_3$  as in a section of an i.c. shown above). Transistor  $Tr_2$  is one of the output transistors and if the output current flowing through  $R$  tries to exceed the value at which the  $V_{be}$  of  $Tr_3$  reaches 0.5V,  $Tr_3$  comes into conduction, diverting the base current supplied by  $Tr_1$  and preventing further increase in output. In general, the limit current falls with increasing temperature because the  $V_{be}$  of  $Tr_3$  required for conduction falls, and the resistance of  $R$  increases with temperature. Such a mechanism is thus not adequate for precision constant current action but can offer

### Typical data

IC: N574IV (Signetics)  
 Supply voltage: 10V  
 Current: 26-30mA  
 Voltage for limiting: 7-9V  
 10 samples of other manufacturers 741/748

i.cs gave current range 20-35mA.  
 10 samples from three manufacturers 301 i.cs gave currents of 15-25mA, but included devices requiring only 2-3V to achieve limiting.

good rejection of supply variation including ripple. If an i.c. op-amp having such limiting has its output shorted to one supply line and the inputs connected to the supply lines, in the sense that causes the output to try to drive towards the opposite line, the limiting mechanism comes into play and the complete circuit may be used as a two-terminal device. Placed between source and load, the load current is limited typically to 12-30mA depending on amplifier type for any p.d. across the amplifier above some minimum voltage (5-9V). The max p.d. across the amplifier must not allow the device dissipation to be exceeded, though self-heating minimizes the dissipation by reducing the current.

### Component changes

● With output open-circuit the circuit may also draw constant current but of much smaller magnitude. Similarly, connecting output to opposite supply and/or reversing input terminals brings different sections of the circuit into action, i.e. several different current limits can be obtained.

## Current mirror

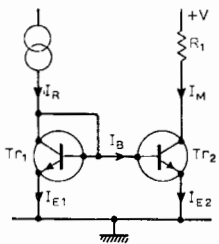

### Typical data

Supply: +6V  
 $Tr_1, Tr_2$ , part of CA3046  
 $R_1$ : 0-10k $\Omega$  decade resistor,  $\pm 0.05\%$   
 $I_R$ : 0-5mA from commercial current generator,  $\pm 0.05\%$   
 $I_M$ : Calculated from voltage reading across  $R_1$  using five-digit voltmeter  
 Dynamic output

impedance: 2M $\Omega$  at 50 $\mu$ A  
 Curves opposite show percentage variation of 'mirror' current to reference current for the basic and enhanced current mirror circuits, for currents in the range, 1 $\mu$ A to 5mA.  
 Product of  $I_M R_1$  maintained constant.

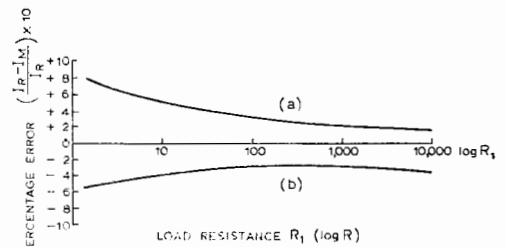

### Circuit description

Circuit configuration is known as a 'current mirror' and is widely used in integrated circuits. If the two transistors  $Tr_1$  and  $Tr_2$  are considered identical so that the base-emitter voltages are the same, then to a first order the collector currents will be the same. Transistor  $Tr_1$  acts as a diode whose forward voltage between base and emitter defines the base-emitter voltage of transistor  $Tr_2$ . If  $Tr_2$  has a high current gain, then the reference current  $I_R$  will be approximately equal to the collector 'mirror' current  $I_M$ .

$$I_R = I_B + I_E = I_{E2}/(1 + \beta) + I_{E1} = I_{E2} \left( \frac{1}{1 + \beta} + 1 \right)$$

$$I_M = \alpha I_{E2} = \frac{\beta I_{E2}}{1 + \beta}$$

$$I_{E2} = I_R \cdot \frac{1 + \beta}{2 + \beta}; \therefore I_M = \frac{\beta}{1 + \beta} \cdot I_R \cdot \frac{1 + \beta}{2 + \beta} \approx I_R.$$

Hence if the reference current is fixed, the collector current of  $Tr_2$  is fixed.

Discrete components are temperature sensitive and the circuit is not reliable with them. Closer matching of the transistor parameters and the facility of compensating changes due to temperature are available, when the transistors are produced on the same monolithic silicon chip. The circuit is thus often used in the reference stage for basic regulator circuits. Output impedance is approximately that of a common-emitter configuration, as the only effective resistance connected across base and emitter is the low dynamic resistance of  $Tr_1$  connected as a diode.

Output resistance characteristic of this circuit is increased considerably by including a diode connected transistor in series with the emitter of  $Tr_2$  as shown over (middle).

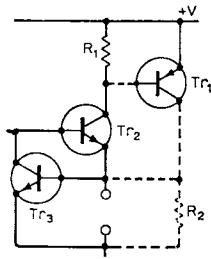

● With typical device from N5741V range, six configurations were tested, as below, with minimum voltage of 8V throughout; tests carried out at 10V and resulting current limits from 0.85 to 30mA obtainable from single device:

inv. input	non-inv. input	output	current (mA) at 10V
+	-	+	30
-	+	-	29
+	-	-	12
+	-	o/c	1.4
-	+	+	0.9
-	+	o/c	0.85

Current reduction 20% for temperature increase of 50 deg C.

#### Circuit modifications

● The basic idea of using a transistor to monitor the p.d. across a current-carrying resistor is also applied in voltage regulators to limit the output current even into a short-circuit load. Here,  $Tr_3$  deprives  $Tr_2$  of base-current, monitoring the p.d. across an external resistor  $R_3$ . This allows boosting of the output current via external transistor  $Tr_1$ , a variable R giving control of the current limit.

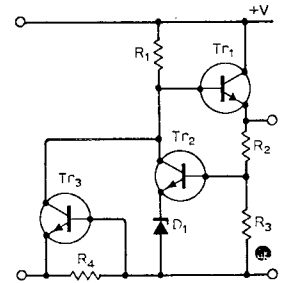
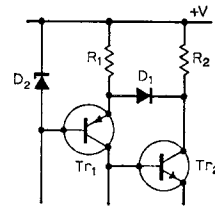

● Limiting by sensing of the collector current of the output stage is also possible. The nature of the drive circuit is often such that a loss of, say, 1V in the collector circuit does not further increase the minimum supply voltage. As shown,  $Tr_1$  is a constant-current stage biased by  $D_2$  acting as a high-impedance load for the error amplifier (not shown). As the output current increases so does the p.d. across  $R_3$  bringing  $D_1$  into conduction and diverting current from  $Tr_1$  i.e. limiting base current of  $Tr_2$ .

● In principle simple limiting circuits may be added to any voltage regulator. Shown is a method by which base current is diverted from the series pass transistor by  $Tr_3$  which senses the p.d. across  $R_4$ . In this case it is the total current that is limited i.e. load current plus circuit quiescent current.

#### Further reading

Patchett, E. N., Automatic Voltage Regulators & Stabilizers, Pitman 1970, pp. 364-6.

#### Cross references

Series 6, cards 2, 5 & 9.

© 1973 IPC Business Press Ltd.

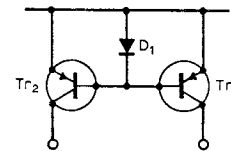
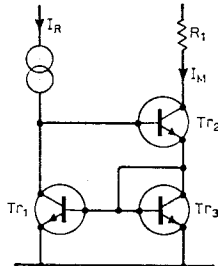
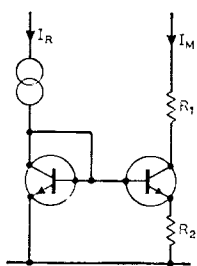

#### Component changes

● Dynamic output impedance reduces to  $200k\Omega$  for a current of  $500\mu A$ , and  $90k\Omega$  for load current of 1mA.  
 ● Percentage mirror current error is typically better than 2.5% for  $I_M = 500\mu A$  when  $R_1$  is varied from 0-10k $\Omega$  without attempting to maintain  $V_{ce}$  of  $Tr_2$  constant.

#### Circuit modifications

● Output impedance of the current mirror is increased by negative feedback via resistor  $R_2$  (left) but its use should be restricted to currents in the microamp range.  
 ● Higher output impedance obtained using the enhanced circuit shown middle. This requires about 1.2V minimum before control commences as the  $V_{be}$  of  $Tr_2$  and  $Tr_3$  must be overcome. The resulting transfer ratio of  $I_M/I_R$  can be shown to be  $(\beta^2 + 2\beta)/(\beta^2 + 2\beta + 2)$  indicating an improvement dependent on the  $\beta^2$  term, the  $(2\beta + 2)$  term becoming insignificant for high-gain transistors.

● Current mirror, shown right, available within transistor package CA3084. This is a p-n-p version and illustrates the use of the current mirror in establishing multiple current sources. Diode  $D_1$  is a transistor with its base and collector connected. The  $V_{be}$  values for each transistor are identical, and hence control of  $D_1$  current ensures first-order constancy of currents in  $Tr_1$  and  $Tr_2$ . In practice, the increased number of units of base current degrade the stability if too many stages are controlled.

#### Further reading

Hart, B. L., Current generators, *Wireless World*, vol. 76, 1970, pp. 511-4.

RCA Solid-State Databook, Series SSD-201, 1973.

RCA Solid-State Databook, Series SSD-202A, 1973, pp. 325-76.

#### Cross references

Series 6, cards 5 & 12.

© 1973 IPC Business Press Ltd.

## Ring-of-two reference

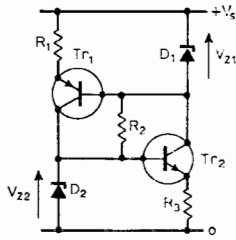

**Typical performance**  
 Minimum terminal p.d.  
 $\sim V_{Z2} + V_{Z1} - 0.5V$   
 Constant current  
 $\sim \frac{V_{Z2} - 0.6}{R_3} + \frac{V_{Z1} - 0.6}{R_1}$   
 $T_{R1}$ : 2N2702  
 $T_{R2}$ : 2N3707

$R_1, R_3$ : 470k $\Omega$ ;  $R_2$ :  $\infty$   
 $D_1, D_2$ : Reverse biased base-emitter junction at planar transistor e.g. 2S512  
 Comparable results for currents up to several mA. Self-heating effects significant at higher current.

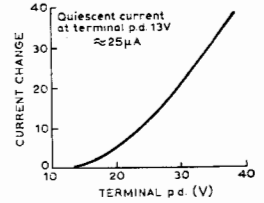

### Circuit description

If a circuit can maintain a constant voltage across a resistor against changes in the supply voltage, then the current flow in this resistor is maintained constant. If this current is greater than any other current in the circuit, then the total current taken from the supply is reasonably constant. A simple circuit that attempts this has the base-emitter of  $T_{R1}$  in parallel with a 100 $\Omega$  resistor  $R_3$ , maintaining a current through  $R_3$  of about 6mA with the feedback loop closed via  $T_{R2}$ . Although the current in  $T_{R1}$  varies when the applied voltage varies, this current is appreciably less than that in  $T_{R2}$ , and so the dynamic impedance of the circuit used as a two terminal element is high. A more complex amplifier, e.g. a Darlington pair, in place of  $T_{R2}$  would allow the contribution to total current change, due to the current in  $R_3$ , to be very small.

An alternative arrangement is to introduce  $R_4$  and  $R_5$ . If supply voltage increases, this potential divider increases p.d. across  $R_5$ . The base potential of  $T_{R1}$  is substantially constant, and hence p.d. across  $R_3$  must fall, and hence the current i.e. a relatively large increase in the current in  $R_3$  (which is small) is balanced by a small decrease in the relatively large current through  $R_3$ . By suitable choice of  $R_4, R_5$ , the dynamic resistance can be controlled to be positive or negative, and with a critical value of  $R_5$  is extremely high over a wide range of supply voltage. The operation of the circuit below 5V is non-linear.

When a.c. is to be applied, it may first be rectified so that the circuit sees a unidirectional voltage, but only the peak current can be controlled i.e. currents corresponding to voltages in

## A.C. constant-current circuits

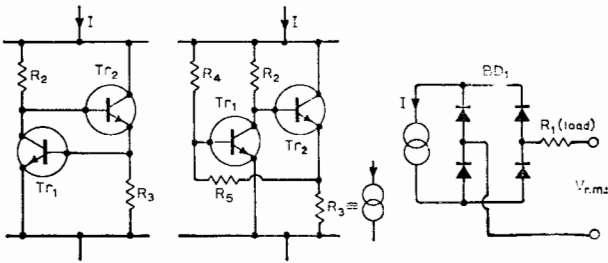

### Circuit description

The ready availability of two-terminal elements which can be placed in parallel with a load to make the load voltage stable is not matched by dual elements for sustaining constant load currents. Constant-current diodes are available but are no match for the variety and performance provided by zener diodes. Two problems have to be overcome in designing a two-terminal constant-current circuit. There will usually be two or more separate paths for current flow and they must either be separately constant or, if variable, such variations must be restricted to a low-current path. A second problem is that the minimum p.d. at which constant-current is achieved must be as low as possible, while the breakdown voltage should be high. The ratio of these p.d.s is one guide to the usefulness of the circuit and a ratio of 10:1 or greater is good. The upper voltage is fixed in the present circuit by the  $V_{cb}$  breakdown of

### Typical performance

$T_{R1}, T_{R2}$ : BC125  
 $BD_1$ : A154  
 $R_1$ : 47 $\Omega$ ;  $R_2$ : 3.9k $\Omega$   
 $R_3$ : 100 $\Omega$ ;  $R_4$ : 47k $\Omega$   
 $R_5$ : 1.5k $\Omega$   
 Current constant at 5.8mA  $\pm 1\%$  for direct voltage of 6 to 18V.

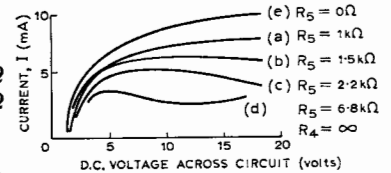

the transistors and the lower voltage by the sum of the  $V_z$  values. The two current paths are separately constant and may be made equal or not as required. Diode  $D_2$  maintains a constant potential at the base of  $T_{R2}$  and hence a constant p.d. across  $R_3$  ( $V_z - V_{be}$ ). The resulting constant emitter current ensures that the collector current of  $T_{R2}$  and hence the current in  $D_1$  are also constant. Similarly the p.d. across  $R_1$  is defined ensuring the stability of current in  $D_2$ . Thus each diode defines the current flowing in the other. The circuit is a form of complementary bistable and precautions must be taken to ensure that the on-state is the only practical one. This may be achieved by a starting resistor  $R_2$  between the bases (or from  $T_{R2}$  base to +ve line for example).

### Component changes

$T_{R1}, T_{R2}$ : General purpose silicon e.g. n-p-n. types ME4103, 2N706, BFR41; p-n-p types 2N3702, ME0413, BFR81.  
 $D_1, D_2$ : Zener diodes 2.7 to 12V. Low voltage units (2.7 to

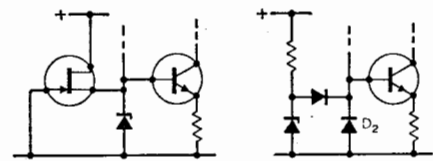
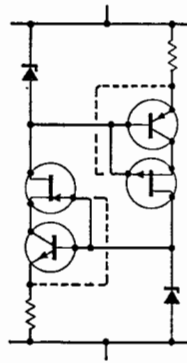
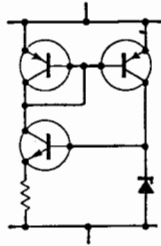

excess of 5V. To control the r.m.s. value of current, and if the waveshape is unimportant, the negative resistance effect allows the current to fall during the peaks of the applied signal, compensating for the rise during the rest of the cycle. Adjustment is empirical and depends on waveshape, but offers a simple means of controlling current in a resistive load for heating, or the mean charging current in the battery.

### Circuit modifications

- A high current gain in the output stage of the simple circuit, allows the bias current to be very small (left) and is therefore also suitable for high current circuits. Also  $Tr_1$  had to act as both an error amplifier and reference against which the current is being compared i.e. the  $V_{be}$  of the transistor. To improve this, a zener diode may be added as reference with the transistor primarily performing the function of error amplifier.

© 1973 IPC Business Press Ltd.

- The bias current itself may be made constant if resistors are replaced by elements which are two-terminal constant-current devices (e.g. f.e.t.) which may itself be combined with a better amplifier such as an op-amp, to give improved overall stability.
- The control of alternating currents is possible where devices are available which may be made to directly accept signals of both polarities (right). One practical case is a junction f.e.t. in which a resistor-diode network attached to the gate allows interchangeability of source and drain, e.g. when supply to A is positive,  $D_2$  conducts, clamping gate close to source voltage, and  $Tr_1$  current is near maximum value and unvaried with respect to further increase in supply. As f.e.t.s have great variation in pinch-off voltage and 'on' current, equal resistors are connected into source and drain paths, to exercise control over the current.

### Further reading

Williams, D. A., High-voltage constant-current source, *Wireless World*, Jan. 1972, p. 29/30.  
 Watson, G. Two transistors equal one, *Electronics*, 6 July, 1962.

### Cross references

Series 6, cards 9 & 12.

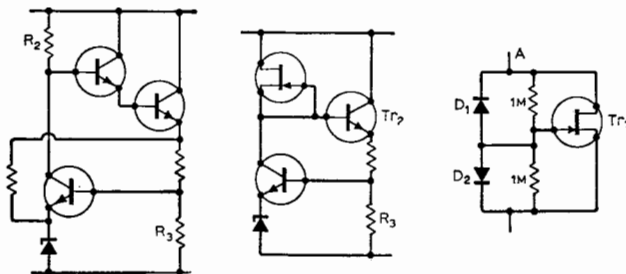

4.7V) give minimum terminal p.d. and first-order compensation for  $V_{be}$  temperature drift. Higher voltage units increase dynamic resistance of circuit. Zeners of breakdown  $\approx 6V$  have low temp. drift, and additional forward-biased diode in series gives temp. comp. (For very low voltage operation see card 9). Diodes need not have equal breakdown voltage. For low currents reverse breakdown in planar transistor base-emitter junctions offers good performance.

$R_1, R_3$ : 330k $\Omega$  1M $\Omega$ . At higher currents, self-heating effects vary current as terminal p.d. changes. At lower currents, low-leakage transistors used for  $Tr_1, Tr_2$ . Zeners may be replaced by reverse-biased base-emitter junctions of planar transistors (breakdown voltages typically 5 to 10V, fairly close tolerance for given device type).

$R_2$ : Typically 330k $\Omega$  to 10M $\Omega$ . Use highest value that ensures self-starting. 1M $\Omega$  adequate with all except high leakage zeners.

### Circuit modifications

- To minimize the p.d. at which the circuit achieves constant-current operation, only one half of the circuit has a zener diode. The other half may have the zener replaced by any

other element that sustains an approx. constant, p.d. against variation in current. A current mirror in one of its forms allows the circuit to function correctly for a terminal p.d. barely more than the zener voltage. Alternative circuits (card 4) can increase accuracy of current for small increase in minimum p.d.

- For highest dynamic resistance, each transistor may be replaced by cascode or similar circuits while retaining defined  $V_{be}$  characteristics of bipolar transistors. Alternative connection for f.e.t. gives higher dynamic resistance but version shown allows f.e.t. to operate with slight forward bias if required, increasing the current capability.

- Circuits are all bistable in form, with a possible non-conducting state. Any resistive start-up circuit degrades dynamic resistance. Use of junction f.e.t. with pinch off between  $V_{be}$  and  $V_z$  inhibits off-state without contributing current in one state. Identical zener diode with high resistance drive brings  $D_2$  into conduction-preferred method in some i.c. regulators but current in R flows in load if used as two-terminal constant-current circuit.

### Further reading

Williams, P., Ring-of-two reference, *Wireless World*, vol. 73 1967, pp. 318-22.  
 E-Line Transistor, Stable voltage reference source, Ferranti applications note, 1969, pp. 41-4.  
 MacHattie, L. E., Highly stable current or voltage source, *Scientific Instruments*, Oct. 1972, pp. 1016/7.

### Cross references

Series 2, card 9.  
 Series 6, cards 3, 4 & 9.

© 1973 IPC Business Press Ltd.

## Switching current regulator

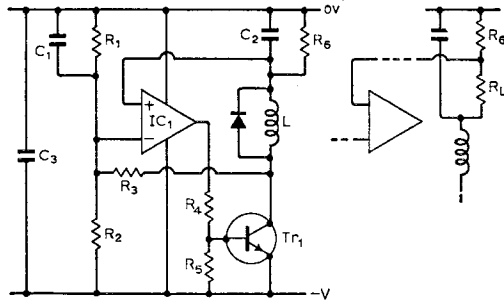

### Circuit description

The key difference between switching regulators and conventional types lies in the discontinuous operation of power stage which is isolated from the load by an LC network. The power transistor delivers current for short periods to the inductor and during its non-conducting period the current flow in the inductor is sustained through the diode. The resulting voltage step across the inductor (approximately equal to the supply voltage) defines the rate-of-change of current in terms of the inductance. If the period is short enough, the current is relatively constant, and together with the filtering action provided by the capacitor, the ripple voltage across  $R_1$  can be small compared with its mean p.d. The circuit may be alternatively viewed as a simple astable in which the inversion due to the output transistor interchanges the functions of the op.amp. input terminals, while an LR circuit replaces the

### Typical data

IC: 301  
Tr: TIP3055  
D: SD2 (1A 25V diode)  
 $C_1$ : 1nF  
 $C_2$ : 22 $\mu$ F 6.3V Tantalum  
 $C_3$ : 22 $\mu$ F 20V Tantalum  
 $R_1$ : 1k $\Omega$ ;  $R_2$ : 5.6k $\Omega$   
 $R_3$ : 470k $\Omega$ ;  $R_4$ : 220 $\Omega$

$R_5$ : 150 $\Omega$   
L: 5mH (Ferrite core)\*  
For  $R_6=2\Omega$ ,  $V_s=-10V$   
load voltage: 1.2V,  
supply current: 150mA  
switching frequency:  
4kHz  
\*See component changes

ripple voltage: 100mV  
stability: output change  
<  $\pm 4\%$   
for supply 5 to 20V  
output change  
<  $\pm 1\%$   
for load resistance  
2 to 15 $\Omega$ .

conventional CR version. Hysteresis provided by  $R_3$  defines the pk-pk swing that will occur across  $R_6$ . The smaller this hysteresis, i.e. the larger  $R_3$ , the smaller the resulting ripple. This brings with it increased frequency of operation, as the rate-of-change of voltage is a function of L,  $C_2$ ,  $R_6$  as outlined above. Mean level across  $R_6$  is fixed by that across  $R_1$  and is a fixed fraction of the supply voltage. In most applications this potential divider is replaced by stable reference voltage of suitable value (see cards 5, 9). As shown, the circuit acts as a voltage regulator for a load at  $R_6$ . To be used as a constant-current source the load may be placed series with the resistor across while a constant p.d. is developed. Switching regulators may be driven by an external oscillator with the internal positive feedback eliminated.

### Component changes

L: Frequency of operation is a compromise; too high and amplifier switching times limit performance, too low and increased inductance brings reduced efficiency because of

## Thyristor control current regulator

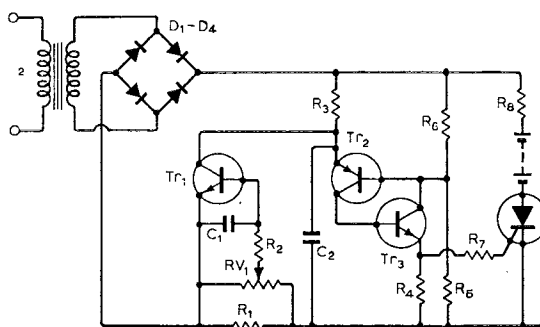

### Circuit description

The circuit consists of four sections: a full-wave bridge-rectified power supply; a thyristor in series with the load with the angle of conduction varying the mean load current; a pulse-generating circuit which delivers a series of pulses to the thyristor starting at a particular instant in each half-cycle; and a current-sensing transistor that varies the pulsing circuit to control the mean current via the firing angle. Once the thyristor has fired, the remainder of the circuitry has no influence on the instantaneous current (determined only by the elements in series across the supply:  $R_1$  thyristor, load,  $R_8$ ). Any increase in the mean current causes the mean p.d. across  $R_1$  to increase and via  $RV_1$ , smoothed by  $R_2$ ,  $C_1$ , brings  $Tr_1$  into conduction. This by-passes some charging current

### Typical performance

T: 240V r.m.s. 50Hz primary  
30V r.m.s. secondary  
 $D_1$  to  $D_4$ : 50V 1A bridge rectifier  
 $Tr_1$ ,  $Tr_3$ : BC 125  
 $Tr_2$ : BC 126  
 $Tr_4$ : 50V 1A (mean d.c.) thyristor (2N1595 etc)  
 $R_1$ : 12 $\Omega$ ;  $R_2$ ,  $R_5$ ,  $R_6$ : 10k $\Omega$   
 $R_3$ : 150k $\Omega$ ;  $R_4$ : 470 $\Omega$

$R_7$ : 100 $\Omega$ ;  $R_8$ : 15 $\Omega$   
 $C_1$ : 470 $\mu$ F;  $C_2$ : 22nF  
Supply: 200V r.m.s.  
Battery terminal p.d.: 8V  
Charging current set to: 50mA (mean)  
Change in current for supply voltage  $\pm 25\%$   
 $\approx \pm 4\%$   
Change in current for terminal p.d. changed by  $\pm 2V \approx \pm 0.5\%$

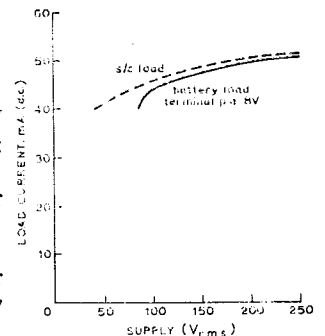

from  $C_2$  delaying the onset of firing of the unijunction-equivalent composed of  $Tr_2$ ,  $Tr_3$ ,  $R_5$ ,  $R_6$  (see Series 3, card 4). The minimum p.d. wasted across current-sensing resistor  $R_1$  need only be  $\approx 0.6V$ , giving good efficiency. Accuracy of control is limited by relatively low gain of control element, its temperature dependence, etc. Adding a zener diode in emitter of  $Tr_1$  and dispensing with  $RV_1$  would define control point more accurately at expense of increased voltage/dissipation in  $R_1$ .

### Component changes

T,  $D_1$  to  $D_4$ : Diodes must carry peak current much greater than mean current where conduction angles are small (high supply voltages, low load voltages) i.e. if mean load current is to be 1A peak currents might have to be  $> 5A$ . Similarly for transformer, thyristor.

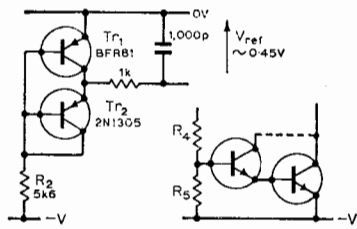

winding resistance. Coils wound on ferrite rings/cores offer wide range of operating frequencies with minimum radiation of switching harmonics if shielded units used. Typical range 200 $\mu$ H to 10mH.

IC<sub>1</sub>: Uncompensated op.amp. 748, etc. Possibility of 741,301 compensated amplifiers at low frequency with suitable choice of ferrite.

Tr<sub>1</sub>: For currents < 500mA: BFR41, BFY50 with reduced efficiency; somewhat higher frequencies at moderate currents: MJE521.

R<sub>1</sub>, R<sub>2</sub>, R<sub>3</sub>: Set reference voltage/hysteresis. R<sub>1</sub>, R<sub>2</sub> replaced normally by separate reference circuit.

### Circuit modifications

- To stabilize load voltage/current some stable reference voltage must be added. A simple circuit that allows operation down to very low supply voltages, tolerates high voltages and gives reasonable stability against temperature changes, matches the  $V_{be}$  characteristics of a silicon against a germanium transistor. Unselected units give a variation in reference voltage against supply of <2% over the whole supply range of the regulator (e.g. 3 to 20V), and a typical temperature drift of <0.1% per deg. C.

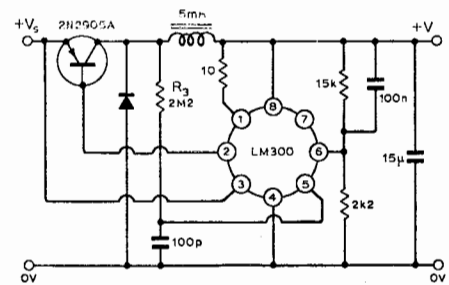

- Output current can be increased by replacing the drive transistor by any high gain combination such as the Darlington pair provided frequency is not too high (charge storage problems) and the increased losses due to saturation are acceptable. At low supply voltages the collector of the first transistor may be returned to the zero line.

- A positive voltage regulator using a standard i.c. is given in the first reference below. It operates at a higher switching frequency and contains its own voltage reference circuit. Pin 6 compares a portion of the output voltage with the internal reference, the error amplifier driving the transistor with positive feedback via pin 6 and defining the hysteresis.

### Further reading

Designing Switching Regulators, National Semiconductor application note AN-2, 1969.

Nowicki, J. R., Power Supplies for Electronic Equipment, vol. 2, Leonard Hill, 1971, pp. 153-81.

### Cross references

Series 6, cards 8 & 10.

© 1973 IPC Business Press Ltd.

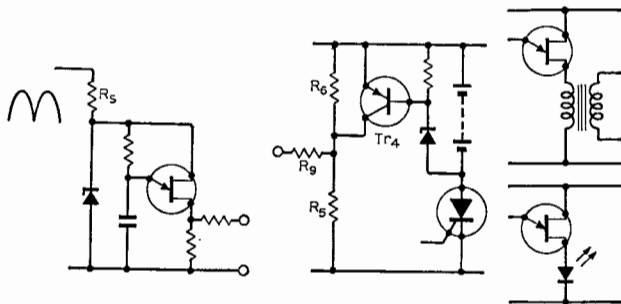

R<sub>1</sub>: At max. setting of RV<sub>1</sub>, mean voltage across R<sub>1</sub> is 0.6V approx. and mean current = 0.6V/R<sub>1</sub>. Setting RV<sub>1</sub> to 50% doubles mean current, and p.d. across R<sub>1</sub>, quadrupling power in R<sub>1</sub>.

C<sub>1</sub>: Smooths bias to Tr<sub>1</sub>, 50 to 1000 $\mu$ F low-voltage electrolytic.

R<sub>2</sub>: Increased value allows lower C<sub>1</sub> for given smoothing but decreases accuracy of current. Typical range: 2.2 to 47k $\Omega$ .

R<sub>3</sub>, C<sub>2</sub>: To give free running frequency  $\geq$  100Hz so that firing can occur early in each cycle. R<sub>3</sub>: 47 to 470k $\Omega$ ; C<sub>2</sub>: 10 to 100nF.

Tr<sub>2</sub>, Tr<sub>3</sub>, R<sub>5</sub>, R<sub>6</sub>: Can be replaced by single unijunction transistor e.g. 2N2646, 2N2160, etc. Any other general-purpose silicon transistors in place of Tr<sub>2</sub>, Tr<sub>3</sub>.

R<sub>4</sub>, R<sub>7</sub>: Reduce R<sub>4</sub> to 100 for some unijunctions. R<sub>7</sub> not critical.

Thyristor: Any medium sensitivity, low-voltage thyristor. For higher peak currents reduce R<sub>1</sub>, R<sub>8</sub> proportionately. Resistor R<sub>8</sub> can be omitted if very high peaks can be tolerated by thyristor, load.

### Circuit modifications

- The supply to the sensing/firing circuits may be limited and/or stabilized by a zener diode to improve control over the firing point, and to protect the circuitry when the thyristor supply is too great. For example, this would be necessary if constant-current action were desired directly from mains with no intervening transformer. Dissipation in R<sub>5</sub> would be high. In this, as in main diagram, a unijunction may be substituted for the complementary bistable.

- Where the circuit is to be used for battery charging, over-voltage protection might be desired. One possibility is to monitor the battery voltage directly (or better via an RC filter to eliminate spikes, as with R<sub>2</sub>, C<sub>1</sub> over) using a zener diode or other suitable reference to define onset of conduction in Tr<sub>4</sub>. The latter can then be used to raise the potential at the junction of R<sub>5</sub>, R<sub>6</sub>, delaying and eventually preventing firing. Addition of a series resistor R<sub>9</sub> to the junction of Tr<sub>2</sub> base/Tr<sub>3</sub> collector prevents excessive current flow via Tr<sub>4</sub>, Tr<sub>3</sub>.

- Alternative coupling methods including pulse transformation, light-emitting diodes, etc., may be used if thyristor is at an inconvenient potential relative to firing circuit.

### Further reading

Low-cost constant-current battery charger with voltage limiting, *Semiconductors* (Motorola), vol. 3, 1972, no. 1, pp. 15/6.

400V constant-current source, *Electronic Circuit Design Handbook*, Tab. 1971, p. 298.

Nowicki, J. E., *Power Supplies for Electronic Equipment*, vol. 2, Leonard Hill, 1971, pp. 182-93.

### Cross references

Series 2, card 5. Series 3, card 4. Series 6, card 7.

© 1973 IPC Business Press Ltd.



## Low-voltage current regulators

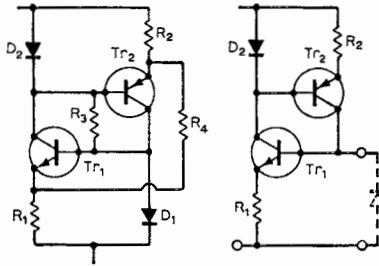

### Circuit description

The ring-of-two reference (card 5) may be adapted for very low voltage applications by replacing the zener diodes by forward-biased silicon diodes or any other element having dynamic resistance less than static resistance ('amplified' diodes, asymmetric voltage-dependent resistors, gallium arsenide diodes, etc.). The transistors used must then have a  $V_{be}$  less than the diode forward voltage drop, and germanium devices are indicated for use with silicon diodes. For optimum temperature compensation with these devices, the p.d. across each emitter resistor should be around 420mV (a figure based on the junction properties of the devices). This is not always convenient to achieve, but stability of 0.1%/deg. C is normally possible. Leakage currents of the Ge transistors are enough to ensure start-up in most cases and  $R_3$  may be dispensed with. Resistor  $R_4$  may be added to neutralize the effect of  $R_3$  if present, and if absent to control the dynamic resistance of the

### Typical data

$D_1, D_2$ : 1S130  
 $Tr_1$ : 2N1308  
 $Tr_2$ : 2N404  
 $R_1, R_2$ : 220 $\Omega$   
 $R_3, R_4$ :  $\infty$ . Typically leakage current of Ge transistors sufficient for self-starting. To increase dynamic resistance  $R_4$  may be in range  $100R_1$  to  $1000R_1$ .

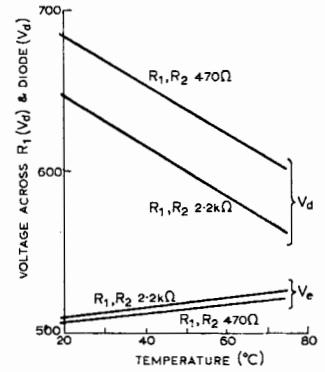

two-terminal circuit. It bypasses current around the transistors reducing the collector current in each, i.e. opposing the natural tendency for a slight increase in current as the terminal p.d. increases. Dynamic resistance may even be made negative and large if  $R_4$  is reduced sufficiently though over a more limited range of supply voltages than normal. This circuit, as with related circuits on card 5, may be used to supply a constant current to an external zener diode minimizing the total supply voltage required (as compared with its use as a two-terminal circuit interposed between supply voltage and load).

### Component changes

$D_1, D_2$ : Any silicon p-n junction including diodes (1N914, etc.) base-emitter junction of transistors (2N3707, BC125, BC126, ME4103, ZTX300, etc.) diode-connected transistor i.e. collector-base short.

## High-power current regulators

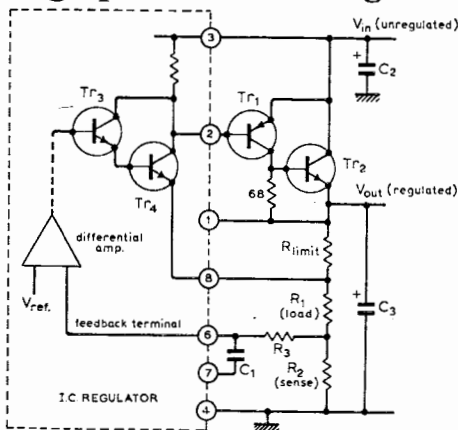

### Typical data

Load current: 0.9A  
 Unregulated input: 13 to 20V  
 IC: LM300  
 $Tr_1$ : BFR81;  $Tr_2$ : MJE521  
 $R_{limit}$ : 1 $\Omega$ ;  $R_1$  (load): 10 $\Omega$   
 $R_2$ : 1.95 $\Omega$ ;  $R_3$ : 2.2k $\Omega$   
 $C_1$ : 47pF  
 $C_2$ : 1 $\mu$ F (tantalum)  
 $C_3$ : 4.7 $\mu$ F (tantalum)

### Circuit description

This is basically a series voltage regulator used as a constant-current source, where the maximum output current depends on the current gain and power rating of the series-pass transistors ( $Tr_3, Tr_4$ ) connected as a Darlington pair. Further amplification, and thus a greater output current, is available by modifying this series element by connecting two discrete transistors  $Tr_1$  and  $Tr_2$  to give a compound emitter-follower. The p-n-p/n-p-n combination is preferred for an improved temperature coefficient over a straightforward quad emitter-follower.

Graph shows effect of foldback current limiting on output current when load  $R_1$  is varied (see circuit over, left)

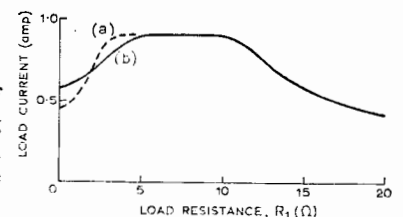

(a)  $R_{limit} = 1\Omega$   $R_4 = 56\Omega$   $R_5 = 470\Omega$   
 (b)  $R_{limit} = 0.6\Omega$   $R_4 = 56\Omega$   $R_5 = 1k5\Omega$

The essential function of this regulator is that some fraction of the output voltage (or a voltage due to load current through a resistor) is compared with a reference voltage developed within the i.c. regulator. If the output voltage changes, the error signal is amplified and used to compensate for the original change by modifying the drive to the compound emitter-follower. The internal reference voltage is approximately 1.7V, and hence the feedback sense voltage developed across  $R_2$  must approach this value for the desired load current, thus defining  $R_2$ . The resistors across the base-emitter terminals of the external transistors cause the operating currents to be raised and improves the stability.

An arrangement for foldback current limiting is shown over (left) and is used to protect the regulator against the load going short-circuit, and limits the current to around 0.5A under this condition. Capacitor  $C_1$  is a frequency compensation capacitor. The additional current gain necessary for the high current regulators may cause h.f. oscillation, eliminated by connecting a tantalum capacitor across the input and the output.

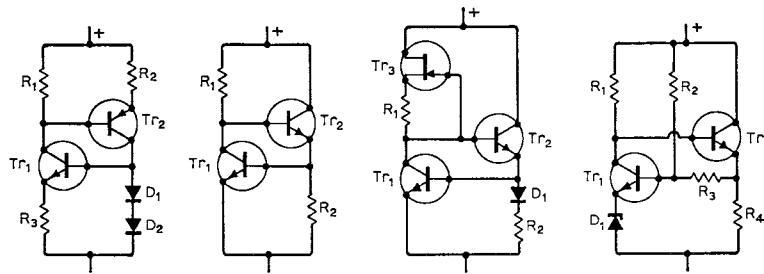

Tr<sub>1</sub>: n-p-n germanium transistor (OC139, 2N1302, 2N1304, 2N1306, 2N1308).

Tr<sub>2</sub>: p-n-p germanium transistor (2N1303, -05, -07, -09, OC42, OC44) for optimum temperature performance with reasonably high gain transistors, diode/transistor combination should result in 400-450mV across emitter resistor.

### Circuit modifications

- Diodes may be placed in one limb of the circuit, over-compensating the temperature induced change in Tr<sub>1</sub> V<sub>be</sub>. By keeping R<sub>1</sub> and R<sub>2</sub> low, resulting decrease in the p.d. across R<sub>1</sub> is insufficient to compensate for the change in the V<sub>be</sub> of Tr<sub>2</sub>. Hence currents in the two limbs change in opposite senses and approximate cancellation is possible. Once this has been achieved, R<sub>1</sub>, R<sub>2</sub> may be replaced by a single potentiometer, varying the total current while remaining approximately compensated.

- A different circuit using transistors of only one type is basically a voltage regulator defining the p.d. across a resistor whose current is larger than the remaining circuit currents (similar to card 2). Simplest version defines the current in terms of Tr<sub>1</sub> V<sub>be</sub> and suffers from variation of current in R<sub>1</sub> as

supply varies in addition to temperature dependence ( $\approx 0.3\%$ /deg. C).

- Replacing R<sub>1</sub> by a junction f.e.t. Tr<sub>3</sub> improves the constancy of current against supply voltage while the introduction of D<sub>1</sub> a germanium diode gives first-order temperature compensation.
- With the penalty of higher terminal p.d. better stability is given by the addition of zener diode D<sub>1</sub>. Resistors R<sub>2</sub>, R<sub>3</sub> compensate for current variations in R<sub>1</sub> by causing the p.d. across R<sub>4</sub> to fall as the supply voltage rises. Typically R<sub>1</sub> = 10R<sub>4</sub>, R<sub>2</sub> = 100R<sub>4</sub>, R<sub>3</sub> is varied to optimize slope resistance, but is in the region 0.5 to 5R<sub>4</sub>.

### Further reading

Williams, P., Low-voltage ring-of-two reference, *Electronic Engineering*, 1967, pp. 676-9.

Verster, T. C., Temperature-compensated low-voltage reference, *Electronic Engineering*, 1969, p. 65.

Watson, G., Constant-current circuit, *Electronics*, 6th July, 1962, p. 50.

### Cross references

Series 6, cards 3, 4, 5 & 6.

© 1973 IPC Business Press Ltd.

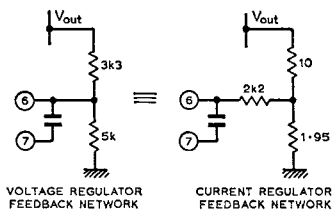
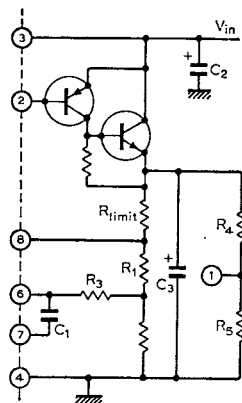

### Component changes

R<sub>1</sub> varies from 1 to 10Ω, current variation within +0.1% over the full range. Regulator may be LM100 or LM305.

Tr<sub>1</sub>: 2N3055. Tr<sub>2</sub>: 2N2905.

Parasitic oscillations can be suppressed by threading a ferrite bead over the emitter head of power transistor Tr<sub>2</sub>.

Basic voltage regulator normally has its output voltage set by connecting the tap on a potential divider to the feedback terminal. The resistance seen by this terminal should be around 2.2kΩ to minimize drift caused by the bias current at this terminal. This explains the values shown for the voltage regulator divider, and need for R<sub>3</sub> when the i.c. is used as a current regulator, the network equivalents being shown over (middle).

### Circuit modifications

- Foldback current limiting is achieved by connection of resistors R<sub>4</sub> and R<sub>5</sub> (left). This provides protection for the

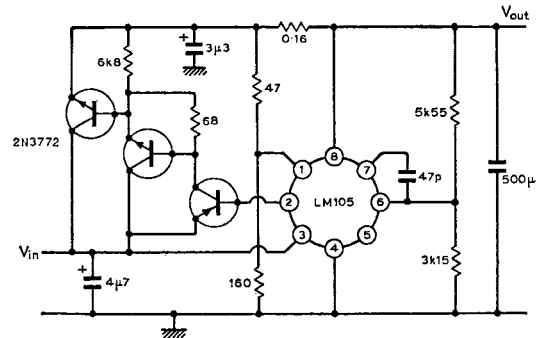

regulator against excessive power dissipation should the load short-circuit, and limits the current to about 0.5A. Limiting starts when the voltage across terminals 1 and 8 exceeds +0.4V, and depends on the potential differences across R<sub>limit</sub> and R<sub>4</sub>. This critical voltage increases the positive bias on a transistor which therefore conducts harder and steers current away from the first transistor of the series element, and hence the load current decreases.

- Very high output currents can be obtained using LM105 or LM305 regulator, and an additional high power transistor. A typical arrangement is shown right to produce 10A, and with foldback current limiting. Input level should be >9V.

### Further reading

400 ideas for design. vol. 2. Hayden, 1971.

Williams, P., Voltage following, *Wireless World*, vol. 74, 1968, pp. 295-8.

National Semiconductor application notes AN-1 and AN-23.

Cross references Series 6, cards 2 & 7.

© 1973 IPC Business Press Ltd.

Constant-current applications

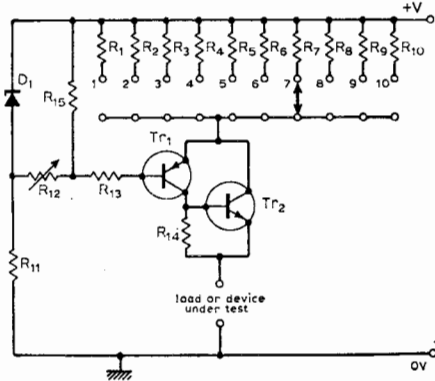

**Typical performance**  
 Supply: +12V  
 Tr<sub>1</sub>: 2N3702  
 Tr<sub>2</sub>: BFY50  
 D<sub>1</sub>: HS7062  
 R<sub>1</sub>: 560kΩ; R<sub>2</sub>: 270kΩ  
 R<sub>3</sub>: 100kΩ; R<sub>4</sub>: 56kΩ  
 R<sub>5</sub>: 27kΩ; R<sub>6</sub>: 12kΩ  
 R<sub>7</sub>: 5.6kΩ; R<sub>8</sub>: 2.7kΩ  
 R<sub>9</sub>: 1.2kΩ; R<sub>10</sub>: 560Ω  
 R<sub>11</sub>: 470Ω; R<sub>12</sub>: 100Ω  
 R<sub>13</sub>, R<sub>14</sub>, R<sub>15</sub>: 1kΩ  
 I<sub>supply</sub>: 14.5 to 24.3mA.

With load of 1kΩ all preset currents within +8% of nominal values and decade values, e.g. 10μA, 100μA, 1mA, 10mA within ±1% of each other. Dynamic output resistance/load current: see graph opposite.

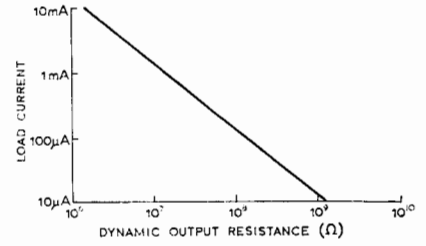

Circuit description

A preset constant current may be used in many instrumentation applications in the same way as a preset voltage. Such a current generator may be used, for example, to test semiconductor devices such as diodes and zener diodes to obtain their current-voltage characteristics; in a zener diode the current may change by a factor or more than 100 with a corresponding voltage change of only a few percent. The circuit shown provides constant currents that are preset within the range 100μA (S<sub>1</sub> in position 1) to 10mA (S<sub>1</sub> in position 10), with an overall stability of less than 1% at any preset value. The accuracy of the preset currents is not so high as preferred-value 5% resistors were used, but can be improved by using

selected values. For diode testing over a wide range of currents, the preset currents are chosen to be multiples of 1, 2, 5, 10 to allow rapid construction of a log-scale graph. The zener diode D<sub>1</sub> sets the base potential of Tr<sub>1</sub> and hence the p.d. across its selected emitter resistor R<sub>1</sub> to R<sub>10</sub>. Current in the selected resistor is therefore defined as is the current in the load or device under test. Transistors Tr<sub>1</sub> and Tr<sub>2</sub> form a complementary pair, the equivalent compound transistor having a current gain approximately equal to the product of the individual current gains and an input characteristic equivalent to that of Tr<sub>1</sub>. The base current of Tr<sub>1</sub> is thus very much less than the load current so that the latter is virtually the same as that defined in the selected emitter resistor. By selecting the emitter resistor to be R<sub>7</sub> the load current can be set to be 1mA by adjustment of R<sub>12</sub>. Constant currents of 10μA, 100μA and 10mA are then also defined to an accuracy, depending on the tolerances of R<sub>1</sub>, R<sub>4</sub> and R<sub>10</sub> respectively.

Constant-current amplifiers

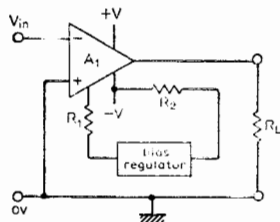

**Typical performance**  
 Supplies: ±6V  
 A<sub>1</sub>: 1/3 × CA3060 (regulator is part of CA3060)  
 R<sub>1</sub>: 53.7kΩ ±1% for I<sub>bias</sub>: 100μA  
 R<sub>2</sub>: 47kΩ for I<sub>bias</sub>

≤ 100μA; R<sub>L</sub> = 1kΩ  
 Equivalent source resistance with I<sub>bias</sub> = 100μA is approx. 264kΩ i.e. load current changes by about 4% for a 1000% increase in R<sub>L</sub>.

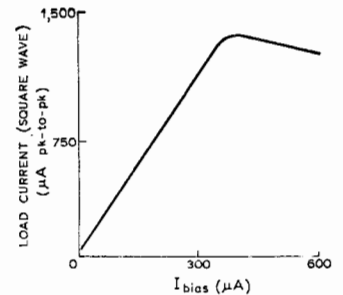

Circuit description

A class of monolithic amplifiers is now available called operational transconductance amplifiers. This type of amplifier is a novel circuit having similar general characteristics as an operational voltage amplifier except that its gain is better described in terms of a transconductance rather than as voltage gain. Its open-loop voltage gain is equal to the product of its transconductance and the load resistance it feeds.

In the circuit A<sub>1</sub> is one of three transconductance amplifiers in a single package together with a bias regulator. The regulator is supplied from the -V rail through a resistor R<sub>2</sub> and each of the class-A push-pull transconductance amplifiers are biased independently by a suitable resistor R<sub>1</sub>. The transconductance of the amplifier is controlled by the bias current i.e. by the value of R<sub>1</sub>. For a given input voltage between the inverting and non-inverting inputs the output current is defined by the bias current which can be varied over a wide range.

While the amplifier can be used in its linear mode with various feedback arrangements, the open-loop circuit shown above can deliver a square wave current to the load resistance. The peak-to-peak amplitude of the square wave is under the control of the bias current. As the amplifier has a high output impedance, it may be thought of as being a generator of a current square wave having a definable and constant peak-to-peak value. The circuit can supply an output of around 1V pk-pk into loads of around 10kΩ with an equivalent source resistance of about 260kΩ, provided V<sub>in</sub> is large enough.

Component Changes

Useful range of supply: ±2.5 to ±7V  
 Maximum differential input voltage: ±5V  
 Maximum d.c. input voltage: +V to -V  
 Useful range of bias current approx: 10μA to 2mA

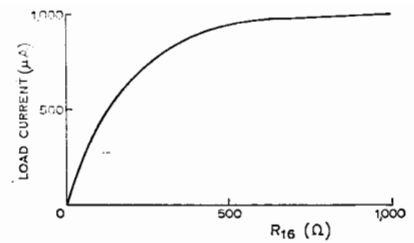
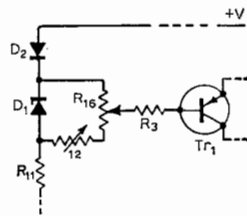
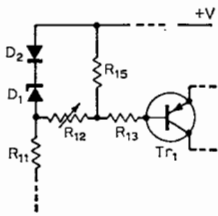

### Component changes

Larger values of constant current can be obtained by changing  $Tr_1$  and  $Tr_2$  to higher power transistors capable of handling the larger currents. The p.d. available at the load terminals can be increased by using a lower voltage zener diode for a given value of  $+V$ . The value of  $+V$  can be increased, provided that the breakdown voltage of  $Tr_1$  and  $Tr_2$  is not exceeded, to provide higher load voltages at defined currents. If the  $Tr_1$  biasing network is replaced by a simple potentiometer between the supply lines a high output impedance is still obtained but the load current is less stable and the load p.d. will fall as the load current is increased by altering the potentiometer setting.

### Circuit modifications

Errors in the constant currents will be due to drift in the zener diode, drift in  $V_{be}$  of  $Tr_1$  and the finite and variable current gain of the compound transistor. In the circuit discussed the zener diode is chosen for low slope resistance to limit dependence on supply voltage. If the circuit is operated from a stabilized voltage supply, the low slope resistance can be abandoned and the zener diode can be chosen to provide best temperature matching. A forward-biased junction diode can then be placed in series with a zener diode to provide temperature compensation for the drift in  $V_{be}$  of  $Tr_1$  (see left),

where  $D_1$  could be a 5.6V zener and  $D_2$  a BYX22-200.

• In addition to the preset constant currents it is often necessary to provide a current that may be accurately varied over a restricted range. This can be achieved by connecting a potentiometer of the calibrated multi-turn type across the zener diode as shown middle. A graph of the variation in load current achievable using  $S_1$  in position 7 and a 1-k $\Omega$  potentiometer is shown right.

• As well as being used for measuring the characteristics of diodes and zener diodes, the unit described may also be used to measure loop resistance by monitoring the load terminal p.d. with a d.v.m. whilst feeding an appropriate constant current to the unknown resistance. By feeding a constant current to the emitter of a transistor and measuring its base current the d.c. current gain can be quickly found. Another application is in electrochemical plating.

### Further reading

Williams, P., Constant-current testing of semiconductor devices, *International Journal of Electrical Engineering Education*, vol. 6, pp. 363-9.

Hemingway, T. K., *Circuit Consultant's Handbook*, Business Books 1970, pp. 196-202.

Cross references Series 6, cards 1 & 2.

© 1973 IPC Business Press Ltd.

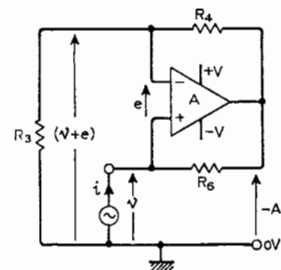
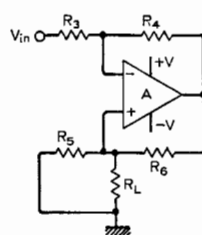
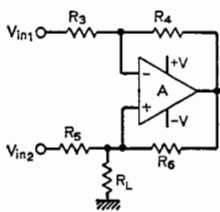

Maximum bias regulator input current (total for 3 amplifiers): -5mA

Useful frequency range for square wave output current is typically 120kHz.

### Circuit modifications

An amplitude-modulated constant-current source is obtained if the modulating voltage source is connected as a floating source in series with  $R_1$  or as a grounded source to the bias terminal through a resistance of the order of 100k $\Omega$ . In the first arrangement 100% amplitude modulation of the output square wave is obtainable, whereas the latter connection provides about 30% modulation depth using a 12V pk-pk sine wave source.

Circuit left shows the general form of a circuit, known as the "Howland" circuit, which provides a constant current into the load by virtue of the fact that A,  $R_4$  and  $R_6$  act as a negative impedance converter. As shown,  $V_{in2}$  must supply the short-circuit load current, therefore the circuit is often used in the form shown centre. The high output impedance available at the load terminals can be seen by reference to the diagram on right where  $R_L$  has been replaced by a voltage source,  $V_{in}$  has been set to zero and  $R_5$  temporarily removed, for analysis.

The output impedance at the load terminals is  $Z_o = Z_p // R_5$  where  $Z_p = v/i$ . For simplicity, let  $R_3 = R_4 = R_5 = R_6 = R$ , then  $-Ae = 2(V + e)/R$ . Hence  $e = -2V/(A + 2)$  and  $i = (V + Ae)/R = v - [A.2V/(A + 2)]$ . Thus  $Z_p = V/i = (A + 2)R/(2 - A)$  and  $Z_o = Z_p // R = R(A + 2)/4$ . Therefore, as  $A \rightarrow \infty$   $Z_o \rightarrow \infty$  and a constant current may be fed to  $R_L$ .

For an operational amplifier of the 741 type,  $A = -jA_o f_o / f$  where  $A_o$  and  $f_o$  are typically  $10^5$  and 10Hz respectively. In this case  $Z_o \approx -jA_o f_o R / 4f$  or  $Z_o \approx -j\omega C$  so that  $Z_o$  consists of a capacitor  $C \approx 2/\pi f_o A_o R$ . For  $R = 10k\Omega$ ,  $C \approx 64pF$ . Thus, the constant load current will be 3dB down w.r.t. its low frequency value at  $f = 1/2\pi C R_L \approx A_o f_o R / 4R_L \approx 250/R_L$  (kHz) for a 741-type operational amplifier.

### Further reading

RCA Solid-State Databook: SSD-202A, application note ICAN-6668, 1973, pp. 311-24,

Application Manual for Operational Amplifiers, Philbrick/Nexus Research, 1968, pp. 66 and 97.

Smith, J. I., *Modern Operational Circuit Design*, Wiley-Interscience, 1971, pp. 155-9.

Cross references Series 6, cards 4 & 6.

© 1973 IPC Business Press Ltd.