

Conversion techniques adapt voltages to your needs

Different parts of your system often need specialized voltages. A variety of conversion techniques can help you obtain these voltages from the main supply.

Jim Williams, National Semiconductor Corp

Need more than one voltage in a single-supply system design? You can tailor the main system supply by using a variety of techniques; understanding how each works lets you choose the one most appropriate to producing the levels—and characteristics—you need.

Analog circuits need $\pm 15V$

Specifically, note that if you have a 5V logic rail available in your system but need $\pm 15V$, it's easy to

construct a dc/dc converter with an oscillator, a transformer and a rectifier circuit. However, most dc/dc converters suffer from large noise spikes generated by the fast-switching oscillator. So if the analog circuitry is especially sensitive to power-supply noise, you can eliminate or minimize the switching noise by using an interrupt-driven converter or a full-duty-cycle, low-noise converter.

Fig 1 shows an interrupt-driven circuit. The LM3524 switching regulator runs open-loop; its Q_1 - Q_2 output pair drives the step-up transformer. Unlike a standard

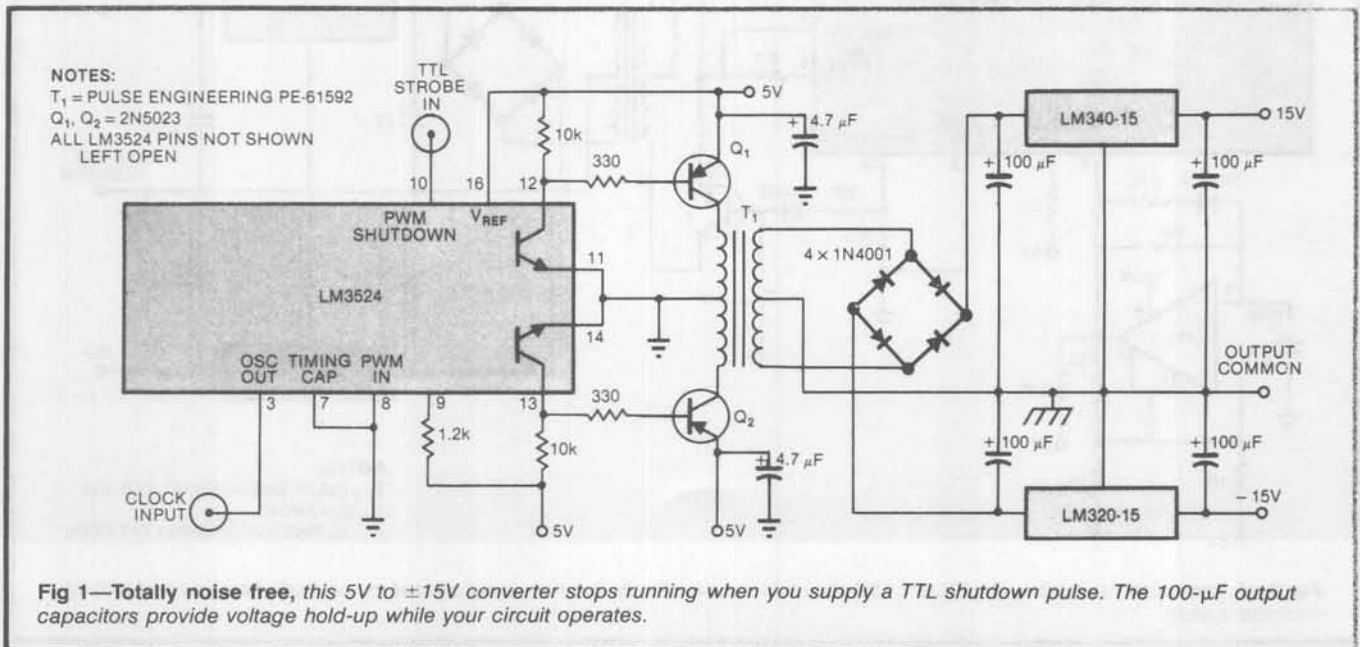

Interrupt switching for noise-free operation

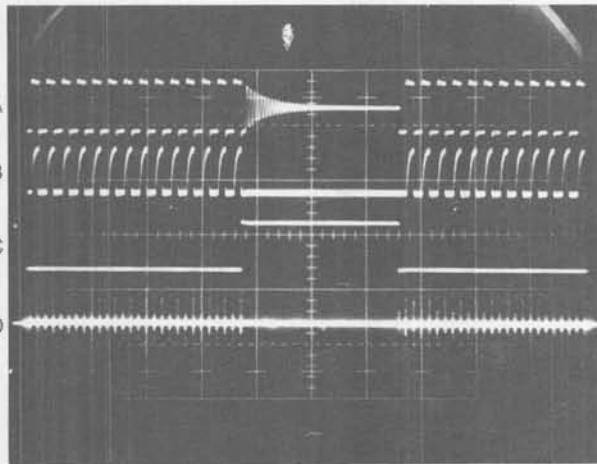

TRACE	VERTICAL	HORIZONTAL
A	10V/DIV	200 μSEC/DIV
B	1A/DIV	200 μSEC/DIV
C	5V/DIV	200 μSEC/DIV
D	20 mV/DIV (AC COUPLED)	200 μSEC/DIV

Fig 2—The center portion of this scope photo shows the drop in output noise (trace D) that occurs when Fig 1's converter shuts down.

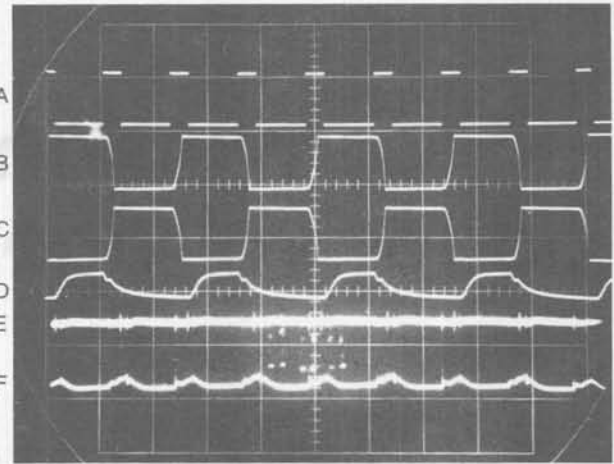

TRACE	VERTICAL	HORIZONTAL
A	5V/DIV	20 μSEC/DIV
B	10V/DIV	20 μSEC/DIV
C	10V/DIV	20 μSEC/DIV
D	500 mA/DIV	20 μSEC/DIV
E	2 mV/DIV (AC COUPLED)	20 μSEC/DIV
F	100 mV/DIV	20 μSEC/DIV

Fig 4—Barely discernible spikiness is visible in the output (trace E) of Fig 3's low-noise converter.

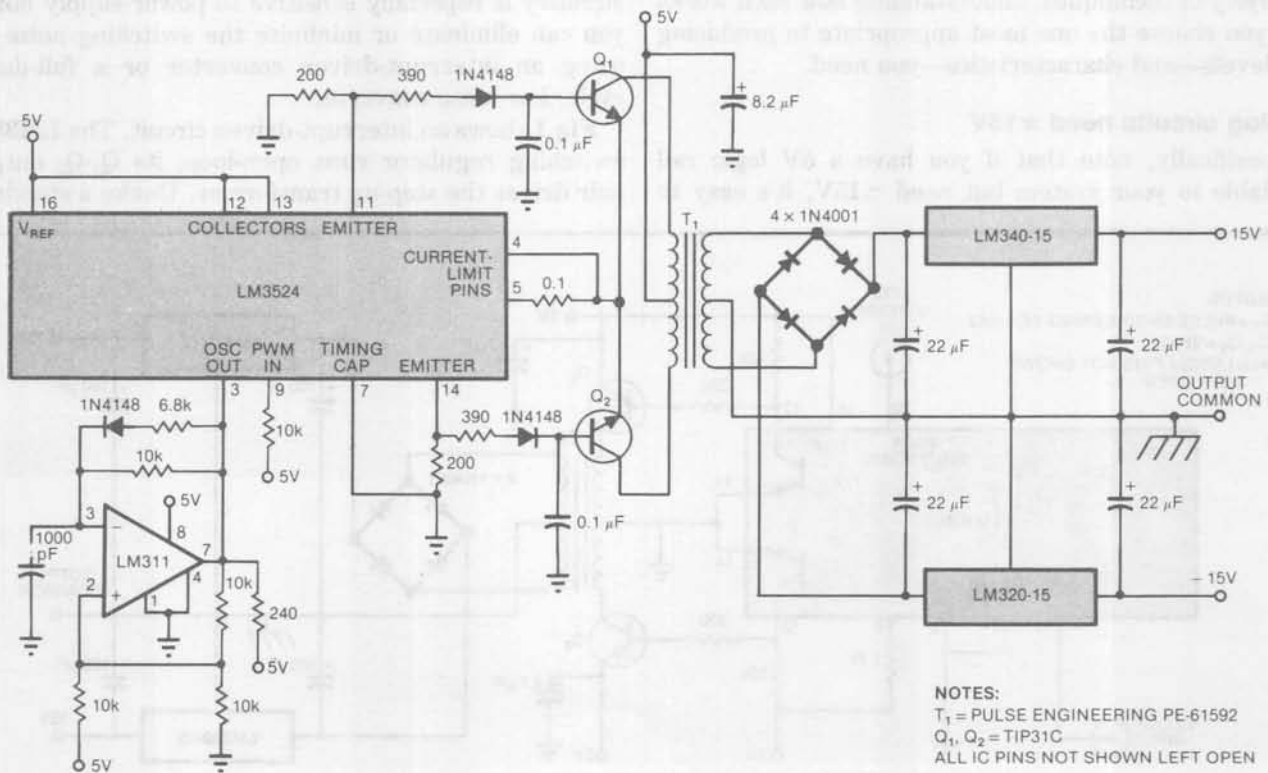

Fig 3—A low-noise converter, this 5V to ±15V circuit runs continuously, but the output transistors' controlled turn-on and turn-off minimize spikes.

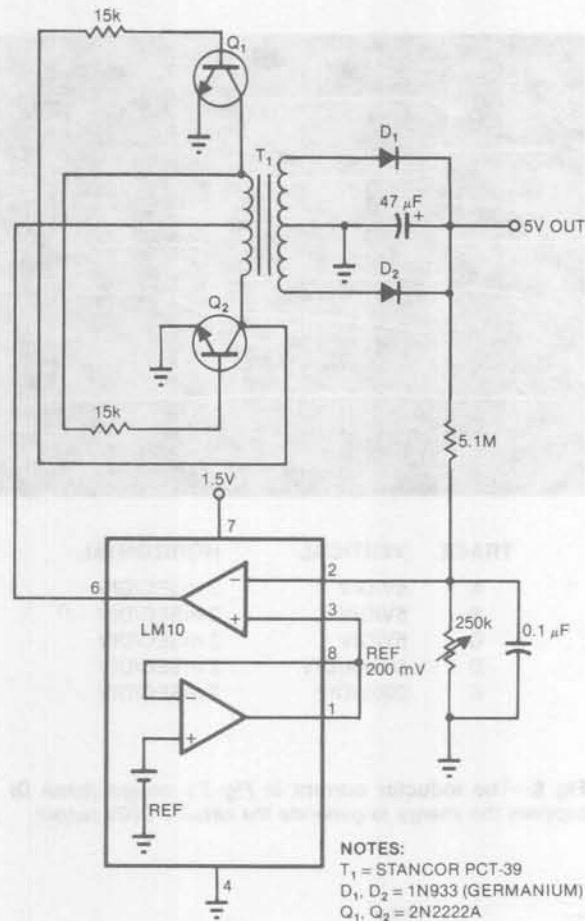

Fig 5—Powered by a 1.5V battery, this 5V-output design can drive low-power circuitry for months from one cell.

dc/dc converter, this circuit uses an external clocked oscillator, allowing you to synchronize the converter to the host system. To use this feature, you disable the LM3524's internal oscillator by grounding the capacitor timing pin and apply the system clock to the oscillator output, yielding a 50% switching duty cycle.

To obtain a noise-free $\pm 15V$ output for a critical circuit operation such as an A/D conversion or a sample/hold acquisition, interrupt the switching by applying a TTL-level pulse to the LM3524's shutdown pin. This action stops the converter, leaving the large output capacitors as a virtually noiseless dc source to power the output regulators.

Fig 2 details the circuit's performance; traces A and B show Q₁'s voltage and current waveforms, respectively (Q₂'s waveforms are similar). Trace D depicts the 15V output line (the -15V line is similar): The noise pulses caused by the switching circuitry are clearly visible. When the interrupt pulse is applied (trace C), the noise disappears. The large output filter capacitors

provide adequate $\pm 15V$ holdup time for the critical operation required while the interrupt pulse is HIGH.

Don't interrupt—just quiet down

If you need a 5V to $\pm 15V$ converter with low (but not necessarily zero) noise, consider the continuously running circuit shown in Fig 3. Here, the LM311 multivibrator clocks the LM3524 (Fig 4, trace A), whose internal oscillator is again disabled by grounding the timing-capacitor pin. While the LM311's output is HIGH, the LM3524 cuts the drive to Q₁ and Q₂, helping to minimize switching noise.

The main contributor to low-noise performance is the base-drive slowdown network used with Q₁ and Q₂: The 390 Ω /0.1- μ F time constant slows turn-on, and the diode forces base-emitter charge trapping to delay turn-off.

The effect of these components is evident in the Q₁-Q₂ collector-voltage waveforms (Fig 4, traces B and C) and Q₂'s current waveform (Fig 4, trace D). Note that the LM311's long ON time permits no current to flow in Q₂ until well after Q₁ has turned off. Moreover, the current's rise and fall times are smoothly controlled and long, unlike those of the more common fast-switching converters. Therefore, very little harmonic content appears in the transformer drive, so converter output noise (Fig 4, trace E) is exceptionally low. In addition,

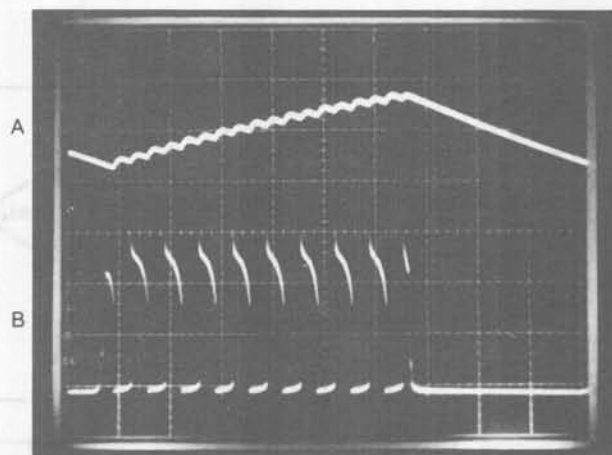

TRACE	VERTICAL	HORIZONTAL
A	0.1V/DIV (AC COUPLED)	10 mSEC/DIV
B	1V/DIV	10 mSEC/DIV

Fig 6—The on-demand operation of Fig 5's 1.5V to 5V converter is evident in this scope photo. The converter turns on when the output drops to approximately 4.93V and off when it rises to roughly 5.07V.

Power CMOS ICs for months with one D cell

the disturbance to the 5V rail (Fig 4, trace F) is small compared with standard designs.

This circuit's low noise comes at the expense of efficiency and available output power, though: During the slow base transitions, Q_1 and Q_2 dissipate power, reducing efficiency to about 50% and available output to approximately 50 mA. Heat-sinking Q_1 and Q_2 won't help, either, because it involves the risk of secondary breakdown. The circuit is, however, short-circuit protected by the 0.1Ω emitter resistor and the LM3524's current-limiting circuitry.

Power circuits from a battery

What if your basic system supply is a battery? The circuit depicted in Fig 5 supplies 5V from a 1.5V source—such as a battery, saltwater cells or a solar-cell stack. With 125- μ A load current (typically 20 CMOS ICs), it runs for 3 months on one D cell.

The circuit is unusual because the amount of time required for Q_1 and Q_2 to drive the transformer is directly related to the load resistance. The LM10 op-amp/reference IC compares the converter's output with its own internal 200-mV reference via the 5.1-M Ω /250-k Ω voltage divider. Whenever the converter's output drops below 5V, the LM10 output goes HIGH, driving the Q_1 - Q_2 - T_1 oscillator circuit. The rectified transformer output then charges the 47- μ F

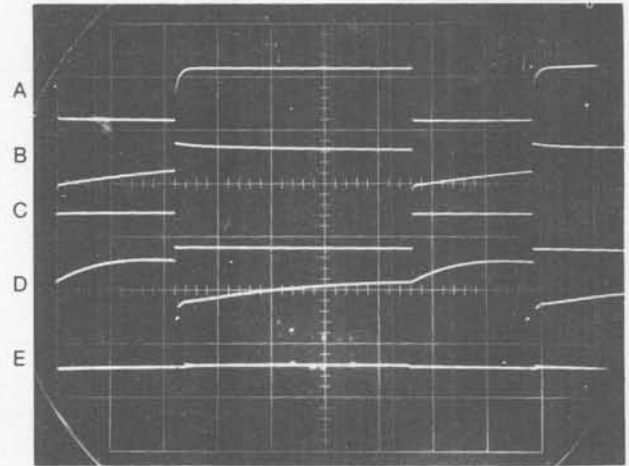

TRACE	VERTICAL	HORIZONTAL
A	5V/DIV	2 mSEC/DIV
B	5V/DIV	2 mSEC/DIV
C	5V/DIV	2 mSEC/DIV
D	50 mA/DIV	2 mSEC/DIV
E	200V/DIV	2 mSEC/DIV

Fig 8—The inductor current in Fig 7's design (trace D) supplies the energy to generate the circuit's 200V output.

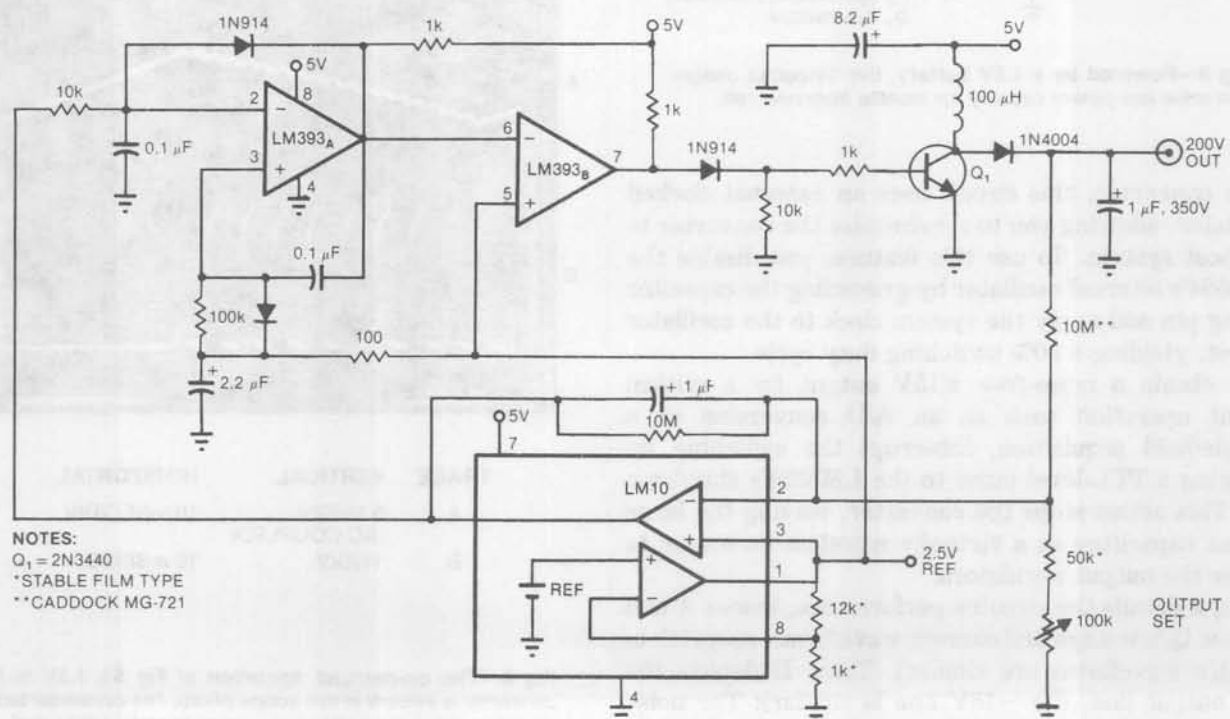

Fig 7—A 40-fold multiplication of the 5V supply results with this flyback-type converter. It furnishes 200V into a 500- μ A load.

Use a typical circuit to obtain high voltages

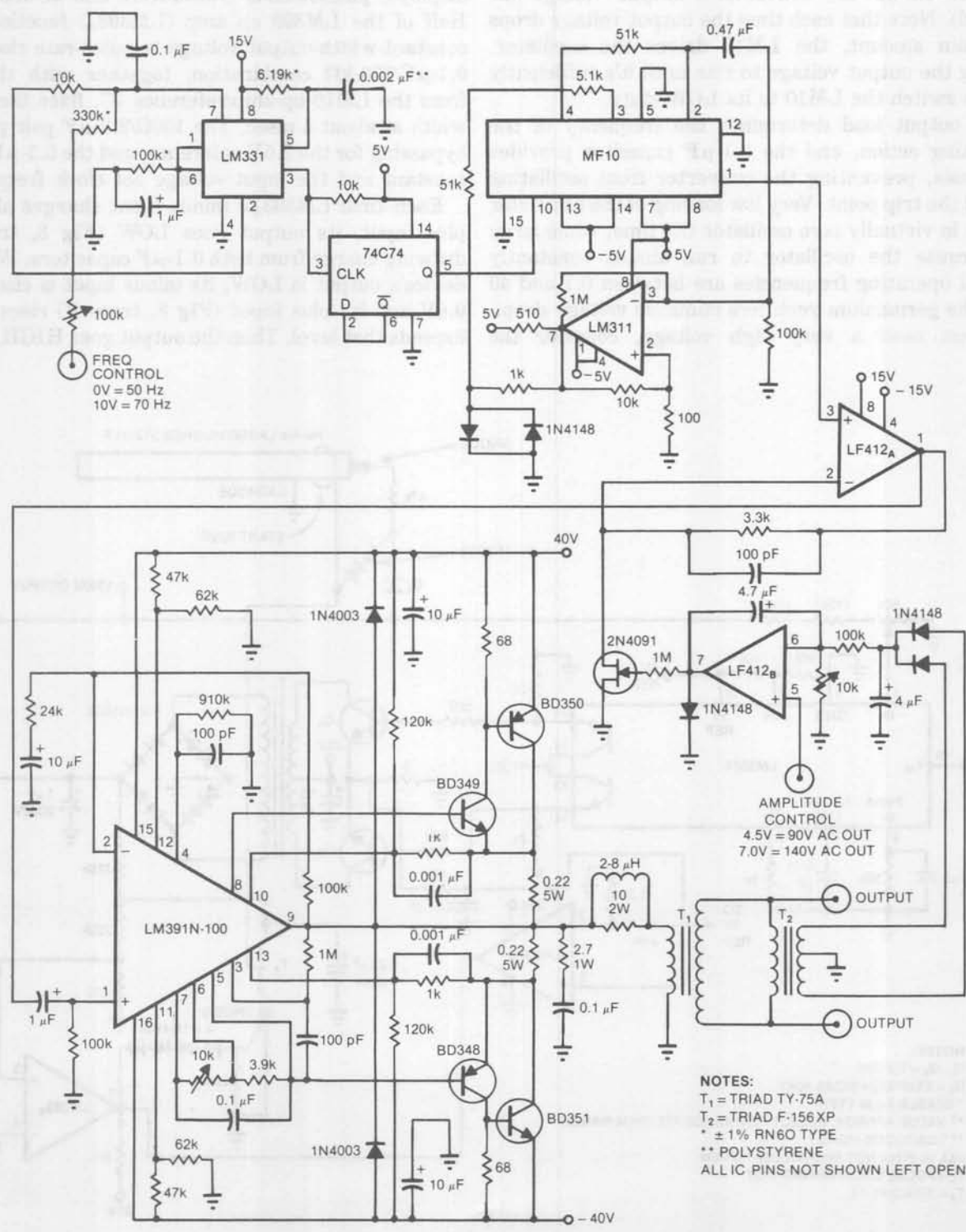

Fig 9—Test line-operated devices with this variable-voltage and -frequency converter. From a 40V dc input, you can get 90 to 140V ac at 50 to 70 Hz.

Use a flyback circuit to obtain high voltages

capacitor to a value high enough to cause the LM10 output to go LOW, thereby cutting off the oscillation.

In Fig 6, trace B shows the collector voltage of Q₁; trace A shows the converter's output voltage (ac coupled). Note that each time the output voltage drops a certain amount, the LM10 drives the oscillator, causing the output voltage to rise until it's sufficiently high to switch the LM10 to its LOW state.

The output load determines the frequency of the regulating action, and the 0.1- μ F capacitor provides hysteresis, preventing the converter from oscillating around the trip point. Very low loading of the converter results in virtually zero oscillator ON time, while large loads cause the oscillator to run almost constantly (typical operating frequencies are between 0.1 and 40 Hz). The germanium rectifiers minimize voltage drop.

If you need a very high voltage, consider the

flyback-type converter shown in Fig 7. It generates 200V (regulated) into a 500- μ A load from a 5V supply and thus serves applications such as gas-discharge displays, piezoelectric transducers and strobe lamps. Half of the LM393 op amp (LM393_A) functions as a constant-width-output voltage-to-pulse-rate clock. The 0.1- μ F/100-k Ω combination, together with the 2.5V from the LM10 op-amp/reference IC, fixes the output width at about 4 msec. The 100 Ω /2.2- μ F pair provides bypassing for the 2.5V reference, and the 0.1- μ F/10-k Ω constant and the input voltage set clock frequency.

Each time LM393_A's minus input charges above its plus input, its output goes LOW (Fig 8, trace A), drawing charge from both 0.1- μ F capacitors. When the device's output is LOW, its minus input is clamped at 0.6V and its plus input (Fig 8, trace B) rises until it exceeds that level. Then the output goes HIGH, ending

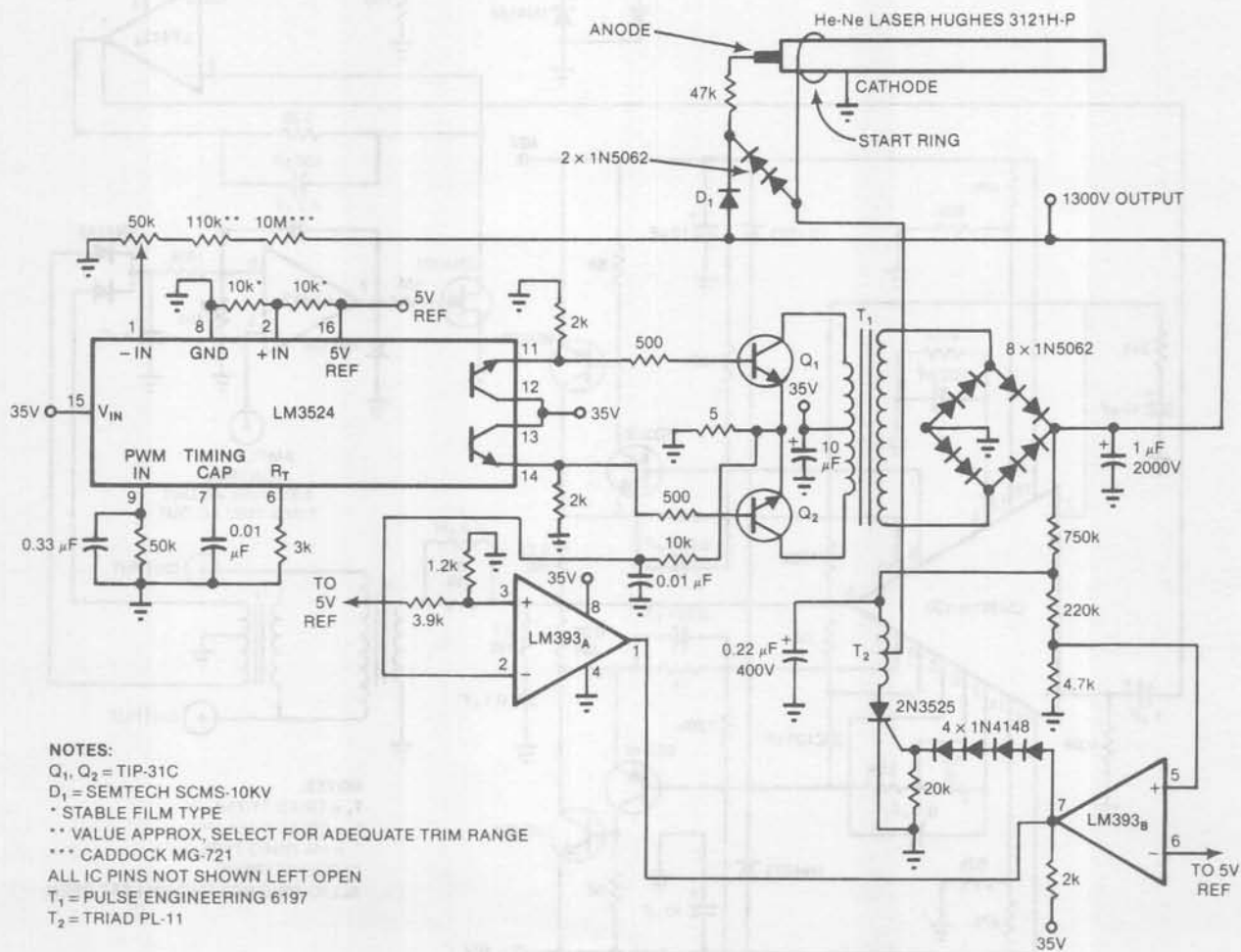

Fig 10—Start and run a laser with this 35V to 1300V converter. It furnishes an 8000V pulse that repeats as often as needed until the laser starts.

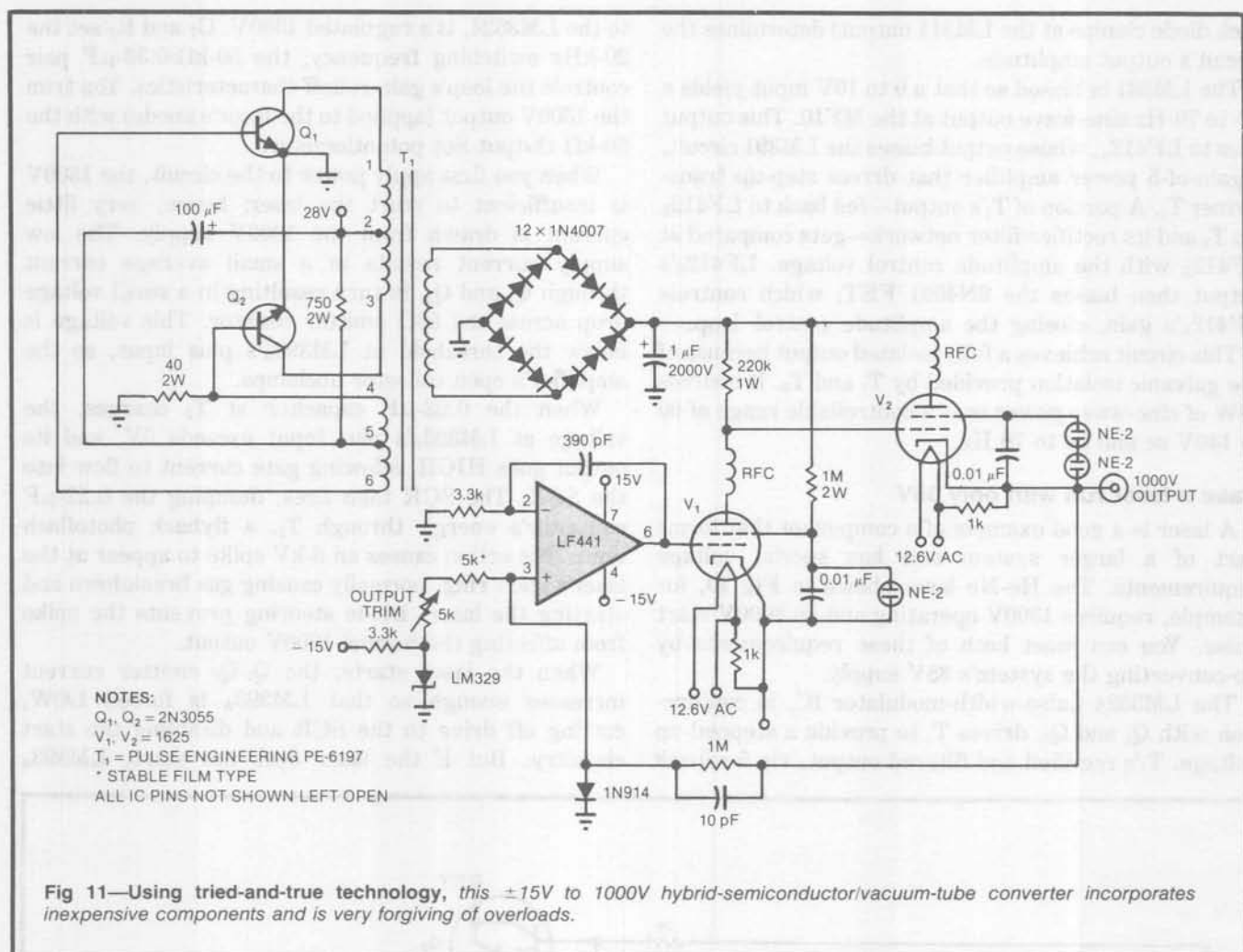

Fig 11—Using tried-and-true technology, this ±15V to 1000V hybrid-semiconductor/vacuum-tube converter incorporates inexpensive components and is very forgiving of overloads.

the timing cycle and reinitializing the entire process. The 1N914 diode prevents a differentiated positive response at LM393_A's plus input, allowing the circuit to recover quickly for the next cycle.

LM393_B, meanwhile, inverts the clock's output and drives Q₁. When this op amp's output goes HIGH (Fig 8, trace C), Q₁ turns on, its collector current rises (Fig 8, trace D) and the 100-µH inductor stores energy. (*Ed Note: The current probe is ac coupled—the long tail is actually flat.*) When LM393_B's output goes LOW, the magnetic field in the inductor collapses and Q₁'s collector voltage rises to about 200V (Fig 8, trace E). This high-voltage spike gets clamped and stored by the 1N4004/1-µF combination at the circuit's output.

The LM10 compares a divided-down portion of the output with its 2.5V internal reference. The difference voltage at the LM10 output then closes the loop at LM393_A's clock. The 10-MΩ/1-µF feedback components set loop gain and frequency compensation.

Vary voltage, frequency with ac line converter

If you must generate a variable-frequency and

-amplitude ac supply from a 40V source, consider Fig 9's circuit. This arrangement is ideal for testing 115V ac, 60-Hz line-powered loads for sensitivity to amplitude and frequency variations. The frequency of its sinusoidal output is voltage controllable from 50 to 90 Hz; output amplitude is also voltage controllable over a 90 to 140V ac range.

In the circuit, the LM331 V/F converter and flip flop form a voltage-controlled square-wave clock that drives the MF10 filter. That device, together with an LM311 comparator, forms a resonator that generates stable-amplitude sine outputs without using AGC circuitry. The MF10 operates as a Q-of-10 bandpass filter that rings at its resonant frequency in response to a step input. The LM311, upon receipt of this ringing signal, creates a square-wave input signal for the bandpass to regenerate the oscillation.

The bandpass output is the filtered fundamental frequency of a 50%-duty cycle square wave. The clock controls the filter's center frequency, in turn setting the oscillation frequency. The peak-to-peak swing of the MF10's square-wave input (defined by the back-to-

Build an isolated ac supply using a bandpass-filter IC

back diode clamps at the LM311 output) determines the circuit's output amplitude.

The LM331 is biased so that a 0 to 10V input yields a 50- to 70-Hz sine-wave output at the MF10. This output goes to LF412_A, whose output biases the LM391 circuit, a gain-of-5 power amplifier that drives step-up transformer T₁. A portion of T₁'s output—fed back to LF412_B via T₂ and its rectifier/filter network—gets compared at LF412_B with the amplitude control voltage. LF412_B's output then biases the 2N4091 FET, which controls LF412_A's gain, closing the amplitude control loop.

This circuit achieves a fully isolated output because of the galvanic isolation provided by T₁ and T₂. It sources 10W of sine-wave power over a controllable range of 90 to 140V ac and 50 to 70 Hz.

Make a laser run with only 35V

A laser is a good example of a component that forms part of a larger system and has special voltage requirements. The He-Ne laser shown in Fig 10, for example, requires 1300V operating and an 8000V start pulse. You can meet both of these requirements by up-converting the system's 35V supply.

The LM3524 pulse-width-modulator IC, in conjunction with Q₁ and Q₂, drives T₁ to provide a stepped-up voltage. T₁'s rectified and filtered output, via feedback

to the LM3524, is a regulated 1300V. C_T and R_T set the 20-kHz switching frequency; the 50-kΩ/0.33-μF pair controls the loop's gain-rolloff characteristics. You trim the 1300V output (applied to the laser's anode) with the 50-kΩ Output Set potentiometer.

When you first apply power to the circuit, the 1300V is insufficient to start the laser; hence, very little current is drawn from the 1300V supply. The low supply current results in a small average current through Q₁ and Q₂, in turn resulting in a small voltage drop across the 50Ω emitter resistor. This voltage is below the threshold at LM393_A's plus input, so the amplifier's open collector unclamps.

When the 0.22-μF capacitor at T₂ charges, the voltage at LM393_B's plus input exceeds 5V, and its output goes HIGH, allowing gate current to flow into the SCR. The SCR then fires, dumping the 0.22-μF capacitor's energy through T₂, a flyback photoflash unit. This action causes an 8-kV spike to appear at the laser's start ring, normally causing gas breakdown and starting the laser. Diode steering prevents the spike from affecting the normal 1300V output.

When the laser starts, the Q₁-Q₂ emitter current increases enough so that LM393_A is forced LOW, cutting off drive to the SCR and disabling the start circuitry. But if the laser does not start, LM393_A

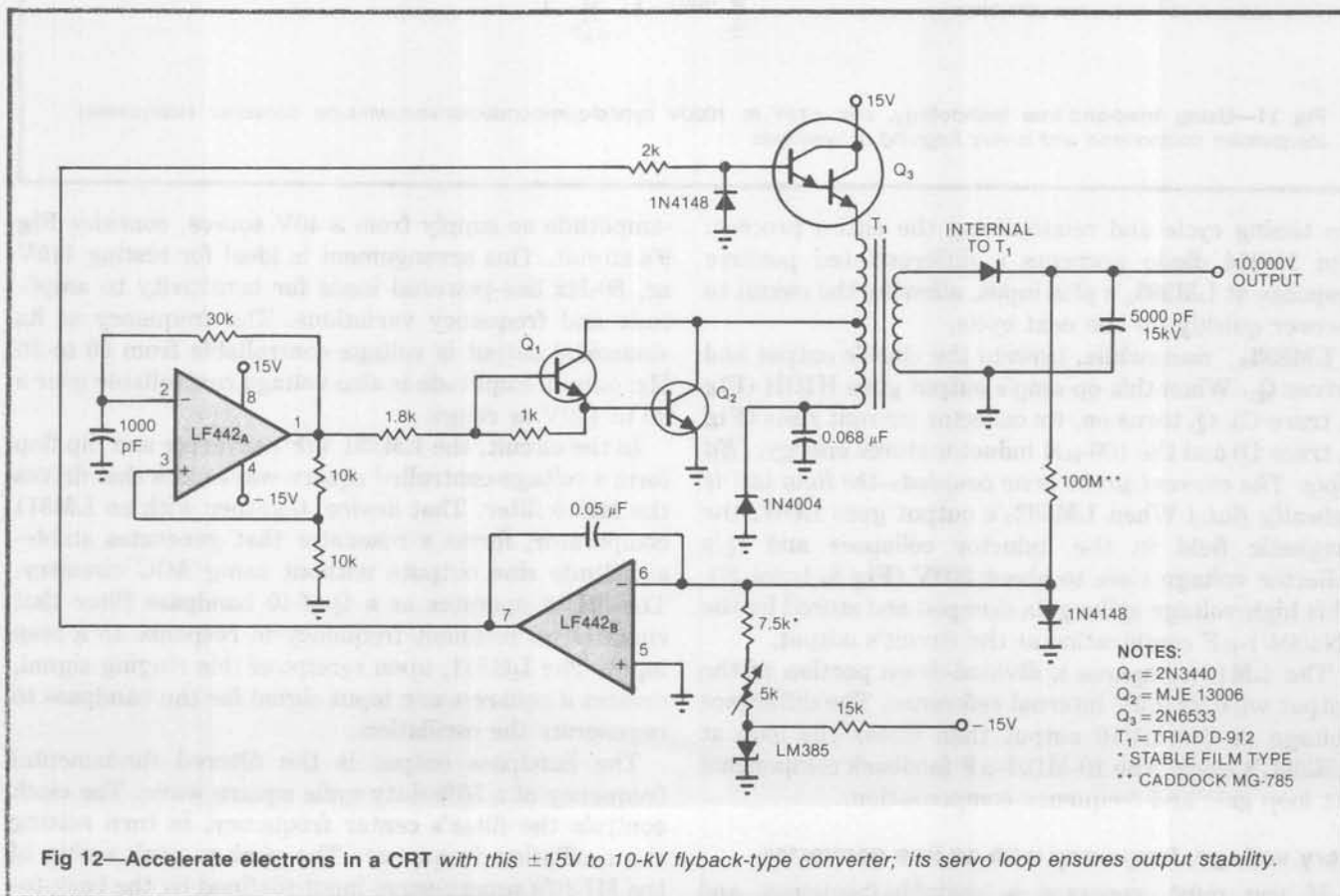

Fig 12—Accelerate electrons in a CRT with this ±15V to 10-kV flyback-type converter; its servo loop ensures output stability.

Meet lasers' special needs with a PWM IC

remains unclamped. When the 0.22- μ F capacitor charges fully, LM393's plus input exceeds 5V, and the SCR again drives T_2 , producing the 8-kV start pulse. This action continues until the laser runs.

Don't write off vacuum tubes

Fig 10's laser supply achieves its 1300V output through servo control around a transformer. A potential problem with this type of converter is that its transient response is limited by the modulation frequency applied to the transformer. The best way to avoid the problem is to regulate with a series-pass

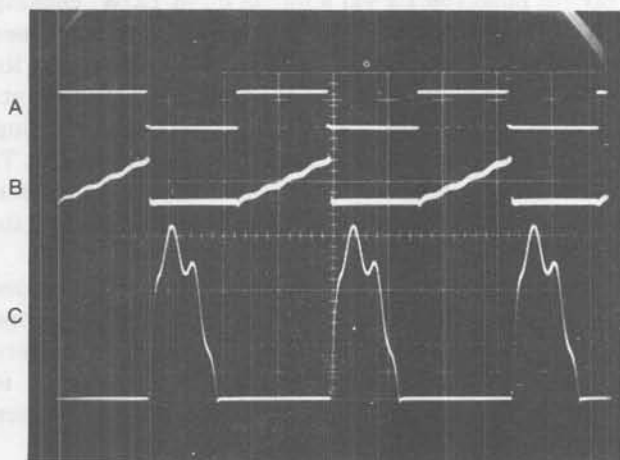

TRACE	VERTICAL	HORIZONTAL
A	50V/DIV	20 μ SEC/DIV
B	4A/DIV	20 μ SEC/DIV
C	50V/DIV	20 μ SEC/DIV

Fig 13—Magnetic-field collapse in Fig 12's T_1 primary produces the high Q_2 collector-voltage pulses in trace C.

element on the transformer's high-voltage side. But this action usually implies the use of expensive high-voltage transistors and a substantial amount of protective circuitry. Fig 11 shows a converter that deals with these problems. It's inexpensive, provides the fast transient response of a series regulator and requires no output protection. Moreover, it withstands short circuits and output-current or -voltage reversals arising from reactive loads.

The self-exciting dc/dc converter composed of T_1 , Q_1 , Q_2 and their associated components generates the unregulated high voltage from a 28V supply. This converter's rectified and filtered output is applied to the plates of the two 1625 vacuum tubes, which are configured in a common-cathode-driven cathode-

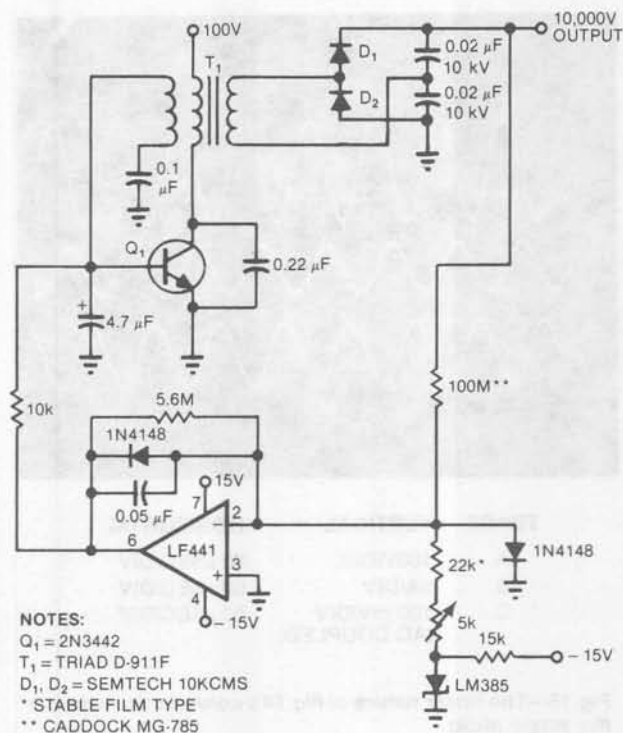

NOTES:

- Q_1 = 2N3442
- T_1 = TRIAD D-911F
- D_1, D_2 = SEMTECH 10KCMS
- * STABLE FILM TYPE
- ** CADDOCK MG-785

Fig 14—Using sinusoidal signals, this converter supplies 10 kV with no radiated noise or spikiness.

follower arrangement, with NE-2 neon-lamp screen-to-cathode clamps. Feedback from V_2 to the LF441 provides overall loop stabilization. The 390-pF/3.3-k Ω pair provides local rolloff at the LF441; overall compensation comes from the 10-pF/1-M Ω network. The 1N914 prevents capacitively coupled transients from appearing at the LF441's input.

Set the output voltage with the 5-k Ω potentiometer at the LM329 reference. The power-handling capability of T_1 limits the circuit's output to 10W at 1000V—a chore that V_2 can perform effortlessly. If you anticipate extended (greater than 5 min) short circuits at the output, consider fusing V_2 's plate circuit.

Multiply $\pm 15V$ for voltage-hungry CRTs

In data-terminal designs, you must often convert the supply rails to the high voltage needed for CRT electron-beam acceleration. You can use a flyback approach for this task, but for more demanding applications (such as oscilloscopes), you might have to use a sine-wave conversion technique. So consider examples of conversion circuits that use each method.

In Fig 12's flyback circuit, LF442A functions as an oscillator whose output (Fig 13, trace A) drives the Q_1 - Q_2 Darlington pair. When the output is HIGH, Q_1 and Q_2 conduct and the current through T_1 's primary

Use vacuum tubes for a low-cost high-voltage supply

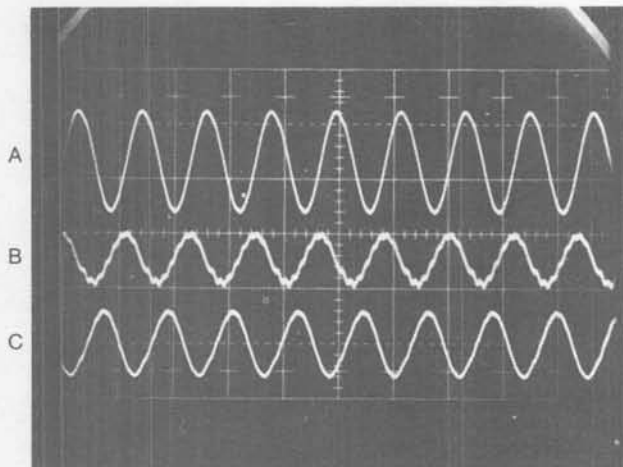

TRACE	VERTICAL	HORIZONTAL
A	100V/DIV	50 μ SEC/DIV
B	5A/DIV	50 μ SEC/DIV
C	100 mV/DIV (AC COUPLED)	50 μ SEC/DIV

Fig 15—The linear nature of Fig 14's converter is evident in this scope photo.

builds up (Fig 13, trace B). When LF442_A goes LOW, however, the field in T₁'s primary collapses and a large flyback voltage appears at Q₂'s collector (Fig 13, trace

C). This field collapse also appears at T₁'s secondary and produces a very-high-voltage output, which is rectified and filtered and fed back to LF442_B via a divider. LF442_B's output then servo-controls Q₃, which determines the amount of drive available to T₁. The 0.05- μ F capacitor provides stable loop compensation; the LM385 and the 5-k Ω pot set the output voltage.

Although effective, this circuit produces unavoidable radiated noise and supply spiking—which some sensitive data terminals and oscilloscopes can't tolerate. Fig 14's sine-wave-based high-voltage converter eliminates these problems.

When you apply power to this circuit, the LM385 reference pulls the LF441's minus input LOW, causing the LF441's output to rise. This action in turn causes Q₁'s collector voltage to drop (Fig 15, trace A) and its collector current to rise (Fig 15, trace B). Concurrently, the 0.1- μ F capacitor in T₁'s feedback winding charges to a negative voltage. When the current in T₁ stops building, T₁'s feedback winding pulls Q₁'s base negative (Fig 15, trace C), cutting off Q₁ and causing its collector voltage to rise.

When the voltage on the 0.1- μ F capacitor becomes positive, Q₁ starts to conduct, its collector voltage drops and the cycle repeats. The 0.22- and 4.7- μ F capacitors provide stabilization, and the high-voltage output is current-summed with the LM385's negative reference current at the LF441 servo amplifier.

The LF441's output servo-controls the drive to Q₁,

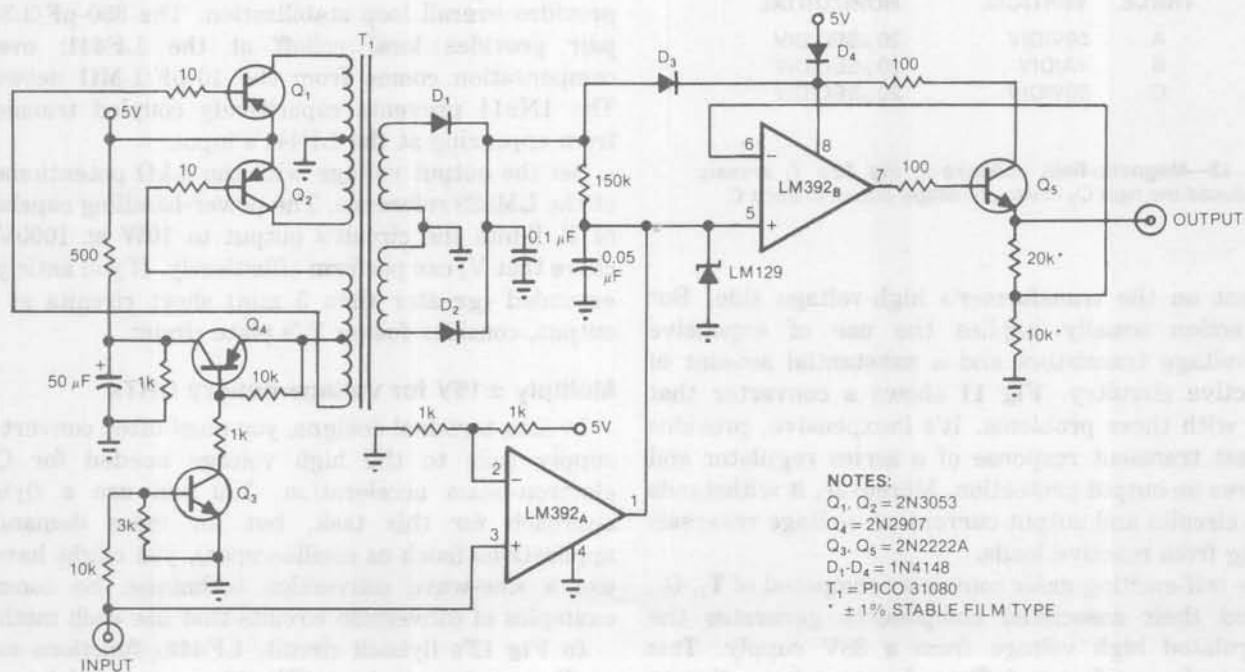

Fig 16—Memories are made of this—a converter that supplies the 21V pulses for EEPROM programming. It achieves controlled rise time; you determine the pulse's width with a TTL command.

Generate EPROM-programming pulses from the 5V rail

closing the feedback loop around the transformer. Because the transformer isn't used in the flyback mode, the voltage step-up ratio is smaller than in Fig 12's design, so you need higher initial input voltages. Alternatively, you could use a voltage-doubler network at the transformer output.

An easy way to power memory programming

What about the voltage required by programmable memories? Widely used EEPROM types such as the 2816 require controlled-rise-time 21V pulses for programming. Fig 16 shows a converter that generates the necessary high-voltage pulses from the 5V rail.

T₁, in conjunction with Q₁ and Q₂, forms a self-driven 5 to 30V dc/dc converter. Q₃ and Q₄ serve as a strobe for this converter, allowing it to draw power and run only when a TTL signal is present at the circuit's input. When you apply a signal to the input (Fig 17, trace A), the Q₃-Q₄ pair conducts, biasing Q₁ and Q₂ so the converter runs (Q₂'s collector waveform appears in Fig 17, trace B). The converter's output (Fig 17, trace C) is very lightly filtered by the 0.1- μ F capacitor, allowing it to rise quickly. This output charges the 0.05- μ F/150-k Ω combination.

The gain-of-3 LM392_B amplifies the 0.05- μ F capacitor voltage; Q₅ serves as an output-current booster. As the 0.05- μ F capacitor charges, Q₅'s emitter voltage rises,

providing the leading edge of the programming pulse (Fig 17, trace D). When the capacitor voltage reaches 7V, the LM129 clamps, charging ceases and the output remains at 21V.

When you switch the TTL input pulse LOW, the LM392_A's open-collector output clamps LOW, discharging the 0.05- μ F capacitor and readying the circuit for the next pulse. You can satisfy any EEPROM's programming requirement by varying the gain of LM392_B, the time constant at its input or the zener clamp across the 0.05- μ F capacitor. **EDN**

Author's biography

Jim Williams, now a consultant, was applications manager in National Semiconductor's Linear Applications Group (Santa Clara, CA), specializing in analog-circuit and instrumentation development, when he wrote this article. Before joining the firm, he served as a consultant at Arthur D Little Inc and directed the Instrumentation Development Lab at the Massachusetts Institute of Technology. A former student of psychology at Wayne State University, Jim enjoys tennis, art and collecting antique scientific instruments in his spare time.

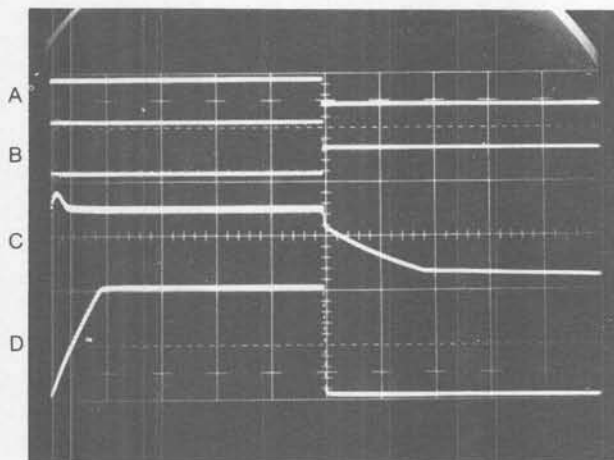

TRACE	VERTICAL	HORIZONTAL
A	10V/DIV	2 mSEC/DIV
B	10V/DIV	2 mSEC/DIV
C	20V/DIV	2 mSEC/DIV
D	10V/DIV	2 mSEC/DIV

Fig 17—The programming pulse of Fig 16's circuit appears in trace D. Note the cleanly rising leading edge.

References

1. Tektronix Inc, *CRT Circuit*, Operating Manual 453, pgs 3-16.
2. Regan, Tim, *Introducing the MF10*, Application Note, National Semiconductor Corp, Santa Clara, CA.
3. John Fluke Mfg Co, *Operating Manual—Model 415B High Voltage Supply*.
4. Kepco Inc, *Operating Manual—Model BHK-2000-01M*.
5. Williams, Jim, "Design dc/dc converters to catch noise at the source," *Electronic Design*, October 15, 1981, pgs 229-234.