

CARNEGIE MELLON UNIVERSITY

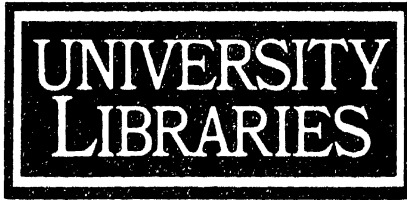

PRESENTED BY

Mrs. W.K. Lockhart

ELECTRIC LIGHTING



McGraw-Hill Book Co. Inc.

PUBLISHERS OF BOOKS FOR

Electrical World ∇ Engineering News-Record
Power ∇ Engineering and Mining Journal-Press
Chemical and Metallurgical Engineering
Electric Railway Journal ∇ Coal Age
American Machinist ∇ Ingenieria Internacional
Electrical Merchandising ∇ BusTransportation
Journal of Electricity and Western Industry
Industrial Engineer

ELECTRIC LIGHTING

BY

OLIN JEROME FERGUSON, B. S. IN E. E., M. E. E.

PROFESSOR OF ELECTRICAL ENGINEERING, AND DEAN OF THE COLLEGE OF ENGINEERING
UNIVERSITY OF NEBRASKA; FELLOW, AMERICAN INSTITUTE OF ELECTRICAL ENGI-
NEERS; MEMBER, NATIONAL ELECTRIC LIGHT ASSOCIATION; MEMBER,
SOCIETY FOR PROMOTION OF ENGINEERING EDUCATION; MEMBER
ILLUMINATING ENGINEERING SOCIETY

FIRST EDITION
THIRD IMPRESSION

McGRAW-HILL BOOK COMPANY, INC.
NEW YORK: 370 SEVENTH AVENUE
LONDON: 6 & 8 BOUVERIE ST., E. C. 4

1920

COPYRIGHT, 1920, BY THE
MCGRAW-HILL BOOK COMPANY, INC.

PRINTED IN THE UNITED STATES OF AMERICA

PREFACE

Next to the human need for food, shelter and clothing, comes the need for artificial light. The meeting of this requirement, upon a large scale, becomes an engineering proposition and electric lighting stands prime among various agencies used therefor, when illuminants are classified according to their effectiveness, adaptability, flexibility and efficiency.

There are few engineering activities which have advanced more rapidly during the last few years than have the art and practice of electric lighting. Illuminants have been steadily improved and refined. New types of lamps have been developed giving better colors of light, more efficient light production, cheaper units and a greater range of sizes.

Principles of illumination have been studied and applied in the better solution of lighting problems. Indirect lighting, semi-or complete, has introduced great possibilities into the handling of both small and large installations. The economic value of good lighting is better appreciated.

Color is beginning to play an important part in lighting schemes. It is destined to become even more widely utilized.

There are excellent books which satisfactorily cover certain portions of the field which is understood to be included by the term "Electric Lighting." Generally speaking, however, they emphasize some one phase of the subject, to the partial exclusion of other equally worthy considerations. This limits their usefulness as text-books and it has been the aim of the author to meet the need in this particular by the production of a well-balanced presentation of fundamentals, with principles and practice appearing through the whole work.

It is not thought necessary to make this treatise a voluminous one. Those users who desire more subject matter will find unlimited amounts of it in the sources which are frequently cited in the references made.

The author has been greatly assisted by information received from several manufacturers, including the General Electric Co., the Westinghouse Electric and Manufacturing Co. and the Na-

tional X-Ray Co. Numerous individuals have also very actively contributed to the completion of the manuscript by direct responses to inquiries and requests. For these many courtesies, the author hereby expresses his deep appreciation.

OLIN JEROME FERGUSON.

UNIVERSITY OF NEBRASKA, LINCOLN,
November 11, 1919.

CONTENTS

	PAGE
PREFACE	v
CHAPTER I	
CONDUCTORS	1
Materials, copper and iron—Approximate methods of calculation—Sizes—Insulation.	
CHAPTER II	
WIRING	13
General considerations. Entrances—Grounding—Residence lay-out—Office building.	
CHAPTER III	
CIRCUITS.	25
Series vs. parallel—Potential gradients—Networks—Feeders—Excess-voltage feeders—Multiwire systems.	
CHAPTER IV	
APPARATUS.	38
Switchboards—Potential regulators—Constant-current transformers—Mercury arc rectifier—Demand indicators.	
CHAPTER V	
INCANDESCENT LAMPS	50
History—Manufacture—Metal filaments—Gas-filled globes—Lamp details—Light flux—Rating—Efficiency—Life—Operating characteristics—Specific outputs.	
CHAPTER VI	
THE ARC.	63
History—Description—Flaming arcs—Luminous arcs.	
CHAPTER VII	
GAS TUBE LAMPS	69
General—Moore tube—Mercury vapor lamp.	

	PAGE
CHAPTER VIII	
ILLUMINATION.	73
Classification of systems—Direct vs. indirect units—Errors in illumination.	
CHAPTER IX	
THE EYE.	77
Physiology—Sensitivity—Protection—Properties as a physical instrument.	
CHAPTER X	
LIGHT.	82
Definition—Radiation—Black, white and colored bodies—Reflection—Coefficients of reflection—Absorption—Transmission—Colors of light sources—Luminescence—Refraction—Vision—Fatigue—Glare.	
CHAPTER XI	
PHOTOMETRY.	98
Aims—Definitions—Nomenclature—Symbols—Standards—Photometers—Measurement of coefficient of reflection—Colorimeter—Spectrophotometer—Arc lamp photometry—Spherical calculation—Rousseau diagram—Set-of-constants—Absorption-of-light—Equilux spheres.	
CHAPTER XII	
SHADES AND REFLECTORS	137
Control of light flux emission—Materials—Types of reflection—Reflectors, types—Shades—Globes—Prismatic glassware.	
CHAPTER XIII	
ILLUMINATION CALCULATIONS	150
Illumination requirements—Effective flux—Effects of ceilings, walls and floors—Efficiency of utilization—Point-by-point calculations—Illumination contours—Flux-of-light—Effective angle—Indirect systems.	
CHAPTER XIV	
RESIDENCE LIGHTING	178
Needs of the various rooms and means of obtaining same.	
CHAPTER XV	
GENERAL OFFICES	186
Accounting rooms—Drafting rooms—Offices—Intensities needed—Methods.	

CONTENTS

ix

CHAPTER XVI

	PAGE
STORE LIGHTING	189
Large stores—Exclusive stores—Small stores—Kinds of merchandise—Efficiency of utilization—Show cases—Windows.	

CHAPTER XVII

FACTORY LIGHTING	197
Money value of good lighting—Lamps—Reflectors—Calculations—Basis for cost calculation.	

CHAPTER XVIII

AUDITORIUMS	204
Churches, auditoriums, ball rooms—Center chandelier—Indirect lighting—Architecture.	

CHAPTER XIX

SCHOOLS	206
Classification of rooms—Direction of light—Libraries—Glare.	

CHAPTER XX

ART GALLERIES	208
The Cleveland Museum of Art—Artificial sky-light illumination.	

CHAPTER XXI

STREETS	211
General considerations—Glare—Spacing of lamps—Height of suspension—Luminous arc lamps—Incandescent lamps—Lamp data—Classification of streets—Calculations.	

CHAPTER XXII

FLOOD LIGHTING YARDS, BUILDINGS, ETC.	224
Reflectors—Statuary—Buildings—Large areas—The projector.	

CHAPTER XXIII

COLOR	232
Place of color in lighting—Artificial daylight—Color in interiors—Exposition lighting for spectacular displays.	

CONTENTS

CHAPTER XXIV

	PAGE
RATES	235
Basis on which rates are established.	
APPENDIX	237
Tables used in illumination calculations.	
INDEX	239

ELECTRIC LIGHTING

CHAPTER I

CONDUCTORS

Materials Used.—Conductors used for electric lighting supply and distribution are usually of copper. The high cost of materials in 1915-18 has been especially noticeable in connection with copper wire. Prompt delivery has been an impossibility. As a consequence, there has been emphasized the need of the use of iron wire wherever it is found at all practicable, in either transmission or distribution. This practice has been adopted in a limited way but it is found to be surprisingly satisfactory in many particulars once considered well outside its field.

Copper.—Copper wire may be hard-drawn or soft-drawn. The former is annealed less frequently than the latter in the process of manufacture. The main physical differences which are noted for the hard-drawn are increased tensile strength, hardness, stiffness and resistance. The increase in strength is of the order of 40 to 70 per cent., depending upon the size of the wire. It is greater for the smaller wires because it results from the changed texture of the outer part or deep skin of the wire. For a small wire, this outer part affected is a greater percentage of total area of cross-section than it is for the large wire, hence the percentage increase in strength is greater. It is wholly on account of the increased strength that the wire is used. In fact, larger resistance, greater difficulty in bending, etc., are disadvantages.

The increase in resistance is only 3 to 4 per cent., however, and is allowable if greater strength is any object. Hence, for transmission, the hard-drawn wire is always used. It is necessary to guard against kinking, or nicking the wire or bending it too abruptly for its surface is responsible for its greater strength and an injury thereto is liable to cause failure. Moreover, such a surface injury is easily inflicted, due to the comparative brittleness of the hardened copper. The annealed wire is required

for all work where bending is frequent in the installation. A medium hard-drawn wire is considerably used.

Tables.—Tables are prepared showing the properties of copper wire graduated by the American Wire Gage (see Table 1). The mil is 0.001 inch, while the circular mil is the area of a circle with a diameter of one mil. A mil-foot of wire is a circular wire one mil in diameter and one foot long.

TABLE 1.—DATA ON STANDARD ANNEALED COPPER WIRE

American Wire Gage No.	Diameter in mils	Cross-section		Ohms per 1000 ft.		Ohms per mile		Pounds per 1000 ft	Pounds per mile
		Circular mils	Square inches	25°C. (= 77° F.)	65°C. (= 149° F.)	25°C. (= 77° F.)	65°C. (= 149° F.)		
0000	460	212,000	0.166	0.0500	0.0577	0.264	0.305	641.0	3,380.0
000	410	168,000	0.132	0.0630	0.0727	0.333	0.384	508.0	2,680.0
00	365	133,000	0.105	0.0795	0.0917	0.420	0.484	403.0	2,130.0
0	325	106,000	0.0829	0.100	0.116	0.528	0.613	319.0	1,680.0
1	289	83,700	0.0657	0.126	0.146	0.665	0.771	253.0	1,340.0
2	258	66,400	0.0521	0.159	0.184	0.840	0.972	201.0	1,060.0
3	229	52,600	0.0413	0.201	0.232	1.06	1.23	159.0	840.0
4	204	41,700	0.0328	0.253	0.292	1.34	1.54	126.0	665.0
5	182	33,100	0.0260	0.319	0.369	1.68	1.95	100.0	528.0
6	162	26,300	0.0206	0.403	0.465	2.13	2.46	79.5	420.0
7	144	20,800	0.0164	0.508	0.586	2.68	3.09	63.0	333.0
8	128	16,500	0.0130	0.641	0.739	3.38	3.90	50.0	264.0
9	114	13,100	0.0103	0.808	0.932	4.27	4.92	39.6	209.0
10	102	10,400	0.00815	1.02	1.18	5.39	6.23	31.4	166.0
11	91	8,230	0.00647	1.28	1.48	6.76	7.81	24.9	132.0
12	81	6,530	0.00513	1.62	1.87	8.55	9.87	19.8	105.0
13	72	5,180	0.00407	2.04	2.36	10.8	12.5	15.7	82.9
14	64	4,110	0.00323	2.58	2.97	13.6	15.7	12.4	65.5
15	57	3,260	0.00256	3.25	3.75	17.2	19.8	9.86	52.1
16	51	2,580	0.00203	4.09	4.73	21.6	25.0	7.82	41.3
17	45	2,050	0.00161	5.16	5.90	27.2	31.5	6.20	32.7
18	40	1,620	0.00128	6.51	7.51	34.4	39.7	4.92	26.0
19	36	1,290	0.00101	8.21	9.48	43.4	50.1	3.90	20.6
20	32	1,020	0.000802	10.4	11.9	54.9	62.8	3.09	16.3

This table is accurate to three significant figures, only.

Approximations.—It is frequently convenient to be able quickly to approximate the resistance of a given wire, or to estimate the size of a wire required for a given installation. This may be accomplished directly by the use of the resistance formula,

$$R = 9.38 l/d^2 \text{ for soft-drawn wire,}$$

$$\text{or } R = 9.59 l/d^2 \text{ for hard-drawn wire,}$$

where R = resistance in international ohms at 0°C.,

l = length of wire in feet,

d = diameter of wire in mils.

Another practical scheme for the same purpose and linking the calculation with the standard sizes of wire is based upon the following features of the A. W. G. An increase of three in the gage number divides the area of the wire by two. Successive numbers differ in area of cross-section by the factor $\sqrt[3]{2}$ or 1.26. For large changes this will give a factor of 10 in area of cross-section for a change of 10 in gage numbers.

As a starting point, it is convenient to remember that No. 10 wire is about 0.1 inch in diameter and has a resistance of about 1 ohm per 1000 feet, while it weighs 32 pounds per 1000 feet.

Example.—As an example of the use of this approximation process we might desire to know the size of wire required for use between arc lamps 100 feet apart, using 10 amperes, with two lamps connected in series across a 110-volt supply. This would necessitate a loop of 400 feet of wire and we will allow a 3 per cent. drop.

Line drop	= 3.3 volts
Resistance of line	= 0.33
Resistance per 1000 ft.	= 0.825 ohms

But as the resistance of No. 10 wire is 1 ohm per 1000 feet, so the required wire is larger than that.

$$\text{Resistance of No. 9} = \frac{1}{1.26} = 0.794 \text{ ohms per 1000 feet}$$

$$\text{Resistance of No. 8} = \frac{0.794}{1.26} = 0.63 \text{ ohms per 1000 feet}$$

Hence, No. 9 wire would be required, or if only even numbers are to be used we should take No. 8.

Iron Wire.—The life of iron wire is extremely variable, depending upon location as regards smoke, gases, etc. No. 10 galvanized iron wire has been known to fail in one year at a point close to the top of a boiler house smoke stack. Upon the other hand, iron wire used for telephone lines in country districts has been taken down after 20 years service, inspected, and then replaced on new pins.

The resistances of iron wire and steel wire are eight to ten times as high as that of copper wire of the same size. The resistivity of iron or steel depends on the size of wire, the frequency of the current alternations and the amount of current being carried. The variations are in the following directions:¹

¹ See U. S. *Bulletin*, Bureau of Standards. Vol. 12 (1915) p. 207, Effective Resistance and Inductance of Iron and Bimetallic Wires, JOHN M. MILLER.

TABLE 2.—DATA ON GALVANIZED IRON WIRE

Size B. W. G.	Diameter in mils	Approximate weight in pounds per mile	Approximate breaking load in pounds			Resistance per mile (ohms) at 68°F or 20°C.		
			Ex. B. B.	B. B.	Steel	Ex. B. B.	B. B.	Steel
0	340	1655	4138	4634	4965	2 84	3 38	3 93
1	300	1289	3223	3609	3867	3 65	4 34	5 04
2	284	1155	2888	3234	3465	4.07	4 85	5.63
3	259	960	2400	2688	2880	4.90	5.83	6 77
4	238	811	2078	2271	2433	5 80	6 91	8 01
5	220	693	1732	1940	2079	6.78	8.08	9 38
6	203	590	1475	1652	1770	7.97	9.49	11.02
7	180	463	1158	1296	1389	10.15	12.10	14.04
8	165	390	975	1092	1170	12.05	14.36	16.71
9	148	314	785	879	942	14.97	17.84	20.70
10	134	258	645	722	774	18.22	21.71	25.29
11	120	206	515	577	618	22.82	27.19	31.55
12	109	170	425	476	510	27.65	32.94	38 23
13	95	129	310	347	372	37.90	45.16	52.41
14	83	99	247	277	297	47.48	56.56	65.66
15	72	74	185	207	222	63.52	75.68	87.84
16	65	61	152	171	183	77.05	91.80	106.55

With increase in size of wire, ρ increases. Moreover, the percentage increase of ρ due to increase in size of wire is greater for the higher frequencies. The larger the current, the greater the percentage rise in ρ for increase in size of wire, until permeability begins to decrease.

Increase in frequency. This causes ρ to increase. The increase is greater for the larger wires.

Increase in current causes increase in ρ . The increase is greater for the larger wires.

It must be pointed out that an iron of low permeability will be chosen in preference to one of high permeability, in order that reactance may be minimized and skin-effect (and therefore resistance) may be kept low. This is simply another way of saying that, other things being equal, the poorer the magnetic qualities of the material, the better electrical conductor it be-

CONDUCTORS

TABLE 3.—CHARACTERISTICS OF COPPER AND IRON WIRE

Hard-drawn copper wire and cable				Galvanized iron wire and cable								
Weight per mile				Size								
Size A. W. G. and circ. mils	Diameter, in.	Ultimate strength in lb.	Resistance per mile, 20°C.	Copper	Iron or steel	Nominal ins. and B. W. G. gauge	Actual inches	Strength in lb.	Resistance per mile, 20°C.	Strength in lb.	Resistance per mile, 20°C.	E. B. B.
300,000 ¹	0.630	15,300	0.182	4,831	4,225	5/8	0.660	14,000	1.17	12,700	0.99	
250,000	0.575	12,900	0.219	4,026	3,430	9/16	0.610	12,000	1.37	10,900	1.17	
0000	0.530	10,800	0.258	3,405	2,690	1/2	0.495	7,900	2.08	7,200	1.78	
0000	0.470	8,600	0.326	2,709	2,190	7/16	0.440	6,400	2.58	5,800	2.21	
0	0.375	5,500	0.518	1,700	1,560	3/8	0.360	4,200	3.93	3,800	3.36	
1	0.330	4,300	0.653	1,347	1,110	5/16	0.327	3,400	4.76	3,100	4.07	
2	0.291	3,400	0.824	1,072	875	9/32	0.285	2,600	6.25	2,400	5.36	
4 ¹	0.261	2,200	1.31	671	660	1/4 ¹	0.249	2,000	8.20	1,800	7.01	
4 ²	0.204	2,000	1.31	678	573	No. 6 ²	0.203	1,900	9.60	1,700	8.21	
5	0.182	1,600	1.65	529	450	No. 7	0.180	1,500	12.21	1,300	10.44	
6	0.162	1,200	2.08	420	378	No. 8	0.165	1,200	14.53	1,100	12.42	

¹ Stranded cable.

² Solid wire, from here on.

TABLE 4—GALVANIZED STEEL CABLE

Size		Ordinary grade		Siemens Martin		High strength		Extra high strength	
Nominal inches and B.W.G.	Actual inches	Strength in lb.	Resistance per mile, 20°C.	Strength in lb.	Resistance per mile, 20°C.	Strength in lb.	Resistance per mile, 20°C.	Strength in lb.	Resistance per mile, 20°C.
5/8 ¹	0 660	14,000	1 31	19,000	1 88	25,000	1 92	42,500	1 96
3/4 ¹	0 610	12,000	1 62	15,500	2 32	21,000	2 37	34,000	2 42
1/2 ¹	0 495	8,500	2 45	11,000	3 51	18,000	3 58	27,000	3 66
7/16 ¹	0 444	6,500	3 05	9,000	4 36	15,000	4 45	22,500	4 54
3/8 ¹	0 360	5,000	4 63	6,800	6 62	11,500	6 76	17,200	6 90
5/16 ¹	0 327	3,800	5 62	4,800	8 03	8,100	8 20	12,100	8 37
3/16 ¹	0 285	3,100	7 34	4,400	10 51	7,300	10 73	10,900	10 95
1/4 ¹	0 249	2,300	9 72	3,000	13 90	5,100	14 2	7,600	14 5
No. 6 ²	0 203	1,800	11 3	2,400	16 3	3,900	16 6	5,800	17 0
No. 7	0 180	1,400	14 6	1,900	20 8	3,100	21 2	4,600	21 6
No. 8	0 165	1,200	17 2	1,600	24 6	2,600	25 1	3,900	25 6

¹ Stranded cable.² Solid wire.

comes. Annealing a wire will increase its permeability. Hence, it should be used unannealed.

Energy loss in the conductor depends upon the I^2R product, where R is the effective resistance at the frequency and load assigned. Eddy currents may be cut down by stranding the conductor, thus lowering the line loss.

Mr. T. A. Worcester gives data¹ and curves for several different instances of the use of iron wire. Both are reproduced here (see Tables 3 and 4, and Figs. 1 to 6) and constitute good, serviceable information.

Usual Sizes and Insulation.—Conductors used in electric lighting vary from No. 12 (or No. 14) A. W. G. up to the largest cables. The insulation used for the wire or cable is determined by the place of installation, voltage of conductor, etc.

There are four standard types of insulation for wires—*weather-proof*, *slow-burning-weatherproof*, *slow-burning* and *rubber*. Cables may be covered by paper, varnished cambric, jute, hemp, asbestos outside of rubber, but should have from one to three braids or an armor for the exterior protection. These types of insulation are approved by the National Board of Fire Underwriters and recommended in the National Electric Code. Through its

¹ *G. E. Rev.*, vol. 19 (1916), p. 488. Similar data are found in *Elec. Wld.*, Oct. 14, 1916, by Oakes & Eckley; with economic statistics in *Elec. Wld.*, vol. 67 (1916), p. 820.

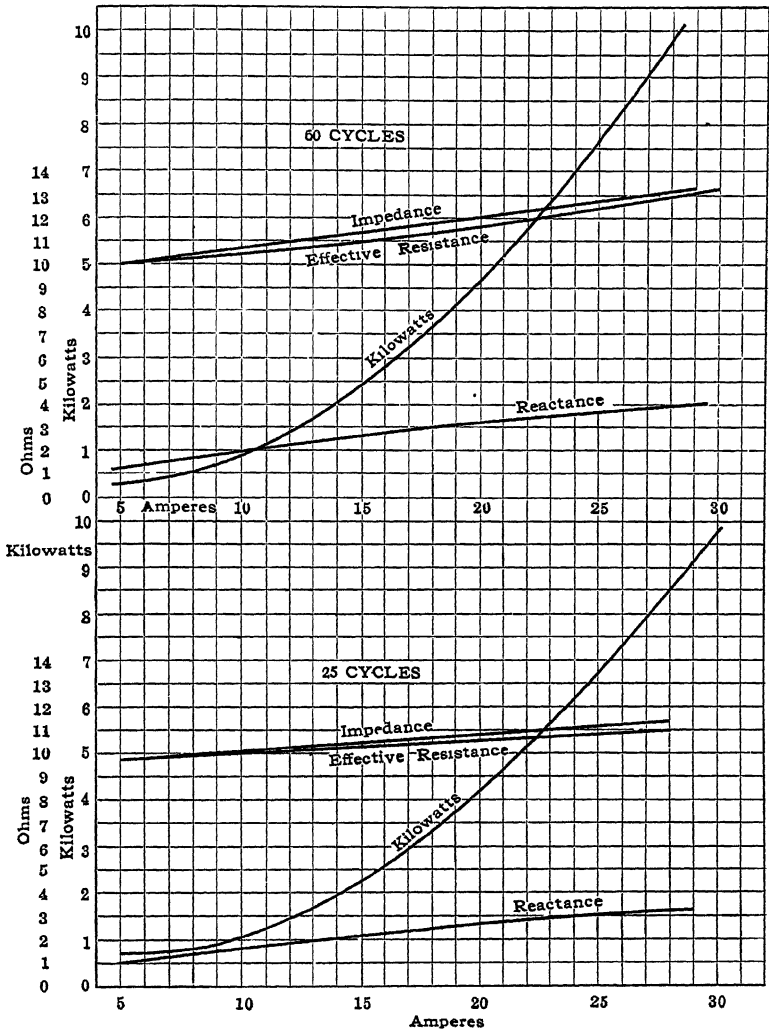

FIG. 1.—Constants for one mile of $\frac{1}{4}$ -inch galvanized stranded steel cable at 25 cycles and 60 cycles per second. Direct-current resistance per mile of cable is 9.72 ohms.

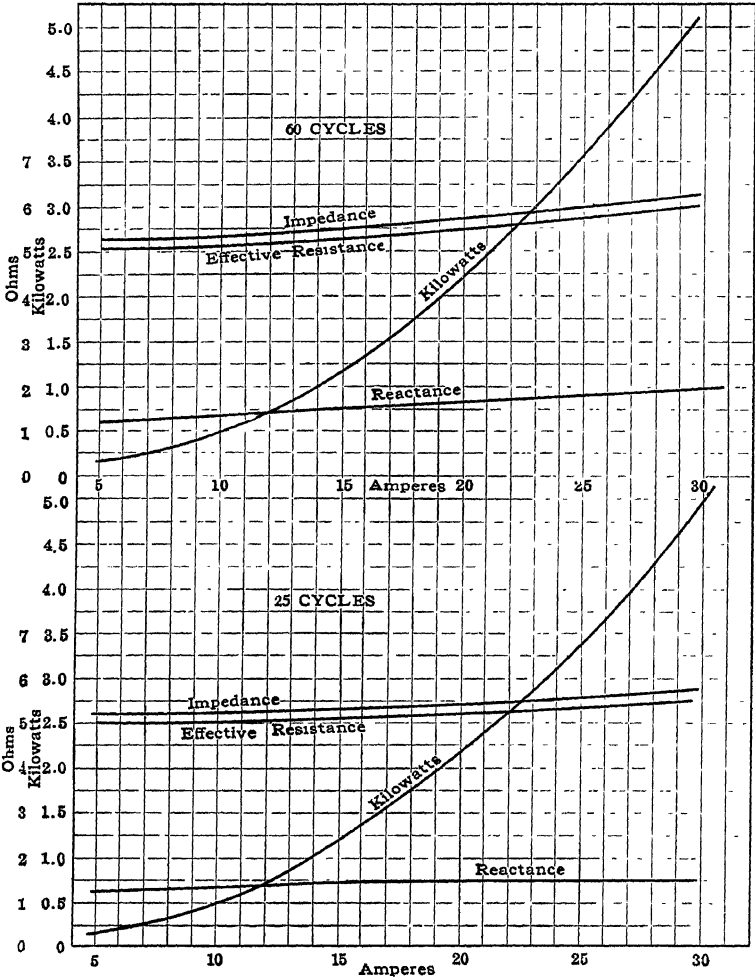

FIG. 2.—Constants for one mile of $\frac{3}{8}$ -inch galvanized stranded steel cable at 25 cycles and 60 cycles per second. Direct-current resistance per mile of cable is 5.03 ohms.

laboratories the association also examines materials, fittings, devices, etc., and publishes lists of those which meet with their approval. In any case it is well to refer to the code and the list

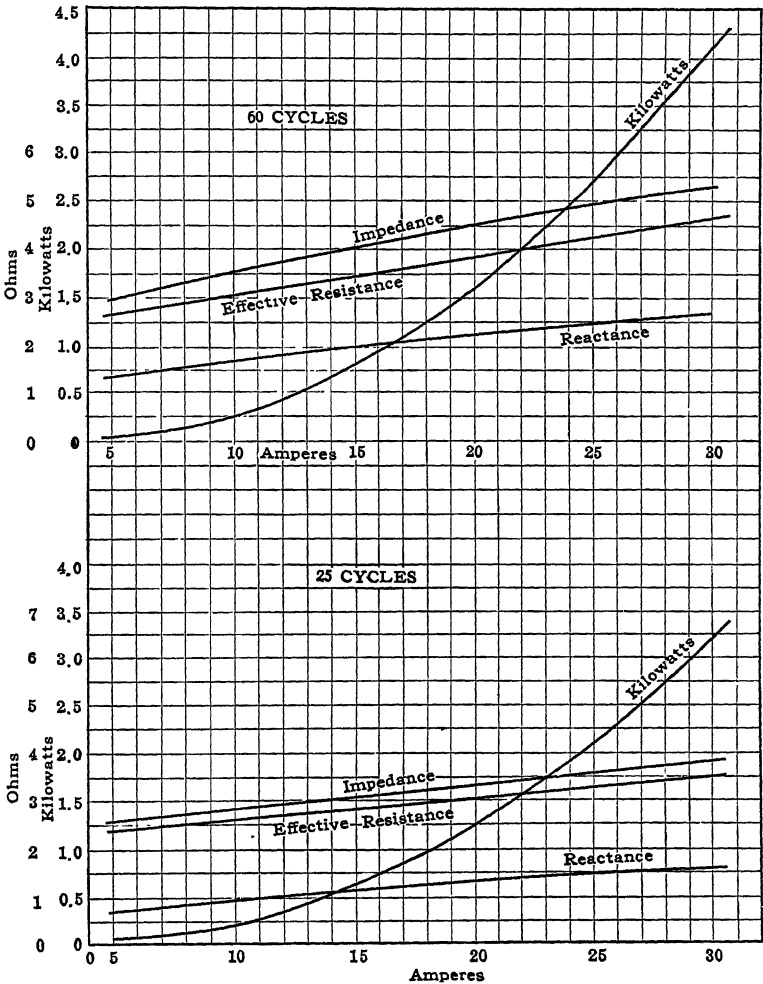

FIG. 3.—Constants for one mile of $\frac{1}{2}$ -inch galvanized stranded steel cable at 25 cycles and 60 cycles per second. Direct-current resistance per mile of cable is 2.42 ohms.

of approved fittings to settle points of usage or standards and materials.

For *outside work* there may be used for low potential systems

the weatherproof covering. For high potentials, only rubber covered conductors are to be used if insulation is used at all. In fact, for transmission lines, it is customary to use bare wire. Wherever there is any likelihood of workmen brushing against a conductor it should be covered by good insulation. Then, the workman must be taught that he should treat the wire as if it

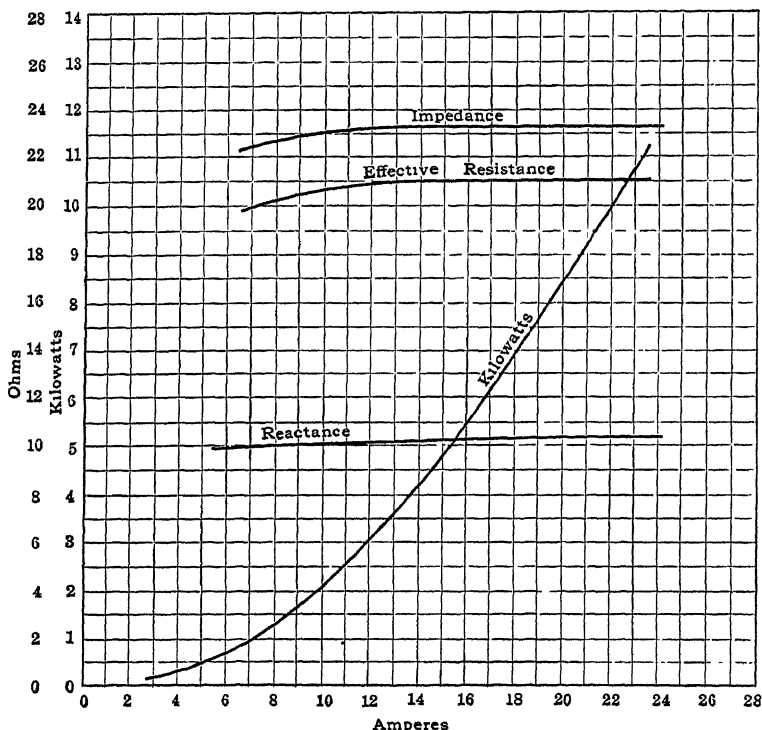

FIG. 4.—Constants for one mile of No. 6 B.W.G. solid BB galvanized iron wire at 60 cycles per second. Direct-current resistance per mile of wire is 10.6 ohms. Tests made on three-phase circuits with wire at vertices of 84-inch equilateral triangle.

were bare. It is never safe to trust one's life to even good insulation especially after it has seen service and yet it is never safe to neglect to provide insulation against contingency. For *inside work*, there is the choice from slow-burning weatherproof, slow-burning, and rubber covered by braid. The slow-burning cover is intended to lessen fire risk. It should never be put under the weatherproof layer. It is not suitable for outside work nor for

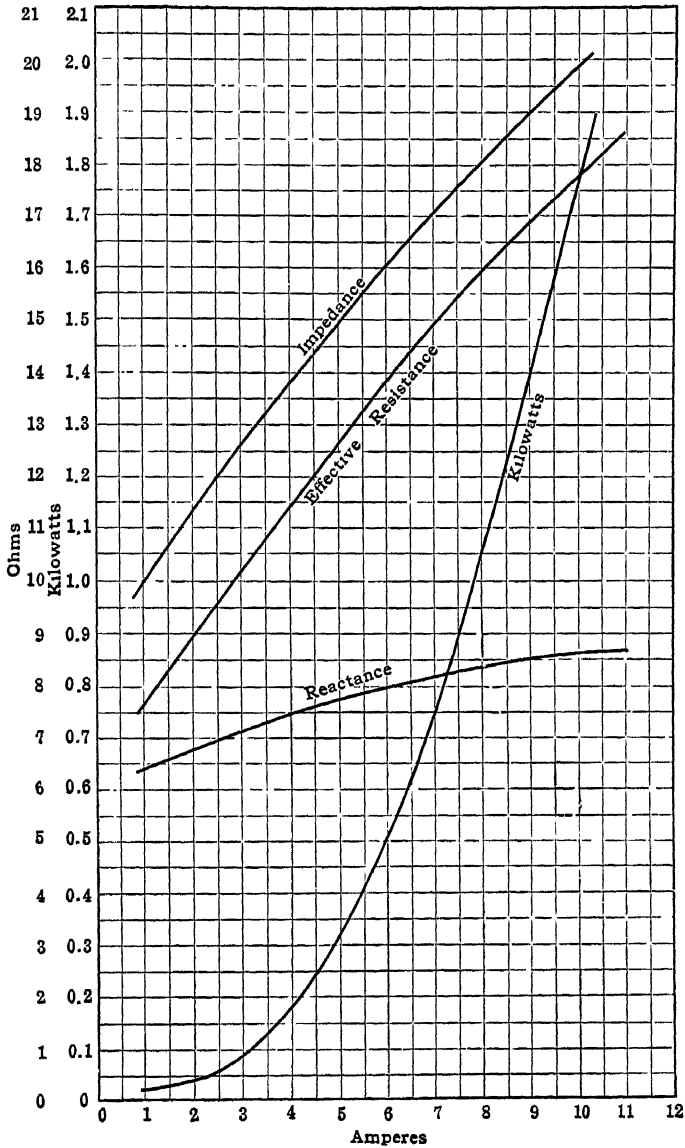

FIG. 5.—Constants for one mile of No. 4 B.W.G. solid EBB galvanized iron wire at 60 cycles per second. Direct-current resistance per mile of wire is 5.97 ohms. Tests made on three-phase circuit with wires in one plane on 42-inch centers.

damp places. In the latter kind of installations weatherproof or rubber is necessary, the latter for protection against water, and either for protection against corrosive vapors.

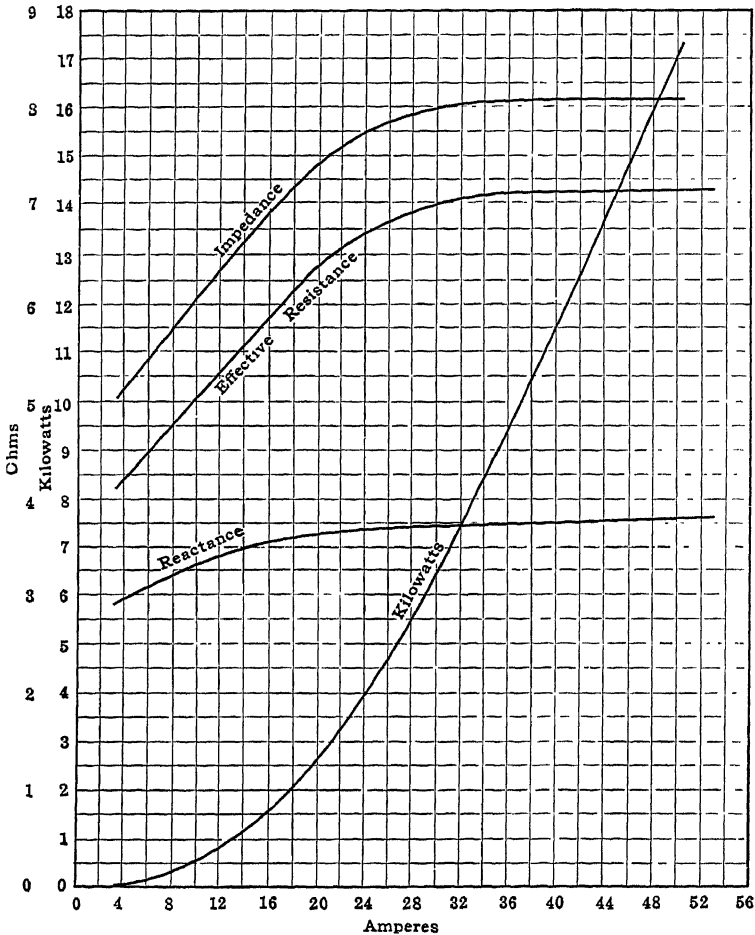

FIG. 6.—Constants for one mile of $\frac{3}{8}$ -inch galvanized stranded EBB iron cable at 60 cycles per second. Direct-current resistance per mile of cable is 3.6 ohms. Tests made on three-phase circuit with wires in one plane on 24-inch centers.

For conductors to be used in *conduits, concealed work or fixtures*, only rubber and braid should be used as there is always some likelihood of injury during installation and subsequent inspection is impossible.

CHAPTER II

WIRING

General Considerations.—In wiring as in other phases of construction, it is always economy to build well. When large plants or systems are being established, there is ordinarily no hesitation in recognizing this. With a reduction in size of the undertaking and a lowering of voltages, there is apt to enter into the problem a greater demand for economy—a proper requirement, but one which may be over-emphasized to the detriment of the operation characteristics or of frugality of maintenance. Specifically, in the case of fire hazard, a National Conference was held in 1897, which initiated a movement to establish certain standards which might be required for normal rating by insurance companies. The conference has been succeeded by the National Fire Protection Association which continues its work in the formulation of recommendations under the titles “National Electric Code” (N. E. C.) and “List of Electric Fittings.” The former gives rules for installations, the latter covers approved fittings, wires, etc., and is revised semi-annually. Contracts frequently contain direct reference to these publications, accepting them as standard guides throughout, or else with certain exceptions specifically noted. To quote some general suggestions from this source:

“In all electric work, conductors, however well insulated, should always be treated as bare, except when in conduit, to the end that under no conditions existing or likely to exist, can a ground or short circuit occur, and so that all leakage from conductor to conductor, or between conductor and ground, may be reduced to a minimum.

“In all wiring, special attention should be paid to the *mechanical execution* of the work. Careful and neat running, connecting, soldering, taping of conductors, and securing and attaching of fittings are specially conducive to security and efficiency, and are strongly advised.

“In *laying out* an installation, except for constant-current systems every reasonable effort should be made to secure distribution centers located in easily accessible places, at which places the cut-outs and switches controlling the several branch circuits can be grouped for convenience and safety of operation. The load should be divided as evenly as possible among the branches and all complicated and unnecessary wiring avoided.

“The use of wire-ways for rendering concealed wiring permanently accessible is most heartily endorsed and recommended, and this method of accessible concealed construction is advised for general use.

“Architects are urged when drawing plans and specifications, to make provision for the channeling and pocketing of buildings for electric light or power wires, and also for telephone, district messenger and other signalling-system wiring.”

Outside Construction.—Outside construction includes pole lines, subterranean conduits, crossings, entrances, etc. Details of the pole line are so varied that it is rather difficult to make a broad statement, sufficient to cover variations and yet of specific value.¹ In general, the N. E. C. requires that conductors exposed to weather shall be carried upon glass or porcelain insulators having petticoats. They must not be carried near to other conductors without special precautions. At crossings, the high potential lines preferably are placed overhead. A grounded guard is sometimes placed to intercept the upper wire should it break. The guard may be replaced by a span so short and so high that a break occurring at one pole gives a loose end too short to reach the lower system. The latter practice is the better, and the grounded guard or cradle is being abandoned.

When passing over flat roofs, wires must clear them by 7 feet. In proximity to roofs, they must be at such heights as to permit fire fighting. When wires are nearer than 25 feet to the cornice of a building they must be elevated above the cornice level by distances up to 9 feet when 2.5 feet away. Pole lines should be laid out to interfere as little as possible with hook-and-ladders, water towers, etc. Moreover, reliability of service is increased by such isolation. It is well even to have the yards of a manufacturing plant served separately with an independent emergency lighting system, sufficient to aid the firmen in dangerous places when the main circuits are cut off either by destruction or for sake of safety. Joints or splices must be made mechanically strong and electrically conducting, after which solder is to be

¹ The best source to consult for details of construction of overhead lines, etc., is the set of reports in the publications of the National Electric Light Association. These reports will be found incorporated in the N. E. L. A. Handbook on Overhead Construction (1914) having been taken in part from the transactions of 1911. Much additional material is found in the handbook, which describes materials, processes of manufacture, equipment, protective apparatus, specifications for supplies and construction, electrical and mechanical calculations, etc.

applied for permanency. The soldered joint must then be taped to correspond in insulation about to that of the conductor itself.

Entrances.—Entrances of the simple sort (Fig. 7) are to be made by establishing a secure outer support, from which the wire drops to a point a little below the opening, loops back and threads its way through the bushing with an upward slant, coming immediately to another support on the interior. The outer loop or depression is called a "drip loop" and keeps water from entering the bushing. The upward slope of the bushing, inwardly, aids in keeping rain out. When conduit is used for this purpose, it should be entered through a downwardly pointing service head. A one-piece bushing or conduit must be used; or if the wall is too thick for one bushing, two bushings may be used provided they are enclosed by a metal tube which extends the full distance through the wall. In case two bushings are used, the hole should be horizontal or nearly so.

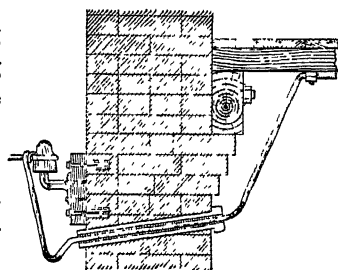

FIG. 7.—A simple, low-voltage entrance.

Transformers.—In all distributing systems using alternating current, it is necessary to install transformers in various places as close to their loads as possible. In order that this may be done economically, simple housings or none must be used. It is not considered good practice to put transformers into the buildings served unless these are stations or substations. This exclusion is effective in keeping all high potential lines outside, minimizing danger on the interior and at the entrance.

Actual installations are made with all grades of protection from the substation to the open, pole mounting. A very common usage is to put small transformers on the poles, having them of water-proof construction. They may be hung upon the wall of the building, singly or in groups provided they are separated therefrom by substantial supports. In this case, it may be advisable to furnish a snow shed roof to keep them from the accumulation of snow and ice that might otherwise drip from overhanging eaves. Again, a vault may be used, directly against the foundation of the building, bringing the high potential lines down the side of the wall. These wires must be well

insulated, well separated electrically, and well protected mechanically. Conduit or boxing is necessary for safety.

Grounding of Neutrals.—The N.E.C. requires the grounding of the neutral on a *three-wire d.-c. system* except when supplied from private plants where the primary potential is not greater than 550 volts. The ground is to be permanently effected at the central station either by utilization of special grounds or not, as may be required, although all underground continuous metallic pipe systems must be included. Ground connection must be repeated at each distributing box of underground systems or every 500 feet on overhead systems. For *alternating currents*, the transformer secondaries must be grounded, except for low-potential private supply, provided the maximum potential between line and ground does not exceed 150 volts. For higher differences of potential, the grounding is not required though it is permitted. When no neutral is available, one side of the secondary circuit may be grounded, locations being about as for direct-current systems. The ground wire at the station must be as large as the neutral and, elsewhere, not smaller than No. 6. It should be kept outside of buildings wherever possible. Insulated wire must be used inside of buildings other than stations, if such ground locations are necessary. The wires should be run as straight as possible directly to the grounding device.

In connecting a ground wire to a piping system, the wire should be sweated into a lug attached to an approved clamp, firmly bolted against the cleaned surface of the pipe. It may be soldered into a brass plug with the plug screwed into the pipe or a pipe fitting. Several connections in multiple should be made for large stations.

Water departments may be assured that no damage will be caused by the practice of using their systems as grounds for lighting systems.

Inside Wiring.—Inside wiring must not utilize smaller size of wire than No. 14, A.W.G. because of the mechanical exigencies of the case. They may be supported by knobs or cleats, tie-wires being permissible for sizes No. 8, or larger. Below this, split supports are to be used except at the ends of runs. At least a $2\frac{1}{2}$ -inch spacing is needed for open work, any wires approaching each other closer than that being covered by some firmly fixed non-conductor, as a porcelain tube, taped into place. Wherever a wire is run through a wall space in such a way that

it is likely to swing into contact with the lath or studding, as may occur in the wiring of old houses, tubes should be fed onto the wire till the full length of the exposed section is covered, from one support to the next one. In the mill type of building, wires run from beam to beam need no intermediate supports. When they are to follow a flat ceiling, however, they must be substantially supported every 24 to 54 inches, depending upon the weight of conductor, the height of support, etc.

On walls (Fig. 8) where the conductors reach the floor or even low levels, they must be protected by conduit or boxing to a height of at least 5 feet above the floor. The separate wires of an alternating-current circuit cannot be put into different metal conduits. The housing must be very rigidly supported and may run clear to the ceiling in case of unusual liability to mechanical injury. Where the wires enter wooden boxings or cabinets, they must pass through bushings. Where plain iron pipe is used for protection, the wires must each be served with a flexible tubing, extending in each direction to the first support outside the pipe. With lined conduit and braid-covered rubber-insulated wire, the extra tubing is not necessary.

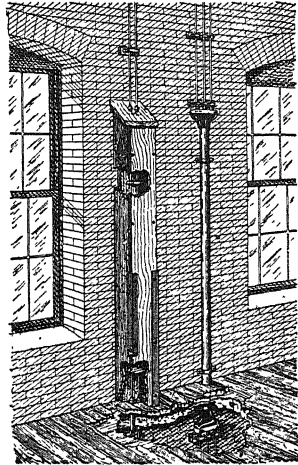

FIG. 8.—Protection for wires on walls.

Inexpensive Installations.—The concealed “knob and tube” work has been used a great deal as it is comparatively cheap and easily installed. There is very just criticism of it as it is found in many places. It is not to be universally condemned, however, but should always receive a very rigid inspection. Open “knob and cleat” work has a very well established place in mills and shops but it has never been accepted for promiscuous installation. In Europe, where they have recognized the value of the numerous, very small consumers, even the homes of the peasants are often wired by open runs in the simplest way possible, consistent with safety. It is only by the use of some such inexpensive system that it will be possible for our central

stations to develop this field of the small consumer. It is startling to realize that in the city of Milan,¹ the average connected load of about 25,000 small customers is 1.83 lamps, giving an average of about 22 watts per customer. With the present practice of wiring, metering, etc., in this country, we are hardly ready to undertake to serve the public so broadly. Yet, as has been pointed out by Mr. S. E. Doane, it would be of undoubted value to the industry to study the possibilities existing in these lines. As a matter of fact, in the early history of electric service, the ordinary residence was looked upon as a doubtful possible customer. But, without it nowadays, the central station would lose a very large percentage of its load and in very many situations, it would shut down.

Accessories to Distribution.—It is not necessary nor desirable to insert in this publication any extended description of apparatus used in accomplishing the details of distribution for electric lighting. In the first place, the devices are ever changing and improving; and in the second place, there are several sources to which one may go to get information upon any and every phase of wiring practice with a completeness not attainable in a general text of this type.² However, in order to point out some of the fundamental and necessary requirements for safety, efficiency and economy, it is sufficient that there should be presented certain illustrations of good practice, with the express understanding that they are typical rather than all-inclusive. It will be convenient to do this in connection with the discussion of a given type of installation with a few variations.

Example, Residence.—As a suitable instance, we may consider the case of a service made to a residence and the wiring of the house. If the *service* is aerial, it will be made by wires (two or three, as the case may be) running from the low-voltage mains to supports upon the pole cross-arms, thence to small glass or porcelain, petticoat insulators near to the entrance. A simple *entrance* may be made to the attic through bushings, the drip-

¹ "The Successful Handling of the Small Consumer in Europe," S. E. DOANE, N.E.L.A., 1914.

² American Electrician's Handbook, CROFT.

Electric Light Wiring, KNOX.

Wiring of Finished Houses, CROFT.

Various trade catalogs.

loop being provided first. It is better practice to run the wires down the wall of the building (properly protected, of course), and enter the basement or cellar, as this will put the meter in a more convenient location for inspection and reading. Directly after the entrance, the wires should again be fastened, after which they may be led through bushings to the fuses, line-switch and meter which must be as close at hand as possible. The fuses and switch are placed in a cabinet. The *cabinet* may be of metal or of wood lined with asbestos or other non-combustible. It must be dust-proof and moisture-resisting. The fuses are of the enclosed type, either plug or cartridge, depending upon voltage and current. The line-switch is to be multi-pole and up to 30 amperes it may be a snap switch. Beyond this, the knife-blade is used.

From the *cabinet*, one or more circuits are run as determined by the "16-lamp load rule" or grouping requirements, balancing, etc. The N.E.C. approves the practice of limiting the load upon one set of fuses to 16 lamps or 660 watts. It is good practice, however, to allot a lesser load to any branch circuit (say, 440 watts), so that a later increase in size of lamps, a fan load, a toaster or a flat-iron, may be allowed. When the residence is of a considerable size, there may be distributing panels provided for each floor. Small houses do not need this. Each circuit, before it leaves the panel is individually fused. Rubber-covered wire need not be used beyond the cabinet, although it should be used up to that point. The proper insulation for house wiring is, of course, "slow-burning," or rubber cover.

When a *new frame building* is being wired, it is satisfactory from the standpoint of both economy and safety to use the knob and tube work. Conduit of any type is much more expensive, though of a higher class. By tearing up floors in places and fishing for conductors in walls, knob and tube wiring may be used with old houses, also. Without thus damaging the house, flexible conduit is required. The solid walls of brick, cement or stone are wired only by solid conduit unless they have been provided with the proper channelling.

From an *inspection of the plan* of the building, locate all lamps, outlets and switches. This should be done very carefully and is preferably predetermined by the architect, in consultation with the owner. It is evident at a glance that there are many features which make or mar a lay-out. Foremost, one must consider

proper illumination, and this phase of the problem will be discussed at length at a later time. Of the *numerous incidentals*, we may mention such as follows: Switches should be placed near the door which is most used in entering a room and in a position so that doors, furniture, etc., will not cover them. Stairways should be supplied with three-way switches with four-way switches at intermediate points if needed. Double switches may be used to allow complete or partial illumination at will. A master switch may be placed at any point to light all lamps at once in case of emergency. Special sockets may be provided for all-night lamps or they may be replaced by "turn-down lamps." In no place like a cellar, bathroom, kitchen, or other place where contact is easily made with well-grounded pipes, should metal fixtures be placed at such a point that they can be touched at the same time as the "ground." Such fixtures should be relocated or they should be grounded or replaced by non-metallic ones. Pilot lamps may be placed near the switches controlling lights in cellars, attics, etc. Floor and baseboard outlets may be desirable for lamps for reading, music, dressing table and for dining table heating devices. In case of electric cooking by a range, separate circuits must be run for it, and it is usual to meter this service independently, because it is generally supplied at a lower rate than is charged for lighting.

Determine the *nature of each unit of load*, as to number of lamps, sizes, etc. Make a tentative location of the distributing board. Group the load into unit circuits requiring about 440 watts each. See if these groups can be fed easily and economically from the distributing center. It may be found that a different grouping and another center would be preferable. By the aid of a table showing the current-carrying capacity of wires, the circuits may now be determined. It is never permissible to use wires smaller than No. 14, for interiors.

"Risers," or the vertical leads up through walls, may be supported on knobs. Where conduit is used, conductors up to No. 0 in size must be supported every 100 feet. In this connection, it will be considered that a turn of 90 degrees in direction is a support. Without turns, it is necessary to insert a junction box and fasten the conductors therein, by bending them through an angle of not less than 90 degrees and displacing them from the vertical line by a distance not less than twice the diameter of the conductor. These bends are made by passing from knob to

knob, the wire being further secured by ties if it is thought best.

To aid in drawing a wire into a conduit or up an opening in a wall, use is made of a "*fishing*" wire or chain. It is lowered or pushed through the duct and the conductor is attached to the end of it. A good steel, well-tempered, is required for this service. The wire is of rectangular cross-section. Conductors pulled through by fishing must be very well-secured to the fishing wire, as some of the pulls are difficult. The attachment joint is taped in order to make it less liable to catch at bends. When the pull is extra difficult, it is well to pull through a steel wire by means of the fishing wire, attaching the heavy steel wire, in turn, to the conductor.

Wall switches are reached by having the wire pass through the openings in an outlet box. This is a small metal box of sufficient size to house the switch and its porcelain parts. Numerous small holes cut through the sides of the box are closed by metal discs soldered into place. These discs can be removed by a slight blow, leaving an opening for the wire at any desired position upon the box. The boxes must be well supported, preferably by means of a board running from studding to studding. Snap switches are permissible, though sub-bases are desirable for them. Flush switches, covered by a neat wall plate are especially good.

The *service opening* for a light requires a substantial construction which will permit the support of the lighting fixture. This is best accomplished by the use of a board between the floor joists. The fixture must be firmly attached thereto, while the entering wires must be supported upon knobs at the entrance point. Except where conduit is used, wires at all outlets are to be protected by flexible tubing extending from the last porcelain support to at least one inch beyond the outlet. When the service is for a combination of gas and electricity, the flexible tubing must extend at least to the ends of the gas caps, and any box or plate used must make good, secure, electrical connection with the gas pipes. The fixtures need rubber-covered wire, at least as large as No. 18.

When the system used is a grounded system, it is desirable to have the *live wire proceed through the switch* to the lamp or other service point. In a three-wire system, this would always bring one or the other of the outside wires to the switch, the

grounded neutral running to the lamp. Then, when the switch is open the lamp is at ground potential or "dead."

It is not permissible to *branch off* from a circuit, "tree" fashion, without the installation of a junction box. To avoid extra boxes, it is usual to run the wires to any outlet and loop them back when necessary to reach other outlets upon the same circuit. This is spoken of as a looped system, and it has the advantage of being clear of all soldered joints in concealed places, where they cannot be inspected.

Larger Buildings.—The foregoing discussion of many of the details of house-wiring, incomplete, and brief as it is, will serve to give a fair idea of the most important requirements for such cases, and to lay a foundation for the consideration of more elaborate systems required by larger buildings such as apartment houses, offices, shops, factories and stores. None of these will be discussed at this time, the differences being principally those of detail and equipment, rather than of principle. The higher voltages used for series lighting give rise to a few more stringent rules. Conduit work also has certain well defined privileges and limitations. With increase in the amount of power to be distributed, more elaborate provision must be made for wire-ways, distributing panels, etc.

The wiring plan of a large office building is a very extensive and complicated affair. There must be among the general diagrams, drawings showing the risers; the feeder system to different floors, for regular lights, hall lights, watchman's lights; the location of distributing boards. Each floor must be shown, giving the main architectural features, and showing thereon all conduits from the riser to the panel and to the outlet. Some of these conduits will serve the rooms below the given floor, while some of them will supply floor and base-board outlets. If embedded in concrete floors, the conduits will be located high or low in the floors so as to reach the outlets most conveniently or to avoid the beams, either rising to a floor box or descending to a ceiling outlet.

The actual path of the *conduit in the floor* may be the most direct route from the riser or panel box to the outlet. The practice of running it in lines parallel to the walls has some advantages, although it is more expensive and makes pulling-in harder. Pull-in boxes are also shown, being installed at points that will aid most in handling the wires. Whichever course is

pursued in laying the conduit, it is customary to group the runs leading in the same direction, laying numerous lines close together as far as they can conveniently go.

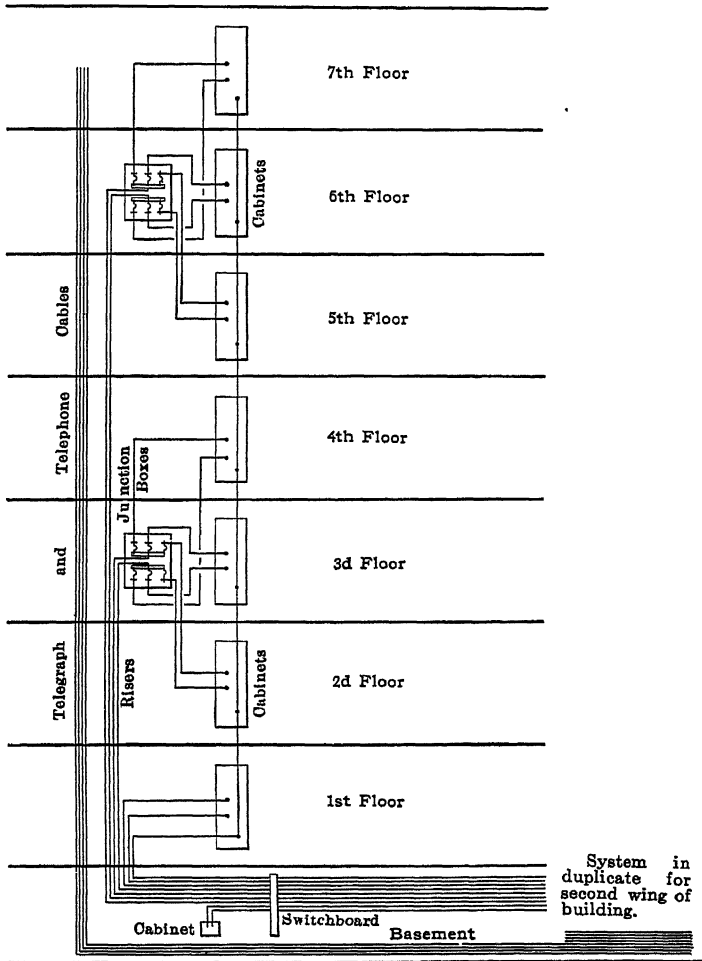

FIG. 9.—Systems of feeders and risers for an office building.

Wiring channels may be provided in the floor as well as in the walls and this practice has the pronounced advantage that trouble, renewal, additions or enlargement may be handled with minimum labor and cost. These channels may be in the

concrete itself, or they may be placed in the wooden sub-floor, when it is present.

It is necessary then, that all details of construction shall be worked out and specification drawings made corresponding thereto.

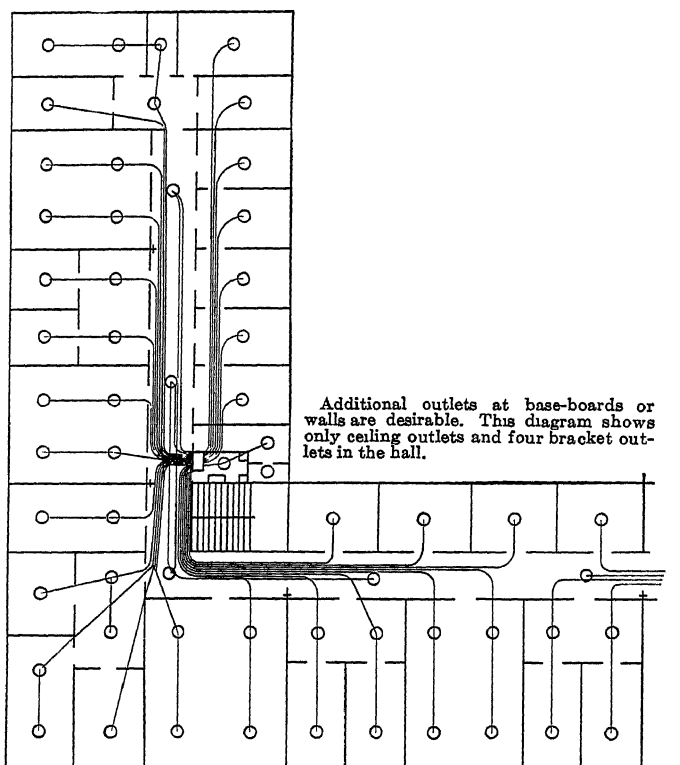

FIG. 10.—Conduit system for electric wiring for one floor of an office building.

Typical drawings are shown. Fig. 9 gives a good idea of the feeder system found necessary in one large building and the location of panels. Fig. 10 shows the method of distributing from a given center upon any one of the several floors of the building.

CHAPTER III

CIRCUITS

Series vs. Parallel Distribution.—When a lighting system is fed at constant potential, the connections to the lighting units are made in parallel. Fed at constant current, the units are connected in series. These constitute the “*parallel*” and “*series*” systems of distribution.

Some outside and all interior lighting is done by using the parallel system. Prime among its advantages is the fact that it gives convenient independent control of each unit without affecting the operating or efficiency of the system. It is applicable to arcs as well as to incandescents. There are no high and dangerous voltages upon the lamp circuits. Local troubles can be easily cut out of circuit, leaving other service uninterrupted. Various sizes and types of units may be connected to the same circuit for simultaneous operation. The supply circuit is available for other classes of service, such as motors, fans, elevators and heating devices. Generators for this system are easily designed and constructed in any reasonable size, while voltages may exceed, for distribution purposes, the voltage rating of the load unit, transformers being interposed in the case of an alternating-current circuit and a multi-wire distribution being used with direct current.

Upon the other hand, the series circuit has some very distinct advantages for street lighting. One of these is the fact that the constant-current system permits easy and prompt control of the lighting circuit from a central location. This combines switching economy and timely service. Again, there is economy of copper, for all such systems are designed for low current values, and the return conductor, following another street, will serve as many lights as the out-going lead. This system is also capable of carrying either arcs or incandescents. Inasmuch as the arc is inherently unstable, the installation of stability devices is required and these must be applied to the individual lamps upon the parallel system, while a series system may operate from a source which gives automatic regulation of current value by

means of its own mechanism. Series incandescent lamps present the feature of large filaments with added strength.

Potential Gradient, Series Circuit.—A study of the potential gradient of the series circuit shows (Fig. 11) that there are well defined points where the drop in voltage is marked, and that the voltage variations over the system are large. The condition assumed is that of a generator armature supplying a circuit of arc lamps connected in series along a loop circuit. If no point of the circuit is grounded, the system as a whole will assume, due to capacity, a potential relation to earth such that the mid-point of the circuit is at ground potential. This places the point *P* at ground potential, as is also the mid-point of the armature.

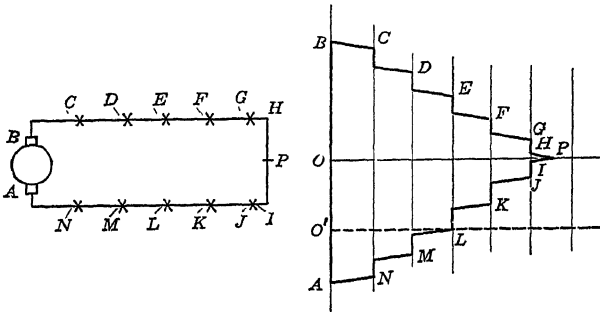

FIG. 11.—Series circuit and its potential gradient.

In this case, the gradient is shown by the curve given, supposing the zero point to be at *O*, of the scale, and *B* is as much above the ground potential as *A* is below it. The figure as drawn shows potential to ground, plotted against distance to generator. On this account, the curve returns toward zero value of distance after reaching *P*. The ordinate *AB* is the value of the voltage of the generator. This gradient curve may be termed a "floating curve" because its location upon the potential axis is easily disturbed by any slight change from the assumed condition of balance or symmetry to ground. For example, suppose a ground connection to be made to the circuit at any point, as *L*, and that point becomes of ground potential. The gradient curve will retain its original shape, but rise bodily until the point *L* upon it lies upon the zero line to be lowered to the position *O'*. Maximum difference of potential between system and ground will exist if one of the brushes of the generator is grounded. This

latter situation corresponds to the most dangerous condition for workmen because it places the line insulation under higher strain.

The steep elements of the gradient correspond to the load units of the circuit. The more nearly horizontal portions indicate the drop in the conductor between the lamps. It follows that the flatter the line portion of the curve is, the less line drop there is and the more efficient will be the transmission. In general, these parts of the curve are parallel, because current is constant throughout the circuit and the conductor is kept of uniform size and resistance. Similarly, the load units are always alike and the potential drops across them are uniform. The calculation or design of a series circuit therefore begins in determining the allowable drop along the line between load units. Having fixed this permissible loss and knowing the current to be used, the resistance and the size of the conductor follow directly. A loss of about 10 per cent. may be allowed.

Potential Gradient, Parallel Circuit.—A marked difference is noted between the foregoing curve and the potential gradient of the parallel distributing system. In the first place, the curve discussed is a one-loop curve, the conductor potential varying widely and more or less uniformly. By reference to Fig. 12, the contrast is shown. The gradient of the parallel system is a branching curve having a separate portion for each branch of the load. Assuming a three-wire system, grounding the neutral will put O at zero potential. Points upon the curve are lettered the same as the corresponding parts of the circuit. On the main $BCDEF$ the voltage falls off as shown. At each junction there is a load taken off and the short curves, CN , JP , FW , IX , MY , etc. indicate the potential relation of each respective section to other sections. Inasmuch as there is an unbalanced load, there is return current in the neutral wire and its potential does not stand at zero throughout its entire length. Where the load is balanced, drops on positive and negative mains will be symmetrical. This does not necessitate that the potentials across the two sets of lamps of the balanced group shall be equal to each other, for the unbalancing of other loads of the system is quite capable of throwing off from symmetry the supply voltage to this point of the circuit, and equal drops in the group perpetuate the dissymmetry. The lines GR , HU , and IX , show the characteristic effects of three different conditions of load balance. The first group of lamps is unbalanced in such a direction that

the drop in its neutral is *negative*. The drop in *HU* is zero, while that in *IX* is positive. It is possible that the elements of the load may be arranged in such a way that positive, zero or negative drops occur in different sections of the neutral main.

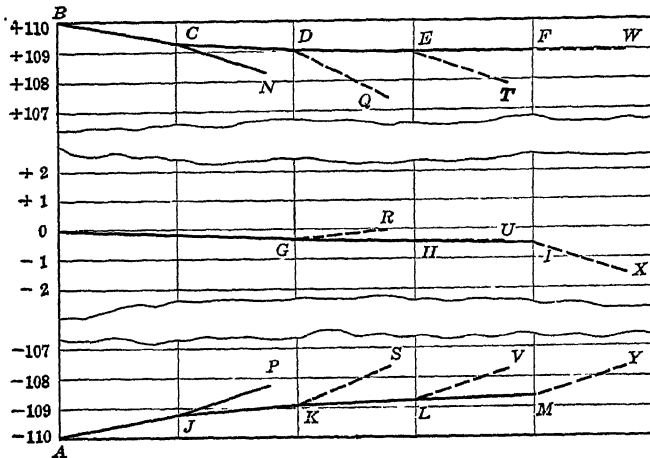
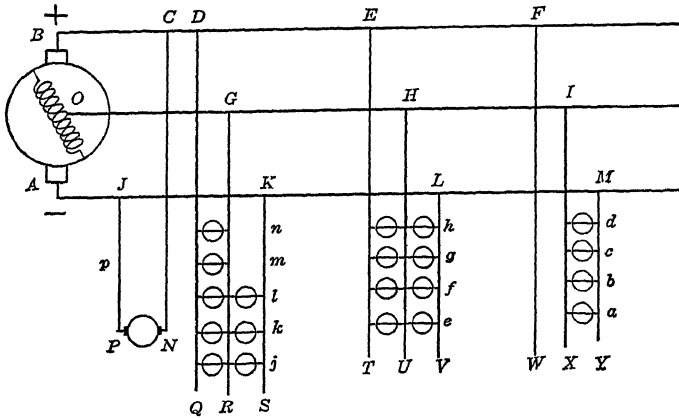

FIG. 12.—Parallel circuit and its potential gradient.

This, of course, depends wholly upon the direction in which the current is flowing in that conductor.

When the distributing system becomes large, it is usual to interconnect it by lines which serve to assist in maintaining different parts of the system at the same potential. The gradient curve then becomes an assemblage of loops, where the former

depressions due to a local heavy load are partially eliminated by the sustaining influence of other points of higher potential. This is another way of saying that the new connections give a net-work of parallel paths which present a lesser resistance between the generator and the local load being considered.

Solution of Parallel Circuits.—In the calculation of circuits, complex problems are impregnable unless some methodical process is used whereby the separate steps suggest themselves in their proper sequence and the results are tabulated for use in later steps. The series circuit presents no such difficulties as does the parallel circuit and will not be illustrated now. Referring again to Fig. 12, the process best adapted to the solution of this case, is to take each group separately, as the *WXY* load, the *TUV* load, etc. Then later deal with the mains by affixing these loads to them at the points *FIM*, *EHL*, respectively. A tabular form may be used to advantage for any calculation in which the load cannot be considered as concentrated, the space between the different load units supplying headings for the columns of the sheet. The complete solution is presented in Table 5. Main headings like *WXY*, *DGK*, etc., refer to that part of the load similarly lettered or to that portion of the line immediately adjacent to that load, upon the generator side. The minor headings, *a*, *b*, *c*, . . . *m*, *n*, *p*, refer to the section of the line so labeled. The headings for rows use *i* for the current taken by the one adjacent element of load. *I* indicates the summation of currents from the outer end of the line to the point being considered. The quantity *e* is the voltage drop in the one section of the line. *E* is the summation of voltage drops from the end of the line to the point being considered. The first half of the table gives the data for the elementary parts of the load, of which it is assumed that each lamp shown is a 5-ampere group, while the motor takes 100 amperes. These calculations are made, first for the negative service wire, then for the neutral, and then for the positive service wire. Each section of these lighting service wires has a resistance $r_f = 0.02$ ohm. Each service wire running to the motor has a resistance of $r_p = 0.01$ ohm. Each main has a resistance per section of $r_m = 0.005$ ohm. The voltage is 220.

The second half of the table brings the calculation down to the mains, themselves, the first part being for the negative main, the second part for the neutral, and the third part for the positive

TABLE 5.—CALCULATION OF POTENTIAL GRADIENT. PARALLEL SYSTEM

Sections.....	WXYZ				TUV				QRS				NP	
	a	b	c	d	e	f	g	h	j	k	l	m		n
Service wires														
Negative service wire.....	i	5.0	5.0	5.0	5.0	5.0	5.0	5.0	5.0	5.0	5.0	0.0	0.0	100.0
	I	5.0	10.0	15.0	20.0	5.0	10.0	15.0	20.0	5.0	10.0	15.0	15.0	100.0
	e	0.1	0.2	0.3	0.4	0.1	0.2	0.3	0.4	0.1	0.2	0.3	0.3	1.0
	E	0.1	0.3	0.6	1.0*	0.1	0.3	0.6	1.0*	0.1	0.3	0.6	0.9	1.2*
Neutral service wire.....	† I	As for negative				Zero currents				0.0	0.0	0.0	-5.0	None
	e	As for negative				Zero currents				0.0	0.0	0.0	-5.0	-10.0
	E	0.1	0.3	0.6	1.0*	0.0	0.0	0.0	0.0	0.0	0.0	-0.1	-0.2	-0.3*
Positive service wire.....	† I	Zero currents				As for negative				5.0	5.0	5.0	5.0	As for negative
	I	Zero currents				As for negative				5.0	10.0	15.0	20.0	25.0
	e	0.0	0.0	0.0	0.0*	0.1	0.3	0.6	1.0*	0.1	0.2	0.3	0.4	0.5
	E	0.0	0.0	0.0	0.0*	0.1	0.3	0.6	1.0*	0.1	0.3	0.6	1.0	1.5*
Mains														
Sections.....	FIM				EHL				DGK				CJ	
Negative main.....	i	20.0	20.0	20.0	20.0	20.0	40.0	0.2*	0.3	15.0	55.0	0.275*	0.575	100.0
	I	20.0	0.1*	0.1	0.1	40.0	0.2*	0.3	0.3	55.0	0.275*	0.575	0.755*	1.35
	e	0.1	0.1	0.1	0.1	0.1	0.2	0.3	0.3	0.15*	0.35	0.15*	0.15*	0.5
	E	0.1	0.1	0.1	0.1	0.1	0.2	0.3	0.3	0.15*	0.35	0.15*	0.15*	0.5
Neutral main.....	† I	Zero currents				Zero currents				0.0	0.0	0.0	0.0	0.0
	I	Zero currents				Zero currents				0.0	0.0	0.0	0.0	0.0
	e	0.0	0.0	0.0	0.0	0.0	0.1*	0.1	0.2	0.15*	0.35	0.15*	0.15*	0.5
	E	0.0	0.0	0.0	0.0	0.0	0.1*	0.1	0.2	0.15*	0.35	0.15*	0.15*	0.5
Positive main.....	† I	Zero currents				Zero currents				35.0	45.0	35.0	45.0	100.0
	I	Zero currents				Zero currents				35.0	45.0	35.0	45.0	145.0
	e	0.0	0.0	0.0	0.0	0.0	0.1*	0.1	0.1	0.225*	0.325	0.225*	0.325	0.725*
	E	0.0	0.0	0.0	0.0	0.0	0.1	0.1	0.1	0.225*	0.325	0.225*	0.325	1.05

* Used in the calculation of the subsequent table of potentials.

main. From the data given, the potential of every point upon the line in reference to ground can be tabulated, and this is done for the principal points as in Table 6.

TABLE 6.—POTENTIALS OF VARIOUS POINTS ON PARALLEL SYSTEM

<i>A</i>	-110.0	<i>J</i>	-109.225	<i>S.</i>	-107.75
<i>B</i>	+110.0	<i>K.</i>	-108.95	<i>T.</i>	+107.95
<i>C</i>	+109.275	<i>L.</i>	-108.75	<i>U</i>	- 0.40
<i>D</i>	+109.05	<i>M</i>	-108.65	<i>V</i>	-107.75
<i>E.</i>	+108.95	<i>N.</i>	+108.275	<i>W</i>	+108.95
<i>F.</i>	+108.95	<i>O.</i>	0 0	<i>X..</i>	- 1.50
<i>G</i>	- 0.30	<i>P.</i>	-108.225	<i>Y.....</i>	-107.65
<i>H</i>	- 0.40	<i>Q.</i>	+107.55		
<i>I.....</i>	- 0.50	<i>R .. .</i>	0.0		

With these figures, it is easy to state the difference in potential between any two points given. This list does not include the potentials of all lamp terminals, but the original calculation table does contain all the material necessary for establishing such figures. The data actually used are marked in Table 5 by the asterisk. In calculating the potentials of the individual lamps, the rows of figures headed *e* in the feeder table would be used. The gradients *DQ*, *ET*, etc., in Fig. 12 are not straight lines, because the load is distributed. In contrast to this, *CN* and *JP* are straight.

Networks.—In general, networks become too complicated to admit of solution. The final design of such systems must be based upon many things which probably did not enter into the problem initially. In other words, systems grow from the comparatively simple state, the intermediate steps being results of rather plainly evidenced demands made upon the service. It is evident, therefore, that one of the prime factors in the first plan, as, in fact, in every later addition thereto, is the outlook or prospect for growth and the taking on of new loads in certain localities, as well as extensions. Where the running of new feeders implies laying them in underground conduits, forethought and initial investment very frequently return heavy dividends. In numerous instances, companies establish a minimum size of feeder or of main below which they will not go in putting in new lines, even if the immediate load is much below the capacity of this cable.

Constant Potential Systems.—Constant potential circuits may be either d.-c. or a.-c. In either case, the large systems utilize alternating currents for the first general distribution, in order to have high enough voltages for economy. These circuits, running out at from 2300 volts to 30,000 volts are regenerated or transformed to 220-volt, three-wire systems, for the actual lighting circuit. Single or double reorganization may be required. The initial circuit may have been single-phase, or three-phase. It is customary to run the a.-c. secondaries as single-phase unless some three-phase power is to be taken from them. For lighting only, some companies do not carry the full 220 volts into each house unless the connected load amounts to as much as thirty or forty lamps. This is an unusually large minimum, however, and it is found preferable by most companies to use a much smaller figure. Where motor load is to be served, it is desirable to put it upon the 220-volt lines in order to lessen as much as possible the unbalancing of the system and to keep currents as low as can be, especially when starting the machine. Direct current is especially desirable in dense load districts because of the flexibility of its service for elevators, etc. The New York Edison Co. maintains both the d.-c. and the a.-c. systems, the former having been established at an early date, the latter having come in with the demand of service over a much greater territory. The early d.-c. service has perpetuated itself because of certain advantages and the expense which would attend the change of a very large amount of motor equipment.

Power Loads.—The harmful effects which power loads have upon lighting, by reason of their constantly and widely varying demands, are much more serious upon small systems than upon large ones. The reason for this is at least three-fold. Upon any large system, the variations introduced by any one load unit are small compared to the total supply. With increase in the number of units, the peaks of some load curves fall in the valleys of others. Pressure regulating devices are always included in large systems, generally installed in medium sized stations and sometimes in small ones. As an extreme instance of the abolition of such troubles, we may cite the conditions in Chicago, where the Commonwealth Edison Co. has combined lighting and power loads even to the extent of contracting for the

street railway supply. They are even prepared to furnish at any time electrical energy to electrify any or all railway terminals in the city.

Service Wires, Feeders.—In the distribution of electrical power, it is convenient to make certain distinctions between conductors, depending upon the part they take in the network. Roughly speaking, a conductor which supplies energy directly to the load is a *service wire*. Service wires are lead off from the mains at any desirable points along the route. The mains are supplied through *feeders* which run from the station or substation and connect to the main at one or more points, depending upon the nature of the circuit. In lighting, the feeder generally leads to but one point of the main, while in railways, due to the fact that the load shifts its location, the feeder is connected to the trolley wire (the main, in this case) in numerous places. The calculation of feeders, therefore, becomes a process of computing the parts of a divided circuit, where conditions are analogous to the parallel circuit. Very frequently the feeders for distant points originate at buses which are at a higher potential than the

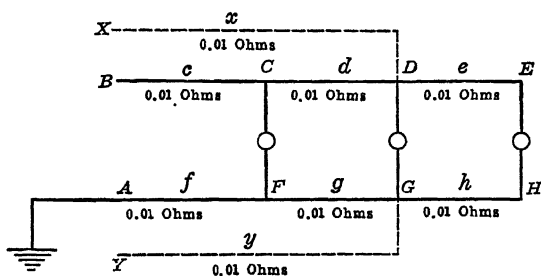

FIG. 13.—Simple parallel circuit without and with feeders.

feeding points near to the power station. This condition is especially useful in lighting systems, and we shall see by a few computations how satisfactory the device is in effecting copper economy.

Calculation of Parallel System Without Feeders.—Let us first calculate the conditions existing in the case of the load shown in Fig. 13, *with no feeders* at X and Y. In the symbolism of the former problems we have the data of Table 7.

TABLE 7.—CALCULATION OF POTENTIALS. PARALLEL SYSTEM WITHOUT FEEDERS

Section	<i>C</i> (or <i>F</i>)	<i>D</i> (or <i>G</i>)	<i>E</i> (or <i>H</i>)
<i>i</i>	10 0	20.0	20 0
<i>I</i>	50.0	40 0	20 0
<i>e</i>	0 5	0.4	0 2
<i>E</i>	0 5	0.9	1.1
Potential at	<i>A</i> = 0 0		<i>B</i> = 110.0
<i>C</i> = 109 5		<i>D</i> = 109 1	<i>E</i> = 108.0
<i>F</i> = 0 5		<i>G</i> = 0 9	<i>H</i> = 1.1
Lamp Voltage, <i>CF</i> = 109 0, <i>DG</i> = 108 2, <i>EH</i> = 107.8.			

Calculation of Parallel System with Feeders.—Next, as a second case, allow feeders to be connected in as shown in the figure by the dotted lines, letting the resistance of each feeder equal that of any section of the main, namely, 0.01 ohm. It is necessary now to estimate by steps the value of the current in any individual circuit. For example, the current in the section *c* is the sum of two-thirds of the current of *CF*, one-third of that in *DG* and one-third of that in *EH*, that is, $20/3 + 20/3 + 20/3 = 20$ amperes. This is indicated in the following table.

TABLE 8.—POTENTIALS IN A PARALLEL SYSTEM WITH FEEDERS TAKEN FROM MAIN BUSES

Section	<i>C</i> (or <i>F</i>)	<i>D</i> (or <i>G</i>)	<i>E</i> (or <i>H</i>)	<i>X</i> (or <i>Y</i>)
<i>i</i>	10.0	20.0	20.0	
<i>I</i>	$\frac{20}{3} + \frac{20}{3} + \frac{20}{3}$ = 20 0	$-\frac{10}{3} + \frac{20}{3} + \frac{20}{3}$ = 10.0	20.0	$\frac{10}{3} + \frac{40}{3} + \frac{40}{3}$ = 30.0
<i>e</i>	0.2	0.1	0.2	0.3
<i>E</i>	0.2	0.3	0.5	0.3
Potential at <i>A</i> (or <i>Y</i>) = 0		<i>B</i> (or <i>X</i>) = 110 0	<i>C</i> = 109.8	
	<i>D</i> = 109.7	<i>E</i> = 109.5	<i>F</i> = 0.2	
	<i>G</i> = 0 3	<i>H</i> = 0.5		
Lamp voltages, <i>CF</i> = 109.6		<i>DG</i> = 109.4	<i>EH</i> = 109.0	

The influence of the feeder is at once seen by a comparison of the lamp voltages of the two tables. These calculations have assumed that the proper feeding point is at *D* and *G*. Ordinarily, this should not be taken for granted, but similar calculations

should be made for other points of connection, as at *E* and *H* say, with the same amount of copper. It must not be forgotten however, that the cost of copper alone does not settle the question, for the copper must be put into place and the longer the line, the more expensive this is.

Calculation of Parallel System with Excess-voltage Feeders.— Going now to the third case, where the feeders are present but originate at buses at a different potential from the main buses, we will assume that the results to be obtained are the same as those of the second case, while the feeder voltages differ from their respective bus-bars by two volts each. *X* is fed at 112 volts and *Y* is fed at -2 volts. The problem now is to determine what amount of copper in the feeders will be required to give the same potential drops as the former case. The drop in the feeder is now to be two volts more than it was before, that is, $2 + 0.3$ volts. But the current will remain 30 amperes. Hence the resistance will be $2.3/30 = 0.07\frac{2}{3}$ ohm. The weights of the feeders in the two cases will be to each other inversely as the resistances, or as 1 : 0.13. A saving of about 87 per cent. of the feeder copper will be effected by the increase in feed voltage.

Or, suppose that the feeder resistance is known and we wish to calculate the current distribution and the consequent voltage relations. By the use of Kirchhoff's laws, we may formulate enough equations to determine the unknowns and find the current in each branch. The calculation of the voltages then becomes simple. For example, suppose that in the foregoing circuit we should use a feeder having a resistance of 0.1 ohm. Let the currents in the respective sections of the circuit be represented by the small letters, *c*, *d*, *e* and *x*. We find that:

$$(1) \quad 0.01c + 0.01d = 0.1x - 2$$

$$(2) \quad c + x = 50$$

$$(3) \quad d + x = 40$$

$$\begin{aligned} \text{Whence,} \quad x &= 24\frac{1}{8} \text{ amperes,} \\ c &= 25\frac{5}{8} \text{ amperes,} \\ d &= 15\frac{5}{8} \text{ amperes,} \end{aligned}$$

$$\text{Moreover} \quad e = 20 \text{ amperes,}$$

and this gives a complete statement of current conditions in the circuit, because of the symmetry of the supply, feeders, etc. With unsymmetrical circuits the problem is attacked by the

same method and differs from the above solution only in the fact that there are more unknowns and therefore more equations to the group.

It is to be remembered in connection with all increased-voltage feeder switching, that if the load goes off, the feeder must be disconnected or there will be a current flowing from the feeder to the main. In the last instance it would have a value of $2 \div 0.12 = 16\frac{2}{3}$ amperes. Or as load decreases from normal values, there will come a time when the feeder will be supplying all of the current. Again, the same undesirable result will occur if the load remains the same, but the resistance of the feeder is decreased. This system is, therefore, one in which the load distribution or variations must be known or indicated, in order that the feeders may be cut in or cut out as the needs demand.

Multi-wire Systems.—Mention has already been made of the *multi-wire* systems of parallel distribution. While the possibilities go beyond the use of three wires, common practice is limited to that maximum, because of the great difficulty of balancing loads. This arrangement is known as the *Edison three-wire system*. For lighting, it is usually restricted (in America) to a 220-volt pressure between outside mains. A third wire, the neutral, is then run to be maintained at a potential nearly midway between that of the two outer mains. The standard practice is to ground the neutral wire, leaving one main at a positive 110 volts and the other at a negative 110 volts from ground potential. If the load is exactly balanced by having units upon one side placed symmetrically with similar units upon the other side, there will be no current flowing in the neutral and the system is, to all intents, a 220-volt system, rather than a 110-volt system. Doubling the voltage and reducing the neutral to zero would save half of the copper. Depending upon the size of neutral wire used, therefore, there will be possible a very considerable saving in copper. Practice as regards the size of the neutral wire varies. The N.E.C. requires that the center wire in interior wiring shall be of equal cross-section with the other mains. In outside work, its size is to be determined by the amount of unbalance to be expected. At least locally, this unbalance will be more in the mains than it will in the feeders. In the latter, it may be necessary to take care of as much as 20 to 30 per cent. of unbalance, although it is usually possible to limit it to 10 per cent. or less.

The practice of the New York Edison Co. as outlined in a paper by Mr. Torchio,¹ is to lay neutral mains of the same size as the outer mains but to use feeders averaging only about 16.3 per cent. of the size of one of the outer feeders. This liberality in the use of copper in the mains is explained upon the grounds of benefiting the regulation when the load is unbalanced. The mains are interconnected at each street intersection, giving a complete network. The neutral main is grounded at frequent intervals, besides which, neutral feeders are run from substations to the mains at various points, being themselves grounded repeatedly.

¹ *Trans. A.I.E.E.*, February, 1914.

CHAPTER IV

APPARATUS

General.—It will not be necessary to discuss in detail the different kinds of machinery which are needed to complete a lighting system. Prime movers and their accessories are standard. The electric generators are also standard, both in direct-current and in alternating-current machinery. Engines, generators, transformers, regulators, meters, etc., are also individually the same apparatus as has been considered in general work. A few remarks may be made, however, upon the assembly of these parts and in description of special forms or devices. The lamps themselves will be taken up at a later point in the text.

Constant-potential Circuit Relations and Switchboards.—The constant-potential system of distribution is fed most simply, directly from the terminals of the generator. In the case of a direct-current supply, the voltage of the generator is the voltage of the system. This may be true for an alternating-current system, or there may be in this latter instance the interposition of transformers to step down the voltage, or a double set to step up and then step down. With alternating current, the generation may be either single-phase or polyphase. In point of fact, systems of any considerable size are always polyphase. Each phase may then be run out separately or they may be combined into polyphase circuits. Here, the common practice is to distribute by polyphase circuits in order to render available all the advantages of this system, namely, economy of generation and distribution when a load is fairly balanced, and polyphase torque characteristics for power utilization. The advantages of the constant-potential system have already been shown. The arrangements are given in Fig. 14, where the solid lines of the wiring diagram indicate the circuits coming from one small, 2300-v., three-phase, a.-c. generator to the switchboard instruments and switches and then passing out to two separate feeder lines. The exciter is shown with its rheostats. Three ammeters permit simultaneous readings to be taken upon all phases. The

one voltmeter is shifted from phase to phase by means of the potential plug. In Fig. 15 is seen the arrangement of these parts upon the panel itself.

Enlarging upon this system, it becomes necessary to provide for larger outputs from single machines and for the paralleling of two or more machines for simultaneous operation upon the same bus-bars. Synchronizing apparatus appears upon the

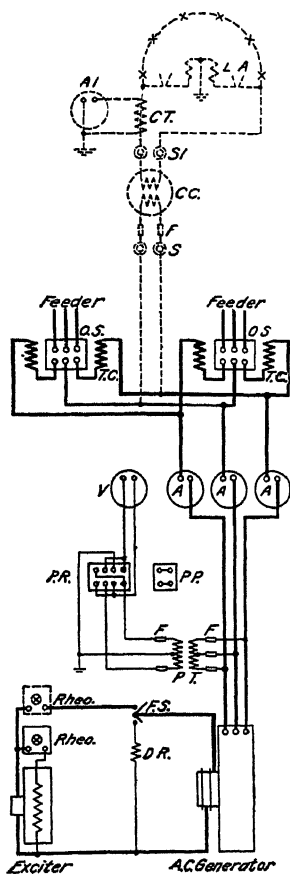

FIG. 14.—Diagram of circuits for separately excited, 3-phase arclight generator, with two sets of feeders at constant potential and one arc circuit.

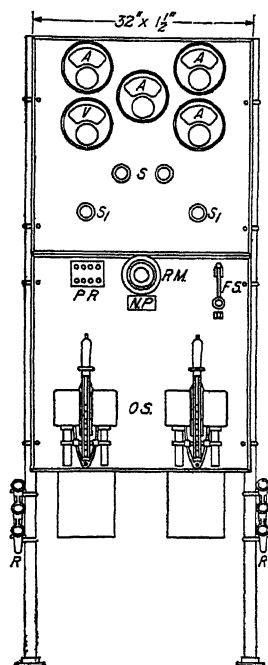

FIG. 15.—Switchboard panel for 2300-volt, 3-phase generator with two sets of feeders at constant potential, and one arc circuit.

switchboard. If not electrically controlled, each generator has its individual panel, with buses mounted in the rear of the series. Taking a-c. switchboards only as an example, there are three distinct types, namely: (a) the direct control, where the switches, meters and all apparatus are mounted directly upon the panels;

(b) the remote mechanical control, where oil switches, instrument transformers, etc., are displaced from the panel by any distance which may be spanned by mechanical articulation; and finally, (c) the remote electrical control, where the panel carries control circuits and indicating devices, instruments, etc., but all power-circuit devices are housed in any suitable and convenient part of the building, being operated by electrical means from the minor circuits upon the panels. The factors which have greatest influence in determining the choice of type to be used

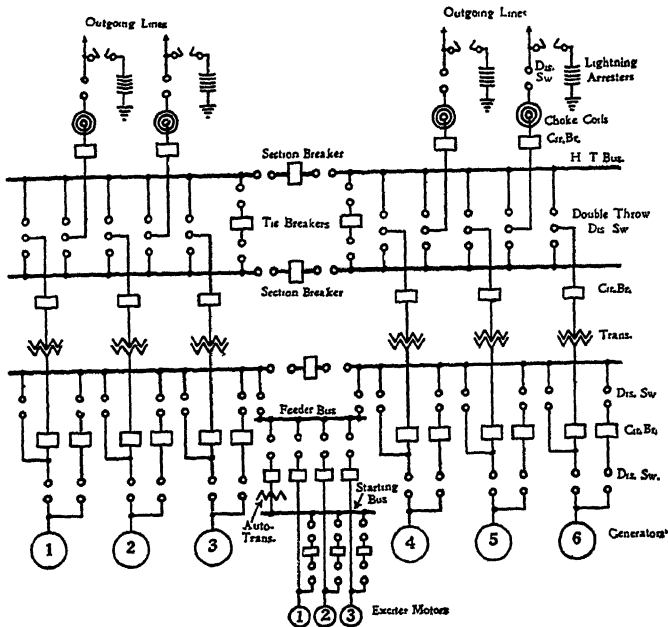

FIG. 16.—Operating features of circuits.

are: (a) the amount of power to be handled; (b) the essential operating features; (c) the space required; and (d) the permissible cost. These features are discussed in detail in the *Electric Journal*, vol. 10 (1913), p. 83. Fig. 16 taken from this article, indicates what is meant by the operating features. In such an illustration as this, it must be remembered that we are dealing with polyphase circuits and each of the lines shown is meant to represent a polyphase arrangement. The generators, the leads, the buses, the circuit-breakers, the transformers, etc., all fall into the same class.

Loading.—In loading polyphase lines, the attempt must be made to keep as near a balanced load as it is possible to achieve. The lighting load is most frequently applied by means of a balanced arrangement of single-phase transformers. These may be connected wye if a balance is always to be had, but if the demands of the three legs are allowed to vary independently of each other, the connection must be delta. Each leg is loaded as a two-wire or three-wire system, as it is desired.

Potential Regulators.—Potential regulators are used as soon as the size of the unit and the demands of the line regulation have sufficient influence. They are of two distinct types, the *induction type* and the *automatic type*. The former consists of a form-wound primary mounted upon a stationary laminated iron core resembling an induction motor primary (see Fig. 17). It may be single phase or polyphase. Inductively related to this is a secondary winding, mounted upon a movable inner member. Each leg of the secondary winding is connected in series with the corresponding leg of the primary, in such a way that the voltage induced in the secondary is added vectorially to the primary voltage. Inasmuch as the magnetic relation of primary to secondary is changeable, the regulation of the voltage upon the load side of the regulator is under control. The actual manipulation may be made by hand or by a small motor, automatically operated. These regulators are to be found in feeders, where each one takes into account the instability of its own load as regards voltage, one line running to a factory district while another line serves a residential section.

The *automatic potential regulator* is of a different character, in that it operates to control the voltage generated by the dynamo, rather than the potential delivered from a feeding point. With this distinction in mind, it is seen that the induction type is especially well adapted for the control of feeders as just indicated,

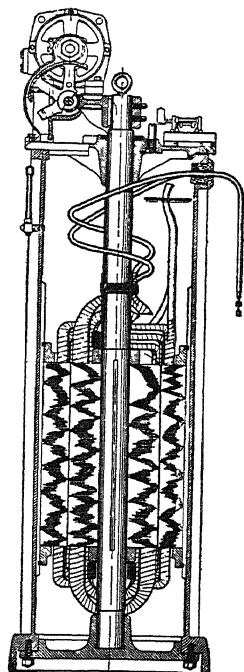

FIG. 17.—Motor-operated induction type of potential regulator.

while the automatic potential regulator operates to maintain bus-bar potential at a constant, predetermined value.

The generated potential is maintained constant by an automatic action upon the excitation of the generator. A floating contact is established across the rheostat in the exciter field (see Fig. 18) in such a way that too low a bus voltage operates to short-circuit the resistance and cause the exciter voltage to rise. This increases the excitation of the generator, which automatically serves to release the short-circuiting contact with a result-

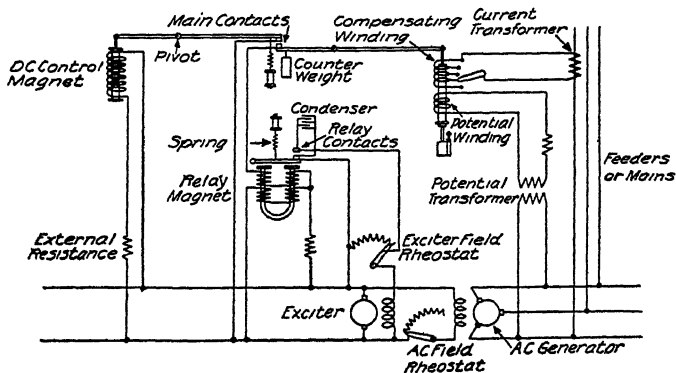

FIG. 18.—Simple diagram of circuits for automatic potential regulator.

ing drop in voltage. The action is so rapid that the average or effective field excitation of the generator gives the required bus-bar potential. Heavy loads operate to cause the length of the short-circuiting period to increase. Light loads cause a lengthening of the open-circuiting period.

The *proper regulation* of circuit voltages will give steady illumination from the lamps, a longer lamp life, better satisfied customers, an increase in load, an increase in the load-handling capacity of the several elements of the circuit and a higher operating economy in general.

Constant-current Circuit Relations.—Constant-current systems involve both incandescent lamps and arc lamps the same as the constant-potential systems. There are two fundamental methods of supplying a varying potential when current is kept constant. The original method introduced the constant-current generator which was very highly developed in direct-current practice. In alternating-current service the regulation for con-

stant current generally devolved upon the constant-current transformer. Present practice in nearly all cases makes use of a constant-potential alternating-current generator supplying energy to constant-current transformers. This circuit may then feed directly to the lighting units or the current may be rectified by a mercury arc set, and then go to the lamps. With incandescent lamps the alternating current is just as satisfactory as the direct current, provided the frequency is above 25 to 30 cycles per second. Common practice, therefore, is to install series incandescent lamps upon a-c. circuits. When arc circuits are run, it depends upon the type of lamp used as to whether it will be possible to use the alternating current or not. For example, the luminous arc requires that its magnetite electrode shall be negative. It is used on a direct-current system, therefore. As above indicated, such a demand is met by the use of constant potential generation, constant-current transformation and rectification.

Constant-current Transformer.—The constant-current transformer is seen in Fig. 19. This particular unit is a combination adapted to the magnetite arc service and consists of the transformer and rectifier mounted together. The outer casing of the transformer is removed showing the core with its fixed coils and with its movable coil balanced by weights. The rectifier tubes are enclosed in the oil tank at the right. In this case, there are two mercury arc tubes. For 100- and 75-light sets and for some 50-light sets, two tubes are put in series. For lesser numbers, only one tube is used. These transformers are made in sizes for lights varying in number from six to one hundred. They are rated at 4 amperes and 6.6 amperes with primary voltages from 220 to 13,200 volts. They operate on either 25 or 60 cycles per second.

For alternating-current arcs, these transformers are generally rated in terms of the number of lamps to be carried, as, for example, 25, 50, 75 or 100 lamps. They run on 6.6, 7.5 and 10 amperes with primary potentials of 1100 and 2200 volts. Incandescent lamp loads are supplied from constant-current transformers rated up to 25 kilowatts. Currents are standardized at 4, 5.5, 6 and 7.5 amperes. Primary voltages are generally 1100 or 2200 volts. The power factor of the combination of one of these transformers and an arc load is as low as 0.60 to 0.70 at full load. On an underload, this figure is materially depressed.

A special type of series transformer has come into use recently to serve the purpose of making a satisfactory connecting link between the low-current series distribution system and the high-

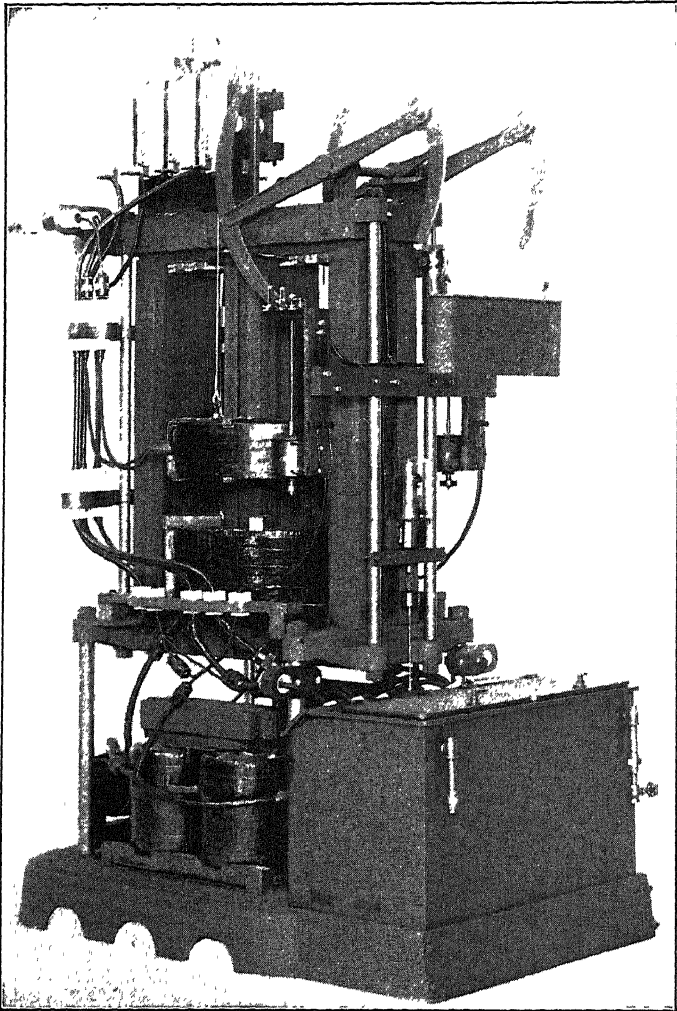

FIG. 19.—Constant-current transformer with double-tube mercury-arc rectifier; General Electric, 6600–6750 volts, 75 lights.

current incandescent lamp. The large type C mazda lamps are inherently heavy-current lamps, taking 15 to 20 amperes. The series arc-lamp circuits are designed for 4 to 7.5 amperes. It

may be desirable to put a few mazdas in series with the arcs, in which case they are attached to the 20-ampere secondaries of transformers with primaries rated at the current value of the circuit. Even when series incandescent lamps alone are to be used, the high current value would make direct distribution rather inefficient or expensive. The transformers may therefore be used in this case also. They are built in sizes ranging from

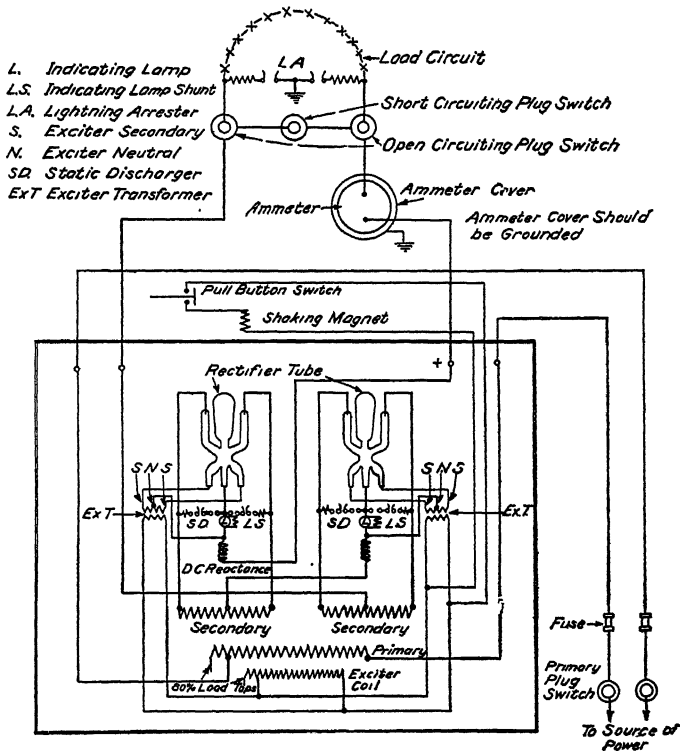

FIG. 20.—Diagram of circuits for two-tube mercury-arc rectifier.

the small single lamp capacity of 40 watts to those capable of carrying many lamps aggregating 10 kw. They are air-cooled in the smaller sizes, although they are oil-cooled in sizes above 2 kw. The small ones are installed in the housing directly above the lamp socket and become an integral part of the unit.

It is necessary to put a short-circuiting protective device across the secondary terminals so that if the circuit opens by accident the high impedance of the primary will not cause trouble.

Mercury Arc Rectifier.—The mercury arc rectifier is very widely used today to rectify alternating current for certain purposes. Unique, broadly inclusive, efficient and cheap, it is practically exclusive in its own field. Among its important uses is its application to the field of lighting. In company with the constant-current transformer just described, it has displaced all d-c., constant-current generators. With this new practice, there have been established a very large number of installations, all over the country, of the luminous arc circuits. As we shall see later, this lamp is especially effective in street lighting. The importance of the rectifier is therefore great. When two tubes are connected in series, the circuits are as shown in Fig. 20. Starting from the positive terminal at the upper right hand corner of the panel, the circuit may be followed through ammeter, load, to negative terminal, to the center of the right hand secondary, through either half of this secondary (say, to the right) down through the right tube to the center lower arm, to the center of the left hand secondary (to the right) through half of this secondary, down through the left tube, and thence to the starting point.

Requirements in Metering.—In no other field of electrical operation is the matter of metering so important as in the field of electric lighting. This arises from the fact that the process of serving the public is a retail process with a large number of customers, the average consumption being small. The presence of an error in the measurement of the service, with a consequent inaccuracy in the payment therefore, may upset all calculations as to economies practiced, and the usually narrow margin between a surplus and a deficit may be wiped out. Even supposing that the errors are not cumulative but largely cancel each other, inaccurate metering is unfair to both the customer and the central station and is unbusinesslike. It is necessary, therefore, to establish a meter service that is above the suspicion of being crude in any sense.

The meters¹ should be tested in place and these tests should occur periodically. The frequency of the tests may vary from six to twenty-four months, depending upon the type of the meter and its rating. The standards used for this work should

¹ Many states now have definite regulations enacted governing these details of public utility service. A good compilation of representative laws will be found in the annual report of the Com. on Meters, N.E.L.A., June, 1914.

be accurate within one-half of 1 per cent. They should be checked daily with reference standards. Errors of over 1 per cent. found in service meters should call for adjustment while errors exceeding 4 per cent. should necessitate correction and adjustment of bills.

Demand Indicators.—In connection with this matter of accuracy of measurement of energy, it is well to recall that not all charges are based upon meter readings. There are several

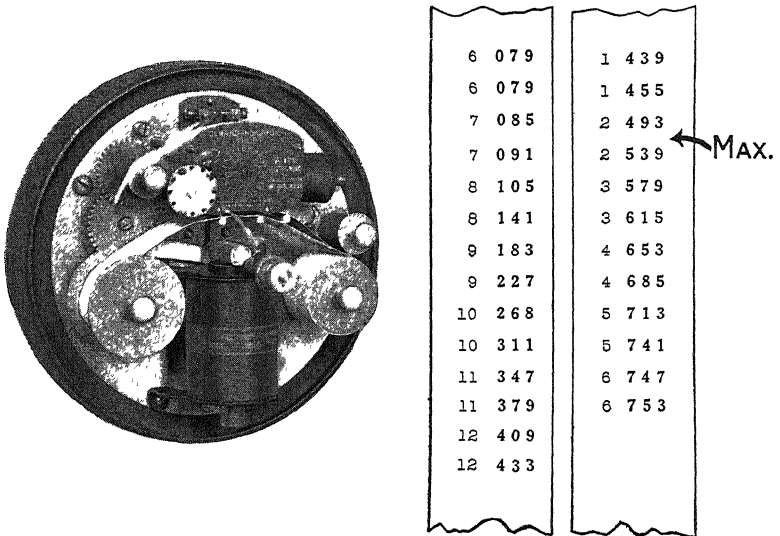

FIG. 21.—Type P demand indicator (Printometer, General Electric Co.), with record.

methods of establishing rates. Some of these are simple in construction while others are more elaborate. Anticipating the discussion of these processes, we will call attention to the fact that one of the elements frequently given prominent place is the maximum demand made by the customer upon the system, as measured in kilowatts. When a knowledge of this feature is desired, the service company either guesses at it or measures it. The guess is made by considering the size of the installation and the class of service to be rendered—whether it be residence lighting, shop or sign lighting, etc. To measure the demand, there have been developed the maximum demand indicators of several different types. They are constructed: (a) to integrate and record the demand for certain predetermined intervals;

or (b) to draw a curve of the demand as it varies. The device may be "lagged" so as to cause it to refrain from following to the extremes rapid variation of current. As classified by the N.E.L.A. Committee on Meters,¹ we find both independent instruments and attachments to watt-hour meters, although some record in terms of amperes and some in terms of watts. One type simply indicates the demand being made at any instant but does not record it. A recording device may be included which will intermittently print or otherwise register the demand then made, or will draw a continuous curve of the demand. The inter-

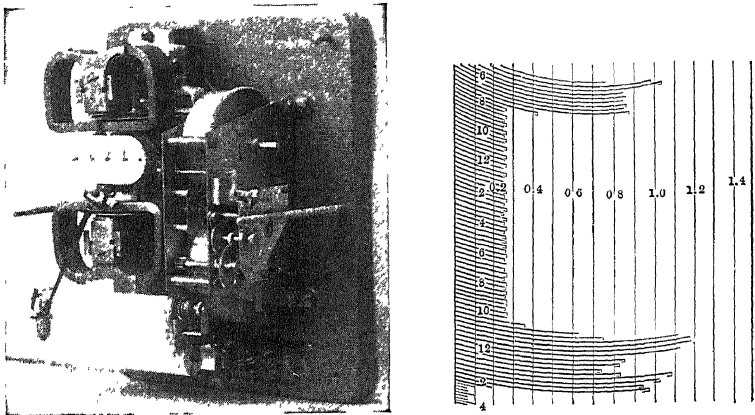

FIG. 22.—Recording-demand watt-hour meter; Westinghouse, type RA, with record.

mittent records may be made with corresponding time records, with fixed time intervals, or by noting the length of time it takes for a predetermined number of kilowatt-hours to be used. Furthermore, there are those instruments which simply leave an indication of the maximum rate at which energy had been used during the interval that they have been allowed to operate. If the excess demand is to be denied the customer, it is necessary to install a type of device which will either periodically or permanently interrupt his circuit when the specified limit is passed. Upon the other hand, it may be that the increased consumption is to be allowed but with the penalty of being paid for at a different rate. In this instance, there is installed, besides the

¹ Reports, N.E.L.A., June, 1914, Technical Vol., p. 22, and May, 1917, Technical Vol., p. 228.

regular meter, an excess demand watt-hour meter which will operate only when the demand is greater than the specified amount. When the cost of energy is different at different times of the day, a two-rate watt-hour meter is used, equipped with two registers, one to record the consumption of energy during the "peak" interval, the other to record that during the "valley" interval.

As one illustration of the above, there may be seen in Fig. 21, the instrument known as the printometer with a sample of the record which it makes upon a strip of paper. This instrument prints upon a paper strip at regular intervals the integrated kilowatt-hours and the time of recording. The difference between any two successive readings gives the integrated demand for the interval.

Fig. 22 shows a form of demand indicator which is assembled with the watt-hour meter. Its recording pen is advanced across the paper strip a distance proportional to the integrated demand for the specified stroke. The record is made upon the return stroke of the pen when the latter is released at the end of the period:

CHAPTER V

INCANDESCENT LAMPS

History and Process of Manufacture.—The incandescent electric lamp is about 35 years old, having been a commercial product since early in the eighties. The original form of the lamp has been retained to a remarkable degree throughout the momentous changes which have brought about improvements in economy, efficiency and uniformity of product.

Early experimenters used for the incandescent member platinum in air, platinum in vacuum, etc., but the first successful commercial lamps were constructed with carbon filaments. Edison instituted the use of carbonized bamboo filaments, while other materials employed included paper, cardboard, etc. In practically all cases, cellulose in some form or other was formed into a thread or filament and then carbonized by heat. Finally, practice settled down to the use of cotton dissolved in zinc chlorid which gives a gelatinous mass. This jelly was usually squirted through a very small opening, the thin string falling into a vessel containing alcohol which acted as a drying agent, leaving a long, almost colorless strand which could be handled and formed into proper shapes at will. The formed filament was then allowed to harden, after which it was buried in sand and carbonized by heating.

The filaments produced by this process were not of uniform section and this presented certain difficulties. The point of minimum section was weak mechanically. Moreover, it was a point of high resistance and by taking an undue share of the voltage drop it absorbed more energy than adjacent sections and became abnormally hot. This increase in temperature shortened the life of the filament because it concentrated the volatilization of carbon at that weak point. However, by a process developed to eliminate this trouble, the latter fault was made to correct itself. The filament was mounted in an atmosphere of hydrocarbon vapor such as gasoline, and brought to incandescence. At the weak, high-temperature spots the vapor is decomposed and a deposit of carbon is formed upon the filament. This

strengthens the point and tends to equalize the resistance per unit length throughout. The treatment is known as *flashing the filament*.

The carbon filament has numerous characteristics which make it very satisfactory, especially, when it has been given a further treatment by raising it to a very high temperature. The strength is retained, while there is added thereto a greater stability at high temperatures. Vaporization and blackening of the bulb are not as great. The temperature characteristic is changed so that instead of having a large decrease in the resistance of the carbon as temperature increases there is a slight increase in the resistance. This tends toward a better regulation of light. Because of this positive temperature characteristic, which is similar to that of a metal, the filament is said to be "metallized."

Metal Filaments.—Besides the carbon and the metallized carbon filaments, there have lately been used for filaments, tantalum and tungsten. The former came into use about 1907 and had a promising but short life in the market, owing to the fact that tungsten was found to be available and suitable, possessing better characteristics than tantalum. Today, there are practically no plain carbon lamps installed, the metallized carbon being the only form in which carbon appears. The tantalum lamp has entirely disappeared, while the tungsten lamp is replacing almost everything in the line of incandescent lamps. Under the trade name of mazda, it has been developed from a fragile, low-voltage lamp to a sturdy, high-efficiency and even high-voltage lamp. It is presented in sizes from 15 watts to 1000 watts for installation on constant potential systems of 110 volts and 220 volts. It is made also for series circuits in sizes from 30 to 500 watts with ratings from 32 to 1000 candle-power. Small units for signals, headlights, etc. are common.

The most serious difficulty which had to be overcome before the tungsten lamp became practicable, was the matter of forming the filament. Tungsten was not workable in drawing as were other metals and all early filaments made of it were cast, molded or squirted by using the oxid mixed with various other compounds which could later be driven off by heat. The oxid itself was reduced, leaving a sintered metallic filament. Persistent research, however, resulted in the discovery of a process whereby tungsten is made ductile, and can be drawn after swaging to a diameter less than one mil. Now, all tungsten filaments are made by drawing.

The product is much superior to the earlier one and will stand very hard usage and operate in any position. The wire has a high tensile strength and may be given sharp bends. Even after being used for a considerable time it is strong and flexible, although with use these characteristics become less satisfactory.

Gas-filled Globes.—In a later type of construction, the filament was curled into a small, close helix and mounted in an atmosphere of nitrogen. These lamps are known as the nitrogen-filled mazdas. Other gases are used similarly, the principal competitor for nitrogen being argon. In fact, argon (80 to 90 per cent.) has now precedence over nitrogen and replaces it in common practice. Wonderfully brilliant units are produced and economy is remarkable, especially in the large sizes.

The use of the close-coiled helix serves to lessen the evaporation from the filament for there is less exposure. This would lengthen the life of the lamp if it were run at the same temperature. Furthermore, it will permit running the filament at a higher temperature for the same evaporation and life. This latter practice is current, as it increases the efficiency of the lamp.

Chemical "Getters."—Certain chemicals when introduced into the lamp bulb make operation more efficient and life longer. These are called "getters." They function by making the deposits upon the glass walls more transparent or by causing a deposition of evaporated metal upon the filament itself rather than upon the bulb.

Lamp Details.—The carbon filament lamp consists, essentially, of an evacuated bulb, frequently pear shaped, in which is mounted a loop of carbon connected to leading-in wires which, in turn are attached to the outside terminals of the device. The filament is formed in one, two or three loops, sometimes supported at intermediate points, and varies in length and diameter according to the voltage, candle-power, etc. A 16-c.-p., 110-volt lamp has a filament about 9 inches long and 5.5 mils in diameter. The last half mil represents approximately the increase in diameter due to flashing. The filament has a metallic gray sheen and is very sturdy. It is fastened to 7-mil platinum leading-in wires, about 0.25 inch long by a deposit of graphite around the two. These platinum wires attach to copper leads, the joint and about half the platinum being imbedded in the glass. The copper wires then run through the plaster-of-Paris and porcelain used to attach the globe to its base. The usual form for the latter consists of a

threaded brass screw sleeve around the stem, as one terminal, with a brass tip upon the center of the stem as the other terminal. The bulb is usually exhausted from the other end and the sealing process leaves a tip to the glass.

In the details of base, leading-in wires and bulb, the tungsten lamp is similar to the carbon lamp. The bulbs are even about the same sizes for corresponding wattages. The filament mounting and dimensions differ very greatly, however.

A 100-volt, 100-watt, tungsten lamp has a filament about 3 mils in diameter. A 10-watt lamp uses 0.75 mil-wire. It is remarkable to note that these are *drawn* wires. The platinum sealing-in wires do not connect directly to the filament in this case because of the type of mounting used. Because of the fact that the resistance is low, the filament is of small diameter but also of greater length than the carbon filament. A 110-volt, 40-watt lamp uses a filament about 22 inches long. Such great length assembled within a small bulb necessitates numerous bends. This is accomplished by providing a central glass stem having supporting wires arranged like the spokes of a wheel. The tungsten wire is then lead back and forth from upper to lower supports, progressing around the stem and completing the circuit. It is possible thus to mount in a small bulb a filament of three feet or more in length. For the higher voltages this increased length is necessary, but in all cases the measurements must be very accurate.

The attachment of the filament to the leading-in wire is accomplished by fusing them together or even by inserting the filament in a hole in the end of the lead and pressing the two together firmly.

In special cases a double filament is provided, one being for high candle-power, the other for low candle-power. The change from one to the other is made by a pull-chain or other device. One such design puts both filaments in series for low candle-power operation and cuts out the high resistance, short filament for full illumination by the regular filament. When the two are in series, only the low candle-power filament glows.

Flux of Light. Distribution Curves.—Light flux from incandescent lamps varies in quantity rather widely as the direction from the bulb is varied. For example, there is one minimum directly below the tip, another one above the base. A maximum occurs near the horizontal line if the axis of the bulb is

vertical. The intensity from one of these positions to the other varies gradually over some such curve as is shown by Fig. 23.

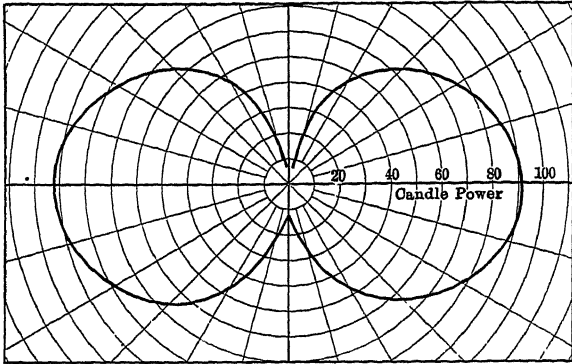

FIG. 23.—Vertical distribution curve of light flux from incandescent lamp.

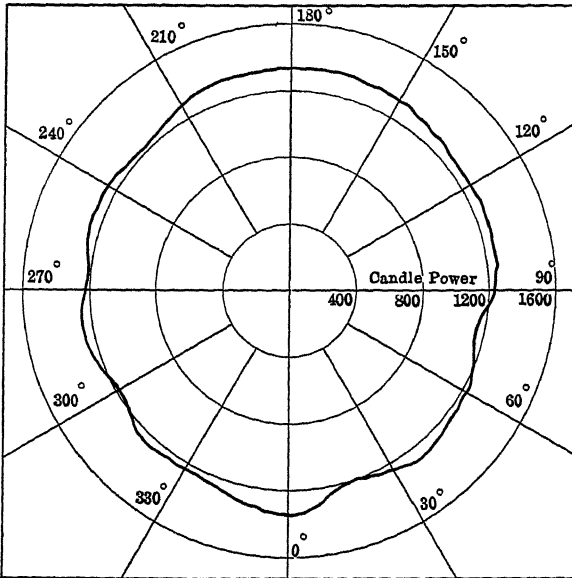

FIG. 24.—Equatorial light flux from 750-watt, 1000-c.-p., nitrogen-filled tungsten-filament lamp.

It will be noted, however, that the bare lamp is scarcely ever used nowadays, some shade or reflector generally being added. By the

use of such devices the light may be distributed to comply with any desired plan.

The light flux from the tungsten lamp is practically like that from the carbon lamp so far as the distribution is concerned. The maximum occurs on or very near to the horizontal plane. Upon any parallel of latitude of a surrounding sphere the light flux is nearly constant for all points. Hence, the curve shown is the measure for all axial planes.

Minor variations from this occur from several causes and are noticeable chiefly with single-loop filaments as they are less symmetrical in all axial planes. Sharp minima exist where one side of the filament hides the other, or where the supporting stem casts a shadow. Maxima may be noticed where reflections from the opposite face of the bulb are concentrated. As before mentioned, however, these are the individual characteristics of each lamp and are of such magnitude as to be unimportant except when they fall directly upon the work and thus produce annoying contrasts. With a 750-watt, 1000-candle-power, nitrogen-filled lamp, having six fairly straight sections or parts to its zig-zag filament, the variation found amounted to 6.8 per cent. (Fig. 24). The maxima and minima are not sharply defined, because of the numerous sections.

Rating of Lamps.—In the rating of incandescent lamps, it is necessary to recognize voltage, candle-power, efficiency and life. These four items need not all be placed upon the label, which in fact, is fully satisfactory if it shows the proper voltage for the unit and either the candle-power or the wattage. Formerly, all lamps were labeled in candle-power. The constant potential lamps are now most generally rated in watts consumed. The occasion for this change in practice came about when the metal filament lamps were replacing the carbon lamps. It was not found possible at first to manufacture a metal filament for the low candle-powers in use with carbon, and give it the required strength. Hence, the public was expected to replace a 16-candle-power, 51-watt, carbon lamp by a 32-candle-power, 40-watt metal lamp. This was in the interest of true economy inasmuch as a greater amount of light was secured from a lesser expenditure of energy. But the commercial aspect of urging the consumer to purchase lamps having twice as high a rating (in candle-power) would put a damper upon sales and this necessitated that a special emphasis be placed upon economy in

order to overcome the psychological first impression. The result was that everybody interested in service, production and sales began talking "watts" instead of "candle-power" and thus rated the new lamp.

It should be noted that the old candle-power rating of a lamp was the *mean horizontal candle-power (m.h.c.-p.)* and had to be multiplied by the *spherical reduction factor* in order to give the *mean spherical candle-power (m.s.c.-p.)*. Its definition, therefore, depended upon the uniformity of this factor. Fortunately, the arrangement of the filaments did not differ so seriously as to cause a material variation in the factor for standard lamps. For the standard carbon filament lamps this multiplier is 0.78. The 110-volt mazdas also require this same value, except for some of the larger sizes in the round-bulb pattern, where the distribution is very slightly more uniform. For the 100-watt round-bulb concentrated-filament lamp the factor rises to 0.955, showing a m.h.c.-p. almost identical with the m.s.c.-p.

The change in rating has given something definite and individual as a basis, and is preferable in some respects to the old form. It is probably the case, however, that a gradual introduction of the term "lumen" will result in a far more satisfactory and scientific rating. It will present a unit in which the total output of the lamp can be expressed without a direct reference to the input. In buying a lamp, this puts the transaction upon the grounds of a purchase of a service or a product rather than a purchase of an opportunity to pay for a certain number of watt-hours used by the lamp.

When candle-power is spoken of it is to be understood as referring to the m.h.c.-p., unless otherwise specified. By direct restriction it may refer to the mean spherical, the mean lower (or upper) hemispherical, or to the light flux in any specified direction.

Voltage Rating.—Practice in voltage rating has varied in recent times. The rating has always referred to the normal or proper voltage for the unit, but, due to the change in efficiency of lamp operation with changes in voltage and an inverse change in lamp life, the practice came into vogue of establishing three voltage ratings for a lamp, differing in steps of two volts, as 118–120–122. A lamp so rated was intended to be operated on the 122-volt circuit, unless energy is very cheap, in which case, the operation on a lower voltage increases the life of the lamp more than enough to pay for the extra energy required in

order to secure sufficient light. This is a rather extreme condition and is found to occur so infrequently that the utility of the whole scheme is questionable. The conditions for carbon lamps and metal lamps are not identical and the maximum rating only is now being used.

“**Efficiency.**”—The term *efficiency* as used in connection with lamp economy, is applied very loosely. Very frequently it is made to replace the term “specific consumption” and is expressed in watts per candle-power. The inverse of this would be “specific output” and would be given in candle-power per watt, or, better still, *lumens per watt*. Neither of these is strictly an expression for efficiency, which is the ratio of output to input. If it can be established, probably the most satisfactory usage will be to refer to the specific output of the lamp and give it in terms of lumens per watt. This will have the advantage of connoting the quantity of light flux from the light source, regardless of its distribution. The modification of the latter can be taken care of by the shades and reflectors.

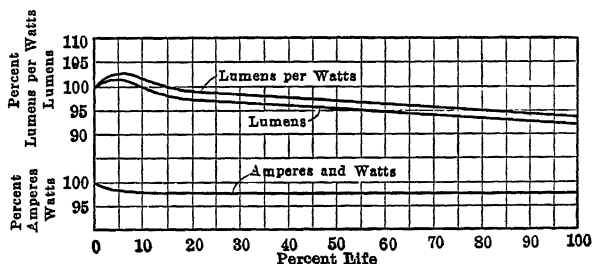

FIG. 25.—Typical performance curves of Mazda type-C lamps.

Life.—The life of a lamp is an arbitrary standard, chosen as a result of experience. It is found that the candle-power of a lamp falls off due mainly to blackening of the bulb. A little decrease in output is not serious, but there comes a time when the loss in output is great enough to warrant renewal of the unit. The time at which this occurs is affected by the cost of power, the cost of lamp, etc., but for the old carbon lamp it was in the neighborhood of a 20 per cent. decrease. As a result, the life of a lamp became known as the figure representing the number of hours that a lamp could be used before falling to 80 per cent. of its original and normal output. This figure having been once established, is used as a reference point for the metal-filament lamps, also. The value for life of lamps has risen steadily. Not

long ago it stood at 800 service hours. Now the normal rating is at least 1000 hours while numerous types are evaluated at 1300 to 1700 hours or more.

While the lamp is being used, its candle-power is decreasing along some such curve as that shown in Fig. 25, which is the experimental curve for 25-watt and 40-watt mazdas. The curve rises at first due probably to a bettering of surface radiating conditions of the filament during the first few hours of incandescence. The falling off in candle-power follows this rise and is due to the blackening of the bulb, the wasting of the filament, etc. At the same time there is a lessening of the current taken by the lamp, the actual power used thus being diminished. This decrease, however, is not as rapid as the decrease in candle-power, hence, the specific consumption increases during the process from 1.17 watts per candle-power to 1.36 watts per candle-power. These data are plainly presented by the additional curves shown in the figure and evidence the fact that sooner or later the lamp will deteriorate until its inefficiency as compared with a new lamp will warrant the expense of smashing it and installing a new one.

Operating Characteristics. Departure from Rated Voltage.—

The use of a lamp upon a circuit in which conditions do not conform to the rating of the lamp, gives rise to certain undesirable results. When, for instance, a lamp is run at too high a voltage, the candle-power and light flux are increased, although this is at the expense of the life. The variations in lumens output for certain lamps are shown in Fig. 26. Taking as an example the 110-volt mazda lamp, we find that an increase from normal of one volt (*not* per cent.) will give an increase in lumens of 3.2 per cent. with an accompanying increase in wattage of only 1.4 per cent. An increase of 2 volts will give a flux greater by 6.5 per cent. with a consumption of 2.9 per cent. more watts. Decreases of 1 and 2 volts, respectively, give flux decreases of 3.1 per cent. and 6.2 per cent. with consumption decreases of 1.5 per cent. and 2.9 per cent. Not only is this of interest in considering the economy of the installation but it shows the necessity of seeing that the voltage is steady enough to give no appreciable flickering of lights. As will be mentioned again, a variation of about 1 per cent. in brightness is noticeable to the average observer and any fluctuations in voltage which effect as great a change as this are to be avoided.

It is frequently the case that lighting companies which have been running for several years without making a voltage survey of their systems will find upon inspection that an increased load demand has resulted in line losses which have reduced their voltages below normal in many unexpected places, thus lowering the station output and, more seriously, lowering the light produced at patrons' lamps, giving cause for dissatisfaction and

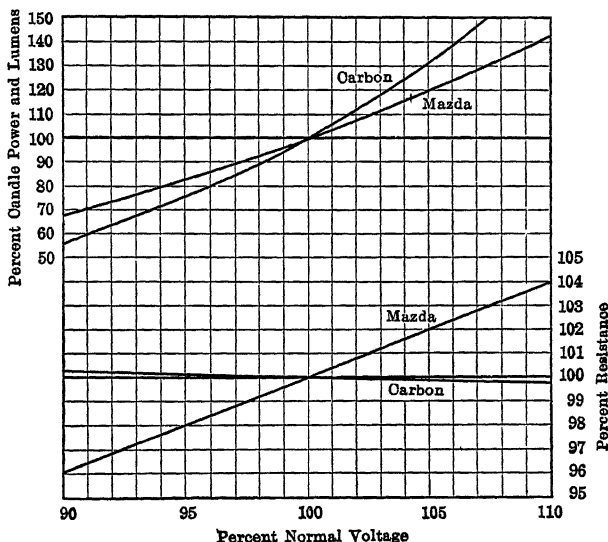

FIG. 26.—Percentage variations in candle-power, lumens and resistance with variation in voltage of operation of incandescent lamps.

complaint. While it is manifestly impossible to maintain the entire system at one voltage, it is usually possible to come near enough to the one figure so that an average voltage may be adopted, allowing some localities to run on slightly over-voltage and another portion of town to operate at under-voltage. If the extremes cannot be narrowed enough without an excessive outlay for copper or for boosters, there remains the possibility of establishing voltage zones, and supplying to each zone the lamp which it requires.

Operating Voltages.—To manufacture a product which would conform to all of the requirements of the foregoing standards and be uniform is a difficult task with carbon filaments. As a result, especially in early times, it has been necessary to sort all

lamps into groups having similar ratings and sell from that group which meets the customer's needs. The great latitude allowed in central station practice in the so-called 110-volt range, namely, anything from 100 volts to 132 volts, is a result of the inaccuracies of earlier manufacture. Rather than scrap the lamps which give normal life and candle-power at 108 volts, they were offered at lower prices to companies willing to use them. In time, this benefited the price of all lamps as it reduced the first cost.

Although so wide a divergence in product is no longer necessary from the standpoint of the manufacturer, the demand has been established and lamps now have to be made to conform thereto. However, there is evidenced, by present lamp sales, a decided tendency to adopt as operating voltages the figures 110, 115 and 120. This would be done by so choosing for all new systems and by relocating the value for all old systems having odd voltages. A consideration of the voltage-candle-power and voltage-life curves and the life of lamps will indicate that the transition state will easily permit all operating companies to raise their operating voltages to the next higher standard (say, from 112 volts to 115 volts) without seriously affecting the cost of service or lamp renewals to customers. New lamps issued should then conform to the new standard. Ultimately this will cheapen lamps, because stocks need not be carried in such a large variety of ratings and range of manufacture can then be restricted. This is entirely feasible now and should be put into practice.

Gas-filled Lamps.—The gas-filled tungsten lamp is unique in many respects. The filament, a drawn wire, is coiled into a fine helix and mounted upon glass and wire supports in rather short spans.

Langmuir states¹ that the blackening of the bulb of a metallic filament lamp may be due to two causes. If water vapor is present in the bulb, it will be decomposed at the filament, attack the tungsten and form an oxid. This evaporates and is deposited upon the bulb, where it is in turn decomposed by the free hydrogen, forming metallic tungsten to blacken the glass and water vapor to return to the filament and repeat the cyclic process. Where water vapor is not present, the blackening still occurs due to direct evaporation of the metal. The nitrogen introduced into the bulb forms a carrier by convection currents and

¹ *Trans. A.I.E.E.*, vol. 32 (1913), Tungsten Lamps.

will cause the tungsten to be deposited in the upper part of the chamber, whereas, without the gas, the metal would be deposited at a point radially outward from the point of emission which is just where it would do the most damage to the emission of light. The nitrogen is at a pressure of about one atmosphere and is found actually to decrease the evaporation of the tungsten.

The observations of Langmuir lead him to conclude that the ordinary blackening of the bulb is due mainly to filament evaporation. He states that after taking extraordinary precautions to evacuate bulbs especially of their water content the blackening occurred as before and to about the same extent as with the *best* of commercial samples. It would seem, therefore, that any sudden blackening may be due to the presence of water vapor in poorly exhausted bulbs; but the usual decrease in transparency of the commercial bulb is due to the deposition thereon of evaporated metal.

Specific Outputs.—The efficiency of any of these incandescent lamps is increased by raising the temperature at which it operates. That is, the higher the temperature, the higher will be the percentage of total energy which is utilized in the visible spectrum. The vacuum tungsten lamp operates at about 2100°C. while the gas-filled lamp operates at 2400 to 2500°C. In all cases, the question at once arises concerning evaporation. If it could be entirely overcome the filament would remain strong and the bulb transparent. But inasmuch as the rise in efficiency is accomplished by decreased life and decreased strength, there is an economic upper limit to the efficiency attainable.

With the carbon filament, the standard 50-watt lamp produces light at the rate of about 3.1 lumens per watt. If we take the metallized filament, we find a specific consumption of 2.5 watts per mean horizontal candle-power and an output of 4.02 lumens per watt. For the tungsten filament, the 40-watt, 110-volt lamp has a specific consumption of 1.10 watts per candle-power. This gives an output of 8.94 lumens per watt with an average life of 1000 hours.

Going to the gas-filled bulb with helical tungsten filament we find no direct comparison with the above figures because the units are not of the same size. Constant potential units are made in sizes from 1000 watts to 75 watts. In the larger sizes they will give 16.1 lumens per watt. This is the highest value commercially obtained from incandescent lamps. It is still well

below the specific outputs of nearly all of the present day arc lights, as will be seen by referring to the relative efficiencies shown in Table 9. The highest value shown is that of the titanium arc, with an output of 65.5 lumens per watt.

TABLE 9.—RELATIVE EFFICIENCY OF ILLUMINANTS
(Irrespective of Size, in Available Mean Sph. C.-p. per Watt)

	Available mean sph c.-p. per watt	(Street lighting) 10° c.-p. per watt	Available mean sph. c.-p.
3.1 watt per h. c.-p. carbon filament	0 21	0 4	Any
2.5 watt per h. c.-p. gem filament	0 26	0 5	Any
450 watt 6.6 amp. series enclosed a.-c. carbon arc..	0 39	0 5	175
Nitrogen Moore tube	0.45		
480 watt 6.6 amp. series enclosed d.-c. carbon arc	0.62	1 0	300
1 watt per h. c.-p. mazda lamp...	0 64	1.25	Any
500 watt d.-c. "intensified" carbon arc.....	0 78		
4 amp. 300 watt d.-c. standard magnetite arc . .	1.00	2.2	300
Neon Moore tube	1.10		
0.5 watt per h. c.-p. gas-filled mazda lamp.	1.28	2.5	Above 350
4 amp. 300 watt d.-c. special magnetite arc	1 40	3.0	(420)
6.6 amp. 500 watt d.-c. standard magnetite arc... .	1.50	3 2	750
Mercury lamp in glass tube, best values	1 55		
6.6 amp. 500 watt d.-c. special magnetite arc.....	1 70	3.6	850
220 watt a.-c. titanium arc	1 90	4.0	420
300 watt yellow flame arc, best values	1 95	4 0	(585)
500 watt white flame arc, best values.....	1.95	4 0	(975)
Mercury lamp in quartz tube, best values...	2.00		
Experimental 350 watt a.-c. titanium arc.....	2.70	5.4	(950)
Melting tungsten in vacuum.....	2.88		
500 watt yellow flame arc, best values.....	3.10	6.2	(1550)
Experimental 500 watt a.-c. titanium arc.....	3 60	7.0	(1800)
Titanium arc, best values (high power).....	5.20		

CHAPTER VI

THE ARC

General.—In the practical production of light by the arc, solid or cored carbons, impregnated carbons and metals are used for electrodes.

Carbon electrodes exemplify the earliest usage and continue to be important today in modified forms although during the last few years there has been such effective competition by newer forms of illuminants that the solid carbon arc is not now being installed at all. Its importance today lies in maintenance of older systems and its historical value. It also lends itself well to the study of fundamental notions of theory. In due time, it will be of value, therefore, to consider the characteristics and phenomena of the arc between solid carbons.

History of the Arc.—Definite history of the arc¹ begins in the early part of the nineteenth century (1809) when Davy made his announcements concerning the true arc. Other commentators for several years before and after this date failed to state clearly the conditions of their experiments and as a consequence, we do not know whether they were working with the arc or the spark discharge. Advance was very slow because of the fact that the electrical supply was necessarily obtained from expensive sources, namely, primary batteries. Higher voltages were obtained by the use of more cells but large values of current were not attempted. With the advent of the dynamo generator practical application of the beautiful laboratory experiment became possible and this lent impetus to research while the new energy source opened a wide field for investigation.

The Arc.²—As a descriptive, though incomplete, definition of the arc we may say that it consists of a persistent, localized

¹ A classic upon "The Electric Arc" appeared in 1895-6 in the articles (later, the book) of Hertha Ayrton who presented at that time an expert discussion and summary of the subject. The reader is also referred to the book "Electric Arcs" by Clement D. Child, published in 1913, which is a notable attempt to bring up to date the statement of our knowledge in this field.

² See *Trans. Am. El. Chem. Soc.*, vol. 29 (1916), p. 593, and discussion.

current-stream between two electrodes. Usually at least one of the electrodes is of a substance which furnishes a vapor affecting the arc phenomena.

This vapor stream in reality consists of two opposing streams of ions, the vapor being broken up into positively charged ions and negatively charged ions. The positive ions rush upon the cathode and heat it by the energy of their attack. Negative ions are emitted by the cathode, probably being originated by the force of impact of the positive volleys, and discharge to the anode.

In air the streams of ions ionize both electrodes and the intermediate vapors.

While there is more heat produced at the anode than at the cathode, it is not necessary that the anode should be allowed to reach high temperatures. It may be cooled artificially.

This is not the case for the cathode, which must be allowed to become hot and to maintain this condition. Otherwise it could not so readily permit

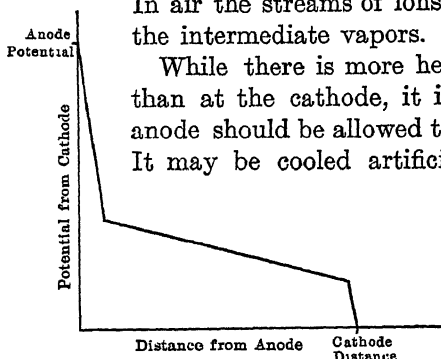

FIG. 27.—Potential gradient in carbon arc.

the formation of the stream of negative ions. Although either heating to a high temperature or impact of an ionized vapor stream will serve to ionize an electrode, it is undoubtedly the case that either one alone would not be sufficient to maintain the ordinary arc.

To establish an arc with electrodes at some distance apart, there must be applied a very high voltage. This brings the electrodes to a difference of potential sufficient to cause an electric spark to pass. The passage of the spark may be sufficient to ionize the intermediate vapors. The free ions are then forced by the potential strain under which they exist to project themselves in their individual directions, falling upon cathode or anode as the case may be. The action once established will continue as long as the potential does not drop too low to cause the ions to acquire a sufficient velocity to ionize by impact. When the temperature of the cathode rises, the impact energy need not be so great. Hence, after the arc is once established, the potential difference needed to maintain it is lowered.

The potential gradient through the space from positive

electrode to negative electrode as seen in Fig. 27 is not a straight line. It begins at the normal high value, descends suddenly in the space adjacent to the anode, falls off very gradually through the arc itself, and again quickly lowers at the cathode. The anode drop is greater than the cathode drop. Both of these electrode drops are lowered by increase of current, while cooling the electrodes will require higher voltages.

Mrs. Ayrton has shown that the potential for given arc length and current is not a constant but depends upon the length of time the arc has run. In some cases the initial voltage was quite low being 18 to 25 volts depending upon the types of carbons. The potential required to maintain the constant current rose rapidly in all cases and within the first ten minutes became 45 to 50 volts. A further slow rise occurred for a space of ten minutes after which the curve lowers somewhat, approaching a constant value of 45 to 48 volts. Again, a sudden change in current value required a sudden and excessive inverse change in potential difference, a slower recovery of voltage occurring later.

The appearance of the arc between carbons is very striking (see Fig. 28). The end of the anode (the positive electrode) is occupied by a large, white-hot crater. The tip of the cathode is likewise white-hot but over a lesser area. Through the space from tip to crater there extends a violet-colored flame or arc-core. Surrounding this is a more or less distinct non-luminous envelope. Again, surrounding all is a greenish envelope of considerable body. The violet core gives little light while the green envelope is quite luminous.

Upon the electrodes, the regions surrounding the white-hot spots are incandescent yellow, gradually shading away through red to black. An irregular circlelet of bright spots forms a ring around the cathode near the shoulder of the tip.

By far the greatest part of the light given off comes from the crater of the anode. This constitutes from 85 to 90 per cent. of the total light and is affected quantitatively by conditions of carbon electrodes, length of arc, etc.

The temperature of the arc is so much above that reached in other phenomena that it is only approximately evaluated. Many

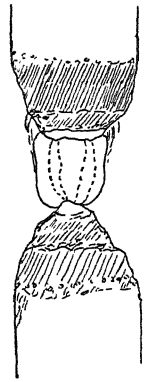

FIG. 28.—
Arc between
carbon elec-
trodes.

investigators have attacked the problem by different processes such as pyrometry, radiation, photometry, calorimetry, etc., and the best determinations agree that the temperature probably lies between the limits of 3600 deg. and 3800 deg. absolute. It is not known whether or not the temperature varies when current density varies although the light becomes whiter as the current density is pushed higher in the so-called intensified arcs. Certain it is that as current varies, the crater changes in area. Again, for constant current the crater will enlarge as the arc length is increased.

The characteristics of the arc are changed somewhat if the arc is enclosed in a loosely fitting globe. This effect is caused by the restriction of the amount of air allowed to reach the heated carbons. With the reduction of oxygen supply, there occurs a marked diminution of electrode consumption. The ends of the electrodes are flatter than for the open arc and a higher voltage is required for the same value of current. Open arcs are rated at about 45 volts while similar enclosed arcs would require 70 to 80 volts. The former run for about 10 hours on one trim while the latter will last 80 hours to 100 hours.

Arcs are possible between carbon electrodes with either d.-c. or a.-c. supply. This comes about from the fact that when the electrodes are once heated, the "spark voltage" is low enough so that when the voltage is reversed a spark jumps from electrode to electrode and the reversed current follows.

Open arcs are used yet for high rating or intense projection work. Search lights, moving picture machinery or large stereopticons are about the only applications. Flood lighting, spot lighting, small stereopticons, etc., are now largely using the gas-filled incandescent lamps with concentrated filaments.

Flaming Arcs.—It has been known for a long while that there are many substances which evidence their presence in arc-light carbon electrodes by giving to the arc itself a high luminosity. In fact, the unsatisfactory accompaniments to this process were short life, welding together of electrodes, flicker or unsteadiness of light, poor colors of light and the prevalence of fumes. These drawbacks have been attacked and more or less successfully solved or provided for.

Longer life was secured by lengthening the electrodes, providing a magazine-feed or by partial exclusion of the air. This gives electrodes lasting from 70 to 120 hours. Flicker is corrected

after careful experimenting for proper mixtures of salts, as is also the case with the sticking together or welding of the electrodes. The color of the light depends wholly upon the mixture used and there have been found certain combinations which give a fairly satisfactory white light. The presence of cerium salts tends to whiten light. Calcium fluoride and calcined calcium phosphate give yellow light. Strontium fluoride will redden the color while barium fluoride will make it whiter.

The best that can be done in regard to the fumes is to see that they are properly deposited, allowing them neither to escape into the open nor to collect upon the enclosing globes. This becomes very largely a matter of design of the lamp.

The mixtures of which the electrodes are made are poor conductors and when long electrodes are used on constant potential the arc voltage would vary considerably during the run. It is found necessary to supply a conductor through the body of the electrode, therefore, by inserting therein a small wire. This may be put in the carbon shell, in the mixed core or between the two. The carbon shell takes different forms but consists essentially of a form for containing or supporting the mixture of lamp black (40 per cent.) and metallic salts (60 per cent.).

Flaming arcs, in their turn, promised to sweep the field clear of competitors because of their high specific outputs.¹ They have been accepted in their best forms for street lighting with white light and for industrial lighting with white or yellow light. Some special applications are also made, such as photography, photo-engraving, therapeutics and dye testing.

The Luminous Arc is one in which the cathode is composed principally of magnetite (Fe_3O_4), powdered and packed into a thin iron tube $\frac{5}{8}$ to $1\frac{1}{16}$ inch in diameter. The anode is a copper rod sometimes having an iron sheath. Titanium carbide is also used for cathode.

The light obtained is a very near approach to white and comes principally from the arc rather than from the anode crater. On this account, the arc length is increased beyond that for the old style carbon arcs, being about $\frac{9}{16}$ inch.

The introduction of this arc into street service a few years ago gave rise to one of the greatest changes that has occurred in the practice of arc lighting. Its advantages include high efficiency,

¹ Compare Table 9, p. (62).

good light distribution,¹ good color, low maintenance cost, and good life. It therefore very quickly proved that the old open arc was a thing of the past and it limited the use of the enclosed arc to a narrower field such as indoor installations. Today as a street illuminant the open carbon arc is obsolete and the enclosed carbon arc is similarly giving away to the luminous arc and the later gas-filled incandescent lamps. There were in 1914 about 200,000 magnetite lamps in service.

Magnetite arc lamps are built in two forms. One takes 310 watts at 4 amperes, 75 to 80 volts, with an electrode life of 165–200 hours and a specific consumption of 0.59 watt per mean lower hemispherical candle-power (m.l.h.c.-p.). The other form takes 510 watts at 6.6 amperes, 75 to 80 volts with an electrode life of 120–150 hours and a specific consumption of 0.38 watts per m.l.h.c.-p. In the later form, the electrode for the 6.6 amp. lamp is usable in a frame for 4 amp. rate of consumption. This gives a life of about 350 hours.

Attempts are being made constantly to improve upon the efficiencies of these lamps and experimental results have been obtained with the 310 watt size of 0.42 to 0.30 watt per m.l.h.c.-p. while laboratory experiments have reached 0.21 watt per m.l.h.c.-p. The General Electric Company's practice is to put the magnetite electrode below. The Westinghouse Company puts it above. In each case, however, it is the cathode (negative).

¹ See Fig. 87, p. 214.

CHAPTER VII

GAS TUBE LAMPS

General.—The electric lamps described heretofore are the types universally known and utilized. A further possibility and even practicability is the use of tubes containing gases which act as the conductors. It is asserted that this action is largely one of chemiluminescence¹ and is a type of light production without heat. The efficiency of *light-production* may thus be raised although the overall efficiency of the device may not be high. For example, Angstrom calculated that he secured 95 per cent. light efficiency with a nitrogen tube at 0.1 mm. pressure, *without electrode losses accounted for*. But these losses brought the efficiency down to 8 per cent.

Moore Tube.—The gases used are numerous, but in all cases the pressure is much below one atmosphere. One commercial development in this line is the Moore tube which consists essentially of a gas-filled tube of any length up to hundreds of feet, built with sealed-in electric terminals between which is supplied the e.m.f. required to force a current through the rarefied gas.

The voltage across the gas column is supplied from the secondary circuit of a transformer which has a ratio of transformation such that it may have its primary connected to the regular distributing circuit, as 110 volts.

The most important point in connection with the operation of the tube is the maintenance of the reduced gas pressure at its proper figure. This is evidenced from the fact that the breakdown or glow characteristics of rarefied gases change very greatly as the degree of rarefaction changes. An enormous potential is required in order to send a spark through three feet of a gas at atmospheric pressure. If, however, the pressure is lowered by partial evacuation, the potential needed is found to decrease with the pressure until a minimum point is reached. Any further progress will demand greater voltages, and the e.m.f. again rises to prohibitive values. The point at which the Moore tube operates best is in the neighborhood of a pressure of 0.1 milli-

¹ BANCROFT, *Trans. I.E.S.*, vol. 10 (1915), p. 289.

meter of mercury, or just before maximum conductivity is reached. As the older form operated there was a gradual decrease in gas pressure and, at first, an increase in current for constant voltage. Later the vacuum became still better, and the current fell off due to increased resistance to breakdown. Evidently, the thing to do was to cause the first increase of current to admit a slight quantity of gas into the tube and thus maintain the stable action of the system. This is what was done, but probably one of the greatest hindrances to successful operation was to be overcome in doing this seemingly simple thing.

It must be remembered that the pressure within the tube is so low that the gas therein occupies about 7600 times the space it would at atmospheric pressure. To admit any appreciable

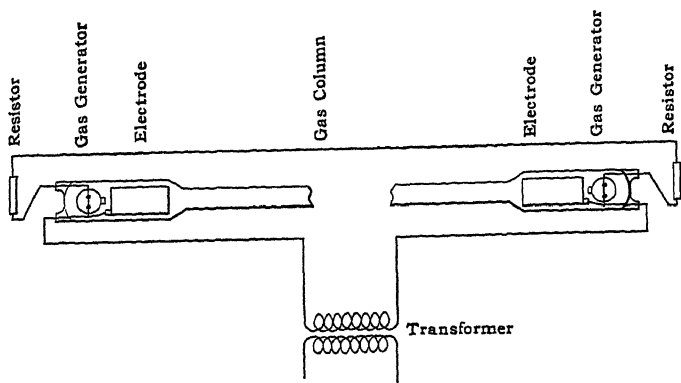

FIG. 29.—Diagram of circuits of Moore tube.

amount of gas would, therefore, spoil the vacuum and cause the tube to cease to operate. The valve evolved for this service consists of a mercury-sealed porous carbon point. One end of the carbon is presented to the gas chamber while the sealed end communicates with the vacuum tube. When the point is exposed to the low pressure inside of the tube, the gas pressure from the other end of the carbon stick causes a very small amount of gas to filter through the pores of the carbon and enter the tube. This quantity is very small, but it is of the magnitude needed. The current diminishes, the valve seals again and the lamp continues to glow.

A later design¹ does away with this valve by inserting a so-

¹ See "Gaseous Conductor Lamps for Color Matching," by D. McF. MOORE, I.E.S., vol. 11 (1916), p. 192.

called "gas generator" in the tube behind the aluminium electrodes (see Fig. 29). Here, a bulb containing a chemical is placed in series with a resistor and both are connected in parallel with the lamp circuit. When the gas-column is CO_2 , the generator contains calcium carbonate. The passage of current through this shunt path evolves CO_2 , and replenishes the gas supply. This type of control operates upon the other side of the crest of the current-gas pressure curve from that of the valve control. The former is shunt operated while the valve is series operated.

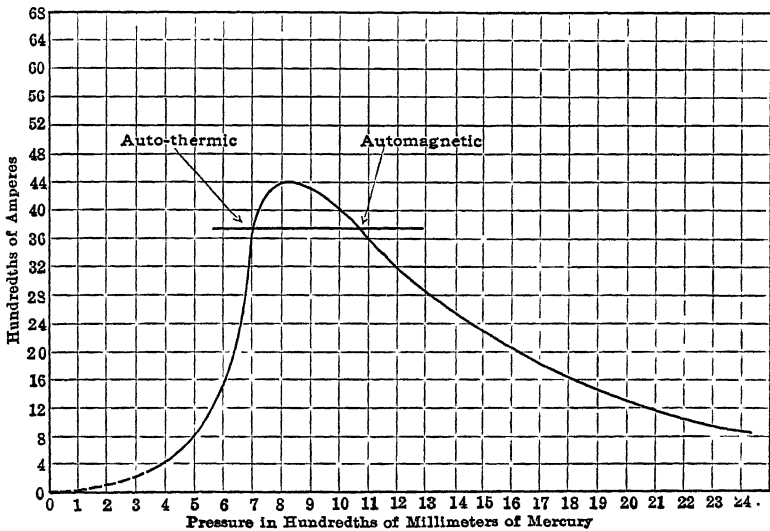

FIG. 30.—Characteristics of Moore tube.

The gas employed determines the color of the light, each gas having its own characteristic tint. Rarefied air gives a pink glow. Carbon dioxide gives nearly white light and is, in fact, used in the set of tubes especially prepared for color matching, as it is so near to daylight in color. Nitrogen gives a yellow color. Neon glows golden orange and is much more economical than the other gases mentioned.

It is readily seen that the length of the tube affects the efficiency of a unit for there are both terminal losses and tube losses to be supplied. The former are alike present in all lengths of tubes and unduly depress the efficiency of the short tubes. The economy of the tube is not very well evaluated. Figures given for any one gas vary rather widely although agreement is

reached in that the white light is less efficiently secured than are the others. On small units for this purpose the consumption is found to be about 3 watts per lumen. For the other colors, values may be obtained somewhat better than those for carbon lamps, neon being especially good. But here we have the same difficulty as with other types of illuminants, namely, that the undesirable colors are the ones most efficiently obtained.

It is not as easy to measure the light from a tubular source as it is to meter approximate point sources and this may be one reason why figures given by different investigators are so scattering. It is clear, however, that the tube light is not in a position to compete in the general field with the other illuminants, even in large units and, although the field is inviting and promising, much remains to be done before they will be upon a common plane.

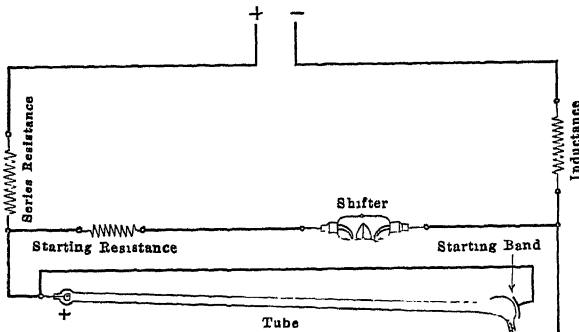

Fig. 31.—Diagram of circuits of mercury-vapor lamp.

Mercury Vapor Lamp.—Upon the other hand, mercury vapor in a tube when used as a conductor gives a very satisfactory efficiency as a light producer. The principal objection to the lamp is the color of the light, which is so predominantly green and violet that its application is limited.

The lamp is made in self-starting forms both for direct currents and for alternating currents. The tubes are of various lengths up to about seven feet. The long tubes are U-shaped, while the shorter ones are straight. This makes the lamp unit rather bulky but this is not a serious matter for high mounting in foundries, dock yards, drafting rooms and printing houses. The circuits are simple as will be seen by Fig. 31, which gives an elementary diagram for a Cooper-Hewitt automatic lamp.

CHAPTER VIII

ILLUMINATION

Classification of Systems of Illumination.—The Research Committee of the Illuminating Engineering Society has given considerable study to the matter of a proper classification of systems of illumination. In their report of 1914,¹ they present certain fundamental discussions and reach conclusions which we may best quote directly.

“*The scientific analysis of a lighting system* is completely given by a record of the intrinsic brilliancies of all objects visible from the position chosen for test, and by the components of illumination at all points. For an absolutely complete description of the lighting conditions the number of measurements would be very large. In any given case by attention to the more significant points and the exercise of judgment the number may be greatly reduced. Also, while every factor is actually given by these data, a more concrete idea may often be obtained from more obvious characteristics, such as the general direction of the light, the area of the principal light source, whether it is visible or invisible to the observer, and in other cases by the commercial specifications.

“Treating these factors in greater detail:

“*Intrinsic brilliancy*, or candle-power per unit of area. A complete plot of the intrinsic brilliancies of all visible areas constitutes a picture of the image thrown upon the retina. In many cases this gives all the necessary information. These measurements should be plotted upon a dimensioned drawing or, even better, upon a photographic print. All points cannot, of course, be so given, but special attention should be paid to the extremes; to the bright light sources and to their backgrounds; to the adjacent spaces of greatly different brightness. The method of making contour maps by the surveyor might be taken as a guide to what is called for here.

“**Components of Illumination.**—The number of components of illumination at a point is infinite, and the number of points and planes upon which measurements can be made is infinite. In any given case the points or planes of chief interest must be selected and the illumination components determined in the smallest number of directions which will give an adequate idea of conditions. Thus in much illuminating engineering work the horizontal plane 30 inches (0.76 m.) above the

¹ *Trans. I.E.S.*, vol. 9 (1914), p. 333.

floor is chosen for measurement as being desk and table height; but other planes often figure, as in library lighting, where the plane of the bookcase is of chief interest. The number of components to be measured is determined by the kind of test or work. If the test involves only flat surfaces, such as print, the measurement of intrinsic brilliancy or of normal illumination is sufficient. If relief surfaces, such as type, then the direction of light becomes significant. In any case the greatest number of components likely to be of interest at the point of work is nine (9), namely vertical, four at 45 deg., four horizontal.

"As to the other factors actually covered by these measurements, but capable of supplying significant information immediately some are in greater detail as follows:

"Visibility of Light Sources.—The illumination of the floor and lower part of the room by daylight is frequently from a part of the sky not visible to the occupants of the room. The illumination of a working plane may be entirely unaffected by the interposition of a shade between the light source and the observer, but the visibility or invisibility of the illuminant is of interest to the worker. Consequently the concealment or visibility of the light source is a significant factor and is easily recorded. By 'light source' must be understood, in illumination science, not alone the original illuminant, such as the flame or filament, but the surface from which the light comes, either by emission, diffuse reflection or diffuse transmission, which illuminates the point of study. Thus the bright ceiling used with an 'indirect' unit is the light source to be considered in discussing visibility or concealment, not the lamp in the fixture.

"The terms 'primary light source' and 'secondary light source' may be used if desired to distinguish between the original illuminant, and the reflecting and transmitting accessories which as well illuminate the point of study.

"Area of Light Source.—The character of the shadows and the relative value of different components of illumination is conditioned largely by the angle subtended by the principal light source. The mere statement that the light sources are practically points (as in the case of bare incandescent lamps) or areas of several square meters (when a bright ceiling is used) is of value.

"Direction of Light.—Usually the light falling on the working plane comes largely from a definite direction from above or from one side. Since certain kinds of detail are revealed by one direction of light over another, this is a factor of importance. Esthetic values are affected to a marked degree by the direction of shadows, and as a consequence the general impression produced on an observer is dependent on the direction of light.

"Dimensions and Commercial Specifications.—No details of dimensions or position which are necessary for the complete picturing of con-

ditions should be omitted. The use of commercial specifications of illuminants, auxiliary apparatus and illuminated surfaces frequently saves much time, but it must not be forgotten that such specifications are apt to be of significance only locally and for a limited time. The legitimate use of photographs with dimensions to show details of shape and position, and of photographs on which measurements of surface brightness are marked to show brightness distribution is to be encouraged."

Direct Units vs. Indirect Units.—Following this presentation of the essentials of any system, the conclusion is announced that the use of the terms "*direct*" and "*indirect*" preferably should be in description of *lighting fixtures*, rather than in connection with *systems of illumination*. The point is made that these terms are not significant in respect to the factors of the above analysis, while two different lighting installations exactly alike in the details of directional values, intensity, etc., may be, the one direct illumination, and the other, indirect illumination.¹ Finally, descriptive definitions were offered loosely covering these types of units as they are in place for use.

"Direct Unit.—A lighting device from which over half the emitted light flux is directed downward, or to the side, reaching the surface to be illuminated without being reflected by the walls or ceiling.

"Semi-indirect.—A lighting device employing a diffusing or translucent medium to direct most of the light to the walls or ceiling to be redirected for use, a part of the light being diffused through this medium.

"Indirect Unit.—A lighting device from which all the light emitted is projected to the ceilings or walls and then reflected to the object to be lighted."

The direct unit utilizes lamps with reflectors, shades, globes, etc., operating to throw the light directly upon the walls and objects of the room, where, by immediate reflection as well as diffused light and secondary reflection, all objects become visible. The indirect unit throws the light, by means of reflectors, upon the ceiling, from which it is scattered to the walls, floor, furnishings, etc. The practical difference lies, of course, in the diffusion

¹ The objection of the committee to the use of the terms "direct" and "indirect" as applied to the lighting system is well taken. The terms in no wise characterize the system or the effect produced. It is doubtful, however, if it has been wholly happy in its suggestion that the fixture should be saddled with the descriptive term. True, the "system" is not "indirect," but neither is the "fixture." The indirection lies with the transmission of light flux from the lamp to the working plane.

attained, although it has been shown above that this is not a fundamental difference.

In contrasting the two schemes, each has advantages. The indirect apparatus cannot be effective in rooms with dark walls and ceiling. The intensive spot lighting required for some classes of work must have the direct light which can be obtained more economically thus than by other means. In fact, it is clear that any degree of illumination can be secured most economically by directed flux. Upon the other hand, a fair amount of diffusion of light is absolutely necessary to visual comfort. Any degree of diffusion can be secured by the indirect methods, even to the elimination of all shadows. Visual comfort and acuity in ordinary situations are both served by a good general illumination with its accompanying diffusion and by the presence of some contrast and the presence of medium shadows.

The things most to be avoided in illumination are:

- (a) The presence of highly brilliant sources in the field of vision.
- (b) Improper direction for flux, causing shadows, glares, etc.
- (c) Improper proportioning of the components of general and of concentrated light.
- (d) Improper proportioning of direct and of diffused light.
- (e) Faulty color content.

Of these troubles, the greater number may be overcome by the use of the indirect units.

CHAPTER IX

THE EYE

General.—Without an appreciation of the physiological nature of the eye, its functions and its processes in performing these functions, any study of lighting is incomplete and lacks much in effectiveness. All artificial illumination is produced for the purpose of its ultimate effect upon the eye, provided we neglect the applications such as in connection with photography, therapeutics, etc. Important as these latter are, they sink into insignificance, in comparison with vision, the province of the eye. It is necessary, therefore, that the eye must be considered both censor and monitor over all illumination, and that full weight be given to its limitations, its distinctive qualifications and even to its whims and foibles.

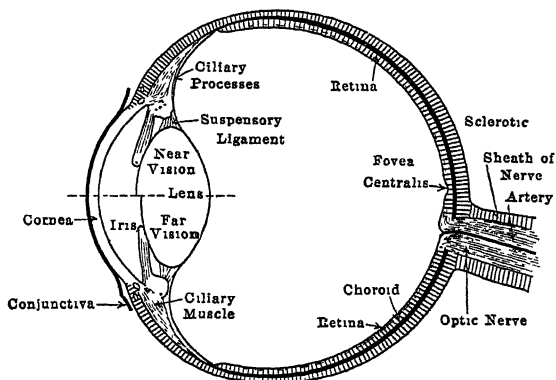

FIG. 32.—The human eye.

The Physiology of the Eye.—Formed like a camera obscura, Fig. 32, it admits light to its active member, the retina, whose office is to receive this radiation and convert it into a form of energy such that it may excite the nerve centers. The retina, thus, forms the inner of three shells being next to the nutritive choroid, which is surrounded by the protective sclerotic coating. The retina contains, in turn, three zones. The inner layer consists of the rods and cones which receive the stimuli; the second layer is of cells which conduct these stimuli to the

large ganglia forming the third layer. From here, the nerve fibers lead to the optic nerve.

Of the ten structural layers of the retina, the inner ones carry the rods and cones. The rods, however, approach the inner surface more closely than do the cones.

The rod is a minute cylinder connected to an oval body. The cylinder points directly toward the inner surface of the retina. The oval member is connected to the cells of the second nerve zone. The cylindrical part of the rod carries a pigment known as "visual purple." The cone similarly consists of two parts, the first being conical in form, while the next is oval as in the other case. This also communicates with the next zone of cells by direct connection. There are many more rods than cones throughout the whole of the retina except at the very center of the "yellow spot." At this point, the fovea centralis, cones alone are present. The yellow spot shows a thinning of all layers except the rods and cones, leaving these in a more active condition.

Functioning of the Rods and Cones.—It is supposed that the rods function by recognizing brightness but not color. This, of course, includes form which is perceived only by relative brightness of the different portions of the object viewed. The rods are, therefore, the active members when we have the sensation of looking at an object although we are really seeing a flat black and white picture of the object. The active principle is the visual purple, which bleaches when light falls upon it. This chemical change is supposed to generate impulses which are transmitted to the cells.

The cones probably contain a fluid or fluids which will act in color recognition somewhat similarly to the visual purple in the case of brightness. It has been suggested that there are three of these fluids corresponding, respectively, to the red, green and blue sensations. They may occupy different cones or they may be mingled in the same cones. Each liquid experiences a change when it is the recipient of its particular color of light and the degree of the light. These stimuli are then transmitted to the nerve centers where they are combined into a composite sensation.

Both rods and cones have other activities than these but the ones outlined seem to be fundamental in the phenomenon of vision. With the exclusion of light from the eye, the parts again assume full normal condition, having been reduced to a subnormal

state by their inability to recuperate as rapidly as their continuous use would demand. A sudden brilliant flash will leave the eye blinded for a time because of the complete inability of the proper parts to furnish at once the suddenly depleted supply of fluids. Continued exposure of the eye to an over-brilliant illumination will have the same effect. In case of a very severe flash, as for example a nearby electric flash, the blindness may persist for several days.

From the fact that the rods approach the inner surface of the retina more closely than do the cones, it may be inferred that "form vision" begins with lower intensities of illumination than does "color vision." This is an experimentally proven fact.

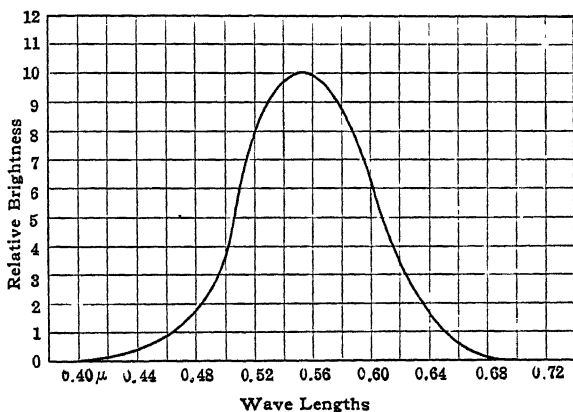

FIG. 33.—Spectral luminosity curve for the average eye, for a source of uniform energy-intensity.

In the early morning or late in the evening color is indistinguishable even while form is still fairly distinct. Nor do the different colors disappear together as the light fails. Inasmuch, however, as the "yellow spot" seems to be weak in the perception of violet, a light of this color receding from the observer will disappear much more quickly if the eyes are focused upon it than if they are directed toward an object a few degrees away from the light. When so displaced, the light falls upon a portion of the retina more sensitive to it than the region immediately surrounding the fovea. This gives the peculiar experience of not being able to see a light when one tries to do so although it is easily distinguishable if one looks away from it. The writer has several times made this observation in watching violet colored signal lights as observed from the rear of a train. This phenomenon is

also noticeable in looking for the faint stars in a black sky. It may mean that the fovea, with its lack of rods, distinguishes only color.

Sensitivity of the Eye.—When a uniform amount of energy falls upon the eye, the color changing over the whole spectrum, the brightness of the light changes. That is, the eye is not equally sensitive to different colors of light. Ives has given a spectral luminosity-curve for the average eye (Fig. 33) showing the relative brightness of the light thus varied.

As for the least illumination which is discernible or its "threshold" value, König has given the following values:

TABLE 10.—THRESHOLD ILLUMINATION

Wave length, $\mu\mu$	670 0	605 0	575 0	505 0	470.0	430.0
Threshold value (approx. met-cand).....	0 060	0 0056	0.0029	0 00017	0.00012	0 00012
Color.....	Red	Orange	Yellow	Green	Blue	Violet

The crystalline lens which focuses the light upon the retina is not achromatic and, therefore, monochromatic vision is clearer than mixed-color vision. This is also easily proven experimentally.

Natural Protection of the Eye.—The iris serves the purpose of determining the amount of light which may enter the eye. It accomplishes this end by advancing toward or receding from the center of the pupillary opening. Its limitations are fairly definite, however, and it is not capable of protecting the eye from over exposure in all cases. Its action is involuntary, but when the field of vision is made up of contrasting elements it may try to regulate for the lesser illumination, to the injury of the eye by the stronger light.

Ultra-violet light and infra-red light are both injurious to the eye because they have no effect upon the iris and it fails to shut out the high energy content of these rays. The ultra-violet light is the more injurious and many sources of artificial light are quite capable of doing much injury because of the presence in their flux of a considerable amount of these rays. The eye is incapable of recognizing them and it must be protected by external means.

The properties of the eye as a physical instrument are summarized by Nutting¹ as follows:

"a. Sensibility to Radiation of Various Wave Lengths.

(1) The eye responds to radiation between ill-defined limits at

¹ *Bulletin*, Bureau of Standards, vol. 5 (1908), p. 265.

about $300\mu\mu$ and $1000\mu\mu$. Its sensibility is highest between $500\mu\mu$ and $600\mu\mu$. Good vision requires radiation between $410\mu\mu$ and $760\mu\mu$. Radiation is easily visible to most eyes out as far as $330\mu\mu$ in the violet and $770\mu\mu$ in the red.

(2) The spectral sensibility curve has a single maximum in the green, slopes off very steeply at first and then very gradually toward the extreme wave lengths.

(3) At low intensities the maximum of the curve lies between $500\mu\mu$ and $520\mu\mu$ for perhaps 90 per cent. of all persons. It is approximately symmetrical and nearly or quite independent of color blindness, partial or complete. It is coincident with the reciprocal of the threshold value of the radiation if reduced to the same maximum ordinate.

(4) At moderate and high intensities the maximum of the visibility curve broadens and shifts slightly toward the yellow, varying considerably with color blindness in the subject.

“*b.* Sensibility to Radiation of Varying Intensity.

Sensibility falls off steadily with increasing intensity. It is approximately inversely proportional to the intensity over a wide range. The ratio of optical intensity to intensity of radiation increases more rapidly for red than for blue and green. (Purkinje phenomenon.)

“*c.* Sensibility to Small Differences in Intensity.—The least perceptible increment, measured as a fraction of the whole, is approximately:

(1) Independent of intensity (Fechner's Law). It is about 0.016 for moderate and high intensities and greater for very low and extremely high intensities.

(2) Independent of wave length (König's Law), at a constant luminosity—extremes again excepted.

(3) Independent of the individual.

“*d.* Sensibility to Slight Differences in Wave Length has two pronounced maxima, one in the yellow and one in the green, and two slight maxima in the extreme blue and red. These maxima vary considerably with the individual and probably also with the intensity of the radiation used.

“*e.* Visual acuity or resolving power, so far as studied, appears to follow the same laws as does sensibility to small intensity differences, (*c*) namely, it is approximately proportional to the luminosity and independent of color and of the individual.

“*f.* The Growth and Decay of the visual responses *with time*, so far as studied, appear to follow the ordinary exponential law. The parameters of the time functions vary with wave length and intensity. A steady impression is the resultant of a pure reception and a fatigue.”

CHAPTER X

LIGHT

Definition.—Webster's dictionary says that light is "the essential condition of vision; the opposite of darkness . . . That form of energy which by its action upon the organs of vision, enables them to perform their function of sight. By extension, radiation or radiant energy incapable of affecting the retina, but resembling true light in other respects . . . According to the undulatory or wave theory at present accepted, light is transmitted from luminous bodies to the eye and other objects by the undulatory or vibrational movement of the ether. The velocity of this transmission is about 186,300 miles (3×10^{10} cm.) a second, and the vibrations of the ether are transverse to the direction of propagation of the wave motion. The waves vary in length from 3.9 to 7.6 ten-thousandths of a millimeter, approximately. The color impression produced varies with the wave length, and the brightness is proportional to the square of the amplitude of vibration. Waves of a similar character whose lengths fall above or below the limits mentioned are not perceptible to the eye. Those between 3.9 and about 1.0 ten-thousandths of a millimeter constitute ultra-violet light and are manifested by their photographic or other chemical action. Those exceeding 7.6 ten-thousandths in length are the infra-red waves and are detected by their thermal effects. The electromagnetic theory of light, originating with Maxwell, holds that these waves, including those of light proper, are the same in kind as those by which electromagnetic oscillations are propagated through the ether, and that light is an electromagnetic phenomenon. The most important phenomena of light are: reflection, refraction, dispersion, interference and polarization."

It is not necessary for our present purpose that we should go beyond this statement. In point of fact, the last few years have brought about dissatisfaction with this theory which, in all probability, will affect its ultimate statement rather than its entity. This comes as a quantum theory of electrical energy and a great variety of phenomena experimentally studied which

have failed to correlate with the earlier notions have fitted well into the new ensemble.

Law of Inverse Squares.—If light is emitted radially from a point source, the intensity of light varies as the square of the distance from the source. This follows from the fact that the amount of surface to be illuminated, as upon the inner side of a hollow sphere, varies as the spherical surface, which varies as the square of the radius. While no commercial light producer is a point source and some types vary therefrom quite widely, this fundamental law is of very material assistance to us in understanding the phenomena of direct radiation, if we are considering a place sufficiently distant from the light source so that the latter may be considered as a point. It is seen at once that no account is here taken of the reflection of light by walls, or objects in a room.

Radiation.—Solar radiation is characterized by the range of wave lengths from 1.0×10^{-2} cm. down to 1.0×10^{-5} cm., which correspond to frequencies of 3×10^{12} cycles per second and to 3×10^{15} cycles per second, respectively. Upon an "octave" scale using 128 cycles per sec. as the zero point, this constitutes about ten octaves, of which less than one octave is actually visible. Below these frequencies there is a range of about six octaves which has not been explored. Above the higher limit set for these frequencies, there is another more or less undetermined range occupied in part by x -rays and reflected x -rays, and extending up to about 1.5×10^{20} cycles per sec. or wave lengths of 2×10^{-10} cm. For the sake of comparison it might be pointed out that the waves of the region below 5×10^{10} cycles per sec. are distinctly recognizable, descending from the upper Hertzian waves down through lightning, radio-telegraphy, oscillations, "static," to commercial frequencies. The blank regions indicate lack of proper detectors rather than absence of those frequencies.

Of the whole sixty octaves of frequencies, as before stated, we are specifically interested at this time in the forty-second octave, approximately, which narrow range is accountable for vision. Incidentally, to a limited extent, the adjacent regions are important to us in that they affect the operation and efficiencies of the light producers and have physiological effects upon the organs of sight. These waves travel in straight lines, may be reflected, refracted, or dispersed—absorbed or transmitted. We will consider a few of their laws and phenomena.

Temperature Radiation.—When energy is supplied to a body by a continuous application of heat, electric current supply, friction, or otherwise that energy is partially absorbed by the body and may be stored chemically, or as heat, etc. If the storage occurs thermally, the temperature of the body is raised. But with a rise in temperature, the body will give off by conduction, convection and radiation, a portion of its heat energy to increase the temperature of the surrounding air. Suppose the energy to be supplied at a constant rate, then as temperature increases there will come a time when this energy is just sufficient to maintain a constant temperature of the body. This indicates that as the temperature rises, the ratio of energy given off, or radiated to the amount received increases.

The law of temperature radiation from bodies is not at all well understood, but there are certain very patent conditions existing. For instance, radiation is a surface phenomenon, *i.e.*, it occurs at the surfaces bounding or separating two bodies and is conditioned by the natures of those surfaces.

According to the Stephan-Boltzman law:

$$W_r = Ke (T_o^4 - T_1^4),$$

where W_r = the amount of energy radiated,

K = a reduction constant,

e = the emissivity constant,

T_o = the temperature of the hot body,

T_1 = the temperature of the cool body.

This formula states that radiation depends upon (1) an emissivity constant determined by the materials and the surface conditions; (2) the difference between the fourth powers of the temperatures of the respective bodies. The emissivity constant varies within a relative range of 50 to 1.

The fact that the exponents of the temperatures are so large indicates that the temperature-radiation curve becomes quite steep and very considerable increases in power supply are required to increase the temperature very greatly.

Radiation from a hot body occurs over a very considerable range in frequencies, a "white hot" body giving much the same range as sun radiation although the corresponding parts differ in intensity. At low temperatures, the radiation is wholly non-luminous. As temperature increases, a faint red light appears, growing stronger and partaking more and more of the orange

and yellow. Eventually, the color becomes white, indicating a mixture of the whole spectrum. With still greater rise, the light evidences a bluish or violet cast. All this shows that with a rise in temperature, the radiating body continues to give off energy over a long range of frequencies but with the frequencies increasing, and with the maximum point shifting toward higher frequencies (see Fig. 34).

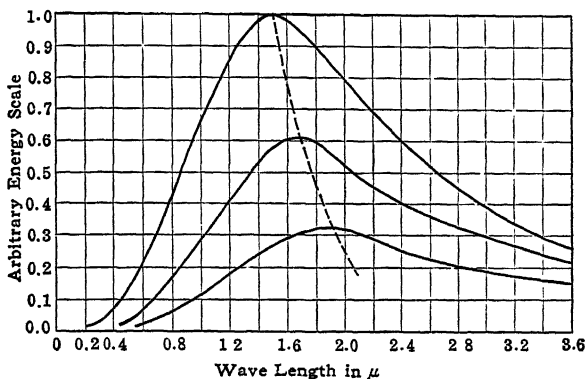

FIG. 34.—Radiation from carbon filament at different temperatures, showing shift of maximum point.

Black, White and Colored Bodies.—When a body absorbs all energy impinging upon it, reflecting none, its temperature will be increased until the stable point is reached. Then, the energy radiated will balance the energy absorbed. It is evident that the radiation from the black body exceeds that of any other body, because it absorbs more. Hence, if we limit ourselves to a consideration of radiation due to temperature only, a black body will radiate more energy at any given point of the spectrum than any other kind of body will.

For a given temperature, the energy radiated plotted against wave length may be given for a black body as curve 1 in Fig. 35. A body which at the same temperature radiates a fixed percentage of this is called a gray body. A white body radiates zero energy at any temperature, a statement which proves from its nature that we are considering the unattainable “perfectly white body.” Nearly all bodies, however, are more or less strongly “colored” or “selective” in their radiation. It will be seen that if a body varies from the black body in its radiation characteristic, it may be possible for it to differ in such

a way that the visible range of the spectrum suffers less decrease than does the invisible part. In this case, the efficiency of the body as a luminant is greater than that of the black body. Or, the variation may be such that its efficiency is lower than that of the black body, if the visible range decreases more than does the infra-red.

Examples of various radiation characteristics are shown in Fig. 35, where curve No. 1 is for the theoretical black body; curve No. 2 is for a gray body; curve No. 3 is for a selective radiant with increased luminous efficiency; curve No. 4 is for a selective radiant with decreased efficiency.

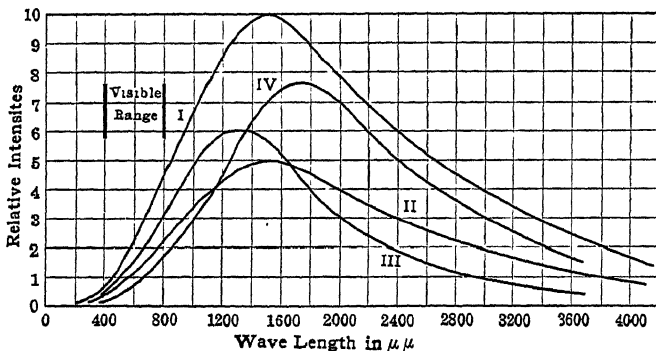

FIG. 35.—Types of energy radiation.

As examples of radiators showing these particular kinds of characteristics we might refer to numerous members of some of the groups but very few in others. The black body is theoretical but it may be approximated by the inner surface of a hollow sphere with a small opening left through which observations may be made. Platinum, tungsten, etc., give gray body radiation; ceria, thoria, etc., give selective radiation with higher efficiency than the black body; transparent substances as glass and quartz radiate selectively with very low luminous efficiency.

It should be noted that nearly all reflection is more or less selective. By this, it is meant that white light falling upon and reflected by a colored object will show in the reflected beam a preponderance of the color of the reflector. This is, of course, why colored objects appear colored under white light. However, some objects reflect all colors diffusely and give the color sensation we recognize as "white" while others reflect very little of

any color and we call them "black." In all practical installations for illuminating purposes the reflection is mixed, partaking of both regular and irregular reflection characteristics. The selective nature of radiation, therefore, becomes important. Ideal regular reflection would give no change in color, but the light returned would be of exactly the same color as that received. Ordinary irregular reflection from the walls of a room will give to the light a considerable tint of the wall paper. Multiple reflection gives a very much increased effect because of the rapid reduction of the returned energy in color ranges other than that of the paper.

Table 11¹ indicates a difference in coefficient of reflection for the same paper but with a changed source of light. This is because of the color relations of the light received and the reflector. It will be noticed, for instance, that the green and the blue wall-papers reflect considerably more of the skylight than they do of the incandescent lamp light; while the cream colors reflect much more of the artificial light than of the sunlight.

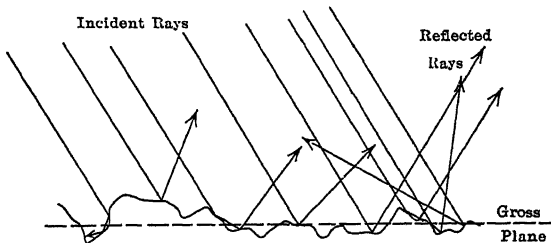

FIG. 36.—Diffusion of light by reflection.

Specular or Diffuse Reflection.—Reflection may be either specular or diffuse.² In the former, the ray of light is reflected and continues to advance in the new direction without being broken up. The chief characteristic of this type of reflection is that the reflecting surface "mirrors" the object from which the light has been received. The angle of incidence equals the angle of reflection. Diffuse reflection, upon the other hand, is irregular or broken reflection, characterized by an advance of the reflected rays in promiscuous directions after reflection. The law of incidence and reflection still holds but the plane of reflection is not the gross plane of the body but is the plane tangent to the minute surface at the point of incidence of the beam (see Fig. 36).

¹ *Trans. I.E.S.*, vol. 2 (1907), p. 653, BELL.

² See Fig. 60, Types of Reflection.

TABLE 11.—COEFFICIENTS OF DIFFUSE REFLECTION

Kind	Color	Coefficient skylight	Coefficient inc. lamp
Plain ceiling.....	Faint greenish	0 50	0 53
	Light ecru....	0 27	0 26
	Very faint gray-cream	0.53	0 64
	Light gray-green	0 26	0.23
	Light yellow.....	0 53	0.49
	Faint ecru.....	0 47	0 55
	Faint pinkish.....	0.41	0.43
	Pale bluish-white	0 42	0 31
Crepe.....	Medium green.....	0.25	0 19
	Deep yellowish-green	0 13	0 07
	Dark coffee-brown	0 08	0 06
	Deep green.....	0 05	0 06
	Deep yellow-buff...	0.41	0 41
	Full green	0.06	0.06
	Deep red.....	0.05	0 05
	Medium red	0.06	0 08
Cartridge	White.....	0.80	
	Medium green	0.15	0 11
	Dull green.....	0 11	0 07
	Dull yellowish-green	0.09	0.07
	Light pinkish-brown	0 21	0.26
	Light green.....	0.23	0 18
	Light blue.....	0.21	0 20
	Pale gray.....	0 35	0.27
	Faint yellowish-gray	0.43	0 33
	Salmon buff.....	0.31	0 33
	Medium light buff.....	0.44	0 44
	Medium full green.. . . .	0.11	0 07
	Medium dull red (gray-red)	0.06	0 07
	Light red.....	0.10	0 10
	Very deep ecru.....	0.18	0 15
	Pale pink.....	0 25	0 19
Deep yellow-gray....	0.18	0 13	
Silky finish.....	Medium crimson (cross grain)	0.08	0 12
	Medium gray-green.....	0 17	0 12
Stripes... ..	Deep cream.	0 56	0 60
	Deep cream silvery.	0 56	0 57
	Yellow medium	0.50	0 53
	Deep buff.....	0.53	0 58
	Medium red.....	0 06	0 08
	Medium red satin.....	0.07	0 11
	Light strawberry pink.....	0.43	0 43
	Light strawberry silvery.....	0.51	0 49
	Light and dark green (heavily streaked with deep green).....	0.06	0 07
	Silvery light green (heavily streaked with deep green).....	0 13	0 14
	Light green (plain).....	0 36	0 26
	Silvery light green (corded).....	0.36	0 23

TABLE 11.—COEFFICIENTS OF DIFFUSE REFLECTION (*Continued*)

Kind	Color	Coefficient skylight	Coefficient inc. lamp
Miscellaneous.	Dark green and gold (minute figuring much gold).....	0 24	0.19
	Light green and gold (minute figuring much gold).....	0 31	0.28
	Deep and light red.....	0 12	0 20
Pique.....	Light bluish.....	0 46	0 47
	Light gray.....	0 38	0 38

A regular polished surface is required for specular reflection while an irregular surface diffuses the light.

Coefficients of Reflection.—In all reflections, the total amount of light received is not returned but a certain portion is absorbed by the surface and transmitted by it. The percentage of the light received which is reflected is called the coefficient of reflection of the surface. Specular reflection need not be higher than the diffuse maximum. Dr. Bell¹ gives very elaborate lists of coefficients of reflection. Table 12 gives data for specular reflection while Table 11 gives data upon walls of rooms variously prepared, illuminated by daylight through a skylight or by incandescent lamps.

TABLE 12.—COEFFICIENTS OF SPECULAR REFLECTION

Material	Coefficient of reflection
Highly polished silver.....	0.93
Mirrors silvered on back.....	0.85
Polished gold.....	0.80
Highly polished brass.....	0.75
Highly polished copper.....	0.75
Polished platinum.....	0.63
Speculum metal.....	0.65
Polished steel.....	0.60
Burnished copper.....	0.50

Mixed Reflection.—As the angle of incidence increases from zero, as measured from the perpendicular, the percentage of reflection increases for a time, reaching a maximum value in the region depending upon the material, its surface condition, etc.

¹ "The Art of Illumination," 1912, and *Trans. I.E.S.*, 1907.

This maximum occurs early with diffusing reflectors and late with specular reflectors.

The reason for the presence of an early maximum, when one might naturally expect it to be much later, is that as the angle of incidence increases, multiple reflection rapidly takes the place of single reflection, especially with diffusing reflectors. A beam of light striking a prominent place upon the surface is reflected, meets another projection and even a third before it clears itself of the surface. This greatly reduces the brilliancy of the deflected ray.

Even with diffusing reflectors, maximum brilliancy will occur at an angle of incidence somewhat different from zero because upon a perfectly plane surface, reflection increases as the beam shifts farther and farther away from the perpendicular, as it can be deflected with less loss of energy. This effect is the opposite to that of multiple reflection and as the latter is not serious at first, the increase in brilliancy due to change of angle predominates for a time over the decrease in brilliancy due to greater multiplicity of reflection.

As the incident angle increases and multiplex reflection occurs, there will be a greater departure from a full reflection of the color of the incident ray, leaving the light more and more affected by the color of the reflector.

Absorption, Transmission.—That part of the radiation which is not reflected is either absorbed or transmitted. Absorption consists in a using up of the energy of the wave by the medium. A beam of light passing through air, glass, etc., is partially absorbed. That portion of the energy which continues to move forward or progress in its original form is said to be transmitted. In general, different portions of the spectrum are differently affected by the medium, which may absorb much of the red or much of some other color, leaving the ray of an altered color. For example, when common glass is of sufficient thickness, it is noticed that it absorbs part of the red and leaves the light of a greenish tint. When used for heavy mirrors this effect is very marked and a tinting process has been invented to give glass for this purpose a slight pink tinge. This leaves the reflected ray with normal coloring and the face and clothing show their true tints. A portion of the change in color due to mirrors is, of course, the result of selective reflection from the silver backing, and this is also corrected for in the new glass.

Perception of Color.—In the perception of color, the eye is not analytical as is the ear in the case of sound. The difference is physiological, in that different sounds reaching the ear at the same time affect different fibers of the auditory nerve. In the eye, however, light of a complex color falling upon a certain point of the retina affects only the nerve center connected to that spot. The resulting sensation is synthetic rather than analytic.

Color perception by the eye implies the presence of a ray of light "containing" the color involved. The eye may be deceived, however, in this sense—a mixture of two simple colors may give the impression of a third color. The simplest illustration of this is mixing yellow and blue to produce green. However, unless the elementary green light is present in the illumination, the spectroscope will show no green. White light, as is well known, is a combination of violet, indigo, blue, green, yellow, orange, and red in rather poorly defined proportions. There is no established standard for it, "sunlight" being the most commonly used synonym. But here again we have a widely variant standard, affected by atmospheric absorption, sky reflection, clouds, etc. The morning sunlight is much redder and less "actinic" than is noonlight. Light from the open sky alters the mixture variously as the nature of the clouds changes.

A green object viewed under a good green light will appear vividly illuminated. A red object viewed under the same light will appear to be black. A white object will take the color of the light. This makes the matter of color of light a very important matter in any place where colors of objects are to be effectively distinguished. Dr. Bell gives the data of Table 13 showing how different colors appear under a variety of illuminations.

Colors of Light Sources.—Gleaned from various sources, Table 14 gives a fairly accurate idea of the colors represented by different sources of light. This list is descriptive rather than the result of measurements, in the different parts of the spectra. It is rather difficult to be explicit in such comparisons for the reason that two lights, each called blue-white may differ widely in their blue contents. It is very instructive to make a study of the spectra of different illuminants and if facilities are present, the student should examine several, such as the carbon arc, flaming arc, magnetite arc, mercury arc, carbon incandescent and tungsten incandescent, comparing them with each other

TABLE 13.—COLOR APPEARANCE UNDER VARIOUS ILLUMINATIONS

Original color of fabric	Red light	Orange light	Yellow light	Green light	Blue light	Violet light
Black.. . . .	Purplish black	Deep maroon	Yellow olive	Greenish brown	Blue-black	Faint violet-black
White.....	Red	Orange	Light yellow	Green	Blue	Violet
Red.... . .	Intense red	Scarlet	Orange	Brown	Violet	Red-violet purple
Orange.. . .	Orange-red	Intense orange	Yellow-orange	Faint yellow slightly greenish	Brown slightly violet	Light red
Yellow.....	Orange	Yellow-orange	Orange	Yellowish green	Green	Brown tinged with faint red
Light green.	Reddish gray	Yellow-green	Greenish yellow	Intenser green	Blue-green	Light purple
Deep green..	Reddish black	Rusty green	Yellowish green	Intenser green	Greenish blue	Bluish gray
Light blue...	Violet	Orange-gray	Yellowish green	Green-blue	Vivid blue	Violet-blue
Deep blue....	Violet-purple	Gray slightly orange	Green-slate	Blue-green	Intenser blue	Bright blue-violet
Indigo blue...	Purple slightly violet	Orange-maroon	Orange-yellow (very dull)	Dull green	Dark blue indigo	Deep blue-violet
Violet.....	Purple	Red-maroon	Yellow-maroon	Bluish green-brown	Deep bluish violet	Deep violet

TABLE 14.—COLORS OF ILLUMINANTS

Illuminant	Color of light
Sun, at zenith.	White
Sun, near horizon.	Orange-white
Sky, clear.	Blue-white
Arc, open carbon.	Blue-white
Arc, enclosed carbon.	Violet-white
Arc, magnetite.	White
Arc, flaming.	{ Golden yellow Orange-red Orange-white
Arc, mercury.	Blue-green
Arc, mercury-quartz tube.	Green-white
Moore tube (CO ₂).	White
Nernst glower.	Yellow-white
Incandescents—Carbon	Orange-white
—Tungsten-vacuum.	Pale orange-white
—gas-filled.	Pale orange-white

and with daylight. For this purpose a small double prism hand type of spectroscope is very convenient, showing two spectra at the same time, side by side. It will then be noted that there are very marked differences in the distribution of light throughout even the continuous bands, while the variations of intensity and the dark lines in others are remarkable.

Luminescence.—Light falling upon an object may give rise to color changes due to a phenomenon quite distinct from that of selective reflection. This other phenomenon is that type of luminescence known as fluorescence. Luminescence is an emission of light not ascribable to incandescence, and, therefore, occurring at low temperatures. When this occurrence is a result of an exposure to light, it is known as photoluminescence and may be fluorescence or phosphorescence, depending upon whether the effect occurs during excitation or after excitation. Some substances fluoresce with a color different from that of the incident light. The explanation seems to be that there is some particular region of frequency at which the substance will give off light. The energy of the light wave received is actually absorbed by the body, and evidences itself by setting the molecules into motion such that light is given off at the characteristic frequency and color.

This can be illustrated by taking monochromatic light and illuminating an object made of a material which has this property of changing the frequency of the energy vibration. Although not monochromatic, the mercury arc is a good illustration. There is no red in the spectrum of the low temperature mercury arc. The spectrum consists of seven prominent bright lines, two lying very close together in the yellow, one in the greenish yellow, one green, one indigo and two violet. However, when a solution of rhodamin is illuminated by the mercury vapor lamp, a cherry red colored light is given off by the liquid which itself becomes a luminous body. It looks, in fact, much like a transparent red hot iron. Similarly, the ultra-violet rays of a spectrum may be made to play upon a screen which, under its excitation, fluoresces within the visible range.

So far as has been recorded, all of these "frequency changers" step down the rate of oscillation, and none is known which will reverse the step, although these experimental data may be only a result observation with comparatively feeble excitation.

Refraction.—Refraction of light is effected whenever the ray leaves a body of one density and enters that of another density at an angle other than 90 deg. From the standpoint of our present subject, this is of value to us principally because of color analysis and of design of shades and reflectors. The former case has already been considered and will reappear in the discussion of photometry. The latter case will be taken up under the head of shades.

Light and Vision.—Vision results when a ray of light coming from an object enters the normal eye, is focused upon the retina and excites the optic nerve. This, of course, is the primary object of all illumination. The effect is not, however, proportional to the excitation. Fechner's law, which obtains over wide limits, although variously stated, asserts in brief, that the effect produced is proportional to the logarithm of the intensity of the light. No matter what the initial brilliancy is (except for the extreme values), an increase of 100 per cent. in the light strength will increase the sensation by $\log 2 - \log 1$, or 0.301, or 30.1 per cent. Inasmuch as the eye is subjected to very large changes in intensities of light, Fechner's law helps to explain why it is not entirely blinded but discerns objects with accuracy within the daily range from artificial light to sunlight, differing by a factor of 100,000, or thereabouts. Even poor lighting or part moonlight will give one a sensation of fairly clear outline vision, and here the illumination is much less than with ordinary conditions. Pupillary contraction will cover a range of diameter-ratio of about one to ten. Upon the other hand, it is found that the eye is sensitive enough to recognize a change of about 1 per cent. of illumination intensity.

Fatigue.—The eye cannot long sustain itself in normal condition when it is exposed to the more trying demands. It is said to become "fatigued." This occurrence takes place even with continued use of the eyes in a less trying situation. In any case, it leaves the familiar after-image which gradually disappears when the eye is relieved from the strain. The after-image is usually of reverse or complementary color, evidencing the fact that there is color fatigue.

Purkinje Effect.—It has been found that the eye does not receive constant relative stimuli from lights of different colors if the intensities are varied. According to the Purkinje effect, the eye observing two objects equally illuminated, respectively,

by the longer and the shorter wave lengths, will, for low illuminations, distinguish detail better by the shorter waves but, as the intensity of the illumination increases, the longer waves become more effective. A simple illustration of this is to place side by side two cards, one red and one blue. Gradually reduce their illumination and the red card will disappear before the blue one will. Raise the value of the illumination and the red will appear to be the brighter.

Monochromatic Vision.—It has been shown by several investigators that visual acuity is promoted by the use of monochromatic light. The explanation for this seems to lie in the fact that the eye is not achromatic and the red content of white light

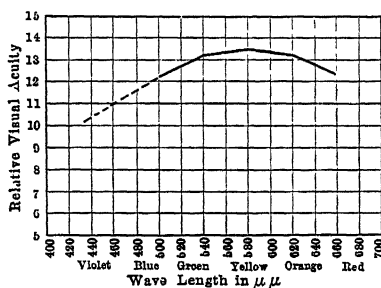

FIG. 37.—Relative visual acuity for different wave lengths.

is focused just behind the retina, and the blue is focused just in front of the retina when the yellow falls upon it. When monochromatic light is used the eye will focus for it, but when white light is used, the eye chooses the yellow-green range for acuity.

This is an efficient selection, for with equal energy content, the middle range of the visible spectrum produces much better visibility than does either extreme. The curve given in Fig. 37 is plotted from data by Luckiesh and shows clearly that the most effective color is yellow.¹ This central region is most suitable, therefore, for use in monochromatic illumination and its content in general illumination should be high.

Taking the wave lengths 430, 470, 505, 535, 590, 605 and 670 and plotting for each of these colors a curve showing visibility against intensity of illumination, we get the family of curves in

¹ Compare with Fig 33 showing the spectral luminosity curve of the average eye.

Fig. 38.¹ It will be seen here that the relative visibility of different colors changes very rapidly in certain regions, as illumination intensity changes.

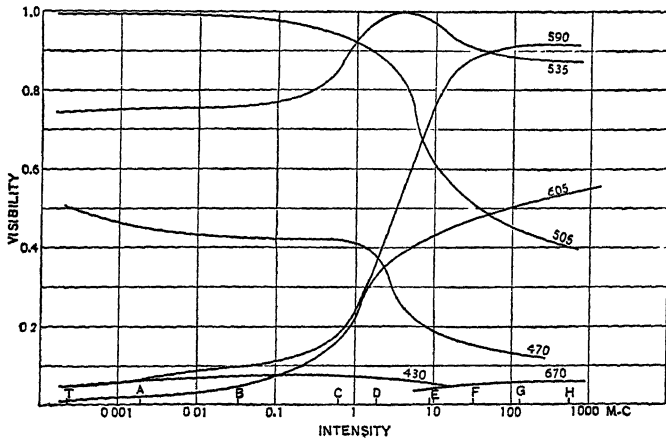

FIG. 38.—Relative visibility curves of various colors of light, as a function of intensity of illumination.

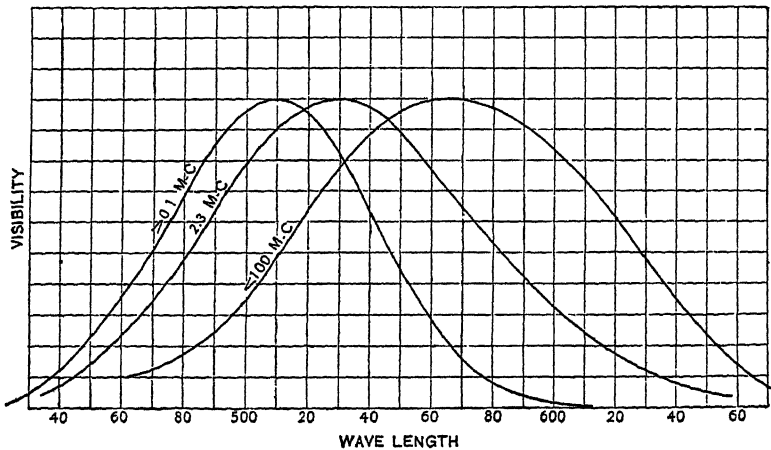

FIG. 39.—Relative visibility curves for various intensities of light, as a function of wave lengths.

Again, plotting visibility against wave length we obtain the curves of Fig. 39,¹ each being for a different intensity of illumination. Here, it will be noted how marked is the shift of the maximum point toward the lower wave lengths with decreased

¹ *Bulletin of the Bureau of Standards*, vol. 5 (1908-09), pp. 280-1, NUTTING.

intensity. The scales have been adjusted so as to have equal maximum points.

A further consideration which must be taken into account is the fact that for the end ranges of the spectrum, the amount of energy received by the eye when good illumination is demanded with monochromatic light becomes excessive. For example, if one is to see well by red light, a large amount of light will be required to enter the eye. The non-effective energy-content of the light is high and an excess of low frequency energy is expended upon the retina. The dissipation of this energy must be as heat, by chemical means or otherwise. But this injures the eye. The same comments would apply in the case of the higher frequencies of blue to ultra-violet range, the wave perhaps being even more destructive because of its more rapid vibration.

Glare.—Whenever there lie in the direct field of vision, objects illuminated so differently that the eye cannot adjust itself so as to admit sufficient light for visibility of the dark portions of the field without admitting too much for comfort from the light parts, there arises a double possibility. On the one hand, the pupil may contract so far that it permits visibility of the bright spot and shrouds the darker portions in obscurity. Again the pupil may adapt itself more or less successfully to the dark parts and admit too much light from the light part. Just what the eye will do depends upon conditions.

If the bright spot is a large part of the field, it will be the controlling feature and the darker features cannot be seen. When, however, the bright spot is small and not too intense, the eye will tend to regulate itself to secure recognition of details of the dark spots and leave a single point upon the retina flooded with light. The farther the high light is from the center of the field of vision, the brighter it must be to produce the same degree of discomfort.

When this combination of the bright spot in a field is sufficiently striking to produce discomfort there is said to be a "glare." It may result from the presence of a lamp installed too low, bringing it into one's field of vision and leaving it unshaded. It may be effected by specular reflection of light directly into the eyes of the observer. Glossy paper is very faulty in this respect, while misplaced lighting fixtures or fixtures unscientifically served by shades or reflectors are too common to excite notice. They are, however, one of the most prevalent crimes against the eye and will be discussed at a later time.

CHAPTER XI

PHOTOMETRY

Photometry. Aims and Definition.—In much of what has gone before, there has been evident the necessity of a process by which illuminants may be fully evaluated. They must be studied both individually and comparatively. Each one must be known by its characteristics in order that it may be put to the uses for which it is best fitted. These points will be emphasized even more in the discussions which follow. The problem therefore presents itself of devising apparatus and methods of procedure whereby, while the lighting unit is held at its normal condition of operation, there may be determined all necessary data for its complete recognition and understanding. These data include all such statistics as total output of light flux, the intensity of this light in each direction, the permanency of the unit as an efficient source of light, the suitability of the light for color vision, etc.

Photometry is the process of measuring the intensity of the light flux in any given direction or directions. Hence, it is fundamental to all of the steps by means of which the lamp is appraised. Its practice and the expression of its results require a set of terms, or a nomenclature especially adopted, in order that the presentation of facts may be scientifically correct and accurate as well as apprehensible to the reader. There are presented in the next few paragraphs the fundamentals of this nomenclature. They are reproduced from the reports of the Committee on Nomenclature and Standards of the Illuminating Engineering Society (1916) and have been established in conference with other societies.

NOMENCLATURE

① **Luminous flux** is radiant power evaluated according to its visibility; *i.e.*, its capacity to produce the sensation of light.

2. **The visibility, K_λ** , of radiation of a particular wave length, is the ratio of the luminous flux to the radiant power producing it.

3. **The mean value of the visibility, K_m** , over any range of wave lengths, or for the whole visible spectrum of any source, is the ratio of the total

luminous flux (in lumens) to the total radiant power (in ergs per second, but more commonly in watts).

4. The luminous intensity, I , of a point source of light is the solid angular density of the luminous flux emitted by the source (of light) in the direction considered; or it is the flux per unit solid angle from that source.

Defining equation:

$$I = \frac{dF}{d\omega}$$

or, if the intensity is uniform,

$$I = \frac{F}{\omega}$$

where ω is the solid angle.

5. Strictly speaking no point source exists, but any source of dimensions which are negligibly small by comparison with the distance at which it is observed may be treated as a point source.

6. Illumination, on a surface, is the luminous flux-density on that surface, or the flux per unit of intercepting area.

Defining equation:

$$E = \frac{dF}{dS}$$

or, when uniform,

$$E = \frac{F}{S}$$

where S is the area of the intercepting surface.

7. Candle—the unit of luminous intensity maintained by the national laboratories of France, Great Britain, and the United States.¹

8. Candle-power—luminous intensity expressed in candles.

9. Lumen—the unit of luminous flux, equal to the flux emitted in a unit solid angle (steradian) by a point source of one candle-power.²

10. Lux—a unit of illumination equal to one lumen per square meter. The c.g.s. unit of illumination is one lumen per square centimeter. For this unit Blondel has proposed the name "Phot." One millilumen per square centimeter (milliphot) is a practical derivative of the c.g.s. system. One foot-candle is one lumen per square foot and is equal to 1.0764 milliphots.

The milliphot is recommended for scientific records.

11. Exposure—the product of an illumination by the time. Blondel has proposed the name "phot-second" for the unit of exposure in the c.g.s. system. The microphot-second (0.000001 phot-second) is a convenient unit for photographic plate exposure.

12. Specific luminous radiation, E' —the luminous flux-density emitted by a surface, or the flux emitted per unit of emissive area. It is expressed in lumens per square centimeter.

Defining equation:

For surfaces obeying Lambert's cosine law of emission,

$$E' = \pi b_0.$$

¹ This unit, which is used also by many other countries, is frequently referred to as the international candle.

² A uniform source of one candle emits 4π lumens.

13. **Brightness, b ,** of an element of a luminous surface from a given position, may be expressed in terms of the luminous intensity per unit area of the surface projected on a plane perpendicular to the line of sight, and including only a surface of dimensions negligibly small in comparison with the distance at which it is observed. It is measured in candles per square centimeter of the projected area.

Defining equation:

$$b = \frac{dI}{dS \cos \theta}$$

(where θ is the angle between the normal to the surface and the line of sight).

14. **Normal brightness, b_n ,** of an element of a surface (sometimes called specific luminous intensity) is the brightness taken in a direction normal to the surface.¹

15. **Brightness** may also be expressed in terms of the specific luminous radiation of an ideal surface of perfect diffusing qualities, i.e., one obeying Lambert's cosine law.

16. **Lambert**—the c.g.s. unit of brightness, the brightness of a perfectly diffusing surface radiating or reflecting one lumen per square centimeter. This is equivalent to the brightness of a perfectly diffusing surface having a coefficient of reflection equal to unity and an illumination of one phot. For most purposes, the millilambert (0.001 lambert) is the preferable practical unit.

A perfectly diffusing surface emitting one lumen per square foot will have a brightness of 1.076 millilamberts.

Brightness expressed in candles per square centimeter may be reduced to lamberts by multiplying by $\pi = 3.14$.

Brightness expressed in candles per square inch may be reduced to foot candle brightness by multiplying by the factor $144\pi = 452$.

Brightness expressed in candles per square inch may be reduced to lamberts by multiplying by $\pi/6.45 = 0.4868$.

In practice, no surface obeys exactly Lambert's cosine law of emission; hence the brightness of a surface in lamberts is, in general, not numerically equal to its specific luminous radiation in lumens per square centimeter.

Defining equations:

$$L = \frac{dF}{dS}$$

or, when uniform,

$$L = \frac{F}{S}$$

17. **Coefficient of reflection**—the ratio of the total luminous flux reflected by a surface to the total luminous flux incident upon it. It is a simple numeric. The reflection from a surface may be regular, diffuse or mixed. In perfect regular reflection, all of the flux is reflected from the surface at an angle of reflection equal to the angle of incidence. In perfect

¹ In practice, the brightness b of a luminous surface or element thereof is observed and not the normal brightness b_n . For surfaces for which the cosine law of emission holds, the quantities b and b_n are equal.

diffuse reflection the flux is reflected from the surface in all directions in accordance with Lambert's cosine law. In most practical cases there is a superposition of regular and diffuse reflection.

18. **Coefficient of regular reflection** is the ratio of the luminous flux reflected regularly to the total incident flux.

19. **Coefficient of diffuse reflection** is the ratio of the luminous flux reflected diffusely to the total incident flux.

Defining equation:

Let m be the coefficient of reflection (regular or diffuse).

Then, for any given portion of the surface,

$$m = \frac{E'}{E}$$

20. **Lamp**—a generic term for an artificial source of light.

21. **Primary luminous standard**—a recognized standard luminous source reproducible from specifications.

22. **Representative luminous standard**—a standard of luminous intensity adopted as the authoritative custodian of the accepted value of the unit.

23. **Reference standard**—a standard calibrated in terms of the unit from either a primary or representative standard and used for the calibration of working standards.

24. **Working standard**—any standardized luminous source for daily use in photometry.

25. **Comparison lamp**—a lamp of constant but not necessarily known candle-power against which a working standard and test lamp are successively compared in a photometer.

26. **Test lamp**, in a photometer—a lamp to be tested.

27. **Performance curve**—a curve representing the behavior of a lamp in any particular (candle-power, consumption, etc.) at different periods during its life.

28. **Characteristic curve**—a curve expressing a relation between two variable properties of a luminous source, as candle-power and volts, candle-power and rate of fuel consumption.

29. **Horizontal distribution curve**—a polar curve representing the luminous intensity of a lamp, or lighting unit, in a plane perpendicular to the axis of the unit, and with the unit at the origin.

30. **Vertical distribution curve**—a polar curve representing the luminous intensity of a lamp, or lighting unit, in a plane passing through the axis of the unit and with the unit at the origin. Unless otherwise specified, a vertical distribution curve is assumed to be an average vertical distribution curve, such as may in many cases be obtained by rotating the unit about its axis, and measuring the average intensities at the different elevations. It is recommended that in vertical distribution curves, angles of elevation shall be counted positively from the nadir as zero, to the zenith as 180 deg. In the case of incandescent lamps, it is assumed that the vertical distribution curve is taken with the tip downward.

31. **Mean horizontal candle-power of a lamp**—the average candle-power in the horizontal plane passing through the luminous center of the lamp.

It is here assumed that the lamp (or other light source) is mounted in the usual manner, or, as in the case of an incandescent lamp, with its axis of symmetry vertical.

—32. **Mean spherical candle-power of a lamp**—the average candle-power of a lamp in all directions in space. It is equal to the total luminous flux of the lamp in lumens divided by 4π .

—33. **Mean hemispherical candle-power of a lamp** (upper or lower)—the average candle-power of a lamp in the hemisphere considered. It is equal to the total luminous flux emitted by the lamp in that hemisphere divided by 2π .

—34. **Mean zonal candle-power of a lamp**—the average candle-power of a lamp over the given zone. It is equal to the total luminous flux emitted by the lamp in that zone divided by the solid angle of the zone.

—35. **Spherical reduction factor of a lamp**—the ratio of the mean spherical to the mean horizontal candle-power of the lamp.¹

36. **Photometric tests** in which the results are stated in candle-power should be made at such a distance from the source of light that the latter may be regarded as practically a point. Where tests are made in the measurement of lamps with reflectors or other accessories at distances such that the inverse-square law does not apply, the results should always be given as "apparent candle-power" at the distance employed, which distance should always be specifically stated.

The output of all illuminants should be expressed in lumens.

37. **Illuminants should be rated upon a lumen basis** instead of a candle-power basis.

38. **The specific output of electric lamps** should be stated in terms of lumens per watt and the specific output of illuminants depending upon combustion should be stated in lumens per British thermal unit per hour. The use of the term "efficiency" in this connection should be discouraged. When auxiliary devices are necessarily employed in circuit with a lamp, the input should be taken to include both that in the lamp and that in the auxiliary devices. For example, the watts lost in the ballast resistance of an arc lamp are properly chargeable to the lamp.

39. **The specific consumption of an electric lamp** is its watt consumption per lumen. "Watts per candle" is a term used commercially in connection with electric incandescent lamps, and denotes watts per mean horizontal candle.

40. **Life Tests.**—Electric incandescent lamps of a given type may be assumed to operate under comparable conditions only when their lumens per watt consumed are the same. Life test results, in order to be compared must be either conducted under, or reduced to, comparable conditions of operation.

41. **In comparing different luminous sources**, not only should their candle-power be compared, but also their relative form, brightness, distribution of illumination and character of light.

¹ In the case of a uniform point-source, this factor would be unity, and for a straight cylindrical filament obeying the cosine law it would be $\frac{\pi}{4}$.

42. **Lamp Accessories.**—A *reflector* is an appliance the chief use of which is to redirect the luminous flux of a lamp in a desired direction or directions.

43. A **shade** is an appliance the chief use of which is to diminish or to interrupt the flux of a lamp in certain directions where such flux is not desirable. The function of a shade is commonly combined with that of a reflector.

44. A **globe** is an enclosing appliance of clear or diffusing material the chief use of which is either to protect the lamp or to diffuse its light.

45. **Photometric Units and Abbreviations.**

Photometric quantity	Name of unit	Symbols and defining equations	Abbreviation for name of unit
1. Luminous flux.	Lumen.....	F, Ψ	
2. Luminous intensity.....	Candle... ..	$I = \frac{dF}{d\omega}, \Gamma = \frac{d\Psi}{d\omega}$	c.-p.
3. Illumination..	Phot, foot-candle, lux	$E = \frac{dF}{dS} = \frac{I}{r^2} \cos \theta, \beta$	ph.fc.
4. Exposure.....	Phot-second,	Et	phs. μ phs.
	Micro phot-second.....		
5. Brightness....	Apparent candle per sq. cm.....	$b = \frac{dI}{dS \cos \theta}$	
	Apparent candle per sq. in.		
6. Normal brightness.....	Lambert.....	$L = \frac{dF}{dS}$	
	Candles per sq. cm. Candles per sq. in..		
7. Specific luminous radiation.	Lumens per sq. cm.	$E' = \pi b_0, \beta'$	
	Lumens per sq. in.		
8. Coefficient of reflection.....	$m = \frac{E'}{E}$	

- 9. Mean spherical candle-power..... s c.-p.
- 10. Mean lower hemispherical candle-power..... l.c.-p.
- 11. Mean upper hemispherical candle-power.. u.c.-p.
- 12. Mean zonal candle-power..... z.c.-p.
- 13. Mean horizontal candle-power..... m.h.c.-p.
- 14. 1 lumen is emitted by 0.07958 spherical candle-power.
- 15. 1 spherical candle-power emits 12.57 lumens.
- 16. 1 lux = 1 lumen incident per sq. meter = 0.0001 phot = 0.1 milliphot.
- 17. 1 phot = 1 lumen incident per sq. cm. = 10,000 lux = 1000 milliphots = 1,000,000 microphots.
- 18. 1 milliphot = 0.001 phot = 0.929.
- 19. 1 foot-candle = 1 lumen incident per sq. ft. = 1.076 milliphots = 10.76 lux.

20. 1 lambert = 1 lumen emitted per sq. cm. of a perfectly diffusing surface.
 21. 1 millilambert = 0.001 lambert.
 22. 1 lumen, emitted, per sq. ft.¹ = 1.076 millilamberts.
 23. 1 millilambert = 0.929 lumen, emitted, per sq. ft.¹
 24. 1 lambert = 0.3183 candle per sq. cm. = 2.054 candles per sq. in.
 25. 1 candle per sq. cm. = 3.1416 lamberts.
 26. 1 candle per sq. in. = 0.4868 lambert = 486.8 millilamberts.

46. **Symbols.**—In view of the fact that the symbols heretofore proposed by this committee conflict in some cases with symbols adopted for electric units by the International Electrotechnical Commission, it is proposed that where the possibility of any confusion exists in the use of electrical and photometrical symbols, an alternative system of symbols for photometrical quantities should be employed. These should be derived exclusively from the Greek alphabet, for instance:

Luminous intensity	Γ
Luminous flux	Ψ
Illumination	β

The Standard Candle.—The standard candle referred to in the preceding paragraphs is called the International Candle and is accepted in France, Great Britain and the United States. The development of this standard has been slow, however, and even now its basis is not wholly acceptable to engineers. The establishing of a fundamental standard is not a simple matter and is being given a large amount of study. For such a reference unit there must exist extremely high precision of rating, uniformity of operation, permanency, and accurate reproducibility. No device yet produced is satisfactory in any of these details. Simplicity and low cost are of secondary importance for primary standards, but are to be given their due weight. They become much more influential in affecting the design of secondary standards.

The history of the development of the standard by which a light source is to be rated leads us back to the old type of illuminant, namely the candle. Early measurements were made of light in terms of the regular candle, although the latter was not specifically described. It is evident at once that candles varied and the kind of candle used was then stated with gradually increasing fullness. To do this it was necessary to give materials, dimensions and rates of consumption. A spermaceti candle of specified size and rate of consumption became the working standard in England while paraffin was used in Germany. As

¹ Perfect diffusion assumed.

soon, however, as these units were compared with other proposed standards, it was quickly recognized that they were far from constant. A glance at the curves shown in Fig. 40 will indicate how rapidly and how widely they may vary in intensity of light flux. It is universally recognized today that the so-called "standard candle" is a thing of the past, not even the manufacturers undertaking the responsibility of vouching for them.

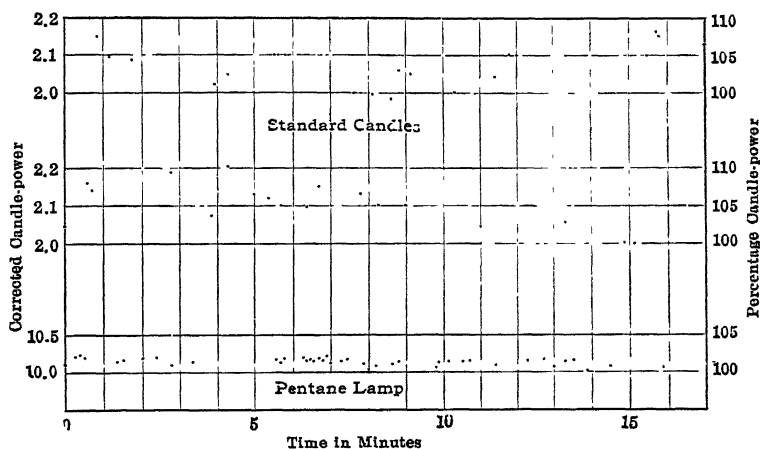

FIG. 40.—Flame-intensity variations for standard candles and pentane lamp.

The Pentane Lamp.—The pentane lamp is one of the units which easily showed up the deficiencies of the candles. It has been in use for a number of years as a regular authorized standard in England. Improvements upon it a few years ago make it perhaps the best primary standard of today. The curve shown in Fig. 40, for the pentane lamp, is said to represent the errors of observation rather than variations in candle-power of the light, this degree of inaccuracy arising from the rapidity with which it was necessary to take the readings. The same allowance should be made in connection with the curves for candles as shown upon the same sheet.

The pentane lamp, as modified for better work, is known as the Harcourt model, being made in the ten-candle-power size (see Fig. 41). Air is carbureted by passing over pentane (C_5H_{12}) and then delivered through an annular opening of the argand-burner type. Air is supplied through the center opening after

being heated by the hot flue gases. A chimney is placed 47 mm. above the burner, serving to carry off the gases, heat the incoming air and determine the height of the visible flame.

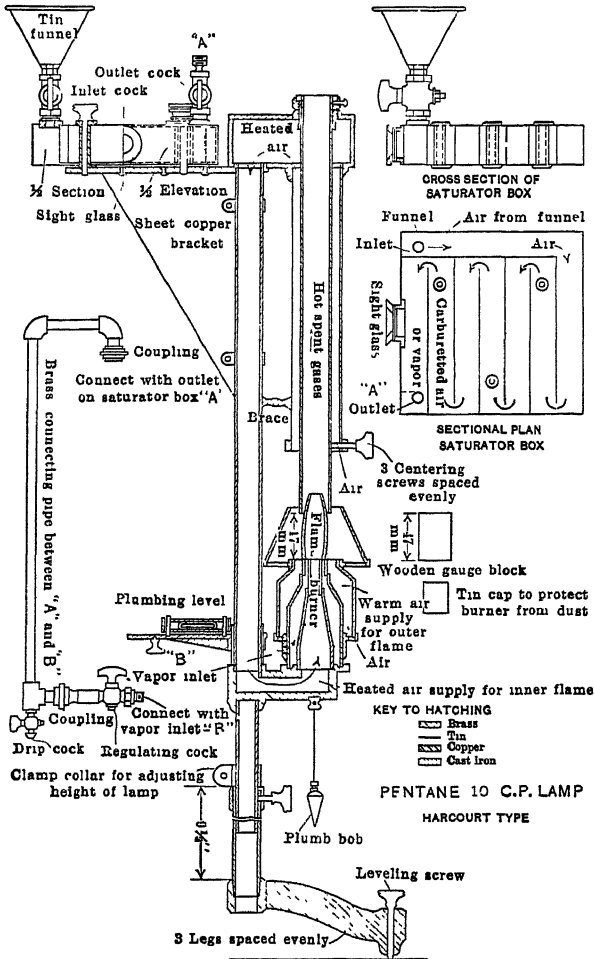

FIG. 41.—Harcourt pentane lamp.

In order to indicate how delicate are the sensibilities of the flame standards, it will be interesting to specify some of the most noticeable causes of variation in the light of the pentane lamp. Similar or identical agencies exist in connection with any of the others.

The fuel used is pentane, having a chemical composition of C_5H_{12} , in spite of which it varies. There are three different molecular constructions for the same formula, giving rise to slightly different characteristics. Fortunately, these pertain more to the distillation temperature than to the luminosity of the flame produced. Furthermore, as pentane is a petroleum distillate, it is defined by its distillation range and includes some of the impurities which overstep these boundaries.

Moisture content of the air as well as barometric pressure will affect the luminosity, by changing the amount of oxygen supplied to the flame. Correction curves must be used for these variations. Similarly, the temperature at which the carbureter is worked will determine the amount of fuel being vaporized, and for high temperature evaporation may be rapid enough to exclude any flow through the carbureter itself, vaporized pentane being furnished to the burner.

Drafts cause serious variations in the light as will also the composition of the air supply. Any lack of adjustment is also a direct cause of error. This is more liable to occur in connection with the spacing of the chimney above the burner than in any other particular. The lamp must be operated for at least half an hour before becoming stable.

While all of the above errors may creep into the operation of a given lamp, still other troubles are present when we are comparing two different lamps. From the standpoint of reproducibility of the lamp we find it impossible to make two lamps exactly alike. The air passages of one will have more friction than those of the other. Radiation losses are different. Chimneys are not identical in shape or length. Burners vary in shape and in the number of holes in the annular ring. Heat conduction away from the active zone depends upon the construction of all accessory parts. The active height of the chimney is lessened by its downward expansion from its point of support, which is sometimes at the bottom and sometimes at the top.

Individually, some of these errors may be of the magnitude of 2 per cent. or 3 per cent., although the greater number of them are of lesser value. Nevertheless, it is easily seen that much attention must be paid to details of both construction and operation.

The Hefner Lamp.—The Hefner lamp (see Fig. 42) has been accepted as the standard in Germany for many years. It has a

wick fed by pure amyl acetate. The height of the flame is gaged by a sight provided, and is maintained at 40 mm. It is a simple device to construct and to operate although it does require the same careful attention as any other lamp. It is rugged and easily duplicated. In practice, it is found to give very consistent results and it is being used in this country though less than the

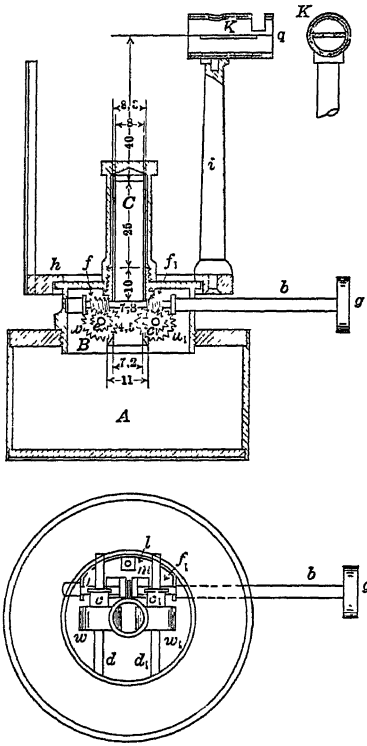

FIG. 42.—Hefner lamp.

pentane lamp. One of the principal objections that is raised to it is its low candle-power. As it is standardized, it has a value of 0.9 international candle-power. Not having any chimney, it is a little unsteady and very sensitive to drafts. Again, the color is rather redder than the common illuminants, giving rise to some of the difficulties mentioned later in this chapter.

Upon the whole, however, both of these primary standards are practicable and neither one has a predominant place over the other.

Color Content.—The question will soon be taken up of color content of the different sources of light. At once we are compelled to admit that there is no standard in this particular.

We speak of "white light" as if it means something definite, but it does not. It is variously taken as direct sunlight at noon, indirect sunlight at noon, light of the clear sky and an "average" daylight. It is not, therefore a scientific term and cannot become one until there is adopted some definite color mixture giving the impression of whiteness and, at the same time being made up of component parts which, taken in varying proportions, will also give the complete color scale. A few such combinations have been suggested but no action has been taken serving to establish any one of these as a recognized

standard.¹ Even then, we shall still be at a loss to pronounce upon the equivalency of a certain amount of "red" light and another amount of "green" light which would have to be adopted before we could establish a scalar relation for the expression of results over the complete range.

Secondary Standards.—The average photometric laboratory does not go back to the primary standard in its everyday work, but utilizes secondary standards especially adapted to its particular problem. These secondary units are generally tested by some one of the regular standardizing bureaus, where the necessary comparison is made between them and the primary standards. The requirements for a good secondary standard are much like those of the primary, with the emphasis shifted to different items. It must be constant in output for a reasonable length of time, subject to accurate rating, cheap, steady, simple in manipulation, of convenient size and suitable colors. In this field there is no serious competitor to the incandescent lamp. To a satisfactory extent, all the above requirements are met. It will be noted that reproducibility is not a necessity in this case. It does not matter if the secondary standards used successively in a laboratory differ somewhat from each other in rating, provided only, that each is carefully evaluated.

Both carbon filaments and tungsten filaments are used. Their principal differences are in color and in regulation. Both are run at voltages slightly below those at which they would be rated for regular service and each runs a little more red than it otherwise would. Nevertheless, the carbon lamp is considerably more red than the tungsten lamp. It is best, therefore, to use for a standard the same kind of lamp as is being tested.

With these lamps it is possible to regulate for constant current, constant voltage or constant wattage. Probably the most accurate setting for light flux would be obtained with a constant power. Constant voltage, however, is the criterion nearly always used, being better adapted to general practice and more accurate than constant current. It is especially good with tungsten lamps, owing to their positive temperature coefficient.

Carbon and tungsten lamps are used with about the same restrictions and precautions and in the following there are made no distinctions between them.

¹ Upon this subject, see STEINMETZ, *Trans. A.I.E.E.*, vol. 27, 1908, p. 1319, and IVES, *Trans. Illum. Eng. Soc.*, vol. 6, 1911, p. 258.

Establishing Secondary Standards.—Lamps to be standardized are first given a very rigid inspection to make sure that they are mechanically perfect, symmetrical and of strictly accurate standard dimensions. The vacuum must be good in order to promise a good life. After these points are determined to be satisfactory, the lamp is seasoned.

Seasoning a lamp consists in running it upon its rated voltage until it has reached the initial point of its constant candle-power range. By an examination of the life curve of a lamp (Fig. 25) it will be seen that during the first fifty hours or so the candle-power of the lamp rises. It gradually reaches a maximum and then slowly falls off along a line practically straight over the range beyond two hundred hours. The crest of the curve is maintained at a fairly uniform value for a considerable period. The constant candle-power range alluded to above is this region of approximate constancy and it represents the working life of the unit as a standard. This part of the curve is successfully extended somewhat by rating the lamp at a voltage appreciably below that at which it would be rated for other purposes. This practice affects the color of the standard, of course, rendering it a little redder than it would be on the higher voltage.

The Photometer.—The photometer consists essentially of a screen to be illuminated, an optical system for observing the effect upon the screen and a bench or scale for measuring the distances between lamps and screen. It is operated by allowing the test lamp and the standard lamp to illuminate the screen simultaneously, while the distances are adjusted until equality of illumination is secured. The relative measurements upon the distance scale then give us a means of calculating the intensity of the test lamp in terms of the working standard, for, according to the law of inverse squares, the illumination will vary inversely as the square of the distance between the light and the screen. This law of inverse squares may be used provided the light sources are small as compared to their distances from the screen.

The screen functions by reflection or by transmission of the light. Under both conditions, however, the action must be highly diffusing or the lamps themselves will be seen and the illumination cannot be judged. Again, no selective absorption is permissible or the color effects are not properly obtained. The reflecting surface should be uniformly white and very finely irregular. Such materials as plaster-of-Paris or paper are widely

used. A satisfactory material for transmission screen is a uniform tissue paper.

The sensitivity of the screen is increased by utilizing a material which is as highly reflecting or transmitting as possible. The screen must also be arranged so as to establish a clear-cut boundary between the two fields to be compared. The accuracy is greatly enhanced by bringing these two regions into direct and intimate contact. As elsewhere indicated, the eye is competent to recognize a change of about 1 per cent. in the illumination of a body. It follows that the screen should be sufficiently sensitive so that the eye may utilize its own full sensitivity.

Methods of Comparing Light Intensity.—There are three distinct methods by which the intensity of light is measured. The foremost of these may be known as the method of direct comparison by *equality of brightness*. The second is the *flicker method*. The third establishes a reading by finding at what distance the light is effective in *illuminating a printed page for reading*. It will be noted that the light flux is considered here without regard to color. Where this latter is necessary, there are other methods of approaching the problem more scientifically although the flicker photometer was developed especially to take care of just such difficulties, and the use of a printed page for reading establishes a good comparison on the basis of visibility. The more elaborate processes are also more analytical. The first one makes use of the *spectrophotometer*, while the second method uses *absorbing color screens*.

For simplicity and general utility and satisfaction, the direct comparison of the test lamp with a standard by equality of brightness is commendable. In some cases there may be provided, two different intensities of illumination by each of the two lamps being compared, a balance being more easily established. The weakness of this method develops when it is called upon to measure a light differing somewhat in color from that of the standard. Heterochromatic photometry is not its sphere, for the division line between the two fields cannot be made to disappear.

Upon the other hand, it has been found that with the flicker type of instrument, the difference in color becomes indistinguishable by a merging of the colors while a lack of balance in illumination is still distinguishable because the flicker still persists. It is a question, yet, as to what part is played in this by lag in per-

ception and persistence of vision. Certain it is that the speed of the flicker device must be easily and widely changeable, and it must be regulated to its lowest possible value for any setting in order to make sure that the flicker has not disappeared merely from too high a speed.

Cheapness, portability and a fair degree of accuracy are combined in the third type mentioned which depends upon the visibility of a printed page. It is not the only portable photometer, however. Fairly accurate instruments are obtainable, operating on each of the other principles.

It is easily seen, however, that the only full comparison of lamps, or the evaluation of any one lamp, must come from an analytical process. Mere brightness of the illuminated screen, while a criterion of the effectiveness with which the lamp may be used for its specific application, that for which it was made, is not the scientific declaration. Of course, it cannot be disputed that illumination for visibility is the main thing to be considered but even here color comes forward and plays a very important part in the matter. Form, or shape, the presence or the absence of an object, the likelihood of danger, etc., generally though not always, may be discerned without a recognition of colors. But so much depends upon color and its accurate perception that our light sources must be studied from this standpoint. And this leads to spectrophotometric measurements, where the light is dispersed by prisms and measured in its different components, separately. Or, again, absorption screens may be interposed, cutting off certain components, while others are being measured. With this latter scheme, either stationary screens or flicker screens may be used, but Ives has concluded¹ that it is best to use the flicker instrument. His instrument is described in these pages, as are several of the other general types. These descriptions will serve to present a few of the most common and most important of the devices found in practice. Many elaborations upon these methods will be found and many excellent photometers are available,² designed both for general use and for attacking special problems.

¹ "Studies in the Photometry of Lights of Different Colors." *Philosophical Magazine*, July, September, November, December, 1912.

² For description of other photometers see *Trans. Illum. Eng. Soc.*, various volumes; *Illum. Eng. Prac.*, (I.E.S. Lectures, 1916); "Light Photometry & Illumination," BARROWS; "Illumination and Photometry," WICKENDEN.

The Bunsen Photometer.—The Bunsen photometer, though not the earliest instrument, is one of the simplest and most effective. The screen consists of a white paper or parchment with a paraffined spot in the center. It is mounted upon a carriage which rides upon a track along a bench. This bench is the framework of the whole device and carries the scale upon which the distance readings are made. The standard lamp is mounted at one end of the scale, the test lamp at the other end. As the screen is moved back and forth between the two lamps, a position is found where the illumination on one side is equalled

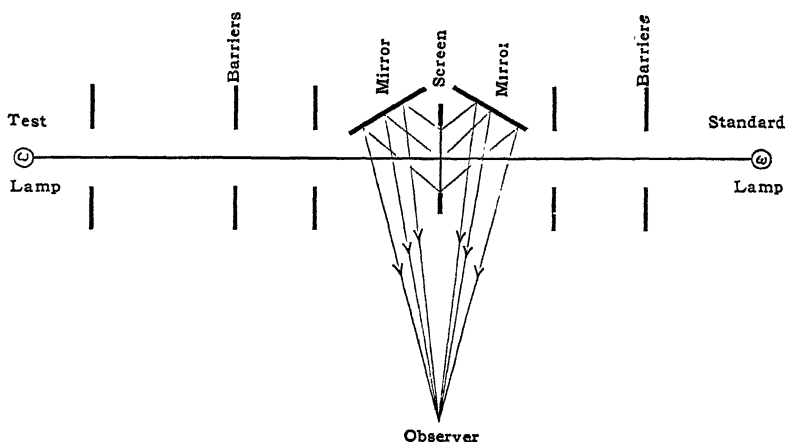

FIG. 43.—Bunsen photometer.

by that on the other side. At this setting, as much light is transmitted through the translucent spot from left to right as from right to left. In other words, as much light comes off from the greased spot, in either direction, as there would be given off by a plain reflecting screen, permitting no transmission of light through it. Hence, the screen appears equally bright upon its whole surface. When the carriage is moved from this position, say, toward the right, if the screen is viewed from the right, the spot appears darker than the surrounding portion of its surface. This is because there is more light sent through the spot from right to left than there is from left to right. If viewed from the left side, the spot shows brighter than the remainder of the screen. From either side, then, the lack of balance is recognized. In fact, there are generally mirrors provided so

that both sides of the screen may be seen at the same time and as close together as possible. Fig. 43 gives an idea of the arrangement.

If s and t are the distances, respectively, to the standard lamp and the test lamp, and if S and T are their respective candle-powers, we have for this reading

$$T : S = t^2 : s^2$$

$$T = \frac{t^2}{s^2} S.$$

It is necessary to have the illuminated screen hooded by dead black sheaths and it is best to have some similarly painted annular cutouts mounted along the bench between the lamps and the carriage. This will serve to help eliminate all reflected rays, or light coming from anywhere except directly from the lamps themselves. Such barriers are absolutely necessary if the walls of the room are not completely absorbent to light. Generally the walls are painted a dull black throughout the room and barriers are added as a precaution.

The bench should be at least three meters long for the ordinary work such as the comparison of the common sizes of incandescent lamps where the standard has about the same rating as the test lamp. The distance from the light to the illuminated screen must be greater for sources having a large area than when they are approximate point sources. This comes about from the fact that the law of inverse squares is applicable only to point sources. It has been found,¹ however, that no very material error is introduced into the calculation if the distance between lamp and screen is about ten times the greatest dimension of the projected incandescent member.

The Lummer-Brodhun Photometer.—The Lummer-Brodhun photometer differs from the Bunsen mainly in the optical devices by which the screen is viewed. In Fig. 44 the lamps are located at L_1 and L_2 , their light being represented by the respective groups of lines, $abcd$ and $wvxy$. Where these rays strike the screen S , diffuse reflection takes place as represented by the tufts proceeding from its surface. Mirrors placed at M_1 and M_2 receive a portion of this light, as $a'b'c'd'$ and $v'w'x'y'$ and direct it upon the prisms P_1 and P_2 . These two prisms are in

¹ "Geometrical Theory of Radiating Surfaces." HYDE, *Bull. Bur. Stds.*, vol. 3 (1907), p. 81.

contact with each other over a circular area, T in their centers, while the annular spaces, RR , surrounding these contacts are separated by slight distances. The results are easily understood from a study of the figure. Of the sheaf $a'b'c'd'$ the center

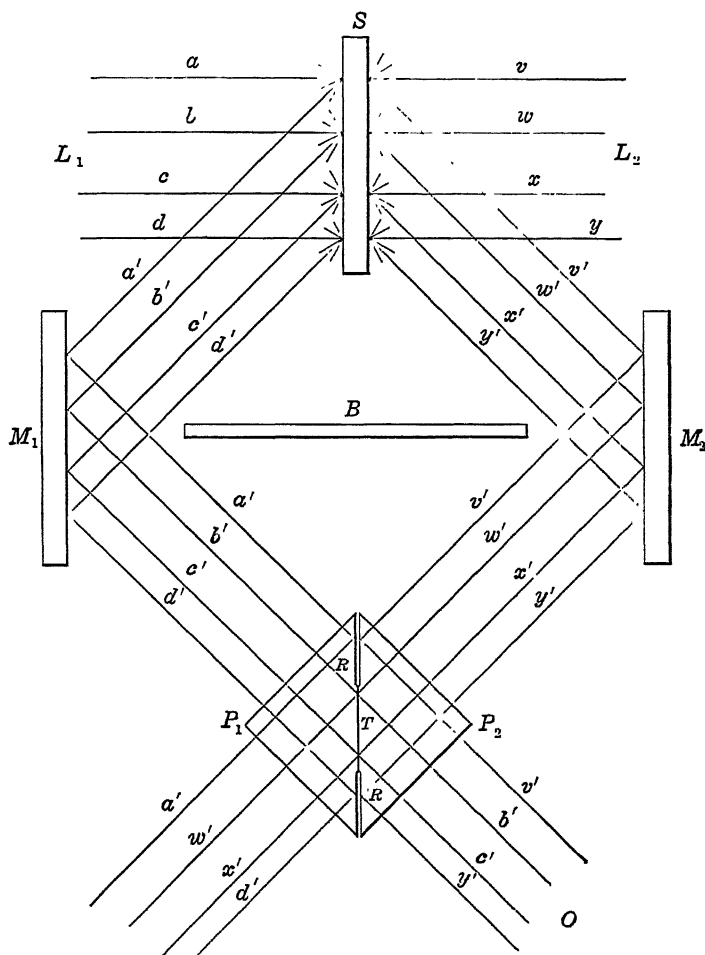
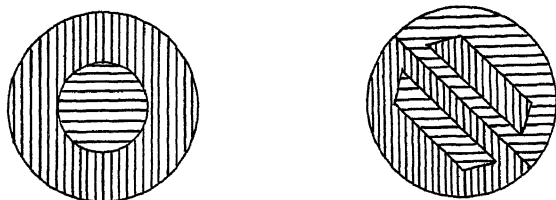

FIG. 44.—Lummer-Brodhun sight box.

rays, $c'd'$, will pass through prism P_1 into P_2 through the contact area T as appears at the lower right hand part of the illustration. The outer part of this beam, however, will be reflected by the surfaces RR , and will be thrown to the left as at $a'd'$. Similarly,

the light coming from L_2 , mirrored at M_2 , is separated at the double prism, and the center, $w'x'$, is transmitted through them while the annular sheaf, $v'w'$, is reflected and appears at the right. An observer located at O will see, therefore, a center illumination from L_1 and an outer illumination from L_2 . A balance established between these two elements indicates an equality of brightness of the two surfaces of the screen. If the two surfaces are equally white, an equality of illumination also exists. The apparatus is arranged so that the whole train of devices consisting of screen mirrors, prisms and eyepiece can be reversed and a second series of readings taken in order to



Figs. 45 and 46.—Annular areas and contrast areas of Lummer-Brodhun sight box.

eliminate any error due to the possibility of unlike surfaces of the screen. During unbalanced conditions the areas appear as in Fig. 45.

In some instruments the contacts of the two prisms are arranged so that an unbalance gives the effect shown in Fig. 46. The greater intimacy of the arrangement of the areas gives a possibility of a greater accuracy of setting.

Integrating Photometers.—In order to sum the light flux from a lamp a single revolving mirror might be used, with speed of rotation high enough to average the flux received in the zone occupied. A stationary mirror and a rotating lamp will give the same result.

Extending the single-mirror idea to the use of multiple mirrors it is readily seen that it will be possible to receive simultaneously at the eyepiece, reflected light from all directions in any one meridian. By one reading, therefore, it is possible to determine a known percentage of the total light flux from the lamp. Therefrom, may be obtained the mean spherical candle-power. The

Matthews integrating photometer¹ accomplishes its results by this device.

Going still farther, and surrounding the light by a globe with a diffusing inner surface² (Fig. 47), the illumination upon any point therein, such as a small window at one side but protected

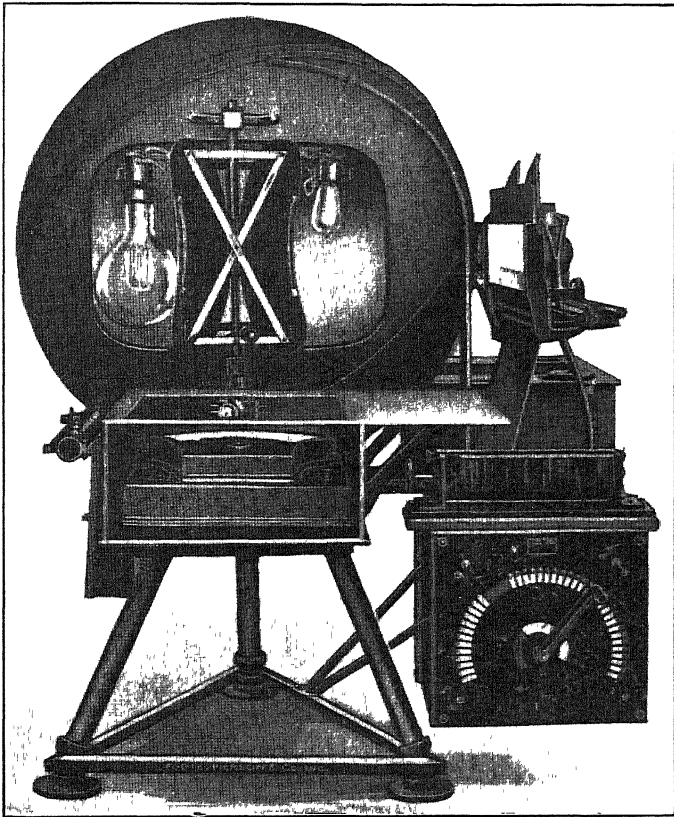

FIG. 47.—Globe photometer and accessories.

from direct rays, will represent a summation of diffused light from all directions from the lamp. Comparing this effect with that of a standard lamp gives the factor by which the flux from the standard must be multiplied to give the total flux from the test lamp.

¹ *Trans. A.I.E.E.*, vol. 18 (1901), p. 677, DR. C. P. MATTHEWS.

² *Trans. Illum. Eng. Soc.*, vol. 3 (1908), p. 508, SHARP & MILLAR; *Illum. Eng. Pract. (I.E.S. Lectures, 1916)*, p. 111-116, SHARP.

The Flicker Photometer.—The flicker photometer in its simplest form consists of a disc illuminated by one light, in front of which rotates a sectored disc illuminated by the other light. A later and more elaborate scheme is described by Ives and Brady in the *Physical Review* of Sept., 1914, as illustrated in Fig. 48. This particular instrument also shows the use of the neutral absorbing screens and will therefore serve as a double illustration.

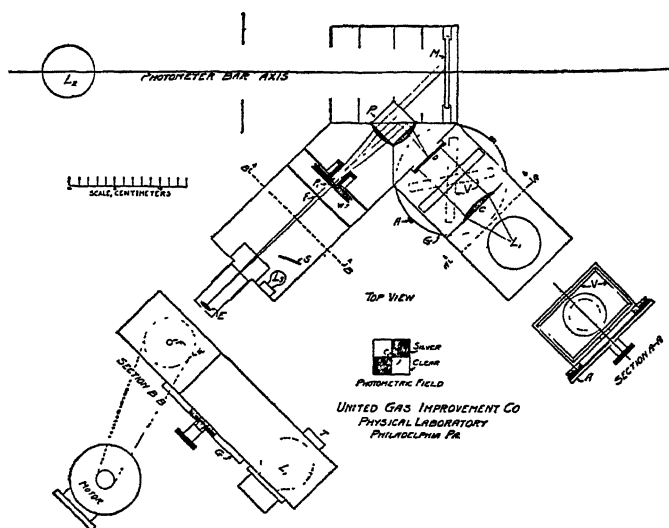

FIG. 48.—Flicker photometer.

The photometer is meant to be used as a means of comparison by substitution. Hence, the standard and the test lamp successively occupy positions upon the photometer bar as at L_2 . The comparison lamp is fixed at L_1 . The standard lamp is placed as indicated, and its light strikes the white diffusing screen (M) a portion of it then entering the optical train, consisting of the Lummer-Brodhun prisms (P), the flicker device (P_1), the cut-out (F) and the eyepiece (E). Light from the comparison lamp (L_1) passes through the lens (C) thence through the variable neutral-tint screen (V) to the opal glass (O) being partly transmitted to the Lummer-Brodhun cube (P) where it is reflected to the flicker device and eyepiece. The 10° prism, P_1 , is caused to rotate by means of the wheel (W), thus sending through the small hole in the barrier (F) first the light from one source, then the light from the other source. These entering the eye at E ,

give the flicker attendant upon the lack of balance. After adjustment for the standard, the test lamp is substituted and balanced with the comparison lamp.

The Lummer-Brodhun cube has one prism with a partially silvered surface, for reflecting the light from the comparison lamp. In this particular, it differs from the usual arrangement. The auxiliary lamp (L_2) is provided for the low illumination of the chamber about the eyepiece. This expedient is said to contribute to the comfort of reading.

The Sharp-Millar Photometer.—The Universal photometer described by Sharp & Millar¹ is a well-known and much-used

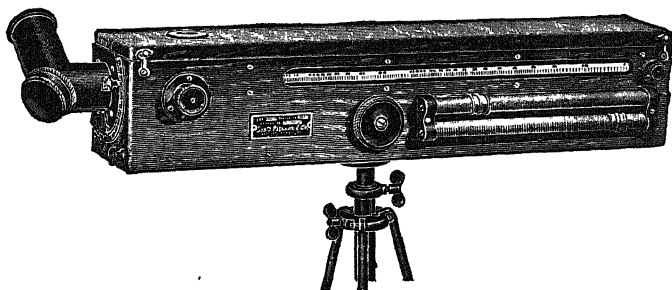

FIG. 49.—Sharp-Millar universal photometer, Model F2410, standard size.

instrument. Its development was a result of the study by these men of the problems presented by demands for accuracy with varying conditions of installations. It thus becomes a portable instrument as will be seen by referring to Fig. 49.

There is adopted a modified form of the Lummer-Brodhun arrangement or optical train. A well-seasoned incandescent lamp is the comparison lamp. The comparison lamp is arranged to approach or recede from the illuminated plate. Special glass is used for the screen. The whole device weighs about 8 pounds.

In Fig. 50 there are shown the main details of this instrument. The housing is a wooden box, the cover of which (C) opens so as to give easy access to all parts. The comparison lamp (L) is enclosed in a metal container and is mounted upon a small carriage which can be drawn back and forth in the body of the instrument, by means of a cord. The cord passes over pulleys and around a drum, the whole system being moved by

¹ *Electrical World*, vol. 51 (1908), p. 181; *Illum. Eng. Prac. (I.E.S. Lectures, 1916)*, p. 117.

turning a knob (*K*) which turns the drum. Light from the comparison lamp passes through openings in the barrier screens (*B*) and illuminates the small ground-glass screen (*G*). The Lummer-Brodhun cube (*P*) receives diffused light from this source and, in turn, transmits it to the eyepiece (*E*). The intensity of this illumination can be varied by shifting the lamp along the track, as described. In order to secure a greater range of illumination, absorbing screens (*A*) are provided which may be moved into position between the ground-glass and the cube. These transmit respectively 10 per cent. and 1 per cent. of the incident light. A rheostat is also provided to permit the adjustment of the lamp

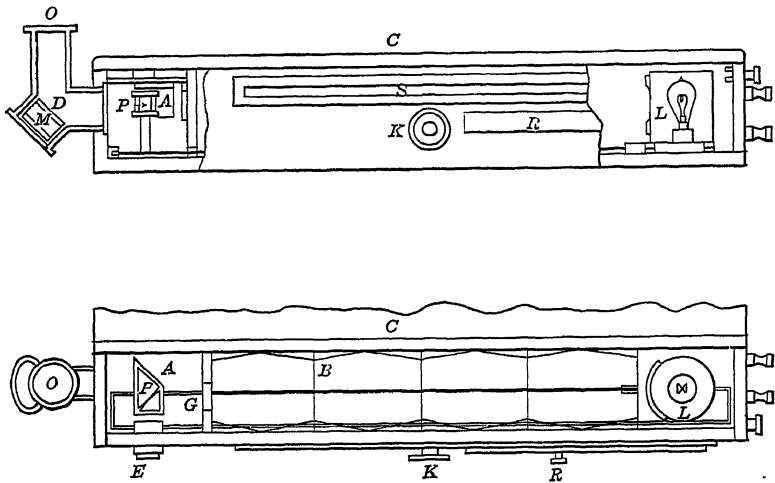

FIG. 50.—Plan and elevation of Sharp-Millar photometer.

circuit as desired. This is controlled by an external handle (*R*). The position of the lamp is read from a scale (*S*) along the side of the box.

The test light (*T*) is placed in front of the elbow extending from the other end of the box, the distance being known as measured from test lamp to the diffusing screen (*D*). The opening of the elbow (*O*) is not closed when the instrument is being thus used. This diffused beam now passes in part to the optical devices (*P*, *E*) as is easily seen, and a comparison is established with the comparison lamp. The working standard is then substituted for the test lamp, and a direct relationship is established between test lamp and standard.

When it is desired to measure the illumination at a given point, the diffusing screen in the elbow is reversed, bringing a mirror (*M*) into position. The opening in the elbow is then pointed at the object whose illumination is to be determined. The instrument can be calibrated for this service by taking a reading upon a screen having a predetermined illumination.

Again, if it is desired to determine the general illumination at a point, there is placed over the opening of the elbow a translucent illumination test plate, the mirror remaining in service at the bend of the elbow.

This elbow tube is attached to the box over a slip-on collar and is held in place by friction. The opening, therefore, can be pointed in any direction with ease. Standard dimensions of the box are 29 in. by 5 in. by 5 in., this being the intermediate size.

Measurement of Coefficient of Reflection.—When it is required to measure the coefficient of reflection of a plate or mirror, the bar photometer is convenient. The direct beam is scattered and it becomes necessary to collect all reflected light. This can be done only by an integrating photometer, the globe type being best. In this measurement, the reflector is placed within the globe, a measured light flux is thrown upon it, and the photometer reading gives the total of the reflected light. The telescope or reading device should not receive light directly from the reflecting surface.

Transmission of light through semi-transparent bodies may be measured by an adaptation of the same type of photometer. This is true whether the transmission is regular or diffusing.

The Ives Colorimeter.—The Ives colorimeter is an instrument designed for the evaluation of any color in terms of three given primary colors. Spectral red, green and blue lights may be mixed in proportions which will match any color. In construction, the instrument consists of an oblong box, at one end of which are four slits. One of these slits remains clear while the other three are covered with red, green and blue transmission screens. The slits are of adjustable widths with scale readings from zero to one hundred. Within the case is a set of lenses, so arranged that they may be rotated rapidly. This motion causes the varicolored lights to be thrown in rapid succession upon the field of vision, where, due to the persistence of vision, they are combined into one color effect. This mixed color is then com-

pared with the test color and the three slits are adjusted until a match is effected.

In practice, something is assumed to be the reference standard, such as an average of numerous daylight readings, the instrument is arranged to give this color and the scales are all set upon 100. Subsequent color matches are then expressed in terms of this daylight. Some of the readings given¹ in connection with the use of this instrument follow and are indicative of its synthesis. It will be seen that it does not give the same kind of results that a spectro-photometer would give. The latter indicates relative values at all points of the spectrum. The colorimeter will give identical readings for any two color combinations which appear alike to the eye.

TABLE 15.—COLORIMETER READINGS OF VARIOUS SOURCES

Source	Red	Green	Blue
Average daylight.....	100	100	100.0
Blue sky.....	100	106	120.0
Sunlight, 2 p. m. (Washington, Aug.).....	100	95	68.0
Tungsten lamp (1.25 watts).....	100	55	12.1
Acetylene flame.....	100	50	10.4
Carbon lamp (31 watts).....	100	45	7.4

As a further item of interest, there is given a list of flame standards, evaluated by this method, in terms of a carbon filament lamp with a consumption of 4 watts per candle-power.²

TABLE 16.—COLORIMETER READINGS OF FLAME STANDARDS

Source	Red	Green	Blue
Carbon lamp (4 w. per c.-p.).....	100	100.0	100
Coal gas (flat flame).....	100	100.0	100
Kerosene standard (light oil).....	100	101.0	102
Kerosene standard (heavy oil).....	100	96.0	85
Carcel lamp.....	100	94.0	76
Pentane lamp.....	100	91.0	68
Candles.....	100	88.0	61
Hefner lamp.....	100	87.5	59

¹ *Trans. Illum. Eng. Soc.*, vol. 3 (1908), p. 627.

² *Trans. Illum. Eng. Soc.*, vol. 6 (1911), p. 422.

The Spectrophotometer.—The spectrophotometer mentioned above may include the usual Lummer-Brodhun cube and all other parts of the photometer up to that point. Interposed between the cube and the observer's eye is placed a prism which disperses the beams. Any one position in the spectrum may then be taken and the two lights compared for that color. Fig. 51 will give an idea of the results obtained with this instrument. It is taken from data given by Ives (*Trans. I.E.S.*, vol. 5 (1910) p. 189).

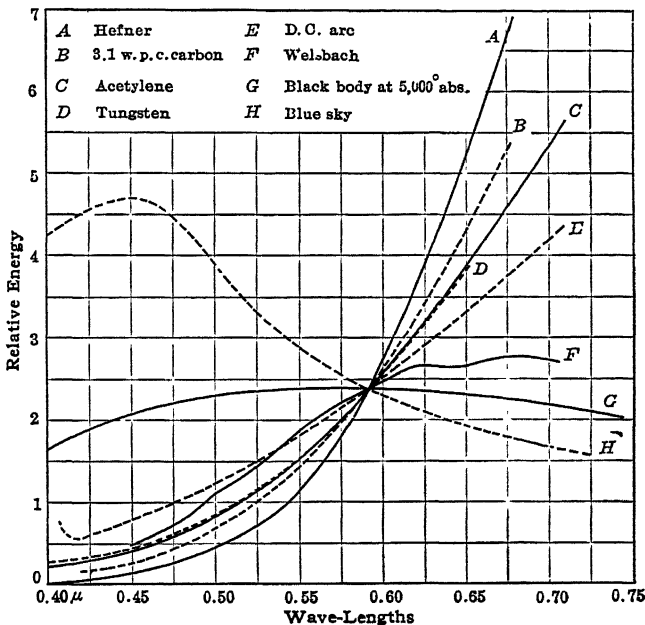

FIG. 51.—Spectrophotometric curves for different light-sources.

Arc Lamp Photometry.—The photometry of arc lamps presents difficulties not heretofore discussed. For example, it is impossible to tip the lamp so non-equatorial readings may be taken. The candle-power is high and the standard is so much smaller that distances have to be large between the test lamp and the illumination screen. The light is generally unsteady and a balance is hard to achieve. Such complications are overcome by various expedients.

Not being able to tilt the lamp, a mirror is used to direct toward the photometrical device the light from any definite

portion of the space surrounding the lamp. Either the lamp or the mirror is fixed in position, while the other one revolves about it. Fig. 52¹ shows a stationary lamp with revolving mirrors. Fig. 53¹ shows the other arrangement.

While increased distances are always used in connection with arc lamp photometry, it is not always a possibility to carry the scheme far enough. Another plan is to place between the large lamp and the screen a revolving disc of metal having sectors cut out of it in width proportional to the amount of light which it is desired to permit to fall upon the screen. For example, if one-eighth of the disc is removed, the candle-power reading must be multiplied by eight. The disc must be run at such a speed that all flickering effect is overcome.

The unsteadiness of the arc light is largely a result of the tendency of the arc itself to wander over the areas of the ends of the electrodes. To a certain degree, therefore, what light is lost on one side of the lamp is, at the same instant, likely to appear in the flux from the opposite side. If, then, two mirrors are used simultaneously, being placed upon opposite sides of the arc, there will be probability of greater accuracy in the final result of total lumens output of the lamp. Moreover, the apparent steadiness of the light flux is increased and the individual readings are more easily taken.

Total Flux of Light from a Source.²—In order to find the total amount of light flux emanating from a lamp, it is necessary to do one of two things. Either the whole light flux in all directions must be combined in the one reading, or the individual reading in the different directions must be properly aggregated. The former scheme is used in spherical photometers, and in the types having multiple mirrors or rapidly revolving mirrors. When the separate readings are taken and a distribution curve is established for a vertical plane, we find that the readings are not to be summed directly, because those in the equatorial region apply for more space than do those readings in the polar regions. The total flux, of course, is a summation of the products of the intensity of illumination into the areas illuminated.

It is permissible to assume that the distribution curve for one vertical plane which passes through the axis of the lamp is the same as for all others. If, now, we consider that the lamp is

¹ *Trans. I.E.S.*, vol. 6 (1911), p. 641, *et seq.*, STICKNEY and ROSE.

² See *Ill. Eng. Pract.* (1916), p. 4, *et seq.*, McALLISTER.

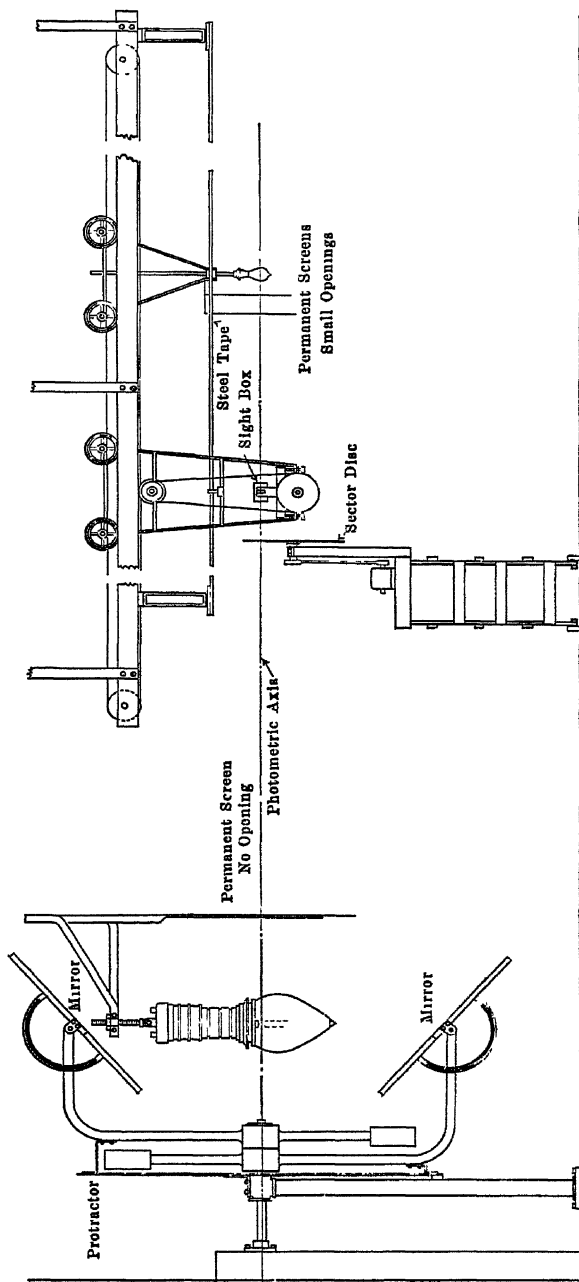

FIG. 52.—Twin-mirror photometer for arc lights.

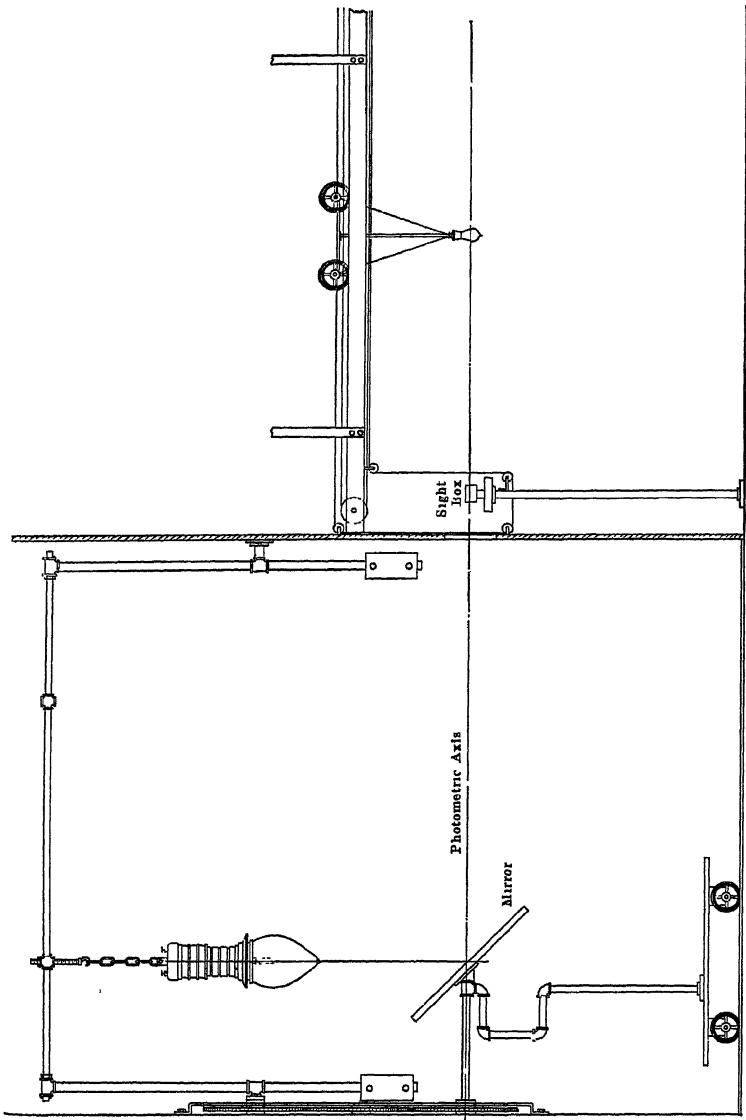

FIG. 53.—One-mirror crane photometer for arc lights.

placed at the center of a hollow unit sphere, as at O , Fig. 54, flux passing out horizontally from it must illuminate the complete equatorial zone while flux passing out at some other elevation will illuminate a smaller zone, that is, one having a lesser circumferential length. But each very narrow zone is uniformly lighted, hence the total flux received by a zone is the product of the intensity of light in that direction into the area of the zone. The areas of the zones are proportional to their heights (measured vertically along the axis of the lamp). But if the surface widths remain equal, subtending equal angles at the center, the heights vary, becoming less in the polar regions. We have

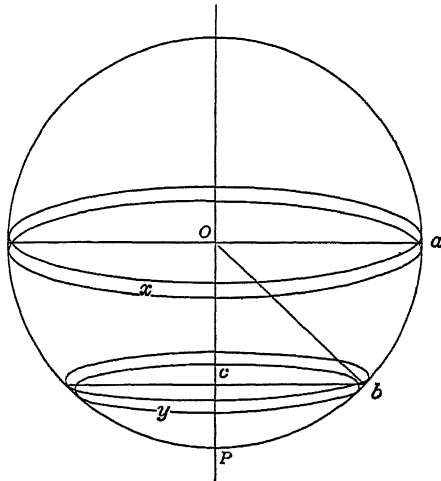

FIG. 54.—Spherical calculations.

$$\text{Area } (ax) : \text{area } (by) = \text{height } (xa) : \text{height } (by)$$

If the zones are narrow, the relation holds fairly well that,

$$\begin{aligned} \text{Area } (ax) : \text{area } (by) &= \sin POa : \sin POb \\ &= Oa : cb. \end{aligned}$$

These relations may be used in several different ways to complete the calculations.

For example, suppose the distribution curve of Fig. 55 to apply to the situation here presented. It represents the light flux from a 60-watt mazda lamp, fitted with an X-ray reflector, No. 555. We will divide each quadrant into nine equal angles of ten degrees each and read the candle-power supplied to the center of each section, viz., at 5° , 15° , . . . 85° , . . . 185° . The flux received

by any one of these zones is proportional to the reading just taken and to the sine of the angle of departure from the downward vertical.

Therefore,

$$I = K (I_5 \sin 5^\circ + I_{15} \sin 15^\circ + \dots + I_{185} \sin 185^\circ).$$

It will be noted that we still have to determine the value of the proportionality factor, K . Wohlaue¹ has presented this method of calculation and has shown that the factor K depends in value upon the width of the zones into which the arc covered is divided.

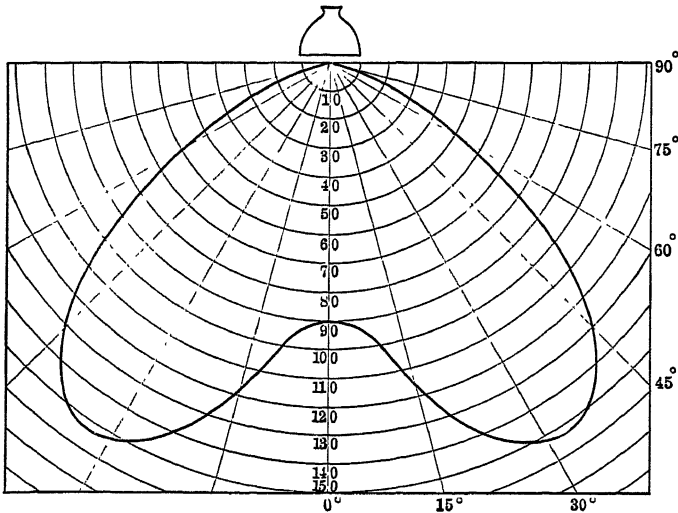

FIG. 55.—Vertical distribution curve, X-ray reflector No. 555.

The values are as follows:

Width of zones.....	5°	10°	15°	20°	30°
Value of K	0.548	1.098	1.64	2.18	3.25

Tabulating our calculations according to this outline we obtain the successive columns of Table 17. Wohlaue has called his specially prepared paper "Fluxolite" paper. It is ruled for polar coordinates and for rectangular coordinates. By means of this arrangement, the polar curve is plotted on the sheet and readings of successive $I_x \sin x$ products can be taken directly therefrom. It is illustrated in Fig. 56, using 15-deg. zones and a different flux curve.

¹ *Illum. Eng.*, vol. 3 (1909), p. 655; vol. 4 (1910), pp. 148, 491.

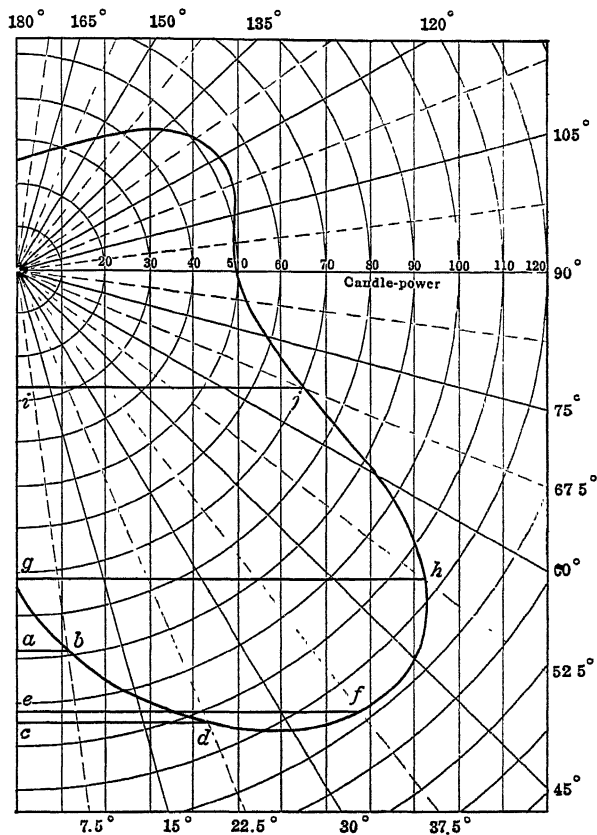

FIG. 56.—Flux-o'-lite paper.

TABLE 17.—FLUXOLITE CALCULATIONS

Mid-zone angle	Sine of angle	Candle-power	Product
5	0.0872	92.6	8.1
15	0.2588	117.0	30.3
25	0.4226	145.0	61.3
35	0.5736	153.0	87.7
45	0.7071	130.0	91.9
55	0.8192	79.6	65.2
65	0.9063	29.9	27.1
75	0.9659	6.3	6.1
85	0.9962	0.0	0.0
			377.7

1.098 (377.7) = 414, Total lumens from lamp and reflector.

The Rousseau Diagram.—The Rousseau Diagram is developed from the polar curve in such a way as to give an area proportional to the total flux emitted by the lamp. The semicircle is divided into equal parts of ten, fifteen, . . . or thirty degrees each, *A, B, C, . . .* Fig. 57. A series of lines are then drawn, *AP, BQ, CR, . . . NX*, from the ends of these radii of the reference circle, extending in a horizontal direction to a new vertical axis (*PX*). Measured upon these horizontal lines from the new axis there are laid off lengths equal to the candle-power vector connected with each, as *Pp* equals *Oa*, *Qq* equals *Ob*, etc. The complete curve is then drawn, *pqr . . . vwx*. The area enclosed between this curve and the axis *PX* is proportional to the total

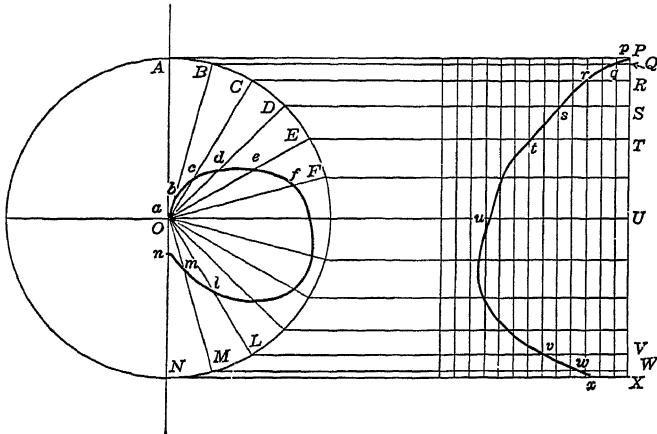

FIG. 57.—Elementary Rousseau diagram.

flux from the lamp, because each horizontal element of this area is the product between the candle-power emitted toward a certain zone and the difference between the cosines of the final and initial angles of the same zone (which limits appear if we integrate over the range of the zone). This product appears in the form,

$$l_x(\cos \beta_x - \cos \alpha_x),$$

where we are referring to the zone, *x*, with boundaries, α_x and β_x .

The area *UuxX* divided by the length *UX*, to whatever scale was used therefore, will give the mean lower hemispherical candle-power. Area *PpxX* divided by *PX* will give the mean spherical candle-power. Should the distribution curve differ for different meridians, it would be necessary to use some sort of a point-by-point method of summation over the whole sphere, because there is a varying illumination along any zone

and our outlined methods presuppose a symmetry in this respect. The "poke bonnet" reflectors must be studied in this latter way.

Fig. 58 shows a double Rousseau diagram, one curve being for the bare lamp, the other for the lamp fitted with a reflector. The lamp is a 500-watt mazda, with a clear globe, running at 1.00 watt per candle-power. The reflector is a Holophane D'Olier, No. ED-500, distributing type of steel reflector with porcelain enamel. It is to be noted that if the efficiency of the reflector is the information sought, the desired result may be obtained directly from the Rousseau areas, without proceeding to the mean spherical candle-power or the total flux of light. The results are tabulated.

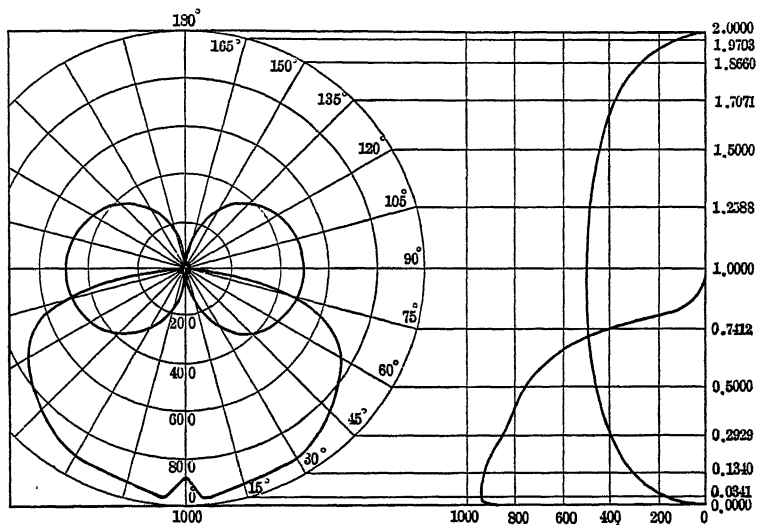

FIG. 58.—Double Rousseau diagram.

TABLE 18.—ROUSSEAU DIAGRAM
Efficiency of D'Olier Reflector, No. ED-500

Item	Bare lamp	With reflector
Rousseau areas.....	798	649.0
Efficiency of reflector, per cent.	81.1
M.S.C-P. (Area/2).....	399	324.5
Lumens.....	5010	4070.0
Maximum candle-power.....	500	970.0
Approximate direction of maximum, degrees.....	90	5.0

"A Set of Constants."—"A Set of Constants" has been presented by Barrows¹ for the direct calculation of mean spherical candle-power readings as usually tabulated. Applying the factor 4π , also, will carry the calculation to flux in lumens. The flux may thus be calculated for each zone or finally, for the sphere. There is no necessity for plotting any of the curves in order to carry out this process. Table 19 gives the multipliers to be used for either ten-degree spacing or fifteen-degree spacing. The initial and final factors in both columns have been halved so as to allow for only one-half of the zones centering at 0 deg. and at 180 deg., thus covering only a full semicircle and not extending beyond these limits. If it is desired to perform the calculation for a quadrant only, the constant for the angle 90 deg. must likewise be halved.

TABLE 19.—CONSTANTS FOR CALCULATING M.S.C.-P.

For 10 deg readings		For 15 deg readings	
Position of reading, degrees	Constant factor	Position of reading, degrees	Constant factor
0 or 180	0.001905	0 or 180	0.00428
10 or 170	0.01513	15 or 165	0.03378
20 or 160	0.02981	30 or 150	0.06526
30 or 150	0.04358	45 or 135	0.092295
40 or 140	0.05602	60 or 120	0.11304
50 or 130	0.066765	75 or 105	0.126075
60 or 120	0.07548	90	0.13053
70 or 110	0.08190		
80 or 100	0.08583		
90	0.08716		

The process of calculation by this method is easily understood by an examination of Table 20, which shows data for a magnetite arc lamp rated at 300 watts. Here, again, two curves are used, one for the bare arc and one for the lamp with reflector.

Absorption-of-light Method.—McAllister has proposed a very reasonable process of calculation of light flux under the above title. It is based upon the fact that all light emitted is eventually absorbed. Some of this absorption occurs when the direct flux first falls upon the wall or other object. Other parts occur only after one or more reflections. If, therefore, the absorption

¹ *Trans. I.E.S.*, vol. 4 (1909), p. 438.

TABLE 20.—CALCULATION OF M.S.C.-P. AND TOTAL FLUX
Using "Set of Constants." Magnetite Arc. With and Without Reflector

Angle, degrees	Bare			With reflector		
	C.-p.	Component of M.S.C.-p.	Lumens in zone	C.-p.	Component of M.S.C.-p.	Lumens in zone
0	110	0.2	2.5	110	0.2	2.5
10	120	1.8	22.6	120	1.8	22.6
20	155	4.6	57.8	155	4.6	57.8
30	260	11.3	142.0	400	17.3	217.3
40	430	24.1	303.0	670	37.5	472.0
50	690	46.1	580.0	930	62.1	780.0
60	850	64.2	806.0	1190	89.8	1129.0
70	935	76.5	966.0	1325	108.5	1364.0
80	995	85.5	1075.0	1355	116.3	1462.0
90	1060	92.4	1161.0	1200	104.5	1312.0
100	1085	93.2	1171.0	150	13.0	163.0
110	1050	86.5	1089.0	0	0.0	0.0
120	995	75.1	944.0	0	0.0	0.0
130	905	60.4	759.0			
140	650	36.4	457.0			
150	230	10.0	126.0			
160	0	0.0	0.0			
170	0	0.0	0.0			
180	0	0.0	0.0			
		768.3 M.S.C.-p.	9662.0 Lumens		555.0 M.S.C.-p.	6982.0 Lumens

characteristics of each illuminated object are known and the light flux falling upon each also is known, we can calculate the total flux emanating from the light source. Of course, a summation of all incident flux would give a figure greater than the flux emitted, by the amount representing the summation of the reflected light (single and multiple).

The coefficients of reflection may be obtained by measurement and the establishment of reference tables. The incident flux may be estimated from the measured or the required illumination.

As an example, take a room 20 ft. \times 35 ft. with a ceiling 12 ft. high. Suppose the ceiling is matte white with a coefficient of reflection of 0.80 (see White Cartridge Paper, Table 11). The walls are covered with medium light buff cartridge paper with coefficient of reflection 0.44. The floor and furniture being rather dark may have a coefficient of reflection as low as 0.07.

The required illumination will be secured if the light flux falling upon ceiling, walls and working plane is in each case respectively one foot-candle, three foot-candles and five foot-candles. These conditions establish results as follows:

TABLE 21.—CALCULATION BY ABSORPTION

	Area	Required illumination		Coefficient		Flux	
		Lumens, per sq. ft.	Incident flux	Reflection	Absorption	Reflected	Absorbed
Ceiling.....	700	1	700	0 80	0.20	560	140
Walls.....	1320	3	3960	0 44	0.56	1742	2218
Work plane..	700	5	3500	0.07	0.93	245	3255
Totals.....	8160	2547	5613

Table 21 shows a total absorption of 5613 lumens, which figure therefore, represents the necessary output of the lamps to be installed.

It will be observed, however, that the actual illumination is not limited to this "direct flux" of the lamp but is increased by the reflection of light to the extent of 2547 lumens. This gives a total of 8160 lumens incident upon the parts of the room, which flux affords the required illumination.

The truth of McAllister's suggestion will at once be appreciated, viz., that the above calculation does not imply that any set of lamps giving 5613 lumens would provide the illumination desired. This result must be secured by a certain definite distribution of that light flux in the room, the reflection must amount to that total indicated, etc.

Equilux Spheres.—In daylight illumination the skylight is often used. The same condition is frequently approximated in artificial illumination by the use of lamps above a diffusing transmitting screen, which screen is, in effect, the source of light flux. The solution of the problem¹ now is most simply attacked by recognition of the fact that the illumination at any given point of a plane is fully defined by means of (a) the emitting density of the source, (b) the solid angle subtended at the station by the

¹ McALLISTER, *Illum. Eng. Prac.* (1916 Lectures), p. 21, *et seq.* Also, *Electrical World*, vol. 56 (1908), p. 1356.

surface source, and (c) the angle between the normal to the plane and the average direction of light flux received at the point. This permits one to use for the actual or artificial window an equal circular area with the same flux emission. This case lends itself well to calculation by what McAllister has called "Equilux Spheres."

In Fig. 59 taken from McAllister's discussion, the line ACB is the edge of the circular source of light having a uniform emission density. We may state, then, that any sphere of which this plane circle is a section will have upon its interior uniform illumi-

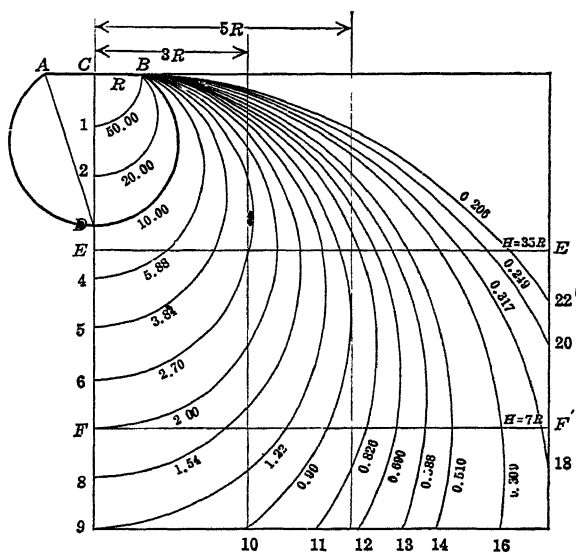

FIG. 59.—Equilux spheres.

nation; the density of the direct illumination will be the emission density multiplied by the square of the radius of the source circle and divided by the square of the distance from the edge of the circle to the opposite pole of the sphere. In the figure shown, the direct illumination on the interior of the circle ADB equals the emission density from the circle ACB multiplied by the ratio $\frac{AC^2}{AD^2}$.

This ratio develops from the geometry of the figure when we utilize the absorption-of-light method of calculation. The illumination is to the flux emission density as the area of the source is to the area illuminated.

The figure shows parts of a number of spheres constructed with zonal heights 1, 2, 3, . . . times the radius of the circle source. The figures upon the spheres give in percentages the ratio of $\overline{AC}^2/\overline{AD}^2$ and thus are the figures by which the emission density will be multiplied to give the illumination. Any plane section of the set of spheres will give section circles. Only on the condition of constant angle of incidence will a section circle be a contour line of constant illumination. Hence, the section circles on the floor or the working plane, being parallel to the source circle, will be illumination contours. The section circles on walls do not represent illumination contours.

The convenient relations of this method are not yet fully listed. For example, a study of the angles involved will show that the floor contour lines are illuminated to an intensity the same as that of the equilux sphere giving this circle upon the floor. In Fig. 59 at the point upon the floor numbered 16, the illumination will be 0.309 per cent. of the emission density.

As for the wall illumination, choose any point upon the wall and pass through it a plane parallel to the floor. Measure the perpendicular distances (a) from center of light source to wall plane, and (b) from source plane to auxiliary parallel plane above indicated. Take the ratio of these distances (a) to (b). The illumination normal to the wall is the equilux sphere illumination at that point multiplied by this ratio.

CHAPTER XII

SHADES AND REFLECTORS

(Light-flux Modifiers)

Control of Flux of Light.—The light sources of today, used unmodified by shades, globes or reflectors, would constitute as great a crime against the eye as can easily be thought of. To be sure, the same indictment might have been made at any time within recent years, but it is a more severe and far-reaching charge today than ever before. The fundamental rule may be stated that no modern illuminant shall be installed without some auxiliary device to modify its natural light flux in distribution, diffusion, intensity or color—one or more. Not alone does the eye require this concession to its comfortable performance of its duties, but so also is the demand made for the sake of efficiency, good taste, etc. The fact further develops that some of the commercial products offered for this estimable service are wholly unfit for use and a little serious consideration given to them quickly relegates them also to the criminal class.

It is, therefore, a matter of prime importance to know what a shade or reflector should do and what it will do in the particular case being considered; what type of service it is designed to give (if *designed* at all); how it should be installed; with what size or type of lamp it should be used; its deterioration, maintenance, etc.

Shades, Globes, Reflectors.—Speaking specifically, a shade is intended to cut off all or a part of the light flux leaving the source in a certain direction. Similarly, a reflector is installed to change the distribution of the flux by redirecting it to a more needy zone. A globe is used to change the diffusion of the light, its intensity or color. Practically, however, these several functions are so intermingled, all of them being considered in connection with any case, that there is no distinct line drawn between any two of them. For example, an amber bowl may be used to reflect much of the light toward the ceiling, while it is designed to trans-

mit and diffuse a minor portion of it with a warm, pleasing tone.

Materials used include metals, glassware, porcelain, and even paper and cloth.

Metals used in this way give durability and rigidity although the surfaces may deteriorate so that efficiency suffers. As a consequence, reflecting metal surfaces are generally protected by transparent coatings of varnish, lacquer or enamel. These coverings must be lasting and must not crack or soil easily. Nontransparent coatings of enamel or paint are also used in establishing permanent effective surfaces.

The metal reflector with aluminium finish is made in a wide range of design. It is not well adapted to outdoor work in which place the enameled steel reflector may better be used. Control of light may be fairly accurate with the former, unless the surface is especially designed for diffusing.

Glass is a very adaptable and satisfactory material for the purposes being considered. To rigidity and durability, it adds permanency of surface polish, of transmission or of diffusion. It may be worked or formed with ease. Color, degree of transparency, etc., are under control. Even its inherent brittleness can be overcome to a surprising extent. The glass used in the front of a flood-light unit will not break in a rain or sleet storm, although it has a very high temperature.

It is of interest to note that "glass" is manufactured in several different forms.¹ The glass used for prismatic effects is a clear, crystal flint glass (much less brilliant than that used for "cut glass"). When the glass carries a homogenous coloring or non-transmitting material, it is called opal glass. It is sometimes used in a uniform homogenous body and sometimes covered on one or both sides by a layer of somewhat different characteristics. It is then said to be "cased" glass. Again, when there are suspended in the body of the glass, particles which affect the light transmission, we have the "alabaster" glass. This is an extremely satisfactory material to the designer, because of the wide control permitted in diffusion, transmission, etc.

Porcelain may be classified with glass in many respects. It has not the transparency of the glass, however. It is much used

¹ *Illum. Eng. Prac.* (1916 Lectures). "Modern Lighting Accessories," LITTLE, p. 186. Manufacturing processes as well as optical properties are here also described.

as are also some lower forms of pottery. Bowls are very frequently made of these materials. In general, however, the reflecting surface is prepared by use of other materials.

Paper and cloth are of more importance as shades than in any of the other capacities mentioned. They are used where color, decorative unity, etc. are of major import.

Absorption and Reflection of Light.—It is said that the ordinary clear glass will absorb about 3 per cent. of the light per inch of penetration. A minimum of 4 per cent. of the incident flux is reflected upon entering ordinary plane glass at right angles and the same percentage reflection occurs upon leaving it. This reflection changes with the angle of incidence. Little (ref. cited) gives tables comparing reflection, transmission and absorption for numerous materials, with variously prepared surfaces. The data for glassware are interesting, covering a large number of com-

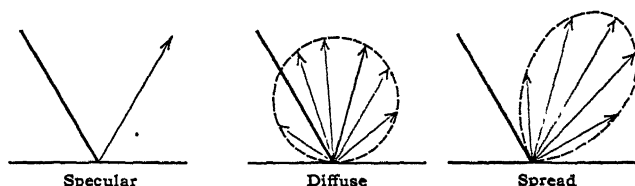

FIG. 60.—Types of reflection.

mercial samples of varying densities. As may be expected, the results cover a very wide range in transmission as well as in reflection.

Reflectors.—The simplest case to be considered is that of the plain reflector. This constitutes an opaque reflecting body placed in the field of light in such a position that the light is thrown to an active region, becoming thereby, more useful. The reflection may be specular, spread or diffuse. Each of these types of action is illustrated in Fig. 60. The result attained depends upon the reflecting surface. Applying some of the facts stated in the discussion of light, specular reflection occurs when light falls upon a highly polished surface such as a smooth glazed reflector. An image of the source is produced and the efficiency of the reflection may be high. Diffuse reflection occurs when the surface is not polished but is formed of a multitude of finely irregular particles such as a matte-surfaced reflector. Spread reflection lies between these two extremes and is found with

glass having a sand-blast surface, etc. Intermediate conditions and combination effects are usual, giving, sometimes, a diffuse reflection curve with a specular maximum of several times the average intensity. As also already pointed out in our discussion of light, the amount of light reflected varies widely with the different surfaces and is frequently much affected by this surface in respect to color. This is true even for specular reflection as can be seen by looking into the acute angle formed between two bright sheets of copper, where the cumulative effect of multiple reflection is quite pronounced.

Good efficiency in a reflector requires a high coefficient of reflection. This reflection must not be much affected by color selection. Unless the reflecting surface is hidden from the eye or displaced from the field of vision, it should be diffusing, rather than specular. The distribution curve of flux must be so altered as to satisfy the requirements. Any highly polished white surface, such as glass or silver, will give a high reflection constant. Aluminium will also give good results, as will enamelled and clear white surfaces in general.

Specular reflectors are generally mirrors, polished metals or prismatic glassware. Their chief characteristic is that they lend themselves well to an accurate control of the light. The action being regular, the result is well under control, and pronounced results are effected in concentration, symmetrical, or asymmetrical. With small light-giving elements, this control becomes accurate. Distribution is disturbed considerably by a change in position of the lamp within the reflector.

Diffuse reflection is obtained in general by opaque glass, white or tinted, and painted or enamelled surfaces. Owing to their irregularities these materials disperse the light widely and may not be used for accurately predetermined flux curves, or any kind of concentration. Slight changes in shape do not alter the distribution greatly, nor does a small change in the position of the lamp.

Spread reflection, lying between these other two, is secured from the satin finished surfaces of glassware or metal, the former material being prepared by sand-blast, the latter by a coating of aluminium. Change in shape and relative lamp position are effective intermediately between the other types.

The Design of Reflectors.—The design of reflectors is more simple and direct for use with the concentrated filament lamp

of the Type *C* mazdas than for application to the extended filament type of earlier date.

In general, in passing upon the efficiency of the design, aside from the materials used, we should remember that the reflector is expected to modify the flux distribution so that it may conform to a desired condition; multiple reflections increase losses; mis-directed light may be trapped and not find egress at all; diffuse reflection does not permit exact control; the greater the modification produced, the greater the losses.

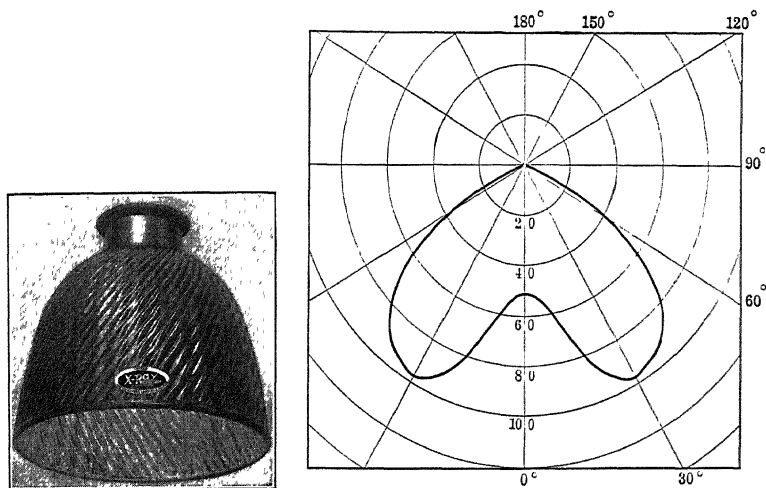

FIG. 61.—X-ray reflector, No. 555 and its distribution curve with 40-watt lamp.

Typical of what effects may be secured and the forms of the reflectors giving these results, several figures are shown. Many other enlightening and suggestive illustrations can be found in trade catalogs as well as in current literature and proceedings of various societies.¹

Distributing or Extensive Types.—Fig. 61 shows what use may be made of a small distributing type of mirrored reflector. It consists of an undulating glass body, coated upon the outside with pure silver, backed by a green paint for protection. This

¹ *Trans. I.E.S.*, as follows: "Prismatic Globes and Reflectors" (LANSINGH), vol. 2 (1907), p. 371; "Scientific Principles of Globes and Reflectors" (LANSINGH), vol. 5 (1910), p. 49; "Symposium on Electric Lighting," vol. 6 (1911), p. 854; "Metal Reflectors for Industrial Purposes" (ROLPH), vol. 8 (1913), p. 268; "Reflection Efficiencies" (CRAVATH), vol. 9 (1914), p. 42.

reflector is No. 555 made by the National X-ray Reflector Co. and has the general dimensions—diameter, 6.375 in.; height, 5.125 in. It is designated as being adapted to the lighting of work tables, benches, counters and for general illumination of rooms or corridors having low ceilings. Being translucent, all light is confined to the lower hemisphere, very little of it reaching the 60-deg. line. The maximum for a 40-watt lamp is at the 30-deg. line and amounts to over 94 candle-power. This reflection is specular and hence, as already pointed out, a slight change in shape or of the lamp position inside it will alter the

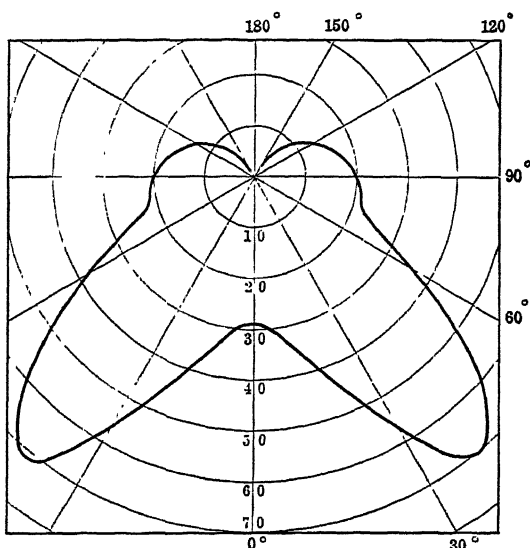

FIG. 62.—Distribution curve for Holophane reflector XE-40, with 40-watt lamp.

distribution rather widely. For concentrated filaments as in mazdas of Type *C*, the undulations of the reflector must be more finely designed.

A very similar light flux is secured by a prismatic Holophane reflector, XE-40, with a clear, 40-watt mazda lamp as shown in Fig. 62. The principle upon which this and like reflectors work is very interesting. It is simply an application of the total reflection of a beam of light by a prismatic surface when the angle of incidence is in excess of a certain value. The light coming to the surface of the reflector (*AB*, Fig. 63) will enter the body of the glass, as at *C*, *D* and *E*. Any of these rays which strike the

prismatic faces will suffer reflection as at *H*. A second reflection occurs at *J* and the ray returns as at *K*. The redirected light is thus added to the light emitted in the useful directions. A minor portion of the light passes through the reflector by meeting it at angles which do not cause reflection. Thus, the back of the reflector does not appear dark. Holding such a reflector toward the observer, having a lamp in place therein but capped so as to cut off direct rays to the eyes, one can appreciate the results of these prismatic effects by observing the silvery appearance of the back surface of the glass as seen from the inside. The intensity of this light and the distribution of it may both be studied in a casual way by moving from side to side and watching the resulting changes.

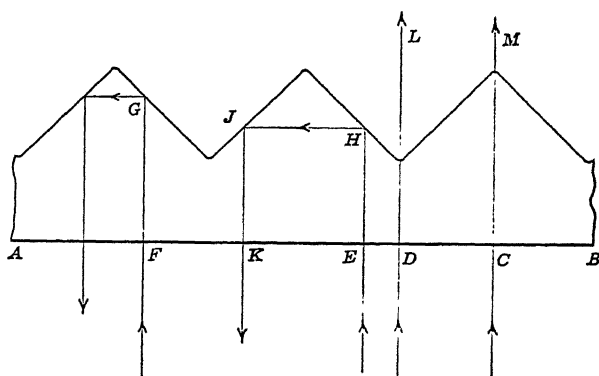

FIG. 63.—Principle of prismatic reflector.

Intensive Type.—By properly designing the shape of reflector body and the prisms, the distribution of light may be fully controlled. For example, returning to Fig. 62, we see a rather wide distribution of light. Quite an appreciable amount passes through the reflector to the ceiling. The intensity in a horizontal direction is 20 c.-p. The maximum occurs at about 40 deg. amounting to over 70 c.-p. The value diminishes toward the vertical, becoming about 29 c.-p. directly under the lamp. Of the total 356 lumens emitted by the lamp, there remains some 316 lumens in the modified flux. This gives an efficiency of shaded lamp of 88.4 per cent.

Now, redesigning the reflector we may find the result of Fig. 64, in which we are using the same 40-watt lamp, but the reflector is a Holophane XI-40. The upper hemisphere still receives a

small amount of light while the position of the maximum has been depressed to the 25-deg. line. Its value has increased to 75 c.-p. The most noticeable change is in the region directly under the lamp. Here, the intensity has increased to 65 c.-p. Throughout the nadir zone extending 35 deg. from the pole, the intensity is in the vicinity of 70 c.-p. The efficiency of this distribution is 87.5 per cent., with a sustained flux of 313 lumens.

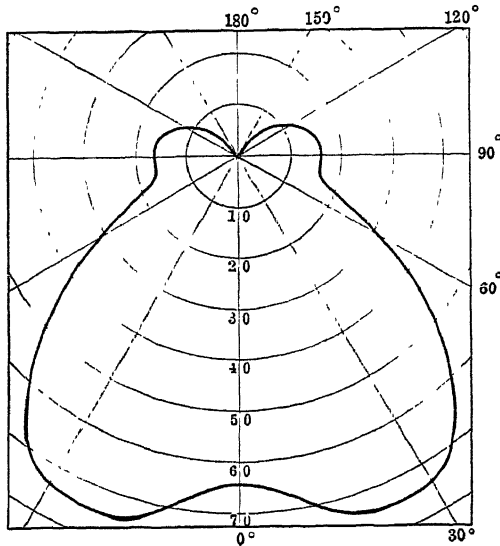

FIG. 64.—Distribution curve for Holophane reflector XI-40, with 40-watt lamp.

Focusing Type.—Again, choosing a reflector known as the Holophane XF-40, the light flux follows the curve of Fig. 65. The changes of the preceding type are carried further and the maximum intensity of 182 c.-p. is secured at the nadir pole. The value decreases rapidly as the angle increases from zero, only about 45 c.-p. being found at the point of the first maximum, namely, 40 deg. The efficiency is well-maintained, still standing at 87.5 per cent.

A study of these figures reveals that high efficiency may be retained with the use of reflectors proper for the situation; the control of the light flux is excellent. The three reflectors used in the tests are shown in Fig. 66, where it will be seen that the changes resulted from *seemingly* small variations in the form of the glassware. The conclusions are obvious. The use of a bare

lamp is a crudity. A reflector, when used, should not be chosen till its distribution curve for the case in question is known to accord with the desired results, when applied to the lamp in question. This is more important than ever, now that incandescent lamp filaments differ so widely in form and concentration.

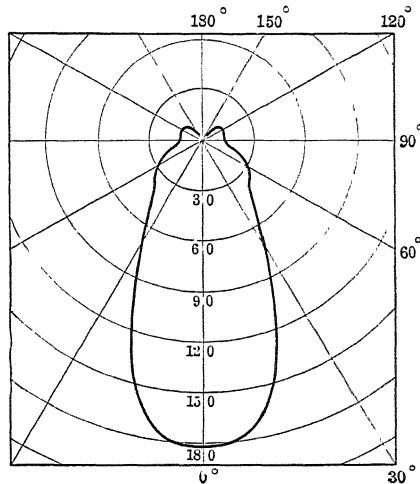

FIG. 65.—Distribution curve for Holophane reflector XF-40, with 40-watt lamp.

The projecting reflector¹ is carried to its extreme in the demand for such special service as search lights, headlights, etc. Floodlights also exhibit the same features. In these types the beam

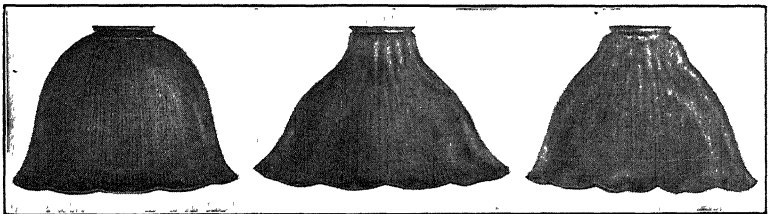

FIG. 66.—Holophane reflectors (left to right) XE-40, XF-40 and XI-40.

is made to approach the parallel-ray efflux, by use of an unaided parabolic reflector or a combination of reflectors and Fresnel lenses. This has become a very important phase of illumination

¹ "Light Projection," by EDWARDS & MAGDSICK, *Illum. Eng. Prac.* (1916 Lect.), p. 216.

and the accessories developed for it cover a wide range of application.

Varieties Available.—As indicated above a great variety of reflectors is available, types being designed for all kinds of service. A study of trade catalogs is recommended to the student as this is the only way of finding the latest literature upon the subject. This material must be read with discrimination, however, bearing in mind the fundamentals of design, construction, etc. The particular application of each unit is to be considered, for a reflector misplaced is often worse than none at all. Asymmetrical distribution is adapted to the lighting of show windows, show cases, etc. Intensive or focusing types are required for local lighting. Extensive types are to be used for general illumination with fairly high ceilings. Metal construction is to be preferred if there is danger of frequent breakage, as in shops, etc. It is cheaper both in first cost and maintenance. Metal reflectors do not require so much attention in keeping them clean nor is collected dust as destructive to their efficiency. This does not imply that they may be left heedlessly to accumulate dirt, for only a clean reflector will do what is desired of it.

Shades.—It is not difficult to see that much which has been said in reference to reflectors may be applied in whole or in part to shades and enclosing glassware. A shade, in fact, should always be a reflector rather than an absorbent or efficiency suffers. Considered alone from the standpoint of a barrier to light, the illuminating engineer has practically no use for the shade. It may, therefore, be thought of as being between the reflector and the globe in its characteristics.

Globes.—Enclosing glassware modifies the flux of light which passes through it by refraction and diffusion. Prismatic globes and shades are constructed with clear glass, the surfaces being so designed that the light is redirected into the desired regions. Figs. 67 and 68 show the principle of this action, which is effected by both internal and external prisms. In Fig. 67 there is shown the form of the inner surface of some of the types. These ribs, when used, run longitudinally upon the surface and a ray of light striking upon any part is broken up by partial reflection and transmission. Light striking the point *B* will be partially reflected to *E*, with transmission to *F, G*. The refracted component, however, is bent to the opposite side, *C, D*, as it proceeds through the material and enters space. Other rays impinging upon the

surface at different points (as *K*) will be similarly affected although the directions will not coincide. Another beam falling upon the same point, *B*, but coming from a different direction will be scattered in still different directions. This accounts for a very wide diffusion of the light longitudinally.

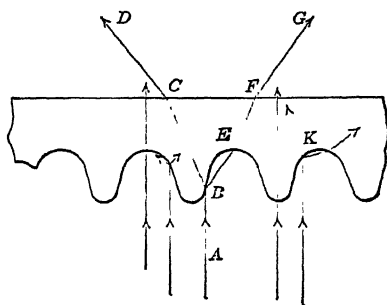

FIG. 67.—Principle of prismatic globes and shades—inner surface.

Upon the outer surface of the globe, the prisms are more angular in shape and run latitudinally around the unit. In Fig. 68 a sheaf of rays (*AX*) enters the body of the globe and each element is refracted. A portion of this light reaches the outer surface at *E* and is bent downward as it leaves the glass. Other

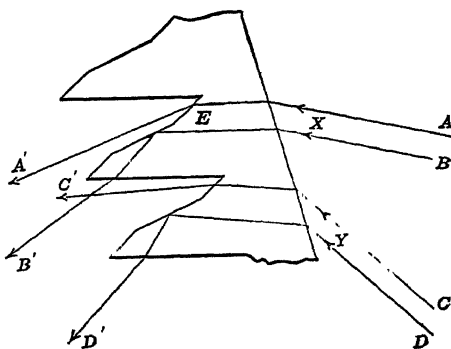

FIG. 68.—Principle of prismatic globes and shades—outer surface.

parts of the light experience single or double reflection and final refraction, but all surfaces are so disposed as to give a very decided downward tendency to the flux. It appears at once that the successive prisms of this series must be differently shaped, each one being at a different elevation from the light. In fact,

near the top of the globe, the net downward bend must be large, while near the bottom, a general diffusion is to be accomplished.

Glassware.—This prismatic glassware is very carefully designed in every detail and must be used understandingly. If the lamp is put in a wrong fixture, leaving it at the wrong elevation in the globe, the beautiful control of flux is deranged. Cleanliness is necessary. The design is used also to establish

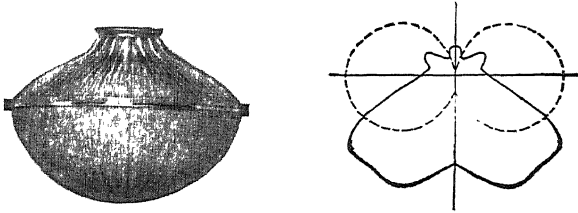

FIG. 69.—Twelve-inch prismatic reflection-bowl and distribution curve.

asymmetrical distribution of light from a wall fixture. By means of it the greater portion of the light is thrown out into the room, rather than casting equal parts upon wall and objects, giving a glare from the wall.

Translucent glass¹ is also used in the construction of shades and globes. Opal glass, ground glass, and white and tinted glasses are very common. They alike act to diffuse the light and they vary in transparency quite widely. Some are so thin

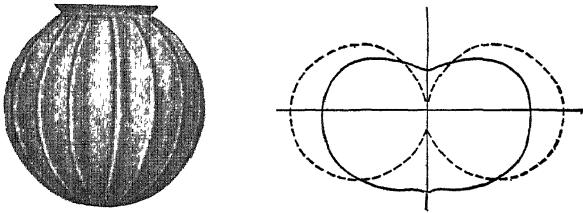

FIG. 70.—Opal bowl and distribution curve.

that it is easy to see the incandescent lamp inside them. This, of course, is a failure to shade, and such devices should be avoided. Practically no control is had over the light distribution by these units and where this is necessary or desirable the prismatic units or reflectors must be employed. The absorption for both types of globes runs about alike, lying between 15 per cent. and 30 per cent.

¹ *Trans. I.E.S.*, vol. 6 (1911), pp. 838, 854; vol. 8 (1913), p. 447; vol. 9 (1914), p. 220.

Typical of what may be done with such glassware, there are shown three curves taken from one of the references cited. Fig. 69 gives the distribution curve for the prismatic reflector-bowl combination shown at the left. The solid line refers to the modified flux, while the dotted line indicates the flux from the bare lamp. The efficiency is 72.3 per cent.

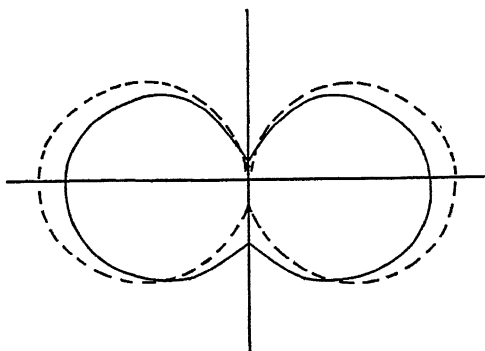

FIG. 71.—Distribution curve for ground-glass ball.

In Fig. 70, is seen the curve for a one-piece, blown, opal ball. The distribution of light is altered somewhat from that for a bare lamp, but there is a very appreciable difference between this and the earlier illustration. The efficiency is 86.4 per cent.

Finally, Fig. 71 gives the results for a 12-inch, ground glass ball. It will be seen that the change in distribution is quite small. The efficiency in this case is 90.3 per cent.

CHAPTER XIII

ILLUMINATION CALCULATIONS

When one is called upon to design an installation for the satisfactory illumination of a given room or plat, there are certain steps which he must take in developing his calculations logically. The questions which he must answer may be presented in the following order.

1. How much illumination is required?
2. How much effective light flux is required in order to give this illumination?
3. What is the total number of lumens output of the lamps?
4. What total power rating will be needed?
5. In what manner shall this total power supply be divided up among numerous units and how shall these units be distributed?

Before discussing these points singly, it will be well to point out that ordinarily they may be attacked in the order presented, as shown below.

(a) The amount of illumination required is determined from tables classifying the needs for different purposes.

(b) The average illumination, in foot-candles, and the area to be lighted give data for calculating the effective number of lumens required.

(c) With the effective number of lumens given, the number of lumens output of the light source will depend upon the kind of lighting system used (direct or indirect, etc.) and the kind of fixtures used. The ratio of effective lumens to total output may be called the efficiency of utilization.

(d) The power requirements for a predetermined lumen output depends upon the efficiency of the lamps.

(e) Choice of size and number of lamps will be fixed by the distribution desired and the physical features of the area to be lighted. This determination is a matter of trial and experience.

Illumination Requirements.—As a result of a large number of tests which have been made in all kinds of rooms and for all kinds of outdoor service, we are well provided with tables giving the amount of illumination needed for every different kind of service.

Table¹ 22 summarizes these statistics and represents the foot-candle illumination (lumens per square foot) required for good lighting. The figures are only average values and must be adjusted to fit individual cases. Excess light may be needed at various points in any particular instance, as for reading lamps in a library. The demands of various persons are not all alike, either, and one must consider the personal equation in solving this problem. It may be noted that standard tables of this sort are showing gradually increasing values.

Among the indoor installations requiring the least illumination, we find halls, corridors, moving picture theaters, store rooms, nightlights, etc. In these places, from 0.25 to 1.00 lumens per square foot will give good results. In fact, in rooms where local lighting is provided, the general illumination may be somewhere near this same figure. As one would expect, outdoor lighting does not ordinarily reach so high a value. The lighting for streets varies from 0.1 to 0.6 lumens per square foot, depending upon the importance of the location. It is hardly necessary that parks should be equally well-lighted, except in the more frequented portions. From these conditions the demands rise very materially when we consider such places as tennis courts or shooting traps. In these latter cases we have lighting which compares very favorably with that for the more exacting interiors. Higher values are reached, however, in connection with such occupations as demand both speed and precision in delicate and particular work. This is seen in type-setting and surgical operations. Display windows are still more brilliantly illuminated, depending upon the color of the goods to be shown. Here the darker and more absorbent wares demand as high values as from 30 to 50 lumens per square foot. This is necessitated by the fact that a show window must attract attention. It is not enough that it is well enough lighted to permit an easy examination of the goods displayed. The brilliancy of the window must draw one toward it from a distance and command response. Competition makes this need an increasing one. In only one other situation is the phase of compelling attractiveness so fundamental, and that is the case of the electric sign. There, brilliancy alone is not depended upon for the result, but it plays a large part in connection with the other elements, such as color, flashing, etc.

¹ With numerous variations, taken from "Light, Photometry and Illumination," BARROWS. Compare Ohio Industrial Lighting Code.

TABLE 22.—INTENSITIES OF ILLUMINATION RECOMMENDED FOR VARIOUS CLASSES OF WORK

Armory or drill hall.	1 3 - 2 0	Factory:	
Art gallery walls .	3 0 - 5 0	Planers	3 0 - 5 0
Auditorium .	1 0 - 3 0	Rough manufacturing	1 25- 3 0
Automobile showroom	3 0 - 5 0	Fine manufacturing	3 5 - 6 0
Baggage room	0 5 - 1 5	Special cases of fine work	10.0 -15 0
Ball-room .	2 0 - 3 0	Fire station:	
Bank. . . .	3 0 - 4 0	Times of alarm	2 0 - 3 0
Barber shop	2 0 - 4 0	Other times . . .	1 0 - 1 5
Billboard .	4 0 - 6 0	Forge and blacksmithing.	
Billiard room	0 5 - 1 0	Ordinary anvil work	2.0 - 4 0
Table	4 0 - 5 0	Machine forging .	2 0 - 3 0
Book binding:		Tempering.	2 0 - 4 0
Cutting, punching, stitch-		Tool forging.	3 0 - 5 0
ing .	3 0 - 5 0	Foundry:	
Embossing	4 0 - 6 0	Bench moulding . . .	1 0 - 3 0
Folding, assembling,		Floor moulding . . .	1 0 - 2 0
pasting	2 0 - 4 0	Garage.	1 5 - 2 0
Bookkeeping .	3 0 - 5 0	Garment industry:	
Bowling:		Light goods	5 0
Alley .	1 0 - 1 5	Dark goods	7 0
Pins	4 0 - 5 0	Glove factory:	
Box factory	2 0 - 4 0	Cutting	5 0 - 6 0
Cafe.	2 0 - 4 0	Sorting	6 0 -10 0
Candy factory	2 0 - 4 0	Gymnasium	2 0 - 4 0
Canning plants:		Hall, concert and enter-	
Coffee roasting at tables	3 0 - 4 0	tainment	2 0 - 4 0
Filling tables	1 0 - 1 5	Hat factory:	
Packing tables	1 0 - 2 0	Blocking	4 0 - 6 0
Packing (dried fruit)	1 5 - 2 5	Forming	3 0 - 5 0
Preserving cauldrons	2 0 - 2 5	Stiffening	2 0 - 4 0
Pressing tables	1 0 - 1 5	Hospital:	
Shipping room	1.5 - 2 5	Corridor.	0 5 - 1 5
Carpenter shop		Operating table	8 0 -20 0
Fine work	3 0 - 5 0	Wards, general	1 5 - 2 0
Rough work	2 0 - 4 0	Wards, with local illumi-	
Cars:		nation	0 5 - 1 0
Baggage. . . .	1 0 - 1.5	Hotel:	
Day coach	2 0 - 3 0	Corridor	0 5 - 1.0
Dining	2 0 - 3 0	Dining room	2 0 - 3 0
Mail.	4 0 - 6.0	Bedroom	1 0 - 2 0
Pullman	2 0 - 3 0	Lobby	1 5 - 2 0
Street	2 0 - 3 0	Parlor.	2 0 - 3 0
Cotton mill weaving.	2 0 - 4 0	Writing room	2 0 - 3 0
Courts:		Jewelry manufacturing	3 0 - 8 0
Handball	5 0 - 8 0	Knitting mill. . . .	3 0 - 6.0
Tennis.	5 0 - 8 0	Laboratory	3 0 - 5 0
Courtroom. . . .	2 0 - 3 0	Laundry.	3 0 - 5.0
Church	2 0 - 3 0	Leather working.	
Dairy or milk depot	2 0 - 4 0	Cutting	4 0 - 6.0
Desk.	2 0 - 5 0	Grading.	6 0 - 8 0
Drafting room. . .	5 0 -10 0	Library:	
Electrotyping. . .	3 0 - 6 0	Stack room	1 0 - 2 0
Factory:		Reading room, no local	
General illumination.	1 0 - 2 0	illumination	3 0 - 4.0
Bench illumination	1 5 -10 0	Reading room, with local	
Assembling . . .	4 0 - 7 0	illumination	0 5 - 1 0
Drills.	2 0 - 4 0	Lodge room.	1 0 - 3 0
Millers.	3 0 - 6 0	Lunch room.	2 0 - 3.0

TABLE 22.—Continued

Machine shop:		School:	
General	1 0 - 1 5	Cloak room	0 5 - 1 0
Local	3 0 - 4 0	Corridor	0 5 - 1 0
Market	2 0 - 3 0	Drafting	5 0 - 10 0
Meat packing.		Drawing	4 0 - 6 0
Cleaning	2 0 - 3 0	Gymnasium	1 0 - 5 0
Packing	2 0 - 4 0	Laboratory	3 0 - 5 0
Museum	3 0 - 4 0	Manual training	3 0 - 5 0
Offices:		Office	2 0 - 3 0
General	3 0	Study room	3 0 - 5 0
Private	1 0 - 3 0	Sheet metal shop.	
Packing and shipping		Assembling	2 0 - 4 0
Ordinary work	2 0 - 3 0	Punching	3 0 - 6 0
Fine work	2 0 - 5 0	Shoe shops:	
Paint shop:		Bench work	2 0 - 5 0
Coarse work (first coat)	2 0 - 3 0	Cutting	5 0 - 7 0
Fine work (finishing)	4 0 - 8 0	Shooting traps	8 0 - 10 0
Passageways	0 25 - 0 5	Show windows:	
Pattern shop	4 0 - 6 0	Light goods	5 0 - 20 0
Power house:		Medium goods	20 0 - 30 0
Boiler room	0 8 - 1 5	Dark goods	20 0 - 50 0
Engine room	2 0 - 3 5	Sign	4 0 - 6 0
Pottery:		Silk mill.	
Grinding	1 0 - 2 0	Finishing	3 0 - 5 0
Pressing	2 0 - 4 0	Weaving	4 0 - 10 0
Postal service	4 0 - 6 0	Winding forms	2 0 - 4 0
Preserving plant:		Spinning mills	1 5 - 3 0
Cleaning	2 0 - 4 0	Stable	0 5 - 1 5
Cooking	2 0 - 3 0	Station:	
Printing:		Platform and trainshed	1 0 - 2 0
Presses	3 0 - 5 0	Waiting room	2 0 - 3 0
Type-setters	6 0 - 8 0	Steel work:	
Public square	0 5 - 1 0	Blast furnace (cast house)	0 3 - 0 5
Reading:		Loading yards (inspection)	0 3 - 0 5
Good print	2 0 - 3 0	Mould, skull cracker and ore yards	0 1 - 0 3
Fine print	3 0 - 5 0	Open hearth floors (soaking pits and cast house)	0 1 - 0 3
Residence:		Rolling mills	1 0 - 2 0
Bathroom	2 0 - 3 0	Stamping and punching sheet metal	2 0 - 5 0
Bedroom	1 0 - 2 0	Stock room	1 0 - 2 0
Dining room	1 0 - 2 0	Threading floor of pipe mills	1 0 - 2 0
Furnace room	0 5 - 1 0	Transfer and storage bays	0 5 - 1 0
Hall	0 5 - 1 0	Unloading yards	0 2 - 0 5
Kitchen	2 0 - 3 0	Warehouse	0 5 - 1 0
Laundry	2 0 - 3 0	Stereotyping	3 0 - 5 0
Library	2 0 - 3 0	Stock rooms:	
Music room	2 0 - 3 0	Rough materials	1 0 - 3 0
Night light	0 1 - 0 25	Fine materials	2 0 - 4 0
Pantry	2 0 - 3 0	Storage	0 25 - 0 5
Parlor	2 0 - 3 0	Store:	
Porch	0 2 - 0 5	Art	4 0 - 5 0
Reception room	1 0 - 2 0	Bakery	2 0 - 3 0
Sitting room	2 0 - 3 0	Book	2 0 - 4 0
Store room	0 5 - 1 0	Butcher	2 0 - 4 0
Restaurant	2 0 - 4 0	China	2 0 - 4 0
Rink, skating	2 0 - 3 0		
Rug rack	10 0 - 15 0		
School:			
Assembly room	2 0 - 4 0		
Blackboards	3 0 - 5 0		
Class room	3 0 - 5 0		

TABLE 22.—Continued

Store:		Store:	
Cigar.....	2 0 - 4 0	Tailor.....	4.0 - 8 0
Clothing.....	4 0 - 8 0	Tobacco.....	2 0 - 3 0
Cloak and suit ...	4 0 - 8 0	Street:	
Confectionery. . .	2 0 - 4 0	Business	0 4 - 0 6
Decorator	2 0 - 4.0	Residence	0 1 - 0 2
Drug.	3 0 - 5 0	Prominent residence.....	0 2 - 0 4
Dry goods.	4 0 - 6 0	Studio.....	4 0 - 6 0
Florist.....	3 0 - 5 0	Telephone exchange	3 0 - 4 0
Furniture.	4 0 - 6 0	Theater:	
Furrier.....	4 0 - 6 0	Auditorium.	2 0 - 3 0
Grocery.....	2 0 - 4 0	Lobby.	2.0 - 3 0
Haberdasher.....	3 0 - 5 0	Moving picture	0 25- 0 5
Hardware	4 0 - 5 0	Warehouse	1 0 - 1 5
Hat.....	4 0 - 5 0	Weaving:	
Jewelry.	4 0 - 5 0	Light colors	2 0 - 3 0
Lace	3 0 - 4 0	Dark colors.....	4 0 -10 0
Leather.	4 0 - 5 0	Wharf.	3 0 - 5.0
Meat	2 0 - 4 0	Wire drawing:	
Men's furnishings ...	3 0 - 5 0	Coarse.....	2.0 - 4 0
Millinery	4 0 - 8 0	Fence machines.....	2 0 - 5.0
Music.....	3 0 - 4 0	Fine	4.0 - 8.0
Notions.	3 0 - 4 0	Woolen mill:	
Piano.....	4.0 - 5 0	Picking table	2.0 - 4 0
Post cards.....	3.0 - 4 0	Twisting.	2 0 - 3 0
Shoe.....	3 0 - 4 0	Warping	3 0 - 5 0
Stationery.	3 0 - 4 0	Weaving	4 0 -10 0

Effective Flux.—When we have determined the average value of the illumination required by our working plane, a very simple calculation will give the total number of lumens which must be effective to produce this result. Inasmuch as the required illumination is expressed in foot-candles which means lumens per square foot, the total area of the working plane multiplied by the constant taken from Table 22 will give the total number of lumens which must reach the working plane. As is at once seen, this may be considered in the light of an absolute requirement, wholly independent of the kind of lamps used, their fixtures, the walls, or any other influencing agency.

Lumens Output of Lamps.—When, however, we come to the step of determining the total flux output of the lamps, consideration must be given to all of the intermediate influences between the point where light flux is emitted, and the place where this flux is to be used. The question is, "How much of the total output of the lamp is to be counted as effective?"

Consider, first, the case of a bare lamp of any type desired, placed above an open-air platform, where roof and walls are absent. It is evident that only that part of the light flux which

is naturally directed downward will reach the working plane. All other light is lost in space. Even that flux which is emitted at an angle near the horizontal will be valueless, for it reaches the plane at such a great distance from the source of light as to be of negligible effect. The specific angle at which the effect becomes too small to be taken into account depends upon the amount of light which is needed and the amount of flux which is actually sent out in the direction being considered. With all bare illuminants, the loss is excessive and it is largely avoidable by the use of reflectors. Hence we are enabled to increase the efficiency of our installation with small cost. It is proper, therefore, for us to make our calculation for outdoor work (*i.e.* no walls, etc.) upon the basis of a lamp with all of its required accessories. In fact, flux distribution curves are plotted, not for the bare lamp, but for the lamp with its globe, reflector, etc. The problem now becomes simple and capable of a straight forward solution. Although the redistribution of light has been accompanied by a loss in total lumens, the operating or utilization efficiency has been increased.

Ceilings.—A ceiling is an effective reflector if it has a light tint. When it is white, according to the table of reflection coefficients, it may be expected to return as much as 70 per cent. to 80 per cent. of the incident light. With tinted papers the percentage reflected is much less, lying in the range from 25 per cent. to 50 per cent. The direction in which this reflected light is given off may not result in having it all reach the working plane. If there are no walls to be considered, or if they are present but dark colored, it is not proper to count upon a very high percentage return from ceiling alone, unless it is practically white and presents diffuse reflection.

It is perfectly feasible to make use of the ceiling in connection with the indirect methods of distribution. Still considering no walls, the composite efficiency of utilization of reflector and the ceiling for widely extended working planes is probably in the neighborhood of 0.35–0.40. This implies the use of the best silvered reflectors in directing the light to a white ceiling.

Walls.—Another agency capable of being utilized to aid in directing light toward the working plane is the walls of the room. If they are light colored, their effect is beneficial. It will amount to from 8 per cent. to 15 per cent. of the incident light, depending somewhat upon the angle of incidence. If they are dark, they

will still send a small amount of light to the floor, but their influence may be so small as to be negligible.

The combined effect of ceiling and walls is shown in the Table 23, given by Cravath.¹ The figures listed under the indirect method show that from 14 per cent. to 40 per cent. of the light emitted by a lamp may finally fall upon the working plane, the rest being absorbed by reflector, ceiling, or walls. These values

TABLE 23.—EFFICIENCY OF UTILIZATION

Ceiling, reflection coefficient	Light, 70 per cent.			Medium 50 per cent	
Walls, reflection coefficient	Light, 50 per cent.	Medium, 35 per cent.	Dark, 20 per cent.	Medium, 35 per cent.	Dark, 20 per cent.
Lighting equipment:					
Direct, prismatic.	65	61	59	58	56
Direct, light opal.	40	37	36	36	35
Direct, dense opal.	57	53	50	48	46
Direct, steel bowl, enamel or aluminum.	33	28	27	26	24
Direct, steel dome, enamel.	61	58	57	56	53
Totally indirect, mirrored.	40	35	34	34	32
Semi-indirect, light opal.	57	55	54	54	53
Semi-indirect, dense opal.	39	36	35	35	34
Totally enclosing.	70	67	65	67	65
Light opal.	46	42	39	42	39
	40	38	36	27	26
	24	21	20	15	14
	47	45	43	39	35
	30	25	24	22	20
	43	41	40	31	30
	27	25	22	18	17
	46	42	40	38	35
	25	19	18	18	15

The values in this table have reference to square rooms equipped with a sufficient number of lighting units and so placed as to produce reasonably good uniform illumination. In each case the upper figure applies to an extended area, namely, one in which the horizontal dimension is at least five times the distance from floor to ceiling. The lower figure applies to a confined area, one in which the floor dimension is but five-fourths of the ceiling height. The utilization factor for a rectangular room is approximately the average of the factors for two square rooms of the large and small floor dimension respectively.

¹ *Illum. Eng. Pract.* (1916), p. 52. Considerable data are presented here in tabular and in graphic form.

represent, therefore, the efficiencies of utilization for the conditions listed. The same table gives also the utilization efficiencies for various semi-indirect and direct systems. Table 24 is taken from the literature of the National X-ray Reflector Company and presents their figures for the efficiency of utilization of flux from lamps in indirect systems with central fixtures. They are said to be 20 per cent. low in order to take care of depreciation due to dust and aging of the lamps.

TABLE 24.—EFFICIENCY OF UTILIZATION

Minimum dimension of room divided by ceiling height	Efficiency of utilization	
	Dark walls	Light walls
1.0	0.20	0 24
1.5	0.22	0 26
2.0	0.24	0 28
2.5	0 28	0 30
3.0	0 30	0 32
3.5	0.32	0 34

When a silvered mirror is used with the direct system, the efficiency of utilization is higher. In this case, the color of the ceiling is immaterial except for aesthetic reasons and the color of the walls has no serious effect for rooms having 3.5 as the ratio of minimum dimensions to ceiling height, and the larger values given below will apply. For lesser dimension factors, we have Table 25.

TABLE 25.—EFFICIENCY OF UTILIZATION

Color of walls	Efficiency of utilization
Light.	0.70
Medium	0.60
Dark.	0 45

It is to be seen in connection with these tables, that the efficiencies depend upon the relative dimensions of the room. The minimum dimension of the room divided by the height of the ceiling gives a quotient which is used as the argument of the tables. In interpreting the data, it is well to note that the presence of a wall, as represented by a lesser minimum dimension of

the room, cuts off from the working plane a certain amount of light and thus lowers the efficiency. It is equivalent to a narrowing of the solid angle by which flux reaches the table. If, with increased ceiling extent, there is also installed an increased number of lighting units, as is always done, the effective illumination for any given spot is increased.¹ Hence, with increasing dimensions of the room, we see a rising efficiency of utilization. Moreover, the effect of the color of the walls becomes less and less, the two columns of efficiencies approaching the same limiting value.

Power Rating of Installation.—When once we have determined the number of lumens output of the lighting equipment required for the room, we are enabled to assume various kinds of lamps and thus find the power consumption for any of them.

Subdivision into Units and Number of Stations.—It has been stated that the division of the total light flux up into units to be furnished by individual lamps or groups of lamps is accomplished by trial calculations based upon experience. Even a limited amount of the latter will very considerably lessen the time

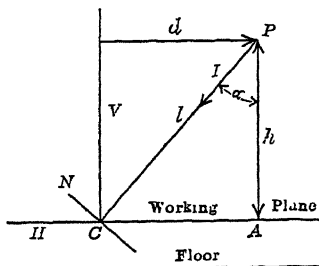

FIG. 72.—Point-by-point calculations of illumination.

spent in the former. Moreover, the reliability of the result will depend to a large degree upon the judgment of the designer in recognizing the weight of all of the influencing elements, control, height of suspension, spacing, lamp size clustering, glassware, etc. It will be well to present a few calculations showing how these elements must be woven together. In doing this, we will begin with the simplest case and progress to some of the more complicated ones.

Point Source with No Wall or Ceiling Reflection.—In Fig. 72, there is shown a working plane (AC) at a distance above the floor equal to the height of desks, or 30 inches. A point source of light is placed at P , which is h feet above the working plane. At a distance of d feet from the foot of the perpendicular through

¹ The limiting condition is that of an infinite plane ceiling over a floor of similar extent. A theoretical consideration of this problem indicates that the illumination would be uniform. The flux falling upon any unit area will be equal to the flux emitted by the same area upon the ceiling. The illumination will be πb , where b is the brightness of the ceiling.

the lamp, there is taken a station C , at which point it is desired to know the illumination. This station is only one of many taken in a systematic way about the plane, solving for all of which will give data from which the illumination contours may be plotted. The intensity of the light in this direction from the lamp is found by reference to the polar curve for the lamp. It is assumed to have a value I . Either the distance d or the angle α may be chosen independently. It is generally more convenient to take the angles when one is making calculations from the lamp data. If l is the distance from the light to the point C , then

$$l = \frac{h}{\cos \alpha}.$$

Upon a normal plane N through the point C , the intensity of the illumination will be

$$E_n = \frac{I}{l^2} = \frac{I \cos^2 \alpha}{h^2}.$$

The illumination upon planes placed at any other angles than normal to the beam of light will be calculated by use of the cosine law. Introducing two planes, V and H , vertical and horizontal, respectively, we have

$$E_h = E_n \cos \alpha = \frac{I}{h^2} \cos^3 \alpha$$

$$E_v = E_n \sin \alpha = \frac{I}{h^2} \sin \alpha \cos^2 \alpha = \frac{I}{d^2} \sin^3 \alpha$$

It is generally assumed that the object to be observed is placed horizontally upon the working plane, in which case it will receive the illumination E_h . If the object is vertical, as in the case of a picture hung upon the wall or that of a book shelf, the lighting is indicated by the value of E_v .

Example of Point-by-point Calculation.—To find the direct illumination upon a working plane, by means of the point-by-point method and to plot illumination contours presents a laborious process. Having done this, the results are in error by whatever amount of light is received from the ceiling or walls. On this account, the point-by-point method is not a satisfactory means of estimating results except in particular instances or for particular reasons. In certain large workshops, however, it is found practicable to use simple reflectors to throw all light downward into the lower hemisphere. The rooms may be so large that the walls are of minor effect. We then have a case which falls within the range of this method of calculation.

ings, we will number them from 1 to 10 as shown, beginning in one corner of the room and running about halfway across the end. The stations of the next row are numbered from 11 to 20; for the third row we use 21 to 30; etc.¹ Now, without following the analysis through in detail, we can assert that all that is required is to secure data for that part of the working plane included in the triangle whose vertices lie at stations number 1, 10 and 100, with, perhaps, a few special points like *X* and *Y*. This involves a list of fifty-seven stations. The calculation for any one of these necessitates an estimate of the illumination at

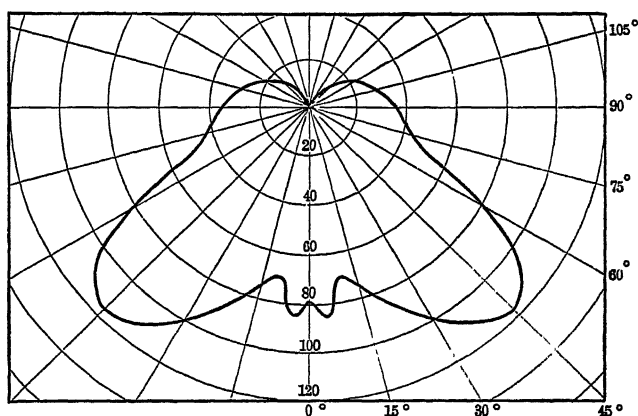

FIG. 74.—Distribution curve for 75-watt Mazda lamp with reflector.

that point by each of several lamps, numbering from four to nine, in this particular instance. It is very probable, however, that we shall find a few duplicate values in this list, as, for example, the two series 46, 47, 48, 49, 50, compared with 56, 57, 58, 59 and 60. Certain other identities might be prophesied, after a little investigation.

Stating the complete problem, we have a room 57 feet by 72 feet with ceiling 13.5 ft. high, a working plane which is 30 in. above the floor, and a suspension of lamps of some undetermined distance from the ceiling. The lamps used are 75-watt mazzdas

¹ This arrangement of stations does not lend itself to best advantage to the calculation of the total flux falling upon the plane. If it is intended to derive such data, it will be more convenient if the stations are taken at the centers of small elementary squares into which the plane is divided.

with a reflector having a velvet finish. Light flux amounting to about 1.5 to 2.0 lumens per square foot is desired. We will try out three different heights of suspension, namely, at distances above the working plane of 10 ft., 8 ft. and 7 ft.

By means of the process of calculation outlined above for that purpose, the first steps are taken by preparing a table of values of the illumination by one lamp for a series of points along a straight line on the working plane beginning directly

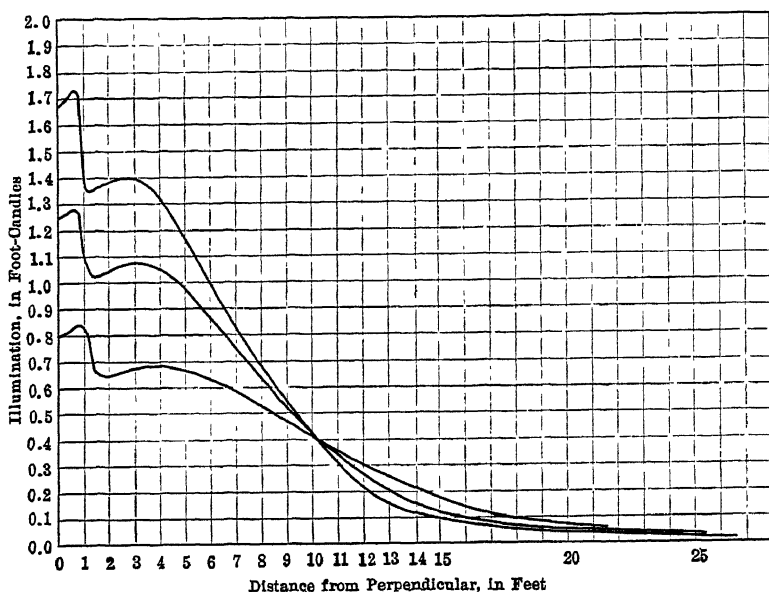

FIG. 75.—Intensity of illumination of working plane by one 75-watt lamp fitted with a reflector having a velvet finish, for different elevations.

underneath the lamp, and extending to a distance such that the vertical component becomes of negligible value. Such curves as Fig. 75 show the results of this investigation as arranged in Table 26, and constitute one component of the total illumination. At any distance, in any direction from any lamp, the effect of that one lamp is exhibited by the corresponding ordinate of one of these curves. By trial, we find that we shall need to use the suspension giving a clearance of 7 ft.

It now remains to compound these individual effects for successive stations. It is convenient to do this by means of tabulated distances and their corresponding values of illumination.

The horizontal distance from a given lamp to any particular station is measured along the hypotenuse of a right triangle in the working plane whose sides are measured in multiples of three feet. Let us tabulate all such sets of legs which we are likely to use, with the lengths of the hypotenuse and (taken from the illuminating curve) the corresponding value of E_h for this distance. This is done in Table 27. Next, taking, for example, station No. 47, we find that it will receive light from lamps A, B, E, F , and perhaps C and G . The amount received from A will be found in our table by taking the reading opposite the leg-pair 12-6, viz., 0.14 foot-candles. For the lamp B there will be received the reading opposite 6-3, viz., 0.90 foot-candles. Lamp C distant 18-6 feet, gives 0.03 foot-candles. Similarly, the effects of E, F , and G are 0.10, 0.48 and 0.02 foot-candles, respectively.

TABLE 26.—ILLUMINATION CURVE DATA FOR 75-WATT MAZDA LAMP WITH REFLECTOR

Distribution data		$h = 10$		$h = 8$		$h = 7$	
α	I	E_h	d	E_h	d	E_h	d
0	80	0.80	0.0	1.25	0.0	1.63	0.0
5	85	0.84	0.875	1.28	0.7	1.71	0.625
10	69	0.66	1.76	1.03	1.41	1.35	1.23
15	74	0.67	2.66	1.05	2.14	1.37	1.86
20	83	0.69	3.64	1.08	2.91	1.40	2.55
25	91	0.68	4.66	1.06	3.73	1.385	3.26
30	100	0.65	5.77	1.01	4.62	1.325	4.03
35	105	0.58	6.86	0.91	5.5	1.18+	4.8
40	113	0.51	8.40	0.79	6.71	1.04	5.9
45	117.5	0.416	10.00	0.65	8.00	0.85	7.0
50	113	0.301	11.9	0.47	9.55	0.613	8.33
55	101.5	0.192	14.8	0.30	11.85	0.392	10.38
60	82	0.103	17.2	0.166	14.8	0.21	12.05
65	66	0.050	21.5	0.079	17.2	0.102	15.0
70	49	27.5	0.031	22.0	0.04	19.3
75	42.5	37.3	0.0115	29.9	0.015	26.1
80	40	56.8	45.4	39.7
85	38						
90	37						
95	35						
100	33						

TABLE 27.—SETS OF DISTANCES FROM LAMPS TO STATIONS

Leg-pairs	Distance	E_h	Leg-pairs	Distance	E_h
21-0	21.0	0.03	9-0	9 0	0.53
			9-3	9 5	0.48
18-0	18.0	0 05	9-6	10.8	0 33
18-3	18.2	0 04	9-9	12.7	0 18
18-6	19 0	0 03			
			6-0	6 0	1 00
15-0	15.0	0.10	6-3	6 7	0.90
15-3	15.3	0.09	6-6	8 5	0.60
15-6	16 2	0 07			
15-9	17.5	0.05	3-0	3 0	1.4
15-12	19.2	0.04	3-3	4 25	1.28
15-15	21.2	0.03			
			0-0	0.0	1.63
12-0	12 0	0.21			
12-3	12.5	0.19			
12-6	13.4	0.14			
12-9	15.0	0.10			
12-12	17.0	0 06			

TABLE 28.—ILLUMINATION INTENSITIES IN FOOT-CANDLES

Station	Illumination	Station	Illumination	Station	Illumination
1	0.60	23	1.86	56	1.44
2	0.93	24	1.84	57	1.67
3	1.10	25	1.65	58	1.77
4	1.04	26	1.68	59	1.67
5	0 93	27	1.80	60	1 44
6	0 93	29	1 80		
7	1 07	30	1.68	67	1.80
8	1.17			68	1.91
9	1.03	34	1.70	69	1.80
10	0 93	35	1.62	70	1.67
		36	1 62		
12	1 36	37	1.76	78	2.08
13	1 54	38	1.87	79	1.91
14	1 51	39	1.76	80	1.81
15	1 41	40	1.62		
16	1 41			89	1 90
17	1 55	45	1.44	90	1.67
18	1.63	46	1.44		
19	1.55	47	1.67	100	1 44
20	1.41	48	1.77		
		49	1.67	X	1.69
		50	1.44	Y	1.36

This gives a total of 1.67 foot-candles. We can neglect in the present case those lamps distant more than 22 feet.

Continuing this process for other stations, we arrive at the results listed in Table 28. From these values we plot the contour curves of Fig. 76, in which the matter of symmetry is very easily apprehended. Even at the edge of the room the direct illumination is in the neighborhood of 1 foot-candle. If there is any reflection from the walls, this value will be increased accordingly.

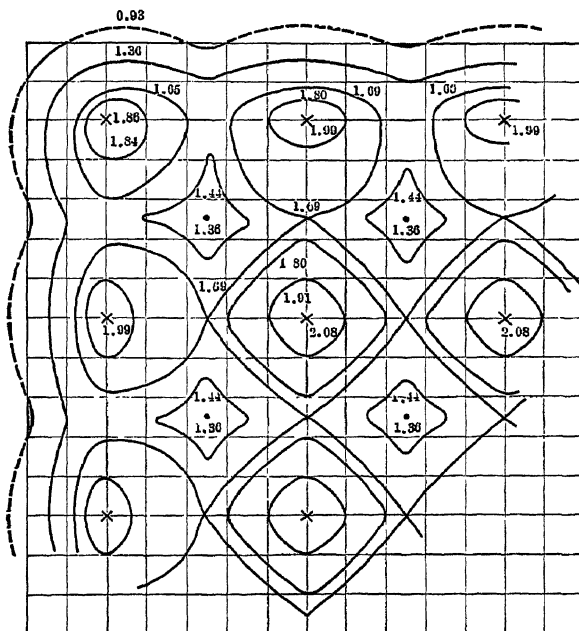

FIG. 76.—Illumination contours.

Effects of Walls and Ceiling.—If it is of any moment, the lighting of the walls may be calculated by a similar process. If the walls are of light color they will affect the lighting of the working plane, especially in the zones at the edges of the room where we now see the least values for E_A . A certain amount of light also reaches the ceiling through the velvet finish reflector. Depending upon the color of the ceiling, this may be sufficient only to relieve the eye of too much of a contrast between lamp and ceiling or it may give an appreciable light source by reflection toward the working plane. Quantitative values of these

effects have been published by Lansingh and Rolph¹ and by Sharp and Millar,² who have made direct measurements in rooms supplied with walls, ceilings and rugs of different colors.

In the latter investigation, the room was 12 ft. 7 in. by 12 ft. 2 in. with a ceiling 9 ft. 10 in. high. The walls were grayish white. The ceiling was covered with white cloth. Black cloth was also used to cover the walls and ceiling during certain stages of the work. The light source was a 250-watt, frosted-bowl metallized-filament lamp equipped with a satin-finished prismatic bowl reflector. It was suspended centrally by a drop cord, being clear of the floor by 9 ft. 4 in. The working plane was assumed to be 36 in. above the floor. Table 29 gives a summary of the findings, with partial analysis.

Discussion.—There are several points in this summary which warrant discussion. With a total light flux of 380 lumens, the interreflection of light is great enough to provide that the effective flux amounts to 1332 lumens over walls, ceiling and working plane, combined. This is an increase of about 250 per cent., giving 3.5 times the average illumination which would be had with black surfaces. Approximately 50 per cent. of this flux is upon the walls, rather than the working plane, which receives

TABLE 29—EFFECTS OF WALLS AND CEILING IN INFLUENCING ILLUMINATION INTENSITIES

	Lumens
Analysis of ceiling illumination:	
Direct from light source.....	183
Light from ceiling, reflected back by walls.....	20
Wall light reflected to ceiling.....	77
	<hr/>
Total flux on ceiling.....	280
Analysis of wall illumination (all four walls):	
Direct from light source.....	382
First reflection from ceiling to walls.....	116
First reflection from wall to wall.....	104
Multiple reflections, ceiling and walls.....	70
	<hr/>
Total flux on walls.....	672

¹ *Trans. Ill. Eng. Soc.*, vol. 3 (1908), p. 584.

² *Trans. Ill. Eng. Soc.*, vol. 5 (1910), p. 391.

Analysis of working plane illumination:

Direct from light source.....	191
From ceiling alone.....	42
From ceiling via walls.....	35
From walls alone.....	86
From walls via ceiling.....	26
<hr/>	
Total flux on working plane.....	380
Total direct flux = $183 + 382 + 191$	756
Check computation from distribution curve..	779

Analysis of effective flux:

Total effective flux on ceiling.....	280
Total effective flux on walls.....	672
Total effective flux on working plane.....	380
<hr/>	
Total effective flux.....	1332

Analysis of reflection effects upon working plane illumination:

	Per cent.
Increase in illumination due to ceiling <i>only</i>	22.0
Increase in illumination due to walls <i>only</i>	45.0
Increase in illumination due to multiple reflection between walls and ceiling.....	32.0
<hr/>	
Total increase in illumination due to all reflections.....	99.0

Efficiency:

Efficiency of utilization, $380/756$	50.2
Ratio of effective flux to total effective flux $380/1332$	28.5

Constants of reflection:¹

Ceiling $(116 + 42 + 35 + 36)/280$	78.0
Walls $(20 + 77 + 35 + 26)/672$	32.0

about one quarter of the total. It is apparent that much of the light falling upon the walls is reflected back and forth and does not reach the table. This is not surprising for a room of these dimensions, if we realize the relative areas of walls, ceiling and floor, as well as the angles involved.

Light colored walls were more effective in this case than was a light colored ceiling. Here, again, relative areas and the angles of incidence and reflection present the solution.

¹ This is not the same as a coefficient of reflection for parallel beam of light in some particular direction of incidence. The incident light is diffuse in striking the ceiling and walls and the constants worked out are therefore composite.

Multiple reflection has a greater effect than either single component above mentioned. In this connection, it is of importance to note that the color of the floor or a well-filled working plane may materially influence the result. Quite generally this is negligible, because the floor is dark. When it is light colored terrazzo or mosaic, the added multiple reflection will be appreciable.

Fig. 77, taken from the same paper, indicates the division of the light flux into its parts, as received from the light source direct or from ceiling or walls. The curves are plotted along a line extending outwardly from the center of the room. The direct component falls off as the distance from the center of the

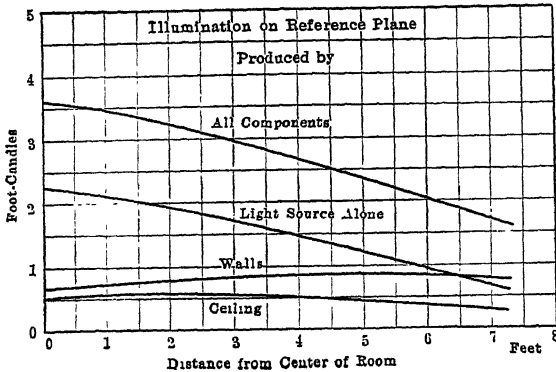

FIG. 77.—Various components of total illumination upon reference plane.

room increases. The ceiling component also decreases, but less rapidly. The wall component increases perceptibly.

Calculation by Flux of Light.—In the example just given (Figs. 73 and 76), the variation in illumination intensity over the interior parts of the working plane amounts to 35 per cent. Provided the minimum illumination is sufficient for the purpose, the lack of uniformity of this amount will not prove to be serious. We may even base our calculations upon the supposition that the light received by the working plane is uniformly distributed. This method was worked out by Lansingh and Rolph as a result of the suggestions made by Sharp in his presidential address before the Illuminating Engineering Society in 1907.

Proceeding from the same starting point as in the previous

problem, we must estimate how much of the flux from the sources of light will reach the table. We have already discussed at an earlier point in this chapter the efficiency of utilization of a lamp. It is a figure which is greatly influenced by fixtures, glassware, furnishings, height of suspension, etc. If, however, we have tabulated values of utilization efficiencies for various types of installation, colors of interiors, etc., taken from actual test readings, we are in a position to make use of these figures in our estimates with a very fair degree of confidence in the results.

Effective Flux.—One method of doing this is to take from the data of Table 23 or Table 24 the efficiency corresponding to the conditions of the proposed installation. In this particular case, we find a probable value of 30 per cent. to 40 per cent. This means that the value of the effective flux upon the working plane will be equal to thirty per cent. or more of the figure giving the total output of the lamp.¹

The output of the lamp used is 955 lumens. With an efficiency of utilization of 35 per cent., we find that 334 lumens represents the effective flux on the table. There were 20 lamps installed giving a total of 6680 lumens, effective. The area of the table is 4104 sq. ft. Hence, the average illumination will be 1.63 lumens per square foot.

It is customary for manufacturers to give nowadays the lumen outputs of their lamps. This practice lends itself well to our present need. Table 30 shows typical data for mazda lamps of both the vacuum and gas-filled types, as supplied in 1916.

This method of calculation does not give any notion of the variation in illumination over the table. It is not capable of furnishing this information as it is based on averages. Only by calculation for individual stations can we secure these data. It will not be difficult, however, to select by inspection the points where these greatest variations are apt to occur, after which, a few point-by-point determinations will give a fair idea of the general characteristics of the installation.

¹ Observe that this does not mean that one-third of the flux is used upon the working plane and two-thirds of it upon the other parts of the room. Much of the effective flux is reflected light, having produced more illumination upon walls and ceiling than it will upon the table. Referring to the data of Table 29 for the small room, it will be seen that with an efficiency of utilization of 50.2 per cent., the ratio of effective flux on the working plane to the total effective flux on the plane, walls and ceiling, is only 28.5 per cent

Effective Angle.—A variation upon this scheme of computation is possible by preparing a schedule of sources of light, listing opposite each the effective angle of each. By this term is meant that angle measured from the nadir, the flux within which is equivalent to the effective flux upon the working plane. It is affected by room conditions as well as glassware, etc.

TABLE 30.—ENGINEERING DATA ON MAZDA LAMPS

Watts	Input, watts per spherical c.-p.	Output, lumens per watt	Total lumens	Reduction factor	
105-125 Volt "B" Straight Side Bulbs					
10	1.67	7.50	75	0.78	
15	1.47	8.55	128	0.78	
20	1.41	8.90	178	0.78	
25	1.35	9.30	234	0.78	
40	1.32	9.50	380	0.78	
50	1.31	9.60	480	0.78	
60	1.28	9.80	590	0.78	
100	1.22	10.3	1030	0.78	
105-125 Volt "C" Pear-shape Bulbs					
75	1.09	11.5	865		
100	1.00	12.6	1,260		
200	0.90	14.0	2,800		
300	0.82	15.3	4,600		
400	0.82	15.3	6,150		
500	0.78	16.1	8,050		
750	0.74	17.0	12,800		
1000	0.70	18.0	18,000		
MAZDA STREET LIGHTING LAMPS					
Nominal rated c.-p.	Total lumens	Average volts	Average watts	Input, watts per spherical c.-p.	Output, lumens per watt
5.5-amp. "C" Street Series Straight Side and Pear-shape Bulbs					
60	600	8.5	46.8	0.98	12.8
80	800	10.8	59.5	0.93	13.5
100	1000	13.0	71.5	0.90	14.0
250	2500	29.7	163.0	0.82	15.3
400	4000	47.4	260.0	0.82	15.3

6.6-amp. "C" Street Series Straight Side and Pear-shape Bulbs

60	600	7.1	46.8	0.99	12.7
80	800	9.1	60.0	0.94	13.4
100	1000	10.9	72.0	0.90	14.0
250	2500	23.5	155.0	0.78	16.1
400	4000	37.1	244.0	0.77	16.3
600	6000	55.7	368.0	0.77	16.3

7.5-amp. "C" Street Series Straight Side and Pear-shape Bulbs

60	600	6.4	48.0	1.00	12.6
80	800	8.0	60.0	0.94	13.4
100	1000	9.6	72.0	0.90	14.0
250	2500	19.6	147.0	0.74	17.0
400	4000	30.5	228.0	0.72	17.5
600	6000	45.8	344.0	0.72	17.5

Lansingh and Rolph give results of tests made in a room 22 ft. to 25 ft. 9 in. long by 11 ft. 6 in. wide with a ceiling 10 ft. 1 in.

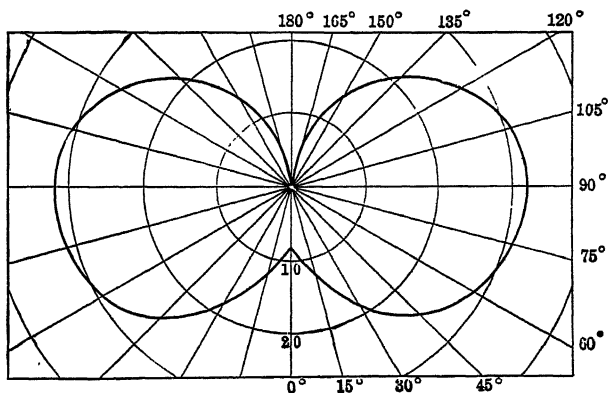

FIG. 78.—Distribution curve for 40-watt, clear-tip, tungsten lamp, bare.

high. Wall coverings were dark green burlap and light cream-colored wrapping paper. Three 40-watt tungsten lamps were installed and used, as the test data indicate, with and without prismatic reflectors, the center light only or the three lights together. The test plane was 2.5 ft. above the floor. No particular attempt was made to arrive at uniformity of illumination, the question involved being mainly that of the effective angle for the illuminant, with the different conditions of room reflection and fixtures.

Figs. 78 and 79 give the distribution curves for the lamp used, with and without the reflector. Fig. 80 shows how many effective lumens there are in the solid angle of revolution about

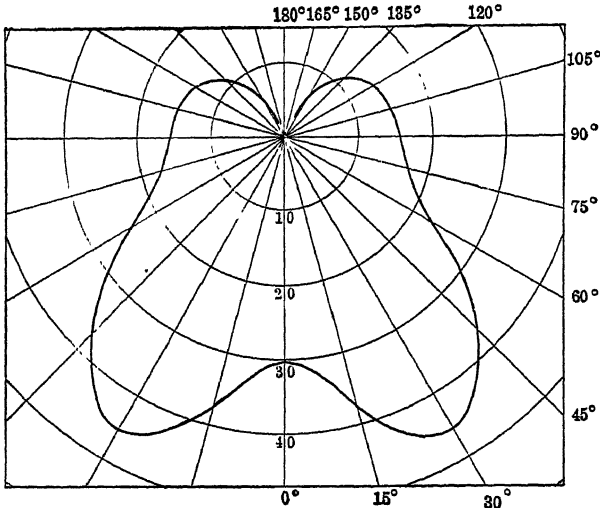

FIG. 79.—Distribution curve for 40-watt, frosted tip, tungsten lamp, with prismatic reflector.

the nadir, by various plane angles. Finally, Table 31 presents the results of the measurements.

The conditions which interest us most are typified by the

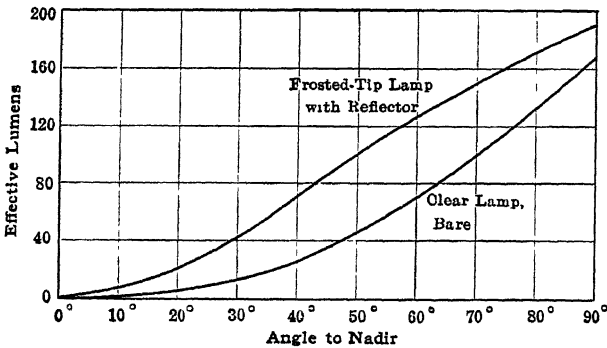

FIG. 80.—Effective lumens for various angles below 40-watt, tungsten lamps.

data for lamps with reflectors. Generally speaking, the ceiling is light if any other part of the room is, and the floor is never light, unless walls and ceiling are light also. Examined upon

this basis, lines, 1, 2, 3, 4, 5, 10, 11, 12, 13, and 14 seem most important to us. The other lines, however, allow important comparisons to be made. Taken as a whole, all possible sets of conditions are given and the effect of any one part may be estimated.

TABLE 31.—EFFECTIVE ANGLES. DATA ON REFLECTIONS IN SMALL ROOMS

Conditions	Bare				With reflector			
	Mean foot-candles	Lumens, effective	Effective angle	Lumens per watt	Mean foot-candles	Lumens, effective	Effective angle	Lumens per watt
For one lamp clear.								
1. Calculated illumination, by points . .	0.16	44	50	1 10	0 36	99	50	2 5
2. Ceiling, walls and floor dark.	0 19	52	53	1 30	0 36	99	50	2 5
3. Ceiling light, walls and floor dark. . . .	0 34	94	69	2 32	0 48	132	63	3 33
4. Ceiling and walls light, floor dark. . .	0 56	154	86	3 84	0 63	173	82	4 35
5. Ceiling, walls and floor light	0.68	187	90	4 76	0 90	248	90	6.25
6. Walls light, ceiling and floor dark	0 31	85	66	2 13	0 43	118	58	2 94
7. Walls and floor light, ceiling dark.	0 34	94	69	2 32	0 49	135	64	3 33
8. Floor light, ceiling and walls dark.	0 21	58	56	1 45	0 37	102	51	2 5
9. Ceiling and floor light, walls dark.	0 37	102	71	2 56	0 49	135	64	3.33
For three lamps, frosted tips:								
10. Calculated illumination, by points.	0.41	113	47	0 943	0 89	245	45	2.04
11. Ceiling, walls and floor dark.	0 48	132	50	1 10	0 91	250	46	2.08
12. Ceiling light, walls and floor dark.	0 94	258	66	2 13	1 17	322	56	2 7
13. Ceiling and walls light, floor dark.	1.57	432	83	3 57	1 74	479	80	4 0
14. Ceiling, walls and floor light.	1 96	540	90	4.55	2.27	625	90	5 25
15. Walls light, ceiling and floor dark.	0 85	234	63	1.96	1 15	316	55	2 63
16. Walls and floor light, ceiling dark.	0 92	253	65	2 12	1 23	338	57	2 77
17. Floor light, ceiling and walls dark.	0 50	137	50	1 14	0 90	248	46	2 08
18. Ceiling and floor light, walls dark.	0 99	272	67	2 27	1 20	330	56	2 77

Table 32 shows the percentage increase in mean illumination and in effective angle due to certain changes of ceiling, walls or floor from dark to light when reflectors are used. If all are dark, whitening the ceiling gives some 30 per cent. better lighting upon the working plane. Changing the walls only, instead of the ceiling gives an increase of 20 per cent. Leaving walls and ceiling dark and lightening the floor gives no appreciable effect. In fact, it appears that it is of no value to make the floor light colored unless the walls are already whitened, when, with dark ceiling, a 10 per cent. increase is noted. Upon the other hand, with white ceiling and walls, changing the floor will give 30 to 40 per cent. more light. One of the striking things brought out by a study of the data, is that when any two elements of the interior are light colored, the changing of the third element from dark to light produces a large effect. How much of this effect can be utilized depends upon the furnishings of the room, and, of course, the reflection by the floor is always more seriously interfered with than is that from the other parts.

TABLE 32.—INCREASE IN ILLUMINATION DUE TO CHANGE OF COLOR OF WALLS, CEILING OR FLOOR

Initial condition		Change to light	Percentage increase due to change			
Dark	Light		Mean foot-candles		Effective angle	
			1 lamp	3 lamps	1 lamp	3 lamps
<i>FWC</i>	<i>C</i>	33	29.0	26.0	22.0
<i>FW</i>	<i>C</i>	<i>W</i>	31	49.0	30.0	43.0
<i>F</i>	<i>WC</i>	<i>F</i>	43	30.0	?	?
<i>FW</i>	<i>C</i>	<i>F</i>	2	2.5	1.5	0.0
<i>W</i>	<i>F C</i>	<i>W</i>	84	89.0	?	?
<i>FWC</i>	<i>W</i>	19	21.0	16.0	19.0
<i>F C</i>	<i>W</i>	<i>C</i>	46	51.0	41.0	45.0
<i>FWC</i>	<i>F</i>	3	2.0	0.0
<i>WC</i>	<i>F</i>	<i>W</i>	32	37.0	25.0	24.0
<i>C</i>	<i>FW</i>	<i>C</i>	84	85.0	?	?
<i>WC</i>	<i>F</i>	<i>C</i>	32	33.0	25.0	22.0
<i>F C</i>	<i>W</i>	<i>F</i>	14	7.0	10.0	3.5

Returning to the consideration of the effective angle, we are probably safe in stating our conclusions as they are given in Table 33. *F*, *W* and *C* refer to floor walls and ceiling, respectively.

TABLE 33.—EFFECTIVE ANGLES, PRISMATIC REFLECTORS USED

Dark	Light	Effective angle, degrees
Small room		
<i>FWC</i>	45-50
<i>FW</i>	<i>C</i>	60
<i>F</i>	<i>WC</i>	80
.....	<i>FWC</i>	90
Large room		
<i>C</i>	60
.....	<i>C</i>	80

Theoretically, an anomalous situation may arise in dealing with the effective angle. Practically, there probably will not come about the existence of the conditions which are needed to give this peculiarity. We have seen that the effective illumination of the working plane may depend more upon the multiple reflections of walls, ceiling and floor than it does upon the actual flux emitted by the source. If these multiple reflections are very efficient, the figure giving the effective flux upon the table may be larger than that giving the flux emitted by the lamp. The effective angle then becomes something indefinite, larger than 180 degrees. Similarly, in the effective flux method of calculation, theoretically, the effective flux may be more than 100 per cent. of the emitted flux. This method is still usable.

The spacing of direct lighting units depends upon the type of reflector used, and the height of suspension. This relation may be indicated by diagrams if we assume that our reflectors are capable of being classified under the headings of concentrating, semi-concentrating and distributing. For the National X-ray reflectors or these types, the spread of light over the working plane is shown by Fig. 81. Similar curves may be developed for any reflector and economy of time and work often results from their preparation, if many calculations are being made. In fact, a man actively engaged in the design of lighting installations will accumulate a great variety of such material and will spend much

effort to keep it revised to date. When this is done, it is possible for the engineer to take advantage of the latest advances of the art. When the material becomes out of date, it is used at the risk of one's professional reputation. An example of the rapidity of the changes involved is given by instance of the introduction of the gas-filled tungsten lamp. Not only do these new units change data on efficiencies, lumens output, etc., but old types of reflectors and glassware in general can not be installed with them unless the adaptation of part to part is very carefully studied.

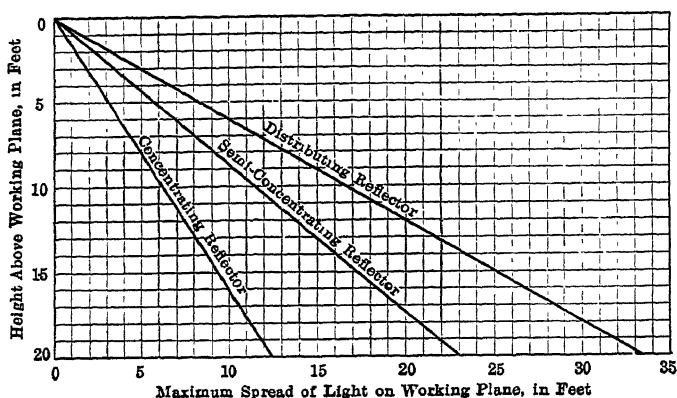

FIG. 81.—Spread of light with direct lighting system.

Calculations for Indirect Systems of Lighting.—When installing the indirect system of illumination known as the Eye Comfort System,¹ the engineering department of the company advises that the ceiling should have a coefficient of reflection of 50 per cent. to 60 per cent. Matte white, light cream and very light ivory finishes will accomplish this.

For all general lighting, the spacing of units and the determination of the required number can be estimated by dividing the room into squares or rectangles with nearly equal dimensions, where the sides of these squares are not over 1.5 to 2 times the ceiling height. The lesser figure applies for ceilings 12 feet high or lower. It is supposed that a fixture will then be installed in the center of each square. From the tables which we have already given, it will be easy to determine the effective number of lumens which must reach the working plane in order to give a

¹ See the engineering data book of the National X-ray Reflector Co.

satisfactory illumination. Having also, the efficiency of utilization for the installation, the lumen output of the unit is made known. The total number of lumens per outlet may now be divided up into lumens per lamp, and the lamp size selected, as is thought best.

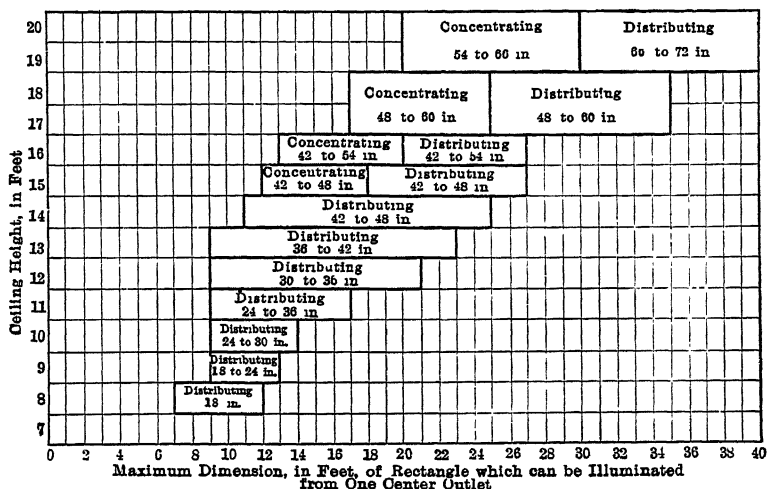

FIG. 82.—Type of reflector and length of suspension for indirect lighting system.

In choosing the type of reflector to be used and its height of suspension, reference may be made to Fig. 82. For different combinations of ceiling heights and sizes of squares, this illustration denotes the preferable choice between concentrating or distributing reflectors and also indicates the proper length of suspension as measured from the ceiling.

CHAPTER XIV

RESIDENCE LIGHTING

In attacking the problems of residence lighting, it is generally convenient to assume a classification of rooms in terms of their uses and their sizes. Living rooms must be dealt with in a manner different from that in which bedrooms are handled; large living rooms admit of and even demand a different treatment from small living rooms. There are a few fundamental items, however, which may be mentioned in contrasting all such rooms with public halls, offices, factories or stores.

The home is essentially a haven, a place of comfort and companionship, a place where the emotions are properly given sway. Therefore peace and comfort should be promoted by quiet, restful, harmonious lighting effects. The psychological phase of illumination is especially prominent in consideration of the home. On this account, intensity and color of light play an important part.

The occupations pursued at home are peculiarly liable to injure the eyes if conditions for work are not favorable. Reading and sewing by evening light or on dark days are responsible for many of the ills of the eye. It must be remembered that mere brilliancy of illumination is not the remedy for these troubles. In fact, the bad effects may be made worse by excess light wrongly used.

Upon the other hand, correct lighting alone cannot be expected to make every interior attractive. In fact, we may even say that correct lighting is so much a matter of ensemble that some rooms as furnished never could be successfully lighted. Designed lighting systems apply in their most effective way to designed homes. Fortunately there may be and generally is more or less unconsciously a plan built up of how each room should look as a whole. The various rooms are sometimes even thought of collectively.

The small living room needs a good general illumination of from two to three foot-candles. When the walls are especially

dark, this must be exceeded, materially. This may be supplied by a central fixture of direct types. Indirect or semi-indirect fixtures may be used with good effects. In any case, the local lighting should probably be increased at some point by use of a table lamp or standard lamp. If a small table is present among the furniture it will probably be placed in the center of the room in such a way that the members of the family may group themselves around it. A table lamp then becomes useful and effective. It should have such a type of translucent shade that the light does not directly strike the eyes and yet covers the paper, book or work being done. The shade should not have a fringe, because this will give rise to streaks across a part of the illumined field. These alternate light and dark streaks are bad enough, but when we add to the undesirable features, an irregular swinging motion of the bead fringe, the effect is abominable.

Large living rooms may be treated the same way, as far as general features go. The method outlined, however, is likely to leave the sides of the room poorly lighted. In case this is found to be true, additional wall lamps may be used if properly shaded so as to avoid glare to the observer's eye. Wall lamps are quite subject to objections because of the difficulty of cutting off direct light which would glare into one's eyes, while still leaving enough light emission to influence the light distribution. If walls are light colored or if good diffusing shades or globes are used, the object can be accomplished.

In the extreme case, the wall lamps may be reduced in output until they constitute merely a room decoration.

Special lighting for individual paintings hung in this room must be handled with extreme care or abandoned altogether, with dependence placed upon the general illumination for more or less satisfactory results. It is undesirable to give too much prominence to a special fixture in a position designed to throw light upon the picture from the front. A beamed ceiling may serve to provide a recess for the lamps. The light must not strike the picture at an angle which causes glare in the eyes of the observer. A straight-line filament lamp may sometimes be hooded upon the frame so as to give good results, but this is a solution which admits of only limited application. More will be said about this in discussing art gallery lighting where it more properly belongs, inasmuch as only occasional instances occur in connection with residence lighting.

Dining room tones should be warm. This implies the use of slightly amber, or orange tinted light. In fact, carbon filament lamps will serve well here if strict economy is not to be considered. This is another way of saying that white linen, silverware, etc., will take on a richer appearance with the orange light. Silver foil placed under tungsten lamp light and under carbon filament light is revealed by the latter in the guise of a gold mass, while in the former it appears brilliant but cold.

For the average room, a central dome is about as effective an arrangement as can be provided. It must be low-hung enough to protect the-eyes from all direct light beams. Here, more than ever, fringe will produce most disastrous results. The dome should permit transmission of some light to the ceiling for general diffusion. Color effects should be studied.

If a semi-indirect unit is used, it should be hung high enough to avoid glare, and the ceiling should be light colored. In the larger rooms, when it becomes necessary to use wall lamps, the same precautions must be observed as before, namely, the lamps must not be very brilliant and must be hidden from direct vision.

In all cases where reflection or direct emission may produce bright lines upon table or ceiling, coming from the brilliant filaments, the practice should be established of installing frosted bulb lamps. With the bowl, a thin diffusing plate may be interposed between the lamps and the ceiling.

For special occasions, small table lamps with candle shades add to the table decorations very materially. Any such device as this should be served from the floor sockets provided for use with toaster, percolator, chafing dish, etc.

The kitchen is often neglected. Dependence upon one central lamp, placed low by use of a fixture is poor design. If one outlet only is provided, place the lamp high enough so that the upper walls will give indirect illumination of objects near the sides of the room. Unless the ceiling is low, however, additional diffusion may be secured by dropping the lamp a few inches from the ceiling so that light, naturally directed upward may be reprojected from a considerable ceiling area. A semi-transparent reflector should be used.

A much better distribution of light will occur and localized illumination will be more satisfactory if the unit fixture is divided into several parts and each is put at some vantage point. Such

locations would be over the table, the sink and the stove. When lamps are so placed, the housewife does not stand in her own light when standing at any of these points. With the central light she is always working in her own shadow. The subdivided lamp units should still be put high enough to afford a good general illumination.

Utility wall sockets should be provided in the kitchen for whatever heating, cooking or small motor units may be used there. The presence of an electric range or fireless cooker calls for special wiring which is aside from the circuits used for lighting and small utilities.

Bedrooms need good local lighting at the dressing table and the mirrors, and a medium general illumination. The lamps may best be placed one on each side of the table or mirror and so installed that they are somewhat adjustable as regards position. Each unit should be well shaded so that it presents a comparatively low intensity to the eye and may therefore illuminate the face without any glare effects. For hair dressing, the light must be high enough to give good visibility of the coiffure. A light for shaving is sometimes supplied in the bedroom, especially if there is running water there. This light must give sufficient illumination from a low source to eliminate the shadows under the chin. Good diffusion of light helps in each of these cases to do away with shadows of the hand. On this account, a light colored wall helps very materially toward securing the desired effect.

If the bedroom is large, there may be several points needing local lighting. These collectively will provide enough general illumination. Economy may dictate individual control of all these lamps, however, in which case the source used for the general lighting should be controlled from a point near the door.

Bathrooms.—It has become evident that a little extra emphasis should be voiced upon the subject of safety of electrical circuits in bathrooms, laundries, and other places where good ground connections can be made by merely touching a water pipe or by standing upon a register or a damp cellar floor. For example, in a bathroom, one or two wall brackets may be installed by the mirror, usually placed just above the wash basin. These are almost universally controlled at the socket switch. One hand may reach the lamp with the other upon the metal water faucet. This constitutes a distinct hazard unless the metal

fixtures are grounded or unless non-metallic fixtures are used. Wall switch control of circuits is good practice, while pull chains are to be recommended in case the wall switch has not been installed.

The location of lamps as above indicated, namely, upon each side of the mirror, is correct. Diffusion should be good and intrinsic brilliancy of the units should be reduced by ground glass shades covering the lamp well.

Halls are generally oblong in shape. If this shape is emphasized, the problem of illumination can be solved only by subdivision of the light source into two or more units. An intensity of one foot-candle is generally plentiful for lower halls, while upper halls need only about half this amount. If the hall merges into the living room, it is important that it be treated in about the same way that the latter is, so that no distinct contrast of effects be produced. Depending upon the special features by which the hall plans may differ from the ordinary plans, the lighting should serve to repress the hall and emphasize the living room. It should "invite one from the hall, into the living room."

Stairways constitute one serious problem usually connected with hall lighting. Especially troublesome are they, if they have landings at which they change direction. The attempt should be made to make the edge of the step distinct to the vision. To do this, it must differ in its illumination from the rest of the tread or from the riser. The amount of light should be at least as much as in the adjacent hall, or one coming suddenly through the hall to the stairway will not see the steps well. Direction of light flux from the lower hall is a handy means of controlling the comparative illumination of tread and riser. Varying the light upon front and back of the tread may be accomplished by low intensity light directed at an angle from above the top of the stairs. Direct glare must be avoided, or even good illumination of steps will fail to provide safety. Ceiling fixtures are generally used.

The circuits should have control switches at the upper end of the stairway as well as below.

Porches need only sufficient light to enable one to use the steps safely. This will also let the resident identify the caller. A light of this intensity will also effectively protect an entrance from the prowler or sneak thief, provided there is no easily opened outer storm vestibule. Control of lights is from within, although

a secreted control button on the porch may assist one in effecting a prompt entrance on a cold or stormy night.

Cellars need light upon the stairway and at the working points. This latter may be the coal bin, furnace, the vegetable cellar, etc. One lamp may serve two of these points, though seldom more than two. Separate control promotes economy. Circuits which are liable to be left closed should be provided with small pilot lamps so located that they cannot be overlooked.

If the *laundry* is in the cellar, it may well be upon an individual circuit. The illumination should be rather high, despite the fact that it is used only in the daytime. Dark days are trying ones in the laundry because a mixture of daylight and artificial light always requires a greater amount of the latter than mere supplementary figures seem to demand. This is noticeable in any installation, office, factory, etc., during the early morning hours or late in the afternoon. Probably it is somewhat a matter of requiring that the light have a predominant direction in order to give definition of form.

Color of light is also of considerable importance in a laundry. The carbon filament lamp is very ineffective in revealing stains or dirt on clothing. For example, perspiration stains are yellowish in color and are minimized under a carbon lamp light, if they do not even entirely disappear. This can in part be overcome by more intense illumination although the color of high efficiency mazda lamp light is much more effective. In fact, if the lamp were available in small flexible units, the blue-green light of the mercury-vapor arc would be an excellent thing in this place.

Placement of lamps should be studied so that one will not have to stand in her own light for any of the processes. The tubs and the ironing board constitute the most important points. Plug sockets are needed for flat-irons, washing machine motor, etc. Safety of installation must be fully developed as pointed out in discussing the bathroom. This is imperative and should be a matter of thorough inspection by the proper authorities. Responsibility for the maintenance of circuits and apparatus in good condition should be impressed upon the householder, because it is impossible to keep floors dry even with a board covering upon the cement cellar bottom. At the ironing table, a wooden platform is a real protection from accident and should always be insisted upon.

Throughout the whole cellar, any fixture which must be handled should be made of porcelain or composition. Failing in this, exposed metal parts should be grounded.

Other Rooms.—Besides the foregoing parts of the average house there are often other portions which vary considerably in their relative importance. Music rooms, sewing rooms, dens, libraries, second parlors, vestibules, etc., may be individual rooms or may blend into certain of the other rooms as a matter of choice or of necessity. We may comment upon these briefly in the order mentioned. Their treatment will of course be entirely a matter of the degree of individuality or independence afforded to them in the building plans.

A *music room* often constitutes one end of a living room, or an adjacent room easily opened by large double doors to throw it into communication with other portions of the house. Low, general indirect illumination with well hooded lamps giving good light upon the piano and music racks will meet the demands successfully.

The *sewing room* will need excellent lighting. Naturally, daylight alone will be used for nearly all work here. When artificial light is needed, however, it must be of the best as regards color and intensity. A fair diffusion with a considerable directional flux component will give the best results. The amount of light should be subject to easy variation to make it suitable for sewing upon light material or upon that which is very dark. Wall sockets should be provided for sewing machine motor and for pressing iron.

A *den or a combined den and study* is the most personal room in the house. Individual tastes account for such a wide variety of furnishings and effects that the lighting intensity should be subject to a rather wide control. The brilliant illumination needed to reveal the curios and decorations is not consistent with the coziness of subdued illumination so much enjoyed in entertaining a friendly caller or in the comfortable perusal of a favorite book. Ceiling fixtures are needed for the more general illumination. These are abandoned for a desk lamp or for a reading lamp over the head of the lounge when the exhibition is over and conversation or musing or reading begins.

The *library* lighting serves the double purpose of showing the titles of books ranged in their cases or upon the shelves, and illuminating the page being read. The former demand is met by

ceiling fixtures or hooded lights above and in front of the shelves. A special reflector is used if this lamp position is chosen. Reading lamps upon the library tables or the tall floor standard lamps serve the second purpose perfectly. Floor sockets are needed in this room.

Second parlors need only a medium illumination intensity with a fair diffusion. Central fixtures of the direct type or semi-indirect type are quite satisfactory for ordinary sized rooms. As in all cases where central fixtures are used, diffusing shades should be installed to lower the brilliancy of the visible source of light.

Vestibules are small enough so that all purposes are best served by illuminating them from a ceiling ball or bowl. Low intensity is satisfactory.

CHAPTER XV

GENERAL OFFICES

(Accounting Rooms, Drafting Rooms, etc.)

The general lighting requirements for offices are about alike. In nearly all cases, the conditions which exist present level or slightly sloping desks or tables with polished surfaces; glazed white books, papers or other working materials; little need for "form" vision; occasional shifting of the office furniture. The particular in which there is the greatest diversity is that of the closeness of detail required, or the grossness of the objects viewed, size of print, fineness of penmanship, intricacy of the drawing, etc. A consideration of these particulars leads one at once to the conclusion that the best lighting for such service will be obtained by use of the indirect methods. Certainly, a well diffused light is needed in order to avoid glare in any of the many situations about the room which may at one time or another represent a working position. Drafting rooms may be considered in connection with offices if the requirements are studied and compared. There are the same flat surfaces, white working materials and fine line work which demand well diffused light which will give no glare and will dissipate shadows. In the matter of shadows, the drafting room is probably more exacting than other rooms, because it is necessary for a draftsman to put his triangles in every position without having confusing shadows appear on his paper. Head and hand shadows are also annoying.

Two considerations affect shadow conditions, the relative positions of the desk and light source and the amount of diffusion of the light. In small rooms having central fixtures, with desks placed around the walls, it is not an easy matter to avoid shadows on the working area unless the walls are made a strong secondary source of light. They should not be white and glossy, but they should be light colored enough to reflect a large part of the light incident upon them, and matte enough to avoid specular reflection. The ceiling may be white. Its coefficient of reflection should be very high. Great care must be taken to avoid any appearance of blotches of light on either the ceiling or the walls.

Intensities.—It has been found by Macbeth that the actual illumination intensities in offices will vary from the insufficient figure of 0.5 lumen per square foot to the unnecessary value of forty lumens per square foot. Probably ten to fifteen foot-candles will meet every demand, even including the cases of individuals who have defective vision and therefore require an abundance of light for the comfortable performance of their duties.

In offices as in other interiors, there is now no reason for declining to furnish good general illumination, on the ground of economy. The great advantage gained by late increases in the efficiencies of illuminants should be appropriated by bettering the lighting, not by saving a little in the cost. Here, as elsewhere, the direct expense of increased fatigue, lowered efficiency and speed, and lost time soon doubles and even manifolds many times the saving in installation and operation costs. The local desk lamps should be condemned, especially if they are of the portable, adjustable type. Each user will arrange his own lamp to his own greatest satisfaction, and the result will be an unsightly array of lamps and cords, light shining up into the eyes of half the users and glaring into the face of anyone who raises his eyes from his desk to glance around. The visitor is repelled by the ensemble, rather than attracted by it.

Calculations.—With the indirect or semi-indirect installations, it is most satisfactory to make our calculations upon the basis of total light flux from the combined unit of lamp and reflector, together with the utilization factor found to apply for the type of conditions existing in the particular case.

If the physical dimensions of the room, its beams, bays or columns do not determine the lamp positions, it is well to assume a spacing of from one to one and one-half times the height of the ceiling. A simple calculation based upon the illumination intensity sought and the area to be lighted gives the total light flux to be divided up among several lamps, and this gives us the effective flux which must be supplied by each lamp. The next step is to make a choice as to the type of installation to be adopted, whether it will be indirect or semi-indirect. When this stage has been reached, we are in a position to make a close estimate of the factor of utilization for the room.

The factor of utilization, being defined as that fraction of the light flux which becomes useful by illuminating the working

plane, is a figure which depends upon (a) the type of installation, with its shades and reflectors, (b) the reflection constants of the ceilings and walls, and (c) the proportions of the room. The greatest factor will occur for direct lighting, with large rooms, where the walls cut off little or none of the light. Only a portion of the light falling upon the walls will be reflected to the working plane. Under some conditions of light distribution, the wall and ceiling have almost no influence upon the result, because the reflector prevents light from falling upon them, but directs the flux into the lower solid angle. The table of values for this coefficient of reflection is given (Table 34). It is taken from Bulletin No. 35 of the National Lamp Works.

Dividing the effective lumens per lamp by the coefficient obtained from the above table, we arrive at a figure representing the lumens per lamp, or the size of the lamp. In making the final choice of lamp size we must remember that there will be deterioration of both lamp and reflector, which will cut down the illumination by a very perceptible amount. It is customary to provide about 20 per cent. more light than is needed at first. Much of this loss can be prevented by a systematic renewal of lamps, the cleaning of lamps and reflectors, the maintenance of walls and ceilings in a good condition as diffusing reflectors.

If several rooms are to be lighted, or if the installation compasses an office building, economy is served by so choosing the lamp that the same sized unit or units may be used throughout. This also introduces the pleasing effect of uniformity.

In rooms where there is a considerable likelihood of having the office furniture changed occasionally, either in position or in nature, where tenants come and go, it will frequently pay to use smaller lamps than are originally called for, placing them in such a manner that a good uniform illumination may be secured even with temporary partitions put in to cut the large office up into several small ones. Such a calculation restricts the zone of influence of each lamp. Initial cost and maintenance may both be increased but they are balanced against adjustment expenses such as the moving of outlets, the making of new ones, the replacement of small lamps by larger ones, the changing of accessories, etc.

TABLE 34.—COEFFICIENTS OF UTILIZATION

This table applies to installations in square rooms having sufficient lighting units symmetrically arranged to produce reasonably uniform illumination. To obtain the coefficient for any rectangular room, find the value for a square room of the narrow dimension and add one-third of the difference between this value and the coefficient for a square room of the long dimension.

Reflector factor	Ceiling.....	Walls.....	Light, 70 per cent.									
			Light, 50 per cent.	Medium, 35 per cent.	Dark, 20 per cent.	Medium, 35 per cent.	Dark, 20 per cent.	Dark, 30 per cent.				
			Light, 50 per cent.	Medium, 35 per cent.	Dark, 20 per cent.	Medium, 35 per cent.	Dark, 20 per cent.	Dark, 30 per cent.				
Indirect, deep bowl of mirrored glass	90° to 180°—80 0° to 90°—0	Ratio $\frac{m}{h}$ Room width Ceiling height	1	0.22	0.19	0.17	0.14	0.12	0.07			
			1.5	0.27	0.24	0.22	0.17	0.15	0.09			
			2	0.31	0.28	0.26	0.20	0.18	0.11			
			3	0.36	0.33	0.31	0.24	0.22	0.13			
			5	0.42	0.39	0.37	0.28	0.26	0.16			
			Semi-indirect, shallow bowl of dense opal	90° to 180°—70 0° to 90°—10	Ratio $\frac{m}{h}$ Room width Ceiling height	1	0.24	0.21	0.19	0.16	0.14	0.10
						1.5	0.30	0.27	0.24	0.20	0.18	0.13
						2	0.34	0.31	0.28	0.23	0.21	0.15
						3	0.39	0.36	0.33	0.27	0.25	0.18
5	0.45	0.42				0.39	0.32	0.30	0.21			
Semi-enclosing, opal bowl with diffusing plate	90° to 180°—20 0° to 90°—60	Ratio $\frac{m}{h}$ Room width Ceiling height				1	0.32	0.28	0.26	0.27	0.25	0.23
						1.5	0.40	0.36	0.33	0.34	0.32	0.30
						2	0.45	0.41	0.38	0.39	0.37	0.35
						3	0.52	0.47	0.44	0.40	0.37	0.40
			5	0.59	0.54	0.51	0.51	0.48	0.46			
			Open reflector of dense opal, with bowl-frosted lamp	90° to 180°—20 0° to 90°—60	Ratio $\frac{m}{h}$ Room width Ceiling height	1	0.41	0.37	0.34	0.35	0.33	0.32
						1.5	0.49	0.45	0.42	0.43	0.41	0.39
						2	0.54	0.50	0.47	0.48	0.46	0.44
						3	0.60	0.56	0.53	0.53	0.51	0.49
5	0.67	0.63				0.59	0.59	0.57	0.54			

CHAPTER XVI

STORE LIGHTING

Stores vary so greatly in the classes of merchandise exhibited, in arrangement and nature of displays, etc., that the demands cover a very wide range. In large installations economy of operation is a very live subject. It is of less importance in small stores, but should never be ignored. Color, diffusion, distribution, unity, are all phases which must receive attention.

In a broad sense we may make for any lighting installation the primary demand of a sufficient illumination for careful examination of the goods. In some kinds of stores such as jewelry stores, a brilliant light is needed for the sake of showing the goods to advantage. The same is not true of a shoe store or with general merchandise. The phrase "sufficient illumination" must therefore be interpreted in each case, for the wares displayed.

The distribution and diffusion of light is of next importance. Here, again, no one condition satisfies all requirements. If a piece of cloth is illuminated by light coming equally from all directions, its fabric cannot be well discerned. It will appear flat and characterless. A considerable component of directed light must be used to show its weave or texture.

The color content of artificial light is another item which must be taken into account in many stores. Wherever color of materials is of any importance, the illumination must be high and the light must have a near-daylight spectrum. As nearly as possible goods should be inspected and chosen under the same lighting conditions as those under which they will be used. Evening apparel may look quite different under artificial light from what it does by daylight.

The general conditions also require a full appreciation of the importance of the comfort and convenience of the customers. People will avoid stores where the lighting is poor and materials have to be carried to the window or to a well lighted spot to be examined. Lamps hung too low or improperly shaded may cause actual discomfort to clerks and public alike.

It is extremely bad practice to install any store lighting system in such a way that a lack of uniformity of illumination is evident. The result should be a unit and it should come from a designed installation which also shows uniformity of purpose and method. In the ordinary case it is rather dangerous to emphasize the lighting system until it becomes self-assertive. It must draw attention to the goods and not away from them. In the most successfully lighted stores, the visitor does not see the lighting devices, but entirely forgets that there are such utilities present. He does not recall having seen whether direct or indirect fixtures are used, clusters or units, shades or globes. But he does remember that the changeable colors of the necktie were very evident even in detail; that the gray hat matched the gloves perfectly; that the tie pins sparkled alluringly.

Large stores are most economically served by direct lighting. Ceilings are high enough to permit proper elevation of fixtures. The major part of the light is thrown down to a rather restricted area, directly below the lamp. Distant lamps are, therefore, not glaring and only by looking up at a sharp angle can an excess light meet the eye. No store displays its goods so that the customer need face this over-head lamp.

There are no walls to reflect light, and hence, the diffuse illumination needed upon the working plane must come from nearby lamps. Globes permit this. When reflectors are used the spacing of lamps must not be too great to allow for it, also. The areas lighted by individual lamps must overlap. A reflection from a light colored ceiling of such light as goes upward, will aid, materially in diffusion of light. In this connection it is well to point out as Macbeth does that a diffuse illumination is the effect produced by light striking the object from various directions, and it is quite a different thing from a diffusion of light emission from a source. For a room with dark walls and ceiling, a shade or globe which gives diffuse emission from a single source cannot give diffuse illumination. Shadows will still be heavy.

Indirect fixtures are not ordinarily chosen for such large stores as we are now considering, although they are permissible. Semi-indirect lighting is, however, frequently used. The architecture of the room should influence the choice made and the treatment.

Small stores are generally lighted by a row of lamps or fixtures placed along the center of the room. These rooms are about

25 feet wide and of lengths varying from 40 feet to 100 feet or more. In stores which depend upon their shelf displays and their wall cases, a considerable part of the light from the central row of lamps must be thrown out fairly near to the horizontal in order to reach the walls. Very little of the light which falls upon the walls thus occupied by shelves will be reflected to the counter tops. If good illumination is required there also, it must come largely from the ceiling and the lamps. The latter predominates, and hence, the customer usually finds himself in his own light. For good illumination intensities upon the walls or the counters, it is much better to put in two rows of lamps, one row over each line of counters, about even with the front edges. In no case should the reflectors be opaque as this would make the ceilings dark and give the double effect of a low diffusion and a considerable contrast. Prismatic glassware will serve well. It is available in types suitable to give any distribution needed. Plain, translucent globes are not very satisfactory, because they do not give an accurate control of the flux.

Even in the small store, there are occasional places where a local light is required. These departures from the general scheme of treatment should be as unobtrusive as possible.

Exclusive Stores.—In the larger cities, there are frequently found stores catering to an exclusive trade. The lighting here is quite special and may well be highly artistic. Efficiency is a minor consideration. Effectiveness and beauty are the prime elements controlling the design. The direct lighting unit has small place in this line of work. Individuality may permit the most extreme treatment.

Kinds of Merchandise.—The dependence of the lighting upon the merchandise handled may be discussed for large and small stores alike. Some differences exist of course, in the arrangement of goods even of similar kinds, but generally these may be easily recognized. The illumination must be designed in respect both to the merchandise and its placement.

There are numerous examples of goods which are always placed on vertical planes when they are displayed. Others are oftentimes so placed. We may mention in these groups different classes of art goods and many furnishings—paintings, tapestries, curtains and even rugs. Other merchandise which may lend itself well to this arrangement for display includes hardware, books, clothing, package goods, etc. All such wares need a good

wall illumination. The light must be thrown upon them with a large horizontal component.

Upon the other hand, jewelry stores need brilliant illumination upon the counters and in the cases. Drygoods, furniture, stationery, general merchandise, etc., are similarly classed, and the working plane is the important one. While direct lighting is most satisfactory for jewelry, cut glass and silverware, the other lines mentioned will admit of semi-indirect systems. For prismatic effects the direct light gives much greater brilliancy.

Some stores must have high general illumination. In this group we find clothing stores, furriers, millinery shops, groceries, drug stores, book stores, bakeries, ten-cent stores, etc.

Local lighting already mentioned will be needed in jewelry stores, barber shops, etc., and over accounting desks or cashiers' desks.

Efficiency of Utilization.—Bulletin No. 29 of the National Lamp Works presents a table showing the percentages of total flux which becomes effective flux in installations of various types. These values are presented in Table 35, and are self-explanatory.

TABLE 35.—EFFICIENCY OF UTILIZATION IN STORES OF DIFFERENT SIZES, LIGHT CEILING AND MEDIUM WALLS ASSUMED

Type of lighting unit	Department and large specialty stores	Stores of medium size	Small stores
Open prismatic	0.55	0.45	0.35
Open opal { dense	0.53	0.44	0.35
{ light	0.48	0.40	0.30
Semi-enclosing	0.49	0.41	0.32
Totally enclosing prismatic	0.46	0.40	0.33
Totally enclosing opal, dense	0.43	0.34	0.24
Semi-indirect opal { dense	0.42	0.35	0.25
{ light to med	0.45	0.38	0.28
Semi-indirect prismatic	0.42	0.35	0.25
Totally-indirect mirrored glass, opaque or luminous bowl	0.38	0.32	0.22

Lamps to be Used.—As will be seen by reference to the data tables upon incandescent lamps (Table 30) the efficiency of the gas-filled lamp is superior to that of the vacuum unit. In the present considerations, lamps of considerable size predominate in the installation, and their efficiencies are higher than those of

smaller lamps. The conclusion is that cost of operation may be lowered by using Type *C* mazdas of sizes as large as is compatible with other features of the system.

Color-matching lamps may be required in certain situations. They are of the types already discussed, gas tube with CO₂ or mazdas with color screens or blue glass bulbs.

Show cases are nowadays lighted individually by use of special fixtures capable of being mounted within the cases at the upper front edge. The light is thrown downward and backward, the shade or reflector being opaque and shutting off all light emission toward the observer. There have been developed for this service numerous trough reflectors in which may be mounted small round-bulb lamps or the later long-tube, straight-filament lamp. Macbeth states¹ that the illumination in the case should approximate twice that of the room in order to attract attention and lessen the necessary handling of goods. This will require about 150 lumens per foot length of case. High efficiency vacuum lamps and reflectors should be used and the interiors should not be allowed to overheat, especially where perishable goods are shown. The fixtures must be as small as practicable. The wiring is enclosed in metal conduit. Where cases are to be used for variable showing it may be necessary to use more light for the darker displays than for the light colored ones. Two circuits may be necessary in this instance.

Store Windows.—Window lighting is one of the places where the majority of installations are not up to the proper standard. This is not because of the difficulty of the task, for any setting may be properly illuminated; but the work is special and therefore has not been well handled. Anyone, in a few minutes upon the street in the evening, can find rank crudities in the way of window lighting. Occasionally he may see even a bare lamp suspended in the middle of a small window display, shining into his eyes at least as brightly as upon any part of the setting.

The illumination must be greater than the surrounding illumination or the observer will not be attracted. The window must be bright enough to call the attention away from other things. The light must largely come from the front and top of the window. Diffusion of light must give diffuse illumination capable of reducing the intensity of shadows enough so that objects in the shadow

¹ *Illum. Eng. Prac.* (Lectures 1916), p. 363, "Office, Store and Window Lighting," MACBETH.

may be seen. A light finish to the woodwork aids here materially, and with a dark finish the problem of diffusion may be hard to solve. Mirrors can be used to help in this and to throw light upon the sides or back of the display. When so installed, they must not be at the level of or in a position to reflect light directly into the eyes of the observer. This condition is easily imposed, inasmuch as the reflection is specular. Of course, this limits the window design quite materially.

In planning any particular installation, one must first study the dimensions of the window as to height and depth, locate the line of trim and note the probable characteristics of the goods to be shown. In the first particular, windows may vary from a height of six feet to twelve, with an average value of about nine feet. The depth from front to back may be as much as twice the height or it may be as little as one-third of the height. The line of trim is a curved line starting near the floor at the front and rising more and more steeply toward the back of the window. It may not rise to the full height of the rear wall, in fact, it rarely does reach this high. This line runs through the average front of the goods displayed, and thus represents the line to which we will measure distances from the lamps in making any direct illumination calculations. Finally, the consideration of the albedo of the wares displayed will give a means of determining the amount of flux required. In general, the same window will be used at different times for widely varying goods—white, colored, dark—and the safest thing to do is to design the lighting for the darkest condition expected.

When these data are compiled, the position of the lamp and the length of the line of trim will determine the width of the angle of light emission. This will never need to exceed 90 degrees, although oftentimes a lesser amount of light is allowed to fall upon the walk at the base of the window. Again, in case of a dark background and a light colored ceiling, some diffusion from the ceiling is a good thing.

If the height of the window equals the depth, the lamp is about the same distance from the floor end of the curve as from the upper end. Uniformity of illumination will be attained by the use of a uniform flux emission. In general, the depth is not as great as the height and a uniform illumination requires that the distribution curve of the lamp and its reflector shall show much more downward flux than that thrown in a horizontal direction.

The reflector should be a high efficiency unit and it is evident that it should be of the unsymmetrical type. A trough reflector or a series of unit reflectors may either one provide the proper agency.

It is well to lay off the window cross-section to scale, show the line of trim, and the position of the lamp all upon one figure. A calculation then may be made for the flux distribution curve needed in order to get the proper relative illumination intensities, diffusion neglected. This will give a means of selecting the type

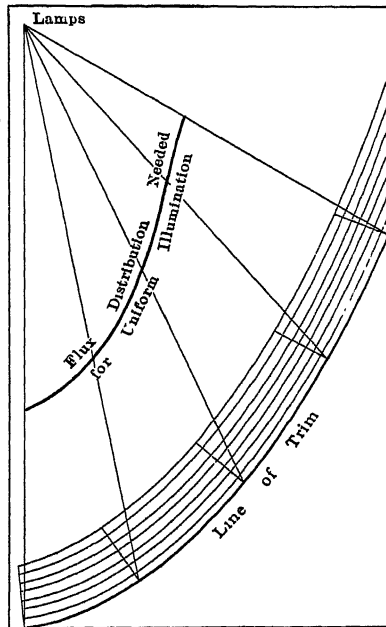

FIG. 83. To find light flux distribution needed for uniform illumination of given store window.

of reflector. Fig. 83 illustrates this. Now by adjusting the spacing of the lamps along the row, this intensity may be made high or low at will.

The efficiency of utilization for an installation of this type will depend very largely upon the reflectors used, and the attention given to keeping them clean. A good average lighting condition will probably be established by having the surface of trim receive from 200 to 300 lumens per running foot. For high illumination of the medium sized window, 300 to 500 lumens

effective per running foot will suffice. These values divided by the efficiency of utilization, will give the lamp output in lumens per running foot. The highest efficiencies will give about a 60 per cent. utilization factor. The other values range downward in a rather indefinite manner, to as low, perhaps, as 20 per cent. It is important, especially with the lower efficiency installation, that the lamps should be placed so that no window trimmer can place material of an inflammable nature against them.

The lamp row must be hidden from the observer. This may be provided for in the building plans by a built-in recess just behind the glass. Ordinarily this is not done, and a valence or screen has to be dropped in front of the lamps. This should be decorative and may bear the firm's name in translucent letters. Frequently there is painted directly upon the glass a band wide enough to conceal the fixtures.

It is good practice in the case of high intensity illumination of closely confined cases or windows to provide for ventilation. As mentioned in connection with show cases, the vacuum lamp is preferable if adaptable. This is because it does not reach such high temperatures as a gas-filled bulb does.

CHAPTER XVII

FACTORY LIGHTING

The factory demands good lighting, for three very important reasons. Without reference to the relative weights of these factors we may list them as follows:

1. To provide safety and comfort.
2. To increase output (or save time).
3. To give greater accuracy of workmanship.

Any one of these items may be stated more or less accurately in money value and will undoubtedly represent a direct financial gain.

For example, in these days of workmen's compensation laws, insurance of laborers, etc., accidents represent expense. Again, time lost in the working day due to the necessity of closer attention to work, resting the eyes, stopping the machine to inspect the result will quickly mount to considerable money loss. It has been shown in many instances that a loss of only 5 to 10 minutes during the day will introduce a loss equal to interest upon investment for a good lighting system and the cost of operation. Spoiled work will similarly more than offset the expense of good illumination.

Government authorities are taking cognizance of the needs in this line and establishing rulings which govern illumination in shops and factories. This movement has not progressed far yet but it is proceeding along fairly substantial and reasonable lines and will eventually be widespread.

With constantly decreasing costs of lighting, the economies are more strongly emphasized than ever before and higher lighting intensities are adopted. Good general illumination comes within the range of practice, displacing mere local illumination or making it less common.

Clewell¹ gives the principal requirements of factory lighting in the following terms:

¹ *Illum. Eng. Prac.* (Lectures, 1916), p. 344.

(a) Sufficient intensity of general illumination over the floor area to prevent accidents and to make it possible to handle material and to get around the machinery readily.

(b) Sufficient intensity of the illumination at the point of work, usually a higher intensity than in (a) although it is practical in some cases to make the intensity of the general illumination for both (a) and (b).

(c) The use of suitable shades and reflectors with the lamps mounted in such positions as to avoid eye-strain.

(d) The electric circuits and gas mains of sufficient size to assure normal working pressures of the supply at all times.

(e) In addition to (d) the supply should be adequately protected against interruption of service.

(f) The size of the lamp should be in accord with the ceiling height of the section where it is employed, particularly where the entire illumination is furnished from lamps overhead, that is to say, where no individual lamps are used close to the work.

In considering the parts (a) and (b) above, it has already been pointed out that the present day tendencies are toward a good general illumination with a restriction of local illumination to the lowest possible limits. Rough work will be properly provided for with low general intensity. If the manufacturing processes involve the use of a large number of small machines which are close together, dependence should still be placed upon the general illumination, although the intensity may need to be high. Fine work may require the installation of a few individual units, but when they are used, care must be taken that they do not annoy one workman while assisting another. Thus, glare from any cause must be eliminated. It is recognized without any need of argument that the voltage must be absolutely steady. No flicker can be permitted.

As was the case in the discussion of the large store, it is economy to use as large lamps as can be adopted and still secure the proper distribution of light. Sometimes, the larger lamp with a necessarily greater reflector loss in order to get the proper effect, will prove to be more economical than a design involving smaller lamps more directly applied. If the design is so developed that the flux is directed toward the working plane, the total amount of light falling upon that plane will be the same for different heights of lamp, except for possible increased reflector losses. The diffuseness of the illumination will be better, however, for high

suspension. It follows that the lamps used for general illumination should be placed as high as possible without introducing troublesome shadows of beams, etc. At any rate, the work of cranes should never carry them out of the lighted space, and the lamps must be placed above such apparatus. In numerous plants, the lamps are within a foot or so of a ceiling twenty or thirty feet high. Such plans permit the use of the high-efficiency, large lamps.

In some rooms, the day lighting may lack uniformity to such an extent that a cloudy day will throw a part of the room into darkness. This, or any other cause which suggests the need of illumination of only part of the room indicates that control of the lamps in small groups will often work toward economy.

The required illumination for a large number of different kinds of labor are shown in the Table 22, p. 152. It may be assumed that a large part of all materials handled in factories is dark colored. Where there is an exception to this it will be easily recognized, as in making garments, where the stock handled may be uniformly light shirting cloth, etc. The depression of the utilization factor with age of the installation depends upon maintenance and cleaning. These have been touched upon in the chapter on shades and reflectors.

Lamps.—In this field as in others, the arc lamp is being replaced in many cases by the modern, large sized, gas-filled mazda incandescent lamp. This is brought about by the high efficiency attained by the latter. It is of great importance to note, however, that the arc lamp never was at all satisfactory for this service from the standpoint of steadiness. Its persistent flicker threw it completely out of the running, for all of the more particular work. Its use has always been limited to the coarser work, store-rooms, etc. Now it is being pushed out of much of this field.

The mazda lamp, Type *C*, is almost universally suitable for factory purposes. It is available in a great range of sizes and gives good efficiencies and color. The flux is redistributed by reflectors without great loss. The light is steady. Despite the fact that the inherent brilliancy of the unit is high, when suitably served by accessories and properly placed, the lamp does not become offensively glaring.

The mercury vapor lamp has made a place for itself in general illumination, where color is of no particular moment. Store-

rooms, docks, printing plants, drafting rooms, laundries, etc., can very satisfactorily use this lamp. It is available only in comparatively large sizes.

Reflectors.—The direct type of fixture is always first choice in factory rooms of any considerable size. Exceptions to this are not impossible but they are unusual. A need of very good diffusion in a room with a low, light colored ceiling, may strongly suggest the adoption of a semi-indirect system.

For the direct system, several types of reflectors are available and satisfactory. The metal reflector, with its various finishes already discussed, gives a substantial and fairly permanent device. They are comparatively cheap. Their surfaces have enough difference in reflection, however, so that one must know before determining upon the finish to be used, whether a diffuse reflection is needed or if the accurate control of flux is necessary. The metal reflector, as well as any other opaque reflector, will not permit the illumination of the ceiling. Practically all flux of light is direct, therefore. The same will be true of the "bee-hive" and "jumbo" mirrored glass reflectors of the X-ray type. The latter have a very high efficiency of reflection, however, and so far as emission is concerned, diffusion occurs. When such units are installed, the areas lighted by adjacent lamps should overlap, from center to center.

Shallow, opaque reflectors with annular corrugations are sometimes used, also. They are commonly called diffusers. They do not cut off the light from the walls but serve to redirect that flux which normally rises. If the diffuser is flat enough, some of the flux may even reach the more distant parts of the ceiling. This type of fixture should be accompanied by the white walls and ceiling.

Calculations.—The fundamental criterion of a lighting system has already been pointed out to be the sufficiency of the illumination. The process of calculation, therefore, begins with an estimate of the required flux intensity upon the working plane and its uniformity of distribution, or its placement in special locations. These calculations are made as in any other installation and proceed along the same lines.

Cost enters immediately into the problem, when once we have determined that there are more ways than one of obtaining the desired result. But cost must be divided into the two parts, under the headings of installation cost and operating expense.

Each one will have its effect upon the final choice made. It may develop in the comparisons made that two reflectors costing different amounts are equally effective. Or, we may find that the installation of a more expensive reflector will increase the effective flux by an amount well worth the extra cost.

For example, we estimate the total effective flux required as the product of area and required foot-candle intensity. We can then assume a utilization factor which seems suitable to the conditions of room dimensions, wall colors, etc., and derive the figure for lumens output of lamps. In spacing the lamps, it is well to start with them at points distant from each other about 50 per cent. greater than the height of the lamps from the floor. This gives a first choice of number of units to serve the given floor space. The size of each lamp or cluster is then derived from the number of lamps and the total flux requirement. Flux distribution curves may then be chosen and the resulting illumination determined.

The cost of operation is well analyzed in Bulletin No. 20 of the Engineering Department of the National Lamp Works. Introducing mazda-C lamps instead of the Type B lamps there used and revising the tables accordingly, we have the data shown, where the total operating cost is divided into three parts.

“First.—Fixed charges, which include interest on the investment, depreciation of permanent parts, and other expenses which are independent of the number of hours of use. Frequently this item forms the greater part of the total operating expense, yet it is only too often omitted from cost tables.

“Second.—Maintenance charges, which include renewal of parts, repairs, labor, and all costs, except the cost of energy, which depend upon the hours of burning and the rate per kilowatt-hour.

“Third.—The cost of energy, which depends upon the hours of burning and the rate per kilowatt-hour.

“The life of a lighting system depends not only upon the wearing out of parts, but also upon obsolescence. Although the lamps may be in good operating condition, economy may demand that they be replaced by more effective illuminants. The rate of depreciation on all permanent parts is equal to at least 12½ per cent. The investment required in the mazda system of lighting is relatively very low.

“A table which would show the total operating expense of mazda lamps for all sizes, with every discount from the list prices, for all possible periods of burning per year, and under all costs of power would be so large as to be entirely impracticable. From Table 36, however, the

operating expense of units under any set of conditions may be found with little calculation.

"The total investment includes the cost of lamps, reflectors, holders and sockets. The investment in permanent parts is the total investment minus the price of lamps. No depreciation is charged against

TABLE 36.—ANALYSIS OF OPERATING COSTS, MAZDA-C, 100-130 VOLTS

Size of lamp, rated watts.....	75	100	150	200	300	400	500	750	1000
Cost of lamp, list	\$0 70	\$1 10	\$1 65	\$2 20	\$3.25	\$4 30	\$4.70	\$6 50	\$7.50
Cost of lamp, std.-pkg discount	0 630	0 990	1 485	1 980	2 925	3 870	4.230	5.850	6 750
Cost of reflector, std.- pkg. discount	0 940	1 050	1 155	1.155	1.820	1 820	1 820	3.065	3.065
Cost of unit, std.-pkg discount	1 57	2 04	2.640	3 135	4 745	5 69	6 05	8 915	9.815
Annual fixed charges:									
Interest on total invest- ment, 6 per cent.....	0 094	0 122	0 159	0 188	0.285	0 341	0 363	0 535	0 589
Depreciation on re- flector, 12.5 per cent.	0.118	0 131	0 145	0.145	0 228	0.228	0.228	0.384	0 384
Labor, monthly cleaning.....	0 240	0 240	0.240	0 240	0.240	0 240	0 240	0 240	0 240
Total	0 452	0 493	0 544	0.573	0 753	0 809	0 831	1 159	1 213
Maintenance, cost per 1000 hr.:									
Lamp renewals at std.-pkg. discount ..	0.630	0 990	1.485	1 980	2.925	3 87	4 23	5 85	6 75
Lamp renewals at \$150-contract disc.	0.581	0 913	1 369	1 824	2 696	3.568	3 900	5 39	6 22
Lamp renewals at \$1200-contract disc.	0.511	0 803	1 205	1 606	2 373	3 139	3.431	4.745	4 775
Energy cost per 1000 hr. at 1c. per kw.-hr.	0 750	1 00	1 50	2 00	3 00	4.00	5.00	7.50	10 00

the lamps inasmuch as they are regularly renewed. The labor item under fixed charges provides for the cleaning of all units once each month. For the smaller units with Holophane steel reflectors, the cost of cleaning is taken as \$0.02 per unit for each cleaning. Data obtained from installations where accurate cost records are kept show that this figure is conservative for labor at \$0.20 per hour. The cost of cleaning other reflectors is taken in proportion to the amount of labor required. Some illuminants require attendance at regular intervals; the cleaning is done at the same time and is, therefore, included under the maintenance charge. For units which require no regular attendance, the cleaning expense becomes a separate charge. It will be noted that the fixed

charges form only a small part of the total operating cost for a lighting system. The folly of using cheap reflectors, which impair the efficiency of the units, is evident.

“The maintenance charge is given for a 1000-hour period of burning. To find the annual charge in any case, it is necessary to multiply by the ratio of the total hours of burning to 1000 hours. Where lamps are sold at other than the prices given, the proper correction should be applied. The renewal of lamps is the only maintenance expense.

“The energy cost is given for a 1000-hour period with energy at \$0.01 per kilowatt-hour. The energy cost per year is found by multiplying by the cost per kilowatt-hour in cents and by the time of burning in thousands of hours.”

An example will illustrate the use of Table 36. It is required to find the total operating expense per unit per year for lighting a mill with 500-watt mazda-C lamps. The lamps are burned a total of 4000 hours and are purchased at the discount obtained on a \$150 contract. The cost of energy is \$0.02 per kilowatt-hour.

From the table we obtain the following:

1. Fixed charges ¹	\$ 0.831
2. Maintenance $4.000 \times \$3.900$	15.600
3. Energy $4.000 \times 2 \times 5.00$	40.000
	\$46.431
Total.....	

¹ The value is taken as in the table. It will, of course, be reduced by the difference in interest on the lamp at the standard-package price and at the \$150-contract price. This difference is practically negligible.

CHAPTER XVIII

AUDITORIUMS

At first thought it seems surprising that for such large rooms as churches, auditoriums and ball rooms the indirect lighting is frequently used with excellent results. Upon the other hand, direct methods are recognized as being quite capable of giving good service in such cases. In general, the direct method has to guard against the great likelihood of glare. This may be accomplished by suitable enclosing glassware, which of course, cuts down the efficiency very materially. Another means employed for the same end is to subdivide the source of light into numerous small units and distribute them well, still properly shaded. This is accomplished in a small way by using a fixture with several lamps rather than a one-socket fixture. To carry this to the extreme of providing an enormous center chandelier is a reversal of results and bad glare again occurs. When dependence is put on multiplicity of lamps, they should be well scattered and kept high. This subdivision introduces another desirable possibility.

In many cases it is better to arrange circuits so that a reduced number of lights may be used for a part of the evening. In churches this provides relief during the sermon. In lodge rooms, certain parts of the rituals need low intensity lighting. Theater lighting is less annoying if it can be brought on in sections.

The center chandelier is not to be universally condemned for the auditorium. Naturally occupants of balconies are very apt to be disturbed and inconvenienced by it, but some ceilings are so high that it is quite possible to hang a central fixture well above the field of vision even of those in the back seats. The decorative features of this unit make its choice not at all infrequent. Few situations exist, however, where the mere illumination needs would not be very considerably better served by other methods.

The indirect lighting, of which mention has been made, is provided by central large unit fixtures alone or aided by cove lighting. Sometimes the latter is relied upon for the whole of

the illumination. One of the first striking examples of indirect lighting from side sources to be installed was that of the railroad station in Washington, D. C. The effect is good and at the same time rather striking. For narrow rooms, cove lighting is quite practical. It looks well with arched ceilings, provided the light is not thrown upon the ceiling in blotches.

If large bowls are suspended in the center of the room, they may be provided with low power lamps between the semi-transparent bowl and the high efficiency reflectors concealed therein. This keeps the bowl from appearing so dark against a well illuminated ceiling. The same purpose can be accomplished by finishing the outside of the bowl in white or old ivory. The general diffusion of light then illuminates this bowl enough to cause it to appear well lighted.

High efficiency reflectors should be used for all this indirect service and provision must be made for cleaning the reflectors frequently. This remark includes the central fixture which may be lowered by windlass.

An alternative, more or less partaking of each of the above methods, may be had by putting high candle-power lamps in a chamber above the diffusing glass ceiling of the room. This gives a low intensity source, as seen, provided the ceiling does not show spotted because of low-hung lamps or too concentrating reflectors. Sometimes the chamber itself is painted white and allowed to take much of the burden of diffusion.

The architecture of the room must be studied in the design of the lighting system and the choice of units. Ornate interiors must be furnished with similar fixtures, plain lines of architecture with similar fixture design.

Special effects are often required. For example in lighting ritualistic churches, the symbolic uses to which lights are put play some part. The sanctuary with its altar needs special treatment as do the choir stalls, the reading desks, etc. A chancel arch offers a suitable frame for support and concealment of some lamps illuminating this part of the church.

Numerous excellent examples of good and poor results of lighting churches, libraries, theaters, lodge rooms, etc., are shown in *Illum. Eng. Prac.* (1916) in lectures by Perrot and Vaughn.

CHAPTER XIX

SCHOOLS

School rooms are to be classified according to the visual acuity demanded in performing the usual duties for which they are planned. In nearly all cases, considerable eye-work of a rather taxing nature is demanded. The exceptions to this come in designing the lighting system for halls, gymnasiums and swimming pools, general assembly rooms, outer offices, etc. In the latter locations, a good general illumination of one to four foot-candles will suffice, provided the diffusion and placement are also taken care of in a proper manner.

Halls are likely to be long and straight with rather low ceilings. Fixtures cannot be placed out of sight, hence, the light must be controlled so as to give low intrinsic brilliancy from any primary or secondary source. This may be accomplished by small units, by indirect lighting, or even by large globes with good diffusing or directing features. Especially with direct lighting, the units should be placed as high as possible. Ceiling hemispheres of prismatic glassware are sometimes used very successfully.

No special comments need be made upon the audience rooms as they are quite similar to the cases already discussed for public halls or auditoriums.

A much more severe task is laid upon the engineer in providing for proper illumination of the work which requires close application of students seated at regular intervals over the entire space of the room. The light must be sufficient upon each desk. It must be fairly diffuse in order to cause no glare and to give no dark shadows. Its predominant direction must be such that the natural position of each student does not throw head- and hand-shadows upon his work. This directional characteristic is attained with light from left and rear with about 50 to 60 deg. slants. In order to provide a good working approximation to these conditions, the lighting fixtures should be well distributed over the area of the room, intrinsic brilliancy should be kept down, ceilings should be very light colored, walls not quite as light as the ceiling, while both the ceiling and walls must be

matte. Indirect lighting is peculiarly effective here. With present low costs of light production, whatever losses may be attendant upon indirect light transmission may well be afforded if it gives the most desirable distribution. Unnecessary losses due to lack of cleaning and delayed renewals must be avoided.

There are a great variety of conditions to be met in lighting school rooms for special purposes such as chemical laboratories with their desks and shelves; botanical or zoological laboratories with close microscopic work; museums and specimen cases; library stacks and reading tables; blackboards and wall charts or maps; manual training laboratories with wood work or metal work; foundry rooms with more or less dust and smoke; sewing rooms; art studios and exhibition rooms; drafting rooms; green-houses, etc. Each one of these needs individual attention. In some, the color content of light is as important as is the intensity. Where form is to be observed closely, light must have a predominant direction. An art class must have clear color vision. Color distinctions must often be made in comparing articles in specimen cases. Upon the other hand, drafting rooms and shops need "form vision." For such rooms the mercury vapor lamp is permissible. The same light is effective in illuminating the foliage in the green-house.

Reading and study tables in libraries are oftentimes very badly supplied with light. Lamps put directly in front of the reader are supplied with opaque shades which throw light directly down upon the book. Specular reflection is unavoidable and contrasts are great. Glare is serious. But all this can be avoided, by using a sufficient general illumination and economy can no longer be a justifiable argument against a good installation. In these days of new illuminants of improved efficiency the abundance of local desk lamps over the whole reading room is unnecessary. Interiors should be light colored. Direct or even indirect light may be used.

CHAPTER XX

ART GALLERIES

Some very excellent designs of art-gallery illumination are found in modern practice. One of the notable examples is that of the Cleveland Museum of Art.¹ The system was installed in a building already constructed and therefore, was adapted to conditions not wholly coöperative.

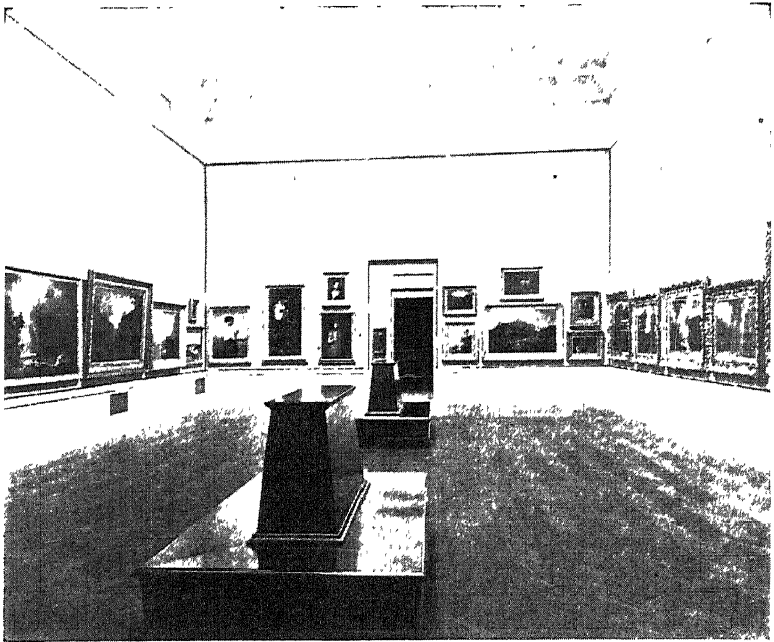

FIG. 84.—Results of artificial illumination of Cleveland Art Museum.

The features which characterize this installation most are the use of diffusing sub-skylights above which the lamps are placed, the use of daylight type of lamps (mazda-C-2) and the control of daylight in top-lighted galleries by adjustable metal louver boarding.

¹ *Trans. I.E.S.*, vol. 11 (1916), p. 1014, *Lighting of the Cleveland Museum of Art*, E. P. HYDE.

Cove and pendant units of Type *C-2* mazdas are used in the rotunda which is lighted to an intensity which does not contrast strongly with adjacent rooms having unlike lighting effects. Side bracket lamps conforming to the architecture give a softening effect.

Deeply etched wire glass forms the sub-skylight for the court of tapestries and armor. This effectually serves to diffuse the light from sun, sky or lamps so fully that the shadows of the beams are not seen. The louver boards are used just below the

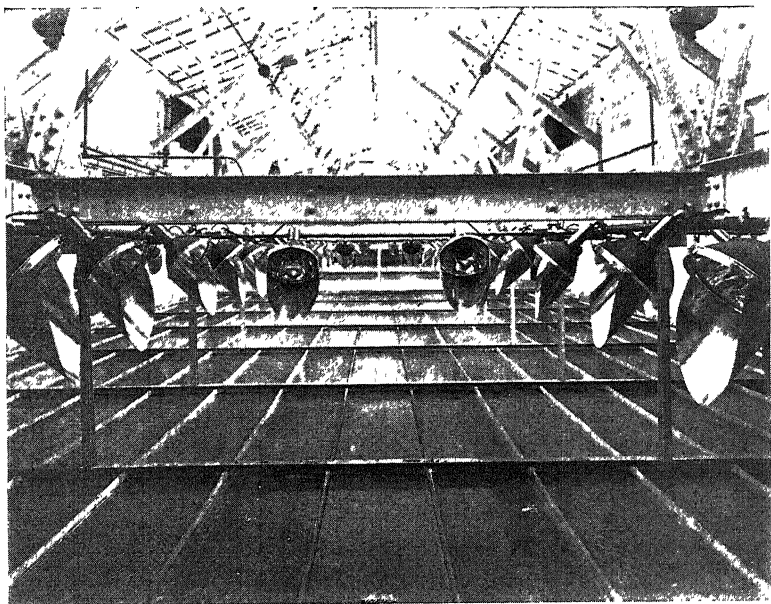

FIG. 85.—Method employed in illumination of Cleveland Art Museum (see Fig. 84).

upper skylight, where the set on each side of the ridge of the roof controls the illumination of the opposite side of the room. These lamps also are mazda, Type *C-2*. They are installed at an average height of 9 feet above the sub-skylight and their light is directed through the diffusing glass toward the opposite side of the room. The directional element of the light is therefore the same for daylight as for artificial illumination. The plan is followed in other rooms also. Details of the scheme may be seen in Figs. 84 and 85 taken from the above paper.

The garden court lighting is planned so as to give night effects, with a dark ceiling, simulating the dark sky. Four lanterns are used, throwing the light downward and horizontally, but not upward. The day illumination is by skylight.

Other rooms are provided with direct lighting suitable for exhibits which may change in location and character.

In all these rooms the results are artistic and effective, and glare is avoided. Where such elaborate provisions cannot be made, glare can be eliminated by having rather low value directional components to the flux and by making this flux line strike the painting at such an angle that its specular reflection will not return to the observer at the level of the eye.

Studios should have well diffused illumination with variable and adjustable local fixtures to give the effects particularly desired for the subject.

CHAPTER XXI

STREETS

General Considerations.—It has been necessary to make rapid and extensive changes in the field of street lighting during the last few years. This has come about largely from the changes which have been made in the list of available electric illuminants. The most prominent and useful of these lamps are the Type *C*, mazda and the luminous arc. Flaming arcs still claim a small amount of attention but they are not nearly as satisfactory units as those types mentioned above. Their application may be considered entirely special nowadays although they have had considerable use in regular work. The enclosed carbon arc is obsolete as far as new installations go. A few renewal units are still called for but no new installations are ever made. The mercury vapor lamp has a very special and limited range in connection with outdoor illumination of foliage in parks, etc. Dependence is put almost entirely upon the first mentioned lamps, viz., the mazda, especially Type *C*, and the luminous arc.

Not alone in the field of electric lamps has the production of the gas-filled incandescent lamp been felt. Before it was developed, small-unit street illuminants of the vacuum type incandescent lamps were available but not very efficient as compared with arcs. In the Type *C*, we have very efficient operation and a great range of sizes both as series lamps and as multiple units. The small units have quite successfully invaded the field heretofore held by gas-mantle lamps and now offer direct competition to gas lighting.

The problems to be met in street lighting involve safety, comfort and convenience of the wayfarer. Added to these, we now see numerous attempts being made to consult his pleasure and to persuade him to frequent the attractively illuminated ways. Thus the whole range is included from personal security to commercialism and even the aesthetic. These objects are not necessarily accomplished by the same type of service.

Security is given by any illumination which will reveal surely and clearly the presence and the nature of a danger. Good

general illumination with clear direct visibility will solve this problem. But again, an obstruction to traffic may be recognized with low illumination intensities, by the silhouette effect or, sometimes by unidirectional lighting. Safety may be served as well in the second case as in the first, and at a greatly reduced expense for lighting. In point of fact, the greater part of our night street vision is properly classed as of the silhouette type. We see the automobile in black outline as it approaches, the background of the pavement, sidewalks or walls being brighter. An unmarked pile of construction material is seen by its black form. Upturned paving stones, small misplaced objects, etc., are discerned by contrast with lighter or darker surroundings.

As intensity of illumination increases from that needed for silhouette vision and finally reaches the value by means of which detail vision enters, there is passed an intermediate state where the pedestrian may lose the sense of dependence upon the former although he may not yet be enabled to see detail. Unless care is observed in this indeterminate region, the danger may be enhanced by the practical disappearance of the object. For example, it is a common experience for a person upon a fairly well lighted street to observe another pedestrian approaching in the distance, the stranger being seen in black relief. As he draws nearer, he may completely disappear by virtue of the fact that he has reached a point where his body is lighted to the same brightness as is the background against which he is placed. A closer approach will cause him to reappear as a brighter object against a darker background. The distance between the observer and the stranger at the time of least visibility may be such that an actual hazard exists. Especially may this be true in the case of swiftly moving vehicles. Bicyclists are very hard to see and to avoid.

When detail vision is needed, the only way of solving the problem is by furnishing the required amount of incident flux for a low-degree detail visibility. This is not a prevalent condition, however, in street lighting.

Consideration of the above facts will make it evident that the calculations for street lighting cannot be made upon a basis of illuminating upon the horizontal plane to the exclusion of the vertical, nor vice versa. Specular, or at least mixed, reflection also plays an important part in results. On top of all this, glare must be avoided as surely as in any other installation.

Glare.—Street illuminants, as will be seen later, have the characteristic flux distribution which gives maximum emission at an angle of 70 to 80 degrees above the nadir. It is evident that the height of suspension of the unit above the street level determines the point at which a person must stand in order to have this maximum flux in his eyes. With high suspension, the distance to the observer will be great enough so that the amount of flux actually reaching his eyes will not be a source of annoyance. With low suspension trouble will result. Glare must therefore be avoided by putting the lamp high enough so that the direct flux at any assumed position of the observer is not great enough to disturb him, or else the position of the lamp places it far enough above the level of his eye so that it will be out of his field of vision. Large units with high position or small units with lower position are permissible.

Size and Spacing.—The spacing of lamps is of course largely influenced by the dimensions of the city blocks. Lamps must be placed at each street crossing because they are most effective there, in that they light in four directions and they cover the point where traffic difficulties are most likely to occur. Intermediate points along the block may need more light than they obtain from the corner lamps in which case the custom is to install one or more lamps with proper spacings. If the blocks are rectangular rather than square, the needs are not the same on all sides. In planning for the proper lighting results, it is probably more satisfactory to have the zones of influence of successive lamps meet, but not overlap very much. If this overlapping occurs, it will be in the region of silhouette vision where approximately unidirectional flux such as moonlight gives better results. The size of the circles of influence will generally be great enough to throw much light upon stores and buildings or upon the houses and trees and into yards, in residence sections. How much of this is desirable will be determined in each individual case. The smaller units will give less of this side flux, which is largely lost so far as the street is concerned.

Height of suspension and placement may sometimes be wholly determined by the physical characteristics of the street, such as tree height and trim, overhead structures, etc. For example, low, bushy trees may easily be overtopped by lines and fixtures but the light will not filter down through their dense foliage to the sidewalk. Sometimes low suspension is the only solution in a

case like this, although center suspension may allow a little increased elevation if the trees do not reach out into the roadway too far. Reasonable tree trimming must be allowed, to give the best results in any case. By low suspension, we imply something in the neighborhood of 15 feet to 18 feet. High suspension goes from 18 feet to 25 feet for residence streets and even much higher for business sections.

If a good working illumination is not the only end in view, but the situation calls for an ornamental installation, the spacing is always smaller than it might otherwise be. Poles, fixtures, and lamps, all become a part of the decorative material. They must therefore all be seen at closer range and each lamp must be

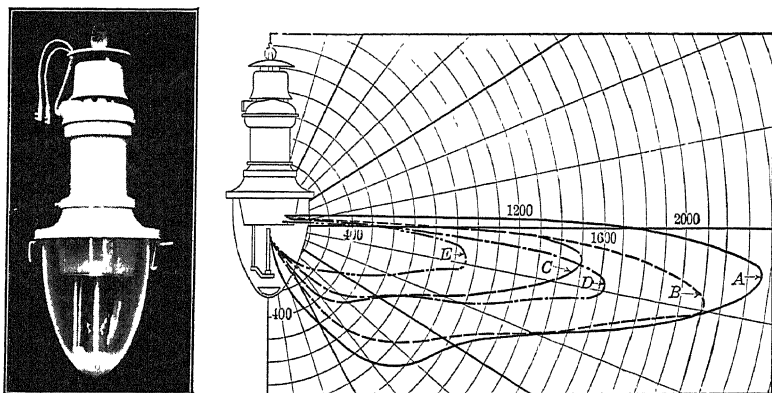

Figs. 86 and 87.—Pendant type of luminous arc lamp with prismatic refractor and distribution curves for electrodes as follows: (A) 6.6-ampere, long-life. (B) 5-ampere, high-efficiency. (C) 5-ampere, long-life. (D) 4-ampere, high-efficiency. (E) 4-ampere, long-life.

less brilliant. Again, the multiplicity of units in a long string down the street presents an effective perspective. In the ornamental lighting of short stretches, the only way in which perspective can be introduced is to use closely spaced lamps. Probably 80 to 100 ft. spacings are as low as should be adopted.

Luminous Arc Lamps.—For over twelve years, there has been employed in street lighting the type of electric lamp known as the luminous arc. This has already been described in the discussion of arcs. Figs. 86 and 87¹ show the pendant type of

¹ These and the following illustrations of distribution curves are taken from an article "Street Lighting with Modern Illuminants," by ROSE and BUTLER, *General Elec. Review*, vol. 20 (1917), p. 945.

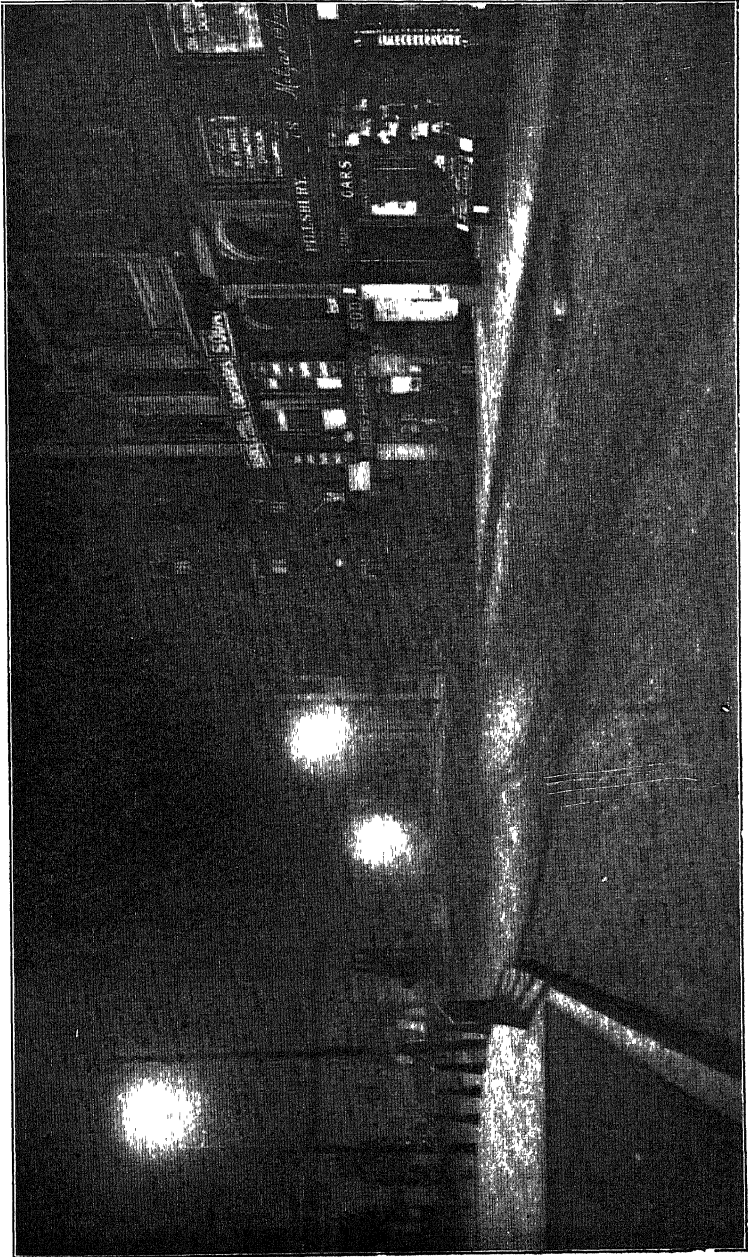
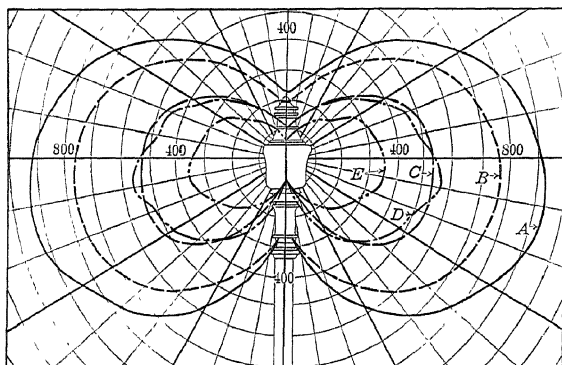
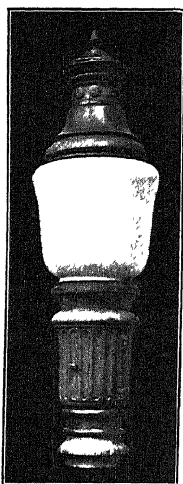

FIG. 88.—Street illumination by General Electric series luminous arc lamps, Boston, Mass.

luminous arc lamp with flux distribution curves for several different electrodes. These curves show the peculiar fitness of this unit as a street illuminant. With the type illustrated it is clear that the distant street receives a large amount of the light. This being a large unit with outputs from 3000 lumens to 9000 lumens, a considerable amount of light also falls upon the buildings although it will not illuminate much above the lamp height (see Fig. 88). When the ornamental installation is installed, the distribution characteristics are changed materially as well as the appearance of the lamp. Figs. 89, 90, 91 and 92 show two such design changes and it will be noted that in them, much



FIGS. 89 and 90.—Ornamental type luminous arc lamp and distribution curve for electrodes and diffusing glass globes as follows: (A) 6.6-ampere, long-life; medium density glass. (B) 5-ampere, high efficiency; medium density glass. (C) 5 ampere, long-life; light density glass. (D) 4-ampere, high-efficiency; light density glass. (E) 4-ampere, long-life; light density glass.

more light will reach the faces of buildings (see Fig. 93). This adds to the good appearance of a well built business section, nor is the light wholly lost, as an appreciable diffusion takes place from the fronts, which are generally rather light colored. These units in themselves are quite attractive and even in the daytime add to the general appearance of the streets.

Incandescent Lamps.—The Type C mazdas have about the same distribution curves as do other incandescent lamps. Having a more concentrated filament, the bare lamp is more nearly a point source than is the vacuum lamp. However, the unmodi-

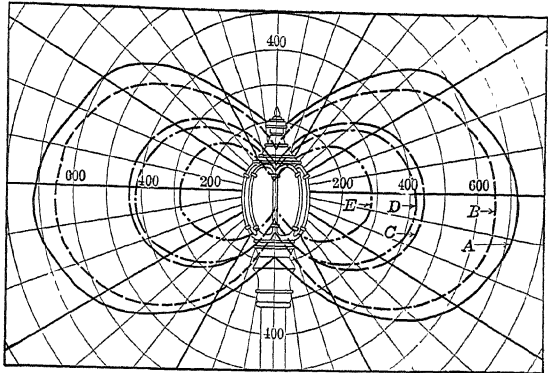
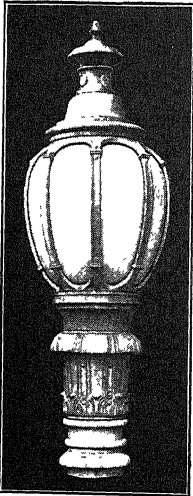

FIGS. 91 and 92.—Ornamental type luminous arc with diffusing glass globe and distribution curves for: (A) 6.6-ampere, long-life electrode, and medium diffusing glass. (B) 5-ampere, high-efficiency electrode, and medium diffusing glass. (C) 5-ampere, long-life electrode, and medium diffusing glass. (D) 4-ampere, high-efficiency electrode, and medium diffusing glass. (E) 4-ampere, long-life electrode, and medium diffusing glass.

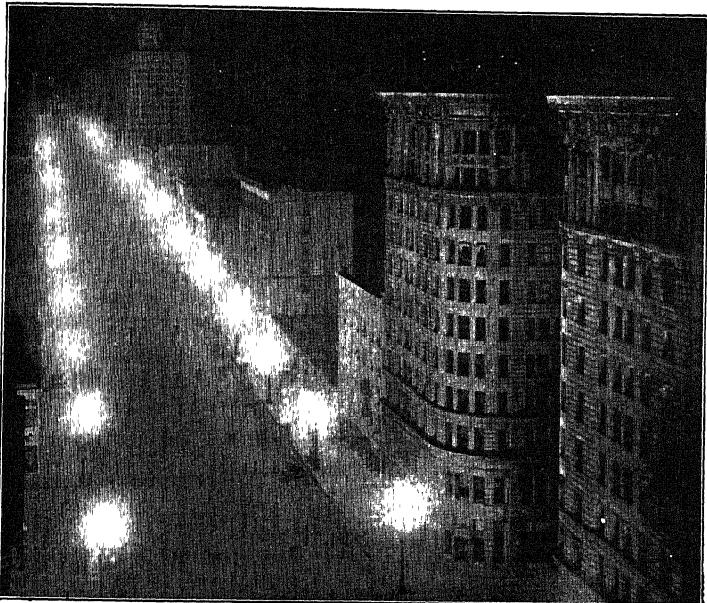
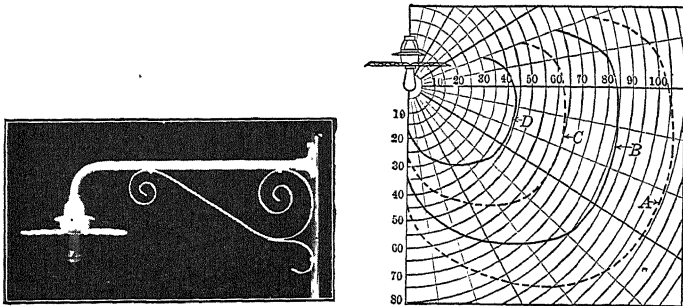

FIG. 93.—Street illumination by General Electric series luminous arc lamps, Salt Lake City, Utah.

fied emission of light is never depended upon because much more satisfactory results are obtained by using reflectors, refractors or globes. There are shown here three typical forms of accessories with their resulting distribution curves. Figs. 94 and 95 show



FIGS. 94 and 95.—Mazda series lamp with flat radial-wave reflector, and distribution curves for: (A) 100-c.-p. mazda. (B) 80-c.-p. mazda. (C) 60-c.-p. mazda. (D) 40-c.-p. mazda.

the effect of using a flat radial-wave reflector upon series lamps rated 40-, 60-, 80- and 100-c.-p., respectively. Going to the pendant type, the effect of a refractor is shown in Figs. 96 and

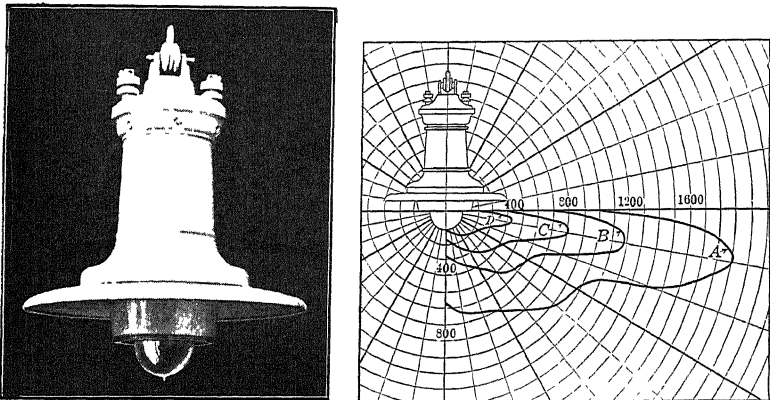

FIGS. 96 and 97.—Novalux pendant unit, steel reflector and prismatic glass band refractor and distribution curves for: (A) 1000-c.-p., 20-ampere mazda series lamp. (B) 600-c.-p., 20-ampere, mazda series lamp. (C) 400-c.-p., 15-ampere, mazda series lamp. (D) 250-c.-p., 6.6-ampere, mazda series lamp.

97 for series lamps rated 250-, 400-, 600- and 1000-c.-p. When the refractor is used it gives the distribution suggestive of that for the luminous arc already mentioned. Figs. 98 and 99 are for

the novalux pendant unit with diffusing glass globe and reflector with 250-, 400-, 600- and 1000-c.-p. series lamps. These accessories should be used with closer spacing than the refractor type. They also allow for a greater illumination of the upper part of building fronts.

Comparison of the Luminous Arc and the Incandescent Lamps.—The arc is a more efficient way of producing light than is the incandescent filament. In choosing, therefore, between the two lamps, the arc lamp will have first place in this respect. Upon the other hand, the arc lamp is inherently a large unit, with a range of outputs from 3000 to 8700 lumens and it will fit into only certain designs of installation. When closely spaced for

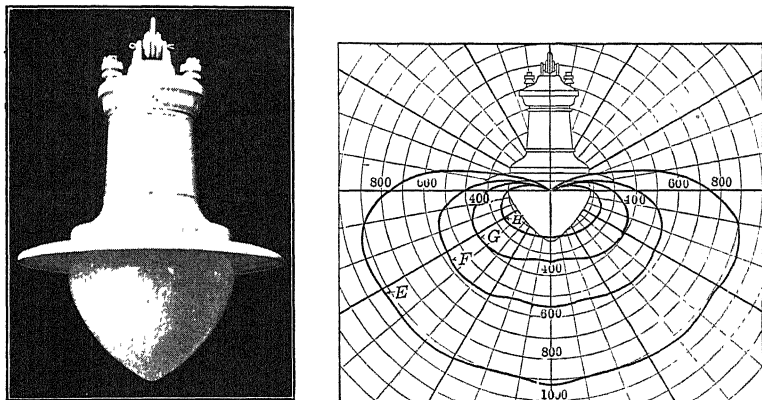

FIGS. 98 and 99.—Steel reflector and diffusing glass globe and distribution curves for: (E) 1000-c.-p., 20-ampere, mazda series lamp. (F) 600-c.-p., 20-ampere, mazda series lamp. (G) 400-c.-p., 15-ampere, mazda series lamp. (H) 250-c.-p., 6.6-ampere, mazda series lamp.

ornamental effects it gives the high illumination values required only for the highest classes of service. The Type C mazdas cover a much greater range, being available in one form or another with outputs when equipped for service of from 450 lumens to 13,500 lumens. Table 37¹ gives comparative data in which the individual characteristics of each size are shown. Both series and constant potential incandescents are represented in the table and one value is shown for the alternating-current enclosed flame arc lamp. It will be noted that the smallest unit listed is the series type mazda rated at 60 c.-p. with input of about 47 watts,

¹ *Illum. Eng. Prac.* (Lectures, 1916), p. 423, "Lighting of Streets," by P. S. MILLAR.

while the largest unit is the multiple type, 110-volt, 1000-watt mazda. These are exceeded today by the 15,000-watt mazdas, used in some places.

TABLE 37.—RELATIVE LIGHT PRODUCING EFFICIENCIES OF MAZDA C, FLAMING ARC AND MAGNETITE LAMPS

Mazda C lamps								
Description			Bare lamp			Equipped for service assuming 25 per cent. absorption in accessory		
			Total lumens	Average watts	Lumens per watt	Total lumens	Average watts	Lumens per watt
6.6-amp., "60-c.-p."...			600	46.9	12.8	450	46.9	9.6
6.6-amp., "100-c.-p."...			1,000	71.9	13.97	750	71.9	10.4
6.6-amp., "250-c.-p."...			2,500	155.0	16.12	1,875	155.0	12.5
6.6-amp., "400-c.-p."...			4,000	245.0	16.32	3,000	245.0	12.2
6.6-amp., "600-c.-p."...			6,000	367.0	16.32	4,500	367.0	12.3
20-amp., "600-c.-p." (compensator)			6,000	310.0	19.3	4,500	310.0	14.5
20-amp., "1000-c.-p." (compensator)..			10,000	518.0	19.3	7,500	518.0	14.5
110-volt, "75-watts"								
110-volt, "200-watts"...			2,795	200.0	13.97	2,098	200.0	10.5
110-volt, "400-watts"...			6,130	400.0	15.33	4,600	400.0	11.5
110-volt, "750-watts"...			12,740	750.0	16.99	9,550	750.0	12.7
110-volt, "1000-watts".			17,960	1000.0	17.96	13,480	1000.0	13.5
Magnetite lamps								
Description			Bare lamp			Equipped for service		
Amperes	Electrode	Globe	Total lumens	Average watts	Lumens per watt	Total lumens	Average watts	Lumens per watt
4.0	Standard.....	clear	2991	310	9.65
4.0	High efficiency..	clear	4649	323	14.4
5.0	Standard.....	clear	5768	390	14.8
5.0	High efficiency..	clear	7655	371	20.6
6.6	Standard.....	clear	8708	511	17.0
A.-c. enclosed flame arc lamps								
7.5	(Yellow).....	clear	8557	480	17.8

Within the range of the arc lamp, therefore, we have direct competition between arc and mazda, with efficiency in favor of the arc. Nevertheless, this is not enough to decide the choice, for the equipment necessary for the arc light service is more elaborate and expensive than for the incandescent lamps. It remains, therefore, to consider the size of the installation. With a large number of lamps, well bunched, the arc system will work out most advantageously, while for few lamps or badly scattered units the mazdas are found to be best. This is, of course, simply a matter of economics and can be determined only by actual cost calculations, installation and operation costs, both being considered.

The use of series incandescent lamps upon the same circuit with arc lamps is not a very satisfactory procedure, although it is frequently done in case a few incandescents are needed to fill in or supplement an arc system already installed. The practice subjects the incandescent lamps to too great current fluctuations and their lives are shortened as a result.

Classification of Streets.—Turning now to the actual application of light to the solution of various illuminating problems presented by streets we find it necessary as a first step to distinguish between the demands made by different situations. It is customary to classify streets into groups according to the type of the illumination required. Lacombe¹ gives eight headings under which he lists the various needs (Table 38). These are affected somewhat by the size of the city to be considered, larger cities requiring higher intensities for the streets of the same class. Only the large cities may have the highest classification.

TABLE 38.—CLASSIFICATION OF STREETS

Class of street	Description
AA (Special)	Very important. Crossing of great streams of traffic.
A	Important. Greatly used at night.
B	Well used.
C	Ordinary night use, best residence sections.
D	Ordinary residence sections.
E	Suburban residence sections.
F	Parkways, boulevards or suburban roads.
G	State or country roads, etc.

¹ *Illum. Eng. Prac.* (Lectures, 1916), p. 461, "Lighting of Streets," by C. F. LACOMBE.

The following values represent fair minima and maxima for the various classes listed above.

- Class AA—0.25 to 1.25 lumens per square foot, or higher.
 A—0.1 to 0.75 lumens per square foot, or higher.
 B—0.05 to 0.5 lumens per square foot, or higher.
 C—0.02 to 0.25 lumens per square foot, or higher.
 D—0.01 to 0.10 lumens per square foot, or higher.
 E—0.005 to 0.05 lumens per square foot, or higher.
 F—0.005 to 0.01 lumens per square foot, or higher.
 G—Road markers to 0.01 per square foot, or higher.

In this connection it may be recalled that full moonlight gives an intensity of about 0.02 lumens per square foot.

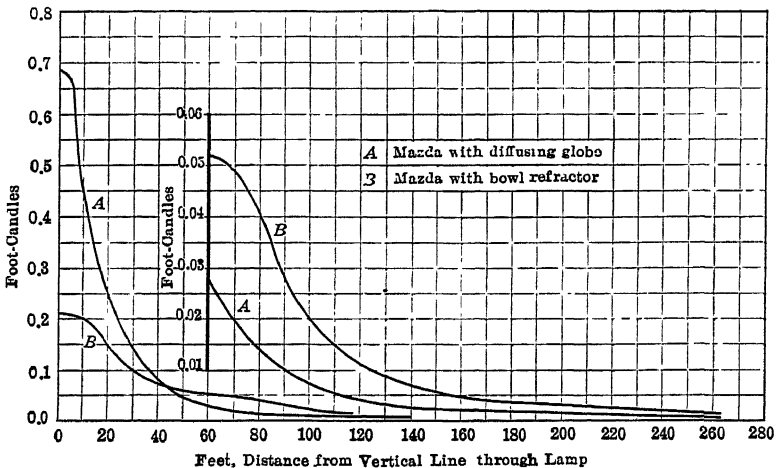

Fig. 100.—Results of illumination calculations.

Calculations.—The most direct method of calculating the illumination of streets is to assume the logical distribution of lamps upon the basis of physical characteristics of the areas to be lighted, choose the most promising units available, and from the flux curves of the lamp and reflector chosen, calculate the actual illumination curve data for different distances along the street. To the extent that the regions of influence overlap, illumination curves may be combined and totals plotted. The actual process is very similar to that outlined in the discussion of illumination calculations for a large room, and will not be gone into in detail here. A comparison of the results obtained by different lamps

and various spacings, mounts, etc. will give a basis for making the final choice.

Where much of this work is to be done, the illuminating engineer prepares standard tables or curve sheets which can be readily used for the specific problem. Where it is a matter of visualizing the results, the flux distribution may be represented by a solid whose radius vector represents the magnitude of the flux in the given direction. Mr. P. S. Millar has prepared such solids, coloring white that part representing the flux which reaches the street, thus making a visual appeal to the investigator. Such methods of presenting data become generalized solutions and tend toward calculation on the basis of light flux. These processes by averages are oftentimes very helpful and fully satisfactory. They must be used with caution in solving individual problems, however, and check values should be secured covering the most important areas by more direct methods. Curves showing typical results of street calculations are shown in Fig. 100.

CHAPTER XXII

FLOOD LIGHTING YARDS, BUILDINGS, ETC.

As a very effective and satisfactory development in connection with exterior illumination, there has come into prominence in the last few years the practice of directing a flood of light upon a circumscribed area. This area may be as limited in extent as a statue, a bill board or a doorway; or it may cover a whole building, a tennis court, a dock, a factory yard or a construction site. The so-called flood lighting is accomplished by projectors, the beam of light varying in angle according to results desired, position of lamps in respect to the illuminated surface, etc. Angles of divergence vary from about eight degrees up to fifty degrees. The wide-angle units must be installed close to the objects to be lighted, but the narrow-angle units may be placed at very considerable distances from them.

If an ellipsoidal reflector could be used with a point-light source at the focus, the beam of light would consist of parallel rays and the intensity of the illumination would be constant for varying distance, except for the absorption by air. Total light flux would fall upon a given constant area regardless of distance. With the diverging beams of light, however, there is a departure from this condition and although, in the immediate neighborhood of the lamp the lighted area will be a function of the distance, it will not follow the law of inverse squares. The effect of departure from this law is more, the narrower the beam, but even with the eight-degree projectors a distance of one hundred feet makes it an acceptable process to base calculations upon. As distance increases the error lessens and becomes indiscernable.

Probably as satisfactory a process of calculation as any is to secure the figure representing the total flux output of the lamp when equipped with its reflector, lens, etc., and then proceed upon the assumption that all of this light strikes the base of a cone whose area depends upon the angle of spread and whose area and shape both depend upon its distance from the projector and the angle of incidence of the light. It will be recognized that this type of illumination will cast clear-cut black shadows unless

the zones of adjacent lamps overlap, or considerable diffusion of light is afforded by reflection from the illuminated surfaces. The surfaces must be broken and non-parallel or they cannot throw reflected light upon each other. Whether these conditions exist or not depends upon the nature of the individual problem.

If the objective is a *flat bill board* the calculations are easily performed. The projectors used are usually the wide-spread type. They are mounted close to the board, but in such a position that top and bottom receive approximately the same illumination.

White statuary, well lighted presents a very striking appearance. There are certain dangers arising here connected with lamp placement, however. If the statue is accessible to the view from all sides, care must be taken to light different sides without "flattening out" the characteristic features by eliminating shadows. This may be done by using a limited number of light stations, the intensities differing enough so as to emphasize a front view, but not enough to shroud the other views. A central shaft cannot be so treated, and it is a delicate procedure at best to vary intensities. Probably a safer process would be to study lamp placement with a view to the making of shadows in the right places in order to show to the eye the surface form. Usually an irregular surface brilliantly lighted from a source near the eye of the observer will appear flat and characterless, because of the elimination of defining shadow edges. Even the automobile driver meets this difficulty in inspecting the road ahead of him.

The altitude of the light source also affects the result seriously. We are used to seeing objects illuminated by light with a downward slant and when upwardly directed light reveals an object normally seen near the ground level, such as human figures or an equestrian statue, there is an unnaturalness about the result which is disconcerting. Upon the other hand, if lamps are placed high and throw light downward, an observer standing upon the opposite side of the statue may be brought face to face with the projector.

A tall shaft, a tower or a capitol dome when flood lighted generally shows a considerable decrease in luminosity toward the top. This is because the lights are placed comparatively close to the base of the shaft, and, even with narrow-beam units, the lessening of intensity combined with the increased angle of incidence gives decreased illumination. This effect may not be displeasing

if it is well handled, in fact, it may be distinctly pleasing, and give to the structure an increased dignity and impressiveness due to the sense of height introduced by the perspective.

The fronts of buildings present different features. If lighting is to be worth while there are probably architectural properties which warrant attention. The object sought may be to bring these natural characteristics into prominence, securing the night effects by emphasizing the day values. Not infrequently, however, there are latent possibilities which an artificial illumination may bring out, strongly different from the daytime views. Among these are the emphasis of columns, corridors and cornices.

Large areas are flood lighted for many purposes. During the late war, conditions were such that many bridges, manufacturing plants, arsenals, storehouses, etc., had to be guarded against mischief makers. One of the greatest helps in this was the flooding of approaches with light, giving clear vision of all trespassers, and minimizing the need for watchmen. Again, construction work, shipping at docks or in train yards are greatly facilitated by full lighting. They may be made continuous, twenty-four-hour processes. Shooting traps, tennis courts, golf links, and toboggan slides have all come in for actual installations and even race tracks have been flood lighted.

TABLE 39.—DATA ON X-RAY PROJECTORS

Unit	No. of reflector	Position of lamp	Spread of beam	Diam. beam at 100 ft. distance, (ft.)	Foot-candle illum. at 100 ft. distance
200-250 watts:					
51-C.....	800	Focus	12	21	5.2
51-D.....	800	¼" from F.	20	35	1.8
51-E.....	810	Focus	40	72	0.63
400-500 watts:					
60-C.....	840	10	17	13.4
60-D.....	835	25	45	1.3
60-E.....	845	50	94	0.4
1000 watts:					
90-C.....	825	10	17	18.4
90-D.....	827	15	26	7.8
90-E.....	825-827	35	62	1.1
	spec. cover				

In all of these greater installations, the lamps will be distributed so as to give as uniform an illumination as is possible.

If the lamps are too far from the field, the angle of incidence of the light is too great for satisfactory results. It is necessary to have the light come from sources which will not be faced by operators. A compromise must therefore be sought between the low-mounted lamp with its sweep of light flux and the high-mounted unit, with its downward flux. Certain items are recognized at a glance, as for example the fact that a tennis court should be lighted by fairly high projectors placed at the sides of the court. End lights are impossible. Lamps should be placed on both sides, served with downward pointing reflectors with rather wide angles. The fields of the two lamps opposite to each other should overlap.

The Projector.—For all of these foregoing purposes, the material used is the projector, with sizes and angles of divergence

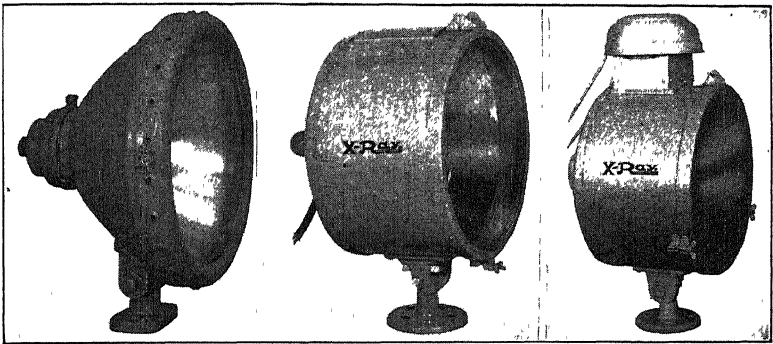

Fig. 101.—X-ray flood light projectors, No. 51 for 200- and 250-watt lamps; No. 60 for 400- and 500-watt lamps; No. 91 for any 300- to 1000-watt lamp with mogul base.

varying according to the needs. Fig. 101 shows typical units. Construction must be weatherproof despite the necessary ventilating openings; the front glass must be capable of standing the temperature strains resulting from the heated interior and dashing rain on the outside; the tilt must be adjustable as should also the horizontal angle. Some manufacturers secure a variation in the angle of spread by moving the incandescent element toward or from the focus of the parabolic reflector. When, however, the adjustment is determined there should be made every effort to keep it absolutely accurate. Porter (*Trans. I.E.S.*, Vol. 8, 1917, p. 193) gives data showing the effect of very small displacements of the 6-volt, 36-watt, focus-type mazda

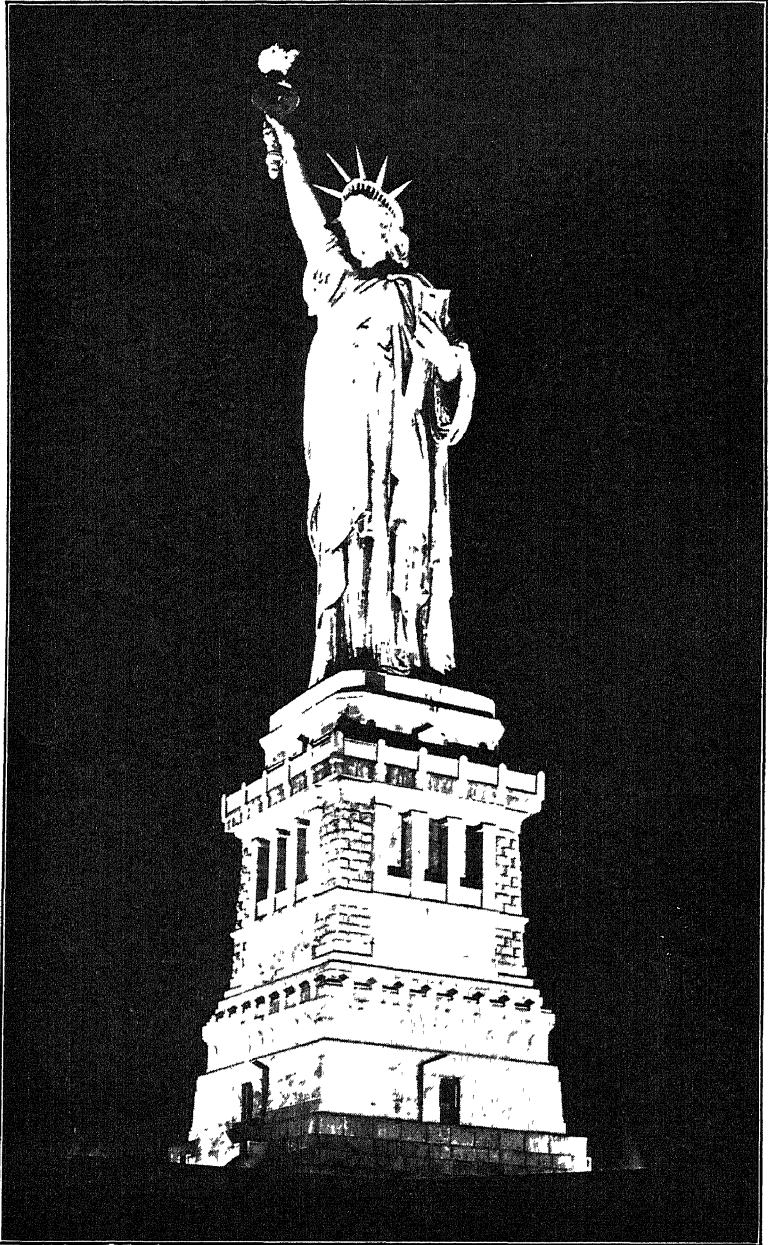

FIG. 102.—The Statue of Liberty, flood lighted.

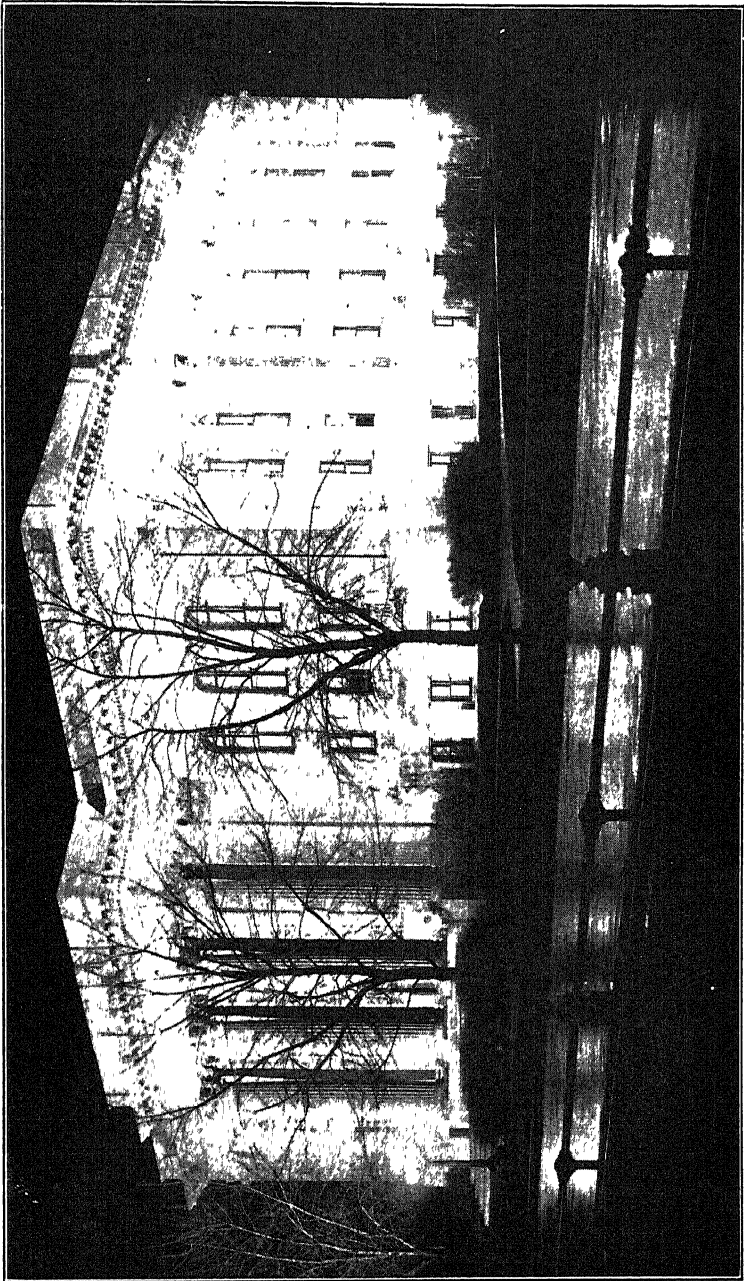

FIG. 103.—The Public Library, Lynn, Mass., flood lighted

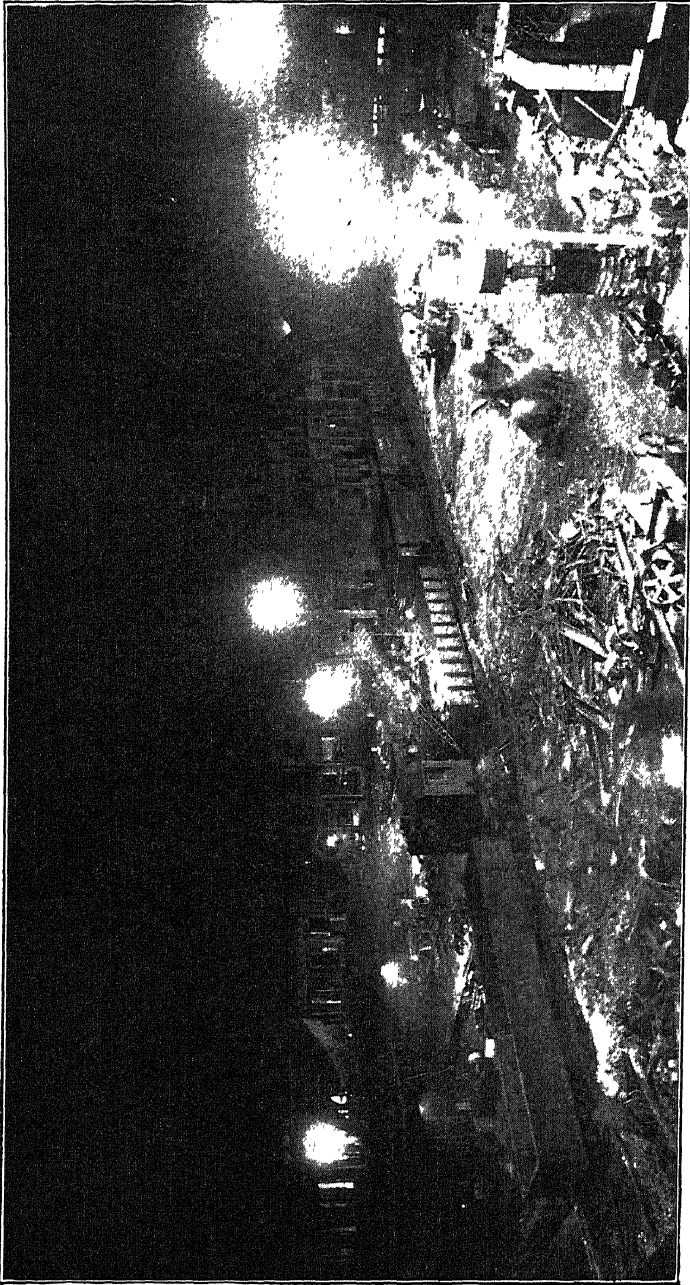

FIG. 104.—Flood lighting a construction site. The ruins of Thos. A Edison's plant, West Orange, N. J., lighted by 1000-watt, type C, Edison mazda lamps and General Electric incandescent searchlights, enabling the work to proceed twenty-four hours per day.

lamp in a 16-inch diameter parabolic reflector having a 3-inch focal length (see Table 40).

TABLE 40.—SHOWING THE EFFECT OF DISPLACEMENT FROM FOCAL POSITION

Lamp at focus.....	220,000 beam candle-power
Lamp $\frac{1}{16}$ in. (1.6 mm.) back of focus.....	70,000 beam candle-power
Lamp $\frac{2}{16}$ in. (3.2 mm.) back of focus.....	40,000 beam candle-power
Lamp $\frac{3}{16}$ in. (4.8 mm.) back of focus.....	18,000 beam candle-power
Lamp $\frac{4}{16}$ in. (6.4 mm.) back of focus.....	8,000 beam candle-power

The lighting element is the mazda Type *C* lamp, and the filament is especially formed in order to concentrate the luminous source and thereby gain in the accuracy of the flux control. In sizes, the lamps are obtainable up to 1000 watt ratings. This approaches the field of the searchlight, in which very powerful arcs are standard.

A few examples may present better than words the features of flood lighting. The illustrations, Figs. 102, 103, 104, should be examined for clearness, uniformity of illumination, flatness or the obliteration of detail, and for probable glare. It must be remembered that photographs are not always reliable gauges of ocular effects. At the same time they do show some errors in illumination which would become disastrous to good results if they were allowed to become much greater.

Decorative flood lighting is common in expositions, especially for building exteriors, courts, etc. Certain phases of this application are treated under the head of color illumination. It is not the case, of course, that color is a necessary adjunct in such lighting. In the San Francisco case, however, color played so important a part in the wonderful effects produced that it must be given a most prominent place in the discussion. It will, therefore, be presented under the head of "color."

CHAPTER XXIII

COLOR

Color has been an ever-present charm in nature and an increasing source of delight in art. It gives character to the landscape, it paints the skies, it enters our homes, it decorates our surroundings. It is the attractive feature of a sunset; it gives individuality to our personal effects. It demands our recognition of even the faintest tinted flower; it conceals the wild bird in its habitat. It aids vision as much as shade does. It is to the eye what music is to the ear.

The most beautiful colors are the pure ones which are derived from white light and are available to the illuminating engineer. Besides these, by proper screening, any shades or tints may be obtained. Yet, there has not been developed any considerable widespread practice which makes successful use of color lighting, either by daylight or by artificial means. The exceptions to this statement involve discussions of theater stage lighting, color-matching outfits, advertising, signal work, artificial daylight, etc. It is a mooted question as to the extent to which color lighting will develop, but certainly there is a legitimate field for its consideration in any situation where the æsthetic is predominant. It may not always be adaptable to these situations, but it will nearly always be worth while to weigh its possible effects. Frequently, the softening effect of pale amber tints will "warm" a room acceptably.

Artificial daylight, though not thought of as a colored light, is strictly a matter of color consideration and must be dealt with as such. Its value is being more and more recognized. A wide variety of industrial activities find it of extreme value to them. Paint making, garment dyeing, surgery, color printing, color matching (and even color choosing), grading of commercial products where color is of moment, as in cotton, sugar, paper, jewels, and many other processes are pointed out by Luckiesh as being peculiarly within the field of artificial daylight illumination.

There has been very little commercial application of the stronger colors. A Los Angeles hotel has made a very novel and striking installation.¹ The room is 90 ft. by 38 ft., with four beams. The ceiling and walls are covered by cloth draped from a center ring in each bay of the ceiling outward to the walls and then down the walls in alternate white and green panels. Additional fern-cloth drapery is used, sprinkled with mica, to simulate snow covered tree branches. At various distances below the ceiling are hung thousands of mica-covered balls, 4 inches to 7 inches in diameter

There are eight bead-covered, indirect lighting fixtures, each having six 200-watt lamps with individual, silvered-glass reflectors. Red, blue and green gelatin films cover different lamps. The circuits for each being provided, so that any desired proportions of colored light flux may be secured. The reflected light from the ceiling drapery mixes into the uniform color tone sought for the lower room, but on the glistening balls the individual colors themselves appear, though the whole combination may give a white light at the table tops. The effects produced are remarkable.

There have been some very striking display lighting installations connected with expositions, where color has been used with results beyond the conception of the lay mind. The most notable example of this is the color work at the Panama-Pacific International Exposition in San Francisco in 1915. Those persons who saw these beauties will never forget their impressions. They, as well as others who were not so fortunate, will enjoy a perusal of W. D'A. Ryan's paper² descriptive of this installation. Fifty-two color plates are shown and should be carefully examined by anyone studying color-lighting for display.

In this particular case, buildings were in general flood-lighted. Ryan points out that it was a studied departure from the earlier outline lighting of the Pan-American Exposition at Buffalo. The flattening effect of simple flood lighting was avoided by color illumination of shadows, colonnade interiors, windows, balconies, cornices, etc., with various intensities. For example, towers were illuminated by white flood light rising at a sharp

¹ *Elec. World*, vol. 68 (1916), p. 1106, "Color Effects and Indirect Lighting in a Los Angeles Restaurant," MILLS and HOEVELER.

² "Illumination of the Panama-Pacific International Exposition," *Trans. A. I. E. E.*, vol. 35 (1916), p. 757.

angle, creating dense shadows above all projections. Instead of leaving these places completely submerged, concealed colored lights gave them entity and introduced perspective into the picture. Brilliant sparkling effects were produced by the use of cut-glass jewels ("novagems") in sizes up to 47 mm. in diameter. They were scientifically cut in imitation of diamonds, sapphires and rubies. They were mounted with mirrors at their points and moved in the breezes. Kaleidoscopic effects were produced by shifting color screens and shadow bars in front of each of twelve projectors throwing light through special central lenses, illuminating the glass dome of the Palace of Horticulture, from the inside. Great clouds of steam and smoke were lighted by a bank of forty-six, 36-inch, hand-controlled projectors, with color screens, operated according to studied schedules and giving great plumes, fans, jets and other similar moving effects. Water jets appeared iridescent from being lighted by red and green flux upon front and rear surfaces. Flaming arcs gave much illumination for exteriors. But, in all of these applications, the lighting unit was concealed by hooding, recessing, sinking into the floor or covering by banners and cartouches. The color changes in general illumination traversed the whole range from the dazzling streamers of the rising sun to deep toned moonlight; from the gay scintillation of myriads of jewels to the lurid red of a burning city.

CHAPTER XXIV

RATES

The charge which any central station makes for electric service should be based upon the cost of giving that service. This is a local and individual matter and the company should base its rates upon an analysis of its own conditions. In so far as these conditions are common to other installations, similar bases for rate making exist.

Generally speaking, the cost of electric service can be broken up into several parts which are individually capable of being grouped under the headings, investment expense, energy expense, and customer expense. The investment expense includes interest, insurance, taxes, depreciation, etc., and is affected by the maximum demand made by a consumer and the relation of his peaks and valleys to those of the whole system. Energy expense includes all operating costs which depend upon the amount of energy used, such as coal, waste, oil. The customer expense includes the items which are proportional to the number of customers, such as overhead charges, billing, etc. Having analyzed the re-grouped elements of the total cost, it is then possible to establish a fair rate for the service in question. Whether this is done or not depends very largely upon the size of the system and the type of service it is rendering. In many cases, the analysis is made but the whole finally is combined into a single-charge.

Among the types of charges made for lighting service, we see, therefore, such as the following:¹

1. The flat rate, where no meter is used, and the charge is either fixed arbitrarily per period or is based on some unit such as size of building, or on number and capacity of energy-consuming devices, or even on the output of consumer's product.

2. The quantity-meter rate, where the charge is based on the quantity of energy consumed during bill-period as measured by an integrating meter, generally in kilowatt-hours.

3. The demand-meter rate, where the charge is based on the

¹ *Elec. Wld.*, vol. 65 (1915), p. 655.

demand of the consumer's installation as measured by an indicating meter, generally in kilowatts.

4. The two-charge or load-factor rate, where the charge is based on both quantity of electric energy consumed and capacity or demand of the installation.

5. The three-charge or "Doherty" rate, where the charge is based on (a) quantity of energy consumed, (b) capacity or demand of the installation, and (c) number of consumers, meters or service connections, or some similar unit.

Each of these schedules may be modified by being attached to a sliding scale or a stepped scale. Discounts are frequently allowed for prompt payment of bills.

Probably the most common rate basis in the United States is that recognizing a fixed charge, plus a consumption charge. Flat rates are not common although in some countries, notably Austria, they constitute about 30 per cent. of the schedules, while in Switzerland in one form or another they control or affect nearly three-quarters of the schedules. It will be noted that water power is common in these countries. Furthermore, the flat rate applies more acceptably in small stations where the standby losses are large compared to what they are in large stations.

APPENDIX

α	$\tan \alpha$	$\cos \alpha$	$\cos^2 \alpha$	$\cos^3 \alpha$
0	0.00	1.00	1.00	1.00
1	0.0175	0.9998	0.9997	0.9995
2	0.0349	0.9994	0.9988	0.998
3	0.0524	0.9986	0.997	0.996
4	0.0699	0.9376	0.995	0.993
5	0.0875	0.9962	0.992	0.989
6	0.1051	0.9945	0.989	0.984
7	0.1228	0.9925	0.985	0.978
8	0.1405	0.9903	0.981	0.971
9	0.1584	0.9877	0.976	0.964
10	0.1763	0.9848	0.970	0.955
11	0.1944	0.9816	0.964	0.946
12	0.2126	0.9781	0.957	0.936
13	0.2309	0.9744	0.949	0.925
14	0.2493	0.9703	0.941	0.914
15	0.2679	0.9659	0.933	0.901
16	0.2867	0.9613	0.924	0.888
17	0.3057	0.9563	0.915	0.875
18	0.3249	0.9511	0.905	0.860
19	0.3443	0.9455	0.894	0.845
20	0.3640	0.9397	0.883	0.830
21	0.3839	0.9336	0.872	0.814
22	0.4040	0.9272	0.860	0.797
23	0.4245	0.9205	0.847	0.780
24	0.4452	0.9135	0.835	0.762
25	0.4663	0.9063	0.821	0.744
26	0.4877	0.8988	0.808	0.726
27	0.5095	0.8910	0.794	0.707
28	0.5317	0.8829	0.780	0.688
29	0.5543	0.8746	0.765	0.669
30	0.5774	0.8660	0.750	0.650
31	0.6009	0.8572	0.735	0.630
32	0.6249	0.8480	0.719	0.610
33	0.6494	0.8387	0.703	0.590
34	0.6745	0.8290	0.687	0.570
35	0.7002	0.8192	0.671	0.550
36	0.7265	0.8090	0.655	0.530
37	0.7536	0.7986	0.638	0.509
38	0.7813	0.7880	0.621	0.489
39	0.8098	0.7771	0.604	0.469
40	0.8391	0.7660	0.587	0.450
41	0.8693	0.7547	0.570	0.430
42	0.9004	0.7431	0.552	0.410
43	0.9325	0.7314	0.535	0.391
44	0.9657	0.7193	0.517	0.37

APPENDIX (Continued)

α	$\tan \alpha$	$\cos \alpha$	$\cos^2 \alpha$	$\cos^3 \alpha$
45	1.0000	0.7071	0.500	0.354
46	1.0355	0.6947	0.483	0.335
47	1.0724	0.6820	0.465	0.317
48	1.1106	0.6691	0.448	0.300
49	1.1504	0.6561	0.430	0.282
50	1.1918	0.6428	0.413	0.266
51	1.2349	0.6293	0.396	0.249
52	1.2799	0.6157	0.379	0.233
53	1.3270	0.6018	0.362	0.218
54	1.3764	0.5878	0.345	0.203
55	1.4281	0.5736	0.329	0.189
56	1.4826	0.5592	0.313	0.175
57	1.5399	0.5446	0.297	0.1616
58	1.6003	0.5299	0.281	0.1488
59	1.6643	0.5150	0.265	0.1366
60	1.7321	0.5000	0.250	0.1250
61	1.8040	0.4848	0.235	0.1140
62	1.8807	0.4695	0.220	0.1035
63	1.9626	0.4540	0.206	0.0936
64	2.0503	0.4384	0.192	0.0842
65	2.1445	0.4226	0.179	0.0755
66	2.2460	0.4067	0.165	0.0673
67	2.3559	0.3907	0.153	0.0597
68	2.4751	0.3746	0.140	0.0527
69	2.6051	0.3584	0.128	0.0460
70	2.7475	0.3420	0.117	0.0400
71	2.9042	0.3256	0.106	0.0345
72	3.0777	0.3090	0.0955	0.0295
73	3.2709	0.2924	0.0855	0.0250
74	3.4874	0.2756	0.0760	0.0209
75	3.7321	0.2588	0.0670	0.0173
76	4.0108	0.2419	0.0585	0.01416
77	4.3315	0.2250	0.0506	0.01138
78	4.7046	0.2079	0.0432	0.00899
79	5.1446	0.1908	0.0364	0.00695
80	5.6713	0.1736	0.0302	0.00524
81	6.3138	0.1564	0.0245	0.00383
82	7.1154	0.1392	0.0194	0.00270
83	8.1443	0.1219	0.0149	0.00181
84	9.514	0.1045	0.0109	0.00142
85	11.43	0.0872	0.0076	0.000662
86	14.30	0.0698	0.00487	0.000339
87	19.08	0.0523	0.00274	0.0001434
88	28.64	0.0349	0.00122	0.0000425
89	57.29	0.0175	0.000305	0.00000532

INDEX

- Abbreviations for photometric units, 103
- Absorption of light, 90
- Absorption-of-light method, 132
- Acuity, visual, 95
- Analysis of lighting system, 73
- Apparatus, general, 38
- Arc, electric, 63
 - between carbons, 65
 - flaming, 66
 - history, 63
 - lamps, magnetite, 68
 - luminous, 67
 - magnetite, 67
 - potential gradient, 64
 - titanium carbide, 67
- Area of light source, 74
- Art galleries, 208
- Auditoriums, 204
 - chandelier for, 204
 - diffusing ceilings, 205
 - indirect lighting, 204
 - special, 205
- Balancing load, 41
- Bathrooms, 181
- Bedrooms, 181
- Black body radiation, 85
- Brightness, 100
- Candle power, mean hemispherical, 102
 - mean horizontal, 101
 - mean spherical, 102
- Candle, standard, 104
- Ceilings, effect of, 155, 165, 173
- Cellars, 183
- Circuits, series vs. parallel, 25
- Cleveland Museum of Art, 208
- Coefficient of reflection, measurement of, 121
- Color, lighting, 232
 - perception of, 91
 - radiation, 85
- Colorimeter, Ives, 121
 - readings, 122
- Colors of light sources, 91, 122
- Compounding illumination data, 163
- Conductors, 1
- Conduit laying in floor, 22
- Constant-current systems, 42
- Constant-current transformer, 43
- Constant-potential systems, 32, 38
- Contours, illumination, 165
- Copper wire, 1
- Copper wire tables, 2, 5
- Costs, analysis of operating, 201
- Demand indicators, 47
- Diffuse illumination, 190
 - radiation or emission, 190
- Dining room, 180
- Direction of light, 74
- Direct vs. indirect, 75
- Direct unit, 75
- Distribution curves, incandescent lamps, 53
 - equatorial curve, 54
 - horizontal, 101
 - vertical, 101
- Drafting room, 186
- Edison three-wire system, 36
- Effective angle, 170
 - flux, 169
- Entrances, 15
- Equilux spheres, 134
- Exposition, lighting, 233
- Eye, the human, 77
 - as a physical instrument, 80
 - physiology of, 77
 - protection of, 80
 - sensitivity of, 80

- Factory lighting, 197
 calculations, 200
 cost, 200
 economy of good, 197
 foot-candles needed, 152
 Government codes for, 197
 lamps used, 199
 reflectors, 200
 requirements, 198
 Fatigue, 94
 Fechner's law, 81
 Feeders, 33
 excess-voltage, 35
 Filaments, metal, 51
 Fishing, 21
 Flashing, 51
 Flood lighting, 224
 building fronts, 226
 decorative, 231
 large areas, 226
 projectors, 227
 shaft, 225
 statuary, 225
 units, 227
 Floor, effect of color of, 173
 Fluorescence, 93
 Flux of light, 168
 distribution, incandescent
 lamps, 53
 "Fluxolite" paper, 128
 Frequencies of radiant energy, 83

 Gas-filled incandescent lamps, 52
 Gas tube lamps, 69
 losses in, 69
 Moore type, 69
 "Getters," chemical, 52
 Glare, 97
 on streets, 213
 Glass, 138
 Glassware, 148
 Globes, 137, 146
 prismatic, principles of, 147
 Grounding, . 16

 Halls, in residences, 182
 Harcourt lamp, 106
 Hefner lamp, 107

 Illumination, 73
 calculations, 150
 flux of light, 159
 effective angle, 170
 effective flux, 169
 point-by-point, 168
 classification, 73
 components, 73
 contours, 165
 defects in, 76
 on working plane, 162
 requirements, 150
 Indirect systems, calculation for, 176
 unit, 75
 Inside wiring, 10-16
 Insulation, wire, 6
 Intensity of light, comparing, 111

 Kitchen, 180
 "Knob and tube" work, 17
 König's law, 81

 Lambert, 100
 Lamp,
 Harcourt, 106
 Hefner, 107
 pentane, 106
 Lamps
 arc, luminous, for streets, 214-
 219
 magnetite, 68
 incandescent, 50-62
 blackening of bulb, 60
 details, 52
 "efficiency," 57
 engineering data on, 170
 gas-filled, 52, 60
 history, 50
 life, 57
 manufacture, 50
 metal filament, 51
 operating characteristics, 58
 voltages, 59
 rating, 55
 voltage, 56
 specific outputs, 61
 mercury vapor, 72
 Laundry, 183

- Law of inverse squares, 83
- Library room, 184
- Life tests, 102
- Light, 82
 - definition, 82
 - white, 108
- Light and vision, 94
- Lumen, 99
 - output of mazda lamps, 170
 - output of street lamps, 170, 220
- Luminescence, 93
- Lux, 99

- Magnetite arc lamp, 68
- Merchandise, kinds of, 191
- Mercury-arc rectifier, 46
- Mercury-arc, spectrum, 93
- Mercury-vapor lamp, 72
- Metering, requirements in, 46
- Monochromatic vision, 95
- Moore tube, 69
 - characteristics, 71
 - circuits, 70, 72
 - design, 70
- Multi-wire systems, 36
- Music room, 184

- National Electric Code, 6, 13
- Networks, 31

- Office building, wiring, 23
- Office lighting, 186
 - calculations, 187
 - intensities, 187
- Outside wiring, 9
 - construction, 14
- Overhead construction, 14

- Parallel circuit, 27
 - solution of, 29
 - with excess-voltage feeders, 35
 - with feeders, 34
 - without feeders, 33
- Parlor, 178
 - second, 185
- Pentane lamp, 105
- Phosphorescence, 93
- Photoluminescence, 93
- Photometer, the, 110
 - Bunsen, 113
 - flicker, 118
 - globe, 117
 - integrating, 116
 - Lummer-Brodhun, 114
 - one-mirror, crane, 124
 - Sharp-Millar, 119
 - twin-mirror, 124
- Photometric units, abbreviations, 103
 - symbols, 104
- Photometry, 98
 - aims, 98
 - arc-lamp, 123
 - nomenclature, 98-104
 - of total light flux, 124
- Point source, 158
- Point-by-point calculation, 159
- Porches, 182
- Potential gradient, parallel circuit, 27
 - series circuit, 26
 - regulators, 41
- Power loads on lighting systems, 32
- Projectors, 227
 - focal adjustment, 227
- Purkinje phenomenon, 81, 94

- Radiation, black body, 85
 - colored, 85
 - solar, 83
 - temperature, 84
- Rates, 235
- Rectifier, mercury arc, 46
- Reduction factor, spherical, 102
- Reference standard, 101
- Reflectors, 137, 139
 - design of, 140
 - distributing, 141
 - focusing, 144
 - intensive, 143
 - varieties available, 146
- Reflection, diffuse, 87
 - coefficient of, 88, 101
 - mixed, 89
 - specular, 87
 - coefficient of, 89, 101
 - spread, 139

- Refraction, 94
 Regulators, potential, 41
 Residence lighting, 178
 wiring, 18
 Risers, 20
 Rods and cones, functioning of, 78
 Rooms, bath, 181
 bed, 181
 dining, 180
 drafting, 186
 halls, 182
 kitchen, 180
 library, 184
 living, 178
 music, 184
 parlor, second, 185
 sewing, 184
 study, 184
 vestibules, 185
 Rousseau diagram, 130

 Schools, 206
 Semi-indirect unit, 75
 Sensitivity of eye, 80
 Series circuit, 26
 Service wire, 33
 "Set of constants," 132
 Sewing room, 184
 Shades, 137, 146
 prismatic, principle of, 147
 Shafts, 225
 Showcases, 193
 Silhouette vision, 212
 Solar radiation, 83
 Specific consumption, 102
 output of electric lamps, 102
 Spectral luminosity curve, 79
 Spectrophotometer, 123
 Spherical calculations, 127
 Standard candle, 104
 luminous, 101
 reference, 101
 secondary, 109
 working, 101
 Standard lamps, Harcourt, 106
 Hefner, 107
 pentane, 106
 Statuary, 225

 Store, exclusive, 191
 large, 190
 small, 190
 windows, 193
 Store lighting, 189
 lamps to be used, 192
 Streets, 211
 classification of, 221
 lamp sizes and spacing, 213
 lamp suspension, 213
 lamps used, incandescent, 216
 luminous arc, 214
 lighting calculations, 222
 principles involved in lighting, 211
 silhouette vision on, 212
 Study, 184
 Subdivision of light source, 158
 Switchboards, 38
 direct control, 39
 operating features, 40
 remote control, 40
 Symbols for photometric quantities, 104

 Tests, life, 102
 Three-wire system, 37
 Transformer, location of, 15
 Transmission of light through a body, 90

 Units, photometric, 103
 Utilization, efficiency of, 156, 157
 factor for offices, 187
 factor for stores, 192
 factor for windows, 196

 Ventilation of show cases, 196
 Vestibules, 185
 Visibility of light sources, 74
 relative, of colors, 96
 Vision, color, 79
 form, 79
 light and, 94
 monochromatic, 95
 Visual acuity, 95

 Walls, effect of, 155, 165, 173
 White light, 108

- Windows, store, 193
 - reflector for, 195
- Wire, calculations, 2, 3
 - copper, 1, 2, 5
 - insulation, 6
 - iron, 3, 4, 5
- Wire, sizes used, 6
 - steel, 6
- Wiring, 13
 - large buildings, 22
 - residences, 18
- Working standard, 101



3 8482 00533 8104

JAN 29 1990

621.32 F35e c.1
Ferguson, Olin Jerome.
Electric lighting,

University Libraries
Carnegie-Mellon University
Pittsburgh, Pennsylvania 15213

UNIVERSAL
LIBRARY



138 407

UNIVERSAL
LIBRARY