

CHAPTER VI

Thyristor and Transistor Switches

6.1 Thyristor Zero-Point Switches

Zero-point switches are highly desirable in many applications because they do not generate electro-magnetic interference (EMI). A zero-point switch controls sine-wave power in such a way that either complete cycles or half cycles of the power-supply voltage are applied to the load as shown in Figure 6-1. This type of switching is primarily used to control power to resistive loads such as heaters. It can also be used for controlling the speed of motors if the duty cycle is modulated by having short bursts of power applied to the load and the load characteristic is primarily inertial rather than frictional. Modulation can be on a random basis with an on-off control, or on a proportioning basis with the proper type of proportioning control.

In order for zero-point switching to be effective, it must be true zero-point switching. If an SCR is turned on with an anode voltage as low as 10 volts and a load of just a few hundred watts, sufficient EMI will result to nullify the advantages of going to zero-point switching in the first place. The thyristor to be turned on must receive gate drive exactly at the

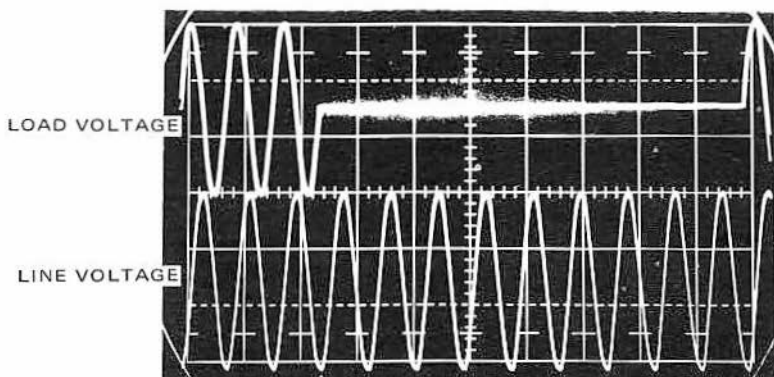

Figure 6-1 — Load Voltage and Line Voltage for 25% Duty Cycle

zero crossing of the applied voltage. Because of this exact-timing requirement, pulse-type thyristor triggering is usually impracticable, since even small timing drifts will result in off-zero switching, or possibly no switching at all.

The most successful method of zero-point thyristor control is therefore, to have the gate signal applied before the zero crossing, and have it remain somewhat past the zero crossing. As soon as the zero-crossing occurs, anode voltage will be supplied and the thyristor will come on. This is effectively accomplished by using a capacitor to derive a 90° -leading gate signal from the power line source. However, only one thyristor can be controlled from this phase-shifted signal, and a slaving circuit is necessary to control the other SCR to get full-wave power control. These basic ideas are illustrated in Figure 6-2. The slaving circuit fires only on the half cycle after the firing of the master SCR. This guarantees that only complete cycles of power will be applied to the load. The gate signal to the master SCR receives all the control; a convenient control method is to shunt the gate signal to ground whenever the SCRs are supposed to remain off. The gate shunt can be a low-power transistor, which can be controlled by bridge sensing circuits, manually controlled potentiometers, or various other techniques.

A basic SCR slaving circuit such as shown in Figure 6-2 is very effective and trouble free. However, it can dissipate considerable power. This must be taken into account in designing the circuit and its packaging. Slaving circuits which dissipate less power can be devised but they usually require active devices which add considerably to circuit cost.

In the case of triacs, a slaving circuit is also usually required to furnish the gate signal for the negative half cycle. However triacs can use slave circuits requiring less power than do SCRs, as shown in Figure 6-3. Other considerations being equal, the ease of slaving will sometimes make the triac circuit more desirable than the SCR circuit.

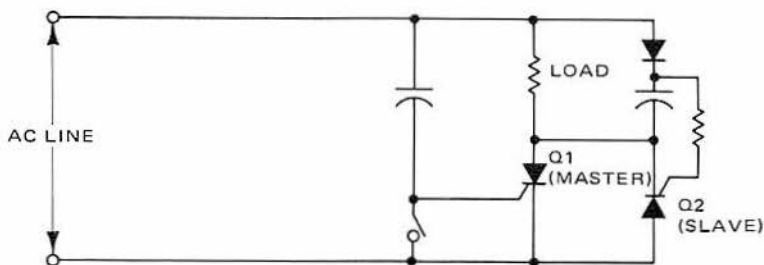

Figure 6-2 — Slave and Master SCRs for Zero-Point Switching

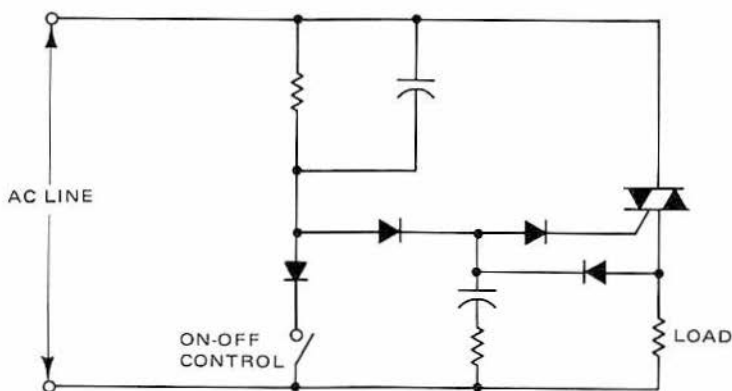

Figure 6-3 – Triac Zero-Point Switch

Besides slaving-circuit power dissipation, there is another consideration which should be carefully checked when using high-power zero-point switching. Since this is on-off switching, it abruptly applies the full load to the power line every time the circuit turns on. This may cause a temporary drop in voltage which can lead to erratic operation of other electrical equipment on the line (light dimming, TV picture shrinkage, etc.). For this reason, loads with high cycling rates should not be powered from the same supply lines as lights and other voltage sensitive devices. On the other hand, if the load-cycling rate is slow, say once per half minute, the loading flicker may not be objectionable on lighting circuits.

A note of caution is in order here. Neither of the full-wave, zero-point-switching controls illustrated in Figures 6-2 and 6-3 should be used as half-wave controls by removing the slave SCR: When the slave SCR in Figure 6-2 is removed, the master SCR has positive gate current flowing over approximately $1/4$ of a cycle while the SCR itself is in the reverse-blocking state. This occurs during the negative half cycle of the line voltage. When this condition exists, Q1 will have a high leakage current with full voltage applied and will therefore be dissipating high power. This will cause excessive heating of the SCR and may lead to its failure. If it is desirable to use such a circuit as a half-wave control, then some means of clamping the gate signal during the negative half cycle must be devised to inhibit gate current while the SCR is reverse-blocking.

Practical Zero-Point Switches

The zero-point switches shown in Figures 6-4 and 6-5 are used to insure that the control SCR turns on at the start of each positive alterna-

tion. If the SCR were turned on later in the alternation, the turn-on voltage and current spikes could cause electro-magnetic interference (EMI). In Figure 6-4, a pulse is generated before the zero crossing and provides a small amount of gate current when line voltage starts to go positive. This circuit is primarily for sensitive-gate SCRs. Less-sensitive SCRs, with their higher gate currents, require smaller values for R1 and R2, and the result can be high power dissipation in these resistors. The circuit of Figure 6-5 uses a capacitor, C2, to provide a low-impedance path around resistors R1 and R2, and can be used with less-sensitive, higher-current SCRs. This circuit actually oscillates near the zero-crossing point and provides a series of pulses to assure zero-point switching. The basic circuit is that shown in Figure 6-4. Operation begins when switch S1 is closed. If the positive alternation is present, nothing will happen since diode D1 is reverse-biased. When the negative alternation begins, capacitor C1 will charge through resistor R2 toward the limit of voltage set by the voltage divider consisting of resistors R1 and R2. As the negative alternation reaches its peak, C1 will have charged to about 40 volts. Line voltage will decrease, but C1 cannot discharge because diode D2 will be reverse-biased. It can be seen that C1 and three-layer diode D4 are effectively in series with the line. When the line drops to -10 volts, C1 will still be 40 volts positive with respect to the gate of Q1. At this time D4 will see about 30 volts and will break back about 10 volts. This allows C1 to discharge through D3, D4, the gate, R2, and R1. This discharge current will continue to flow as the line voltage crosses zero and will insure that Q1 turns on at the start of the positive alternation. Diode D3 prevents reverse gate current and resistor R3 prevents false triggering.

The circuit in Figure 6-5 operates in a similar manner up to the point where C1 starts to discharge into the gate. The discharge path will now be from C1 through D3, D4, R3, the gate, and capacitor C2. C2 will eventually charge from the pulse at the cathode of Q1. This will reduce the voltage across D4 and it will turn off, and again revert to its blocking state. Now C2 will discharge through R1 and R2 until the voltage on D4 again becomes sufficient to cause it to break back. This repetitive exchange of charge from C1 to C2 causes a series of gate-current pulses to flow as the line voltage crosses zero. This means that Q1 will again be turned on at the start of each positive alternation, as desired. Resistor R3 has been added to limit the peak gate current.

Additional zero-point-switching circuits are shown in the temperature-control section of this chapter (6.2). A slave circuit which can be added to the circuits just discussed to provide full-wave power is shown in section 6.3.

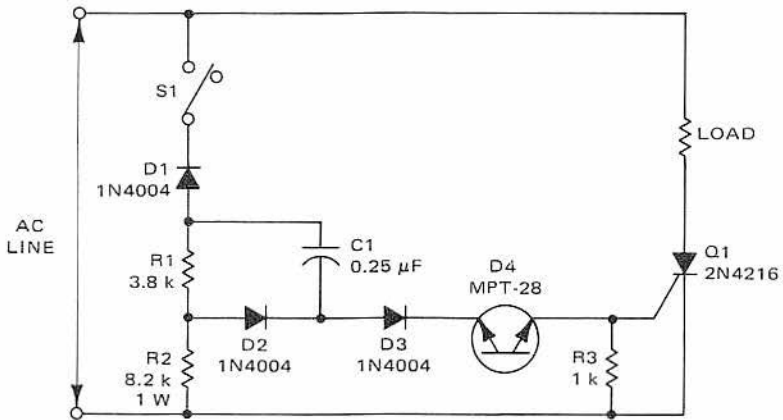

Figure 6-4 – Sensitive-Gate Switch

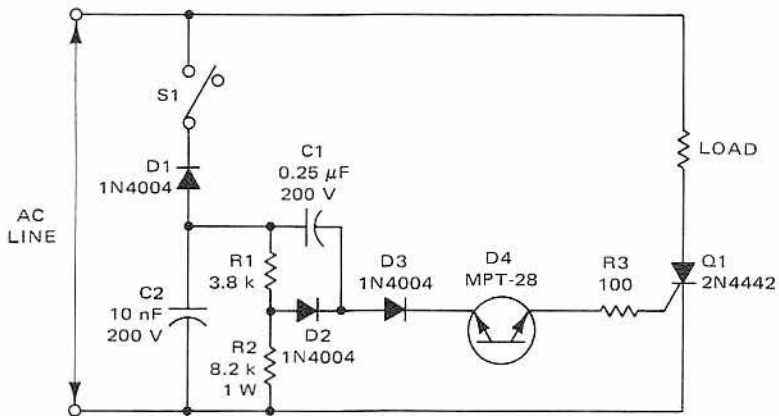

Figure 6-5 – Zero-Point Switch

6.2 Zero-Point Temperature-Control Circuits

117 Vac, 3 kW Temperature-Control Circuit

The circuit shown in Figure 6-6 is a temperature controller. It can directly drive any heating element which consumes 3 kW of power or less. The temperature-sensing element is a thermistor which controls base drive to a transistor. Switching of the load is done at the zero point of the ac input voltage to prevent electro-magnetic interference (EMI). When the thermistor is chosen to have a resistance of 5 k Ω at the desired operating temperature, temperature regulation will be better than 1%.

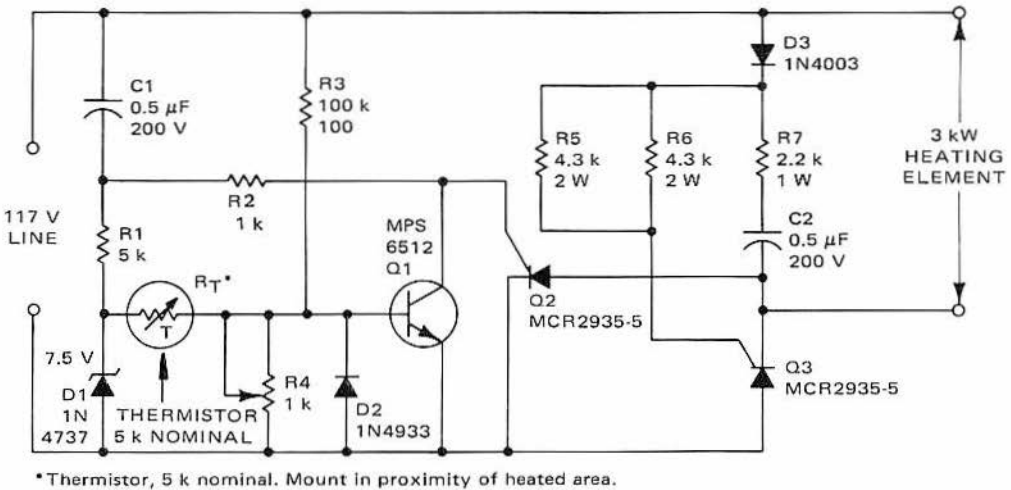

Figure 6-6 — 3 kW Temperature-Control Circuit

Operation of the circuit is as follows: capacitor C1, which is in series with resistor R1, causes current in zener diode D1 to lead the line voltage. In other words, the reference voltage will appear across the zener while the line voltage is changing from the negative to the positive alternation. The reference is divided by 10 through thermistor R_T , and potentiometer R4, to the transistor base. The nominal potentiometer setting will be $500\ \Omega$. If the thermistor is cold (high resistance), the base voltage will be low and the transistor will not turn on. Current through resistor R2, which is also leading the line voltage, will then flow into the gate of SCR Q2, and Q2 will fire at the zero crossing of the line voltage. When the thermistor becomes heated by the load, its resistance will decrease. Now base drive during the zero-point interval will increase and the transistor will remain on. In this case, no current can flow into the gate of Q2 and the heater will be turned off at the desired temperature. Resistor R3 prevents Q2 from being gated on beyond the zero-crossing point by turning on transistor Q1 and shunting the gate drive.

The circuit can actually be operated over a range of temperature by manually adjusting the $1\ \text{k}\Omega$ potentiometer. Tests performed with a $5\ \text{k}\Omega$, 25°C rod thermistor indicate that the circuit would regulate up to 60°C . Thermistor resistance changed from $5\ \text{k}\Omega$ to $1.4\ \text{k}\Omega$ over this range.

The RC circuit connected across the load is used to sense the stored energy during the positive voltage alternation. If Q2 has been triggered on, this energy will then be used to gate Q3 on during the following negative alternation. Capacitor C2 will begin discharging through the gate of Q3 while the line voltage is still positive. Thus, Q3 will also be turned at the zero point of the line voltage. Since Q3 is slaved to Q2, the power to the load will be applied in full cycles.

230 Vac, 4 kW Temperature-Control Circuit

Figure 6-7 shows a modulated SCR zero-point-switching circuit designed to control 4 kW heater loads operating from 230 V power lines. Circuit operation will be explained by splitting the circuit into two halves. The right half consists of the SCRs and their triggering circuits. The phase-shift network (C3, R8) supplies a 90° shifted sine wave gate signal to the master SCR (Q4). Each time Q4 applies a positive half cycle of power to the load, it energizes the slave circuit which will then fire Q5 and apply the following negative half cycle of power to the load. Hence, load power is completely controlled on a full-wave basis by controlling the master SCR. When no load power is desired, the gate signal (Ig) is shunted to ground through a small SCR (Q3). This switch is commutated by the gate signal and turns off each negative half cycle assuring control on a cycle-to-cycle

Figure 6-7 — 4 kW Temperature-Control Circuit

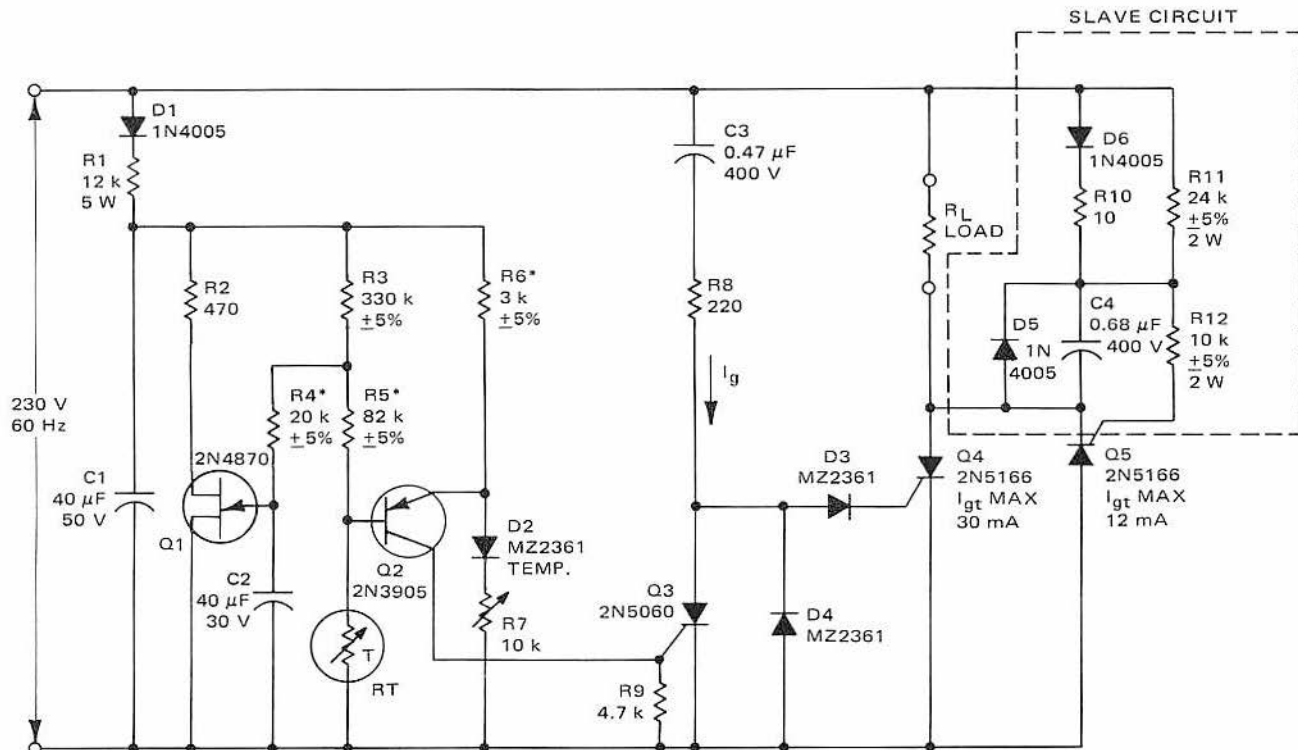

*LOW TEMP. COEFFICIENT
FENWELL QR51J1 100 k THERMISTOR

basis. Diodes D3 and D4 perform dual functions. They provide dc restoration for capacitor C3, and they also provide a dc offset which is more easily controlled by switch Q3 than if this switch were placed directly between the gate of Q4 and ground.

Modulation is accomplished with a circuit network which controls the master SCR (Q4) through switch Q3. The line frequency is divided into twelve-cycle groups, and from one to all 12 cycles from each group can be applied to the load, thus allowing the load power to be modulated in 8% steps from 0% to 100% duty cycle. The number of cycles per group can be changed by changing C2.

Modulation is achieved in the following manner: First the main on-off control for this circuit is supplied by a bridge circuit consisting of R3, R5, R_T, R6, R7, and D2. The detector for the bridge is Q2. As R_T decreases, Q2 turns on, turning on Q3, shunting the gate signal to ground and removing power from the load. Now as the temperature drops, Q3 does not come on and (if modulation were omitted) full-wave power would be applied to the load on a continuous basis. However, the modulation is applied to proportion the load power in response to small changes in R_T. The modulation is achieved by superimposing a sawtooth voltage on one arm of the bridge through R3 and R5. This sawtooth voltage is generated by the unijunction-transistor relaxation oscillator consisting of R2, R4, Q1, and C2. The sawtooth wave modulates the bridge voltage so that over a portion of the ten-cycle group the bridge voltage will be above the null point, and over the other portion it will be below the null point.

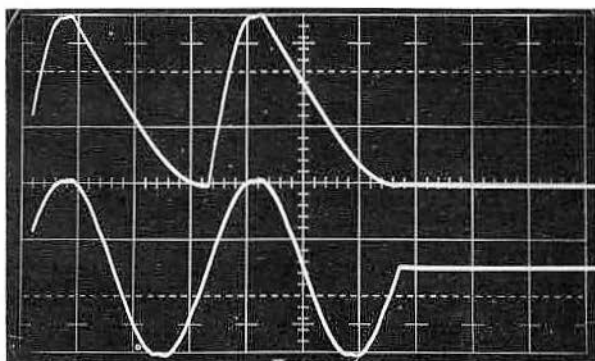

UPPER VERTICAL 100 V/cm
LOWER VERTICAL 200 V/cm
HORIZONTAL 5 ms/cm

Figure 6-8A – Capacitor Voltage and Load Voltage versus Time

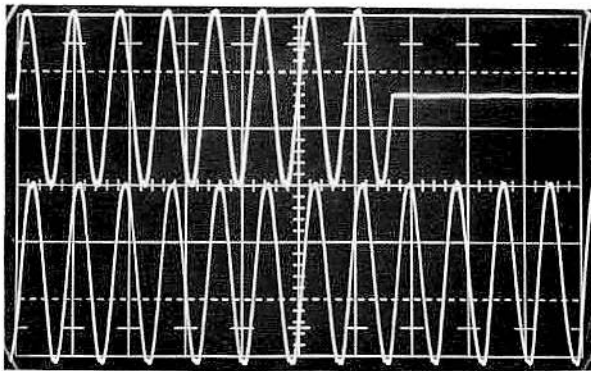

UPPER VERTICAL 100 V/cm
LOWER VERTICAL 200 V/cm
HORIZONTAL 5 ms/cm

Figure 6-8B — Load Voltage and Line Voltage for 65% Duty Cycle

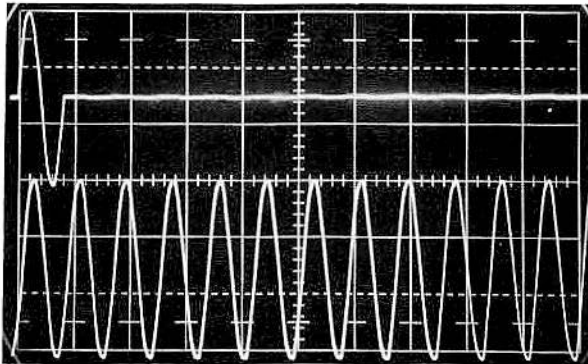

UPPER VERTICAL 100 V/cm
LOWER VERTICAL 200 V/cm
HORIZONTAL 5 ms/cm

Figure 6-8C — Load Voltage and Line Voltage for 8% Duty Cycle

This action divides each ten-cycle group into an on and off portion — the proportioning depending upon the amount R_T has varied from the nominal value. This circuit provides excellent control of a resistance heater as it will tend to stabilize and apply the correct amount of power on a continuous basis at a steady-state duty cycle depending on the load requirements. The temperature is therefore controlled over a very narrow range and no EMI is generated.

Since this circuit can switch the load power on and off at 6 Hz, it may cause undesirable flickering of incandescent lamps which are supplied

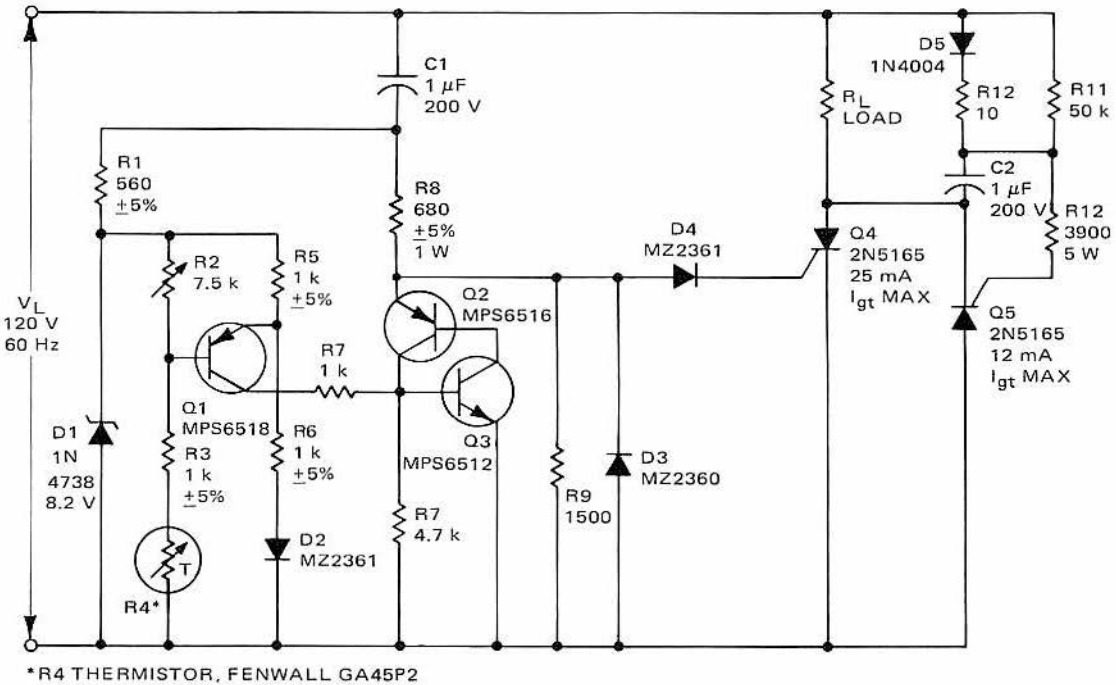

Figure 6-9 — 2 kW, 120 V Zero-Point Temperature-Control Circuit

from the same power line as the heater load. Therefore, its primary application would be in an industrial situation where separate transformers supply banks of heaters.

Figure 6-8A shows the voltage waveform on slave-circuit capacitor C4. Figures 6-8B and 6-8C illustrate the load voltage for the different duty cycles (65% and 8%).

120 Vac, 2 kW Temperature-Control Circuit

Figure 6-9 shows a zero-point temperature-control switching circuit capable of controlling 2 kW watts from a 120 V supply. The circuit philosophy is basically the same as the temperature-control circuit shown in Figure 6-7, except that the proportioning feature has been removed. In many applications this type of circuit can be used on lighting circuits to control small heating loads such as portable heaters and electrical appliances. Here the cycling rate is controlled by temperature, so it will overshoot slightly because of the time lag between the heat source, the surface being controlled, and the thermistor (R4). By tailoring the amount of overshoot to the device being controlled, the cycling rate will be determined by the temperature overshoot and can be made slow enough — say once per minute — that it will not cause objectionable light blinking or TV picture size changes.

6.3 110 Vac SCR Slaving Circuit

When half-wave control of an ac line has been realized, it is often desirable to extend this to full-wave control. A slaving circuit is used to accomplish this. The slave circuit must sense when the master SCR has been gated and fire a slave SCR for the following alternation.

The SCR slaving circuit shown in Figure 6-10 provides a single power pulse to the gate of SCR Q3 each time Q2 turns on, thus turning Q3 on for the half cycle following the one during which Q2 was on. Q3 is therefore turned on only when Q2 is turned on, and the load can be controlled by a signal connected to the gate of Q2 as shown in the schematic. The control signal can be either dc or a power pulse. If the pulse is synchronized with the line, as shown in section 6-22, this circuit will make an excellent zero-point switch. During the time that Q2 is on, capacitor C1 is charged through R1, D1, and Q2. While C1 is being charged, D1 reverse-biases the base-emitter junction of Q1, thereby holding it off. The charging time constant, R1-C1, is set long enough that C1 charges for practically the entire half cycle. The charging rate of C1 follows a S-shaped curve, charging slowly at first, then faster as the supply voltage peaks, and finally slowly again as the supply voltage decreases. When the supply voltage falls

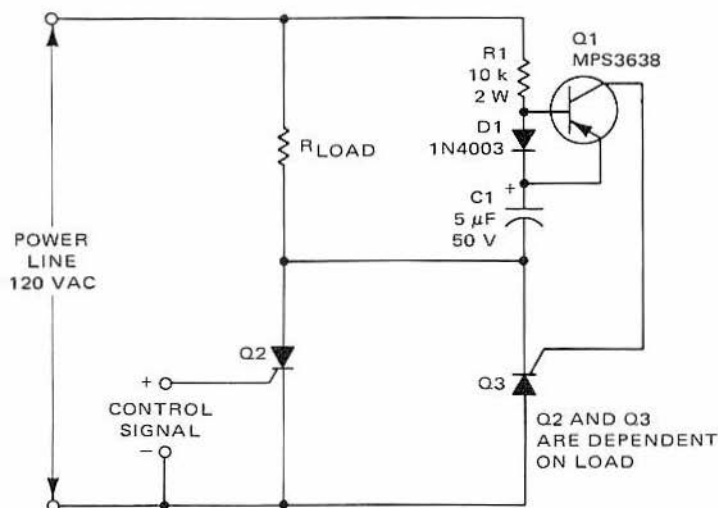

Figure 6-10 — 110 Vac SCR Slaving Circuit

below the voltage across C1, diode D1 becomes reverse-biased, and the base-emitter of Q1 becomes forward-biased. For the values shown, this occurs approximately 6° before the end of the half-cycle conduction of Q2. The base current is derived from the energy stored in C1 and is returned to C1 through R1 and the load. This turns Q1 on, and discharges C1 through the gate of Q3. As the voltage across C1 decreases, the base drive of Q1 decreases and limits the collector current somewhat. The current pulse must last until the line voltage reaches a magnitude such that holding current will exist in Q3. The values shown will deliver a current pulse which peaks at 100 mA and has a magnitude greater than 50 mA when the anode-cathode voltage of Q3 reaches +10 volts. This circuit completely discharges C1 during the half cycle that Q3 is on. This eliminates the possibilities of Q3 being slaved for additional half cycles after the drive is removed from Q2. The peak current and the current duration are controlled by the value of R1. Therefore, the proper value of R1 can be chosen for any given family of SCRs. The particular SCR used must be capable of handling the maximum current requirements of the load to be driven.

6.4 Light Dimmers

800 W Soft-Start Light Dimmer

A circuit capable of controlling incandescent lamp loads up to 800 watts from a 120 V, 60 Hz line is shown in Figure 6-11. Lamp failures

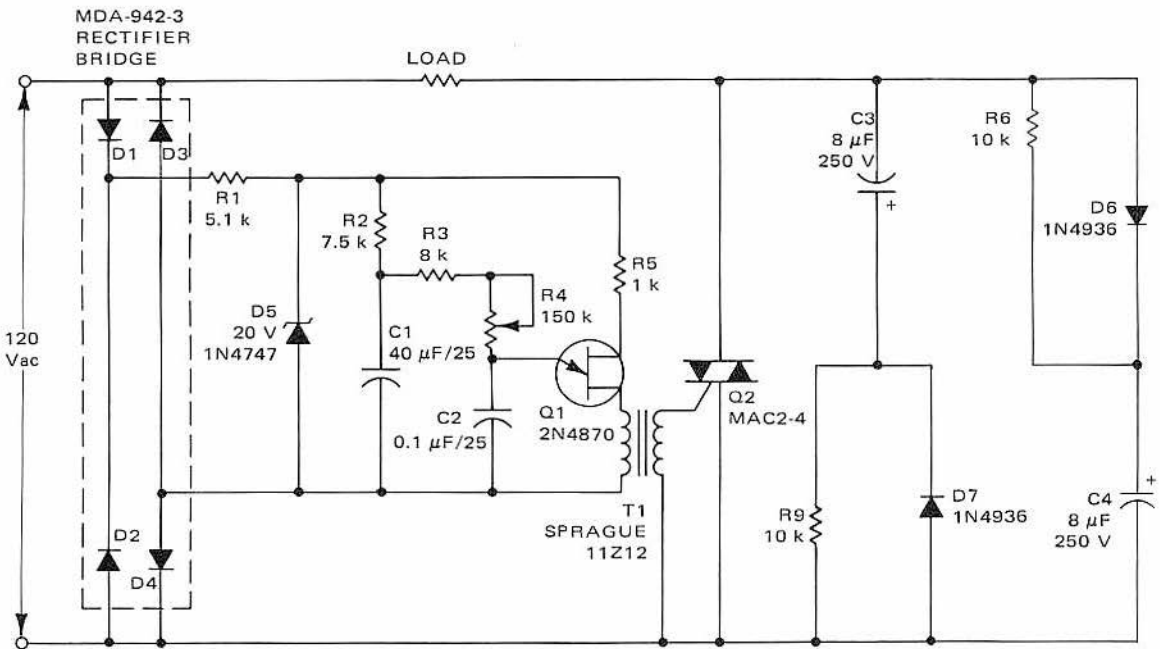

Figure 6-11 — 800 W Soft-Start Light Dimmer

normally caused by high inrush currents are eliminated by the soft-start feature. Accidental turn on, which could nullify this advantage, is prevented by a special dv/dt network.

Operation of this circuit begins when voltage is applied to the diode bridge consisting of D1 through D4. The bridge rectifies the input and applies a dc voltage to resistor R1 and zener diode D1. The zener provides a constant voltage of 20 volts to unijunction transistor Q1, except at the end of each alternation when the line voltage drops to zero. Initially, the voltage across capacitor C1 is zero, and capacitor C2 cannot charge to trigger Q1. C1 will begin to charge, but because the voltage is low, C2 will have adequate voltage to trigger Q1 only near the end of the half cycle. Although the lamp resistance is low at this time, the voltage applied to the lamp is low and the inrush current is small. Then the voltage on C1 rises, allowing C2 to trigger Q1 earlier and earlier in the cycle. At the same time the lamp is being heated by the slowly increasing applied voltage and by the time the peak voltage applied to the lamp has reached its maximum

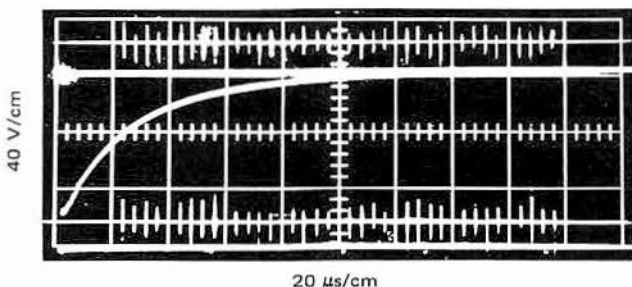

Figure 6-12 — Voltage Rise Across Triac into One 500 W Light Bulb, Using dv/dt Network. 20 μ/div, Horizontal. 40 V/div, Vertical.

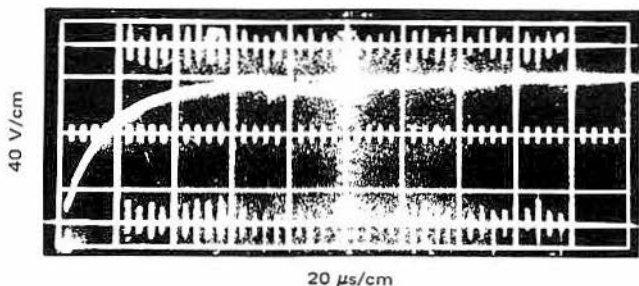

Figure 6-13 — Voltage Rise Across Triac into Two 500 W Light Bulbs, Using dv/dt Network. 20 μ/div, Horizontal. 40 V/div, Vertical.

value, the bulb has been heated sufficiently that the peak inrush current is kept to a reasonable value. Resistor R4 controls the charging rate of C2 and provides the means to dim the lamp. Power to the load can be adjusted manually by varying the resistance of R4.

The dv/dt network is used to prevent the line voltage from triggering triac Q2 before the light has warmed up. This would occur at the instant power is first applied to the circuit if the instantaneous line voltage were sufficient to cause triggering. Capacitor C3 will delay a negative rise in voltage by charging through the load and diode D7. Capacitor C4 does the same for a positive rise. Resistors R6 and R7 are used to discharge capacitors C3 and C4.

A test used to evaluate this network is as follows: A 120 volt dc source was used to charge C4 through a cold 500 watt bulb. The voltage rise shown across the triac in Figure 6-12 is 6 volts per microsecond. A 500 watt load should therefore be the maximum allowable load for an ambient temperature of 65°C. The same test was also confirmed with a 1000 watt load. The rate of rise for this case, as shown in Figure 6-13, is 10 volts per microsecond and the device did not turn on. This is considered to be a safe rate of rise when the ambient temperature is 25°C. In other words, this network will protect the triac from loads as high as 1000 watts at room temperature.

800 W Light Dimmer

A light dimmer circuit which operates from a 120 volt ac source and can control 800 watt incandescent bulbs is shown in Figure 6-14. Output power is varied by controlling the phase of conduction of triac Q1. All of the circuits in Table 6-I have this capability, but the single triac circuit

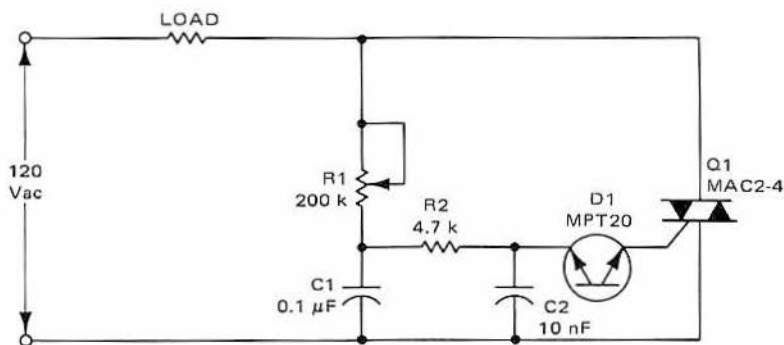

Figure 6-14 – Simple 800 W Triac Light Dimmer

shown as circuit two in Table 6-I is the simplest by far and is the one chosen for this particular application. The control circuit for this triac application must function as shown in Figure 6-15. That is, it must create a delay between the time voltage is applied to the circuit (shown dotted) and the time it is applied to the load. The triac is triggered after this delay and conducts current through the load for the remaining part of each alternation. This circuit can control the conduction angle from 0 to about 170° and provides better than 97% of full-power control.

The operation of this circuit can best be understood by referring to the waveforms of Figure 6-16 which are taken from the circuit in Figure 6-14. Figure 6-16A shows the voltage across capacitor C1, and Figure

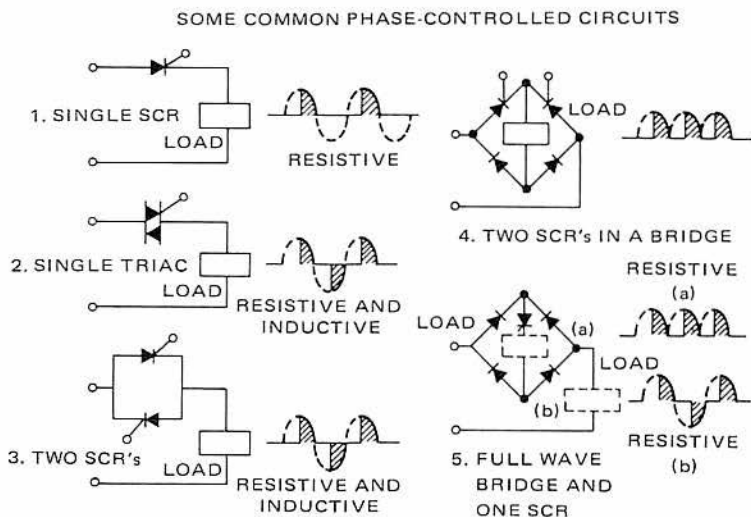

TABLE 6-I

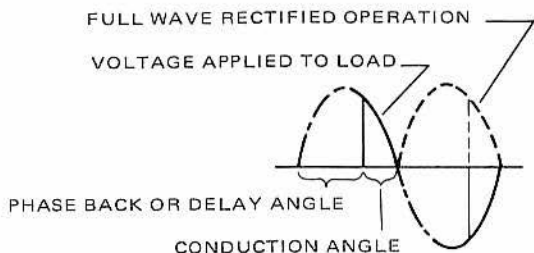

Figure 6-15 — Sine Wave Showing Principles of Phase Control

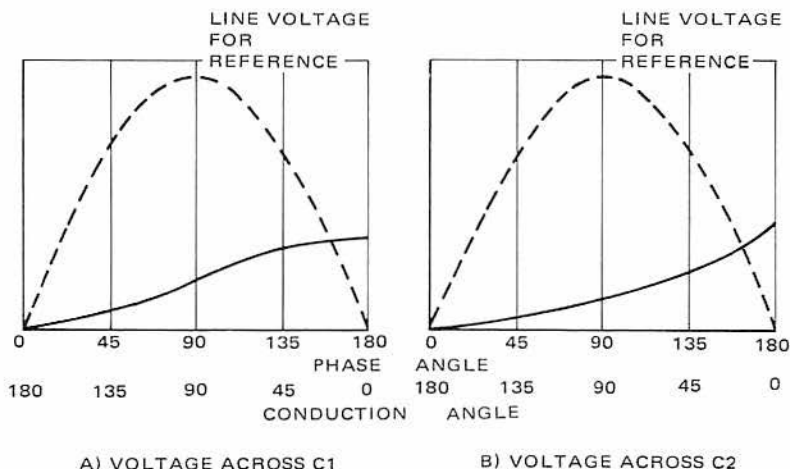

Figure 6-16 — Comparison of Trigger Voltage Waveforms in Single-Section and Two-Section Phase-Shift Circuits. Circuit Shown in Figure 6-14.

6-16B shows the voltage across capacitor C2. Each begins to charge as shown when the positive alternation of line voltage is applied to the circuit. It is affected by the decrease in line voltage for phase angles greater than 90°. However, capacitor C2 is better isolated, and continues to charge at a fairly linear rate even beyond 90°. In order to trigger the triac, this voltage must exceed the breakover voltage of three-layer diode D1 (20 volts) sometime during this alternation. This is accomplished by reducing the in-circuit resistance of potentiometer R1 so that the capacitors will charge faster. When the diode breaks down, the capacitors discharge into the gate of triac Q1 and turn it on. These same voltages will appear during the negative alternation and trigger the triac by pulling current out of the gate.

The two-section phase-shift circuit allows reliable and stable triggering at low conduction angles. The 180° phase shift of this circuit (when unloaded) gives diode D1 an almost-linear ramp from which to trigger, rather than the flat top of a sine wave which occurs as the phase approaches 180° with a single-section circuit (see Figure 6-16). Slight power-supply voltage variations which might cause 5° to 10° jitter at low conduction angles in single-section circuits, cause less than 1° variation with the two-section phase shift circuit.

The starting current in this circuit could cause a problem. The cold resistance of the filament in a 500 watt bulb is about 2 Ω. A 120 volt line

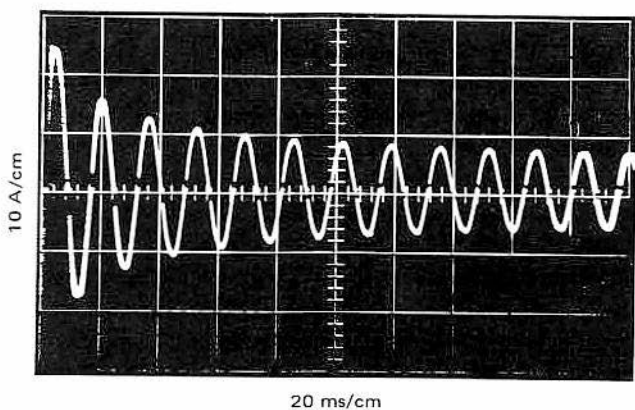

Figure 6-17A — Turn-On Surge Current at 180° Conduction Angle into a 500 W Bulb. 10 A/div, Vertical. 20 ms/div, Horizontal.

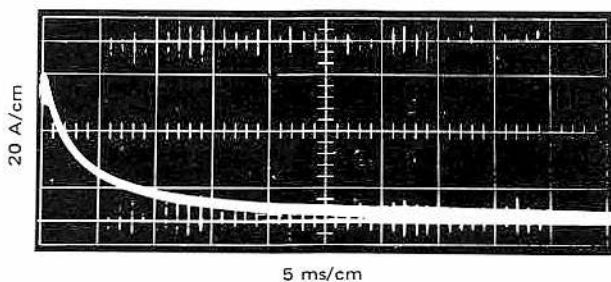

Figure 6-17B — Turn-On Time for a 500 W Bulb from 120 Vdc. 20 A/div, Vertical. 5 ms/div, Horizontal.

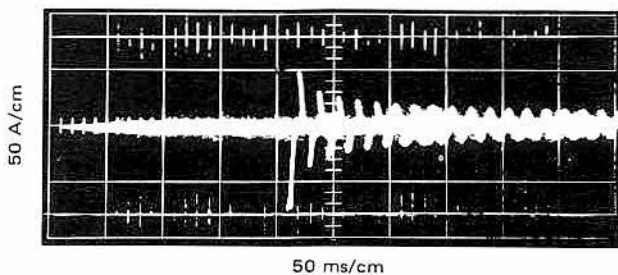

Figure 6-17C — Surge Current into a Cold 500 W Light Bulb Using a Triac Light Dimmer with a 60° Conduction Angle. 50 A/div, Vertical. 50 ms/div, Horizontal.

could therefore produce peak-surge currents of 85 amperes. The starting current waveform for a 180° conduction angle is shown in Figure 6-17A. The peak surge current is less than 30 A and Figure 6-17B shows why. With 120 volts dc applied, the peak current reaches 60 A but decreases to less than 30 A in 5 milliseconds. This means that the filament resistance can double in just a few milliseconds. In Figure 6-17A, the filament actually has 4 milliseconds to warm up before the peak voltage is reached, but this is enough time for the resistance to increase and limit the current. A more severe test is shown in Figure 6-17C. Here the triac is triggered with a 60° conduction angle. The 150 volts applied at this time into the cold filament produces a 75 A current surge. Again, the filament resistance increases rapidly so that this surge was reduced by 60% within two cycles. Based on this information and the I^2t rating of the triac, surge currents from a 1000 watt lamp load at 90° conduction would be the maximum that this device can withstand.

Tests with two 500 watt bulbs in parallel revealed some interesting data as shown in Figure 6-18. When the bulbs had been operating for a while so that resistance stabilized, the steady-state resistance increased from 1Ω starting resistance to about 12Ω , and varied as a function of the conduction angle. For instance, there is more peak current at 70° conduction than at 90° , even though the voltage is less at 70° . The probable explanation is that the filament has more time to cool when operating at

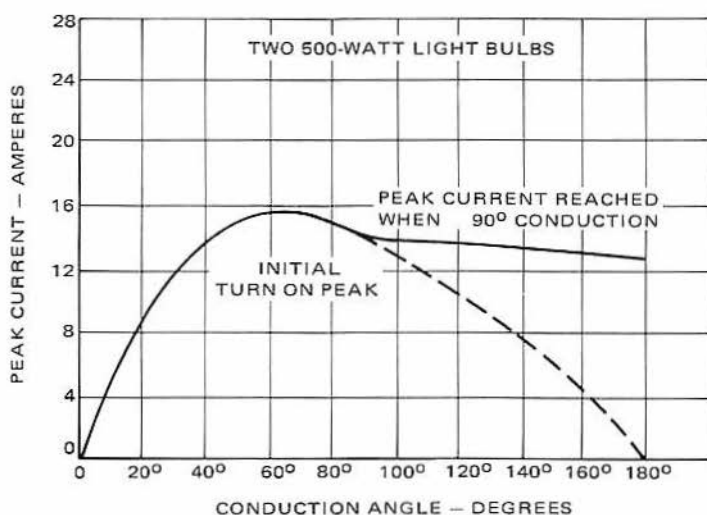

Figure 6-18 — Repetitive (60 Hz) Peak Currents of Triac Light Dimmer versus Conduction Angles

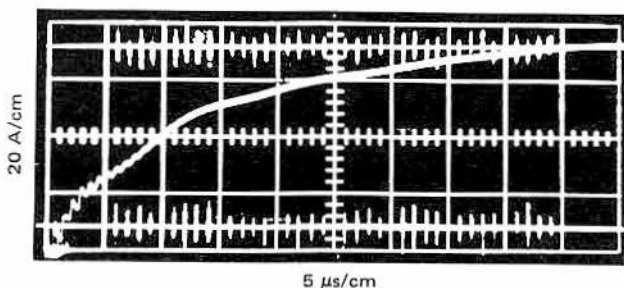

Figure 6-19A — Current Rise into a 500 W Bulb into a 60° Conduction Angle. 20 A/div, Vertical. 5 μ s/div, Horizontal.

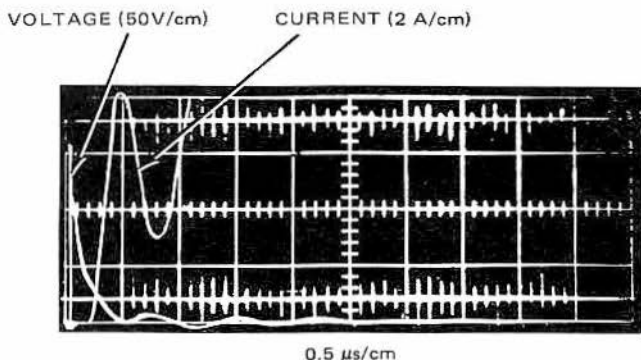

Figure 6-19B — Turn-On Current and Voltage Across Triac with 500 W Bulb and a 60° Conduction Angle (Single Sweep). 2 A/div Current Trace, Vertical. 50 V/div Voltage Trace, Vertical. 0.5 μ s/div, Horizontal.

lower conduction angles and its average resistance will therefore be lower. And, because beyond 90° the filament had less time to cool, average resistance increased and the peak current fell slightly as shown. This variation actually has very little effect on the normal operation of the triac.

Another possible problem could be caused by the power dissipated while the triac is turning on. Figure 6-19A shows the current increasing to 75 A for the previous case (Figure 6-17C) of a cold filament operating at a 60° conduction angle. The current increases to 60% of peak current in about 10 μ s. Since the only resistance in the circuit is the 2 Ω filament, it determined that there must be about 20 μ H of circuit inductance. This explains the turn on waveforms in Figure 6-19B. The triac turns on in less than 0.5 μ s as shown by the voltage waveform. The current surge however, is delayed for 0.3 μ s, and therefore no appreciable amount of power is

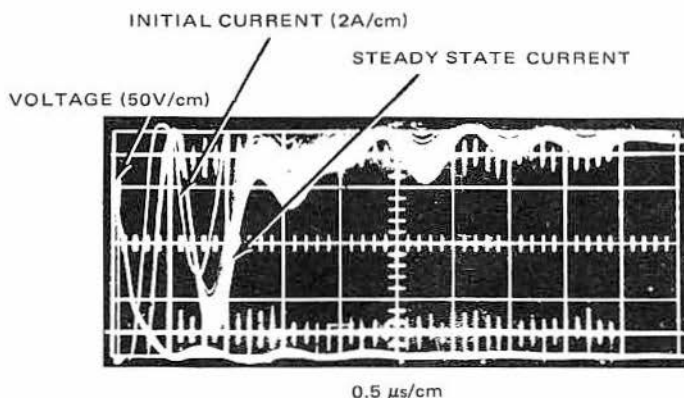

Figure 6-19C — Turn-On Current and Voltage Across Triac with a 500 W Bulb and a 60° Conduction Angle (Repetitive Sweep). 2 A/div Current Trace, Vertical. 50 V/div Voltage Trace, Vertical. 0.5 μs/div, Horizontal.

generated. Figure 6-19C shows the initial surge plus the steady-state turn-on currents. This further illustrates the fact that the circuit inductance is sufficient to limit the power dissipated during turn on.

There is one other possible mode of failure for the triac. That is, if the power switch were closed at the peak of line voltage, the rise of voltage would trigger the triac on. This will not destroy it since the inrush current is limited, even at this time, by the circuit inductance.

6.5 Light-Operated High-Voltage Series Switch

The circuit shown in Figure 6-20 is a high-voltage switch composed of a series string of SCRs which are triggered simultaneously from a single light source. Triggering is accomplished with phototransistors (MRD-300) driven by a xenon flash tube through a fiber-optic bundle.

Across each SCR is a 1.5 MΩ resistor in series with a 51 kΩ resistor. These resistors form not only the voltage equalization network for the series-connected SCRs, but also voltage dividers for each SCR, with 20 volts developed across each 0.1 μF capacitor and 51 kΩ resistor. This voltage provides collector bias for each phototransistor and a source of gate current for each SCR.

When the xenon tube is flashed the light is fed into the fiber-optic bundle where it is split into ten outputs of approximately equal amplitude and fed simultaneously to each phototransistor. As each phototransistor

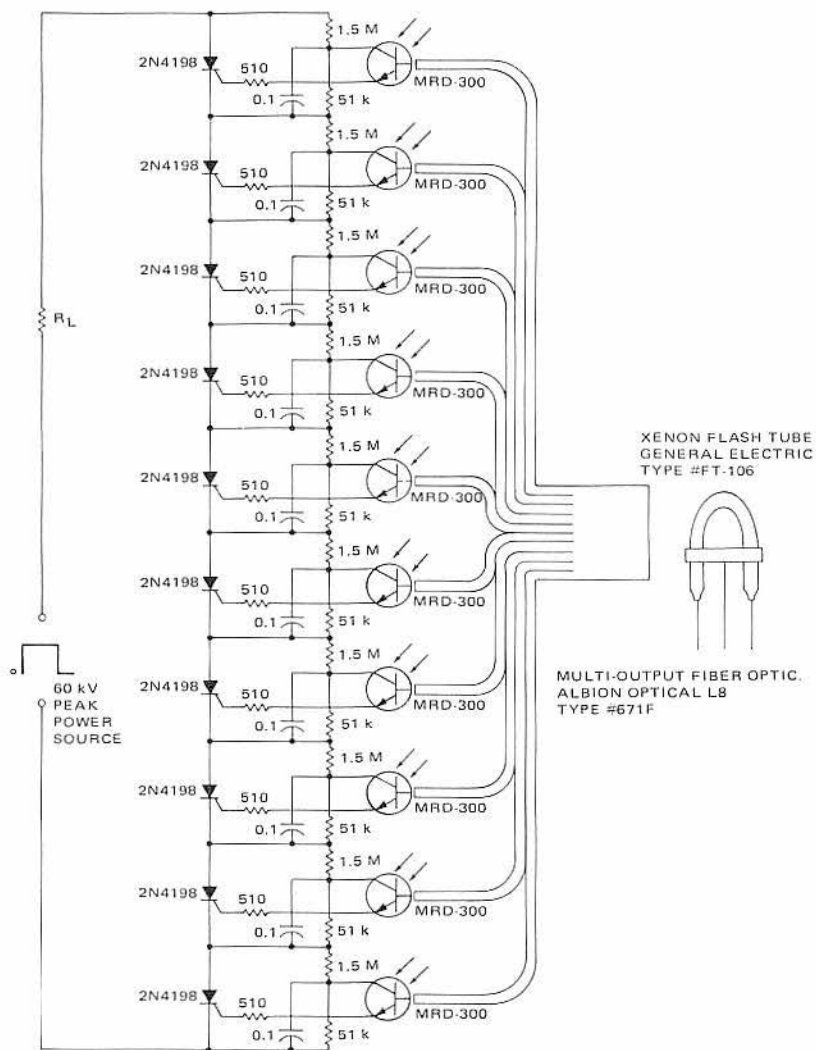

Figure 6-20 – Light-Operated 6 kV Series Switch

conducts, it discharges the $0.1 \mu\text{F}$ capacitor into the gate of its corresponding SCR via the 510Ω resistor, turning all of the SCRs on at once.

Triggering series-connected SCRs by this method offers several advantages over other types of triggering. The use of light via phototransistors results in simultaneous firing of the SCRs, thus eliminating the inductive delays that would result if conventional wiring were used to transport a gate signal from a central source. Also, the use of fiber optics eliminates the need for special trigger transformers that can withstand the high voltages that would exist between windings.

The turn-on time of the circuit shown was measured to be about 300 ns at 1 A anode current; the maximum capability of the circuit is a 100 A pulse for 4 ms with a 6 kV input voltage. The SCRs must have matched rise times so that the slowest units will not be gated on by anode breakover due to earlier turn on of the faster devices.

This circuit would be most useful in high-voltage crowbar circuits or high-voltage pulse-forming networks. Also, with minor modifications it could be adapted to certain proportional control systems.

6.6 Time Delay Circuits

Long Duration FET Timer

The circuit shown in Figure 6-21 is used to obtain a time delay of up to 10 hours. Basically, it is a unijunction-transistor sawtooth oscillator. Output pulses can be obtained from either base one or base two of Q3. The conventional charging resistor for capacitor C_E has been replaced by a current source consisting of resistors R1 through R3 and transistor Q1. As

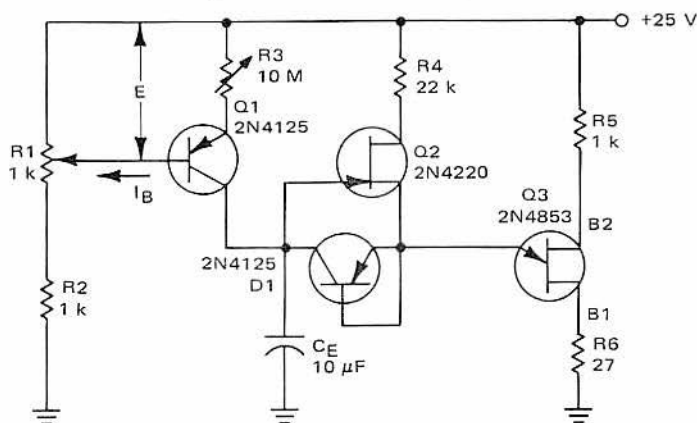

Figure 6-21 — Long-Duration Time Delay

is the case in most long-delay timers using UJTs, the charging current from Q1 will generally be inadequate to supply the peak point current required to trigger Q3. Field-effect transistor Q2 has been placed in parallel with R3 and Q1 to provide the peak point current. Diode D1 has been added to provide a low-resistance path to discharge C_E once its voltage has become sufficient to trigger Q3. Otherwise, the discharge current would pass through the gate-source junction of Q2 and cause damage to the FET.

The time required for C_E to charge is determined by the formula,

$$T = \frac{C_E V_T}{I_C},$$

where

T = the time in seconds,

C_E = the capacitor value in μF ,

V_T = the trigger voltage (about 20 V), and

I_C = the charging current (variable) in μs

The maximum time is obtained when the current source is zero and only leakages are considered, although this is not recommended as a mode of operation. Figure 6-22 shows that worst case leakages at 25°C could total 100nA. The maximum delay time would then be 1/2 hour. In order to remove the dependence of V_T on leakage current, it would be advisable to operate the current source an order of magnitude higher. A certain

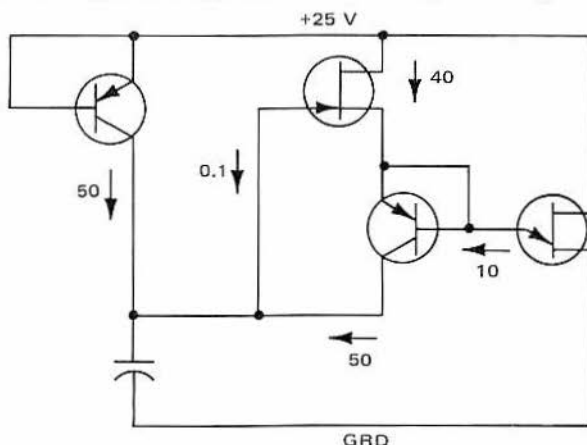

Figure 6-22 — Worst-Case Leakage Currents in Nanoamperes

amount of stability and repeatability would occur when $I_C = 1 \mu\text{A}$, but time delay would be reduced to about 3 minutes maximum. Fortunately, the typical values of leakage currents are less by a factor of 50 (only 2 nA) as shown on the data sheet for the 2N2217, a device similar to the 2N4125. This means that leakage currents alone would create a 30 hour time delay. The insulation resistance of C_E could limit this time if R_C is less than $V_T/I_C = 20/2n = 10 \text{ G}\Omega$. It turns out however, that the minimum insulation resistance of C_E at 25°C is $20 \text{ G}\Omega$ and we were able to operate in practice with up to a 10 hour time delay. Again, for stable operation, it would be advisable to operate the current source with at least 20 nA ($10 \times 2 \text{ nA}$) for a maximum delay of 3 hours.

The current source is actually voltage sensitive since it converts a constant voltage reference to a constant current reference. It can be seen that $I_C = V_3/R_3$, if we ignore leakages. Both V_3 and R_3 are variable. R_3 would normally be set at its maximum value to make V_3 larger and less sensitive to voltage changes in the circuit. And $V_3 = E - V_{BE}$ where E is the manually variable voltage across the upper half of R_1 and V_{BE} is a relatively constant base-emitter voltage drop. If we consider the typical maximum-delay case of 3 hours, I_C will equal 20 nA. If the time delay is to change by less than 10% for voltage variations, then the change in I_C must be less than 2 nA. The voltage E , which would be 0.8 volt, cannot change by more than 20 mV. This means that voltage regulation of the supply must be better than $\frac{20 \text{ mV}}{800 \text{ mV}}$ or 2.5%. Regulation should, of course, be specified to match the accuracy of time that is desired.

Finally, it is desirable to analyze the effects of temperature, or more specifically, the effects of an increase in temperature from 25°C to 125°C , on the 3 hour delay. If C_E is a 100 V polycarbonate capacitor, its insulation resistance will increase to about $2 \text{ G}\Omega$. The limiting value of R_C now will be $20 \text{ V}/20 \text{ nA}$ or $1 \text{ G}\Omega$ so we are safe by a factor of 2. V_{BE} of Q1 will decrease by 0.2 volts with this temperature rise. This doubles I_C and decreases delay time by 50%. The standoff ratio (η) of Q3 will decrease by 7% with this temperature change. This decreases V_T and delay by 7%. The leakage current of Q1 and D1 will increase to 20 nA (a factor of 10). This again doubles I_C and decreases time by 50%. Multiplying these factors ($.50 \times .50 \times .93$) gives about .23, indicating that the delay time will decrease from 3 hours to $3/4$ of an hour. The basic increase of I_C was 40 nA due to V_{BE} and leakage currents. If it is desirable for delay time to change by less than 10%, I_C should start at 400 nA. This is equivalent to saying that time delays should be kept at or below 10 minutes for operation over this range of temperature.

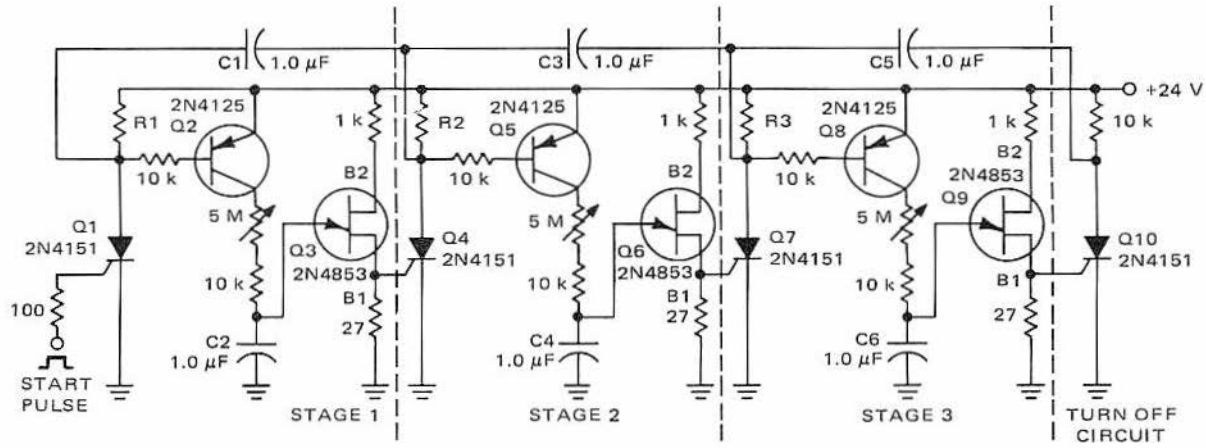

Figure 6-23 — A Sequential UJT Timer Circuit

Sequential UJT Timer

The circuit shown in Figure 6-23 is a timer in which a pulse is formed in sequence across the load resistor of each stage. In this circuit there are a total of three stages. More or fewer stages may be used if desired. The output pulse from each stage will follow that of the previous stage by an interval which is adjustable in length. A pulse at the first SCR, Q1, will start the various time intervals. SCR Q10 is used only to turn off the last stage SCR, Q7. If a timing circuit were added between Q10 and Q1, the sequence would run continuously.

Initially, all capacitors will have zero charge. A pulse at the gate of Q1 will turn it on and allow load current to flow through load resistor R1, and charging current to flow through R2 into C1. Current will also flow through the emitter-base junction of Q2 and through the 10 k Ω base resistor. This base current saturates Q2 and allows C2 to start charging through the 5 M Ω potentiometer and the 10 k Ω timing resistor. When the voltage across C2 becomes sufficient to trigger Q3, a pulse which turns on SCR Q4 is formed at base one of Q3. This places the negative voltage on C1 across Q1, causing it to turn off. Stages two and three operate in the same way. However, after SCR Q10 is pulsed on, it will turn itself off because anode current through the 10 k Ω resistor is less than holding current.

It is possible to drive relays or other types of loads directly with these SCRs. The minimum value of load resistance is determined by the turn-off time requirements and is 50 Ω . Holding current requirements set the maximum value at 1 k Ω . If it is desirable to obtain output pulses from the gate of each SCR, then R1 through R3 should each be 100 Ω . It is possible to set the delay time of each stage between 10 ms and 5s with the 5 M Ω potentiometer. This circuit would be most useful in control operations where different cycles require different time durations.

6.7 Pulse Generators

Pulse Generator with Power Amplifier

The circuit shown in Figure 6-24 is a pulse generator which provides independent control of both "on" pulse width and "off" pulse width. Two outputs of the generator are provided; they are inverted from each other and are capable of driving 50 Ω loads. The pulse generator outputs are used to drive two power stages, which are capable of furnishing 6 A to a 5 Ω load.

The basic circuit of the generator is an astable multivibrator formed by Q5 and Q6. The timing elements for the "on" period are C4, R20, and

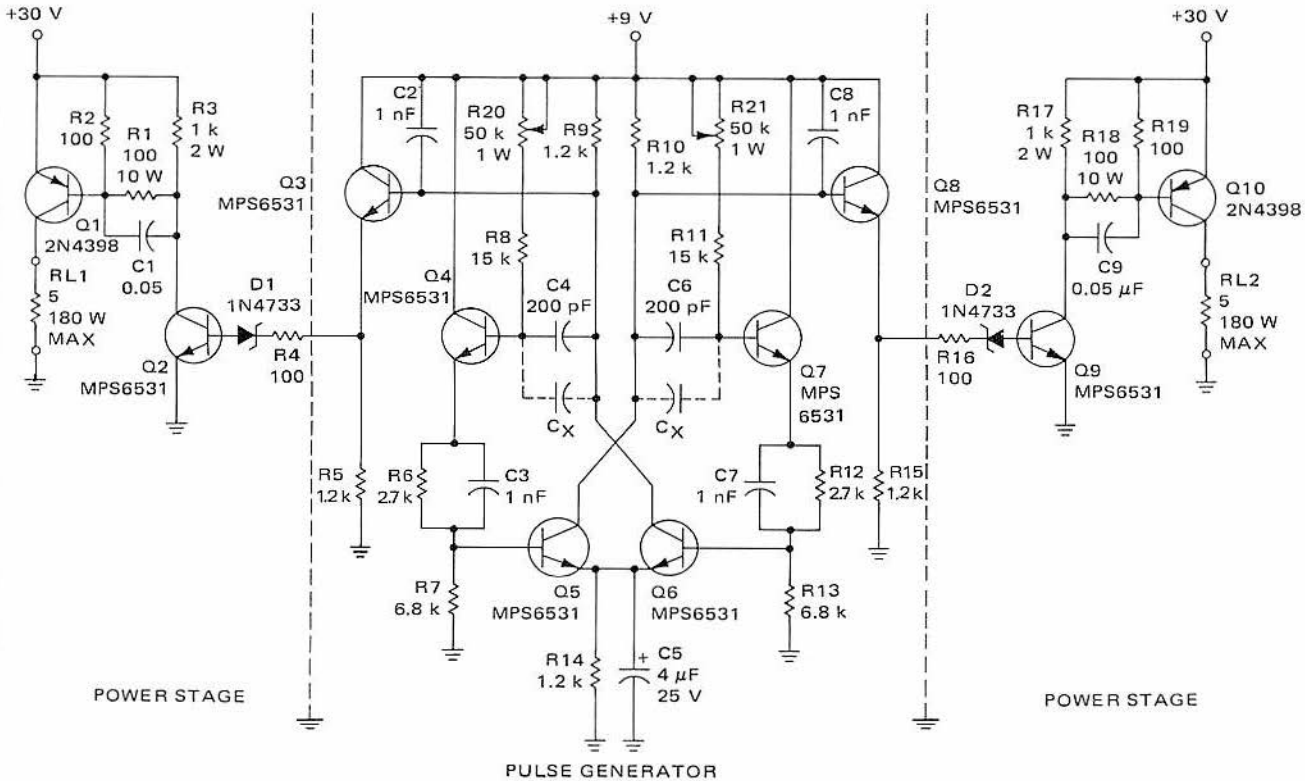
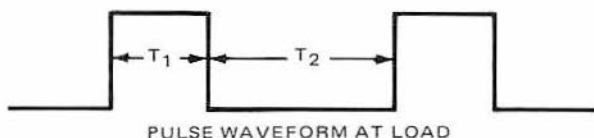

Figure 6-24 — Pulse Generator and Power Amplifier

R8, and for the "off" period are C6, R21, and R11. Emitter followers (Q4 and Q7) provide isolation and a current gain for driving Q5 and Q6. This arrangement permits a wide variation in the value of capacitors C4 and C6. Therefore, the timing of the multivibrator's periods can be made with single potentiometers and various values of capacitors. Table 6-II is a summary of the periods obtained for various values of C_X . The adjustment from minimum to maximum of each period is made with R10 and R21. The values of C_X shown in the table provide some overlapping of period timing so the minimum time setting of a range where C_X is the larger of two adjacent values is less than the maximum time setting of the range where C_X is the smaller of the two adjacent values.



CAPACITANCE	T1 (MIN)	T1 (MAX)	T2 (MIN)	T2 (MAX)
0 pF	5.6 μ s	23 μ s	5.9 μ s	27 μ s
750 pF	20.5 μ s	96 μ s	23.5 μ s	118 μ s
3.9 nF	86 μ s	430 μ s	94 μ s	490 μ s
0.017 μ f	420 μ s	1.9 ms	460 μ s	2.4 ms
0.10 μ f	1.8 ms	9.2 ms	2.3 ms	11.6 ms
0.50 μ f	8.6 ms	36.5 ms	9.4 ms	45.5 ms
1.5 μ f	30 ms	140 ms	34 ms	176 ms

Table 6-II. Value of C_X versus Pulse Period

The maximum pulse duration given in Table 6-II is 176 ms. The delay time is not limited to this value and can be increased by increasing the value of capacitor C_X .

The output for each side of the multivibrator is an emitter follower which provides a low output impedance. Capacitors C2 and C8 are required to prevent the emitter followers from oscillating when a low-impedance load is driven. The rise and fall times of the output pulse are affected by the value of C2 and C8, so these values may be optimized for any particular load used. A load impedance as low as 50 Ω may be driven with the values shown.

The power amplifier stages are duplicates of each other, so only one

will be described. The output will drive 6 A into a 5Ω load with a rise time of 100 ns and a fall time of about $2 \mu\text{s}$. Zener diode D1 blocks the quiescent output voltage of Q3 (approximately 4 volts) from turning on Q2. When the output of Q3 increases to approximately 8 volts, the zener conducts and turns on Q2. Since the zener has no turn on time, Q2 comes on as fast as its intrinsic properties permit. Capacitor C1 is discharged when Q2 comes on, so Q2 receives a large emitter-base current which turns it on fast. The rise time of the turn-on pulse is typically 100 ns. While Q1 and Q2 are on, C1 charges to the supply voltage. When Q2 is turned off, the voltage on C1 reverse-biases the base-emitter junction of Q1 and helps to turn it off. At a current of 6 amperes, Q1 will turn off with no base capacitor (C1) in about 5 ms. With a capacitor, this time is decreased in proportion to capacitance used. The $0.05 \mu\text{F}$ capacitor used brings the turn-off time to less than 2 ms. Faster turn-off times can be obtained by using larger values of capacitance for C1. However, the larger C1 is made, the larger the turn-on current becomes. Therefore, to prevent destruction of either Q1 or Q2, or both, a small resistor should be placed in series with C1. The value of the resistor is dependent upon the size of C1, the maximum rated collector current of Q2, and the maximum rated base current of Q1.

10 ns, 1 A Pulse Generator

Figure 6-25 is the circuit diagram of a pulse generator which is unique in that its output pulse can be positive, negative, or both (Figure 6-26). The positive and negative output levels can be varied from 0 to 10 volts maximum, thus giving a maximum output of 20 volts peak to peak. The generator has a maximum output capability of one ampere, both positive and negative. The output will drive a resistive load with a current greater than 10 mA, and rise and fall times of about 10 ns.

The operation of the circuit is as follows: The relaxation oscillator uses a unijunction transistor (Q1) in which R1 and R2 charge C1 until the emitter voltage reaches V_p , then C1 discharges through R3, forming a positive voltage spike. Consider the monostable multivibrator in its normal state; Q2 is cut off, Q3 is biased on through R6 and R7, and capacitor C3 is charged to approximately 12 volts (positive on the end tied to the collector of Q2). When the relaxation oscillator fires, the positive spike from Q1 is coupled through C2, turning on Q2. The voltage across C3 will then reverse-bias the base of Q3, turning it off. Q3 will remain off until C3 charges through R6 and R7 to the voltage across R5 plus the V_{BE} of Q3. With switch S1 in position one, the predriver transistors Q4 and Q5 are normally off. When Q3 turns off, current flows through R8 and R10,

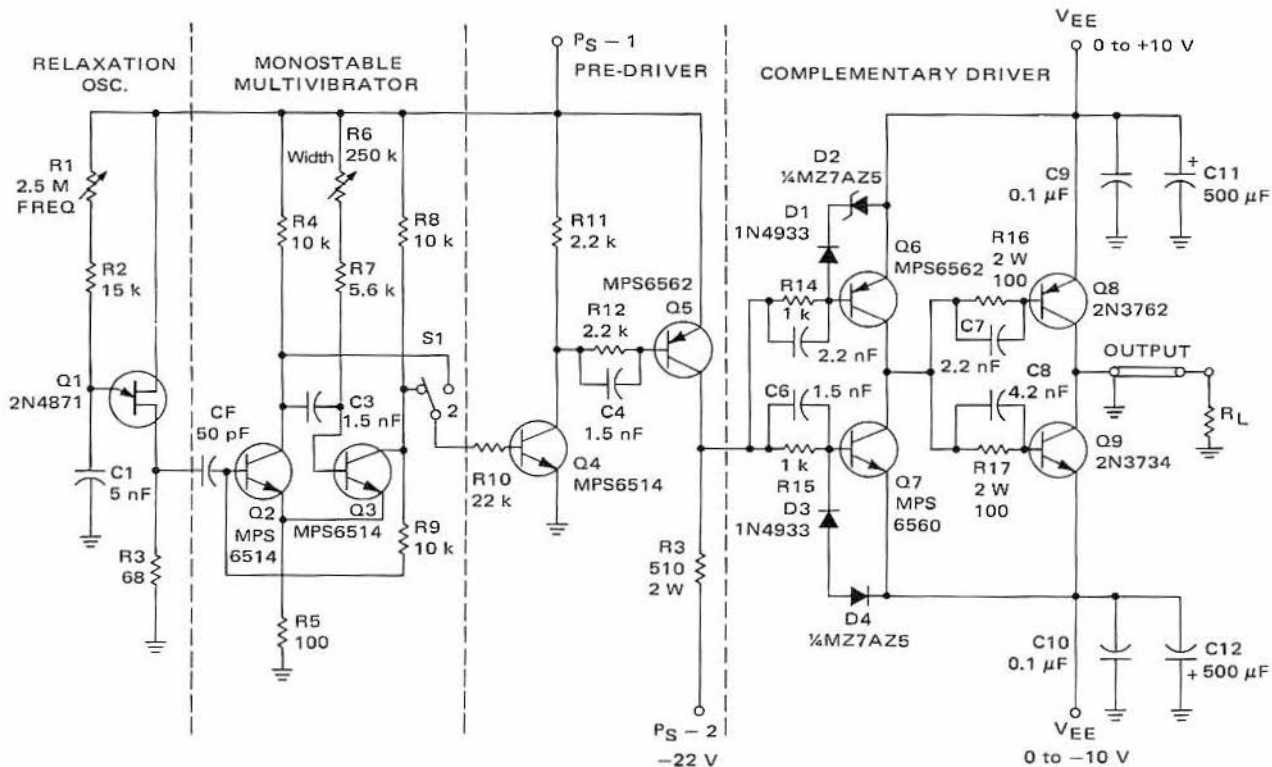

Figure 6-25 — Pulse Generator

turning on Q4 and Q5. A speed-up capacitor is not used across R10 because it will load the monostable multivibrator.

Consider Q5 normally off. Then Q6 of the complementary driver will be biased on through R13 and R14, which in turn will bias Q9 on through R17. The output at this time will be negative with respect to ground. When Q5 turns on, Q7 and Q8 will go on, and at the same time Q6 and Q9 will turn off, which moves the output through ground to a positive level. The zener diode and rectifier combination, D1 through D4, are used together so that I_{B2} for Q6 and Q7 is cut off about 2 volts below BV_{EBO} , which is 4 volts.

By varying resistors R1 and R6, the frequency and pulse width, respectively, can be changed. The frequency band of operation can be shifted by changing C1. The pulse-width band can be shifted by changing C3. The maximum frequency of this circuit is limited by the unijunction

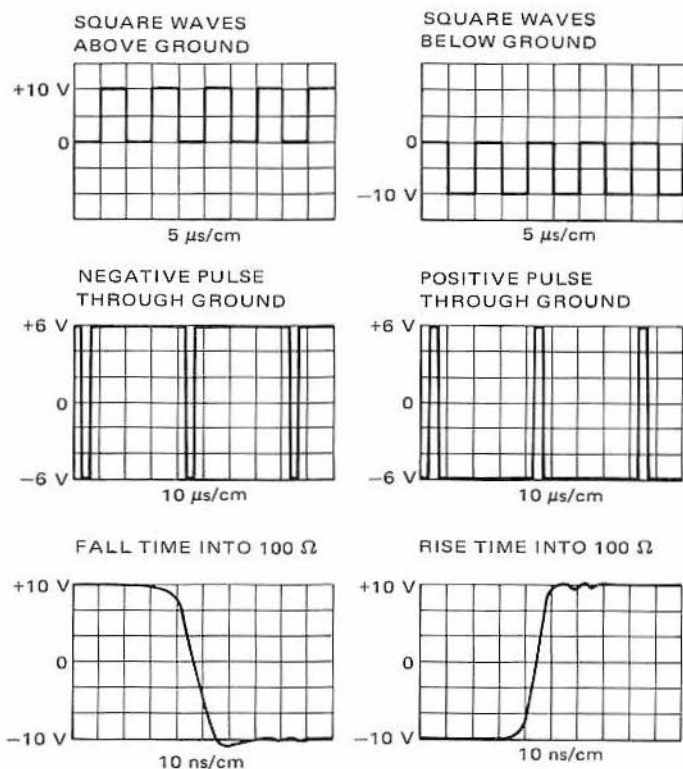

Figure 6-26 — Pulse Generator Output Waveforms into 100 Ω

oscillator to about 1 MHz. Switch S1 inverts the output pulse. There is about a 30% overlap in duty cycle between positions one and two with the values shown for C1 and C3. Good high frequency wiring techniques must be used to minimize ringing. The power supplies for the complementary driver must be very stiff, and the supply busses must be carefully bypassed at the transistors. The output level can be set by varying the positive and negative V_{EE} power supplies. For two-power-supply operation, $+V_{EE}$ and $-V_{EE}$ can be obtained from PS-1 and PS-2 through series-pass regulators.

6.8 Light Flashers

Simple 12 V, 1 W Light Flasher

The simple, inexpensive light flasher shown in Figure 6-27 has many advantages of more complex and expensive flasher circuits, such as flash-rate control, light-duration control, and high efficiency.

The circuit uses only two active devices: Q1, a unijunction transistor, and Q2, an NPN silicon switching transistor. Flash rate may be varied from 6 to 120 flashes per minute and light on duration from 40 ms to 0.5 seconds.

The circuit functions as follows: The firing (flash) rate of Q1 is determined by R1, R2 and C1, R1 being the flash-rate control. When the charge on C1 exceeds the firing level of Q1, it discharges through the emitter into base one of Q1, and the rate of discharge from Q1 to Q2 is

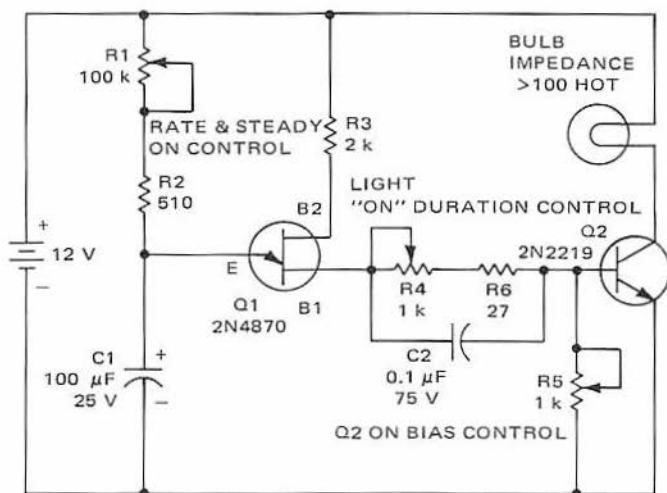

Figure 6-27 — 12 Volt 1 Watt Light Flasher

determined by R4 and C2. R5 sets the on-bias threshold of Q2 and also serves as part of the on-duration control composed of R4, R5 and C2. The high efficiency comes from a low off-state current of less than 2 mA when compared to the on-state saturation current of Q2 of approximately 100 mA.

High-Stability Flasher with Variable Flash Rate

The reliable, high-power flasher shown in Figure 6-28 is excellent for a boat, aircraft, or emergency vehicle. It is a dependable circuit with built-in protection against troublesome transients, and provision for changing the on-time duty cycle of the lamp.

Basically, the circuit is similar to many other SCR flasher circuits which make use of the familiar flip-flop. However, there are two important differences. In this circuit provision is made to guarantee that both SCRs can never come on at the same time, thus preventing latch-up of the circuit. Also, an adjustment is provided to allow the on time of the lamp to be varied from 50% duty cycle to 10% duty cycle. In the basic flip-flop, SCRs Q2 and Q3 are alternately turned on by unijunction transistor Q1 and commutated off by capacitor C1.

With only the basic circuit, a voltage transient, a momentary load short circuit, or some other disturbance could cause both SCRs to turn on at the same time. When this occurs, the circuit ceases to operate and it

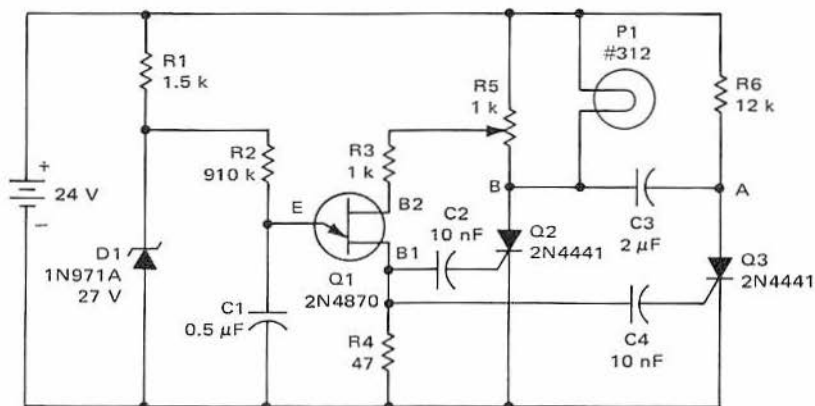

Figure 6-28 — High-Stability Flasher

cannot resume operation until the supply voltage is interrupted momentarily. In this circuit, however, resistor R6 is made large enough that the current which it supplies to Q3 is always less than the holding current. Therefore, Q3 can never remain in conduction. This improvement also eliminates the need for an elaborate starting circuit. Being able to vary the on-time duty cycle of the lamp improves the efficiency of this flasher considerably. A 30% duty cycle not only has been proven to be much easier to see than a 50% duty cycle but also realizes a 40% savings in overall power dissipated.

The circuit operates as follows: The unijunction transistor (Q1) operates as a stable relaxation oscillator which produces trigger pulses for both SCRs. The rate of oscillation varies between flashes in the following manner: When the lamp (P1) is off, the voltage at base two of Q1 is approximately equal to the supply voltage. This means that C2 must charge to the supply voltage times the intrinsic standoff ratio (η) of Q1 before Q1 will fire. When the lamp (P1) is on, however, and the voltage on the wiper of R5 is, let us say, one-half the supply voltage, then capacitor (C1) must only charge to one-half the supply voltage times the η of Q1 before Q1 fires. Since the capacitor is being charged from the full supply voltage, this time will be much shorter, therefore the lamp will stay on a much shorter period of time than it will stay off.

At the start of operation, both SCRs attempt to turn on. Q3 cannot turn on because its anode current is limited by R6 and it never reaches the holding current level. With Q2 in conduction, point B is reduced to a voltage level which is above ground by an amount equal to the forward drop of Q2. C3 charges through R6 with point A rising to the supply voltage. When the next trigger pulse occurs, Q3 can turn on since it is supplied with anode current by C3. With Q3 in conduction, Q2 is effectively reverse-biased by C3, which causes it to turn off. The load current is supported by C3 for a few microseconds during the turn off interval of Q2. Q3 continues to remain in conduction as C3 charges through the lamp with point B rising to the supply voltage. When the sum of the charging current of C3 and the current through R6 drops to a value below the holding current of Q3, Q3 drops out of conduction. C3 then discharges through R6 and the lamp at a low current level. When the next trigger pulse arrives, the cycle is repeated.

Note that when Q3 discharges C3 to turn off Q2, Q2 is also being supplied with a turn-on trigger pulse. The trigger pulse must be kept short in duration in comparison with the turn-off pulse supplied by C3, to insure that Q2 will turn off. If for some reason Q2 should fail to turn off as intended, C3 will recharge with point A positive with respect to point B, and thus turn-off pulses will be supplied until it does turn off. Likewise, if

one of the SCRs should fail to turn on, turn-on pulses will continue to be applied until it does turn on. Since the firing voltage of the unijunction transistor is relatively insensitive to changes in base voltage, the repetition rate of the trigger pulses are not appreciably affected by voltage changes.

The resistor (R3) in series with base two reduces the effects of temperature changes, and thus the repetition rate is relatively insensitive to temperature changes.

If severe transients are encountered, it is recommended that resistor R1 and zener diode D1 be added to protect the unijunction transistor.

6.9 Relay Drivers

Electronic control of either ac or dc relays is possible through the use of a transistor placed in series with the coil of the relay. This must be done through a bridge when an ac relay is used. Figure 6-29 is the schematic of a dc relay that can be controlled by an electronic signal which can supply a current of 1/2 mA. The relay coil is the load for transistor Q1. When a positive control voltage is applied to R1, Q1 receives base drive and saturates, thus connecting the relay coil to the supply voltage. R1 must allow enough base current to saturate Q1. For the components shown, the 1/2 mA of base current will assure this since the relay requires 5 mA and the transistor has a minimum gain of 55. When the control voltage drops to zero, the transistor turns off, de-energizing the relay. Since the relay coil is inductive, a voltage spike could occur at the collector of Q1; to prevent damage, a protective circuit for the transistor should be included. The diode (D1) across the relay coil does this; it clamps the collector voltage to the supply voltage by providing a path for the current in the relay coil when the transistor turns off.

A modification of this relay circuit is shown in Figure 6-30. In this case, the control of the relay is provided by light. When sufficient light is directed at Q1, it turns on. This drives Q2 which energizes the relay coil as

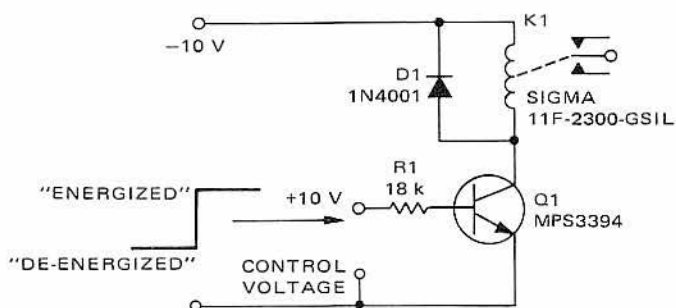

Figure 6-29 — Electronic Control of a DC Relay

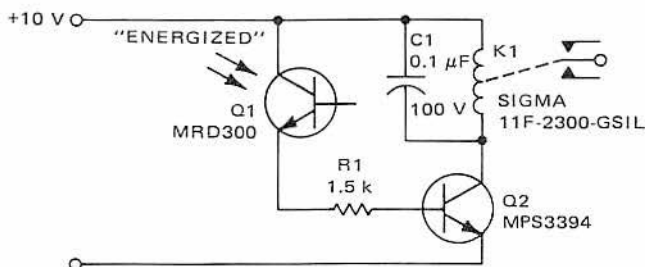

Figure 6-30 — Light-Operated Relay

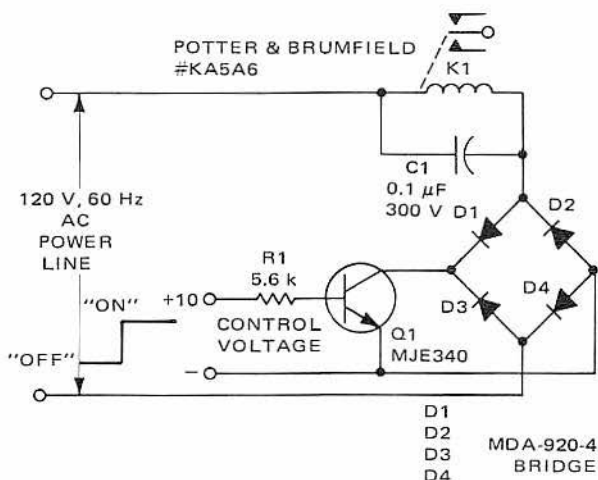

Figure 6-31 — Electronic Control of an AC Relay

in the previous circuit. A light magnitude of 220 foot-candles was enough to drive relay driver Q2 to saturation. When light is removed from Q1, base drive is removed from Q2, and Q2 turns off. In this circuit, Q2 turns off slightly more slowly than in the previous circuit, therefore a small capacitor (C1) across the relay is adequate to limit the maximum voltage spike to below the breakdown level of Q2.

The circuit shown in Figure 6-31 can be used to control an ac-operated relay. The bridge consisting of D1, D2, D3 and D4 provides dc to the transistor while the relay sees an ac voltage. When a dc control voltage is applied to R1, Q1 saturates and energizes the relay coil. As before, adequate base current must be provided to saturate Q1. A disadvantage of this circuit is that the control signal must be isolated from the power line. The prime advantage is, of course, that an ac relay can be controlled by a

single transistor. A forced gain of 10 guarantees that Q1 will be saturated, therefore the base current of 1.6 mA will drive a relay coil requiring 16 mA. In this circuit, protection against voltage spikes must also be provided for the transistor when it is turned off. Capacitor C1 across the relay coil provides such protection.

6.10 Power Supply Monitors

The circuit shown in Figure 6-32 provides a visual indication of momentary interruptions of a power source. The circuit operates as follows: the push-button switch momentarily applies power to the gate of SCR Q1, which will turn it on and clamp the voltage across the lamp to the forward voltage drop of the SCR. This voltage (about 1 volt) is not enough to light the lamp. As long as power is present the SCR will be on and the lamp will be off. If there is a momentary interruption of the power for a time which is greater than the recovery time of the SCR (no greater than $50 \mu\text{s}$ at 240 mA), then the SCR will turn off and remain off. When power service is resumed, the lamp will light indicating that the service had been interrupted. Resistor R2 clamps the gate of the sensitive-gate SCR and prevents spurious signals from firing the SCR. The only way to extinguish the lamp when power is applied is to close the start switch, thus the lamp will glow until noticed. Then the circuit can be reset manually. This circuit will only indicate momentary power failures.

Should an indication of either momentary or continuous power failure be required then the circuit shown in Figure 6-33 can be used.

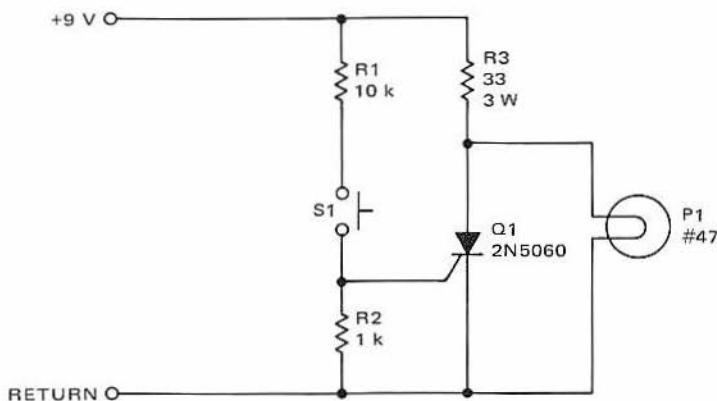

Figure 6-32 — Interrupted-Power Indicator

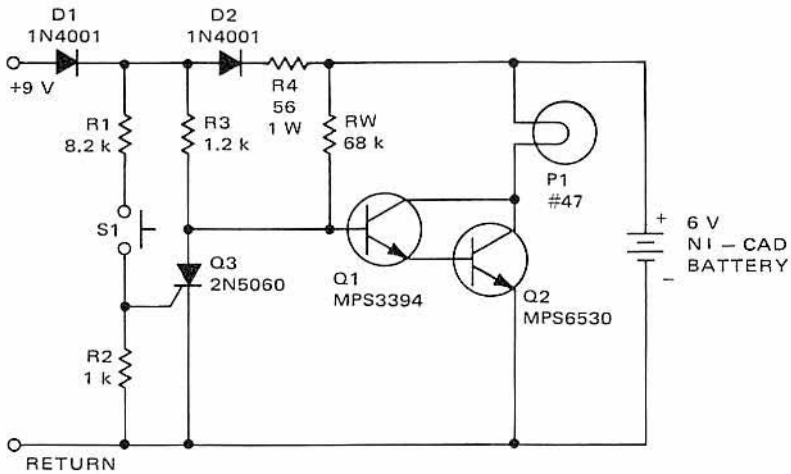

Figure 6-33 — Power-Failure Indicator

When the push-button switch is closed, SCR Q3 turns on and holds the base voltage of Q1 below the value required to turn it on. Resistor R3 is used to provide holding current to SCR Q3. The SCR will stay on as long as power is applied to the circuit. If the power fails either as an open or a short, Q3 will turn off since diode D2 prevents the battery from providing holding current through R3, and the current through R5 is less than the holding current. If the power source fails as a short, then diode D1 prevents the current through R5 from bypassing the base of Q1 through resistor R3 and the shorted supply. This guarantees that Q1 and Q2 will turn on, thus lighting the lamp with current supplied by the battery. If the power should come back on, the SCR will remain off and the lamp will remain lit. This circuit will also indicate momentary power failures if the duration of the failure is greater than the recovery time of the SCR. This time is approximately $5 \mu\text{s}$ when the current is about 7 mA. When the circuit is reset, the supply will trickle-charge the battery, thus keeping it at full charge.

6.11 Battery-Charger Control Circuit

The foolproof battery-charger control circuit shown in Figure 6-34 protects a battery being charged from overcharging or reverse charging. It will also protect itself and/or a separate charging supply from short-circuit damage.

The power transformer and full-wave bridge rectifier can supply approximately 16 A of charging current to the battery.

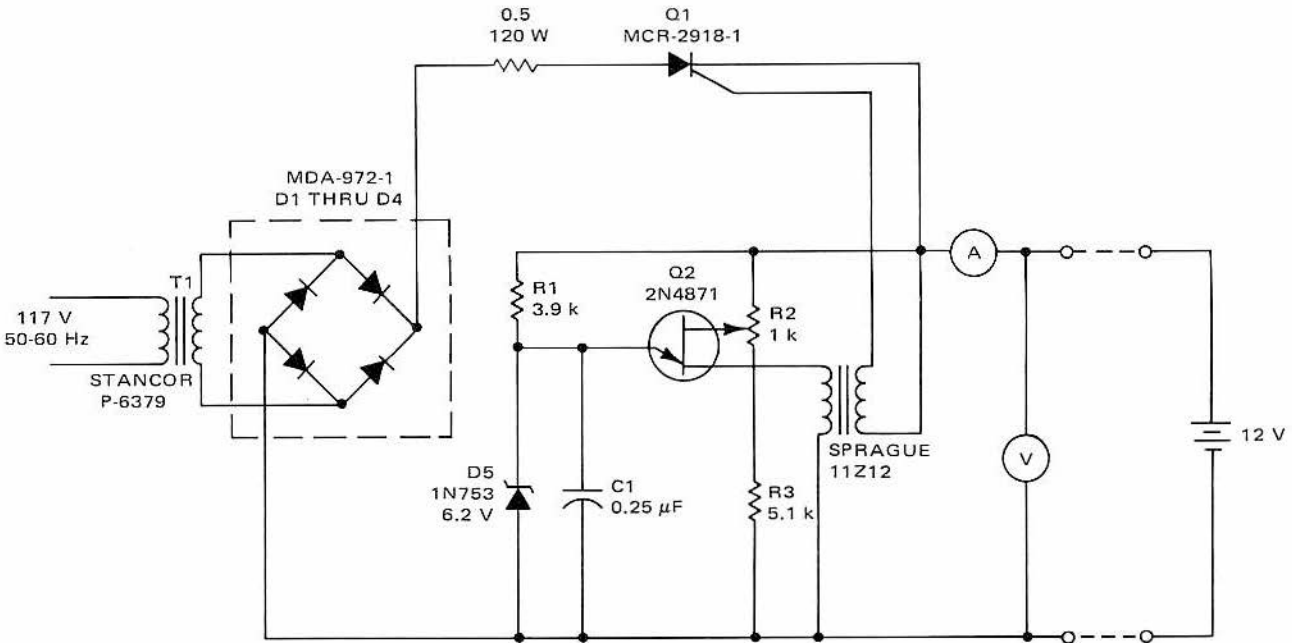

Figure 6-34 — 12 Volt Battery-Charger Control

The unijunction transistor (Q2), R1, R2, R3 and C1 form a relaxation oscillator which is used to trigger SCR Q1 through transformer T2. Power for operation of the relaxation oscillator is obtained from the output which is connected to the battery. The interbase voltage, V_{B2B1} , of the unijunction is therefore determined by the battery voltage. Because the firing voltage of the unijunction is a function of the interbase voltage, as the battery charges and its terminal voltage increases, the firing voltage also increases. The zener diode (D5) limits the voltage to which the emitter of the unijunction can rise. When the required firing voltage of the unijunction as determined by the battery voltage exceeds the breakdown voltage of D5, the unijunction can no longer oscillate. It therefore cannot trigger SCR Q1 and the charging ceases. This voltage cutoff point is controlled by the setting of R2.

The unijunction cannot oscillate unless a positive voltage less than the cutoff setting is present at the output terminals. Therefore, the SCR cannot conduct under conditions of a short circuit, an open circuit, or a reversed polarity connection to the battery.

The trigger transformer specified functions satisfactorily, but its design is not critical. The basic requirements are that its series impedance be low, and that it must be capable of passing a pulse with a width of a few microseconds.

6.12 Remote Strobeflash Slave Adapter

At times when using an electronic strobe flash it is desirable to use a remote, or "slave" flash synchronized with the master. The circuit in Figure 6-35 provides the drive needed to trigger a slave unit, and eliminates the necessity for synchronizing wires between the two flash units.

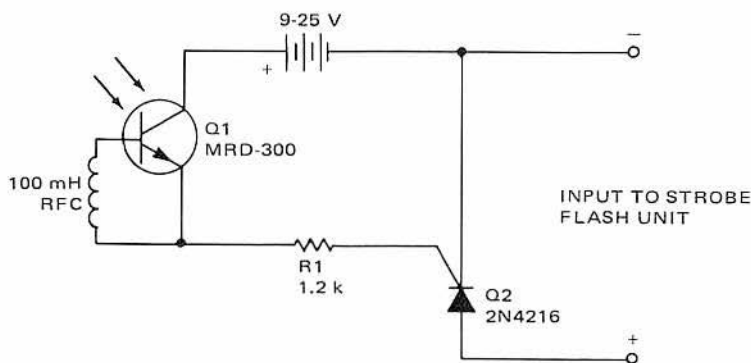

Figure 6-35 — Strobeflash Slave Adapter

The MRD-300 phototransistor used in this circuit is cut off in a V_{CER} mode due to the relatively low dc resistance of rf choke L1 even under high ambient light conditions. When a fast-rising pulse of light strikes the base region of this device, however, L1 acts as a very high impedance to the ramp and the transistor is biased into conduction by the incoming pulse of light.

When the MRD-300 conducts, a signal is applied to the gate of SCR Q2. This triggers Q2, which acts as a solid-state relay and turns on the attached strobe-flash unit.

In tests this unit was unaffected by ambient light conditions. It fired up to approximately 20 feet from strobelight flashes using only the lens of the MRD-300 phototransistor for light pickup. This distance could be greatly increased if a lens or parabolic reflector were used to concentrate light into the phototransistor.

BIBLIOGRAPHY FOR CHAPTER 6

1. Bergersen, Thor, "Unijunction Transistor Timers and Oscillators," Motorola AN-294.
2. Brookmire, James L; "Zero-Voltage Switching for Proportional Temperature Control," *EEE*, April 67.
3. Buchanan, John K.; "A Modulated SCR Zero-Point Switching Circuit" Motorola AN-242.
4. Wechsler, Reuben, "A Unique Battery Charger Control Circuit" Motorola
5. Wechsler, Reuben, "Designing SCR Circuits for High Inrush Loads" Motorola AN-170.
6. Wechsler, Reuben, "Reducing (di/dt)-Effect Failures in SCR's" Motorola AN-173.
7. Zinder, David A., "SCR Power Control Fundamentals," Motorola AN-240.
8. Zinder, David A., "Thyristor Trigger Circuits for Power-Control Applications," Motorola AN-227.