

tup-tun-dug-dus

Wherever possible in Elektor circuits, transistors and diodes are simply marked 'TUP', 'TUN', 'DUG' or 'DUS'. This indicates that a large group of similar devices can be used without detriment to the performance of the circuit.

As far as possible, the circuits in Elektor are designed so that they can be built with standard components that most retailers will have in stock.

It is well-known that there are many general purpose diodes and low frequency transistors with different type numbers but very similar technical specifications. The difference between the various types is often little more than their shape. This family of semiconductors is referred to in the various articles by the following abbreviations:

TUP = Transistor, Universal PNP,
TUN = Transistor, Universal NPN,
DUG = Diode, Universal Germanium,

DUS = Diode, Universal Silicon.
TUP, TUN, DUG and DUS have to meet certain minimum specifications — they are not just 'any old transistor' or 'any old germanium diode'. . . . The minimum specifications are listed in tables 1a and 1b. It is always possible, of course, to use a transistor with better specifications than those listed!

Specifications and equivalents

A number of transistor types that meet the TUN specifications are listed in table 2. This list is, of course, incomplete — there are many more possible types.

Table 3 lists a number of possibilities for use as TUP, while table 4 gives equivalents for DUG and DUS.

A further group of better quality transistors are the BC107 - BC108 - BC109 (NPN) and BC177 - BC178 - BC179 (PNP) families. The minimum specifications are listed in table 5, while table 6 gives a list of equivalents. As will be obvious from the specifications, the main differences between the types are that the BC107/BC177 are higher voltage types ($V_{ce0} = 45$ volts) and the BC 109/BC179 are low-noise. If these differences are not important in a particular circuit, the various types are interchangeable.

The code letters A, B or C after the type number on these transistors denote various current amplification factors. For the A-types this is from 125 to 260, for the B-types it is 240 to 500 and for the C-types 450 to 900. A BC109C is therefore not a direct equivalent for a BC109B, for instance, although in many practical circuits it will make little or no difference.

When using the equivalent types BC167, -168, -169, BC257, -258, -259 or BC467, -468, -469 it should be noted that the base, emitter and collector leads are in a different order (see table 6).

elektor shorthand

From various enquiries it has become clear that some of our readers feel that they have been plunged in at the deep end. Elektor's 'shorthand' style of symbols and conventions seems to have led to some confusion, in spite of our efforts to the contrary, so some further explanation seems to be called for.

Resistor and capacitor codes

When giving the values of resistors and capacitors, decimal points and large numbers of zeros are avoided as far as possible. To this end, extensive use is made of the international abbreviations:

p (pico-) = 10^{-12} = one millionth of one millionth;
n (nano-) = 10^{-9} = one thousandth of one millionth;
 μ (micro-) = 10^{-6} = one millionth;
m (milli-) = 10^{-3} = one thousandth;
E = 10^0 = unity;
k (kilo-) = 10^3 = one thousand times;
M (mega-) = 10^6 = one million times;
G (giga-) = 10^9 = one thousand million times;

Furthermore, the symbols Ω (ohm) and F (farad) are usually omitted, since it is normal practice to state resistance values in ohms and capacitance values in farads. Finally, the decimal point is usually replaced by one of the abbreviations (p, n, μ . . .) listed above (This has also been accepted practice for some years).

A few examples may serve to clarify all this:

Resistance value 2k7: this is 2.7 k Ω , or 2700 Ω .
Resistance value 470: this is 470 Ω .
Resistance value 3M9: this is 3.9 M Ω , or 3,900,000 Ω .
Capacitance value 4p7: this is 4.7 pF, or 0.000 000 000 004 7 F . . .
Capacitance value 100 μ : this is 100 μ F.
Capacitance value 4700 μ : this is

4700 μ F, and could have been written as 4m7 — but never is.

Capacitance value 10 n: this is 10 nF, and is also sometimes written (but not in elektor!) as 10,000 pF or 0.01 μ F; or even as 10 kpF (10 kilo-pico-Farad), which is a horrible confusion of symbols. In the same way one sometimes finds $\mu\mu$ F (micro-micro-Farad) instead of pF.

Semiconductor type numbers

Very often, a large number of equivalent types for one integrated circuit exist with different type numbers. On closer examination, a group of digits are often found to be identical, but they are pre- or suffixed with letters and digits which denote the manufacturer. As an example, a popular op-amp is variously denoted as μ A741, LM741, L741, MC1741, MIC741, RM741, SN72741 or ZLD741, to name a few. To cut through this confusion, this IC is referred to in elektor as a '741' — which means that we couldn't care less who makes it, provided it meets the specifications. . .

TUP TUN DUG DUS

	type	U_{ce0} max	I_c max	h_{fe} min.	P_{tot} max	f_T min.
TUN	NPN	20 V	100 mA	100	100 mW	100 MHz
TUP	PNP	20 V	100 mA	100	100 mW	100 MHz

Table 1a. Minimum specifications for TUP and TUN.

Table 1b. Minimum specifications for DUS and DUG.

	type	U_R max	I_F max	I_R max	P_{tot} max	C_D max
DUS	Si	25 V	100 mA	1 μ A	250 mW	5 pF
DUG	Ge	20 V	35 mA	100 μ A	250 mW	10 pF

Table 2. Various transistor types that meet the TUN specifications.

TUN		
BC 107	BC 208	BC 384
BC 108	BC 209	BC 407
BC 109	BC 237	BC 408
BC 147	BC 238	BC 409
BC 148	BC 239	BC 413
BC 149	BC 317	BC 414
BC 171	BC 318	BC 547
BC 172	BC 319	BC 548
BC 173	BC 347	BC 549
BC 182	BC 348	BC 582
BC 183	BC 349	BC 583
BC 184	BC 382	BC 584
BC 207	BC 383	

Table 3. Various transistor types that meet the TUP specifications.

TUP		
BC 157	BC 253	BC 352
BC 158	BC 261	BC 415
BC 177	BC 262	BC 416
BC 178	BC 263	BC 417
BC 204	BC 307	BC 418
BC 205	BC 308	BC 419
BC 206	BC 309	BC 512
BC 212	BC 320	BC 513
BC 213	BC 321	BC 514
BC 214	BC 322	BC 557
BC 251	BC 350	BC 558
BC 252	BC 351	BC 559

Table 4. Various diodes that meet the DUS or DUG specifications.

DUS		DUG
BA 127	BA 318	OA 85
BA 217	BAX 13	OA 91
BA 218	BAY 61	OA 95
BA 221	1N914	AA 116
BA 222	1N4148	
BA 317		

Table 5. Minimum specifications for the BC107, -108, -109 and BC177, -178, -179 families (according to the Pro-Electron standard). Note that the BC179 does not necessarily meet the TUP specification ($I_{c,max} = 50$ mA).

	NPN	PNP
	BC 107 BC 108 BC 109	BC 177 BC 178 BC 179
V_{ce0} max	45 V 20 V 20 V	45 V 25 V 20 V
V_{eb0} max	6 V 5 V 5 V	5 V 5 V 5 V
I_c max	100 mA 100 mA 100 mA	100 mA 100 mA 50 mA
$P_{tot.}$ max	300 mW 300 mW 300 mW	300 mW 300 mW 300 mW
f_T min.	150 MHz 150 MHz 150 MHz	130 MHz 130 MHz 130 MHz
F max	10 dB 10 dB 4 dB	10 dB 10 dB 4 dB

The letters after the type number denote the current gain:

- A: $a' (\beta, h_{fe}) = 125-260$
- B: $a' = 240-500$
- C: $a' = 450-900$.

Table 6. Various equivalents for the BC107, -108, . . . families. The data are those given by the Pro-Electron standard; individual manufacturers will sometimes give better specifications for their own products.

NPN	PNP	Case	Remarks
BC 107 BC 108 BC 109	BC 177 BC 178 BC 179		
BC 147 BC 148 BC 149	BC 157 BC 158 BC 159		$P_{max} = 250$ mW
BC 207 BC 208 BC 209	BC 204 BC 205 BC 206		
BC 237 BC 238 BC 239	BC 307 BC 308 BC 309		
BC 317 BC 318 BC 319	BC 320 BC 321 BC 322		$I_{c,max} = 150$ mA
BC 347 BC 348 BC 349	BC 350 BC 351 BC 352		
BC 407 BC 408 BC 409	BC 417 BC 418 BC 419		$P_{max} = 250$ mW
BC 547 BC 548 BC 549	BC 557 BC 558 BC 559		$P_{max} = 500$ mW
BC 167 BC 168 BC 169	BC 257 BC 258 BC 259		169/259 $I_{c,max} = 50$ mA
BC 171 BC 172 BC 173	BC 251 BC 252 BC 253		251 . . . 253 low noise
BC 182 BC 183 BC 184	BC 212 BC 213 BC 214		$I_{c,max} = 200$ mA
BC 582 BC 583 BC 584	BC 512 BC 513 BC 514		$I_{c,max} = 200$ mA
BC 414 BC 414 BC 414	BC 416 BC 416 BC 416		low noise
BC 413 BC 413	BC 415 BC 415		low noise
BC 382 BC 383 BC 384			
BC 437 BC 438 BC 439			$P_{max} = 220$ mW
BC 467 BC 468 BC 469			$P_{max} = 220$ mW
	BC 261 BC 262 BC 263		low noise

TUP TUN DUG DUS

tup tun tester

This tester gives an instant check of the 'general health' of a transistor, as well as its compliance with the minimum TUP or TUN specification, by the very simple procedure of plugging it into test sockets and interpreting the messages from two light-emitting diodes. It is also possible to check diodes for excessive capacity or leakage.

The principle of operation is simple and no preliminary calibration is needed — only the use of transistors and diodes known to be 'good' and resistors within the specified tolerance.

An astable multivibrator generates a square wave at a frequency of about 2 kHz, and this oscillation is turned on and off by another multivibrator at about 2 Hz. The collector-emitter path of the transistor under test (or the anode-cathode path of the diode) is connected in series with another transistor across the supply rails, and the inter-

mittent 2 kHz square wave is fed in anti-phase to the bases of each of the two transistors. Figure 1 shows a block diagram of the arrangement, from which a lot of information about the semiconductor under test can be deduced from the 'behaviour', voltage-wise, of the junction between the two semiconductors. This information can be displayed with the aid of only two light-emitting diodes (LEDs).

Circuit Description

Figure 2 shows the complete circuit,

which has been divided into three sections to avoid confusion. Transistors T5 and T6 in figure 2a form an astable multivibrator which runs at about 2 kHz. T2 and T3 form another multivibrator which runs at a much lower speed, about 2 Hz, and turns the 'fast' (2 kHz) oscillator on and off through transistor T4, which also supplies a 2 Hz switching waveform, via connection 'Q', to the display section T7 ... T9 and LEDs 'A' and 'B' (figure 2c). A similar 2 Hz switching waveform, in antiphase to the one which appears at 'Q', is supplied to the display section by T1 via 'P'. As will be seen later, these switching waveforms are needed to enable an unambiguous display to be obtained from two LEDs only.

An optional third LED (shown in the circuit as LED 'C') can be connected in series with the 680 Ω resistor R9 between 'Q' and supply negative. This will give a partial test of the tester itself by blinking in step with the slow oscillator if this is functioning.

2 kHz square waves of equal amplitude and opposite polarity are produced intermittently at the collectors of T5 and T6. These two points, which drive the whole of the test circuitry, are marked 'X' and 'Y' respectively. When the fast oscillator is turned off, T5 is cut off and its collector ('X') is at its higher potential.

The left-hand half of figure 2b is the section in which PNP-transistors are tested. It has been shown that 2 kHz square waves of equal amplitude and opposite polarity are being injected intermittently at 'X' and 'Y'.

Display

Assume that a (good) PNP transistor is plugged in at the test point T_A in figure 2b. When the fast oscillator is off, 'X' is positive and 'Y' is negative. (The terms 'positive' and 'negative' are used to denote the higher and lower potentials taken up by various points in the circuit). Both the transistor T10 and the transistor T_A under test are therefore cut off, and the connection joining the collectors of T10 and T_A is floating. The diode D10 does not pass any current and the Darlington pair T11 and T12 is cut off. Figures 2b and 2c show that the collector of T12 is one of the points connected to the base of T9 (point A). When T12 is cut off, 'A' is positive and T9 is therefore also cut off. LED 'B', which is in the collector lead of T9, is therefore off, and the collector of T9 is negative.

To find what LED 'A' is doing, the other switching waveforms, derived from the slow oscillator via 'P' and 'Q', must now be examined. To switch the fast oscillator off, 'Q' must be negative; therefore 'P' is positive. T7 is connected to 'P', so T7 can conduct if its base receives a positive drive from the collector of T9 via R19.

In the situation now under consideration, however, the collector of T9 is negative and T7 does not pass current. T8 is also returned to the negative rail through LED 'A', but 'Q' is negative so LED 'A' stays off.

Recapping at this stage; with a good

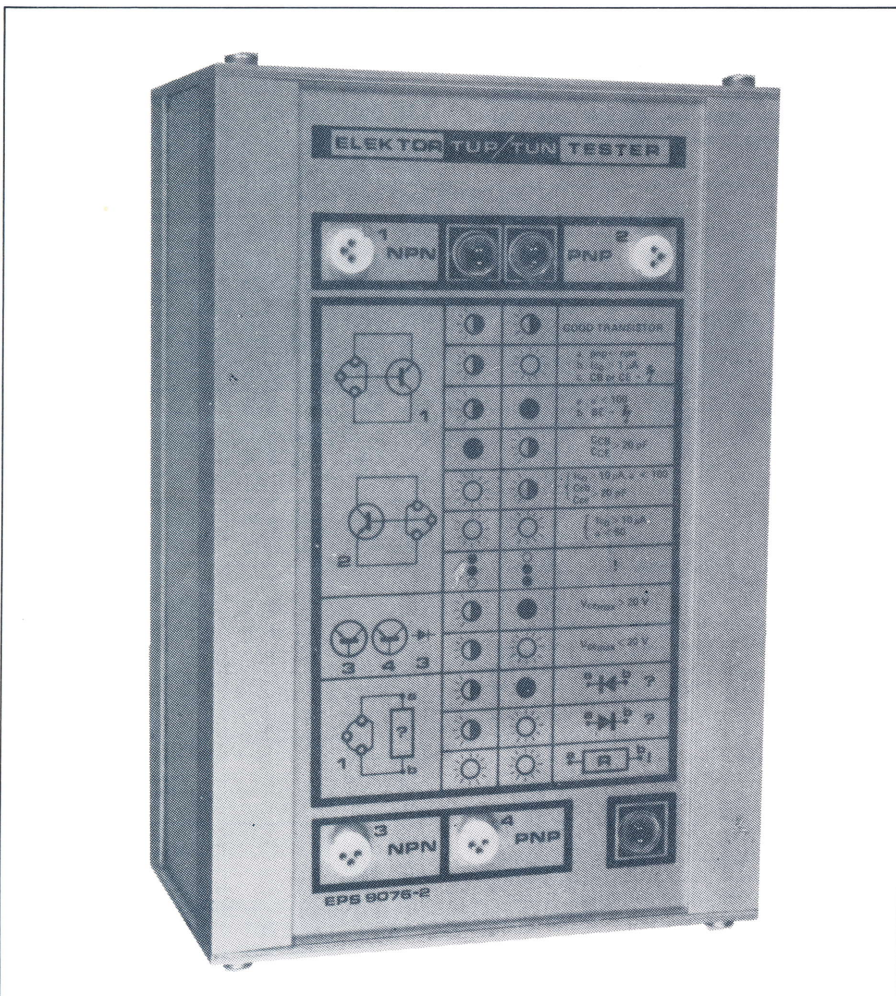

transistor and when the fast oscillator is turned off, both LEDs are off.

It has been seen that the three points which determine the LED display are 'A', 'P' and 'Q'. The basic relationship is as follows:

1. When 'P' is positive (i.e. the fast oscillator is turned off), LED 'A' will light up if the base of NPN transistor T7 is driven positively from the collector of T9.
2. When 'Q' is positive (i.e. the fast oscillator is turned on), LED 'A' will light up if the base of PNP transistor T8 is driven negatively from the collector of T9.
3. LED 'B' lights up when the collector of T9 is positive, irrespective of whether 'P' or 'Q' is positive.
4. When 'A' is negative, the collector of T9 is positive.

These relationships can be combined in a kind of truth table which will help in predicting the display for transistors or diodes in different states of health. They are also summarised, in a slightly different form, in figure 3a + b.

FAST OSCILLATOR TURNED	'A' SWINGS	LED A	LED B
Off	positive	Off	Off
Off	negative	On	On
On	positive	On	Off
On	negative	Off	On

What happens during the bursts when the fast oscillator is turned on?

'X' and 'Y' are being swung alternately positive and negative with opposite polarities at 2 kHz. When 'X' swings positive and 'Y' swings negative, the same reasoning which was applied to the situation when the fast oscillator is turned off will indicate that 'A' swings positive and LED 'B' is off. In this case, however, the fast oscillator is turned on ('Q' is therefore positive) and LED 'A' lights up.

When 'X' swings negative and 'Y' swings positive, it will be seen from figure 2b that both T10 and the transistor under test in T_A are turned on. The emitter of T_A is directly connected to supply positive, while the emitter of T10 is connected to supply negative through the 470 Ω resistor R28. If the current gain of T_A is high enough, the potential at the collector of T_A will move positively, D10 will conduct and the base of T11 will also move positively. (This will be discussed in more detail later.) The emitter of T12, the other transistor in the Darlington pair, is held by R30 and R31 at half the supply rail potential, so T12 is turned on; its collector potential (point 'A') swings negative and, as can be seen from the table, LED 'B' lights up and LED 'A' is off.

So the LED display while the fast oscillator is turned on and the transistor is a 'good' one is that 'A' and 'B' each come on during alternate half-cycles of the 2 kHz oscillation. Both LEDs therefore appear to be on during each 2 kHz burst, and it has already been seen that both are off while the fast oscillation is turned off.

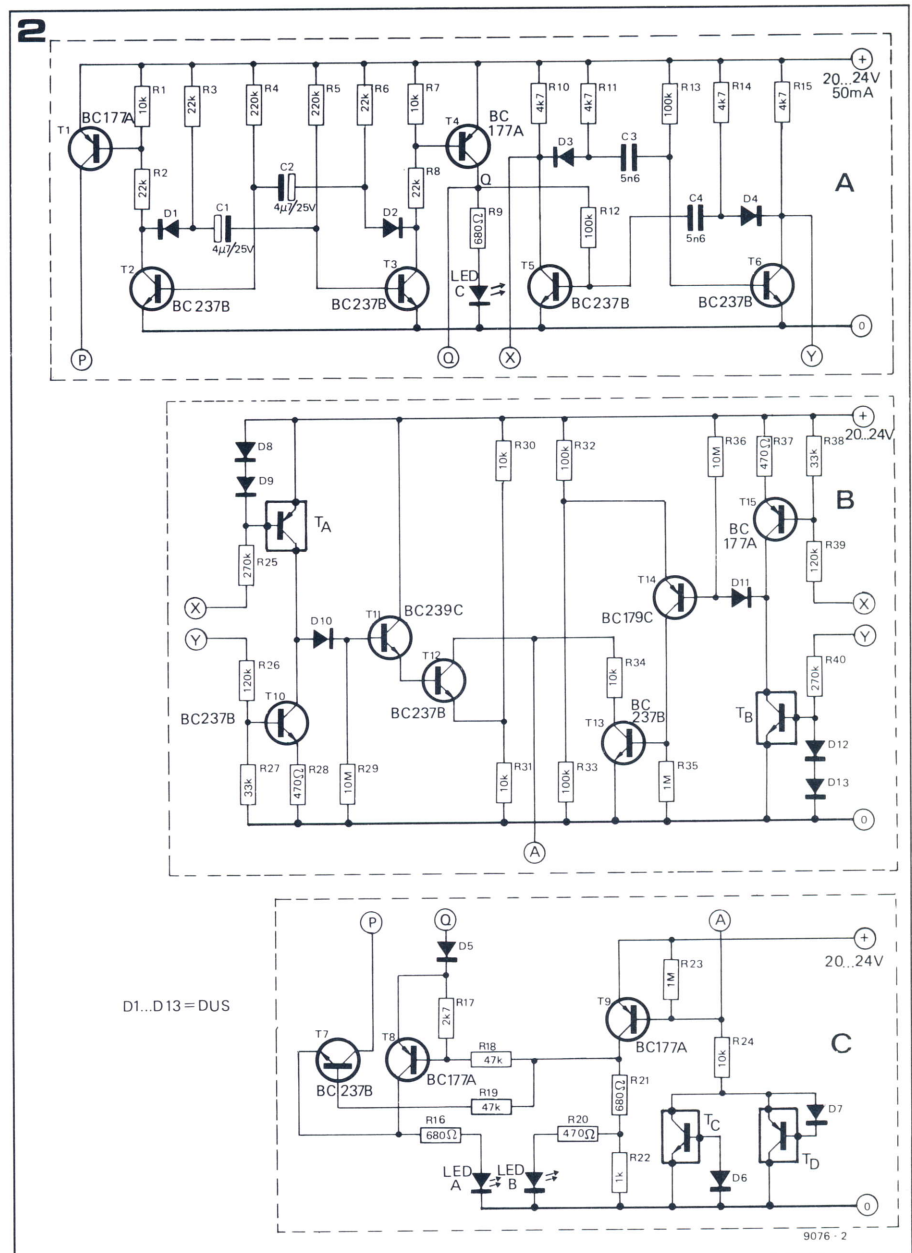
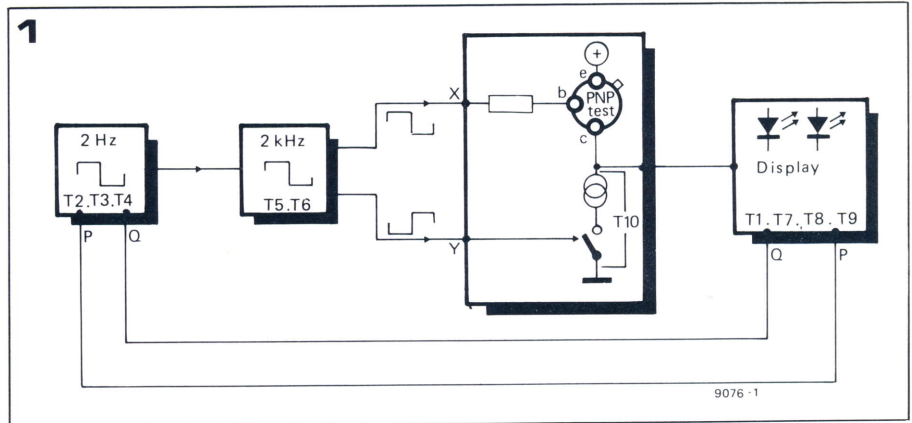

Figure 1. Block diagram of the arrangement for testing a PNP transistor. For clarity, the breakdown voltage test and the complementary test for an NPN transistor have been omitted.

Figure 2. Complete circuit of the TUP/TUN tester. Block A is the collector section, B contains the test bridges for NPN and PNP transistors and C shows the breakdown voltage testing and display sections.

The full display cycle for a 'good' transistor is that both LEDs blink on and off together (figure 3c). It will be seen later that this display occurs only with a transistor which is good according to all the criteria that are tested in socket T_A.

Transistor with low current gain (α')

When the fast oscillator is turned off,

'X' swings positive and 'Y' swings negative, so both T10 and the transistor under test in T_A are cut off. Their commoned collectors are floating, and by the same sequence of events as described for a good transistor, the voltage at the collector of T9 is low and LED 'B' is off. It can be deduced from the table that this combination of switching voltages leads to LED 'A' also being off.

When the fast oscillator comes on and swings 'X' and 'Y' negative and positive respectively, T10 and T_A are both turned on. The potential at the base of T10 is therefore determined by the potentiometer R15 (figure 1a), R26 and R27, i.e.

$$20 \times \frac{33}{4.7 + 120 + 33} = 4.2 \text{ V.}$$

The base-emitter voltage drop in T10 will be about 0.7 V, so the voltage at the emitter of T10 cannot rise above 4.2 V – 0.7 V = 3.5 V. T10 is therefore acting as a current source, its collector current being stabilised at the value determined by this latter voltage and the emitter resistor R28, i.e.

$$\frac{3.5 \times 1000}{470} \text{ mA} \approx 7.4 \text{ mA}$$

As the emitter of T_A is directly connected to the positive supply rail, its base current is determined by the voltage (about 19 V) between 'X' and the positive rail, and by R25, i.e.

$$\frac{18 \times 10^6}{270 \times 10^3} \mu\text{A} \approx 70 \mu\text{A}$$

(the base-emitter resistance can be disregarded in this context).

It has been mentioned that T10 acts as a current source attempting to stabilise the collector current through both transistors at 7.4 mA, which corresponds to a current gain of something over 100 for the transistor under test. If T_A cannot produce this current, T6 bottoms and the voltage at the connected collectors of T_A and T10 becomes too low for T11 and T12 to be turned on (figure 3d). So the potential at 'A' remains positive and LED 'B' stays off. The table will show that LED 'A' comes on.

When the fast oscillator swings to its other polarity (i.e. 'X' swings positive and 'Y' swings negative) the linked collectors of T_A and T10 revert to the floating condition, so that the Darlington pair T11 and T12 remains non-conductive and 'A' positive. LED 'B' therefore stays off and LED 'A' stays on.

Summarising: the LED display with a transistor of low current gain is that LED 'A' blinks and LED 'B' stays on.

Transistor with high capacitances

When the fast oscillator is turned off, the situation is the same as in both the cases already examined: T10 and the transistor under test are both cut off, and this leads to LED 'A' and LED 'B'

both being off. When the fast oscillator comes on and swings 'X' negatively and 'Y' positively, both transistors are turned on, but if T_A has high collector-to-base (C_{cb}) and/or collector-to-emitter (C_{ce}) capacitance, its response is delayed. The voltage rise at its collector is slowed down as these capacitances discharge, but the voltage will probably level off at its 'final' value before the end of the period in which T_A is turned on, and when this happens LED 'B' comes on while LED 'A' stays off (figure 3e).

When, however, T_A and T10 are once more turned off by the swings at 'X' and 'Y', the capacitances can recharge only through the Darlington pair T11 and T12 (which has, by definition, a high input impedance) and through the 10 MΩ resistor R29. The drop in potential at the collector of T_A, as the capacitances recharge, is slower than it would be with a normal transistor, and if the capacitances are too large the potential will not fall far enough to turn T11 off (and therefore LED 'A' on and LED 'B' off) before the time when T_A and T10 are turned on once again. So LED 'B' will stay on, and LED 'A' off, throughout each period when the fast oscillator is turned on.

With slightly smaller capacitances, LED 'A' may come on dimly if the slow recharge of excess capacitance only allows this LED to turn on for a small

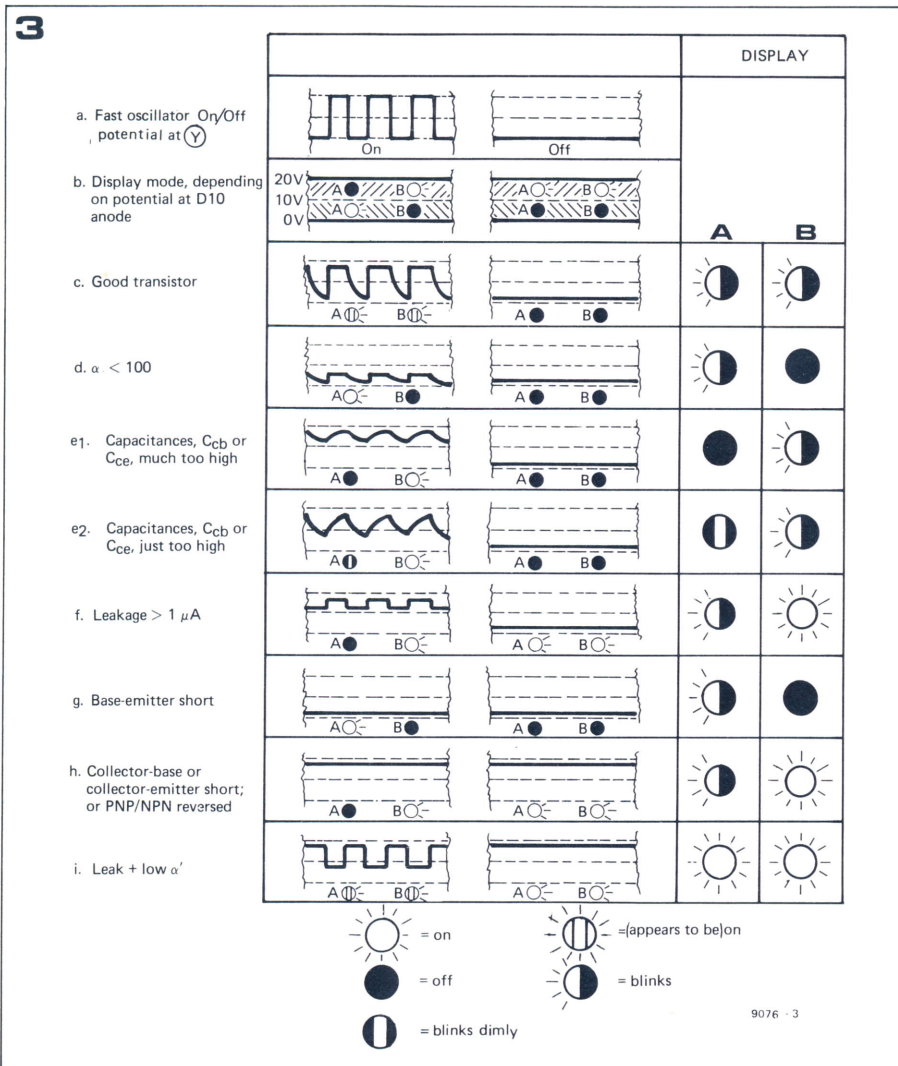

Figure 3. Summary of LED displays, based on the waveforms at the collector of the transistor under test.

Figure 4. Transistor testing chart, showing what the various displays signify. This chart is derived from figure 3.

Figure 5. Transistor (or diode) breakdown test chart.

Figure 6. The conduction test for diodes, in the 'PNP' test socket, is shown in figure 6A. The leakage test for diodes is shown in figure 6B.

Figure 7. Tests to test the tester.

4

DISPLAY		MEANING
LED A	LED B	
		Good transistor
		a. PNP/NPN reversed c. C-B short
		a. Leak > 1 μA d. C-E short
		a. α' < 100 b. B-E short
		C-B or C-E capacitance > 20p
		Leak > 10 μA + very low α' + large C _{cb} or C _{ce}
		C _{cb} or C _{ce} ≈ 20p
		Leak > 10 μA + α' < 50
		Impossible. If this happens something is wrong with the tester. Check the power supply!

	= On continuously		= Blinks
	= Blinks dimly		= Off

9076-4

5

DISPLAY		MEANING
LED A	LED B	
		Good (Breakdown voltage > 20 V)
		Fail (or connections reversed)

NPN	PNP	Diode

Key to display as for figure 4. 9076-5

part of each fast-oscillator cycle. Summarising again: the display for high capacitance is that LED 'B' blinks on and off while LED 'A' remains off or blinks dimly.

Transistor with high leakage

A transistor with high leakage current tends to behave, from the tester's point of view, as though it were turned on all the time. In all the cases examined so far, no collector current flows in the transistor under test while the fast oscillator is turned off. If, however, there is a leakage current between collector and

emitter, this will flow through D10 and R29 to the negative rail even when 'X' is positive and both T_A and T₁₀ are supposed to be cut off. This leakage current develops a voltage across the 10 MΩ resistor R29, and therefore raises the potential at the base of T₁₁.

It will be recalled that the emitter of T₁₂ is held at half the supply voltage (i.e. at about 10 volts) by the potentiometer R30 and R31. So if the leakage current is a little more than 1 μA, it will build up a voltage sufficient to turn on T₁₁ and T₁₂ and thus light up LED 'A' and LED 'B' while the fast oscillator is

off. When the fast oscillator is turned on and the display transistors are switched through 'P' and 'Q', LED 'B' stays on but LED 'A' goes out (figure 3f). So with a transistor having a leakage current of 1 μA or more, LED 'B' stays on and LED 'A' flashes.

Transistor with base and collector or emitter and collector short-circuited

A transistor with one of these faults 'looks like' one with high leakage (only more so). A current can flow from the positive rail through the emitter-base

6 a

DISPLAY		MEANING
LED A	LED B	
		Conducts satisfactorily
		Not conducting, i.e. open circuit or connections reversed

Key to display as for figure 4.

	9076-6A
--	---------

b

DISPLAY		MEANING
LED A	LED B	
		Blocks satisfactorily
		a. Leaks severely b. Shorted c. Connections reversed
		Leaks

Key to display as for figure 4

	9076-6B
--	---------

7

TEST APPLIED	DISPLAY	
	LED A	LED B
1. Nothing plugged into any test socket		
2. Base and collector or emitter and collector sockets shorted in T _A or T _B .		
3. PNP or NPN transistor known to be good, correctly plugged into T _A or T _B as applicable		
4. As previous test, but with a 22 p capacitor connected from collector to base or emitter		
5. Emitter and base leads of a PNP or NPN transistor known to be good connected to the collector and emitter sockets of T _C or T _D , whichever is appropriate; i.e. reverse-diode check of breakdown voltage testing section		

Key to display as for figure 4 9076-7

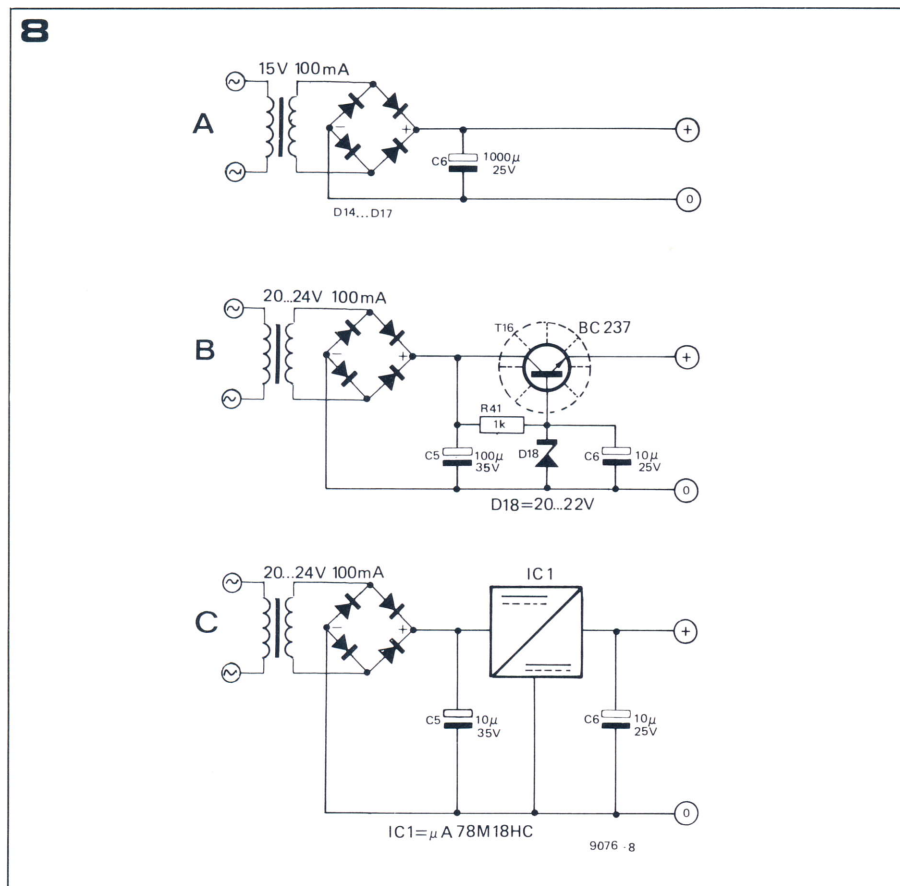

junction and the base-collector short in T_A (or directly through the emitter-collector short), through D10, and through the $10\text{ M}\Omega$ -resistor R29. It has been shown that a leakage current as low as $1\text{ }\mu\text{A}$ can turn on T11 and T12 and therefore make LED 'B' light up and LED 'A' go out while the fast oscillator is on. When the fast oscillator is off, LED 'A' lights up and 'B' stays on. So the display with base and collector or emitter and collector short-circuited is that LED 'B' stays on all the time, and LED 'A' blinks on and off (figure 3h).

Transistor with base and emitter short-circuited

When the base and emitter are short-circuited, no 'normal' base current can flow, and therefore there is no collector current. So the transistor 'looks like' one with zero α' , and the LED display is the same: i.e. LED 'A' blinks and LED 'B' stays off (figure 3g).

Combined leak and low current gain or combined leak and base-emitter short

While the fast oscillator is off, the display is the same as for a leaky transistor: both LED 'A' and LED 'B' are on. When the fast oscillator is on and is turning T_A and T10 off, the leakage current holds the collectors of T_A and T10 high enough in potential to turn on T11, resulting in LED 'A' being off and LED 'B' being on. When the fast oscillator turns T_A and T10 on, the low current gain of T_A allows T10 to 'overcome' both the leakage current and the

Figure 8. Alternative power supply arrangements, depending on the components one can obtain.

Figure 9. The p.c.b. and component layout for the TUP/TUN tester. Three alternative layouts are given, corresponding to the three power supply arrangements.

collector current (if any) in T_A and pull down the potential of the commoned collectors, whereupon LED 'A' comes on and LED 'B' goes off. This alternate lighting up of LED 'A' and LED 'B' is at the speed of the fast oscillator, and both LEDs stay on while the fast oscillator is turned off, so we have a display cycle in which both LEDs appear to be on continuously (figure 3i).

Other combinations of Faults

It would not be a very profitable exercise to list the LED displays with all possible combinations of faults, but it can be said that only a transistor which is 'sound in wind and limb' according to all the test criteria will give the 'good transistor' display in both test sockets.

PNP and NPN transistors

The foregoing descriptions apply to PNP transistors. They also hold good, mutatis mutandis, for NPN transistors plugged into test socket T_B , which appears on the right-hand side of figure 2b. The functions performed by T10, T11 and T12 and associated components for PNP transistors are performed by T13, T14 and T15 and associated components for NPN transistors. In this case, however, the transistors T13 and T14 which pass on a voltage drop at the anode of D11 are not a Darlington pair but a complementary PNP-NPN-pair.

If a transistor is plugged into the wrong test socket (PNP into an NPN socket or vice versa), the base-to-collector path becomes equivalent to a forward-connected diode, and the display is the same as for a transistor with a base-collector short. The transistor will not be damaged, and it is clearly a good thing, when one shows up unexpectedly as 'faulty', to check whether it has been plugged into the wrong holes!

Breakdown Voltage Test

The sockets for this test are T_C and T_D , shown in figure 2c. The effective breakdown test voltage is about 20 V, and if a breakdown current flows the voltage at 'A' is pulled down continuously, resulting in LED 'A' blinking and LED 'B' staying on throughout the cycle. For a transistor which passes this test, LED 'A' blinks and LED 'B' stays off all the time (figure 5).

Diode Tests

By plugging the anode and cathode leads of a diode into the emitter and collector sockets of the PNP test points (or the other way round with the NPN test points) it can be tested for forward conduction, leakage and breakdown voltage. When the fast oscillator is off, the junction of the diode cathode and the collector of T10 will be held positive by the conduction of the diode, and if the conduction is good enough, this junction will remain positive when T10 is turned on (through 'Y') by the fast oscillator. When T10 is turned off the junction will still be positive. This leads to a display cycle in which LED 'A' blinks and LED 'B' stays on continuously (figure 6).

When the diode is non-conducting, open-circuited or connected the wrong way round, the junction of T10 collector and the cathode (or anode) will remain negative throughout the oscillator cycle, giving a LED display in which 'A' blinks and 'B' remains off. When a diode is deliberately connected the wrong way round, this display gives an indication (if the diode is a good one) that it is blocking properly in the reverse direction. If a diode is short-circuited or is leaking severely, it will give the same display, when plugged in the wrong way round, as a good diode connected the correct way round. It is just possible, however, that it is a good diode plugged

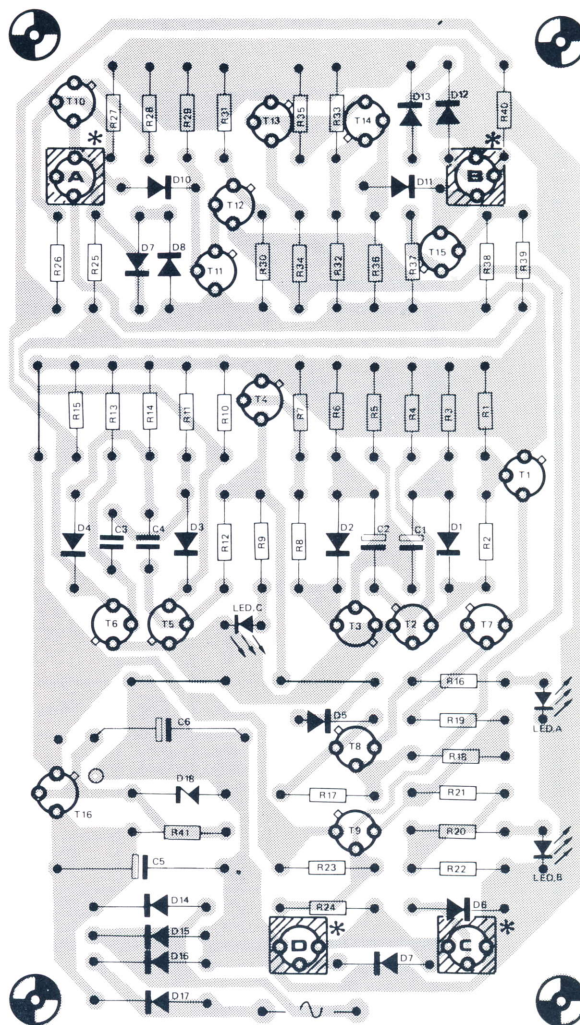
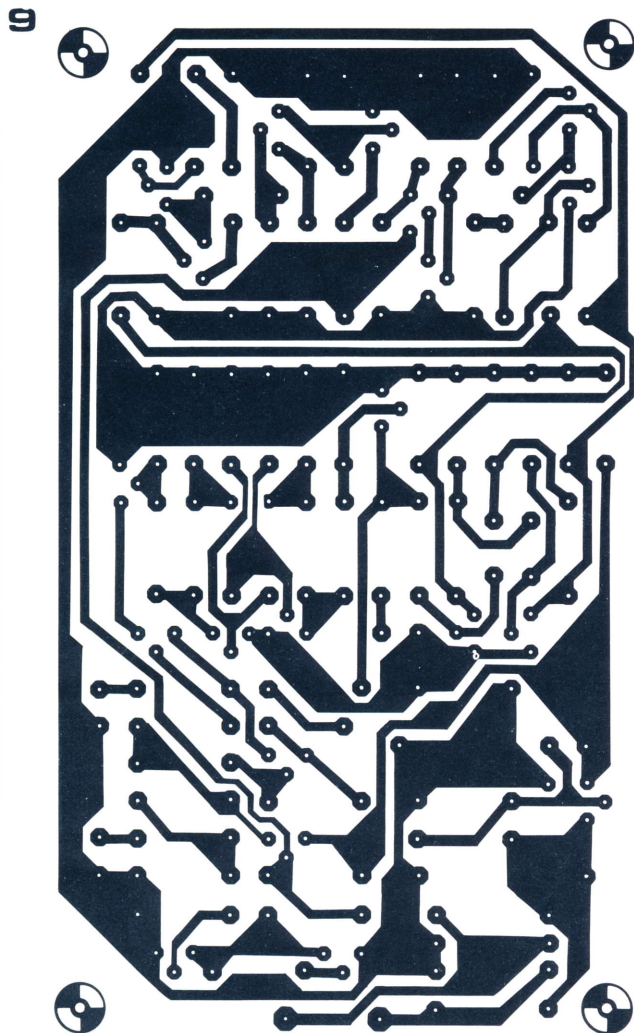

Stabilised supply with discrete components

Tr = 20 V/100 mA
 R41 = 1 k
 C5 = 100 μ /35 V

C6 = 10 μ /35 V
 T16 = BC237B
 D18 = 20 V Zener

Parts list

Resistors:

- R1, R7, R24, R30, R31, R34 = 10 k
- R2, R3, R6, R8 = 22 k
- R4, R5 = 220 k
- R9 (if used), R16, R21 = 680 Ω
- R10, R11, R14, R15 = 4k7
- R12, R13, R32, R33 = 100 k
- R17 = 2k7
- R18, R19 = 47 k
- R22 = 1 k
- R25, R40 = 270 k
- R26 = 120 k
- R27, R38 = 33 k
- R28, R37, R20 = 470 Ω
- R29, R36 = 10 M
- R23, R35 = 1 M
- R39 = 120 k
- R40 = 270 k

Capacitors:

- C1, C2 = 4 μ 7
- C3, C4 = 5n6

Semiconductors:

- T1, T4, T8, T9, T15 = BC307B or equ.
- T2, T3, T5, T6, T7, T10, T12, T13, T16 = BC237B or equ.
- T11 = BC239C or equ.
- T14 = BC179C or equ.
- D1 ... D17 = BAX13, BY126, BY127, 1N4002, or other general-purpose silicon diodes
- 2 x LEDs

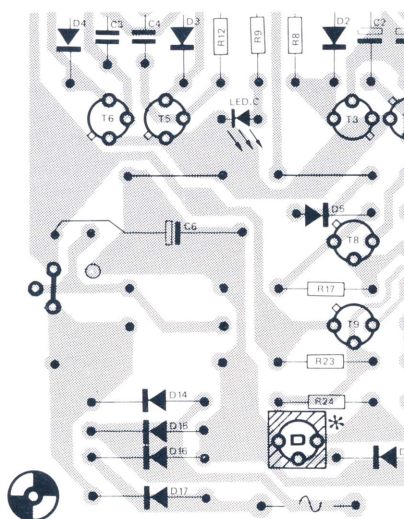

Unstabilised supply
 Tr = 18 V/100 mA
 C6 = 1000 μ /25 V

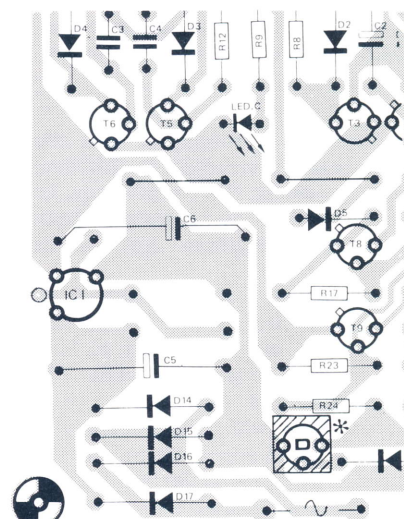

Stabilised supply with IC
 Tr = 20 V/100 mA
 C5 = 100 μ /35 V
 C6 = 10 μ /35 V
 IC = μ A78M18HC or equ.

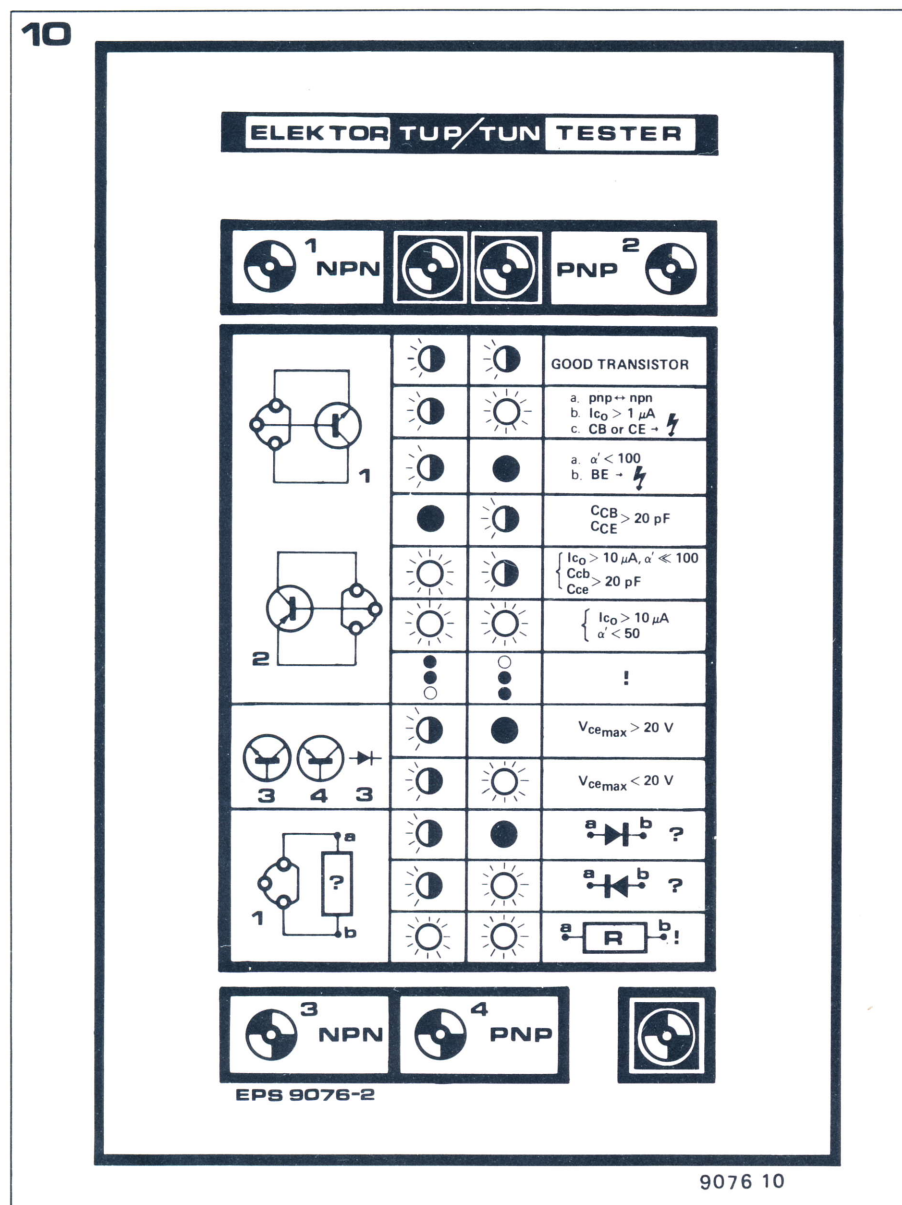

Figure 10. Front panel design for the tester. This panel is available via the Elektor print service, with black lettering on an aluminium-coloured background, as a self-adhesive label.

in the correct way round, i.e. that one has mistakenly connected it this way instead of reversing the connections. So it is important to make tests in both polarities if ambiguities are to be avoided.

If a diode which leaks moderately is plugged in the wrong way round, the leakage current may be enough to hold the anode of D10 positive while T10 is turned off, but not while T10 is turned on. This will give a display in which both LEDs appear to be on continuously – the same as for a transistor which is both leaky and low in current gain.

General

Figure 3 summarises the LED indications when the fast oscillator is on or off, and for different potentials at the anode of D10 in the main PNP testing section. The difference between this figure and table 1 is that the table is based on the

fast oscillator and point 'A', which is common to the main testing circuits and to the breakdown voltage testing circuit. The relationship between the potential at the anode of D10 and the potential at 'A' when the main PNP testing section is in use is that a high potential at the anode of D10 produces a low potential at 'A' and vice versa. Figures 4, 5 and 6 summarise the meanings of the possible LED indications for various tests. Figure 4 is, of course, derived from figure 3. The front panel design (figure 10) summarises all three figures.

Construction and testing

Unless one has access to an independent means of testing the transistors and diodes, these should be ones which carry the manufacturers' warranty. Resistors should have 5% tolerance.

Figure 9 shows the p.c. board and the component layout for the complete tester (with the exception of the mains transformer). It should be noted that the emitter and collector connections to the test sockets appear to be interchanged, but when the sockets are mounted on the copper side of the board

the connections will be correct. This facilitates the mounting of the board flush under the top panel, without the other components getting in the way. As it is not possible to give meaningful voltage or current test values for individual transistors, which might help to localise mistakes or faults, the construction should be checked very carefully. Even if one does not intend to use the optional LED 'C', one of the LEDs which will ultimately serve as 'A' or 'B' can be 'borrowed' at the constructional stage to serve temporarily as 'C' and thus give a check whether the slow oscillator (T2 and T3) and also T4 is working. The actual value of the nominally 680 Ω resistor in series with 'C' is not critical. If the temporary 'C' is seen to blink at about the right rate, test number 1 of figure 7 will show whether T8 is also working. Test number 2 will show whether T7, T9, T11 and T12 are working if the short is put into test socket T_A, and T7, T9, T13 and T14 with the short in test socket T_B.

To check the complete PNP and NPN testing sections, including the breakdown voltage test, one will need spare PNP and NPN transistors known to be sound, in addition to those used in building the tester. Only a transistor with normal current gain, or with a particular combination of faults, can produce a display in which LED 'B' blinks.

Once the two good transistors have been seen to give the display for test number 3 of figure 7, the more refined test number 4, which simulates the effect of excessive capacitance, can be applied. A 22 pF capacitor should be enough to make LED 'A' black out altogether, but it may be of interest to experiment with different lower capacitor values to find what value of capacitor is just low enough to allow the waveform at the junction of T_A and T10 to extend below the critical level (about 10 V) and cause LED 'A' to blink dimly, as shown in figure 3e₂.

The emitter-base junction of a transistor forms a diode with a reverse breakdown voltage of about 5 V, so one of the transistors used in the foregoing checks can also be used to check the breakdown voltage testing section (figure 7; number 5). One must make sure that it is connected the right (or is it the wrong?) way round.

Power Supplies

Three different possibilities are offered for a mains power supply unit (figure 8): a simple unregulated unit, a stabilised unit with the stabilisation circuit built up from three discrete components, or a stabilised unit using an IC. The unregulated unit uses a transformer with an 18 V secondary – which may sometimes be difficult to obtain – and a 1000 μ capacitor. If either of the stabilisation circuits is used, the capacitor can be much smaller. The 20 V transformer used in these circuits should be more readily obtainable.

The transistor or IC should have a heat-sink. 