

HEATHKIT
MODEL IM-11
VTVM

PRICE \$1.00



HEATHKIT® ASSEMBLY MANUAL

DAYSTROM, LIMITED - COOKSVILLE, ONTARIO

DAYSTROM, LIMITED

HEATHKIT® by DAYSTROM



VACUUM TUBE VOLTMETER

MODEL 1M-11

RESISTOR AND CAPACITOR COLOR CODES

RESISTORS

The colored bands around the body of a color coded resistor represent its value in ohms. These colored bands are grouped toward one end of the resistor body. Starting with this end of the resistor, the first band represents the first digit of the resistance value; the second band represents the second digit; the third band represents the number by which the first two digits are multiplied. A fourth band of gold or silver represents a tolerance of $\pm 5\%$ or $\pm 10\%$ respectively. The absence of a fourth band indicates a tolerance of $\pm 20\%$.

The physical size of a composition resistor is related to its wattage rating. Size increases progressively as the wattage rating is increased. The diameters of 1/2 watt, 1 watt and 2 watt resistors are approximately 1/8", 1/4" and 5/16", respectively.

The color code chart and examples which follow provide the information required to identify color coded resistors.

COLOR	CODE		
	1ST DIGIT	2ND DIGIT	MULTIPLIER
BLACK	0	0	1
BROWN	1	1	10
RED	2	2	100
ORANGE	3	3	1,000
YELLOW	4	4	10,000
GREEN	5	5	100,000
BLUE	6	6	1,000,000
VIOLET	7	7	10,000,000
GRAY	8	8	100,000,000
WHITE	9	9	1,000,000,000
GOLD	-	-	.1
SILVER	-	-	.01

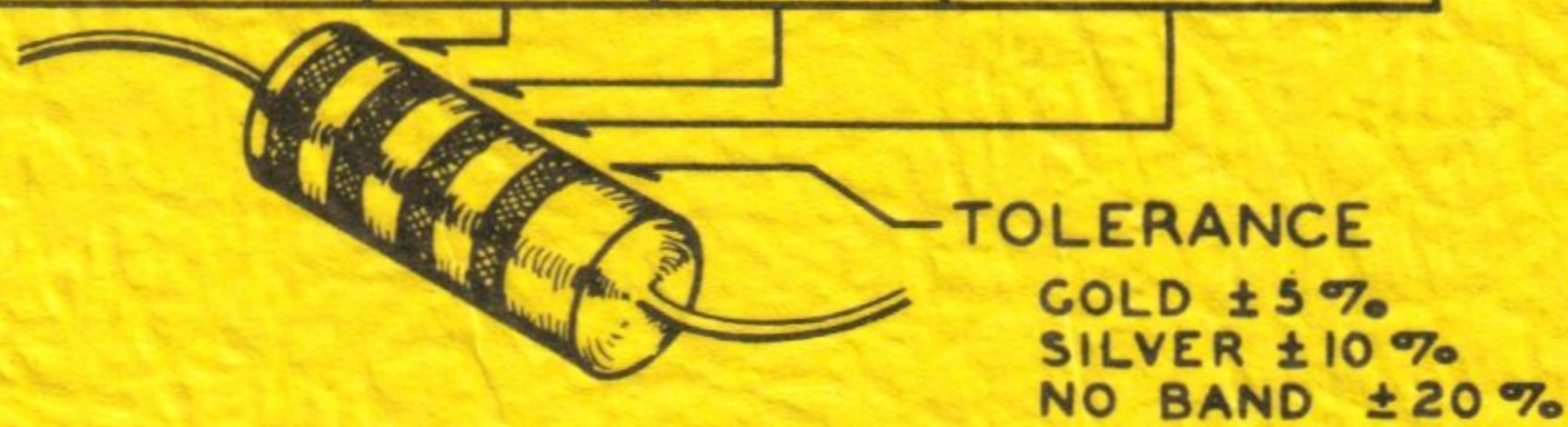

EXAMPLES

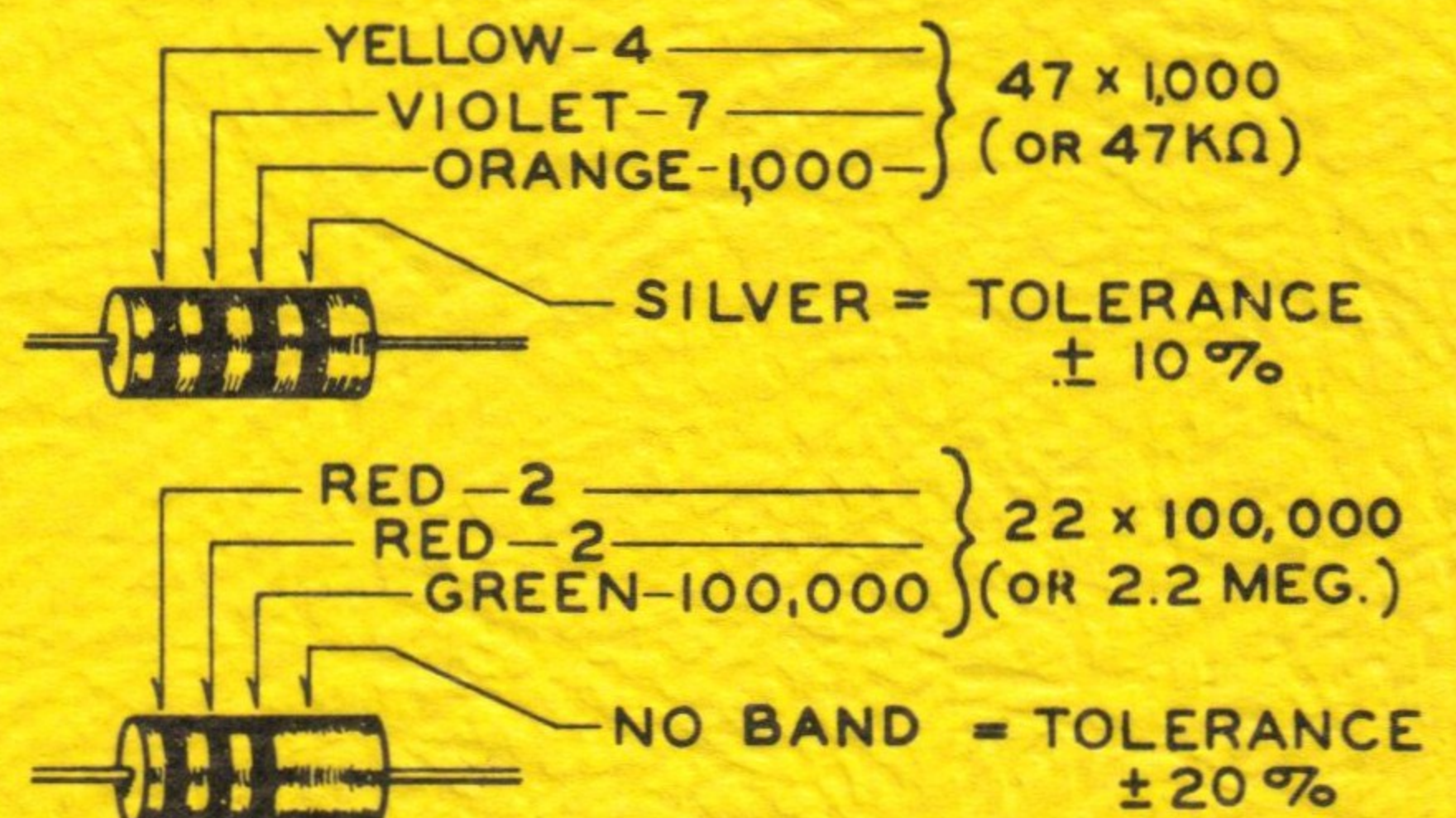

CAPACITORS

Generally, only mica and tubular ceramic capacitors, used in modern equipment, are color coded. The color codes differ somewhat among capacitor manufacturers, however the codes

shown below apply to practically all of the mica and tubular ceramic capacitors that are in common use. These codes comply with EIA (Electronics Industries Association) Standards.

MICA

COLOR	CODE			TOLER. %
	1ST DIGIT	2ND DIGIT	MULTIPLIER	
BLACK	0	0	1	± 20
BROWN	1	1	10	—
RED	2	2	100	± 2
ORANGE	3	3	1,000	± 3
YELLOW	4	4	10,000	—
GREEN	5	5	—	± 5
BLUE	6	6	—	—
VIOLET	7	7	—	—
GRAY	8	8	—	—
WHITE	9	9	—	—
GOLD	-	-	.1	—
SILVER	-	-	.01	± 10

EXAMPLE

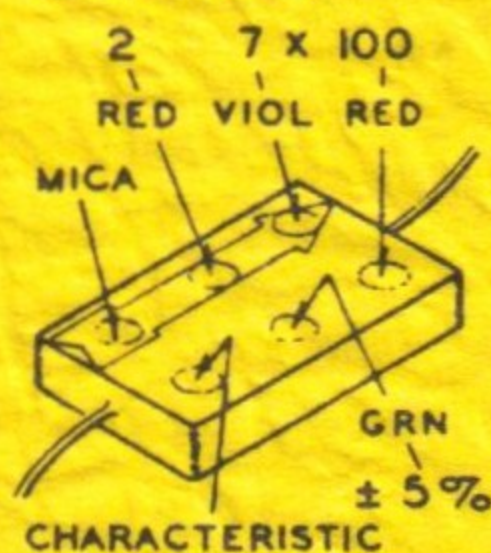

2,700 μf $\pm 5\%$
 OR .0027 μf



TUBULAR CERAMIC

Place the group of rings or dots to the left and read from left to right.

COLOR	CODE			TOLER. %	
	1ST DIGIT	2ND DIGIT	MULTIPLIER	10 OR LESS	OVER 10
BLACK	0	0	1	± 20	± 20
BROWN	1	1	10	± 0.1	± 1
RED	2	2	100	—	± 2
ORANGE	3	3	1,000	—	± 2.5
YELLOW	4	4	10,000	—	—
GREEN	5	5	—	± 0.5	± 5
BLUE	6	6	—	—	—
VIOLET	7	7	—	—	—
GRAY	8	8	—	± 0.25	—
WHITE	9	9	—	± 1.0	± 10

EXAMPLE

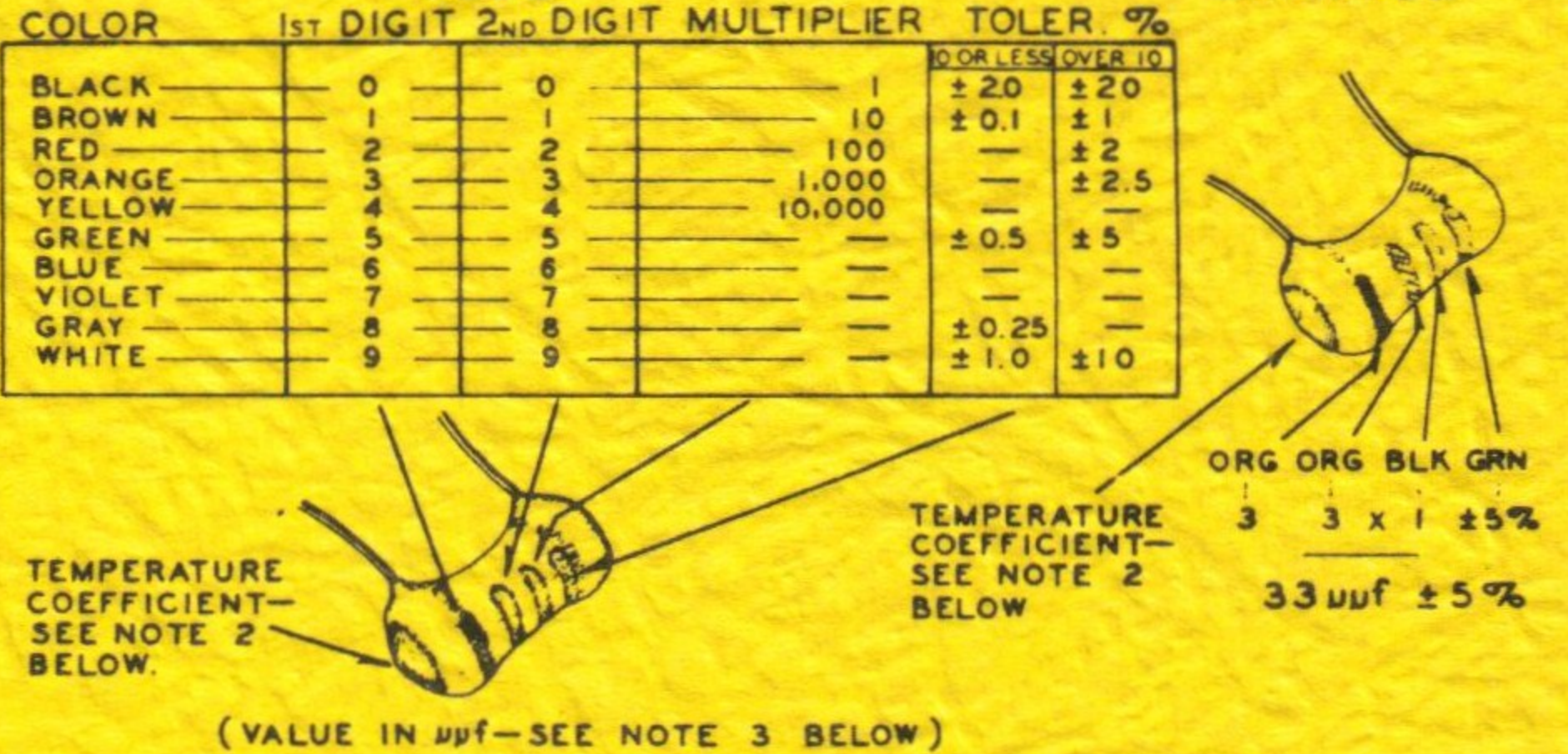

NOTES:

1. The characteristic of a mica capacitor is the temperature coefficient, drift capacitance and insulation resistance. This information is not usually needed to identify a capacitor but, if desired, it can be obtained by referring to EIA Standard, RS-153 (a Standard of Electronic Industries Association.)

2. The temperature coefficient of a capacitor is the predictable change in capacitance with temperature change and is

expressed in parts per million per degree centigrade. Refer to EIA Standard, RS-198 (a Standard of Electronic Industries Association.)

3. The farad is the basic unit of capacitance, however capacitor values are generally expressed in terms of μf (microfarad, .000001 farad) and $\mu\mu\text{f}$ (micro-micro-farad, .000001 μf); therefore, 1,000 $\mu\mu\text{f}$ = .001 μf , 1,000,000 $\mu\mu\text{f}$ = 1 μf .

USING A PLASTIC NUT STARTER

A plastic nut starter offers a convenient method of starting the most used sizes: 3/16" and 1/4" (3-48 and 6-32). When the correct end is pushed down over a nut, the pliable tool conforms to the shape of the nut and the nut is gently held while it is being picked up and started on the screw. The tool should only be used to start the nut.

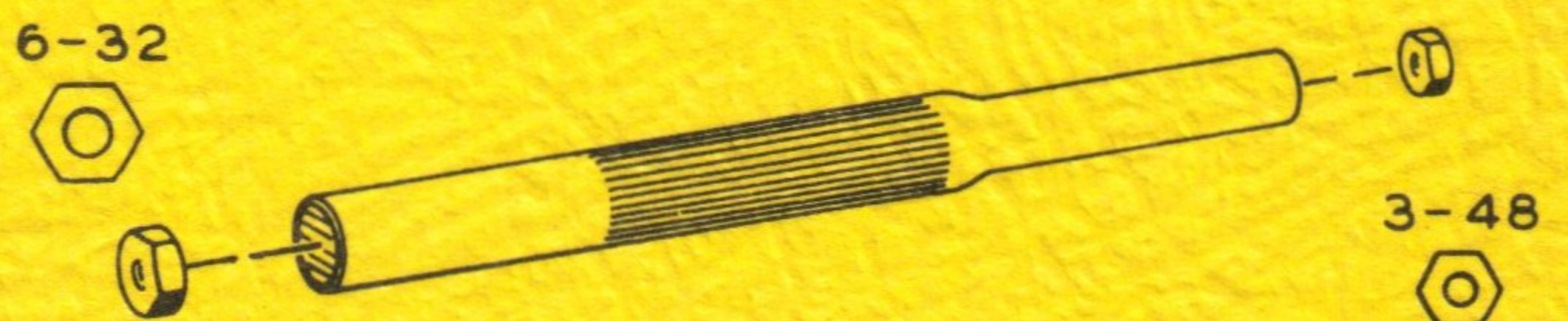

Assembly
and
Operation
of the



VACUUM TUBE
VOLTMETER
MODEL IM-11



TABLE OF CONTENTS

Specifications.	2
Introduction.	3
Circuit Description.	4
Construction Notes.	5
Parts List.	6
Proper Soldering Techniques.	8
Step-By-Step Procedure.	9
Step-By-Step Assembly.	10
Range Switch Assembly.	10
Front Panel Mounting.	12
Front Panel Wiring.	14
Circuit Board Wiring.	15
Connecting Cable.	18
Wiring Circuit Board To The Panel.	18
Mounting The Battery Spring.	18
Meter, Bracket, And Circuit Board Installation.	19
Final Wiring.	20
Preliminary Test.	22
Preparation Of Test Probe And Leads.	22
Test And Calibration.	25
Using The VTVM.	26
In Case Of Difficulty.	30
Troubleshooting Chart.	30
Maintenance.	31
Accessory Probes.	32
Service Information.	32
Service.	32
Replacements.	33
Shipping Instructions.	33
Schematic.	35*

*Fold-out from page.

DAYSTROM, LIMITED
1480 DUNDAS HIGHWAY EAST
COOKSVILLE, ONTARIO

All Prices are subject to change without notice. Daystrom, Limited reserves the right to discontinue instruments and to change specifications at any time without incurring any obligations to incorporate new features in instruments previously sold.

Copyright © 1961
Heath Company
All rights reserved

SPECIFICATIONS

Electronic DC Voltmeter -

7 Ranges.	0-1.5, 5, 15, 50, 150, 500, 1500 volts full scale; up to 30,000 volts with accessory probe.
Input Resistance.	11 megohms (1 megohm in probe) on all ranges; 1100 megohms with accessory probe.
Sensitivity.	7,333,333 ohms-per-volt on 1.5 volt range.
Circuit.	Balanced bridge (push-pull) using twin triode.
Accuracy.	±3% full scale.

Electronic AC Voltmeter -

7 rms Ranges.	0-1.5, 5, 15, 50, 150, 500, 1500 rms scales (.353 of peak-to-peak).
7 Peak-to-Peak Ranges.	0-4, 14, 40, 140, 400, 1400, 4000.
Frequency Response (5 V range).	±1 db 25 cps to 1 mc (600 Ω source).
Accuracy.	±5% full scale.
Input Resistance And Capacitance.	1 megohm shunted by 35 μμf (measured at input terminals).

Electronic Ohmmeter -

7 Ranges.	Scale with 10 Ω center X1, X10, X100, X1000, X10K, X100K, X1MEG. Measures .1 Ω to 1000 megohms with internal battery.
Meter.	4-1/2", 200 μa movement, polystyrene case.
Probes.	Combined AC-OHMS-DC switching probe, single jack input for probe and ground connections.
Multipliers.	1% precision type.
Circuit Board.	Printed circuit; etched metal process.
Tubes.	1 - 12AU7, twin triode meter bridge. 1 - 6AL5, twin diode AC rectifier.



Battery.	1-1/2 volt flashlight cell.
Power Requirements.	105-125 volts, 50/60 cps AC, 10 watts.
Cabinet Size And Finish.	7-3/8" high x 4-11/16" wide x 4-1/8" deep, charcoal gray.
Net Weight.	3-1/2 lbs.
Shipping Weight.	5 lbs.

INTRODUCTION

The HEATHKIT Model IM-11 Vacuum Tube Voltmeter is intended for use by servicemen, engineers, and maintenance men to make accurate measurements of DC+, DC-, AC rms and peak-to-peak voltages, plus resistance. The design is simple and rugged, yet accurate.

The instrument employs vacuum tubes for rectification and amplification on all measurement functions to insure good sensitivity and stability of operation. Precision resistors are used in the voltage divider networks to provide high accuracy.

The confusing tangle of test leads coming from the front panel of most VTVMs is eliminated by the use of a combination AC-OHMS-DC switching test probe and a single jack input connection for both test probe and ground leads. The 1 megohm resistor in the probe is switched into operation

when the probe switch is set on DC. This isolating resistor allows DC component voltages to be measured separately, even when high frequency AC voltages are present at the test point.

The VTVM has a very high input impedance (11 megohms on DC and 1 megohm shunted by 35 $\mu\mu\text{f}$ on AC). Consequently, the circuit in which the voltage is being measured will not be significantly loaded by the VTVM. Most nonelectronic voltmeters (VOM) have a much lower input impedance over the most frequently used ranges of test voltages. Consequently, when a VOM is used to measure voltages in high impedance circuits, the indicated voltage will be appreciably less than the actual voltage. The amplifier section of the VTVM also enables the VTVM to accurately measure much higher resistances than can be measured with a VOM.

CIRCUIT DESCRIPTION

The combination AC-OHMS-DC test lead of the VTVM is connected to the Function switch, which is used to choose the parts of the VTVM circuit needed for any of the VTVM measurement functions. The COMMON test lead is connected to the case (ground) of the instrument.

With the Function switch in the DC+ or DC- position and the switching probe on DC, the test voltage is applied through the 1 megohm resistor in the probe to the Range switch, which is a series of precision resistors arranged as a voltage divider. Depending on the position of the Range switch, a portion of this DC voltage is "picked off" and applied to the input grid of the 12AU7 tube.

With the Function switch in the AC position and the test probe on AC-OHMS, an AC test voltage is applied to the 6AL5 tube (half-wave doubler circuit) where it is changed to a DC voltage which is proportional to the applied AC test voltage. On the higher AC ranges, a voltage divider arrangement is used at the input of the 6AL5 tube to insure that the AC voltage applied to the 6AL5 tube does not exceed the tube's rating. The DC voltage output of the 6AL5 tube is applied to the Range switch and then to the input grid of the 12AU7 tube, in the same way that DC test voltages are applied. A capacitor is used at the output of the 6AL5 to hold the applied pulsating DC voltage at its peak value, so that the VTVM responds to peak voltage regardless of the test voltage waveform. The AC balance control is used to "buck-out" the small amount of contact potential in the 6AL5 tube, thus eliminating residual readings on the lower AC ranges.

The ohmmeter section of the VTVM uses a 1.5 volt battery connected in series with part of the voltage divider network (determined by the Range switch position) and the resistance to be measured. The ratio between the ohmmeter voltage divider network resistors and the measured resistance determines what portion of the ohmmeter battery voltage is applied to the input grid of the 12AU7 tube.

Thus, for all measurement functions, a voltage dependent upon the quantity being measured is applied to the grid of one-half of the 12AU7 twin triode. With zero voltage input to the 12AU7 balanced bridge circuit, each of its triode sec-

tions draws the same amount of cathode current and therefore each cathode is of the same voltage potential. The meter movement is connected between the cathodes of the 12AU7 tube and consequently will not deflect since both cathodes are at the same potential.

When a positive voltage (from the Range switch) is applied to one-half of the 12AU7 tube, this half of the tube draws more current than the other half, causing a difference in cathode potential between the two tube sections. Since the meter is connected between the two cathodes, a current flows through the meter movement. The meter pointer responds proportionally to this current, indicating the value of voltage or resistance being measured. The DC+ and DC- switch positions are used to reverse the meter connections between the cathodes so that current always flows through the meter in the same direction.

The use of the bridge circuit eliminates any change in the voltage reading if the B+ voltage in the VTVM should vary since the resulting variation in tube conduction will occur in both triodes and, therefore, will not affect the difference in cathode potential. Also, the maximum conduction characteristic of the 12AU7 tube, as used in the VTVM circuit, is such that the voltage applied to the meter terminals cannot be large enough to damage the meter movement. This is one of the primary advantages of the VTVM circuit. The meter movement cannot be burned out by inadvertently measuring a voltage that is higher than the Range switch setting. However, if excessive voltage is applied, the pointer may be bent as it hits against the stop. Caution must also be exercised to avoid applying any test voltage to the test probe when the Function switch is set in the OHMS position. The precision resistors in the ohmmeter voltage divider network have very low power ratings and can easily be burned out in this way.

The power supply of the VTVM uses a Silicon rectifier in a half-wave rectifier circuit. An electrolytic capacitor is used for filtering the DC voltage from the power supply. The power supply provides both B+ voltage for the 12AU7 tube and positive DC "buck-out" voltage for the AC balance circuit.



CONSTRUCTION NOTES

This manual is supplied to assist you in every way to complete your kit with the least possible chance for error. The arrangement shown is the result of extensive experimentation and trial. If followed carefully, the result will be a stable instrument, operating at a high degree of dependability. We suggest that you retain the manual in your files for future reference, both in the use of the instrument and for its maintenance.

UNPACK THE KIT CAREFULLY AND CHECK EACH PART AGAINST THE PARTS LIST. In so doing, you will become acquainted with the parts. Refer to the charts and other information on the inside covers of the manual to help you identify the components. If some shortage or parts damage is found in checking the Parts List, please read the Replacement section and supply the information called for therein. Include all inspection slips in your letter to us.

Resistors generally have a tolerance rating of 10% unless otherwise stated in the Parts List.

Tolerances on capacitors are generally even greater. Limits of +100% and -20% are common for electrolytic capacitors.

We suggest that you do the following before work is started:

1. Lay out all parts so that they are readily available.
2. Provide yourself with good quality tools. Basic tool requirements consist of a screwdriver with a 1/4" blade; a small screwdriver with a 1/8" blade; long-nose pliers; wire cutters, preferably separate diagonal cutters; a pen knife or a tool for stripping insulation from wires; a soldering iron (or gun) and rosin core solder. A set of nut drivers and a nut starter, while not necessary, will aid extensively in construction of the kit. Also, a soldering "pencil" is best for the circuit board soldering, but is not necessary.

Most kit builders find it helpful to separate the various parts into convenient categories. Muffin tins or molded egg cartons make convenient trays for small parts. Resistors and capacitors may be placed with their lead ends inserted in the edge of a piece of corrugated cardboard until they are needed. Values can be written on the cardboard next to each component. The illustration shows one method that may be used.

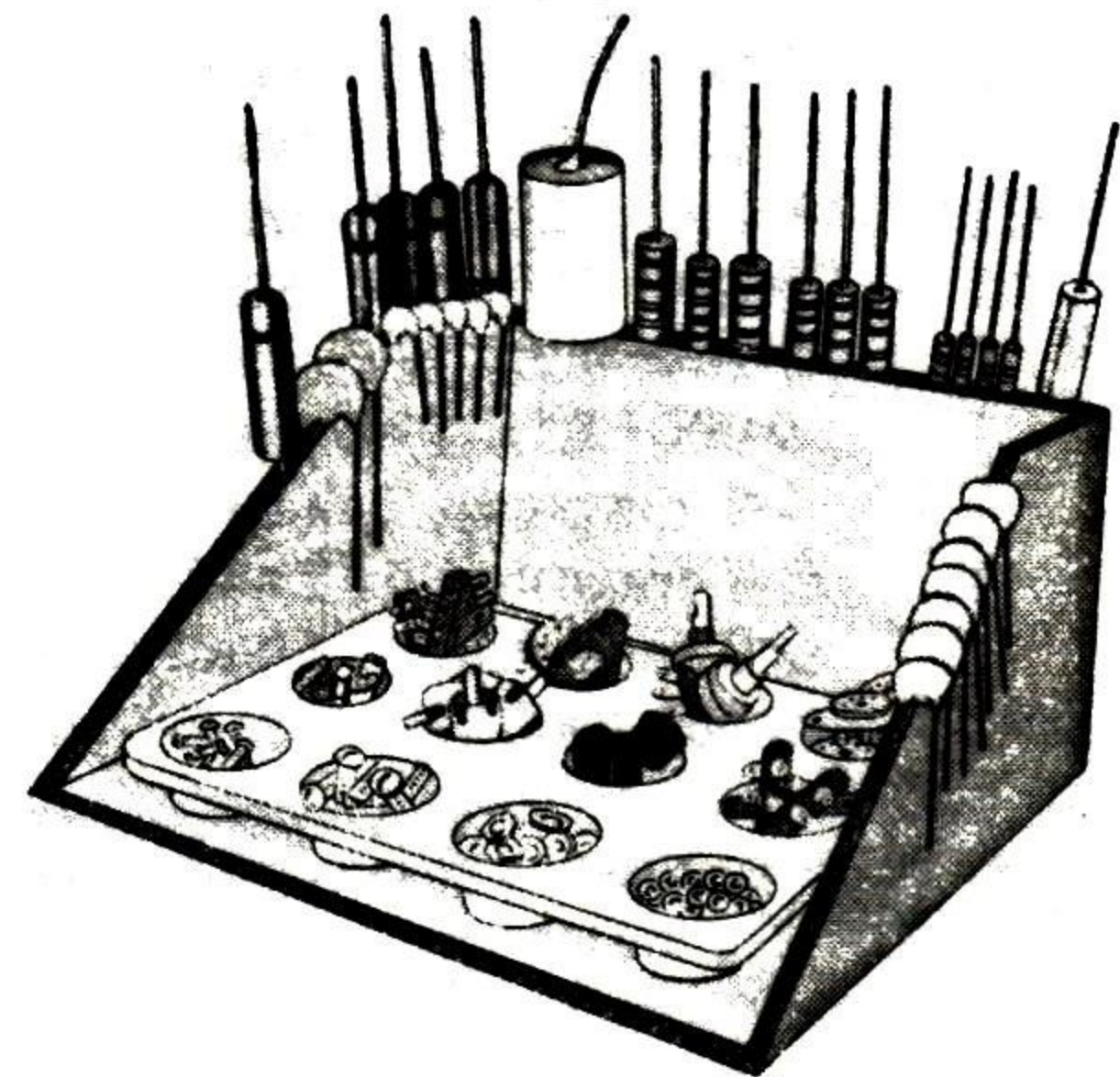

PARTS LIST

<u>PART No.</u>	<u>PARTS Per Kit</u>	<u>DESCRIPTION</u>
Resistors		
① 1-3	1	100 Ω 1/2 watt (brown-black-brown)
1-20	1	10 KΩ 1/2 watt (brown-black-orange)
1-23	1	27 KΩ 1/2 watt (red-violet-orange)
1-27	2	150 KΩ 1/2 watt (brown-green-yellow)
1-29	1	220 KΩ 1/2 watt (red-red-yellow)
1-35	1	1 megohm 1/2 watt (brown-black-green)
1-38	1	3.3 megohm 1/2 watt (orange-orange-green)
1-40	1	10 megohm 1/2 watt (brown-black-blue)
1-70	5	22 megohm 1/2 watt (red-red-blue)
② 2-48	1	9.1 Ω 5% precision 1 watt (white-brown-gold-gold)
* 2-24	1	90 Ω 1/2 watt precision
2-29	1	900 Ω 1/2 watt precision
2-35	1	9 KΩ 1/2 watt precision
2-50	1	10 KΩ 1/2 watt precision
2-38	1	20 KΩ 1/2 watt precision
2-9	1	70 KΩ 1/2 watt precision
2-41	1	90 KΩ 1/2 watt precision
2-86	1	150 KΩ 1/2 watt precision
2-54	1	200 KΩ 1/2 watt precision
2-87	1	320 KΩ 1/2 watt precision
2-13	1	700 KΩ 1/2 watt precision
2-51	1	900 KΩ 1/2 watt precision
2-55	1	2 megohm 1/2 watt precision
2-16	1	7 megohm 1/2 watt precision
2-52	1	9 megohm 1/2 watt precision
2A-28	1	900 KΩ precision 1 watt

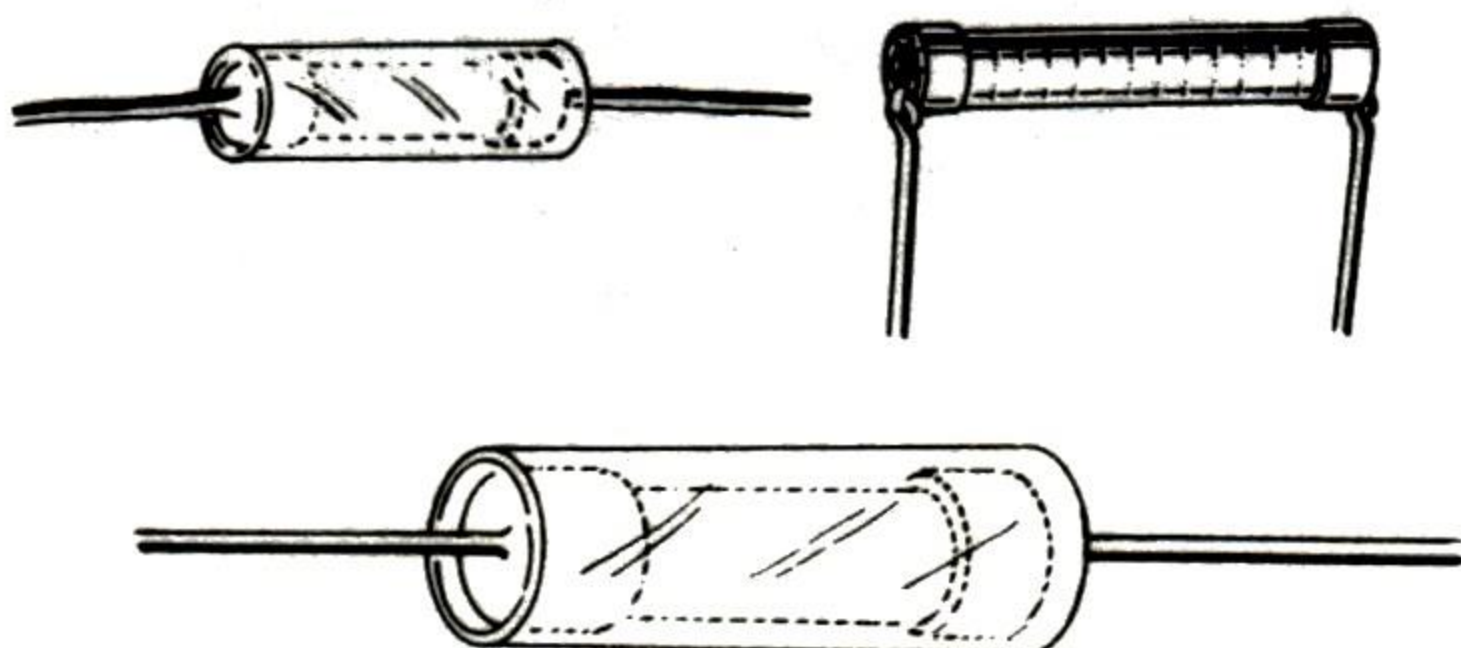
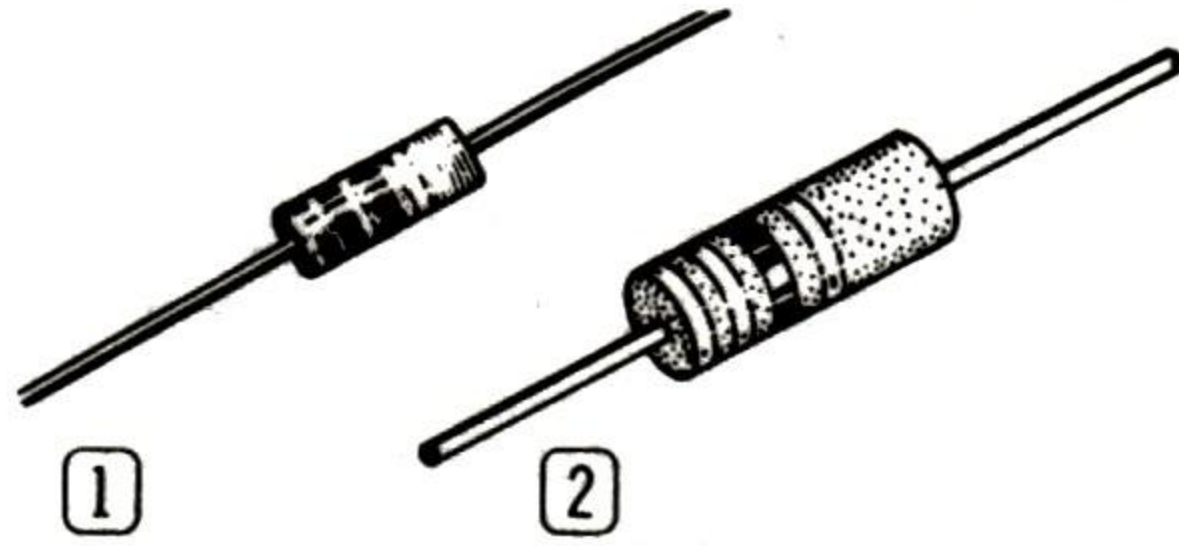

*Various shapes of precision resistors.

<u>PART No.</u>	<u>PARTS Per Kit</u>	<u>DESCRIPTION</u>
Capacitors		
③ 21-27	2	.005 μfd 400 V disc ceramic
21-31	2	.02 μfd 400 V disc ceramic
23-91	1	.047 μfd 1600 V tubular
④ 25-5	1	16 μfd 150 V electrolytic

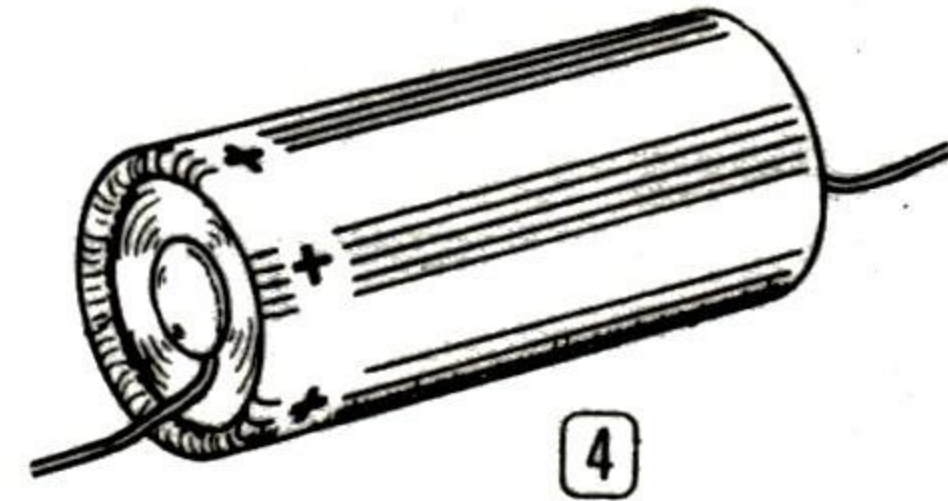

<u>PART No.</u>	<u>PARTS Per Kit</u>	<u>DESCRIPTION</u>
Controls-Switches		
⑤ 10-78	2	15 KΩ control
⑥ 10-38	3	10 KΩ control
63-	1	Range switch
⑦ 63-	1	Function switch

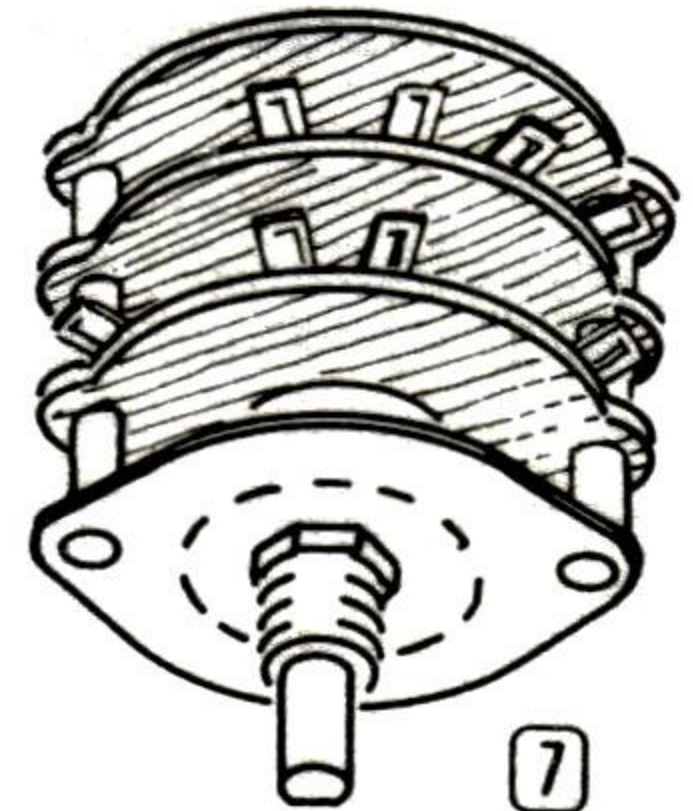

<u>Tubes-Lamps</u>	<u>Quantity</u>	<u>DESCRIPTION</u>
411-25	1	12AU7 tube
411-40	1	6AL5 tube
412-4	1	#50 pilot lamp

<u>Sockets</u>	<u>Quantity</u>	<u>DESCRIPTION</u>
434-47	1	Pilot lamp socket
⑧ 434-79	1	9-pin tube socket
434-112	1	7-pin tube socket

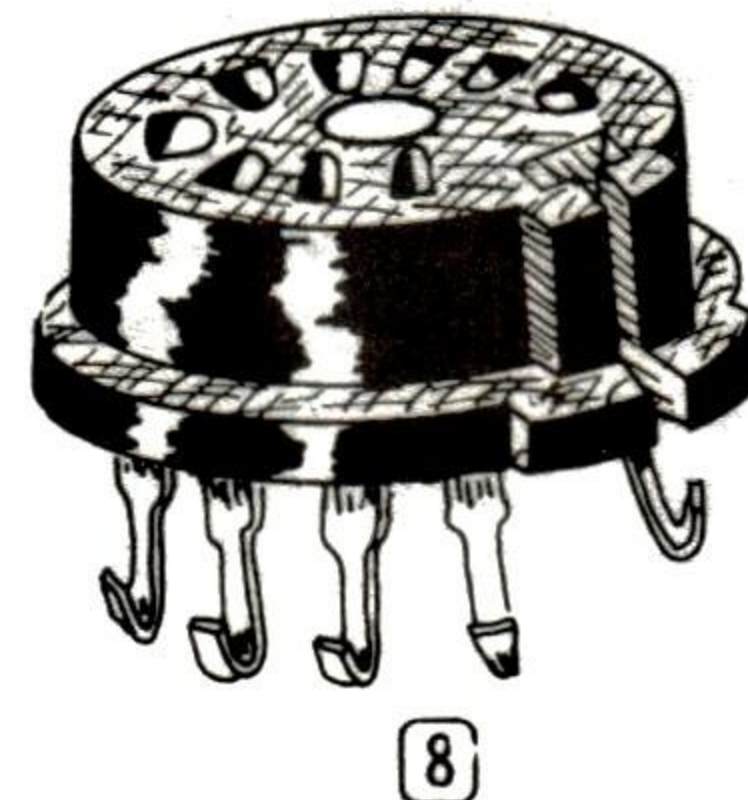

PART No.	PARTS Per Kit	DESCRIPTION
Wire-Sleeving		
89-1	1	Line cord
340-2	1	#20 bare wire
341-1	1	Length black test lead
343-6	1	Length shielded test lead
344-1	1	Length hookup wire
347-1	1	8-wire cable harness
346-1	1	Length insulating sleeving
346-6	1	Fiber glass sleeving

Sheet Metal Parts		
90-195	1	Cabinet and rear cover
203-278F601-602-603	1	Front panel
204-M230	1	Bracket assembly
214-2	1	Battery housing cup
204-M84	1	Support bracket

Hardware		
① 250-8	2	#6 sheet metal screw
② 250-89	3	6-32 x 3/8" screw
③ 250-56	1	6-32 x 1/4" screw
250-83	2	#10 x 1/2" sheet metal screw



252-3	4	6-32 nut
④ 252-7	5	Control nut
253-2	1	#6 fiber shoulder washer
253-3	2	#10 fiber flat washer
⑤ 253-10	5	Control flat washer
⑥ 254-4	5	Control lockwasher
⑦ 254-1	4	#6 lockwasher
259-1	1	#6 solder lug

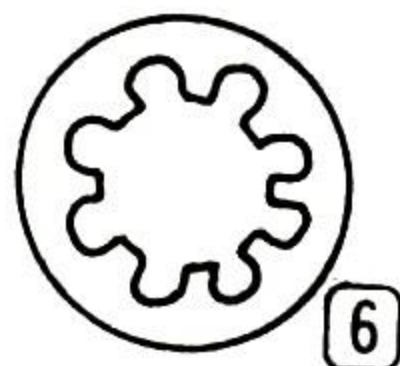
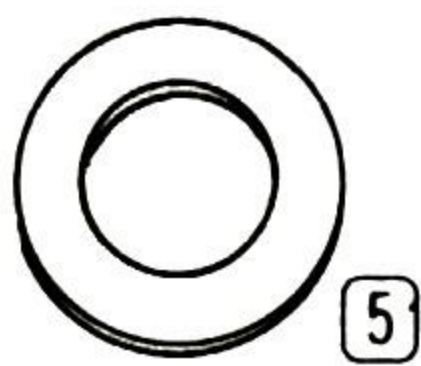

Probe Parts		
⑧ 253-51	1	E washer
⑨ 256-15	2	1/16" x 1/8" rivet
258-53	1	Probe contact loading spring
⑩ 459-6	1	Probe switch lever
⑪ 459-7	1	Probe insert insulator



PART No.	PARTS Per Kit	DESCRIPTION
Probe Parts (Cont'd.)		
476-13	1	Front section of probe body
⑫ 476-14	1	Center section of probe body
476-15	1	Rear section of probe body
⑬ 477-6	1	Probe spike
346-12	1	Probe spike rubber sleeve



Miscellaneous		
54-23	1	Power transformer
⑭ 57-27	1	Silicon rectifier
85-9F102	1	Circuit board
211-15	1	Handle
258-7	1	Battery spring
260-1	1	Alligator clip
261-4	4	Rubber feet
407-62	1	200 microampere meter and hardware
⑮ 436-20	1	Phone jack
⑯ 438-28	1	Phone plug
462-187	2	Knob w/indicator line
⑰ 75-24	1	Line cord strain relief
595-486	1	Manual
409-1	1	Meter Cover (for replacement purposes only)

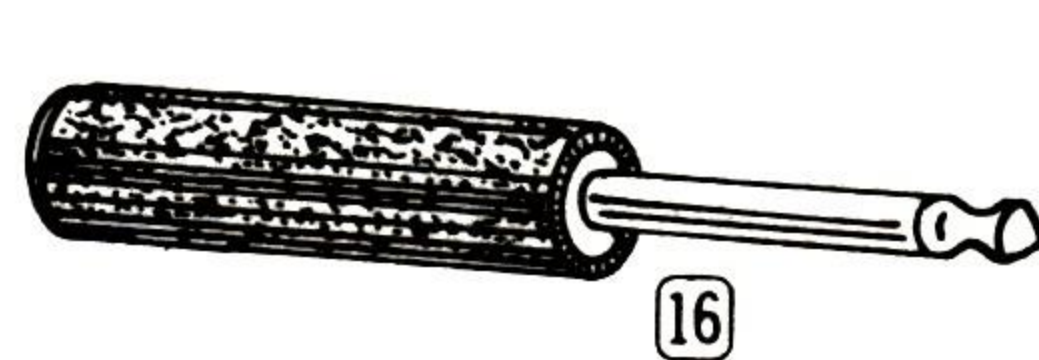
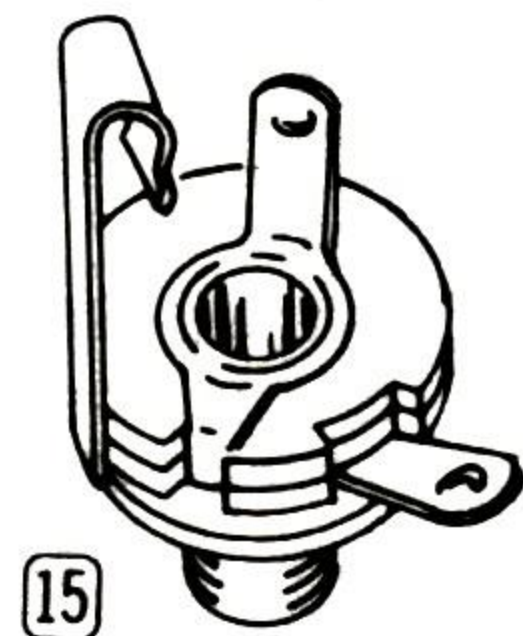

Note: One size C 1.5 volt flashlight battery will also be needed before the ohmmeter function of your VTVM can be used. By purchasing the battery now, you will be able to use your VTVM as soon as assembly is completed.

PROPER SOLDERING TECHNIQUES

Only a small percentage of HEATHKIT equipment purchasers find it necessary to return an instrument for factory service. Of these instruments, by far the largest portion of malfunctions are due to poor or improper soldering.

If terminals are bright and clean and free of wax, frayed insulation and other foreign substances, no difficulty will be experienced in soldering. Correctly soldered connections are essential if the performance engineered into a kit is to be fully realized. If you are a beginner with no experience in soldering, a half hour's practice with some odd lengths of wire may be a worthwhile investment.

For most wiring, a 30 to 100 watt iron or its equivalent in a soldering gun is very satisfactory. A lower wattage iron than this may not heat the connection enough to flow the solder smoothly over the joint. Keep the iron tip clean and bright by wiping it from time to time with a cloth.

CHASSIS WIRING AND SOLDERING

1. Unless otherwise indicated, all wire used is the type with colored insulation (hookup wire); the size of the conductor is the same for all colors of hookup wires furnished with this kit. In preparing a length of hookup wire, 1/4" of insulation should be removed from each end unless directed otherwise in the construction step.
2. To avoid breaking internal connections when stripping insulation from the leads of transformers or similar components, care should be taken not to pull directly on the lead. Instead, hold the lead with pliers while it is being stripped.
3. Leads on resistors, capacitors and similar components are generally much longer than they need to be to make the required connections. In these cases, the leads should be cut to proper length before the part is wired into the kit. In general, the leads should be just long enough to reach their terminating points.
4. Wherever there is a possibility of bare leads shorting to other parts or to the chassis, the leads should be covered with insulating sleeving. Where the use of sleeving is specifically intended, the phrase "use sleeving" is included in the associated construction step. In any case where there is the possibility of an unintentional short circuit, sleeving should be used. Extra sleeving is provided for this purpose.
5. Crimp or bend the lead (or leads) around the terminal to form a good joint without relying on solder for physical strength. If the wire is too large to allow bending or if the step states that the wire is not to be crimped, position the wire so that a good solder connection can still be made.
6. Position the work, if possible, so that gravity will help to keep the solder where you want it.
7. Place a flat side of the soldering iron tip against the joint to be soldered until it is heated sufficiently to melt the solder.
8. Then place the solder against the heated terminal and it will immediately flow over the joint; use only enough solder to thoroughly wet the junction. It is usually not necessary to fill the entire hole in the terminal with solder.
9. Remove the solder and then the iron from the completed junction. Use care not to move the leads until the solder is solidified.

A poor or cold solder joint will usually look crystalline and have a grainy texture, or the solder will stand up in a blob and will not have adhered to the joint. Such joints should be reheated until the solder flows smoothly over the entire junction. In some cases, it may be necessary to add a little more solder to achieve a smooth bright appearance.

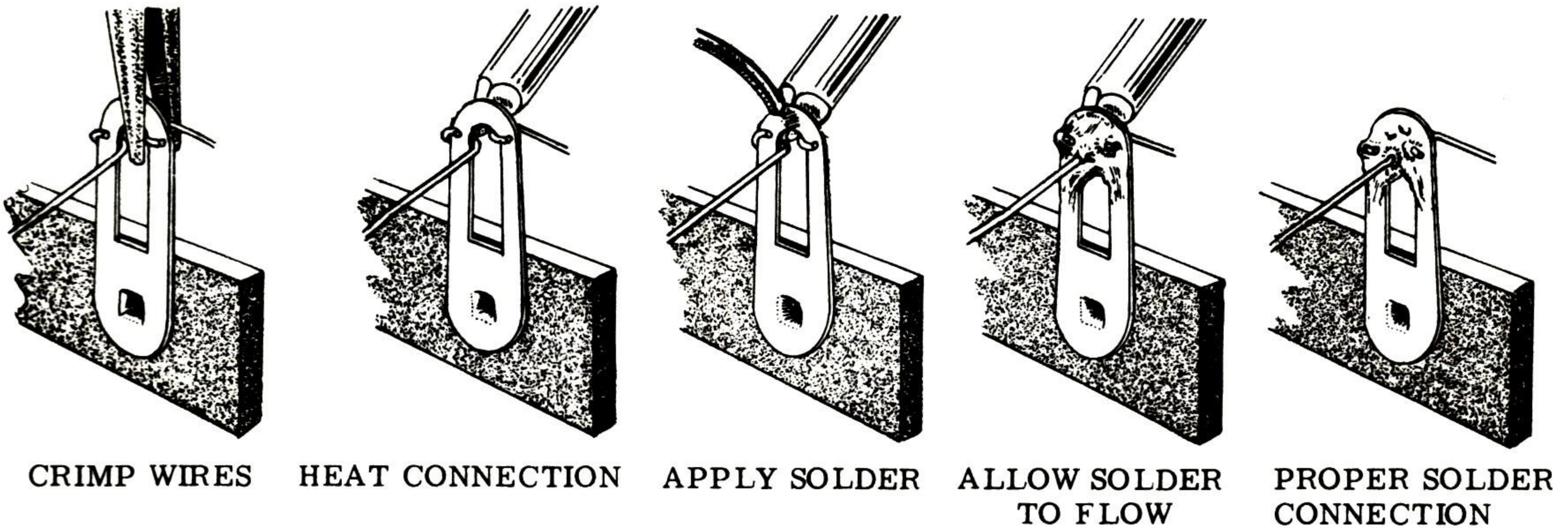

NOTE: ALL GUARANTEES ARE VOIDED AND WE WILL NOT REPAIR OR SERVICE INSTRUMENTS IN WHICH ACID CORE SOLDER OR PASTE FLUXES HAVE BEEN USED. WHEN IN DOUBT ABOUT SOLDER, IT IS RECOMMENDED THAT A NEW ROLL PLAINLY MARKED "ROsin CORE RADIO SOLDER" BE PURCHASED.

STEP-BY-STEP PROCEDURE

The following instructions are presented in a logical step-by-step sequence to enable you to complete your kit with the least possible confusion. Be sure to read each step all the way through before beginning the specified operation. Also read several steps ahead of the actual step being performed. This will familiarize you with the relationship of the subsequent operations. When the step is completed, check it off in the space provided. This is particularly important as it may prevent errors or omissions, especially if your work is interrupted. Some kit builders have also found it helpful to mark each lead in colored pencil on the Pictorial as it is added.

In general, the illustrations in this manual correspond to the actual configuration of the kit; however, in some instances the illustrations may be slightly distorted to facilitate clearly showing all of the parts.

The abbreviation "NS" indicates that a connection should not be soldered yet as other wires will be added. When the last wire is installed, the terminal should be soldered and the abbreviation "S" is used to indicate this. Note

that a number will appear after each solder instruction. This number indicates the number of leads that are supposed to be connected to the terminal in point before it is soldered. For example, if the instruction reads, "Connect a lead to lug 1 (S-2)," it will be understood that there will be two leads connected to the terminal at the time it is soldered. (In cases where a lead passes through a terminal or lug and then connects to another point, it will count as two leads, one entering and one leaving the terminal.)

The use of insulating sleeving is specified in part of the wiring procedure. This sleeving is used to cover the whole length of hookup wire or resistor lead involved in the step. Its purpose is to insure complete insulation between that wire and adjacent wiring or parts.

The steps directing the installation of color coded resistors include color codes to help identify the parts. Also, if a part is identified by a letter-number designation on the Schematic, its designation will appear at the beginning of the construction step which directs its installation.

STEP-BY-STEP ASSEMBLY

RANGE SWITCH ASSEMBLY

Select the Range switch (#63-79). Study Detail 1A for proper orientation and switch lug designations. Orient the switch by locating the blank space on the front deck between lugs 7 and 8. The lug numbering proceeds clockwise when the switch is viewed from the rear. Two of the three decks, or wafers, are 12-lug wafers and the third is an 11-lug wafer. The lugs will be designated as follows: Front deck, which is the deck nearest the switch shaft, is numbered 1 through 11 at each position. The second deck positions are numbered from 1 through 12, as are the rear deck positions. The rear deck is farthest from the switch shaft. Notice that on the front deck, contacts appear on both sides of the deck, whereas on the remaining decks the contacts are all on one side.

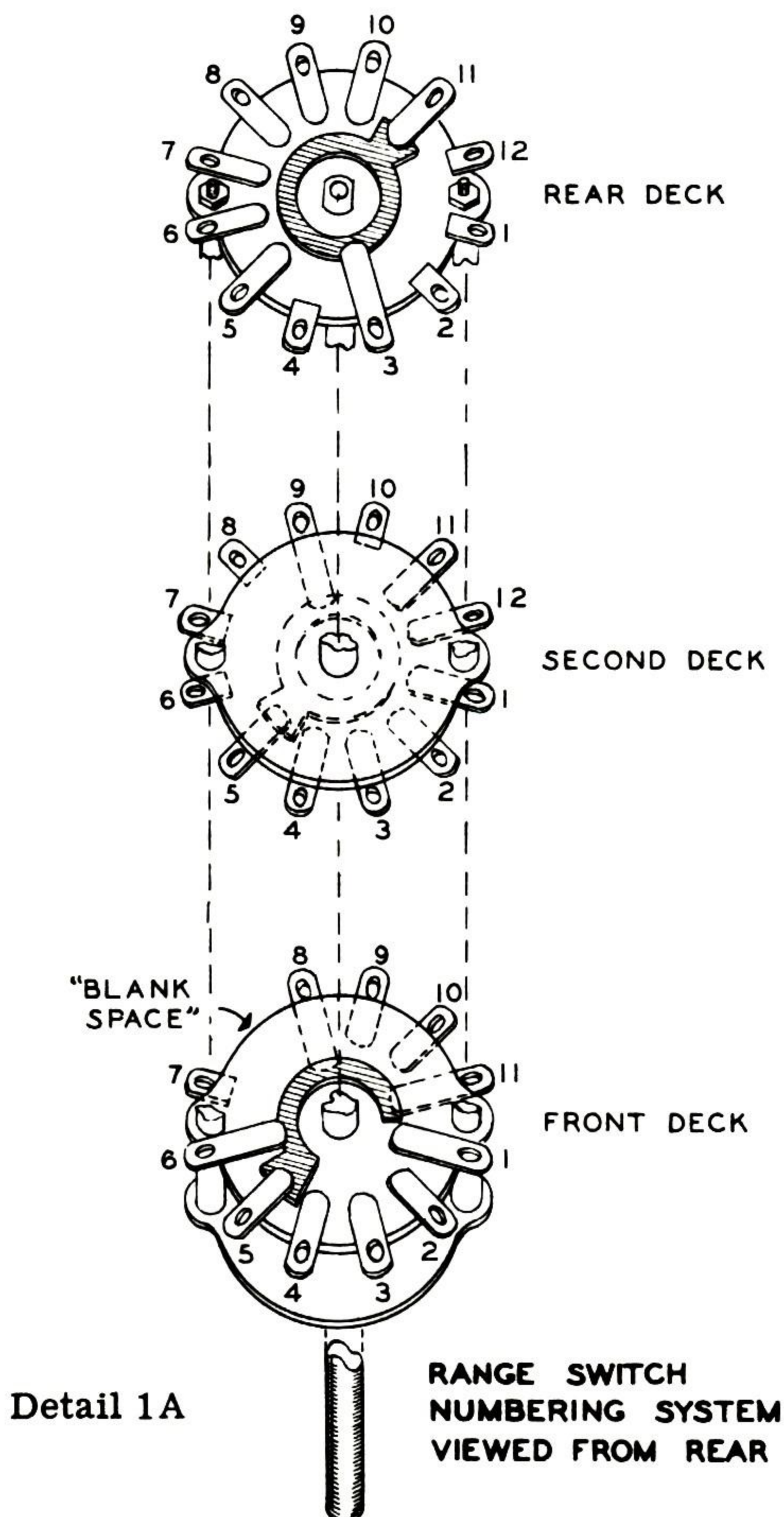

Refer to Detail 1B (fold-out from Page 11) for the following steps.

- () R7. Connect a 320 K Ω precision resistor between front deck lug 7 (NS) and the front deck lug 9 (NS), positioning the resistor body between the front deck and the detent plate as shown in Detail 1B. The detent plate is the metal plate at the front of the switch to which no lugs are attached.
- () R6. Connect a 900 K Ω precision 1 watt resistor (the larger of the two 900 K Ω resistors) between front deck lug 7 (NS) and front deck lug 11 (NS). Place the resistor between the front deck and the second deck so that the resistor does not touch the switch shaft. See Detail 1B.
- () R8. Connect a 150 K Ω precision resistor between second deck lug 7 (NS) and the front deck lug 9 (S-2). Place the resistor between the front deck and the second deck as shown in Detail 1B. The resistor should not touch the switch shaft.
- () R23. Connect a 10 K Ω precision resistor between second deck lug 7 (NS) and second deck lug 11 (NS). Use insulating sleeving on the lead to lug 11. Place the resistor between the front deck and the second deck as shown in Detail 1B. The resistor should not touch the switch shaft.
- () Cut a 2" hookup wire and strip 1/4" of insulation from each end. Connect this wire from front deck lug 7 (S-3) to front deck lug 10 (S-1).
- () R22. Connect a 20 K Ω precision resistor between second deck lug 11 (S-2) and rear deck lug 12 (NS).
- () Connect a 1-3/4" hookup wire between rear deck lug 12 (NS) and second deck lug 12 (S-1).
- () R21. Connect a 70 K Ω precision resistor from rear deck lug 12 (S-3) through second deck lug 1 (NS) to front deck lug 1 (S-1). Use sleeving on the lead to rear deck lug 12. The body of the resistor should be between the rear deck and the second deck.

- () R20. Connect a 200 K Ω precision resistor from second deck lug 1 (S-3) to rear deck lug 2 (NS).
- () Connect a 3" bare wire from rear deck lug 2 (NS) through second deck lug 2 (S-2) to front deck lug 2 (S-1).
- () R19. Connect a 700 K Ω precision resistor from rear deck lug 2 (S-3) through second deck lug 3 (NS) to front deck lug 3 (S-1). The body of the resistor should be between the rear deck and the second deck.
- () R18. Connect a 2 megohm precision resistor from second deck lug 3 (S-3) to rear deck lug 4 (NS).
- () Connect a 3" bare wire from rear deck lug 4 (NS) through second deck lug 4 (S-2) to front deck lug 4 (S-1).
- () R17. Connect a 7 megohm precision resistor from rear deck lug 4 (S-3) through second deck lug 5 (S-2) to front deck lug 5 (NS). The body of the resistor should be between the rear deck and the second deck.
- () R25. Connect a 9 megohm precision resistor from rear deck lug 5 (S-1) to second deck lug 6 (NS).
- () Connect a 1-3/4" hookup wire from rear deck lug 6 (S-1) to second deck lug 6 (NS).
- () R26. Connect a 900 K Ω precision resistor from rear deck lug 7 (NS) to second deck lug 6 (S-3). Use sleeving on both leads.
- () R27. Connect a 90 K Ω precision resistor from rear deck lug 7 (S-2) to second deck lug 8 (NS).
- () Connect a 1-3/4" bare wire from rear deck lug 8 (S-1) to second deck lug 8 (NS).
- () R28. Connect a 9 K Ω precision resistor from rear deck lug 9 (NS) to second deck lug 8 (S-3).
- () R29. Connect a 900 Ω precision resistor from rear deck lug 9 (S-2) to second deck lug 10 (NS).
- () Connect a 1-3/4" bare wire from rear deck lug 10 (S-1) to second deck lug 10 (NS).
- () R30. Connect a 90 Ω precision resistor from rear deck lug 11 (NS) to second deck lug 10 (S-3).
- () R31. Connect a 9.1 Ω precision resistor (white-brown-gold-gold) from rear deck lug 11 (S-2) to rear deck lug 1 (NS). Refer to Detail 1B for the position of the resistor body.

This completes the resistor wiring on the Range switch. Before temporarily setting it aside, recheck the entire procedure. Check all resistor leads and bare wires for possible shorting. Visually inspect all solder connections from every angle to make sure a good solder connection has been made. Make sure excess solder has not flowed over to short adjacent connections. Shake out all loose pieces of solder and wire trimmings. At this time no connections have been made at front deck lug 6 and lug 8, second deck lug 9, and rear deck lug 3. The connections made at front deck lug 5 and lug 11, second deck lug 7, and rear deck lug 1 have not yet been soldered.

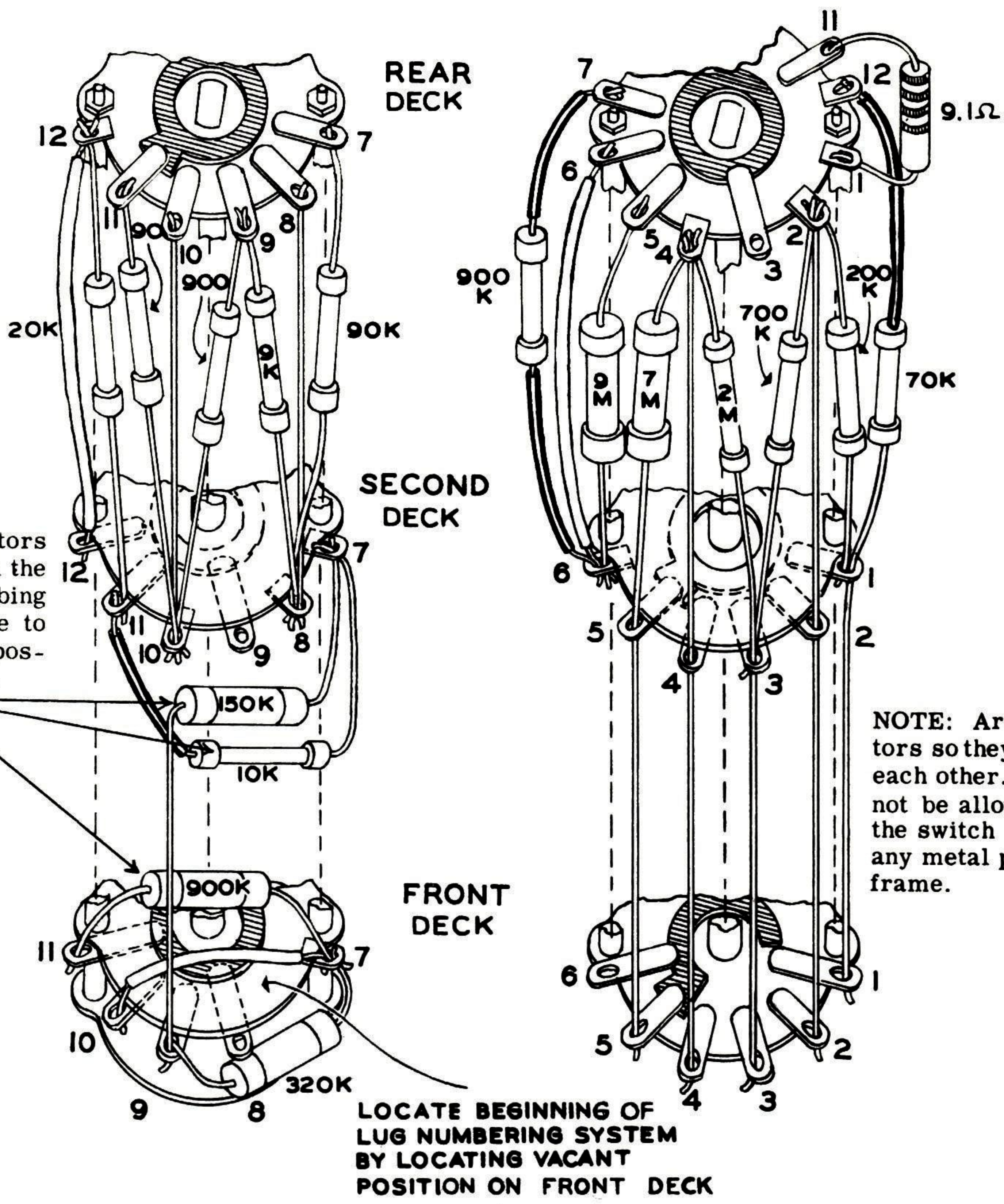

RANGE SWITCH DETAIL

Detail 1B

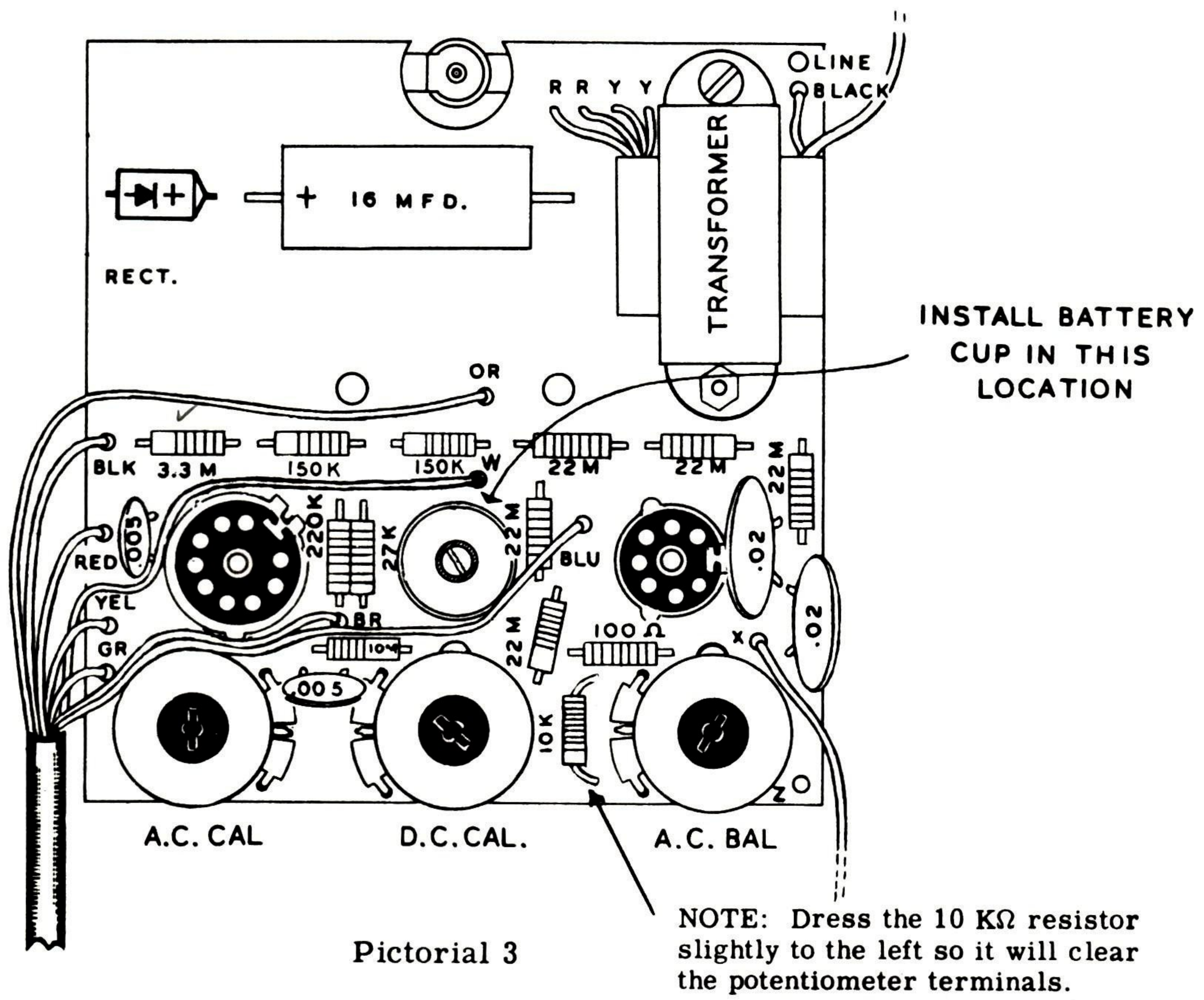

Pictorial 3

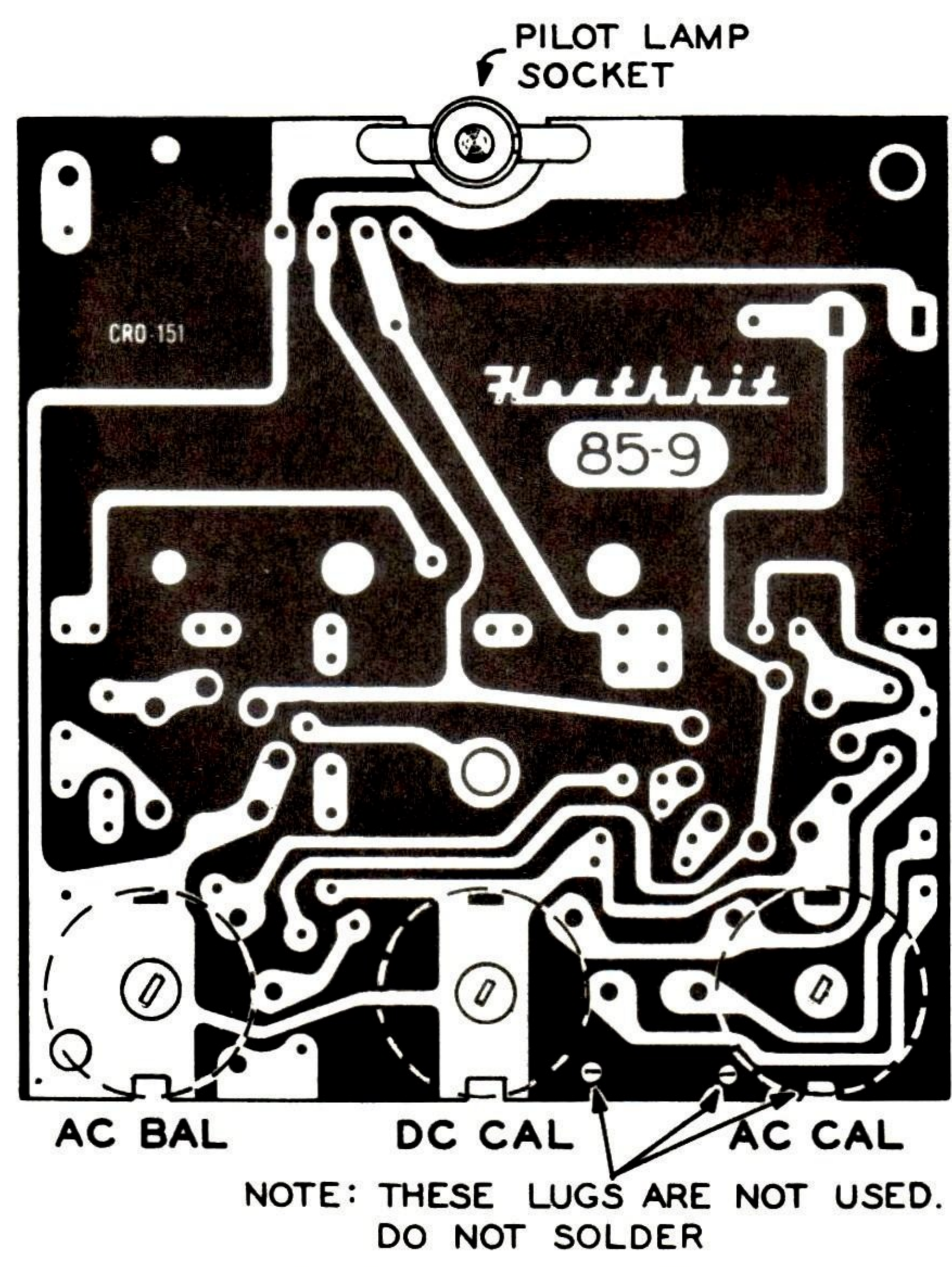

Detail 3D

PLACEMENT OF CONTROLS

FRONT PANEL MOUNTING

Refer to Pictorial 1 for the following steps.

- () Mount the phone jack on the back of the front panel at position P. Orient the lugs as shown in Pictorial 1. Use a control lockwasher, a control flat washer, and a control nut, as shown in Detail 1C.

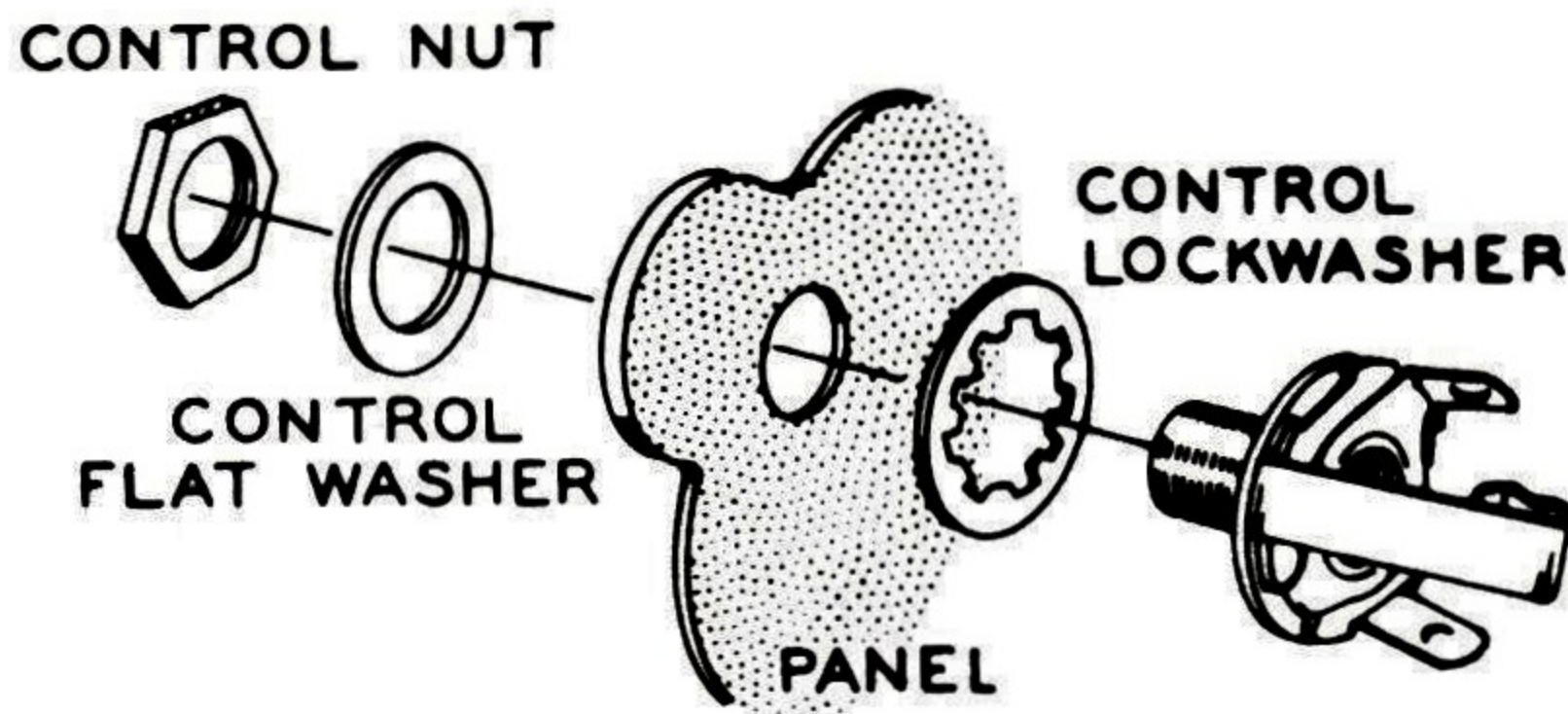

Detail 1C

- () R1, R2. Similarly, mount 15 K Ω controls at positions O and Z. Use control lockwashers, control flat washers, and control nuts. Orient the lugs of the controls as shown in Pictorial 1.
- () Temporarily, mount the Range switch (#63-79) using a control lockwasher, control flat washer, and a control nut. Orient the switch as shown in Pictorial 1. Do not tighten the nut permanently.
- () Similarly, mount the Function switch (#63-80) as shown in Pictorial 1.

Detail 1D

- () Turn the panel around so that the front faces you. Turn the shaft of the Range switch fully counterclockwise. The "flat" on the shaft should now be lined up next to the 1500 V position marked on the front panel. Mount one of the control knobs on the shaft by tightening the setscrew in the knob. The setscrew should bear down on the flat of the shaft.
- () The control knob indicator line should now point exactly to the 1.5 V position marked on the front panel. If it does not, align the indicator line exactly with the 1.5 V position by grasping the range switch body in back of the panel and gently turning it. When the indicator line is aligned, remove the control knob and permanently tighten the control nut, being careful not to turn the body of the Range switch. Now replace the control knob and retighten the setscrew.
- () Using a similar procedure, install the control knob on the Function switch and orient the switch body. With the shaft of the switch turned fully clockwise, the indicator line should rest in the OHMS position indicated on the front panel.

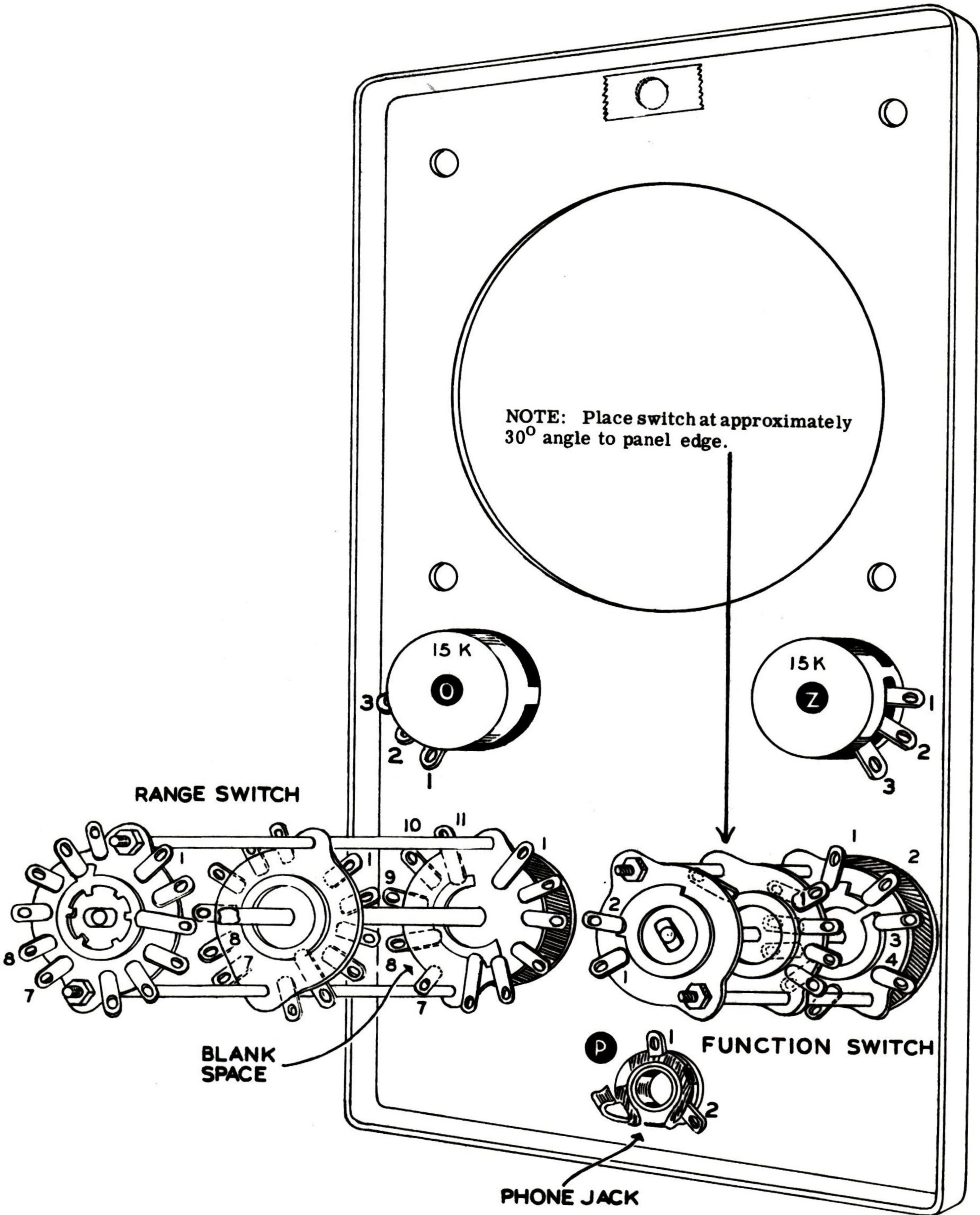

Pictorial 1

FRONT PANEL WIRING

Study the Function switch numbering system as shown in Detail 2A. The front deck of the switch is the wafer closest to the front panel.

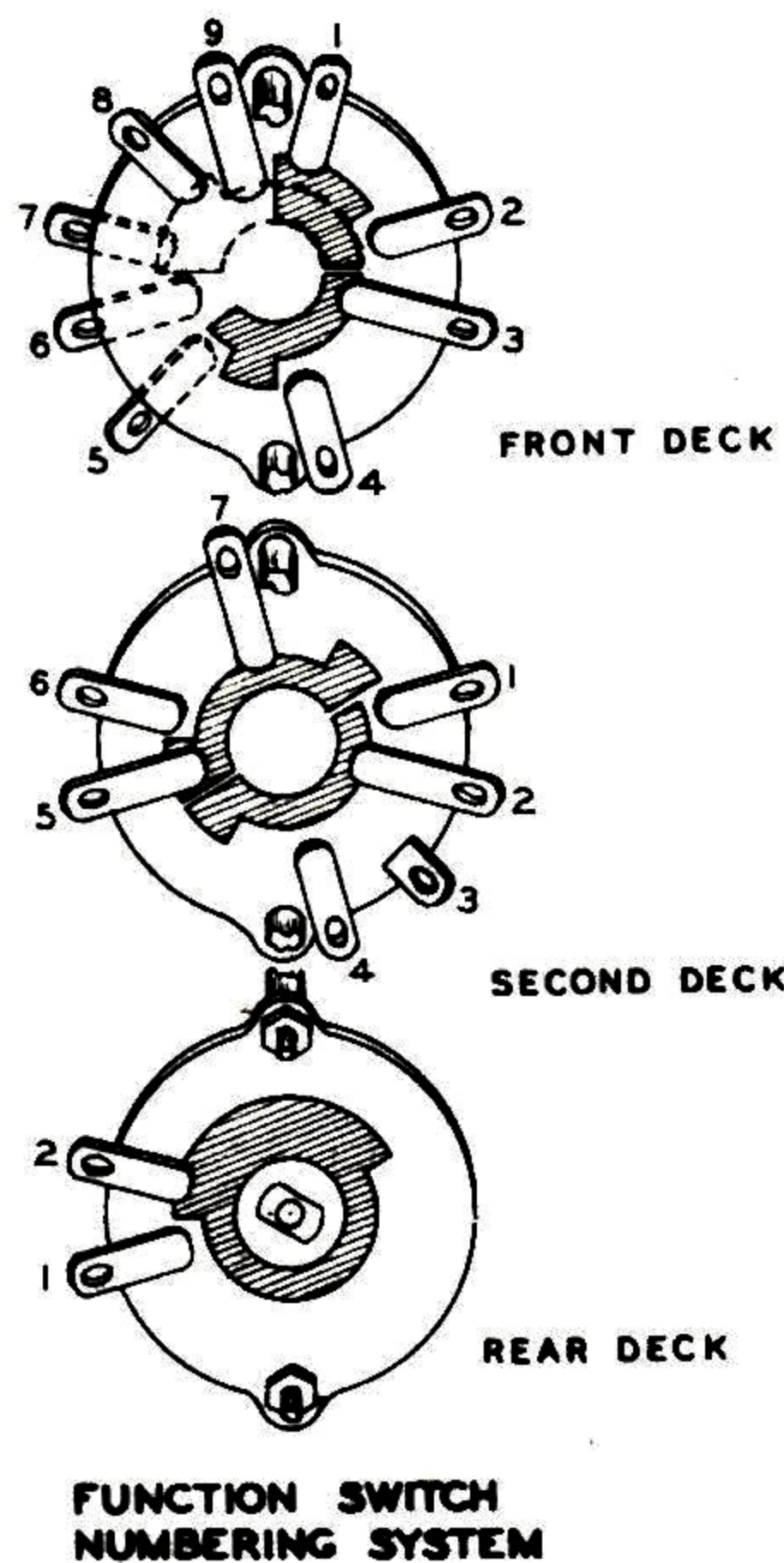

Detail 2A

Refer to Pictorial 2 for the following steps.

- () C2. Connect a .047 μ fd 1600 volt capacitor from the Range switch front deck lug 11 (S-2) to Function switch front deck lug 4 (S-1), using sleeving on both leads. The banded end goes to the Function switch. The capacitor body should be placed flush with the front panel between the Range switch and the Function switch as shown in Pictorial 2. Avoid using excessive solder, since both leads carry high voltage.
- () Connect a 3-1/2" hookup wire from lug 3 of control O (S-1) to Function switch second deck lug 6 (S-1).
- () Connect a 5-1/2" hookup wire from lug 2 of control O (S-1) to lug 1 of control Z (NS). Place the wire close to the front panel.
- () Connect a 2-1/4" hookup wire from lug 3 of control Z (S-1) to Function switch second deck lug 7 (NS).
- () Connect a 1-1/4" hookup wire from Function switch front deck lug 5 (NS) to lug 2 of phone jack P (S-1). Use sleeving over the entire length of this wire. Avoid using excessive solder, since this wire carries high voltage.
- () Connect a 1-3/4" hookup wire from Function switch front deck lug 6 (S-1) to Range switch front deck lug 5 (S-2).
- () Connect a 4" hookup wire from Function switch front deck lug 8 (S-1) to Range switch second deck lug 9 (S-1).
- () Connect a 3-1/4" hookup wire from Function switch front deck lug 1 (S-1) to Range switch front deck lug 6 (S-1).
- () Connect a 2-1/2" hookup wire from Function switch front deck lug 3 (S-1) to Function switch front deck lug 5 (S-2). Use sleeving over the entire length of this wire. Avoid using excessive solder since this wire carries high voltage.
- () Connect a 4-3/4" hookup wire from Function switch second deck lug 3 (NS) to Range switch front deck lug 8 (S-1).
- () Connect a 2-3/4" hookup wire from Range switch second deck lug 7 (S-3) to lug 1 of phone jack P (NS).
- () Connect a 5-1/2" hookup wire to lug 1 of phone jack P (NS). Leave the other end free for connection later.
- () Connect a 5-1/2" hookup wire to lug 1 of phone jack P (S-3). Leave the other end free for connection later.
- () Connect a 6" hookup wire from lug 3 of the range switch rear deck (S-1), to lug 2 of the function switch front deck (S-1).

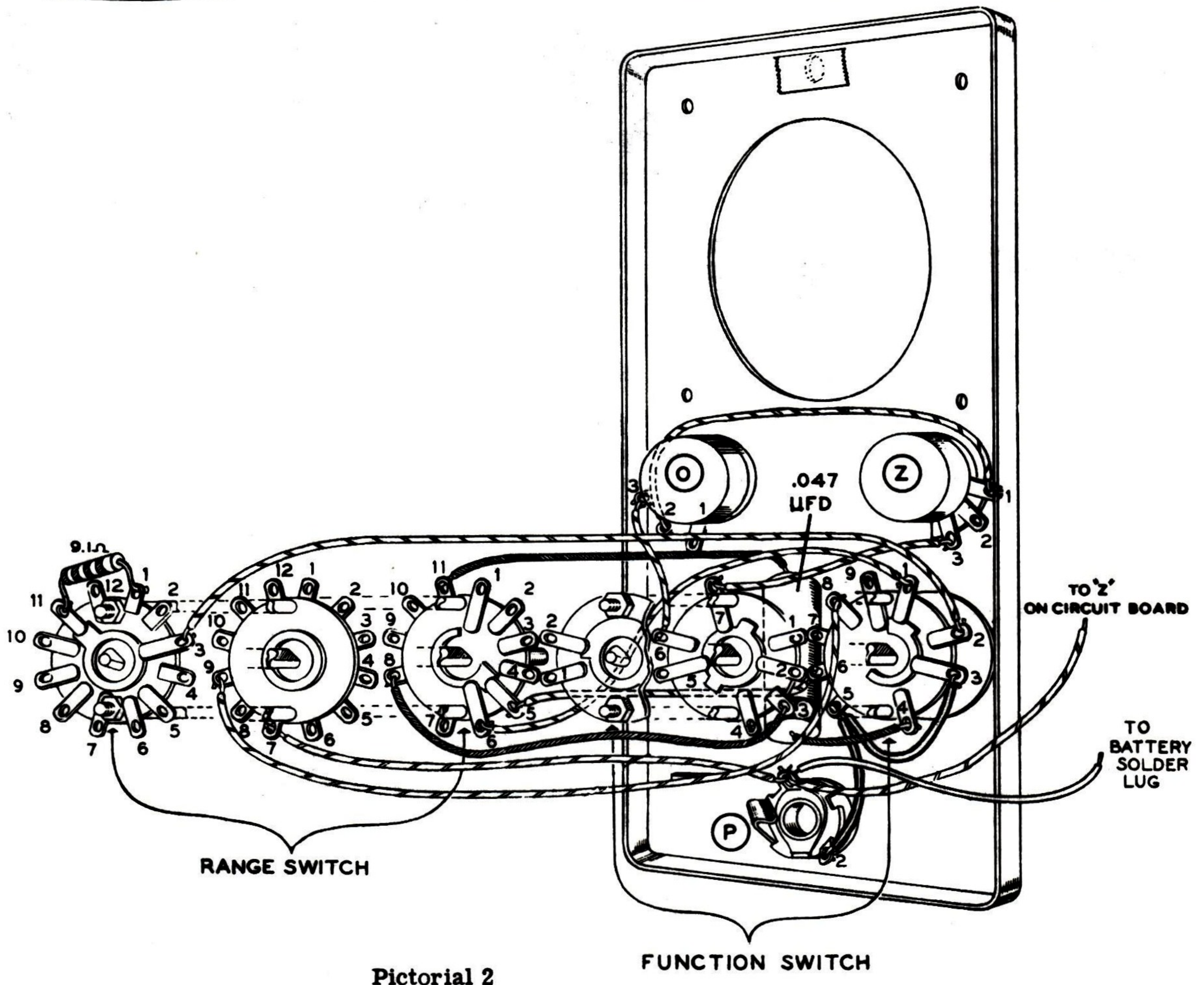

Pictorial 2

CIRCUIT BOARD WIRING

The printed circuit board is virtually self-explanatory regarding the assembly procedure. The lettered side of the board clearly indicates the location of components and cable wiring. The use of such a circuit board saves a great deal of assembly time and minimizes the possibility of error.

Groups of components are mounted at one time with the body of each component on the lettered side; then the circuit board is turned over and all the connections are soldered at one time. A connection is first heated and then solder is applied. The connection is allowed to cool off. The excess lead length is then clipped off close to the circuit board.

Generally speaking, the same soldering techniques with which you are already familiar will apply to the circuit board. It is recommended, however, that a smaller soldering iron with a very small tip be used. A soldering pencil is ideal for circuit board work. Irons in the range of 25 or 50 watts are entirely adequate. Quick heating solder guns can be used but some precaution should be observed regarding the possibility of overheating. Overheating will damage the copper foil or the board itself. Should the circuit board become overheated, it will be immediately evident by distinctly audible "frying" or "crackling" sounds. When making pressure fit connections on sockets and controls, be careful not to bend or crack the circuit board itself. Refer to Detail 3A for the proper mounting and soldering procedures. Be careful not

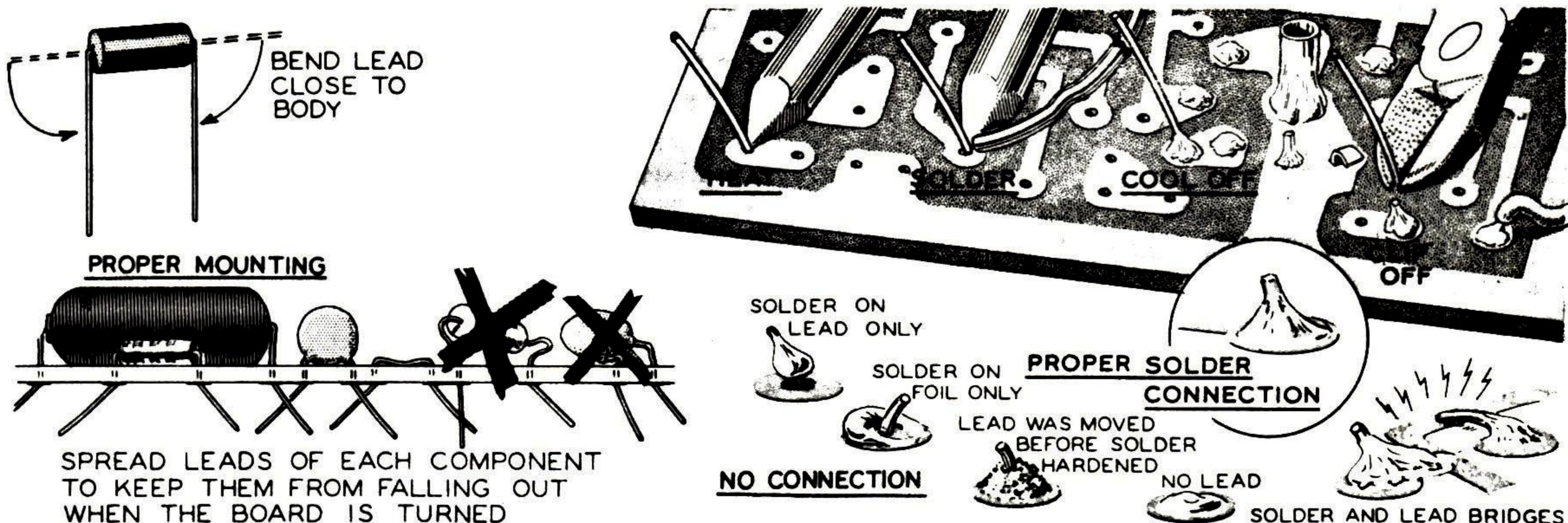

Detail 3A

to cause a "solder bridge" short circuit between two parts of the printed circuit by using excess solder.

- () Using diagonal wire cutters, clip off lug 6 of the 7-pin tube socket. To locate lug 6, count clockwise from the blank space on the bottom of the socket. See Detail 3B.
- () Properly orient the 7-pin socket and install it through the lettered side of the board in the smaller of the two socket locations, as shown in Pictorial 3. Refer to Detail 3B for the mounting procedure. Be sure the lug hooks are seated in the holes before pressing down on the socket.
- () Turn the board over and solder the socket pins to the circuit board foil.
- () Install the 9-pin socket and solder the socket pins to the circuit board foil. Do not clip off any of the pins of the 9-pin socket. Refer to Pictorial 3 (fold-out from Page 12) for the following steps.
- () R24. Install a 3.3 megohm (orange-orange-green) resistor in the position designated on the lettered side of the circuit board. Bend the leads at right angles to the resistor body. Insert the leads in the correct holes and

spread the leads slightly as shown in Detail 3A so that the resistor will not drop out of position when the board is turned over for soldering. All of the remaining circuit board resistors will be mounted before they are soldered.

- () R34. Install a 220 KΩ (red-red-yellow) resistor in position on the circuit board.
- () R33, R35. Install two 150 KΩ (brown-green-yellow) resistors.
- () R16. Install a 27 KΩ (red-violet-orange) resistor.
- () R32. Install a 10 megohm (brown-black-blue) resistor.
- () R9, R10, R11, R12, R13. Install five 22 megohm (red-red-blue) resistors in the five positions shown.
- () R15. Install a 100 Ω (brown-black-brown) resistor.
- () R14. Install a 10 KΩ (brown-black-orange) resistor. Position the 10 KΩ resistor slightly toward the center of the circuit board so that it will clear the AC Balance control terminals, as shown in Pictorial 3.

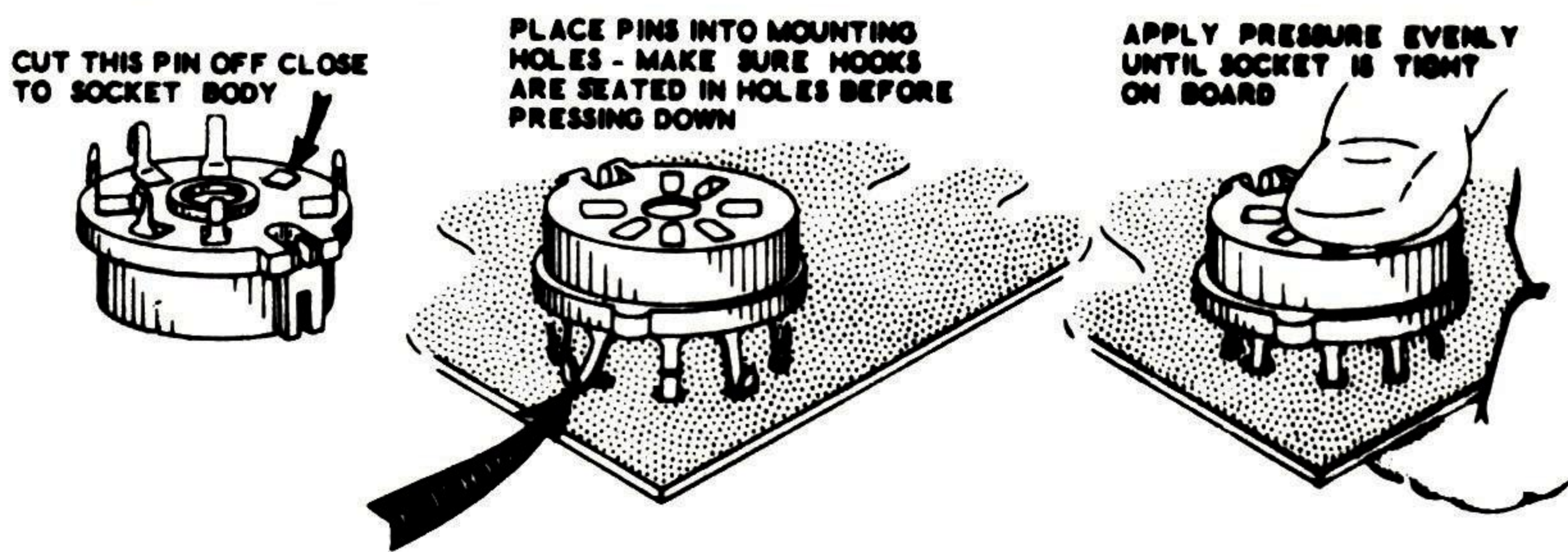

Detail 3B

Check all the resistors for snug positioning against the board. Now turn the circuit board over, solder each lead and trim off the excess lead close to the board surface as shown in Detail 3A. Carefully check each connection after clipping the leads, to make sure a good solder connection has been made.

- () Mount the battery cup in position on the lettered side of the circuit board. Use a 6-32 x 3/8" screw, #6 fiber shoulder washer, #6 lockwasher, and 6-32 nut, as shown in Detail 3C.

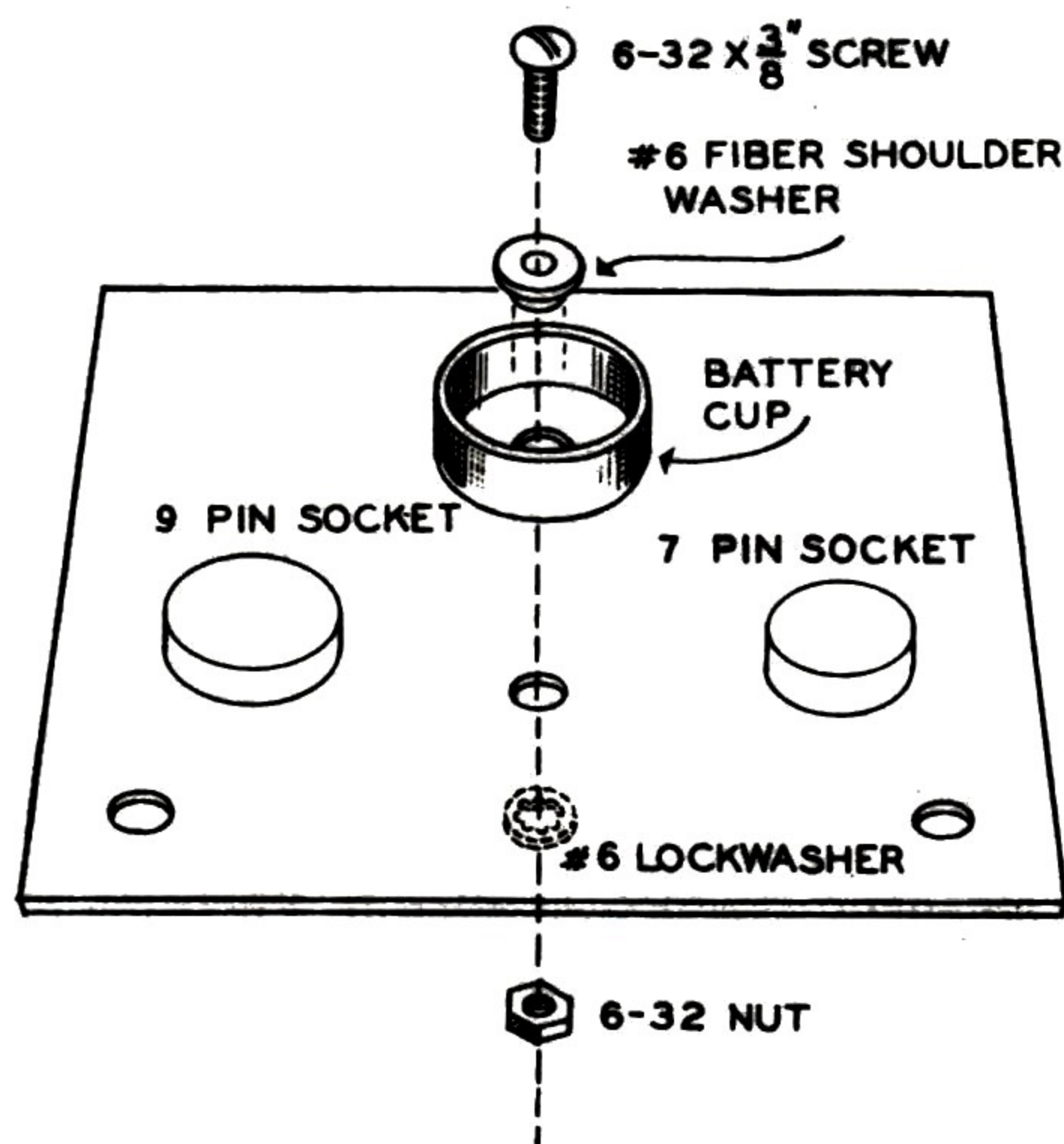

BATTERY CUP MOUNTING ON LETTERED SIDE OF
CIRCUIT BOARD

Detail 3C

- () R3, R4, R5. Mount the three 10 K Ω controls (AC CAL, DC CAL, and AC BAL) on the lettered side of the circuit board so that the mounting lugs and terminals protrude through to the foil side. Refer to Pictorial 3 and Detail 3D. Hold the controls firmly against the board and solder the mounting lugs and terminals directly to the foil pattern. Notice that the three lugs which do not connect to the foil pattern are not soldered, as mentioned in the note in Detail 3D (on fold-out from Page 12).
- () Mount the silicon rectifier on the circuit board, in the position shown in Pictorial 3.

Be sure to align the positive (+) end of the rectifier as shown, and solder the leads to the foil. Clip off the excess leads close to the foil.

- () Mount the power transformer (#54-23) as shown in Pictorial 3. Use two 6-32 x 3/8" screws, two #6 lockwashers, and two 6-32 nuts. Do not tighten the upper mounting screw permanently. The pair of black transformer leads must be on the right side of the circuit board. Notice that the 6-32 screw closest to the tube sockets is inserted from the foil side of the board with the nut attached on the lettered side. This is done to insure adequate clearance for the plastic meter housing after the board is installed in the instrument.
- () The transformer leads are precut to their proper lengths. Insert the two yellow transformer leads in the holes marked Y and the two red transformer leads in the two holes marked R. The shorter black transformer lead is inserted in the hole marked BL. Solder these five leads to the foil side of the board and clip off the excess leads. The longer black transformer lead is not connected at this time.
- () C5, C6. Mount and solder the two .005 μ fd disc ceramic capacitors in their places as shown in Pictorial 3.
- () C3, C4. Mount and solder the two .02 μ fd disc ceramic capacitors in their places as shown in Pictorial 3.
- () C1. Mount and solder the 16 μ fd 150 V electrolytic capacitor as shown in Pictorial 3. Be careful to align the positive (+) end of the electrolytic capacitor adjacent to the rectifier.
- () Mount and solder the pilot lamp socket in the location shown in Pictorial 3. The screw threads on the pilot lamp socket protrude from the foil side of the circuit board. Solder the lugs directly onto the foil.

CONNECTING CABLE

- () Locate the 12" length of 8-wire, color coded cable. Measure 5" from one end of the cable and carefully remove the cable sheathing by making a circular cut with a small sharp knife and then slipping the cable sheathing off. Be careful not to cut the internal wires or their insulation.

Measuring from the cut end of the sheath, cut the wires to the following lengths:

<u>COLOR</u>	<u>LENGTH</u>
() Green	1/2"
() Yellow	3/4"
() Red	1-1/4"
() Black	1-3/4"
() Brown	2"
() White	3"
() Blue	4"
() Orange	4-1/4"

- () Carefully remove 3/16" of insulation from the end of each wire. Twist the fine wire strands lightly together and insert the color coded wires in their respective openings in the lettered side of the circuit board, as shown in Pictorial 4. The actual color code abbreviations used on the back of the circuit board are as follows: Black (BL), red (R), yellow (Y), green (G), orange (OR), blue (B), white (W), brown (BR). Solder each wire to the foil circuit as it is inserted. Clip off any excess wire on the wire strands and avoid making solder bridges to other parts of the foil circuit. Place the blue wire between the battery clip and the DC BAL control.
- () Solder one end of a 4" hookup wire to point X on the circuit board. See Pictorials 3 and 4. The other end of the wire is not connected at this time.

The circuit board is now completely assembled and is ready for installation.

WIRING CIRCUIT BOARD TO THE PANEL

- () Measure 4" back from the free end of the 8-wire cable and remove the sheathing, being careful not to cut the internal wires or their insulation. Do not cut the green and blue wires, but cut 1" from the ends of the remaining six wires. Remove 1/4" insulation from the ends of all eight wires.

To make the wiring as easy as possible, the cable wires will be connected to the front panel assembly before the circuit board is mounted.

Refer to Pictorial 4 (fold-out from Page 21) for the following steps.

- () Connect the orange wire to Function switch front deck lug 7 (S-1).
- () Connect the black wire to Function switch front deck lug 9 (S-1).
- () Connect the white wire to lug 2 of control Z (S-1).
- () Connect the red wire to lug 1 of control Z (S-2).
- () Connect the brown wire to Function switch second deck lug 7 (S-2).
- () Connect the yellow wire to Function switch second deck lug 1 (S-1).
- () Connect the green wire to Function switch second deck lug 4 (S-1).
- () Connect the blue wire to Range switch rear deck lug 1 (S-2).

This completes the circuit board wiring to the front panel.

MOUNTING THE BATTERY SPRING

- () Install the large battery holder spring on the bracket as shown in Detail 5A. Use the 6-32 x 1/4" screw, #6 lockwasher, #6 solder lug, and 6-32 nut. The lockwasher and nut should be on the inner side of the bracket, inside the spring. Otherwise the body of this screw will protrude through the back of the completed VTVM. Position the solder lug so that it does not obstruct the other hole in the bracket. Long-nose pliers should be used to hold the nut while the screw is tightened.

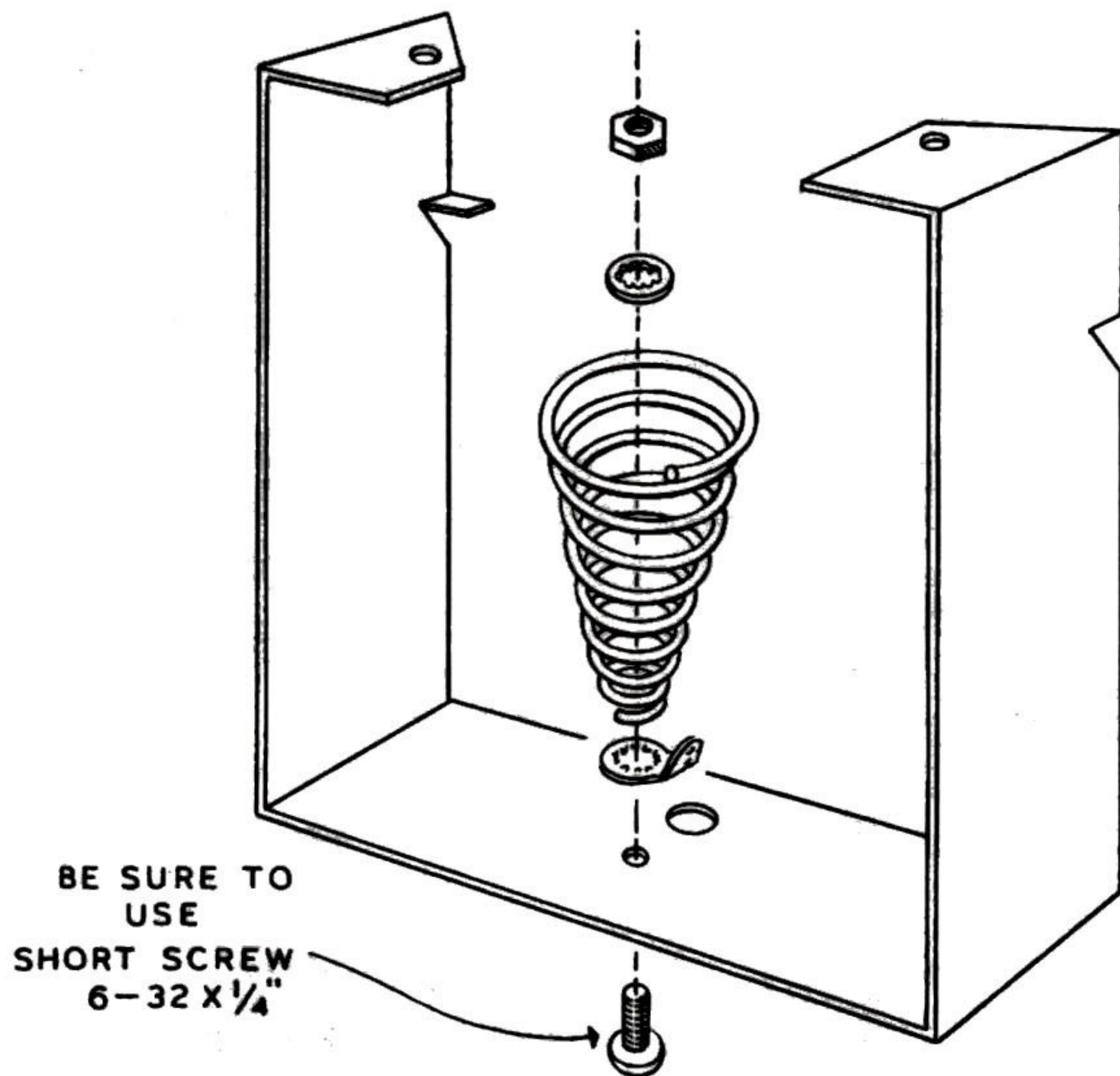

METHOD OF ASSEMBLING BATTERY SPRING TO BRACKET

Detail 5A

METER, BRACKET, AND CIRCUIT BOARD INSTALLATION

() Before installing the meter, it is necessary to remove the solder lugs on the meter terminals. On each terminal hold the lower nut with long-nose pliers while loosening the upper nut with a 3/8" socket wrench or another pair of pliers. **DO NOT PERMIT THE THREADED TERMINAL STUD TO TURN.** Next, tighten the remaining nuts snugly against the meter stud speednut on the back of the meter, using finger pressure only. Again, be sure that the stud itself does not turn.

NOTE: While mounting the meter to the panel, be sure to use a soft cloth on the workbench surface to avoid scratching the plastic meter housing.

() Insert the four meter mounting screws in the holes in the front panel. Looking at the panel from the rear, fasten the upper left meter mounting screw to the panel using a 6-32 nut and #6 lockwasher, packed in the meter box. Only this nut should be installed at this time.

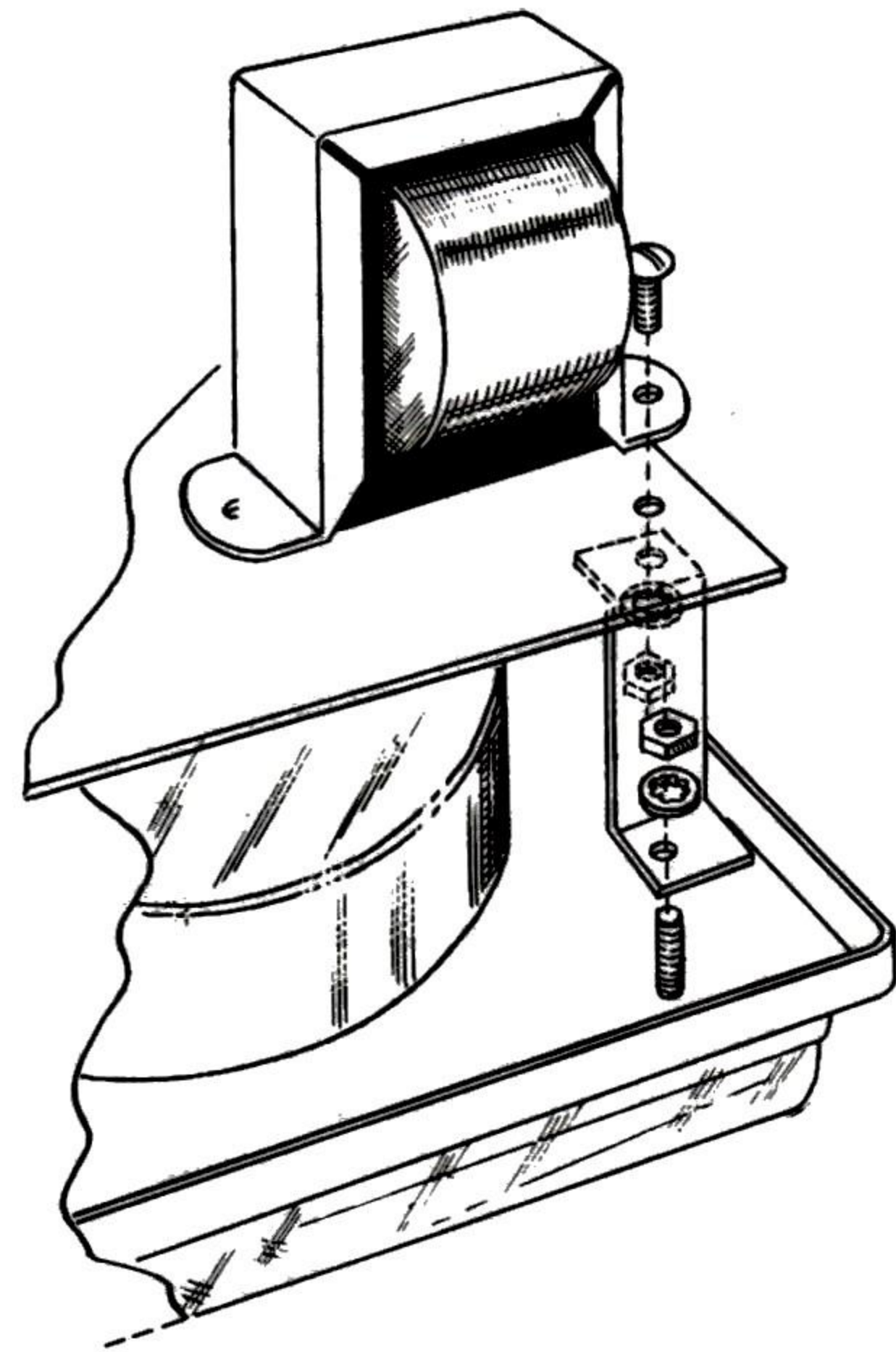

Detail 5B

- () Mount the Z bracket on the upper right meter mounting screw as shown in Detail 5B, using the meter mounting hardware. Note the orientation of the off-center holes in the Z bracket.
- () Install the large bracket on the two lower meter mounting screws as shown in Pictorial 5, using the meter mounting hardware. **NOTE:** The bracket must straddle the cable. As the mounting nuts are being tightened, lightly pinch together the two legs of the bracket to insure adequate clearance between the legs and the panel edge.
- () Screw the pilot lamp into the pilot lamp socket at the top of the circuit board. Slip the 1-1/4" length of 3/8" diameter fiber glass sleeving over the pilot lamp and socket.
- () Remove the 6-32 hardware at the top transformer mounting lug. Refer to Detail 5B. Temporarily set aside this hardware.

() Place a #10 fiber washer over each of the two meter terminal studs. Slip the circuit board between the bracket legs so that the meter stud terminals pass through the mounting holes in the circuit board. The bottom edge of the circuit board will now rest on the two small flanges at the notches in the bracket legs. Replace the two solder lugs and the meter stud nuts over the meter stud terminals, marked M1 and M2 in Pictorial 5. Orient the lugs as shown in Pictorial 5 and very lightly tighten the nuts. Bend the lugs slightly away from the circuit board to facilitate soldering later.

() Align the circuit board so that its edges are parallel to the panel edges and completely clear each side. Now bend the Z bracket toward the right side of the panel and slightly crimp the top of the Z bracket so that its top mounting hole lines up with the top mounting hole of the transformer on the circuit board, and the top of the Z bracket lies flush against the circuit board. Replace the 6-32 hardware in the top transformer mounting lug, securing the transformer and circuit board to the Z bracket, as shown in Detail 5B.

() Now tighten the nuts over the meter stud terminals firmly but not excessively. Also tighten the 6-32 transformer mounting hardware to the Z bracket.

FINAL WIRING

Refer to Pictorial 5 for the following steps.

- () Connect the hookup wire from location X on the circuit board to Function switch second deck lug 3 (S-2).
- () Connect either hookup wire from lug 1 of phone jack P to circuit board location Z (S-1).
- () Connect the remaining hookup wire from lug 1 of phone jack P to the solder lug under the battery spring on the large bracket (S-1).
- () Connect a 6-1/4" hookup wire from M1 (S-1) to Function switch second deck lug 5 (S-1).
- () Connect a 6" hookup wire from M2 (S-1) to Function switch second deck lug 2 (S-1).

() Separate the two wires of the line cord to a point approximately 5" from the end. Cut 2" from the end of one of these wires. Strip 3/8" insulation from the end of the cut wire and lightly tin both wires. ("Tin" means melt a small amount of solder over the exposed wire strands.)

() Clamp the line cord strain relief onto the line cord about 6" back from the end of the longer wire as shown in Detail 5C. Insert the line cord and strain relief through the hole in the top of the bracket as shown in Pictorial 5 and Detail 5C.

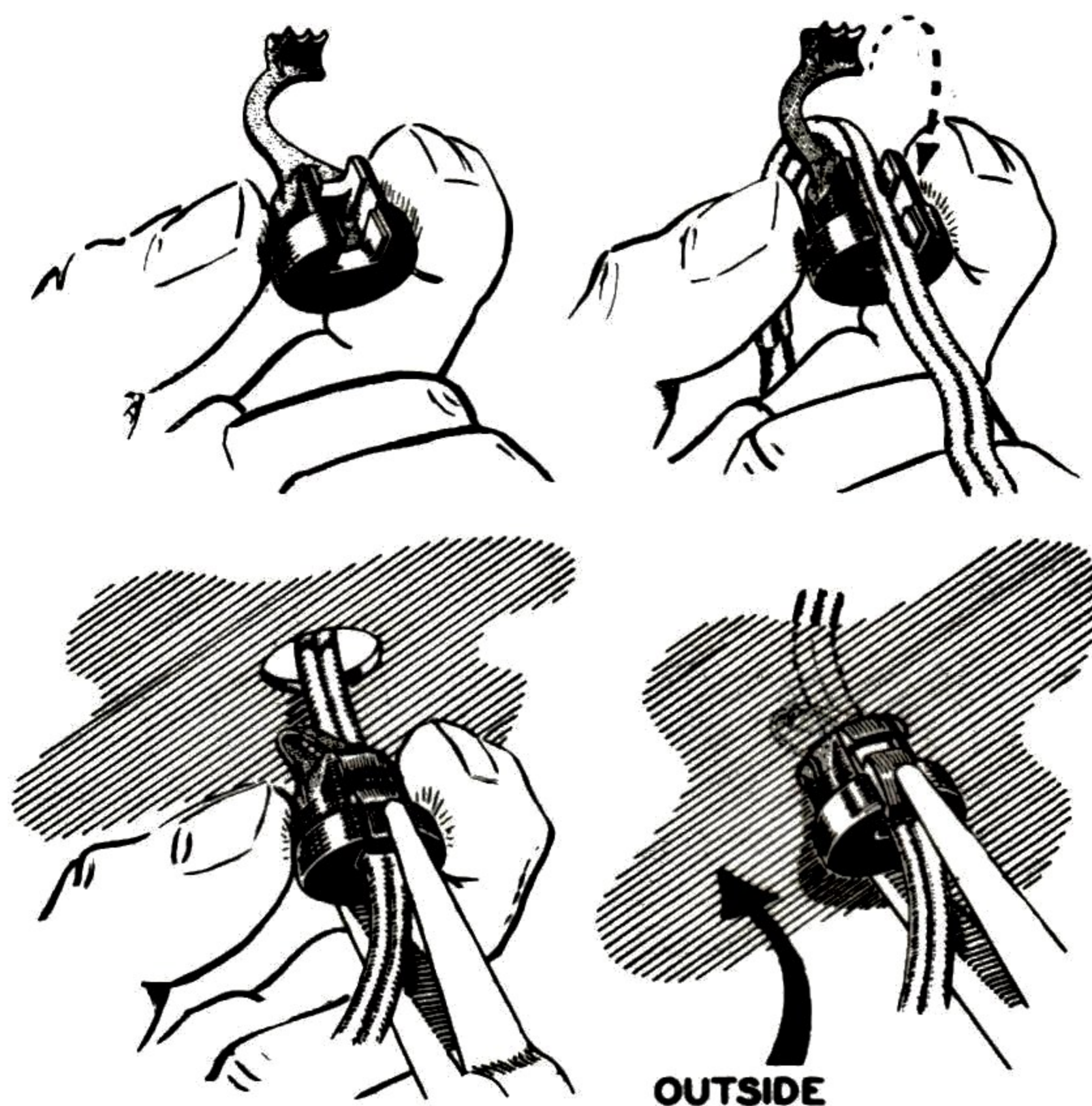

Detail 5C

- () Connect the shorter line cord wire to Function switch rear deck lug 2 (S-1).
- () Solder the longer line cord wire to the position marked "line" in the upper right-hand corner of the circuit board, near the transformer (S-1).
- () Connect the remaining long black transformer lead to Function switch rear deck lug 1 (S-1).
- () Install the 6AL5 tube and 12AU7 tube in their respective sockets as shown in Pictorial 6. Be careful not to damage the tube prongs when inserting them into their sockets.

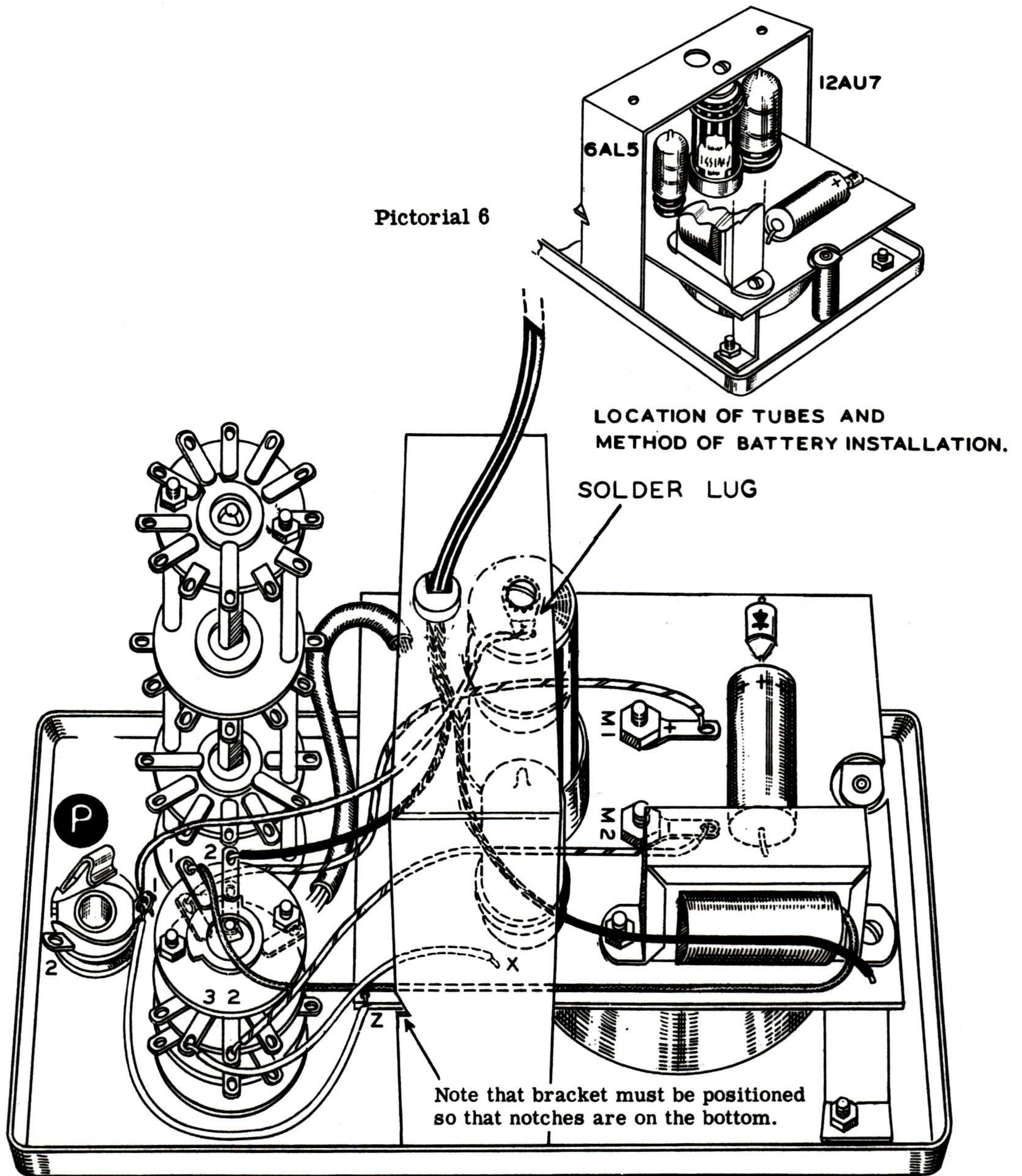

METHOD OF CIRCUIT BOARD INSTALLATION AND DRESS OF 8 WIRE CABLE.

Pictorial 5

- () Fasten the handle on the cabinet, using two #10 x 1/2" sheet metal screws. the bottom of the cabinet.
- () Push the rubber feet into the four holes in Do not install the battery at this time.

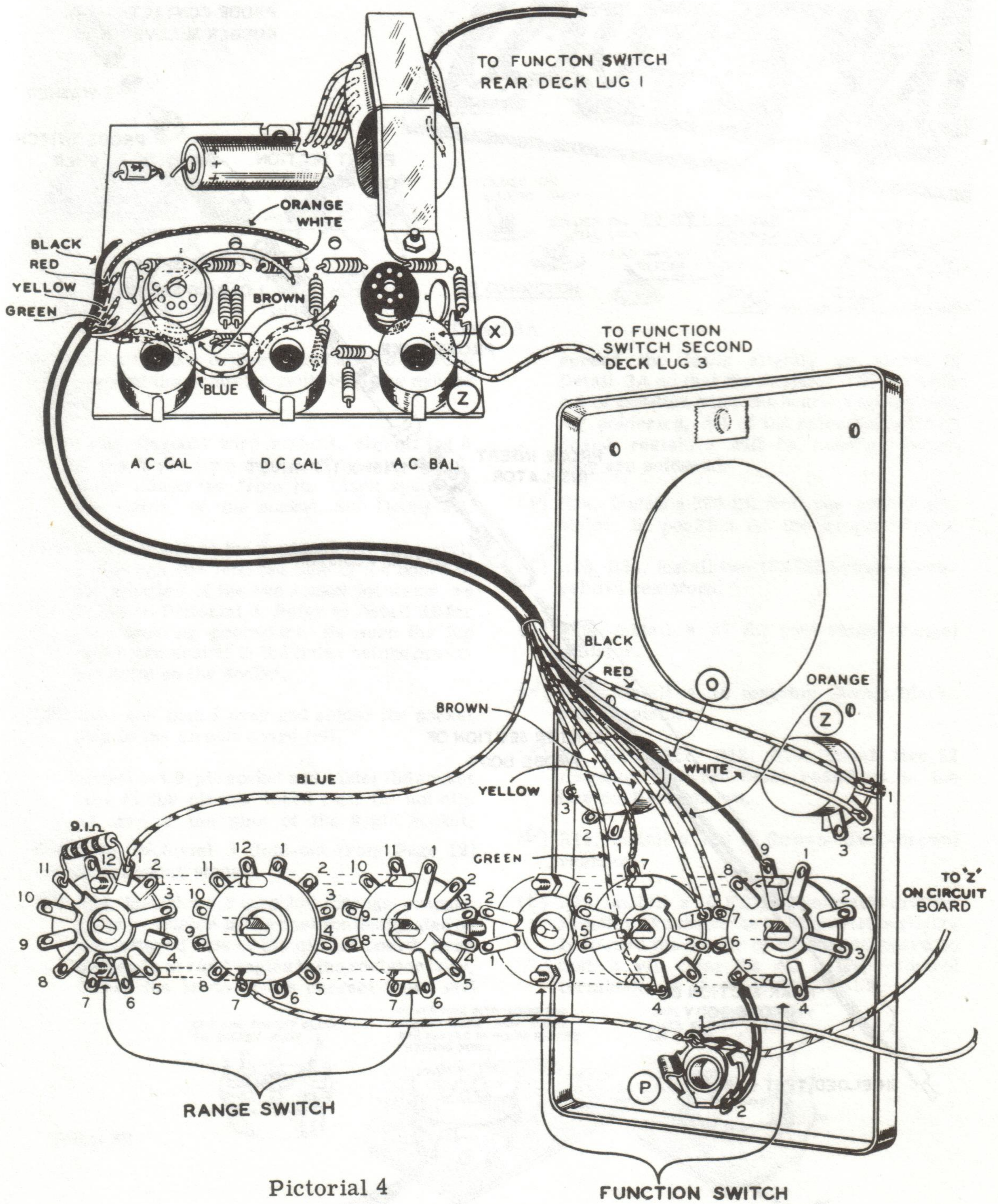

Pictorial 4

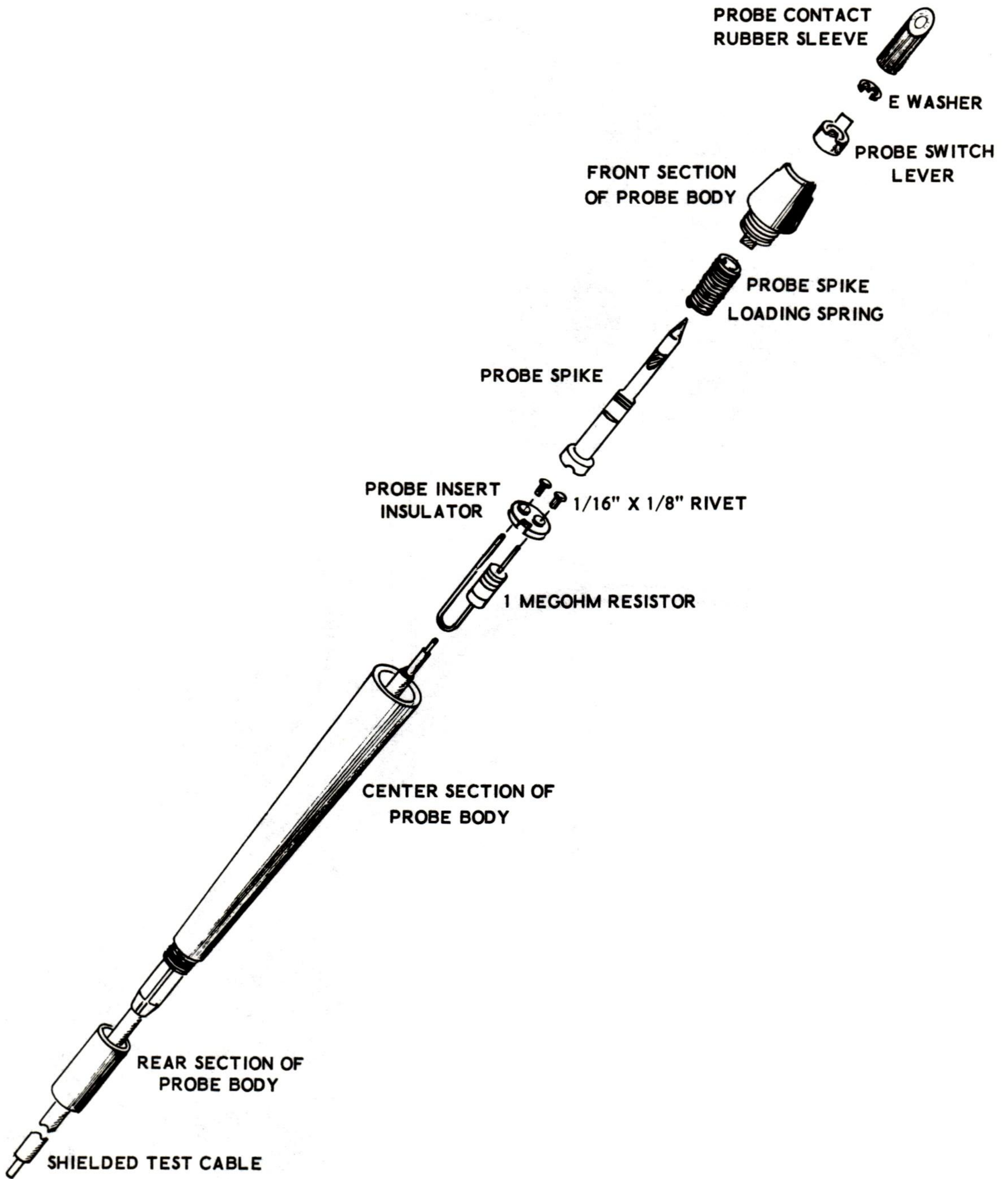

PRELIMINARY TEST

Carefully inspect the instrument and check the "dress" (or arrangement) of all wiring. Be sure the wiring and components are not positioned in such a way that short circuits may occur. Check all solder connections. Gently shake out all loose wire clippings, insulation, and other debris that may have accumulated during the assembly of the instrument.

Plug the VTVM line cord into a 117 volt 60 cps AC source. Turn the Function knob to the DC+ or DC- position and the Range switch to the 1.5 V position. The tubes and pilot lamp should light within 15 to 20 seconds of warmup time. There should be some degree of ZERO ADJ control action which will permit the meter pointer to deflect over a limited range of the dial. During the preliminary test warmup, check the instrument assembly very carefully for any indication of overheating. Assuming that the instrument will respond in the manner indicated, it will be safe to leave it turned on to thoroughly warm up while the balance of the kit project is completed. This will consist of test probe preparation and cabinet assembly.

PREPARATION OF TEST PROBE AND LEADS

NOTE: Read all the remaining assembly steps and familiarize yourself with the completed assembly and parts before proceeding.

- () If necessary, remove any "flash" or sharp edge on the insert insulator with a file or penknife.
- () R36. Locate the two small rivets, the probe insert insulator, and the 1 megohm (brown-black-green) resistor shown in Detail 7A. Insert the rivets into the holes in the insulator so that the head of each rivet rests on the small shoulder around the hole in the insulator. Now turn the insulator over and lay it flat on the workbench.
- () Cut one resistor lead to $3/8$ ". Bend the other lead over and cut flush with the first lead as shown in Detail 7A. Squeeze the leads together so that they line up with the rivet holes.
- () Insert the resistor leads into the rivets and lightly crimp the rivets with long-nose pliers or diagonal cutters to hold the resistor.

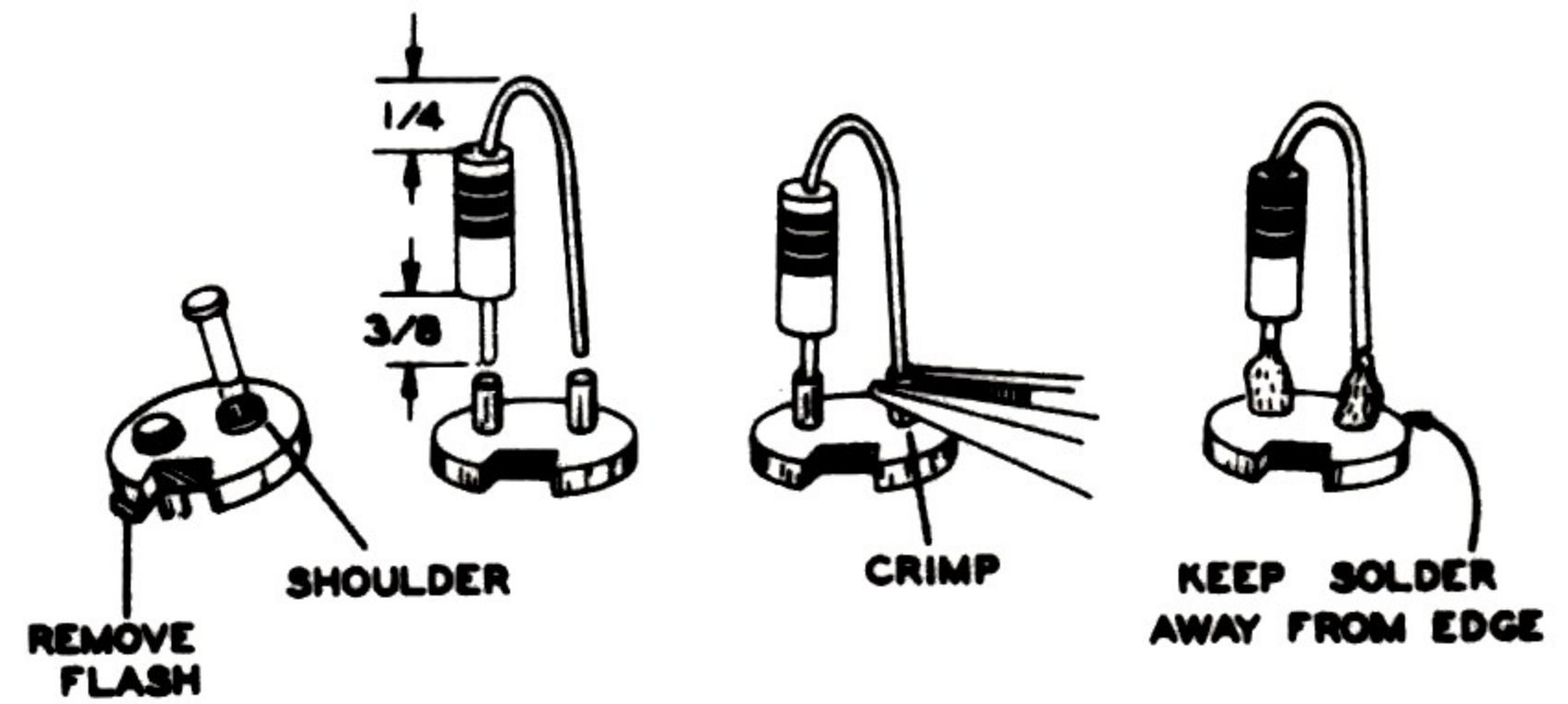

Detail 7A

NOTE: Before proceeding further, check the orientation of the resistor on the insulator. With the notch in the insulator facing you, the resistor should be on the left-hand side.

- () Solder the resistor leads to the rivets. Make sure the resistor is square with the insert insulator and that the solder flows down the rivet to hold the rivet tight against the shoulder. **NOTE:** Keep solder away from the edge of the insert insulator to provide clearance for the internal shoulder of the probe center section.
- () Strip $1/2$ " of the outer insulation from one end of the shielded test cable. Clip off the shield wires up to the outer insulation. It is absolutely essential that the shield wires on this end of the shielded test cable be completely insulated from the rest of the probe tip. **DO NOT** wrap the joint with tape of any kind as this could cause a high resistance leakage path across the shielded portion and the resistor lead.

NOTE: In the following steps, take special care to avoid melting or cutting the inner plastic insulation of the shielded test cable. When soldering, hold the wire with long-nose pliers near the insulation to conduct the heat away from the plastic insulation.

- () Remove $1/4$ " of the inner insulation from the shielded cable and solder to the resistor lead as shown in Detail 7B. Use only enough heat to cause a good solder connection, being careful not to melt the inner insulation of the shielded cable.

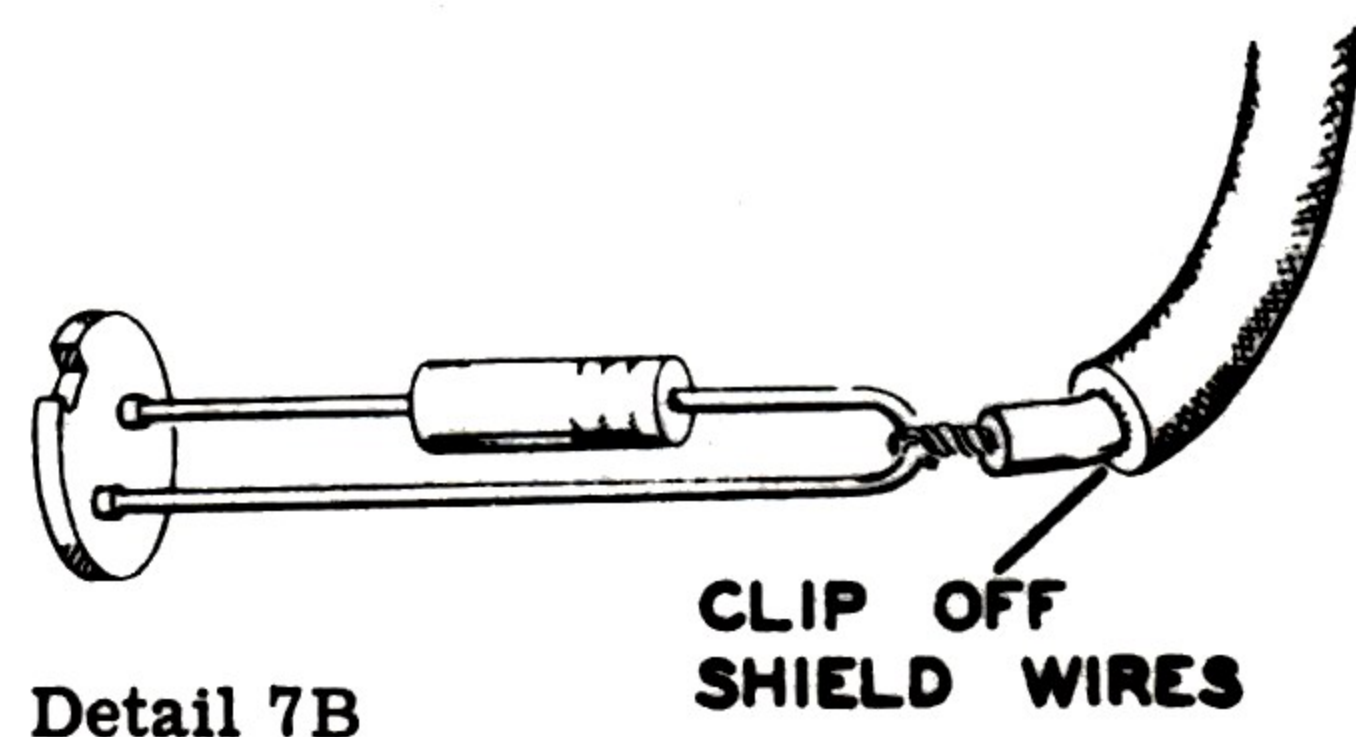

Detail 7B

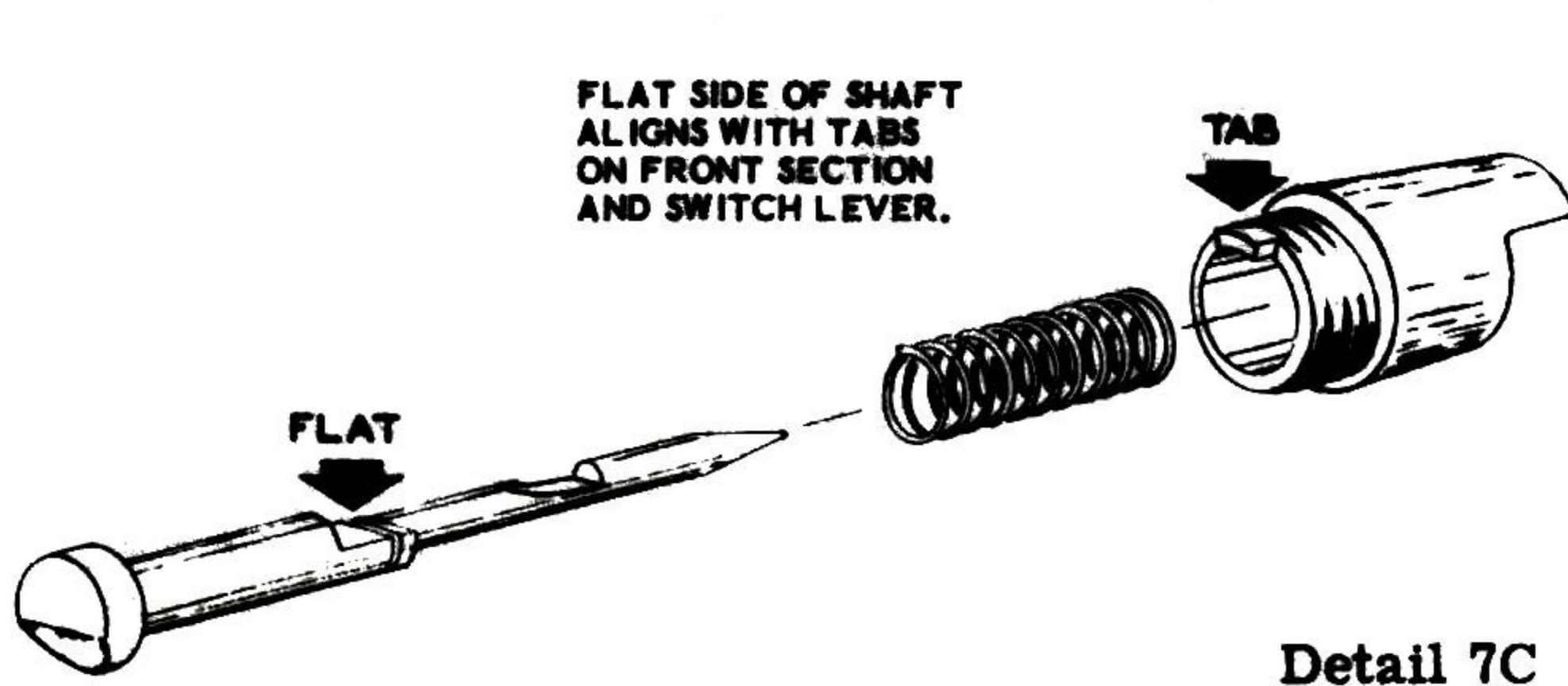

Detail 7C

- () Refer to Detail 7C for the assembly of the front section of the probe, being careful to observe the orientation shown. Assemble the probe spike, the spring, the front section of the probe body, and the switch lever as shown. Push the switch lever flush against the front section of the probe body so that the small retaining ring notch in the spike is exposed. While holding the spike in firmly against the spring pressure with one hand, use a screwdriver or penknife to insert the retaining E washer into the notch in the spike as shown in Detail 7D. When this E washer is securely in place, the spike will be locked to the front section of the probe body.

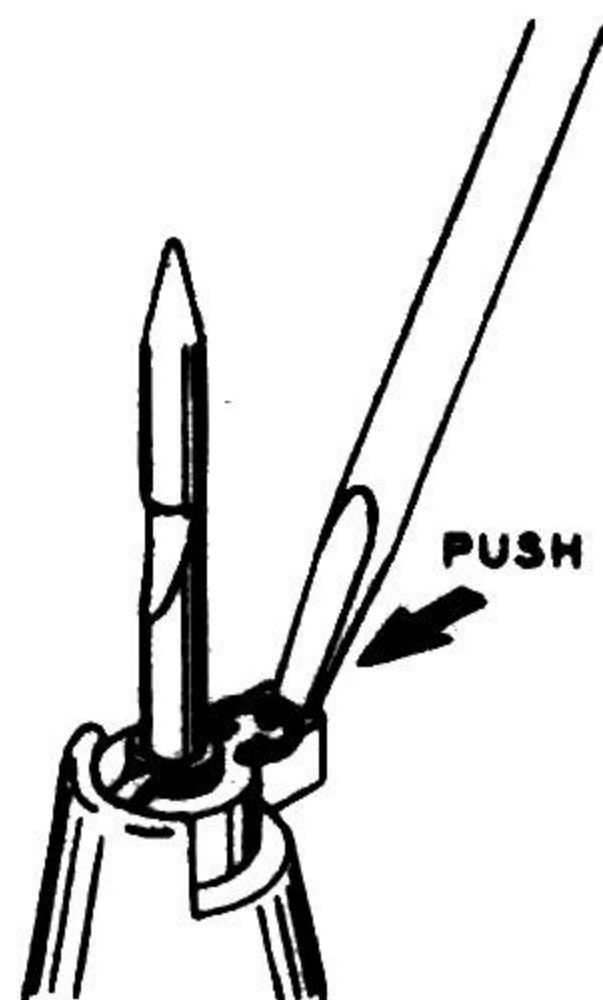

Detail 7D

Refer to Pictorial 7 for final assembly of the test probe.

- () Pull the switch lever forward against the spring tension and temporarily insert a scrap piece of hookup wire between the switch lever and the front section of the probe body.
- () Slip the center section of the probe body onto the shielded cable.
- () Gently pulling the shielded cable from the back of the center section, align the insert insulator flush with the front of the center

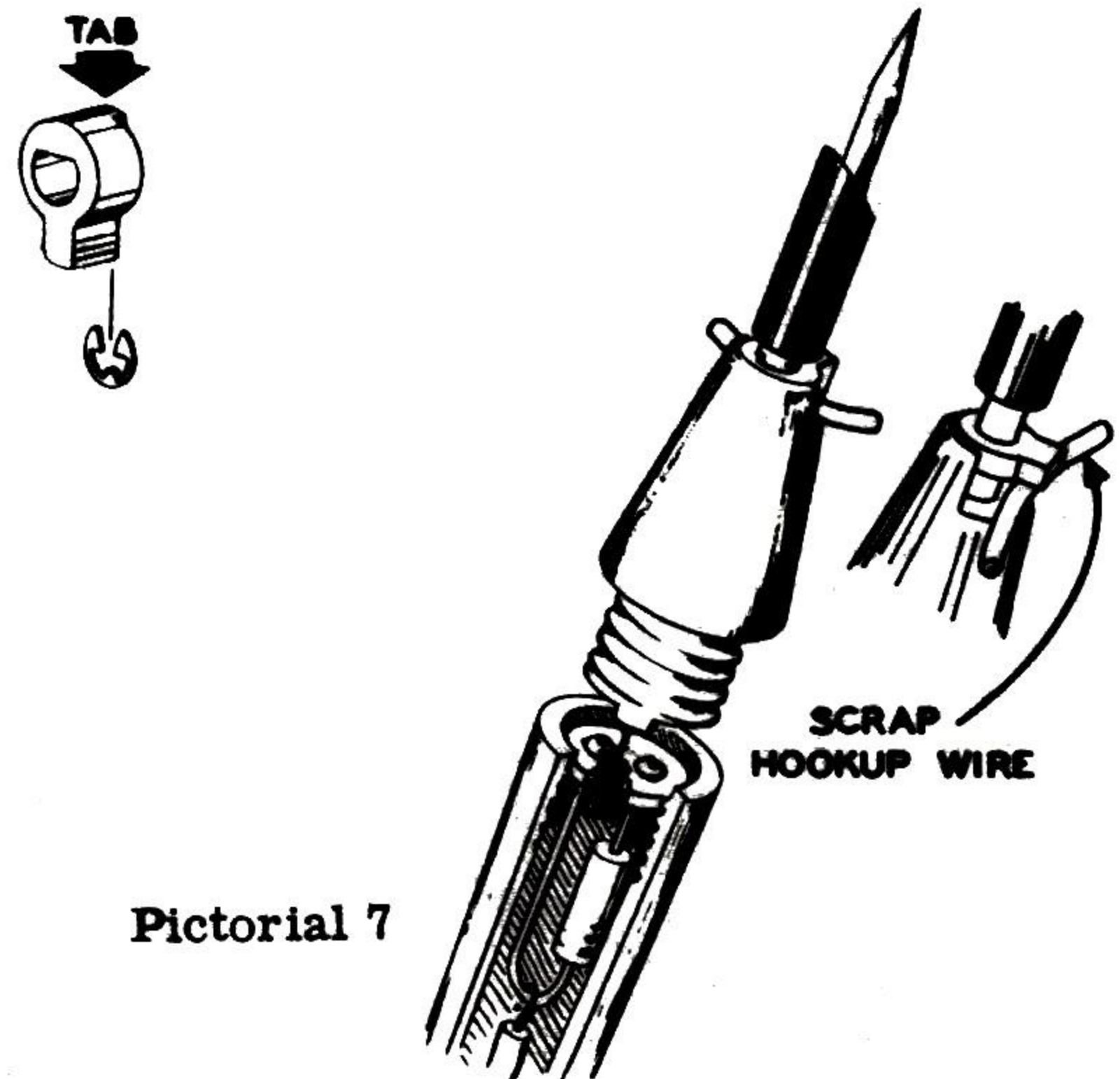

Pictorial 7

section. Do not pull the insert insulator all the way into its final shoulder seat.

- () Insert the tab on the front section of the probe body into the notch in the insert insulator. Holding the front section stationary, screw the center section onto the front section, thus pushing the insert insulator down to its final seat. It is imperative that the final probe assembly be carried out in this manner; otherwise, proper connection between the rivet heads and the front section of the probe will not be made.
- () Remove the scrap hookup wire.

NOTE: If the gap between the front and middle sections is not considerably less than 1/16", the tab is not properly seated in the notch and the above steps must be repeated. Also, when properly assembled, the switch lever will noticeably "detent," or drop into place at both extreme switch positions.

- () Slip the prepared rubber sleeve over the front end of the probe spike as shown in Pictorial 7. The rubber sleeve should be positioned so that it covers the notch in the spike.
- () Slip the rear section of the probe onto the cable and screw it onto the center section.

This completes the assembly of the test probe. The phone plug and alligator clip will now be assembled.

- () Route the free ends of both cables through the phone plug body.
- () Taking care not to cut the outer layer of very thin wires (shield), remove 1/2" of the outer insulator from the free end of the shielded test cable, as shown in Detail 8A.

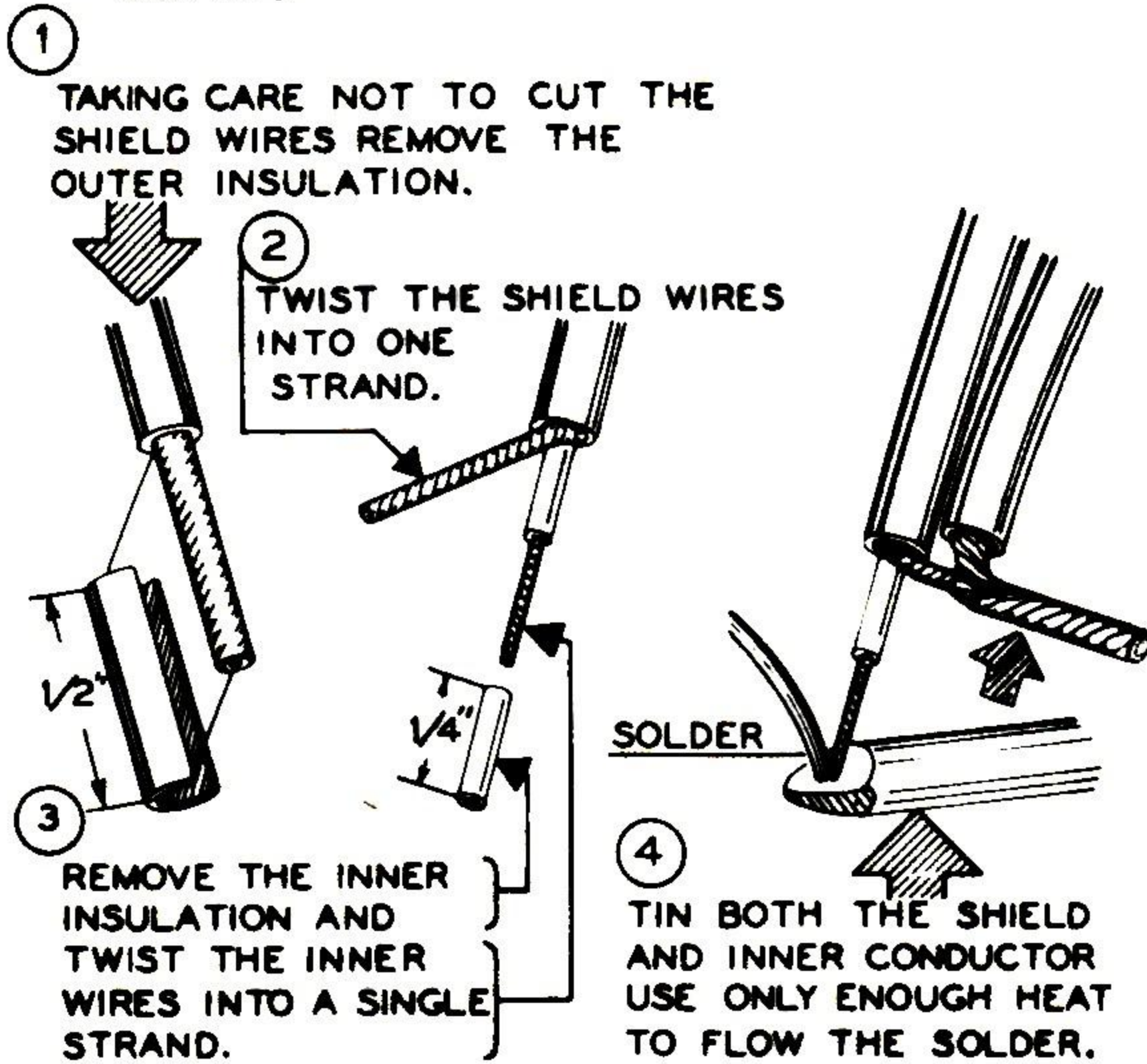

Detail 8A

- () Twist the shield wires lightly into one strand. Remove 1/4" of the inner insulation.
- () Remove 1/2" of insulation from one end of the black test cable. Now twist the shield wires of the shielded cable and the wires

of the black cable firmly together into one strand and tin the combined strand heavily, as shown in Detail 8A. Also tin heavily the inner conducting wire. Take care not to melt the inner insulation.

In the following step, you will connect the prepared cables to the phone plug as shown in Pictorial 8. To avoid overheating the cable insulation, apply a film of solder to the phone plug and heat thoroughly. Then hold the heavily tinned wires to the phone plug and apply just enough heat to melt the solder.

- () First, solder the two twisted wires to the phone plug. Be careful not to melt or burn the inner plastic insulation of the shielded cable. Then solder the inner conducting wire of the shielded cable as shown, being sure the phone plug body will still fit over the wires. Be sure to use only enough heat to melt the solder and make a good connection.
- () After the wires have completely cooled down, use pliers to bend the tabs on the phone plug over lightly to secure the two cables. Be sure not to cut through the insulation by pinching the cables too hard with the tabs. Screw together the two parts of the phone plug.

This completes the phone plug assembly.

- () Strip 1/2" of insulation from the free end of the black test lead, tin the strands of wire and solder to the alligator clip.

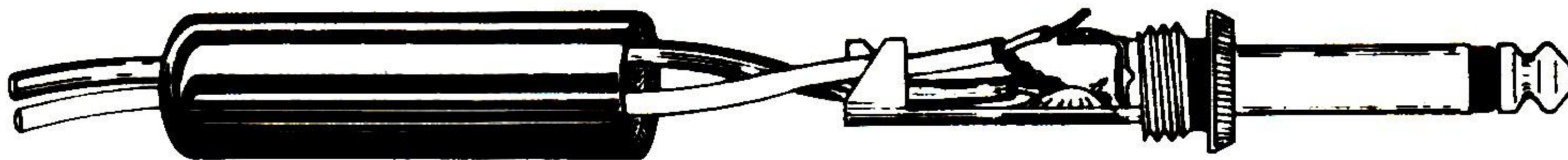

Pictorial 8

TEST AND CALIBRATION

During the preparation of the test leads and cabinet, the VTVM has had an opportunity to warm up thoroughly and should now be calibrated.

Turn the instrument off and make sure that the mechanical zero position of the meter pointer is correct. If not, adjust as follows:

- () Place the instrument in normal operating position. Turn the plastic screw on the meter face with a screwdriver while gently tapping the meter face with one finger until the pointer coincides with the zero line on the left side of the scale. Turn the instrument on again.

ZERO ADJUST

- () Set the Function switch to DC+. Check operation of the ZERO ADJ control. Turning this control should move the meter pointer part way up scale. Set the pointer to zero at the left side of the scale and check for zero positioning when the Function switch is changed to DC-. It should be possible to obtain a ZERO ADJ control position that will permit the meter pointer to remain stationary when switching through from DC+ to DC-. If there is an appreciable zero shift of more than two divisions on the scale, it should be regarded merely as an indication that additional aging of the 12AU7 tube is required. This aging can be obtained by leaving the instrument turned on for a period of 48 hours or more, or through continued use of the VTVM with periodic calibration.

DC CALIBRATE

- () Insert the test lead phone plug. Set the Function switch to DC+, the Range switch to 1.5 V and the probe to DC. Connect the probe and common test leads to the flashlight cell supplied and adjust the DC Calibrate control so that the meter pointer falls directly over the very small red dot on the meter face. Approach the red dot going up scale by turning the screwdriver control and watch the meter read 1.4 volts, and 1.5 volts, and then the red dot. As soon as the red dot is reached, stop turning the DC Calibrate control. Remember that the Range switch must be set on 1.5 V for this adjustment.

OHMS CHECK

- () Turn off VTVM. To install the battery, start the top (+) end of the battery into the battery cup and then pull the spring out and over the bottom (-) end of the battery. Now push the spring and the battery in so the spring, battery, and battery cup are all in line. Turn on the VTVM and set the Function switch to OHMS. Set the OHMS ADJ control for full scale (infinity). Set the probe switch to AC-OHMS and touch the probe to the common test clip. The meter pointer should drop to zero at the left end of scale (no resistance).

WARNING: 117 volt AC line is dangerous. Proceed with due care.

AC CALIBRATE

- () Temporarily remove the phone plug from the jack. Set the Range switch to 1.5 V and the Function switch to AC. Adjust the AC Balance control so no movement is detected when switching from AC through DC- to DC+. Now set the Range switch to 150 V and the Function switch to AC. Reinsert the phone plug. Connect the test probe set on AC and the common lead across the 117 volt AC line.

Adjust the AC Calibrate control until the pointer indicates the line voltage (117 volts AC).

AGING AND FINAL CALIBRATION

- () It is recommended that the tubes be aged before final calibration. This is accomplished by keeping the instrument turned on for a period of at least 48 hours. Final calibration should be done in the same way as the initial calibration. Careful calibration will result in a more accurate instrument. If a standard AC meter is available, it is desirable to use such an instrument to check the accuracy of the VTVM. Preferably, use a voltage near full scale on the VTVM as for instance, 140 volts or 40 volts on the 150 V or 50 V range respectively. The DC scales may also be calibrated using a DC meter of known accuracy. One of the major advantages of kit form instrument assembly is that the kit builder

becomes thoroughly familiar with the calibration procedure and is therefore capable of periodically checking VTVM operating accuracy, instead of assuming that usual factory instrument calibration is still valid.

After final calibration, place the instrument in the cabinet and secure it with two 6-32 x 3/8" sheet metal screws. The instrument is now ready

for use. The power consumption of the VTVM is very low and there is no objection to leaving the instrument on continuously during the daily work period rather than turning it off each time a measurement function is completed. Daily operation for a period of several hours or more will also serve the purpose of minimizing possible moisture accumulation.

USING YOUR VTVM

COMBINATION PROBE

The combination AC-OHMS-DC test probe eliminates two of the usual three test jack installations in the VTVM front panel. The probe is set to AC-OHMS when the Function switch is on AC or OHMS, and on DC when the Function switch is on DC+ or DC-. The probe tip design makes it unnecessary to actually hold the probe to the circuit. Instead, the probe can be clipped onto any lead in the circuit, as shown in Figure 1, giving the operator another free hand. To disconnect the probe, the probe is gently twisted until it comes free from the test circuit.

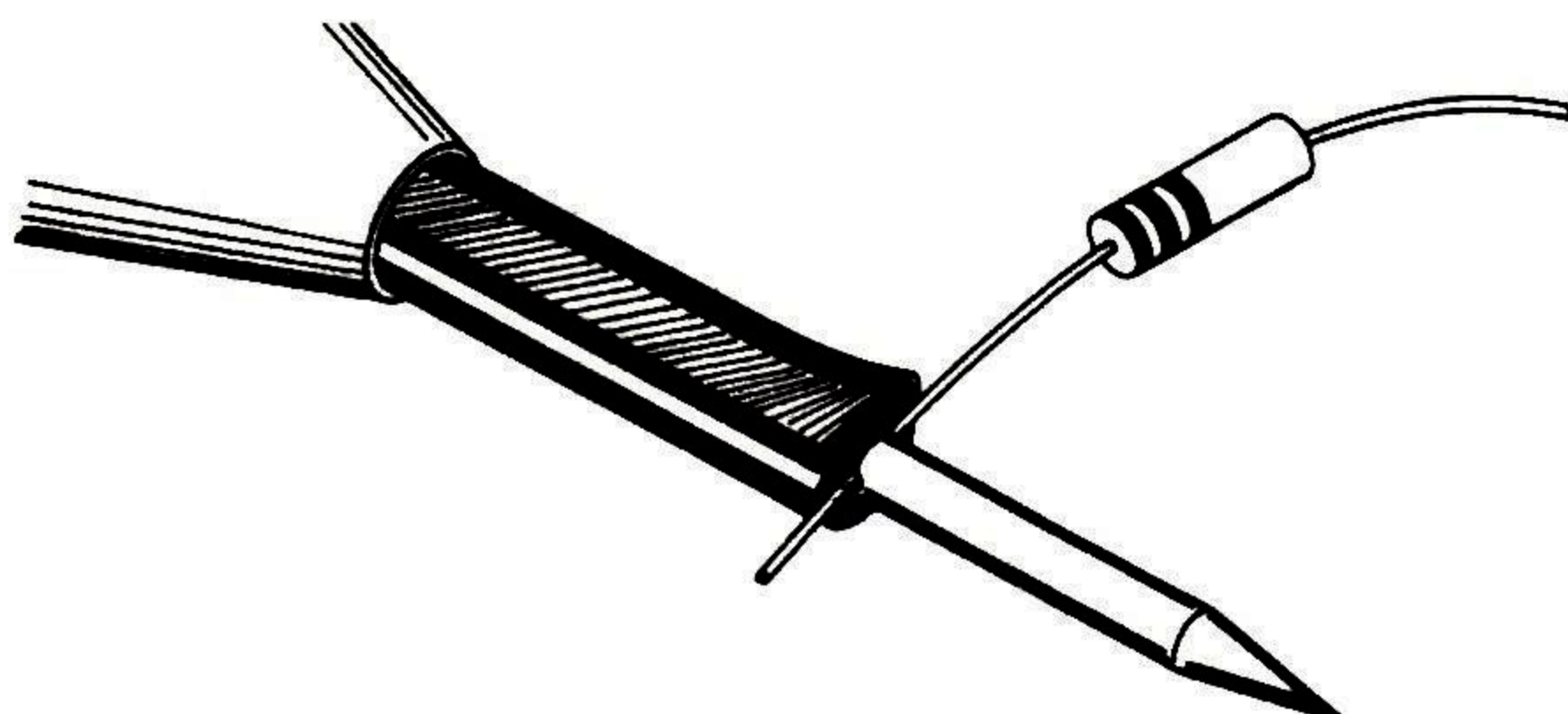

Figure 1

CAUTION: It is good practice to observe certain basic rules of operating procedure anytime voltage measurements are to be made. Always handle the test probe by the insulated housing only and do not touch the exposed tip portion.

The metal case of this instrument is connected to the ground of the internal circuit and for proper operation, the ground terminal of the instrument should always be connected to the ground of the equipment under test. There is always danger inherent in testing electrical equipment and therefore the user should clearly familiarize himself with the equipment under test before working on it, bearing in mind that high voltages may appear at unexpected points in defective equipment.

When measurements are to be made at high voltage points, it is good practice to remove operating power before connecting test leads. If this is not possible, be particularly careful to avoid accidental contact with nearby objects which could provide a ground return path. When working on high voltage circuits, play safe. Keep one hand in your pocket to minimize accidental shock hazard and be sure to stand on a properly insulated floor or floor covering.

Voltages encountered in the measurement range of this instrument are seldom directly lethal but the secondary effects of a shock, such as involuntary reaction causing a fall or heart attack, can be very serious.

DC VOLTAGE MEASUREMENTS

The VTVM has many advantages over nonelectronic volt-ohmmeters. The greatest advantage is the high input resistance. This enables much more accurate readings to be obtained in high impedance circuits such as resistance coupled amplifiers, oscillator grid circuits, and AVC lines.

To illustrate this, assume a resistance coupled audio amplifier with a .5 megohm plate load resistor operating from a 100 volt plate supply as shown in Figure 2. Assume that the plate voltage is 50 volts and therefore the tube acts as a .5 megohm resistor. Measuring the plate voltage with a conventional 1000 ohms-per-volt instrument on the 100 volt scale, the meter can be considered a 100,000 Ω (.1 megohm) resistor in parallel with the tube. The voltage on the plate is then about 14 volts, and is shown as such by the meter. This is due to the shunt resistance of the low resistance meter. Using the VTVM on any scale setting, the full 11 megohms is placed in parallel with the tube. The voltage on the plate

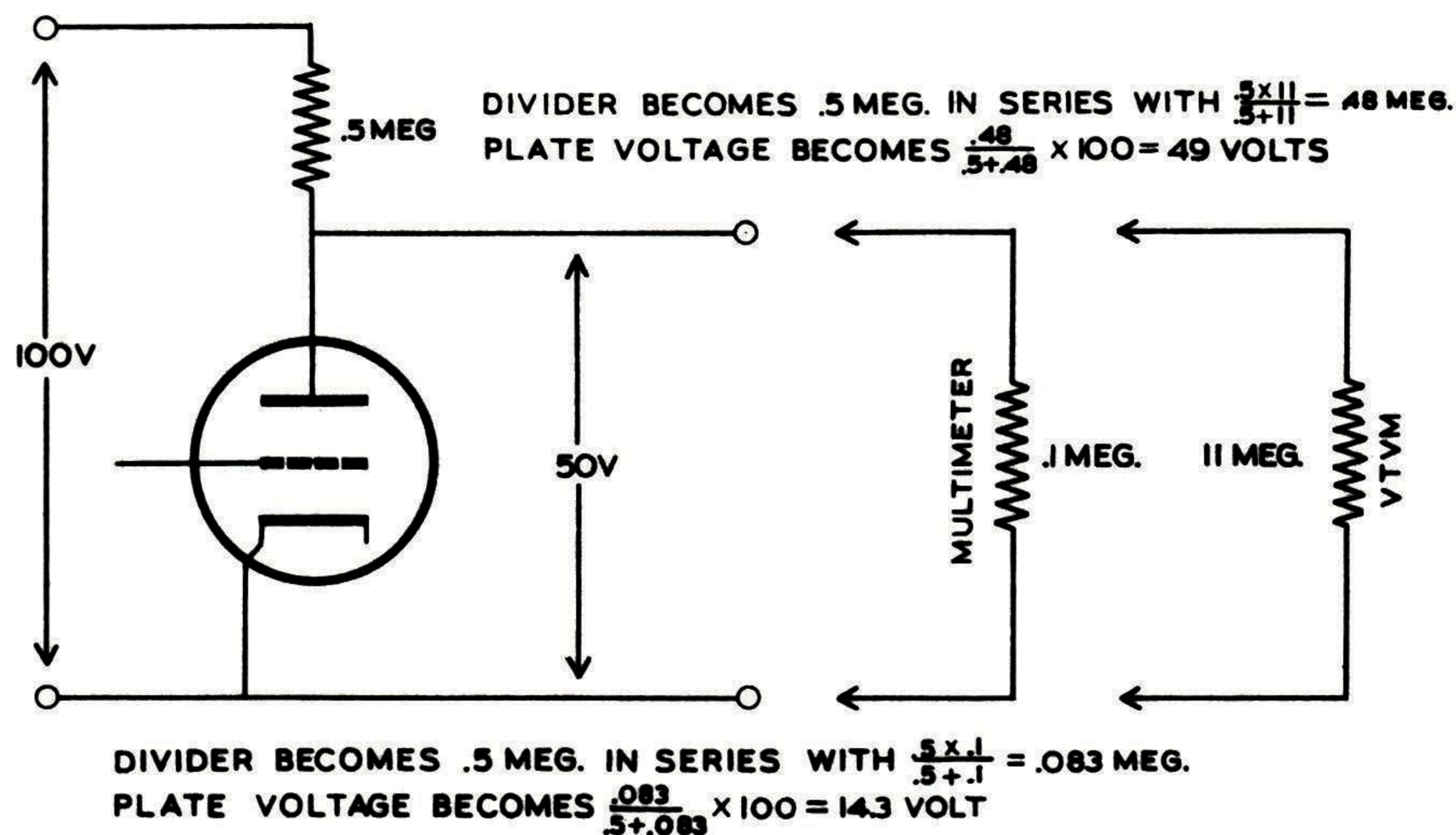

Figure 2

is then about 49 volts or 2% lower than the normal operating voltage. Thus accurate readings can be obtained only with the high resistance provided by a VTVM.

To measure DC voltage with the VTVM, connect the COMMON (black lead) to the common or "cold" side of the voltage to be measured. Set the Function switch to DC+ or DC- as required and set the Range switch to a range greater than the voltage to be measured, if known. If unknown, set to 1500 V. With the test probe set on DC, touch the "hot" side of the voltage to be measured. If the pointer moves less than 1/3 of full scale, switch the Range switch to the next lower range. For greatest measurement accuracy, all voltage measurements should be made on the range which will accommodate the largest possible deflection of the meter pointer.

The available voltage ranges are intended to provide coverage for the radio and TV serviceman. For example, the 1.5 V range will be useful in measuring bias voltages, DC heater voltages, etc. The 5 V and 15 V ranges will again prove their worth in bias measurement functions. The 50 V and 150 V ranges will find greatest application in the measurement of voltages encountered in universal or transformerless type radio circuits. The 500 V range can be used on conventional transformer operated power supplies found in radio and TV circuits, and this voltage range eliminates the necessity for switching from one range to another when measuring plate and screen supply voltages. On many occasions, the higher voltage ranges will prove useful.

DC accelerating potentials developed in TV receiver flyback power supply systems can be safely measured through the use of the HEATH-KIT High Voltage Probe in conjunction with the VTVM. This probe with its precision multiplier resistor mounted in a safety plastic probe housing will provide a multiplication factor of 100 for the VTVM DC ranges. 30,000 volts DC is generally considered the safe upper limit for these measurements.

CENTER SCALE "0" POSITION

Your VTVM features a convenient center scale zero position. The adjustment range of the ZERO ADJ control will permit center scale zero deflection of the meter pointer when Function switch is set to DC+ or DC-. Center scale zero may not be obtained at both positions.

The center scale zero will be useful as a null indicator in discriminator adjustments, for bias measurements or any application where polarity reversals may occur.

AC VOLTAGE MEASUREMENTS

To measure AC voltage, connect the COMMON (black) lead to the common or "cold" side of the voltage to be measured. Set the Function switch to AC and set the range switch to a range greater than the voltage to be measured, if known. If unknown, set to 1500 V. With the test probe set on AC, touch the other side or "hot" side of the voltage to be measured. If the meter moves less than 1/3 of full scale,

switch to the next lower range. The maximum AC voltage that can be safely measured is 1500 volts, and this limit must not be exceeded. The meter scales are calibrated in both rms and peak-to-peak voltages. When values of sine waves are measured, rms voltages are read and the corresponding values in peak-to-peak volts are equal to 2.83 times the rms voltage. If the range switch is set at 15 V and a sine wave of 10 rms volts is applied to the instrument, the meter pointer will indicate 10 rms volts and 28.3 peak-to-peak volts. This direct-reading, time-saving feature makes the usual calculation to transpose from one scale to another unnecessary.

This VTVM is an extremely sensitive electronic AC voltmeter and as the human body picks up AC when near any AC wires, the meter will indicate this pickup. Never touch the probe when on the lower ranges. Zero should be set with the probe shorted to the common clip. Because of this characteristic of extreme sensitivity, it is possible that the accuracy of AC measurements on the 1.5 V range only may vary as much as 15% and this possible deviation should be taken into consideration. On the remaining ranges, the accuracy should be well within the 5% specified.

RESISTANCE MEASUREMENTS

To measure resistance with the VTVM, connect the COMMON (black) lead to one side of the resistor or circuit to be measured. Set the Function switch to OHMS and set the Range switch to a range that will provide a reading as near mid-scale as possible. Set the OHMS ADJ control so the meter indicates exactly full scale (infinity). With the test probe set on OHMS, touch the other side of the resistor or circuit to be measured. Read resistance on the OHMS scale and multiply by the proper factor as shown by the Range switch settings.

NOTE: Although a battery is used to measure resistance, the indication is obtained through the electronic meter circuit and therefore the VTVM must be connected to the AC power line and turned on. Establish the habit of never leaving the instrument set in the OHMS position as this could greatly shorten the life of the ohmmeter battery, particularly if the test leads are accidentally shorted together when lying on the service bench.

USING THE DECIBEL SCALE

Because the human ear does not respond to volume of sound in proportion to signal strength, a unit of measure called the "bel" was adopted. The bel is more nearly equivalent to human ratios. Normally the reading is given in 1/10 of a bel or a decibel. Various signal levels are adopted by various manufacturers as standard of zero decibel. The VTVM DB scale (decibel) uses a standard of 1 milliwatt into a 600 Ω line as zero decibels. This corresponds to .774 volts AC on the 1.5 V scale. From this figure, the various AC ranges of the VTVM may be converted to DB, with adequate accuracy, by the following chart:

<u>AC VOLTS SCALE</u>	<u>DECIBEL SCALE</u>
0-1.5 volts	Read db directly
0-5 volts	Add 10 db to the reading
0-15 volts	Add 20 db to the reading
0-50 volts	Add 30 db to the reading
0-150 volts	Add 40 db to the reading
0-500 volts	Add 50 db to the reading
0-1500 volts	Add 60 db to the reading

As the decibel is a power ratio or voltage ratio, it may be used as such without specifying the reference level. Thus for instance, a fidelity curve may be run on an amplifier by feeding in a signal or variable frequency but constant amplitude. At a reference frequency of say 400 cps, adjust the input to give a convenient indication (zero db, for instance) on the VTVM connected to the output. As the input frequency is varied, the output variation may be noted directly in DB above and below the specified reference level. **NOTE:** When measuring complex AC wave shapes, such as ripple, hum, distorted and square waves, the indication is 35% of peak-to-peak.

READING THE METER SCALE

The voltage markings for the Range switch refer to the full scale reading. The scale is marked 0-15 and 0-50 for voltage. On the 1.5 V range, read the 0-15 scale and move the decimal one place to the left. Thus for example, a reading of 8 would represent a voltage of .8 volt. On the 5 V range, read the 0-50 scale and move the decimal point one place to the left, that is, drop the zero. A reading of 40 would represent a voltage of 4 volts. On the 15 V range, read the 0-15 scale directly. **EXAMPLE:** A reading of 4

represents a voltage of 4 volts. On the 50 V range, read the 0-50 volts directly. On the 150 V range, read the 0-15 scale and add one zero. **EXAMPLE:** A reading of 12 represents a voltage of 120 volts. On the 500 V range, read the 0-50 scale and add one zero. **EXAMPLE:** A reading of 40 represents a voltage of 400 volts. On the 1500 V range, read the 0-15 scale and add two zeros. **EXAMPLE:** A reading of 8 represents a voltage of 800 volts.

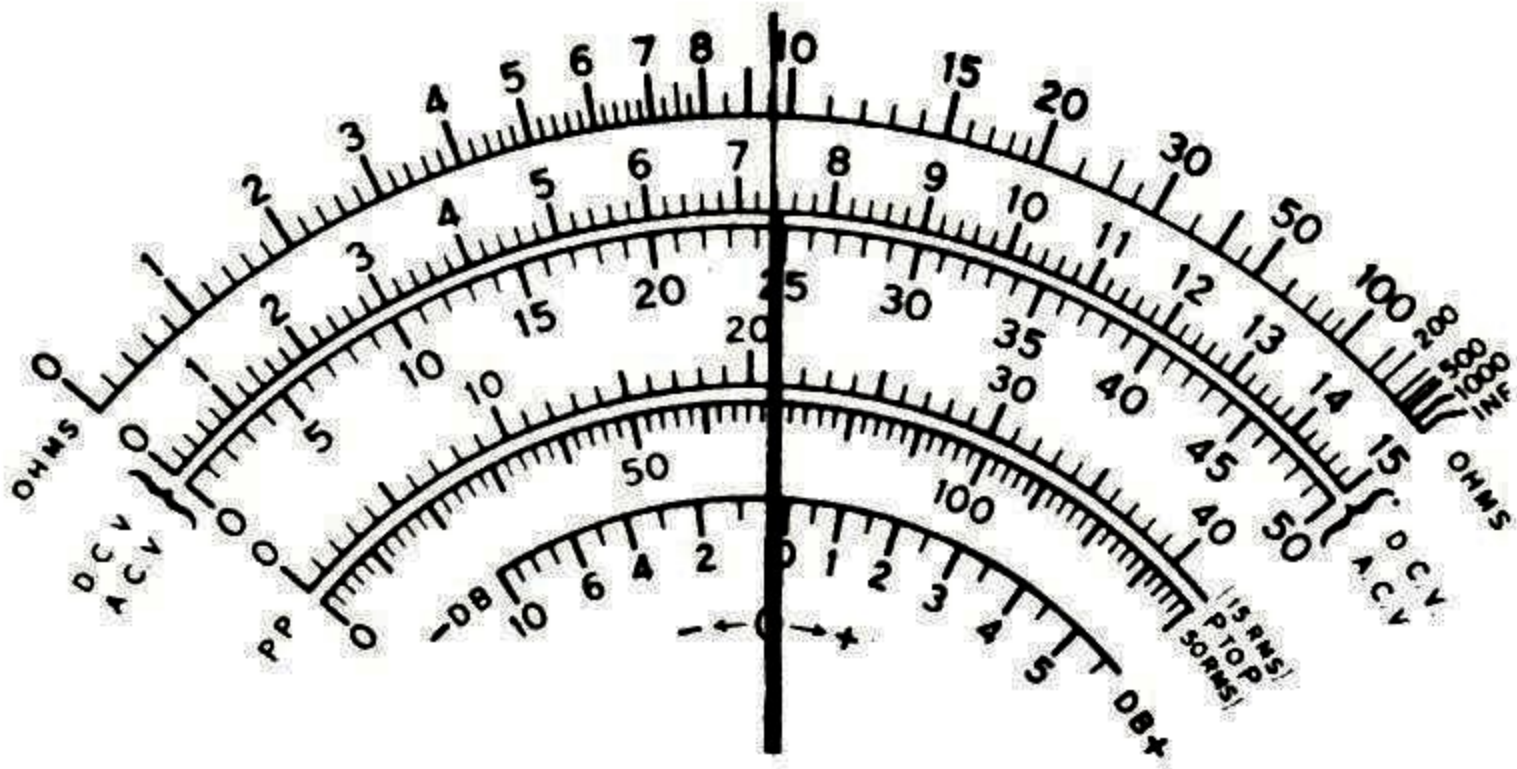

NOTE: The meter markings do not mean that the upper scale indicates DC volts and the lower scale AC volts. Rather, it means that either scale will read AC volts or DC volts, depending on the setting of the Function switch.

The resistance marking or OHMS scale refers to the lowest resistance range, RX1. For the other ranges, add the proper number of zeros. Add two zeros for RX100, four zeros for RX10K and six zeros for RX1 MEG. On the RX1 MEG range, the scale can also be considered to read directly in megohms.

ACCURACY

The accuracy of the meter movement is within 2% of full scale which means that on the 1000 V

range, for instance, the accuracy of the movement will be within 20 volts at any point on the scale. On DC, the accuracy of the multipliers, 1%, may be additive, resulting in an inaccuracy of within 3% of full scale.

On AC, the accuracy of the rectifier circuit contributes variations which result in an accuracy of within 5% of full scale. Bear in mind that on the lowest AC voltage range, 1.5 V extreme sensitivity will introduce additional variation through stray pickup. Therefore, on the 1.5 V range, it is possible that the accuracy may be in the order of 15% on AC only.

The accuracy on the OHMS range depends on the meter accuracy, the ohms multiplier accuracy (including the internal resistance of the battery) and the stability of the battery voltage. On the RX1 scale, the internal resistance of the battery and the battery voltage both vary as a result of the current drawn by the resistance under test. For greatest accuracy, tests on low resistance values should be made as quickly as possible. On the higher ohms range, the accuracy depends practically on the multipliers which are 1% and the meter movement accuracy, 2%. Because of the non-linear OHMS scale, the resulting accuracy is not readily expressed in a percentage figure, but greatest accuracy is obtained at mid-scale readings.

NOTE: When comparing this instrument with another VTVM, consider that the accuracy of the other instrument may deviate in the opposite direction. Therefore, when comparing two instruments of 5% accuracy, the total difference may be 10%. Critical comparisons should only be made against certified laboratory standards.

IN CASE OF DIFFICULTY

1. Recheck the wiring. Trace each lead in colored pencil on the Pictorial as it is checked. It is frequently helpful to have a friend check your work. Someone who is not familiar with the unit may notice something consistently overlooked by the constructor.
2. It is interesting to note that about 90% of the kits that are returned for repair, do not function properly due to poor connections and soldering. Therefore, many troubles can be eliminated by reheating all connections to make sure that they are soldered as described in the Proper Soldering Techniques section of this manual.
3. Check to be sure that all tubes are in their proper locations. Make sure that all tubes light up properly.
4. Check the tubes with a tube tester or by substitution of tubes of the same types and known to be good.
5. Check the values of the component parts. Be sure that the proper part has been wired into the circuit, as shown in the pictorial diagrams and as called out in the wiring instructions.
6. Check for bits of solder, wire ends or other foreign matter which may be lodged in the wiring beneath the chassis.
7. If, after careful checks, the trouble is still not located and a voltmeter is available, check voltage readings against those found on the Schematic Diagram. NOTE: All voltage readings were taken with an 11 megohm input vacuum tube voltmeter. Voltages may vary as much as 10% due to line voltage variations.
8. A review of the Circuit Description will prove helpful in indicating where to look for trouble.

TROUBLESHOOTING CHART

COMPLETELY INOPERATIVE

1. Make sure that power is being applied to the instrument. This may be measured across the primary winding of the power transformer (black leads, 117 volts AC).
2. If pilot lamp and tube filaments do not light, check voltage between the yellow leads of power transformer (5-6 volts AC).
3. Check voltage between each end of electrolytic capacitor and ground. Correct voltages are shown on the Schematic.
4. Check the 12AU7 tube.

INABILITY TO OBTAIN DC BALANCE

1. Check the 12AU7 tube for an unbalanced condition (Substitution).
2. Check the 10 megohm resistor, R32 (brown-black-blue).
3. Check the two .005 capacitors C5 and C6 in grid circuits of the 12AU7 tube (Pins 2 and 7).

4. Check the components in the cathode circuits of the 12AU7 tube (Pins 3 and 8). These circuits include the ZERO ADJ control, R1, R33, R34, and R35.
5. Check Range switch assembly carefully.

AC INOPERATIVE

1. Check the 6AL5 tube.
2. Check C2, .047 μ fd 1600 volt, and the two .02 μ fd capacitors, C3 and C4.
3. Check Function switch assembly carefully.

AC BALANCE

1. Disconnect test leads from instrument before adjusting the AC Balance control as directed in the manual.
2. It is imperative that DC balance be obtained before this adjustment is made.

INACCURATE AC READINGS (The inability to obtain AC calibration).

1. Check capacitors C1, C3, and C4.
2. Check the 6AL5 tube.
3. Check the AC Calibrate control, R3. NOTE: With the test lead plug inserted, there may be a residual reading. This is due to stray AC pickup in the test leads and can be attributed to the instrument's excellent sensitivity. Readings on the two lower AC ranges will normally be slightly low.

INACCURATE DC READINGS

1. Check the DC calibrate control, R4.
2. Check resistor in the test probe. Make sure that it is not being grounded.

OHMS INOPERATIVE

1. Check the OHMS ADJ control, R2, for correct value.
2. Check Range switch proper assembly.

OHMS INACCURATE

1. Check the battery (Substitution).
2. Check the value of all resistors on the range switch which have a value beginning with the number "9". (The 9.1 Ω R31 should receive special attention.) NOTE: The ohms section of the VTVM is not intended for use as a standard. Where a great degree of accuracy is required, a bridge should be used.

MAINTENANCE

METER

Because of the delicate nature of the meter movement, no attempt should be made to repair the meter. Such attempts would automatically void the standard warranty coverage of the meter itself.

METER COVER

If the polystyrene meter cover is accidentally damaged, a replacement cover only is available from Daystrom, Limited. This cover can be easily removed without detaching the meter from the panel. Use a small screwdriver or knife blade under one of the upper corners and pop off the friction-fit cover. When installing a new cover, precaution should be observed regarding proper engagement of the mechanical zero adjust stud. If it is necessary to expose the meter movement to air for a period of time, protect the movement from foreign matter, dust, etc., by enclosing the instrument in a box or possibly in a desk drawer.

ELECTROSTATIC CHARGE

The polystyrene meter cover has been treated to resist an accumulation of static electricity. However, should a static charge accumulate through repeated polishing or cleaning of the meter cover, the pointer will deflect in an erratic manner, regardless of whether the instrument is turned off or on. This condition

can be corrected quickly. Apply a small quantity of liquid dishwashing detergent to a clean, soft cloth and wipe the surface of the meter cover. The accumulated electrostatic charge will immediately disappear. It is not necessary to remove the cover for this correction.

CHECKING METER COIL CONTINUITY

If failure of the meter coil is suspected, continuity can be determined by observing the following precaution. NEVER check meter movement continuity directly with another ohmmeter. The amount of current drawn will seriously overload the meter coil and will certainly result in a definite open circuit condition. Always use a limiting resistor in series with the ohmmeter test leads. The value of the resistor will depend upon the ohmmeter battery voltage and range on which the ohmmeter is being used. Always use at least a 10,000 Ω resistor in series with the VTVM meter coil and the ohmmeter test leads.

TEST LEADS

Because of their constant flexing during use, the test leads are not above suspicion, especially when the VTVM has been in use for several years. Erratic or improper DC voltage measurements can sometimes be caused by a fault in the shielded test lead or in the connection of the 1 megohm isolating resistor used in the test probe.

ACCESSORY PROBES

HIGH VOLTAGE TEST PROBES

A high voltage test probe is available from the Heath Company. This probe will permit VTVM DC measurements up to 30,000 volts, which covers the range of flyback power supply voltages commonly encountered in TV receivers. This probe consists of red molded housing with black molded handle. It contains a 2% precision, 1090 megohm resistor and provides a DC range multiplication factor of 100 for 11 megohm input VTVMs.

Older model high voltage probes may be con-

verted for use in the IM-11 by making a ground connection from an alligator clip lead to the body of the probe phone plug.

RF TEST PROBE

A RF test probe is available from the Heath Company. This probe will permit VTVM usage for RF measurements up to 30 volts, substantially flat from 1000 cps to 100 mc. A built-in isolating capacitor permits DC voltage range up to 500 volts. It uses a printed circuit board for easy assembly and its housing is of polished aluminum with polystyrene insulation.

SERVICE INFORMATION

SERVICE

If, after applying the information contained in this manual and your best efforts, you are still unable to obtain proper performance, it is suggested that you take advantage of the technical facilities which Daystrom, Limited makes available to its customers.

The Technical Consultation Department is maintained for your benefit. This service is available to you at no charge. Its primary purpose is to provide assistance for those who encounter difficulty in the construction, operation or maintenance of HEATHKIT equipment. It is not intended, and is not equipped to function as a general source of technical information involving kit modifications nor anything other than the normal and specified performance of HEATHKIT equipment.

Although the Technical Consultants are familiar with all details of this kit, the effectiveness of their advice will depend entirely upon the amount and the accuracy of the information furnished by you. In a sense, YOU MUST QUALIFY for GOOD technical advice by helping the consultants to help you. Please use this outline:

1. Before writing, fully investigate each of the hints and suggestions listed in this manual under In Case Of Difficulty. Possibly it will not be necessary to write.

2. When writing, clearly describe the nature of the trouble and mention all associated equipment. Specifically report operating procedures, switch positions, connections to other units and anything else that might help to isolate the cause of trouble.
3. Report fully on the results obtained when testing the unit initially and when following the suggestions under In Case Of Difficulty. Be as specific as possible and include voltage readings if test equipment is available.
4. Identify the kit model number and date of purchase, if available. Also mention date of Kit assembly Manual. (Date at bottom of outside back cover.)
5. Print or type your name and address, preferably in two places on the letter.

With the preceding information, the consultant will know exactly what kit you have, what you would like it to do for you and the difficulty you wish to correct. The date of purchase tells him whether or not engineering changes have been made since it was shipped to you. He will know what you have done in an effort to locate the cause of trouble and, thereby, avoid repetitious suggestions. In short, he will devote full time to the problem at hand, and through his familiarity with the kit, plus your accurate report, he will be able to give you a complete and helpful answer. If replacement parts are re-



quired, they will be shipped to you, subject to the terms of the Warranty.

The Factory Service facilities are also available to you, in case you are not familiar enough with electronics to provide our consultants with sufficient information on which to base a diagnosis of your difficulty, or in the event that you prefer to have the difficulty corrected in this manner. You may return the completed instrument to Daystrom, Limited for inspection and necessary repairs and adjustments. You will be charged a minimal service fee, plus the price of any additional parts or material required. However, if the completed kit is returned within the Warranty period, parts charges will be governed by the terms of the Warranty. State the date of purchase, if possible.

THIS SERVICE POLICY APPLIES ONLY TO COMPLETED EQUIPMENT CONSTRUCTED IN ACCORDANCE WITH THE INSTRUCTIONS AS STATED IN THE MANUAL. Equipment that has been modified in design will not be accepted for repair. If there is evidence of acid core solder or paste fluxes, the equipment will be returned NOT repaired.

For information regarding modification of HEATHKIT equipment for special applications, it is suggested that you refer to any one or more of the many publications that are available on all phases of electronics. They can be obtained at or through your local library, as well as at most electronic equipment stores. Although Daystrom, Limited sincerely welcomes all comments and suggestions, it would be impossible to design, test, evaluate and assume responsibility for proposed circuit changes for special purposes. Therefore, such modifications must be made at the discretion of the kit builder, using information available from sources other than Daystrom, Limited.

REPLACEMENTS

Material supplied with HEATHKIT products has been carefully selected to meet design requirements and ordinarily will fulfill its function without difficulty. Occasionally improper instrument operation can be traced to a faulty component. Should inspection reveal the necessity for replacement, write to Daystrom, Limited and supply all of the following information.

- A. Thoroughly identify the part in question by using the part number and description found in the manual Parts List.
- B. Identify the type and model number of kit in which it is used.
- C. Mention date of purchase.
- D. Describe the nature of defect or reason for requesting replacement.

Daystrom, Limited will promptly supply the necessary replacement. PLEASE DO NOT RETURN THE ORIGINAL COMPONENT UNTIL SPECIFICALLY REQUESTED TO DO SO. Do not dismantle the component in question as this will void the guarantee. This replacement policy does not cover the free replacement of parts that may have been broken or damaged through carelessness on the part of the kit builder.

SHIPPING INSTRUCTIONS

In the event that your instrument must be returned for service, these instructions should be carefully followed.

ATTACH A TAG TO THE EQUIPMENT BEARING YOUR NAME, COMPLETE ADDRESS, DATE OF PURCHASE, AND A BRIEF DESCRIPTION OF THE DIFFICULTY ENCOUNTERED. Wrap the equipment in heavy paper, exercising care to prevent damage. Place the wrapped equipment in a stout carton of such size that at least three inches of shredded paper, excelsior, or other resilient packing material can be placed between all sides of the wrapped equipment and the carton. Close and seal the carton with gummed paper tape, or alternately, tie securely with stout cord. Clearly print the address on the carton as follows:

To: DAYSTROM, LIMITED
Cooksville, Ontario

Include your name and return address on the outside of the carton. Preferably affix one or more "Fragile" or "Handle With Care" labels to the carton, or otherwise so mark with a crayon of bright color. Ship by parcel post or prepaid express; note that a carrier cannot be held responsible for damage in transit if, in HIS OPINION, the article is inadequately packed for shipment.



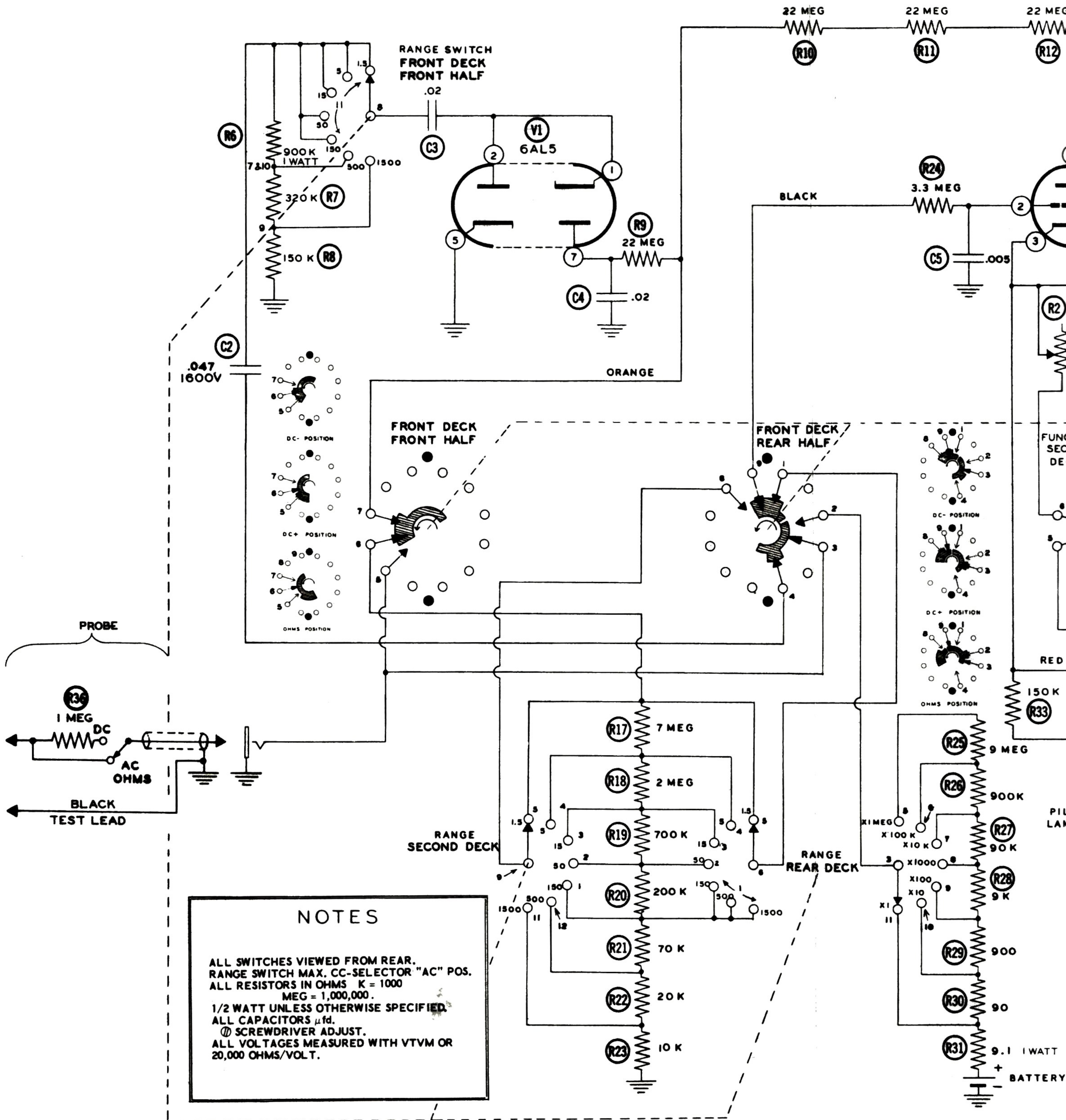

NOTES

ALL SWITCHES VIEWED FROM REAR.
 RANGE SWITCH MAX. CC-SELECTOR "AC" POS.
 ALL RESISTORS IN OHMS K = 1000
 MEG = 1,000,000.
 1/2 WATT UNLESS OTHERWISE SPECIFIED.
 ALL CAPACITORS μ fd.
 Ⓞ SCREWDRIVER ADJUST.
 ALL VOLTAGES MEASURED WITH VTVM OR
 20,000 OHMS/VOLT.





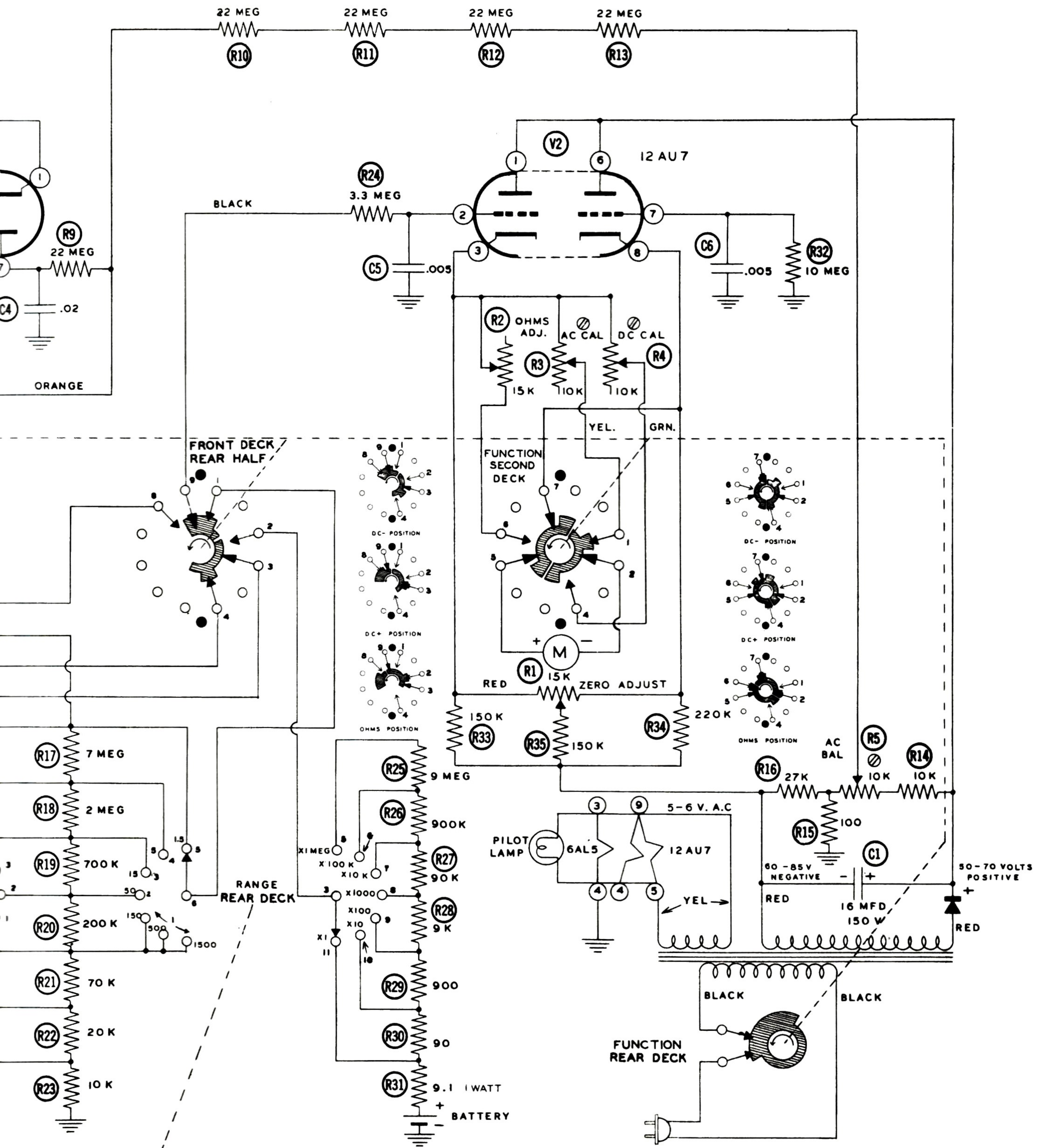









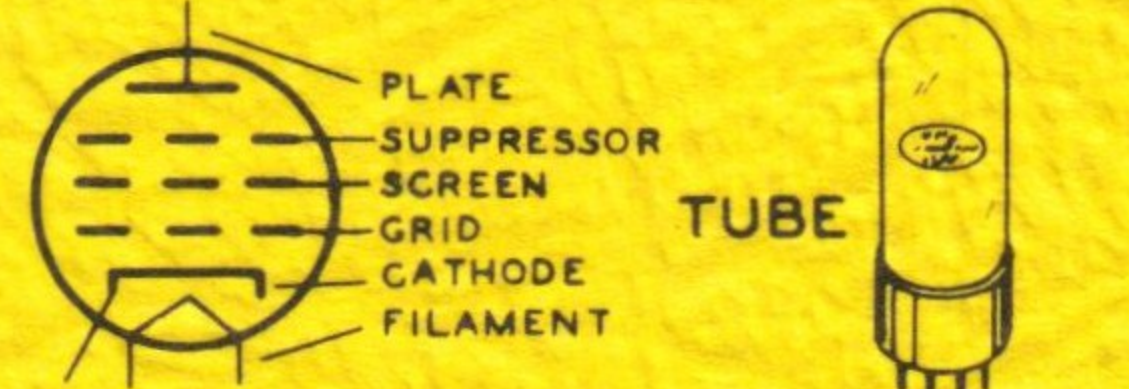









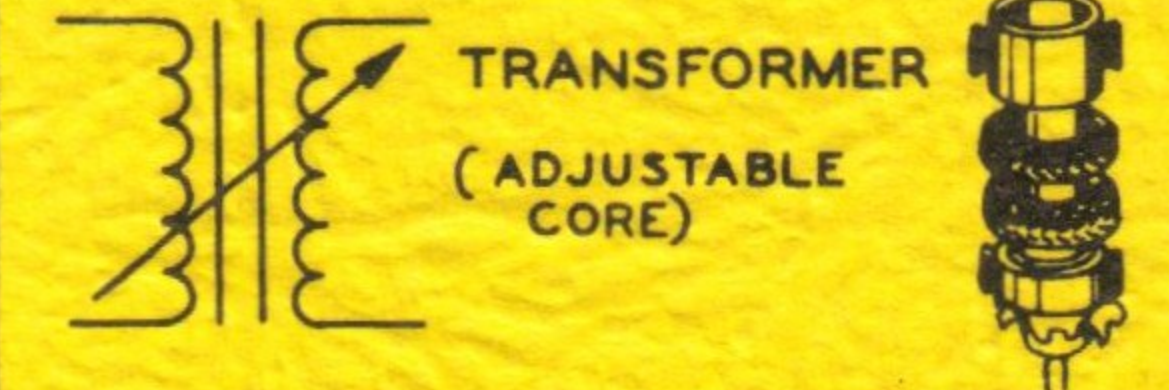

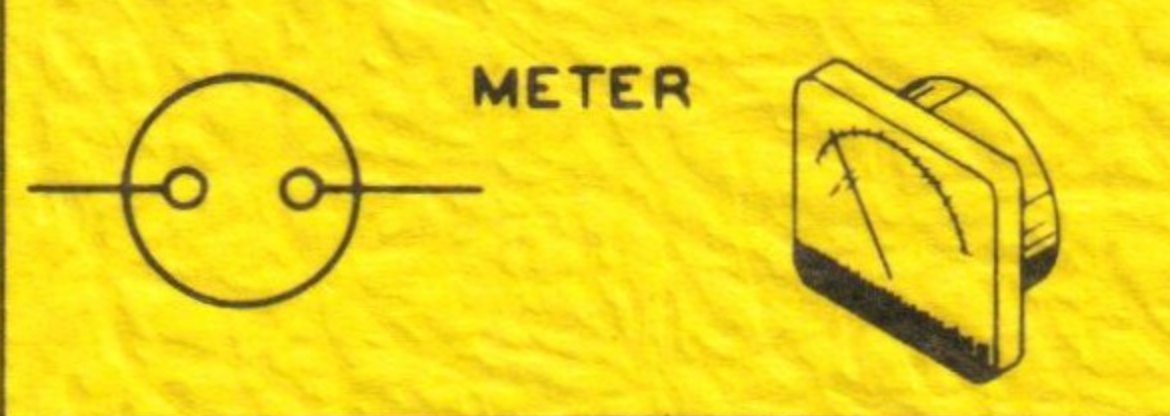
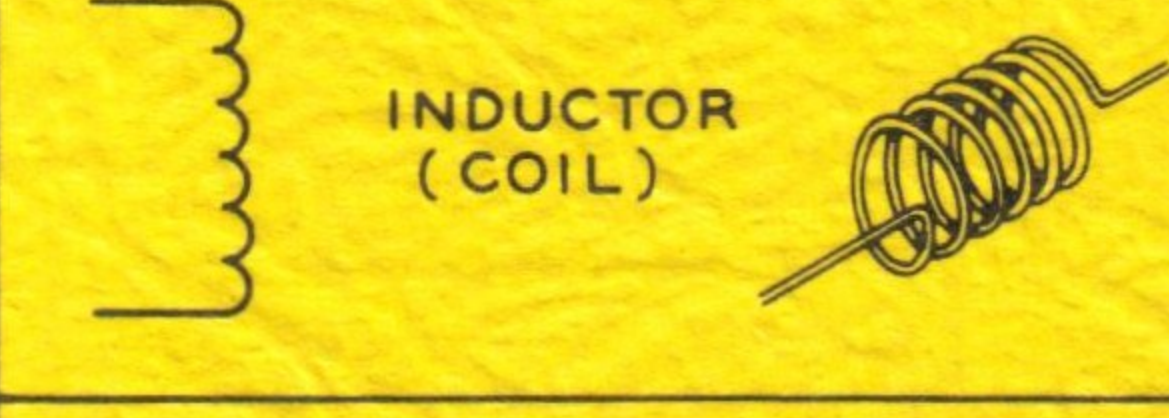

VTVM MODEL IM-11

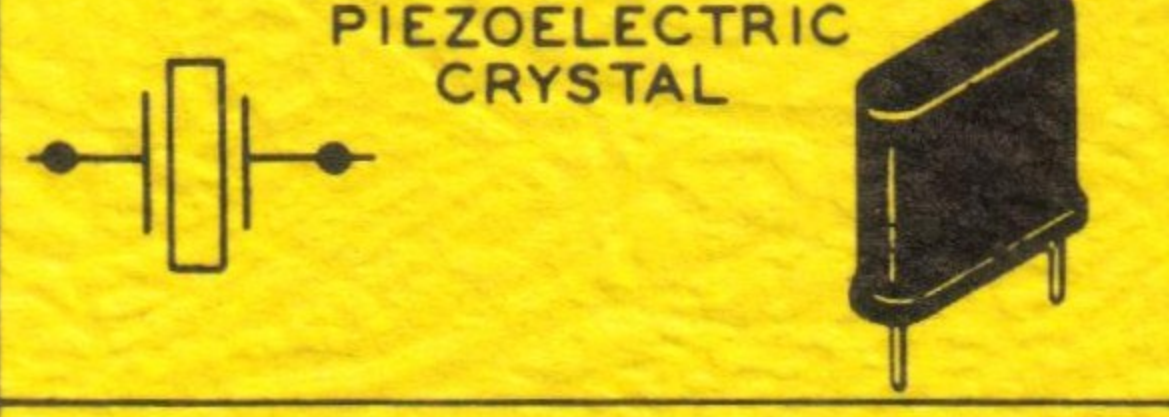

TYPICAL COMPONENT TYPES

This chart is a guide to commonly used types of electronic components. The symbols and related illustrations

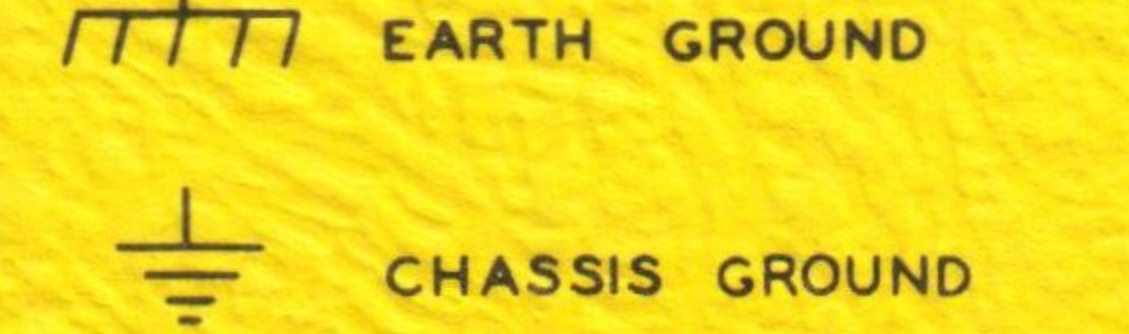
should prove helpful in identifying most parts and reading the schematic diagrams.

<p style="text-align: center;">RESISTOR</p> 	<p style="text-align: center;">CAPACITOR</p> 	<p style="text-align: center;">TUBE</p> 
<p style="text-align: center;">POTENTIOMETER (CONTROL)</p> 	<p style="text-align: center;">ELECTROLYTIC CAPACITOR</p> 	<p style="text-align: center;">TRANSISTOR</p> 
<p style="text-align: center;">TRANSFORMER (IRON CORE)</p> 	<p style="text-align: center;">VARIABLE CAPACITOR</p> 	<p style="text-align: center;">RECTIFIER (DIODE)</p> 
<p style="text-align: center;">TRANSFORMER (ADJUSTABLE POWDERED IRON CORE) ARROW INDICATES DIRECTION OF CORE MOVEMENT TO INCREASE INDUCTANCE</p> 	<p style="text-align: center;">BATTERY</p> 	<p style="text-align: center;">NEON BULB</p> 
<p style="text-align: center;">TRANSFORMER (ADJUSTABLE CORE)</p> 	<p style="text-align: center;">PHONO JACK</p> 	<p style="text-align: center;">ILLUMINATING BULB</p> 
<p style="text-align: center;">POWER TRANSFORMER</p> 	<p style="text-align: center;">PHONE JACK</p> 	<p style="text-align: center;">METER</p> 
<p style="text-align: center;">INDUCTOR (COIL)</p> 	<p style="text-align: center;">RECEPTACLE</p> 	<p style="text-align: center;">SWITCH (TOGGLE)</p> 
<p style="text-align: center;">PIEZOELECTRIC CRYSTAL</p> 	<p style="text-align: center;">SPEAKER</p> 	<p style="text-align: center;">SWITCH (ROTARY)</p> 
<p style="text-align: center;">BINDING POST</p> 	<p style="text-align: center;">MICROPHONE</p> 	<p style="text-align: center;">FUSE</p> 
<p style="text-align: center;">ANTENNA</p> 	<p style="text-align: center;">EARTH GROUND</p>  <p style="text-align: center;">CHASSIS GROUND</p> 	<p style="text-align: center;">CONDUCTORS</p> 



THE WORLD'S FINEST ELECTRONIC EQUIPMENT IN KIT FORM

Heathkit IM-11 . . . The World's Most Popular VTVM



SINGLE PROBE CONVENIENCE

Single, all-purpose probe with hook for all functions and unique clip-action for hands-free connections.



CIRCUIT BOARD ASSEMBLY

For uniformity and stability, as well as easy construction, the Heathkit IM-11 uses a printed circuit board for minimum component wiring.



PRECISION RESISTORS

The IM-11 voltage divider network uses precision (1%) resistors to provide high measurement accuracy.

Price Is Only One Of The Many Reasons For The Popularity Of The IM-11 VTVM

- Proven through experience to have the most popular steel—the most popular features • One probe makes all measurements • 7 AC, 7 DC, 7 Ohms ranges • Two-color scales are easy to read • Precision, sensitive, high-quality 475" 200 μ A motor • 1% precision divider network resistors • Extended frequency response \pm 1 dB 25 Hz to 1 MHz • Maximum RMS and peak-to-peak AC voltage • Circuit board construction for easy assembly and exceptional stability

THE WORLD-FAMOUS HEATHKIT IM-11 VTVM HAS UNDOUBTEDLY CONTRIBUTED MORE TO THE FIELD OF ELECTRONICS THAN ANY OTHER BASIC SERVICE INSTRUMENT. Thousands have been sold. IM-11's are found in home workshops, service shops, electronics and engineering laboratories, and scientific laboratories the world over. They are used as basic instrumentation for many high school, college, and vocational courses in electronics. And only recently the IM-11 was chosen to be part of the Heath Instrumentation Group for the Berkeley Physics Laboratory . . . a sophisticated college-level course, using up-to-date electronic instrumentation for teaching the fundamental principles of physics.

EXAMINE THE IM-11 MORE CLOSELY. In addition to the improved features mentioned, functions include AC volts (RMS), AC volts (peak-to-peak), DC volts, resistance and decibel measurements. Precision 1% resistors and the high, 11 megohm input resistance assure high accuracy by minimizing circuit loading of the unit under test. Front panel controls include a rotary function switch (with DC polarity reversing position to eliminate lead changing when alternately measuring positive & negative voltages), a rotary range selector, and Zero Adjust & Ohms Adjust controls.

WHAT'S MORE, THE SINGLE, SIMPLE PLUG-IN CONNECTOR FROM TEST LEADS TO METER IS DESIGNED WITH YOU IN MIND . . . helps avoid tangled test leads . . . saves you time in changing

KR IM-11

Wired IRW-11

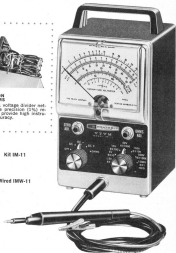

from standard to RF or High Voltage probes. The slim, all-purpose test probe supplied with the IM-11 permits switch-selection of AC, Ohms, & DC functions, and is equipped with a miniature "hook" permitting the probe to be clipped to component leads for "hands-free" circuit testing.

CHECK THE IM-11 SPECIFICATIONS. You'll agree that for all-around performance in the electronics industry, there's not a better buy than the Heathkit VTVM.

KR IM-11, 5 lbs.

Assembled IRW-11, 5 lbs.

Export model available for 115/230 VAC, 50-60 Hz.

IM-11 SPECIFICATIONS—Meter scales: DC & AC (RMS): 0-10, 0-100, 50-500, 1000 volts full scale. AC peak-to-peak: 0.0, 10, 40, 140, 450, 1400, 4500. Resistance: 10 ohm center scale \times 10, 100, 1000, \times 10k, \times 100k, \times 1 meg. Measure \times also to 1000 meg-ohms. Meter: 475" 200 μ A movement. Multiplier: 1% precision type. Input resistance: DC: 11 megohm \pm 5% (open in parallel on all ranges). Ohms: Balanced bridge loads pull string from bridge. Accuracy: DC: \pm 0.5%, AC: \pm 0.7% of full scale. Frequency response: \pm 1 dB, 25 Hz to 1 MHz (500 ohm source). Tubes: 12AX7, 6AL5. Battery requirements: 1.5 volt, size "C" flashlight cell (not supplied). Power requirements: 100-125 volt 50-60 Hz AC, 10 watts. Dimensions: 7 1/2" H \times 4 1/2" W \times 4 1/2" D.

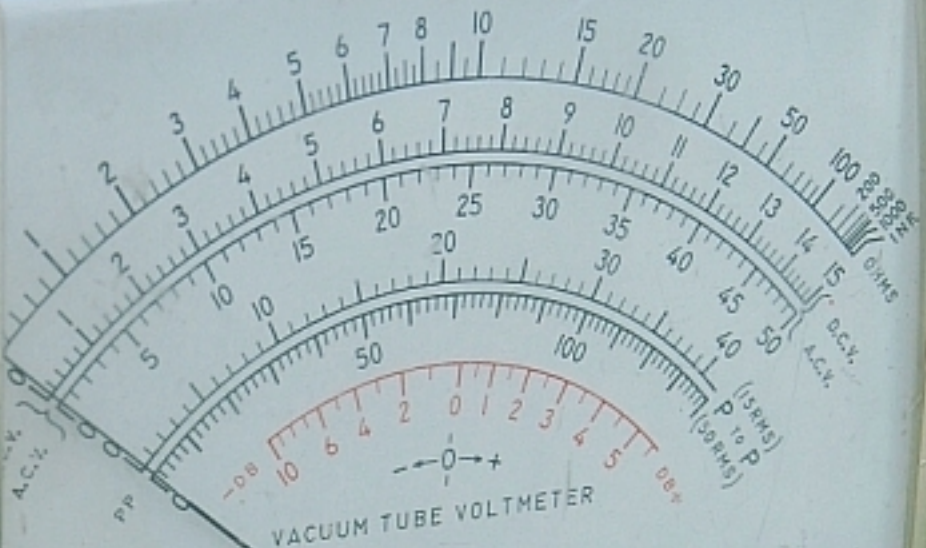

ZERO
ADJ.

HEATHKIT
A Division of
Radio Shack

VTVM
MODEL IM-11

OHMS
ADJ.

AC • DC - • DC +
OFF • OHMS

50V RX1000
15V RX100
5V RX10
1.5V RX1
150V RX10K
500V RX100K
500V RX1 REG.

