

Continuity Tester

A simple but invaluable testing device that's a vast improvement on simple buzzer type continuity testers.

JOHN RUGG

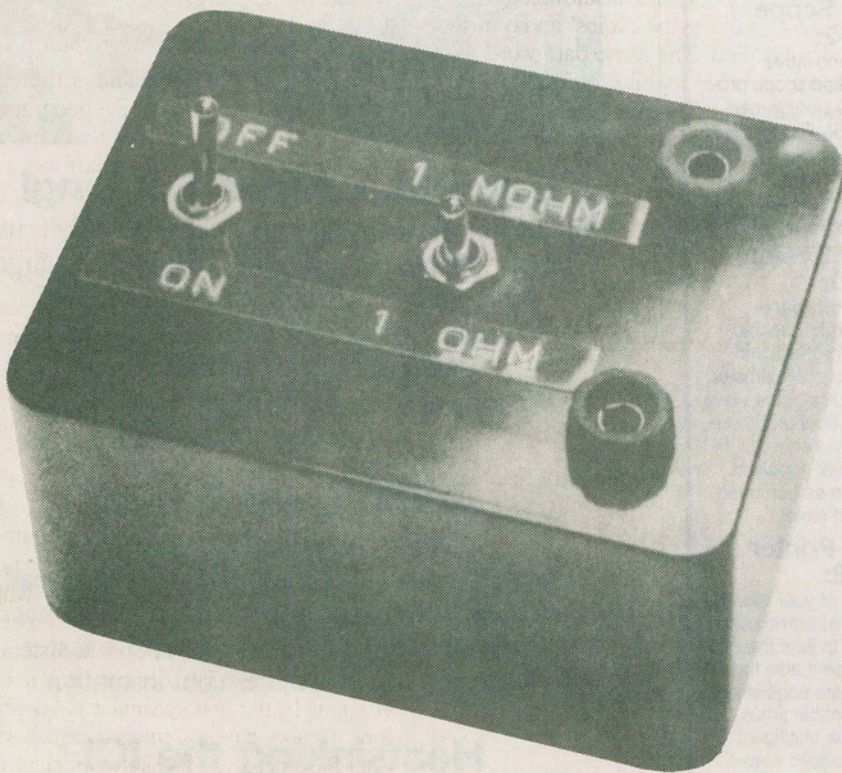

Most of us at one time or another have needed to use a continuity tester. Perhaps the most common domestic example is that of testing whether or not a fuse has blown in the plug of some household appliance. In this sort of situation, where the resistance of the component under test can be one of two widely separated values (*ie*, zero ohms for a good fuse, infinity ohms for a dud one), all circuit testers will perform satisfactorily.

For the home electronics enthusiast, things are never so simple. In any circuit, normal resistances are scattered over a very large range, so tracking down a fault is more tricky. For example, a continuity tester that operates an LED for resistances of less than 100 ohms will be useless if you are trying to confirm that a 47 ohm resistor is correctly connected.

Can continuity testers be this bad, I hear you ask? The answer is most definitely yes. Continuity buzzers fitted to digital multimeters (DMMs) typically show continuity for resistances up to a couple of hundred ohms, and one tester I used showed continuity for resistances of several kilohms.

This really begs the question of what we expect a continuity tester to do. What might the characteristics of the ideal device be?

(a) The most important is that the device should be able to detect a short circuit. By my definition this means resistances of less than about one ohm (not 200 ohms). With this sort of performance we'll be able to find bad connections that have resistances greater than one ohm, and check that very low value resistors are correctly connected in any circuit.

(b) As well as short circuits, the device must be able to detect open circuits (say, greater than about one megohm). This is ideal for checking isolation between tracks on a board (Verostrip, etc).

(c) Diodes and transistors should not cause the device to give false readings (a diode is not a short circuit).

(d) The device should consume no power and occupy no space. This means you don't have to buy batteries very often and it fits in your pocket.

Basic Principle

The fact that we have to decide whether the resistance between the test probes is greater than or less than a certain value (one ohm or one megohm), means that we are performing a comparison. This im-

Continued on page 22

Continuity Tester Continued from page 19

mediately suggests that we might be able to use a comparator. A standard bridge network is ideal for this sort of application and the circuit diagram Fig. 1 shows the basic scheme.

When resistors $R1/R2 = Rx/R3$, the input voltages to the comparator are equal. If we make $R1 = R2 = R3 =$ one ohm, then if Rx is less than one ohm the comparator's positive input is highest, and the output is high. Conversely, if Rx is greater than one ohm, then the output will be low. If we now change $R3$ to one megohm by using a switch, then we have a device that will detect open circuits too.

The "sense voltage" is the voltage that appears between the test probes for an open circuit. If the sense voltage was 2V, diodes would appear as a short circuit, since with a forward voltage drop of 0.7V,

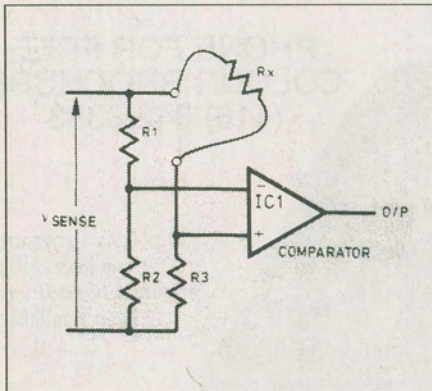

Fig. 1. Basic comparator principle.

the positive input of the comparator would be highest.

This is clearly no good (unless we want to use the device to check diode polarity). Another reason for reducing the sense voltage is that we do not want to damage the circuit under test by applying large voltage biases between two parts of an unpowered circuit. Therefore, a sense voltage of 0.2V has been chosen for this design.

Moving on to consider power consumption, since we are using a linear IC (the comparator) we will probably need a supply voltage of at least 6V. A 9V battery is appropriate since they're small and easily available.

With the circuit so far described, a short circuit between the probes will cause a current of $I = V/R = 0.2V/1ohm = 200mA$ to flow. This is far too large if we want the battery to last very long.

The other thing we must consider is how to generate the sense voltage in the first place. Fig. 2 shows how these problems can be overcome.

In order to reduce the current, resistor $R5$ has been added. Both $R3$ and $R5$ are 220 ohms. We have now complicated the issue by trying to resolve the difference between 220 ohms and 221 ohms. In this situation the input offset voltage of the comparator has a direct impact on the resistance resolution. Varying Rx from 0 to 1 ohm will change the voltage on the comparator positive input by one ohm x

$0.2V/(R3 + R5) = 0.5mV$. This has to be sufficient difference for the comparator to change state.

Comparators are normally optimized for fast switching applications. Since we do not need fast switching performance in this application, we can use an op amp IC instead. An ideal power economic op amp IC is the LM308. It has a current consumption of just 0.3mA and an input offset voltage of 2mV. The offset looks too large for our needs, but in fact this does not turn out to be a difficulty.

Output

An important consideration is the type of output we require from the tester. LED outputs are simple to implement, but take a lot of current (10mA-15mA). Also, and perhaps more importantly, it is often difficult to look at the test probes (to keep them in the right place) and an LED indicator some distance away, at the same time. An audio output, however, is just what the doctor ordered to reduce this sort of eyestrain.

Using a conventional eight ohm speaker will be wasteful of power, and a preferable method is to use a piezoelectric transducer. A suitable audio interface circuit diagram is shown in Fig. 3.

Since the output of the op amp will be neither high (9V) or low (0V) for marginal values of resistance but somewhere in between, a Schmitt trigger buffer is needed to turn it into a clean on/off signal. See Fig. 4.

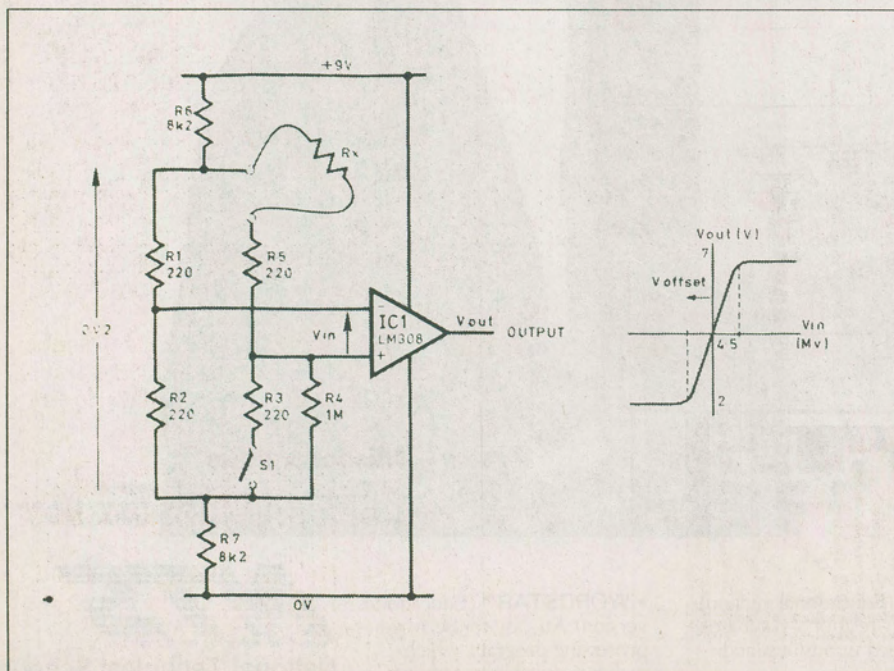

Fig. 2. Improved sense network.

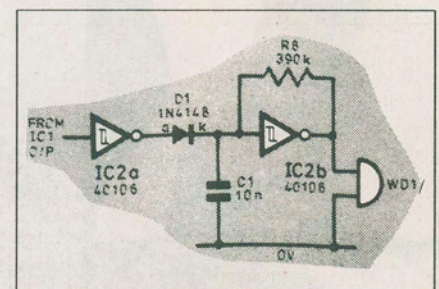

Fig. 3. Audio output stage.

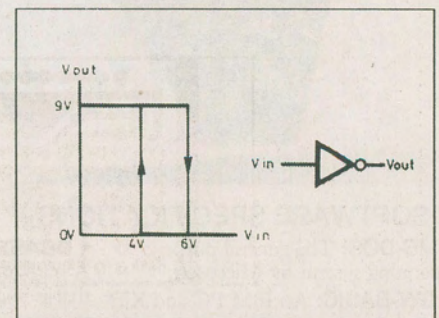

Fig. 4. Schmitt trigger characteristics.

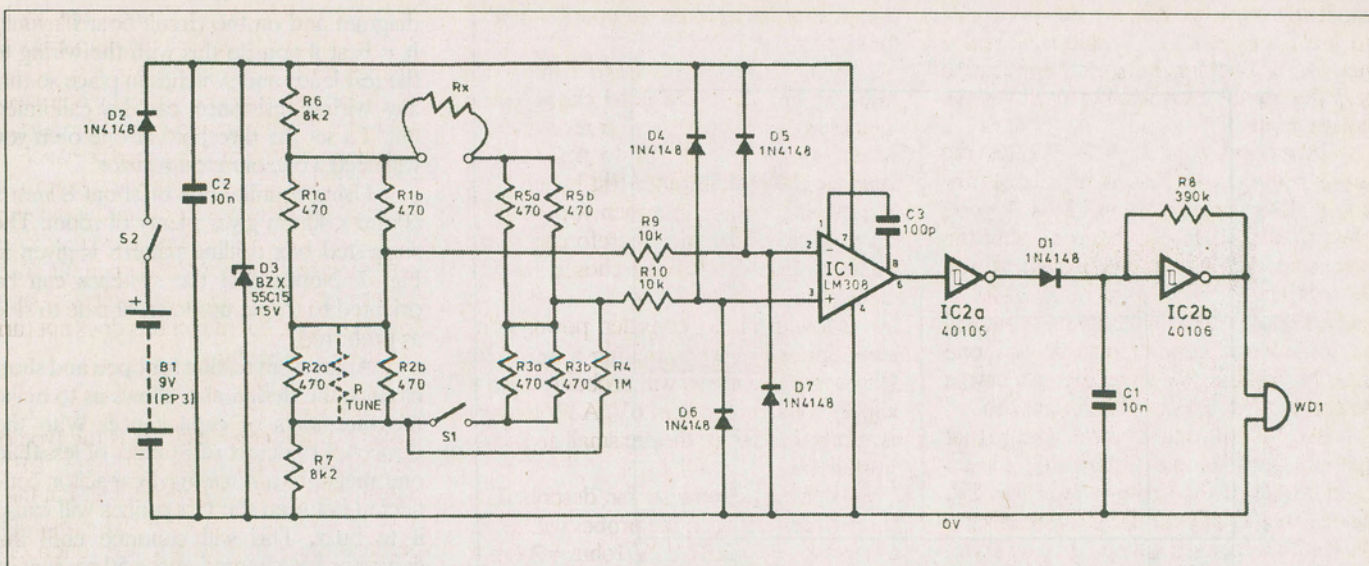

Fig. 5. Complete schematic for the Continuity Tester.

By effectively introducing this threshold on the op amp output, the resolution of the device is increased over what one might expect given the input offset of the op amp. The CMOS CD40106 (IC2) is a good choice here since it consumes virtually no power and will run happily from a 9V rail.

There are six Schmitt inverters on the chip and we can use one of the others to make a square wave oscillator. The values of R and C are chosen to give an audio output of about 1kHz but the exact frequency can vary depending on the

thresholds provided by the Schmitt inverter. By varying R or C slightly you will be able to produce a tone your are happy with.

The piezo-electric transducer WD1 is driven directly by the oscillator output. The oscillator output is disabled when the first inverter output is high.

This leaves four other inverters that are spare. If you wish these can be used to drive an LED indicator (all connected in a parallel configuration), or to produce two tones (one for one megohm, one for one ohm).

PARTS LIST

Resistors

All 0.25W 5%, except where stated.

R1a,b, R2a,b, R3a,b, R5a,b	470
	.25W 1%
R4	1M
R6,7	.8k2
R8	.390k
R9,10	10k
Rtune	(see text)

Capacitors

C1,2	10n
C3	100p

Semiconductors

D1,2,4 to D7	1N4148 signal diode
D3	15V Zener diode
IC1	LM308 op amp
IC2	40106 Schmitt trigger

Miscellaneous

S1,2	spdt toggle switch
WD1	piezoelectric transducer

Case, test lead sockets, black and red; 9V battery and connector; connecting wire; solder; etc.

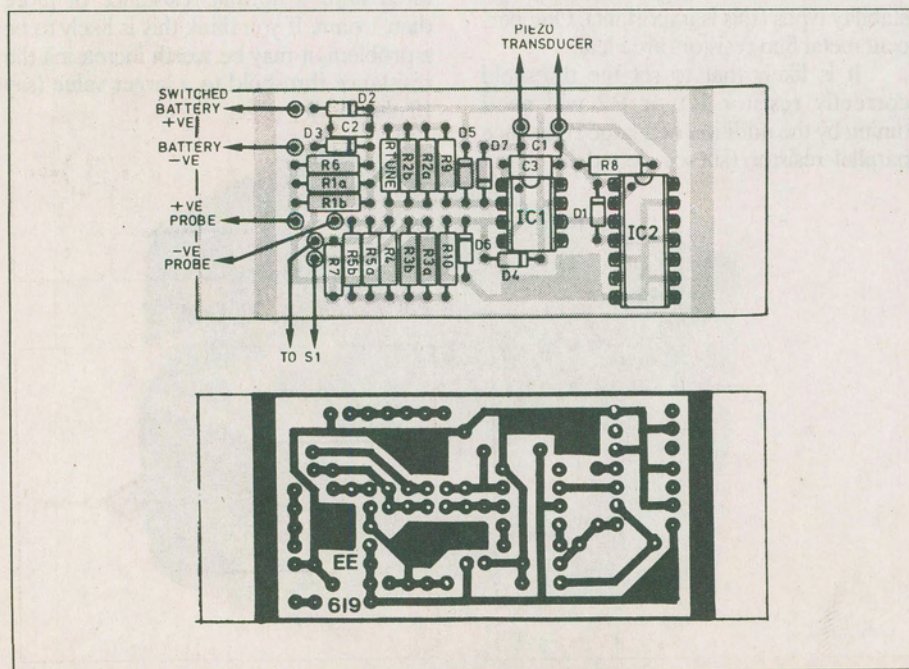

Fig. 6. The PCB layout and wiring for the Continuity Tester.

Continuity Tester

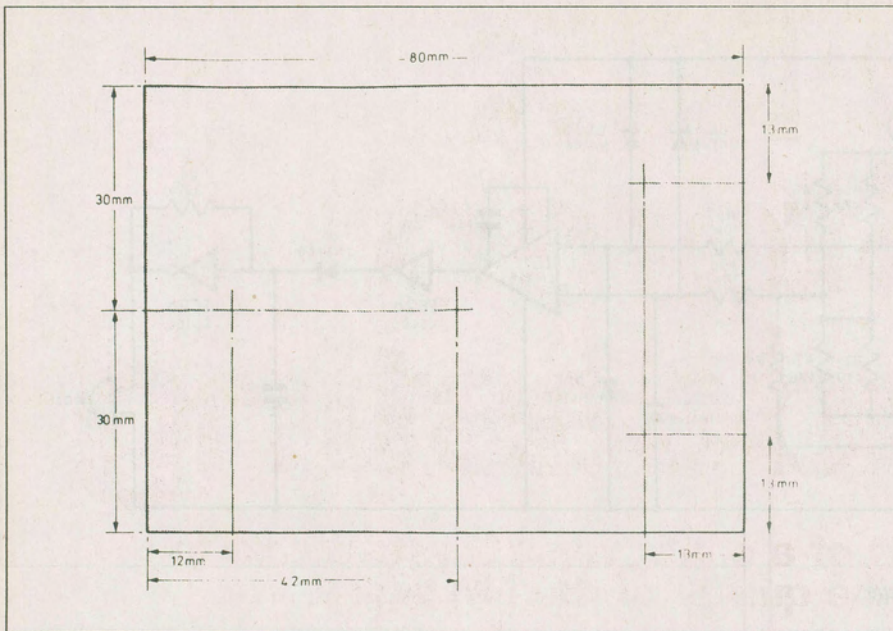

Fig. 7. The case drilling details for the size of case listed in the text; other sizes can be used.

Idiot Proofing

The design given so far will perform well in tests on unpowered circuitry. However, it is inevitable that eventually it will be used on powered circuitry by mistake. We have to make sure that the tester is not destroyed. One might expect the worst case to be connection across a plus and minus 15V supply, or 30V between the test probes.

From Fig. 2 there are several ways in which damage could occur:

(a) Resistors R1, R2, R3, R5 get hot. 30V across 4 x 220 ohms gives 1/4W of power dissipation in each resistor.

(b) Current will try to get pumped into the battery.

(c) Op amp input pins may be biased at voltages outside the voltage appearing at the supply pins.

(d) If the supply rail exceeds 20V, the CMOS chip will fail.

Final Circuit

The complete circuit diagram for the Continuity Tester, Fig 5, shows how we can protect against the above problems. Resistors R1, R2, R3, R5 are now pairs of 470 ohm (1/4W) resistors rather than single 220 ohm resistors (alternatively single 1/2W 220 ohm resistors could be used). These will be able to withstand the additional power consumption.

Diode D2 prevents current going into the battery, and the Zener diode D3 stops

the supply rail exceeding 15V. Resistors R9, R10, and diodes D4 to D7 prevent overvoltage and overcurrent of IC1 op amp inputs.

Construction

The printed circuit board and full-size copper foil master pattern for the Continuity Tester is shown in Fig. 6.

Construction requires no special consideration, except that the resistors R1, R2, R3, and R5 be high tolerance, high stability types (this is important). One percent metal film resistors are ideal.

It is likely that to set the threshold correctly resistor R1 or R2 will need tuning by the addition of a large resistance parallel resistor (shown dotted in circuit

diagram and on the circuit board layout.) It is best if you do this with the wiring to the test leads and switches in place so that any wiring resistance can be calibrated out. To set the threshold at one ohm you will need a one ohm test resistor.

Using a utility box of about 80mm x 60mm x 40mm gives plenty of room. The suggested box drilling pattern is given in Fig. 7. Notice that the switches can be oriented to toggle up/down or side to side as preferred.

Apart from testing for open and short circuits, the design also allows us to make measurements of capacitance. With the device set to detect resistances of less than one megohm a discharged capacitor connected between the test probes will cause it to buzz. This will continue until the capacitor has charged above 50 percent of the sense voltage, when the buzzing will stop.

This behaviour can be well described mathematically, and it turns out that for the circuit values we have used the duration of the buzz (seconds) = $0.7 \times C$, where C is in microfarads. With the aid of a watch then, capacitors in excess of 1uF can be measured. However, larger electrolytic capacitors can be leaky and if the leakage current exceeds 100uA then the Continuity Tester will not stop buzzing.

The tester is ideal for testing domestic fuses, but be careful when it comes to testing very low current fuses, since these often have a normal resistance of more than 1 ohm. If you think this is likely to be a problem, it may be worth increasing the resistance threshold to a larger value (say 10 ohms). ■

