

Autoranging CombiScope™ Instrument

PM3370B-PM3380B-PM3390B
PM3384B-PM3394B

Users Manual

2/1- Nov-1998

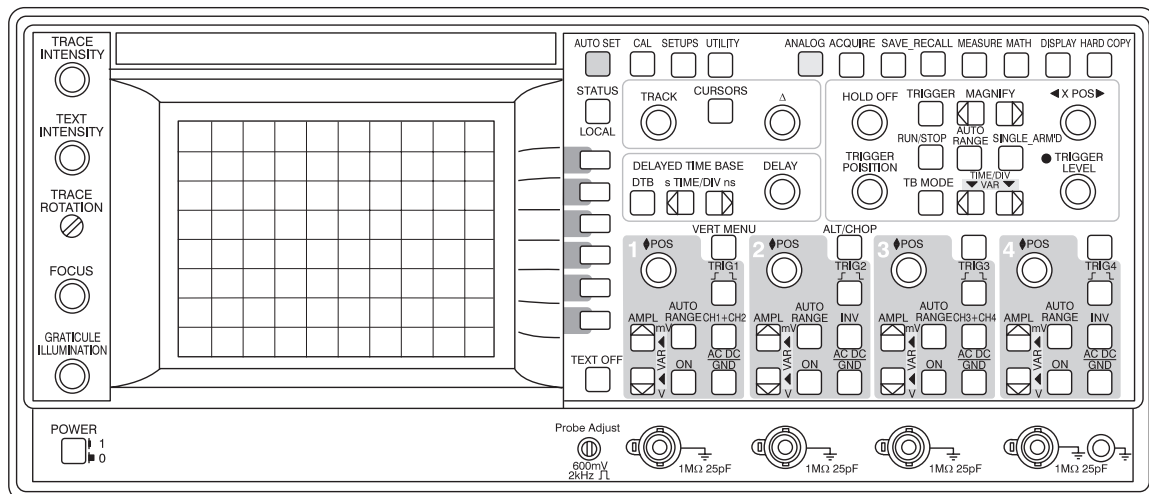

ST7721A

FLUKE®

IMPORTANT

In correspondence concerning this instrument please give the model number and serial number as located on the type plate on the rear of the instrument.

NOTE: The design of this instrument is subject to continuous development and improvement. Consequently, this instrument may incorporate minor changes in detail from the information provided in this manual.

Fluke Corporation
P.O. Box 9090
Everett WA
98206-9090, USA

Fluke Industrial B.V.
P.O. Box 680
7600 AR Almelo
The Netherlands

Copyright © 1997, 1998 Fluke Corporation
All rights reserved. No part of this manual may be reproduced by any means or in any form without written permission of the copyright owner.

Printed in the Netherlands

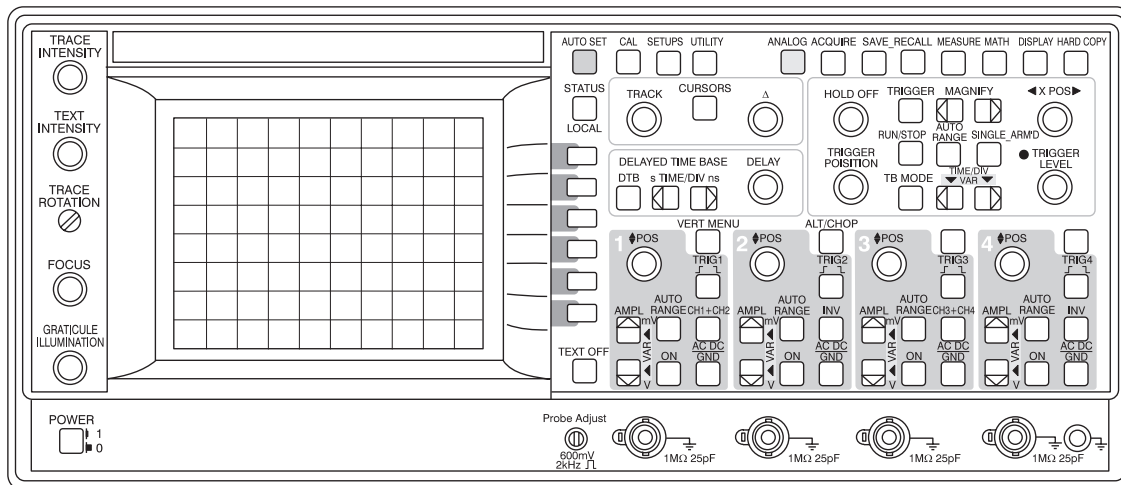

ST7721A

Thank you for purchasing this FLUKE oscilloscope. It has been designed and manufactured to the highest quality standards to give you many years of trouble free and accurate measurements.

The powerful measuring functions listed below have been combined with an easy and logical operation to let you use the full power of this instrument each and every day.

If you have any comments on how this product could be improved, please contact your local FLUKE organization. FLUKE addresses are listed in the back of the REFERENCE MANUAL.

The REFERENCE MANUAL also contains:

- CHARACTERISTICS AND SPECIFICATIONS
- PRINCIPLES OF OPERATION
- BRIEF CHECKING PROCEDURE
- PERFORMANCE TEST PROCEDURES
- PREVENTIVE MAINTENANCE PROCEDURES

MAIN FEATURES

There are five models in this family of FLUKE oscilloscopes. Each of these models is a combination of an analog real-time oscilloscope and a fully featured digital storage oscilloscope. By pressing a single key, you can switch the instrument from the analog mode to the digital mode and back. This allows each of the units to be used in an optimum operating mode for all kinds of signal conditions. Complex data streams, modulated waveforms, and video signals can often best be seen in the analog mode of operation. The digital mode of operation is more suited for single events, signals with low repetition frequencies, and when automatic measurements need to be performed.

In this family there is a choice of five models. Two models have a bandwidth of 200 MHz, two have a bandwidth of 100 MHz and one has a bandwidth of 60 MHz. Beside the 2 channel models with EXT TRIG input, there is a choice of two models with four fully featured channels, all shown in the following table:

Type Number	Bandwidth	Sample rate	Number of Channels	Input Impedance
PM3370B	60 MHz	200 MS/s	2	1 M Ω
PM3380B	100 MHz	200 MS/s	2	1 M Ω
PM3384B	100 MHz	200 MS/s	4	1 M Ω
PM3390B	200 MHz	200 MS/s	2	1 M Ω /50 Ω
PM3394B	200 MHz	200 MS/s	4	1 M Ω /50 Ω

In the same instrument family, there are two 200-MHz and two 100-MHz analog oscilloscopes that have specifications similar to the above-mentioned analog/digital combination oscilloscopes operating in analog mode.

All analog/digital combination oscilloscopes listed above have the following features:

- Autoranging attenuators.
- Realtime clock.
- 32K sample acquisition memory in 4 channel versions.
- 8K sample acquisition memory, expandable to 32K in 2 channel versions.
- Up to 40 waveforms stored in memory or 204 waveforms with optional memory extension.
- Autoset function for an instant optimized signal display at the touch of a button.
- Autoranging timebase.
- Cursor measurements with 1% accuracies.
- Extensive set of fully automated voltmeter and time measurement functions.
- Probe operated 'Touch Hold and Measure' function freezes the display and instantly displays the signal frequency, amplitude and dc voltage level.

-
- Peak detection for the capture of glitches as narrow as 5 ns.
 - Pattern, State and Glitch triggering (2 ns) (2 channel models; 4ns Glitch triggering only)
 - Event delay and pretriggering and posttriggering.
 - TV triggering including HDTV and TV line selection.
 - Serial interface for printing and plotting.
 - Averaging to reduce signal noise and to increase the vertical resolution from 8 to 16 bits.
 - Advanced mathematics, including digital low-pass filtering. A Math+ option adds integration, differentiation, histogramming, and FFT.
 - Sine interpolation and magnification which enables true to life four channel single shot acquisitions with a timebase up to 625 ns/div (32x magnified)
 - A delayed timebase with full trigger features.
 - An RS-232 (EIA-232-D) interface (standard) and an GPIB/IEEE-488 interface (optional).
 - Autocal for automatic fine tuning of all circuitry to achieve maximum accuracy under all user conditions.
 - Closed case calibration for efficient maintenance of traceable calibration at minimum cost.

The following options are available:

- A MATH+ option with more automated measurement functions including envelope and measurement pass/fail testing. Also included in this option are Integration, Differentiation, Histogramming, and FFT.
- Memory extension offering 32K acquisition length and the ability to store 156 traces (of 512 samples each) in memory for 2 channel versions.
- IEEE-488.2 interface using the new SCPI (Standard Commands for Programmable Instruments) industry standard for remote control of test and measurement equipment.

INITIAL INSPECTION

Check the contents of the shipment for completeness and note whether any damage has occurred during transport. When the contents are incomplete or there is damage, file a claim with the carrier immediately. Then notify the FLUKE Sales or Service organization to arrange for the repair or replacement of the instrument or other parts. FLUKE addresses are listed in the back of the REFERENCE MANUAL.

The following parts should be included in the shipment:

	Service ordering number or model number
1 Oscilloscope	PM3370B, PM3380B or PM3390B, PM3384B or PM3394B
1 Front cover	5322 447 70121
1 Users Manual	
1 Reference Manual	
1 Line cord (European type) or	5322 321 21616
1 Line cord (North American type) or	5322 321 10446
1 Line cord (British type) or	5322 321 21617
1 Line cord (Swiss type) or	5322 321 21618
1 Line cord (Australian type)	5322 321 21781
2 Probes 10:1	
2 Batteries	AA (LR6)
1 Spare fuse 3.15 AT (located inside fuse holder)	4822 070 33152

The performance of the instrument can be tested by using the PERFORMANCE TESTS in the REFERENCE MANUAL.

INSIDE THIS MANUAL

This operating guide contains information on all of the oscilloscope's features. It starts with a general introduction, a summary of main capabilities, initial inspection note and a front and rear view.

Operators safety	Chapter 1 should be read before unpacking, installing, and operating the instrument.
Installation instructions	Chapter 2 describes grounding, line cord, fuses, and backup batteries.
Getting started	Chapter 3 provides a 10-minute tutorial intended for those who are not familiar with Fluke oscilloscopes.
How to use more advanced functions of the instrument	Chapter 4 provides the more experienced user with a detailed explanation of the major functions of the oscilloscope.
Function reference	Chapter 5 contains an alphabetized description of each function. Each description includes an explanation of local and remote control functions.
CPL protocol	Chapter 6 provides the CPL commands with an example of each.
Function index	The Function Index lists all implemented functions in alphabetical order.
Index	The overall index contains all function names and reference words in alphabetical order. It includes the relevant chapter and page number where more detailed information can be found.

IN THE APPENDICES

Menu structures

RS-232 Cable configurations

CONTENTS	Page
1 OPERATORS SAFETY	1-1
1.1 INTRODUCTION	1-1
1.2 SAFETY PRECAUTIONS	1-1
1.3 CAUTION AND WARNING STATEMENTS	1-1
1.4 SYMBOLS	1-2
1.5 IMPAIRED SAFETY PROTECTION	1-2
1.6 MEASURING EARTH	1-2
2 INSTALLATION INSTRUCTIONS	2-1
2.1 SAFETY INSTRUCTIONS	2-1
2.1.1 Protective earthing	2-1
2.1.2 Mains voltage cord, mains voltage range and fuses	2-1
2.2 MEMORY BACK-UP BATTERIES	2-3
2.2.1 General information	2-3
2.2.2 Installation of batteries	2-3
2.3 THE FRONT COVER	2-3
2.4 HANDLE ADJUSTMENT AND OPERATING POSITIONS OF THE INSTRUMENT	2-4
2.5 IEEE 488.2/IEC 625 BUS INTERFACE OPTION	2-4
2.6 RS-232-C SERIAL INTERFACE	2-5
2.7 RACK MOUNTING	2-5
2.8 VERSIONS	2-5

3 GETTING STARTED	3-1
3.1 FRONT-PANEL LAYOUT	3-1
3.2 SWITCHING ON THE INSTRUMENT	3-2
3.3 SCREEN CONTROLS	3-3
3.4 AUTO SETUP	3-4
3.5 MODE SWITCHING BETWEEN ANALOG AND DIGITAL OPERATING MODES	3-6
3.6 VERTICAL SETUP	3-8
3.7 TIMEBASE SETUP	3-11
3.8 MAGNIFY (EXPAND)	3-12
3.9 DIRECT TRIGGER SETUP	3-13
3.10 PRE-TRIGGER VIEW	3-15
3.11 MORE ADVANCED FEATURES	3-16
3.12 CURSOR OPERATION	3-17
3.13 MORE ADVANCED TRIGGER FUNCTIONS	3-19
3.14 MORE SIGNAL DETAIL WITH THE DELAYED TIMEBASE	3-20
3.15 TRACE STORAGE	3-22
4 HOW TO USE MORE ADVANCED FUNCTIONS OF THE INSTRUMENT	4-1
4.1 INTRODUCTION	4-1
4.2 DISPLAY AND PROBE ADJUSTMENTS	4-5
4.3 ANALOG AND DIGITAL MODES	4-9
4.4 VERTICAL DEFLECTION	4-13
4.5 HORIZONTAL DEFLECTION AND TRIGGERING	4-22

4.6	DIGITAL ACQUISITION AND STORAGE	4-30
4.7	ADVANCED VERTICAL FUNCTIONS	4-31
4.8	ADVANCED HORIZONTAL AND TRIGGER FUNCTIONS	4-34
4.9	MEMORY FUNCTIONS	4-39
4.10	CURSORS FUNCTIONS	4-44
4.11	MEASUREMENT FUNCTIONS	4-49
4.12	PROCESSING FUNCTIONS	4-54
4.13	DISPLAY FUNCTIONS	4-57
4.14	DELAYED TIMEBASE	4-63
4.15	HARD COPY FACILITIES	4-68
4.16	AUTOSET AND SETUP UTILITIES	4-71
4.17	OTHER FEATURES	4-75
5	FUNCTION REFERENCE	5-1
6	THE CPL PROTOCOL	6-1
6.1	INTRODUCTION	6-1
6.2	EXAMPLE PROGRAM FRAME	6-3
6.3	COMMANDS IN FUNCTIONAL ORDER	6-4
6.4	COMMANDS IN ALPHABETICAL ORDER	6-5
6.5	COMMAND REFERENCE	6-6
6.6	ACKNOWLEDGE	6-47
6.7	STATUS	6-48
6.8	SETUP	6-50

Appendix A	ACQUIRE menu structure	A-1
Appendix B	CURSORS menu structure	B-1
Appendix C	DISPLAY menu structured	C-11
Appendix D	MATHEMATICS menu structure	D-1
Appendix E	MEASURE menu structure	E-1
Appendix F	DTB (DEL'D TB) menu structure	F-1
Appendix G	SAVE/RECALL menu structure	G-1
Appendix H	SETUPS menu structure	H-1
Appendix J	TB MODE menu structure	J-1
Appendix K	TRIGGER menu structure	K-1
Appendix L	UTILITY menu structure	L-1
Appendix M	VERTICAL menu structure	M-1
Appendix N	RS-232 Cable configurations	N-1
Appendix P	P-1
FUNCTION INDEX (see Chapter 5)		I-1
INDEX		I-3

FRONT VIEW

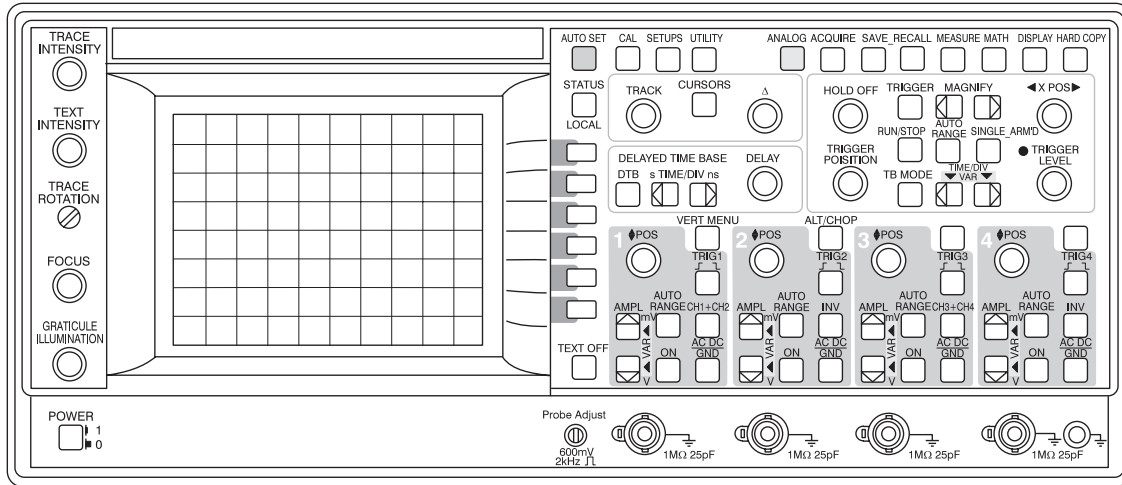

ST7721A

REAR VIEW

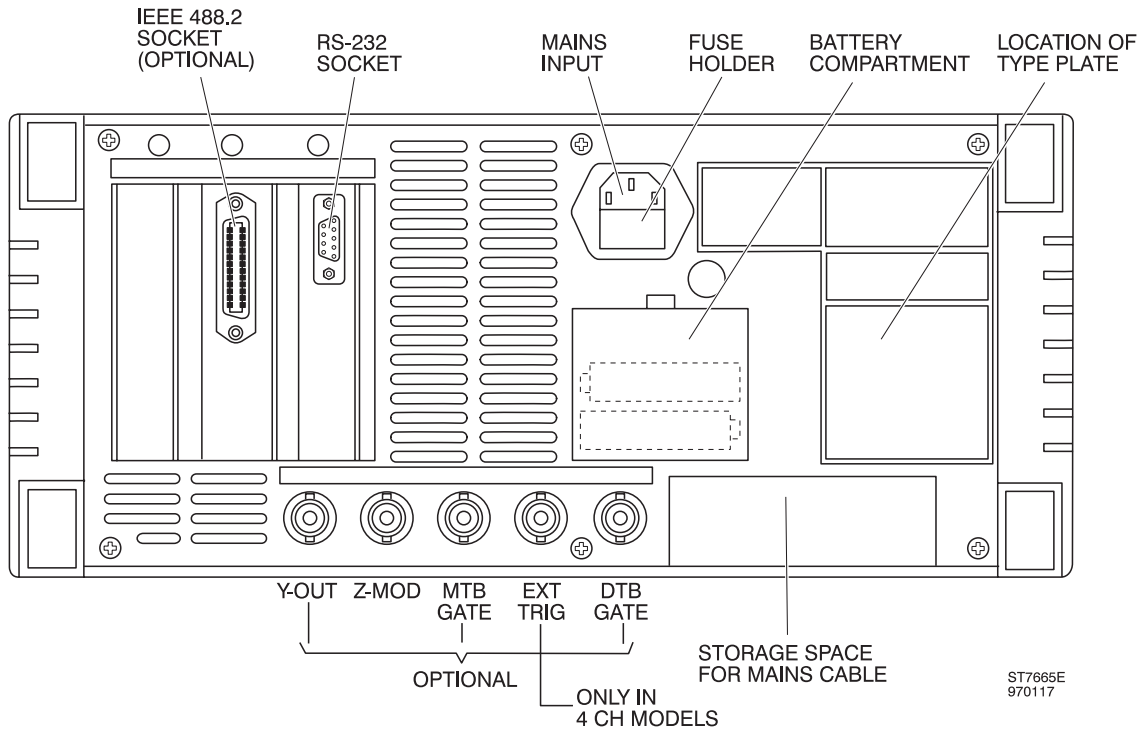

ST7665E
970117

FRONT PANEL CONNECTIONS



Probe Adjust

Squarewave output signal for e.g. probe calibration. Amplitude is calibrated.

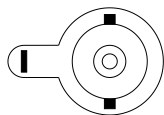

CH1

BNC input socket for vertical channel 1 with probe indication contact.

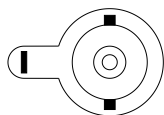

CH2

BNC input socket for vertical channel 2 with probe indication contact.

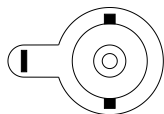

CH3

BNC input socket for vertical channel 1 with probe indication contact. (only in 4 channel models)

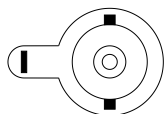

CH4

BNC input socket for vertical channel 1 with probe indication contact. (only in 4 channel models)

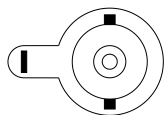

EXT TRIG

BNC input socket used as an extra external trigger input with probe indication contact (only in 2 channel models)



Ground socket (banana): same potential as safety ground.



The measuring ground socket and the external conductor of the BNC sockets are internally connected to the protective earth conductor of the three-core mains cable. The measuring ground socket or the external conductor of the BNC-sockets must not be used as a protective conductor terminal.

REAR PANEL CONNECTIONS

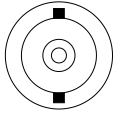

Z-MOD

BNC input socket for external intensity-modulation of the CRT trace.

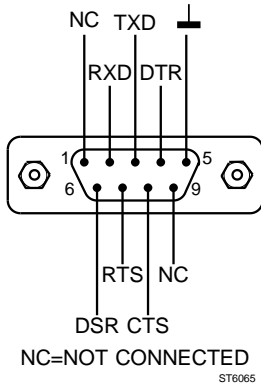

RS-232 BUS (EIA-232-D)

Input/output socket to connect the oscilloscope to an RS-232 Interface.

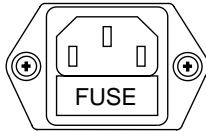

LINE IN

Line input socket. Fuse holder is built in.

OPTIONAL REAR PANEL CONNECTIONS

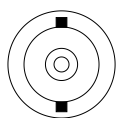

CH1 Y-OUT

BNC output socket with a signal derived from the Channel 1 input signal.

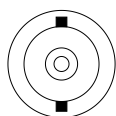

MAIN TB GATE

BNC output socket with a signal that is "high" when the Main Timebase is running and "low" for the other conditions.

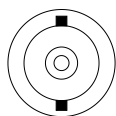

DTB GATE

BNC output socket with a signal that is "high" when the Delayed Timebase is running and "low" for the other conditions.

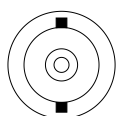

EXT TRIG (only in 4 channel models)

BNC input socket used as an extra external trigger input for the Main Timebase

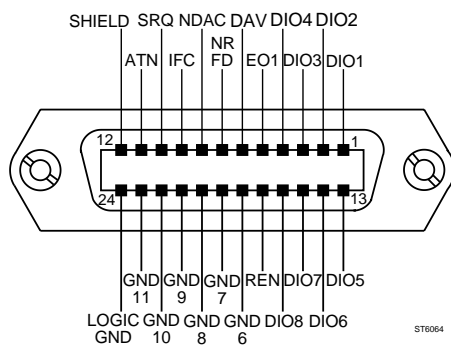

IEEE 488.2 BUS OPTION

If installed you will find here the input/output socket to connect the oscilloscope to an IEEE 488 interface.



The external conductor of the BNC sockets and the screening of the interface bus connectors are internally connected to the protective earth conductor of the three-core mains cable. The external conductor of the BNC sockets and the screening of the interface bus connectors must not be used as a protective conductor terminal.

1 OPERATORS SAFETY

*ATTENTION: The instrument is designed for indoor use only.
Read this page carefully before installation and use of the
instrument.*

1.1 INTRODUCTION

The instrument described in this manual is designed to be used by properly-trained personnel only. Adjustment, maintenance and repair of the exposed equipment shall be carried out only by qualified personnel.

1.2 SAFETY PRECAUTIONS

For the correct and safe use of this instrument it is essential that both operating and service personnel follow generally-accepted safety procedures in addition to the safety precautions specified in this manual. Specific warning and caution statements, where they apply, will be found throughout the manual. Where necessary, the warning and caution statements and/or symbols are marked on the apparatus.

1.3 CAUTION AND WARNING STATEMENTS

CAUTION: Is used to indicate correct operating or maintenance procedures in order to prevent damage to or destruction of the equipment or other property.

WARNING: Calls attention to a potential danger that requires correct procedures or practices in order to prevent personal injury.

1.4 SYMBOLS



Read the safety information in the manual.



Earth.



Conformité Européenne.



Recycling information.

1.5 IMPAIRED SAFETY PROTECTION

The use of the instrument in a manner not specified may impair the protection provided by the equipment. Before use, inspect the instrument and accessories for mechanical damage!

Whenever it is likely that safety-protection has been impaired, the instrument must be made inoperative and be secured against any unintended operation. The matter should then be referred to qualified technicians. Safety protection is likely to be impaired when, for example, the instrument fails to perform the intended measurements or shows visible damage.

1.6 MEASURING EARTH

The measuring earth socket and the external conductor of the BNC sockets are internally connected to the protective earth conductor of the three-core mains cable. The measuring earth socket or the external conductor of the BNC-sockets must not be used to connect a protective conductor.

2 INSTALLATION INSTRUCTIONS

Attention: You are strongly advised to read this chapter thoroughly before installing your oscilloscope.

2.1 SAFETY INSTRUCTIONS

2.1.1 Protective earthing

Before any connection to the input connectors is made, the instrument shall be connected to a protective earth conductor via the three-core mains cable; the mains plug shall be inserted only into a socket outlet provided with a protective earth contact. The protective action shall not be negated by the use of an extension cord without protective conductor.

WARNING: Any interruption of the protective conductor inside or outside the instrument is likely to make the instrument dangerous. Intentional interruption is prohibited.

WARNING: When an instrument is brought from a cold into a warm environment, condensation may cause a hazardous condition. Therefore, make sure that the grounding requirements are strictly adhered to.

2.1.2 Mains voltage cord, mains voltage range and fuses

Before inserting the mains plug into the mains socket, make sure that the instrument is suitable for the local mains voltage.

NOTE: When the mains plug has to be adapted to the local situation, such adaption should be done by a qualified technician only.

WARNING: The instrument shall be disconnected from all voltage sources when a fuse is to be renewed.

The oscilloscope has a tapless switched-mode power supply that covers most nominal voltage ranges in use: ac voltages from 100 ... 240 V (r.m.s.). This obviates the need to adapt to the local mains (line) voltage. The nominal mains (line) frequency range is 50 Hz ... 400 Hz.



Line fuse rating: 3.15 AT delayed action, 250 V (for ordering code see "INITIAL INSPECTION").

The mains (line) fuseholder is located on the rear panel in the mains (line) input socket. When the mains (line) fuse needs replacing, proceed as follows:

- disconnect the oscilloscope from the mains (line).
- remove the cover of the fuseholder by means of a small screwdriver.
- fit a new fuse of the correct rating and refit the cover of the fuseholder.

WARNING: Make sure that only fuses with the required rated current and of the specified type are used for replacement. The use of makeshift fuses and the short-circuiting of fuse holders are prohibited.



REAR VIEW

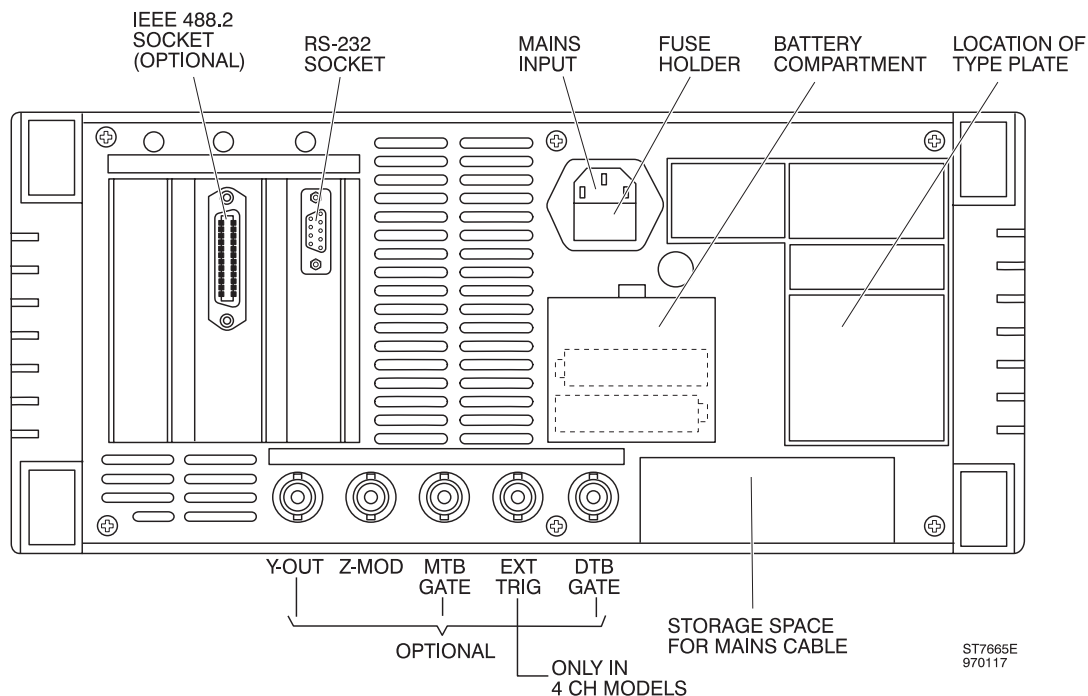

Figure 2.1 Rear view of the instrument showing the mains input/fuse-holder and back-up battery compartment.

When the apparatus is connected to its supply, terminals may be live, and the opening of covers or removal of parts (except those to which access can be gained by hand) is likely to expose live parts.

The apparatus shall be disconnected from all voltage sources before it is opened for any replacement, maintenance or repair.

Capacitors inside the apparatus may still be charged even when the apparatus has been disconnected from all voltage sources.

Any maintenance and repair of the opened apparatus under voltage shall be avoided as far as possible and, when inevitable, shall be carried out only by a skilled person who is aware of the hazard involved.

2.2 MEMORY BACK-UP BATTERIES

2.2.1 General information

Memory backup is provided to store the oscilloscope's settings when switched off so that the instrument returns to the same settings when turned on. Two AA (LR6) Alkaline batteries are used.

Note: The batteries are not factory installed and must be installed at the customer's site.

Note: This instrument contains batteries. Do not dispose of these batteries with other solid waste. Used batteries should be disposed of by a qualified recycler or hazardous materials handler. Contact your authorized Fluke Service Center for recycling information.



2.2.2 Installation of batteries

Proceed as follows:

- Remove all input signals and disconnect the instrument line power.
- Remove the plastic cover of the battery compartment so that the battery holder becomes accessible.
- Install two penlight batteries (AA) in the battery holder as indicated on the battery holder.
- Reinstall the cover of the battery compartment.

Note: Front settings and autocalibration data disappear after exchange of the batteries with the instrument disconnected from the line power. After battery exchange, it is necessary to press the CAL key after the recommended warming up time.

CAUTION: Never leave the batteries in the oscilloscope at ambient temperatures outside the rated range of the battery specifications because of possible damage that may be caused to the instrument. To avoid battery damage, do not leave the batteries in the oscilloscope when it is stored longer than 30 days.

2.3 THE FRONT COVER

For ease of removal and reinstallation, the front cover has been designed to snap on to the front of the instrument.

The front can be removed as follows:

- Fold the carrying handle down so that the oscilloscope occupies a sloping position (refer to Chapter 2.4 for how to proceed).
- Pull the clamping lip at the top side of the cover slightly outwards.
- Lift the cover off the instrument.

2.4 HANDLE ADJUSTMENT AND OPERATING POSITIONS OF THE INSTRUMENT

By pulling both handle ends outwards away from the instrument, the handle can be rotated to allow the following instrument positions:

- vertical position on its rear feet;
- horizontal position on its bottom feet;
- in three sloping positions on its handle.

The characteristics mentioned in the REFERENCE MANUAL are guaranteed for the specified positions or when the handle is folded down.

CAUTION: To avoid overheating, ensure that the ventilation holes in the covers are free of obstruction. Do not position the instrument in direct sunlight or on any surface that produces or radiates heat.

In the rear panel of the instrument there is storage space for the mains cable. There is also a clamping device to fix the end of the mains cable to the rear panel. The mains plug then fits in the area where the RS232 connector is present. In this way the instrument can also stand on its rear feet.

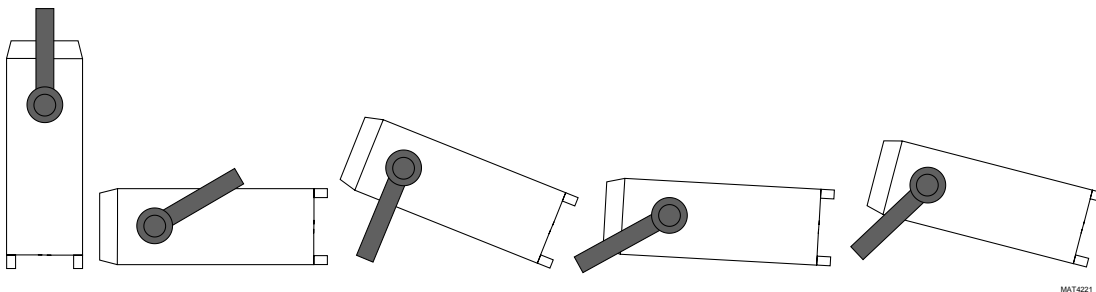

Figure 2.2 Instrument positions

2.5 IEEE 488.2/IEC 625 BUS INTERFACE OPTION

If your oscilloscope is equipped with the IEEE 488.2 interface, it can be used in a bus system configuration. The protocol used is SCPI (Standard Commands for Programmable Instruments). For setup information, refer to the function REMOTE CONTROL IEEE 488.2 in Chapter 5.

The IEEE 488.2 interface is a factory-installed option.

2.6 RS-232-C SERIAL INTERFACE

Your oscilloscope is equipped with an RS-232-C interface as standard. The interface can be used in a system for serial communication. The protocol used is CPL (Compact Programming Language). CPL is a small set of very powerful commands that can be used for full remote control. Detailed information about this interface and the CPL protocol is given in Chapter 6 in this manual. For setup information, refer to the REMOTE CONTROL RS-232 function in Chapter 5 'Function Reference'.

2.7 RACK MOUNTING

The rackmount kit (PM 8960/04) allows you to install the oscilloscope in a standard 19 inch rack.

It is not necessary to open the oscilloscope itself to mount the rackmount kit. Installation can be done easily by the user.

2.8 VERSIONS

The model number of your oscilloscope (e.g. PM33...) is indicated on the text strip above the CRT. This model number is also represented by the digits 6, 7, 8 and 9 of the 12- digit code on the type plate on the rear panel. The 'A' or 'B' series is indicated by a 1 or 2 on the 5th digit.

The instrument's serial number is also given on the type plate. This number consists of a six digit code preceded by the characters 'DM'.

The instrument version can also be displayed on the CRT after having pressed menu key UTILITY and then softkey MAINTENANCE.

3 GETTING STARTED

This chapter provides a 10-minute tutorial intended for those who are not familiar with Fluke oscilloscopes. Those who are already familiar can skip this chapter and continue to Chapter 4.

3.1 FRONT-PANEL LAYOUT

This oscilloscope is a combination of an analog oscilloscope and a digital storage oscilloscope in the same instrument. The basic signal acquisition and display functions are identical in both operating modes. Differences will be explained in the text. Switching between the two operating modes is done with the yellow ANALOG key.

The front panel of the oscilloscope is organized into functional areas. The areas are discussed in order of typical operation.

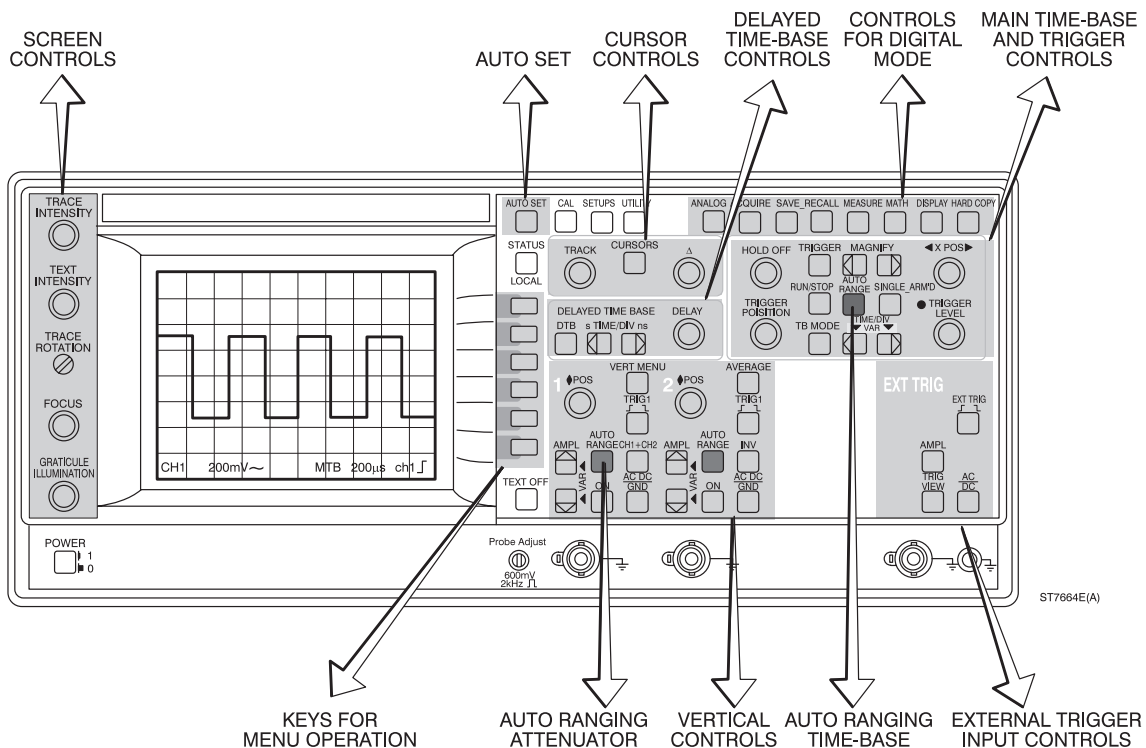

Figure 3.1 Front panel layout

Note that the front panel shown is that with the most functions. Differences are explained in Section 4.1. For this getting started procedure, only CH1 and CH2 are used. These are identical for all models.

Typical operation of your instrument will be:

- Switching on the instrument (see Section 3.2)
- Initial standard setup (see Section 3.2)
- Screen controls (see Section 3.3)
- Auto setup (see Section 3.4)
- Analog-Digital mode switching (see Section 3.5)
- Vertical setup (see Section 3.6)
- Timebase setup (see Section 3.7)
- Magnify (Expand) (see Section 3.8)
- Direct trigger setup (see Section 3.9)
- Pretrigger view (see Section 3.10)
- More advanced features (see Section 3.11)
- Cursor operation (see Section 3.12)
- More advanced trigger functions (see Section 3.13)
- More signal detail with the DTB (see Section 3.14)
- Trace storage (see Section 3.15)

3.2 SWITCHING ON THE INSTRUMENT

Connect the power cord and set the front panel power switch to ON. For any line source between 100V to 240V nominal, 50/400 Hz, the instrument automatically turns on. After performing the built-in power-up routine, the instrument is immediately ready for use. The instrument's settings will be identical to those when the oscilloscope was switched off (with the batteries installed).

To ensure that you will get the same setup in all cases, press the **STATUS** key and **TEXT OFF** key simultaneously. This will set the instrument in a predefined default condition (STANDARD SETUP) and a trace will appear on the screen. Text is also displayed at the bottom of the screen.

3.3 SCREEN CONTROLS

The screen controls can be adjusted for optimum trace, text and spot quality by the controls to the left of the screen.

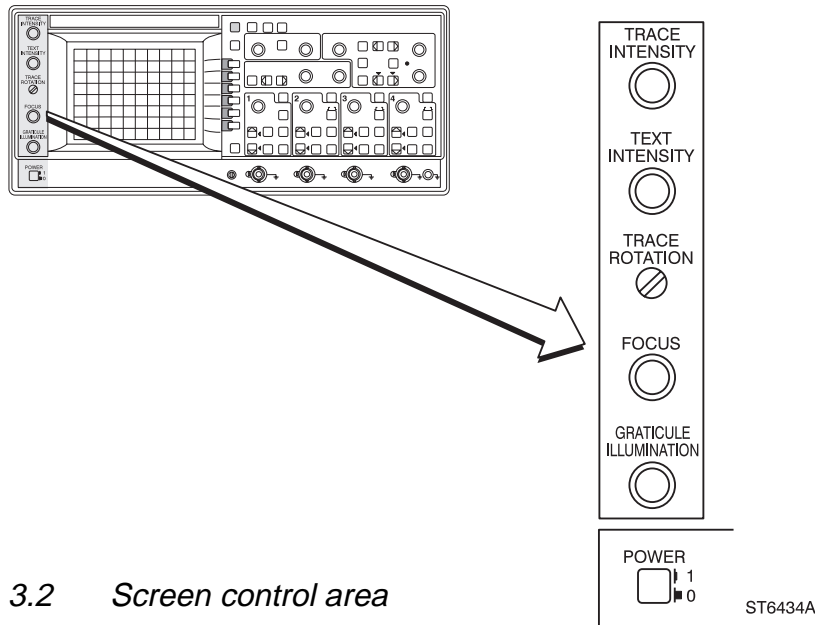

Figure 3.2 Screen control area

The brightness on the screen is adjusted by two controls, one for the trace and one for the text.

- Turn the **TRACE INTENSITY** control clockwise and verify that only the brightness of the trace increases.
- Turn the **TEXT INTENSITY** control clockwise and verify that only the brightness of the text increases.

The sharpness of the trace and text is optimized by the **FOCUS** control.

When you are making photographs or are in a dark environment, you can use the **ILLUMINATION** control to illuminate the graticule of the screen.

The trace is adjusted in parallel with the horizontal graticule lines by the screwdriver-controlled **TRACE ROTATION** control.

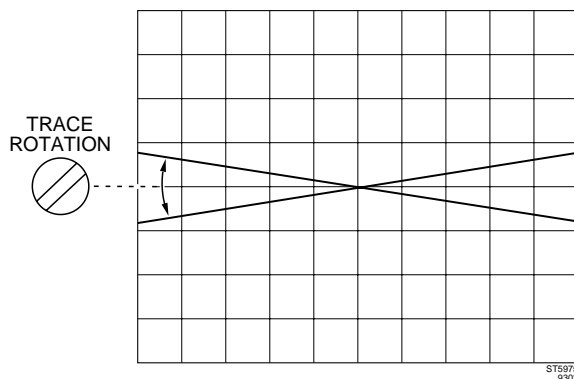

ST5975
9303

3.4 AUTO SETUP

The best way to start each measurement is by using the AUTOSET key. This **automatically** finds and scales all relevant parameters on all channels.

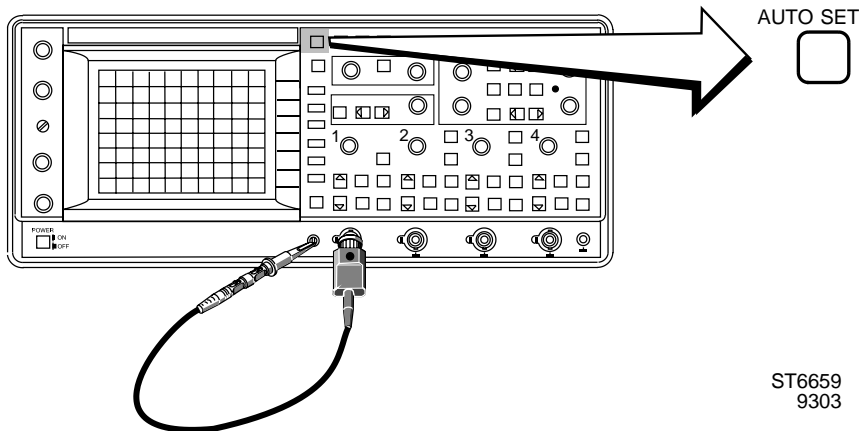

ST6659
9303

Figure 3.3 Measuring setup

Step 1 Connect the probe as shown in figure 3.3.

NOTE: *AUTOSET is programmable. Because you have set the instrument in the "standard setup" before (see Section 3.2), all programmable features are set to a predefined condition and the instrument is set in the analog mode. Programming of AUTOSET is explained in Chapters 4 and 5.*

Step 2 Press the **AUTOSET** key.
The scope flashes the message 'AUTO SETTING...' on the screen. In a few seconds the front-panel settings are adjusted for an optimized display of the applied signal in the analog mode.

Step 3 The calibration signal is clearly displayed.
The parameters of the channel and the timebase settings are displayed at the bottom of the screen.

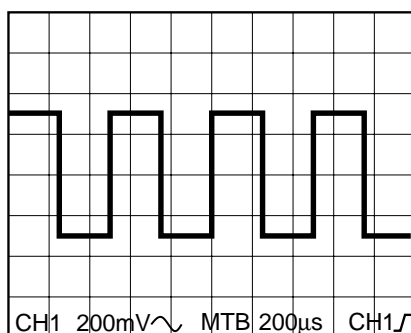

ST6704

- Step 4 To prevent measurement errors, check the pulse response before any measurement. If the pulse shows overshoot or undershoot, you can correct this by using the trimmer in the probe's body. Chapter 4 describes how to adjust the pulse response.

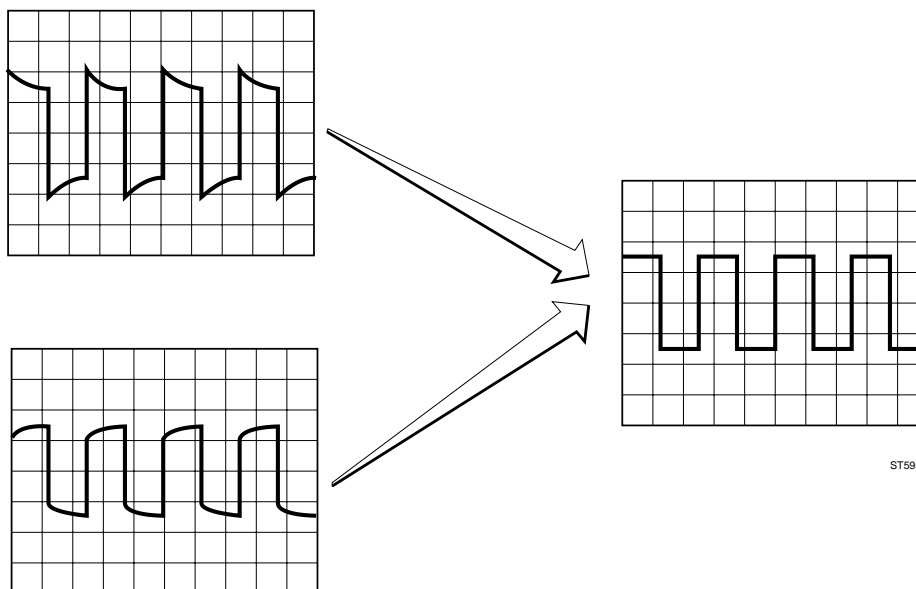

In most cases, using AUTO SETUP is sufficient for a good initial display of the signal(s). After the initial AUTOSET, and to optimize the signal for a more detailed view, continue with the paragraphs below.

NOTE: *If you get lost when adjusting your instrument, just press **AUTOSET**.*

3.5 MODE SWITCHING BETWEEN ANALOG AND DIGITAL OPERATING MODES

You can use the yellow ANALOG key to switch from the analog mode to the digital mode and back at any time. The signal acquisition and display functions of both operating modes are very similar. However, the nature of the signals you are using may determine which operating mode you prefer to use. For more information, refer to the following table:

SIGNAL CRITERIA	ANALOG MODE	DIGITAL MODE
Repetitive signals of 30 Hz and higher	Usable	Usable
Repetitive signals below 30 Hz	Causes display flickering	Preferred
Single events	Displayed for the duration of the event	Can capture and display for long term display
Repetitive signals that are amplitude modulated	Preferred	May cause aliasing Use Peak detect or Envelope mode
Repetitive signals that are modulated in frequency	Preferred	May cause aliasing. Use Envelope mode.
Long serial data streams	Preferred when Delayed sweep is not used.	When using delayed sweep to observe details, Digital mode provides better light output.
Video signals	Preferred when Delayed sweep is not used.	When using delayed sweep to observe details, Digital mode provides better light output.
OTHER CRITERIA		
Need to see pretrigger information	Not possible	Up to full acquisition length

SIGNAL CRITERIA	ANALOG MODE	DIGITAL MODE
You need to make adjustments to the circuitry and watch the signal change	Fastest display update	Slower display update
Automatic measurements	Can't use	Fully implemented
Signal Math Add, Subtract, Multiply	Add, Subtract	All functions
Signal Analysis Integration, Differentiation, FFT	Not available	Full analysis (optional)
Automatic Pass/Fail test	Not available	Fully implemented (optional)
Autorange attenuator	Not available	Results in a displayed signal with an amplitude of 2 to 6.4 divisions
Autorange timebase	Not available	Results in a signal display of 2 to 6 waveform periods

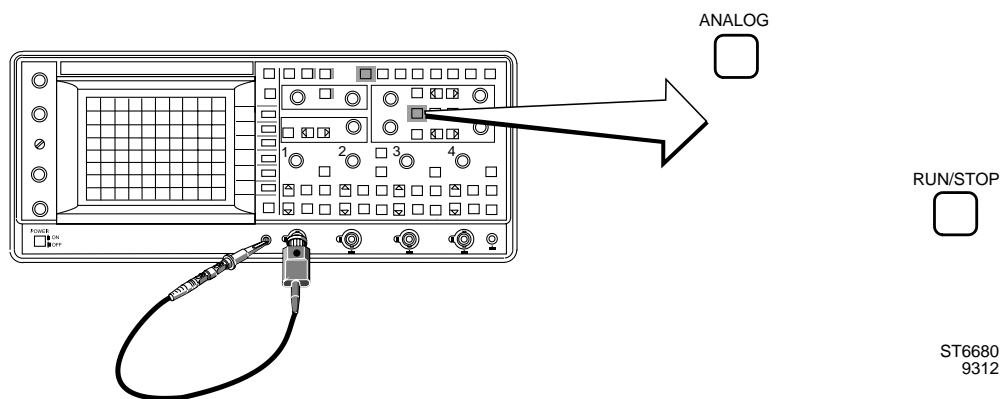

Figure 3.4 Analog-Digital switching setup

- Step 1 Press **AUTOSET**. The scope performs an AUTOSET in analog mode.
- Step 2 Press the **ANALOG** key to change over to the digital mode. Check that the picture is identical to the one in the analog mode. The text 'DIGITAL MODE' is displayed briefly at the bottom of the screen.

- Step 3 Press **AUTOSET** again. This time the scope performs the autoset in digital mode.
- Step 4 Press the **RUN/STOP** key and observe that the trace is frozen and stays on screen even after removing the probe.
- Step 5 Press the **RUN/STOP** key to display the actual input signal again. Reconnect the probe to display the Probe Adjust signal again.
- Step 6 Press the **ANALOG** button once again to return to the analog mode. In the bottom of the screen, the text 'ANALOG MODE' is briefly displayed.

3.6 VERTICAL SETUP

This section deals with setting of the input circuits of the four channels. The main adjustments are **AMPL**itude, **POS**ition, and the channel input coupling selection for **GND**, **DC**, and **AC**.

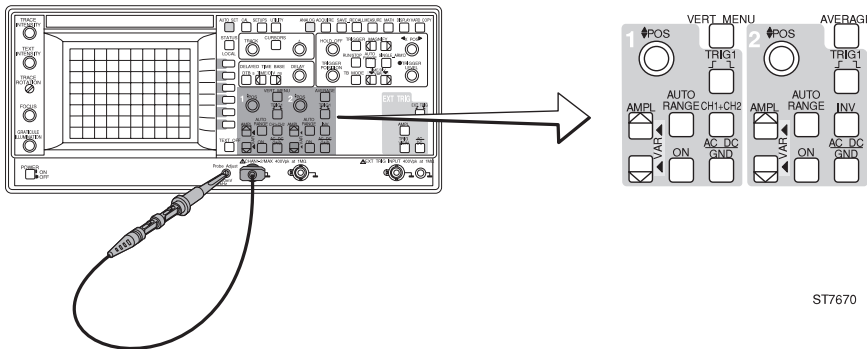

ST7670

Figure 3.5 Vertical setup

- Step 1 Adjust the absolute ground level by disconnecting the signal and using the **POS** control to position the trace in the middle of the screen. A marker with the channel number ('1-') at the left of the screen indicates the ground reference.

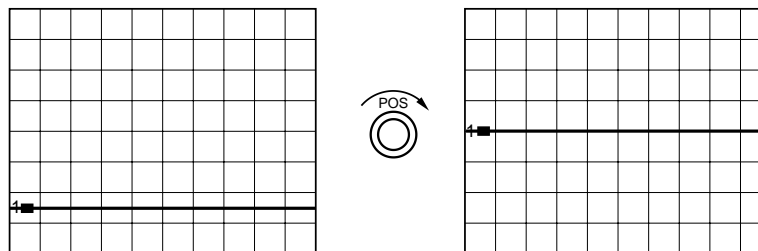

MAT4191

- Step 2 Reconnect the probe to the Probe Adjust signal for display.

- Step 3 You can change the amplitude of the signal in a 1, 2, 5 sequence by pressing one of the **AMPL** keys. Note that the bottom of the screen shows the AMPL/DIV setting of CH1.

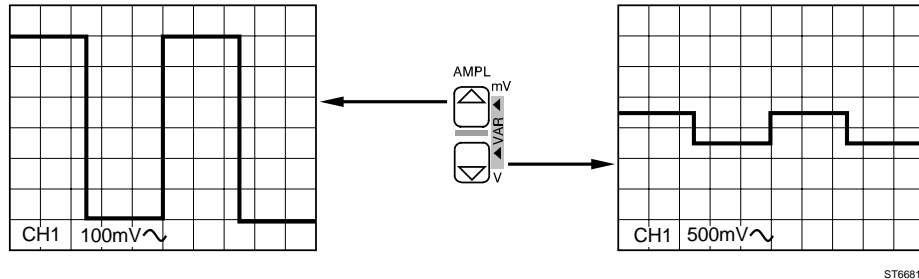

- Step 4 Press the **ON** button of CH2 and observe that a second trace is now visible. The position and amplitude of this channel can be adjusted similar to the adjustment of CH1. The channel settings are also displayed in the bottom of the screen.

Press the **ON** key of CH2 once again to turn this channel off.

- Step 5 Press the **AC DC/GND** key of CH1 so that a '⊥' sign is displayed in the bottom text line. This interrupts the input signal and connects the input to the ground. In this case, only the 'base' line is visible.

Press the **AC DC/GND** key once again for ac input coupling; the bottom text line now displays '~'.

In most cases, dc input coupling is used to show ac as well as dc components of the signal. However, in some cases where a small ac signal is superimposed on a large dc voltage, ac input coupling must be used. Then only the ac component is visible on the screen. The text line shows a '=' or '~' sign to indicate dc or ac coupling. Because the calibration signal is a square wave with a low level of 0V and a high level of +600 mV, the screen shows either of the following two displays:

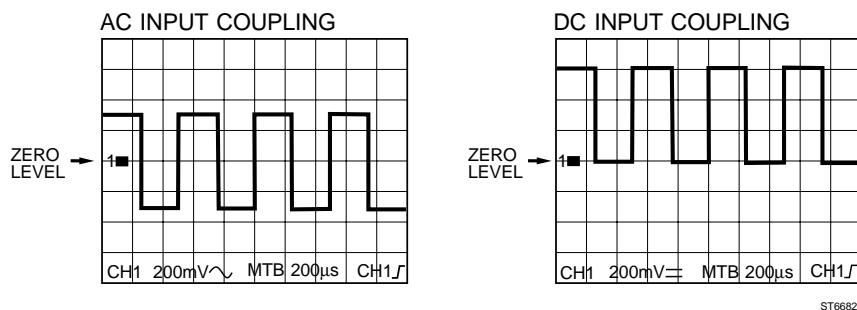

Step 6 Press the **ANALOG** key to enter the digital mode

Step 7 Press the top one (mV) of the **AMPL** keys, so that the signal has maximum amplitude.

Press **AUTO RANGE** and see the signal change to a suitable attenuator value. When AUTO RANGE is active, the attenuators automatically adjust when the signal amplitude changes, to keep the trace on screen.

Step 8 Press the key labeled **AVERAGE**. Noise in the input signal can be reduced by using the average function. The random noise is reduced by calculating the average over the last n scans (average factor can be set between 2 and 4096)

NOTE: Refer to Chapter 4 for an explanation of the CH1+CH2, TRIG1, and INV keys.

3.7 TIMEBASE SETUP

The next step is the adjustment of the main timebase controls (**TIME/DIV**, **X POSITION**, and **MAGNIFY** keys).

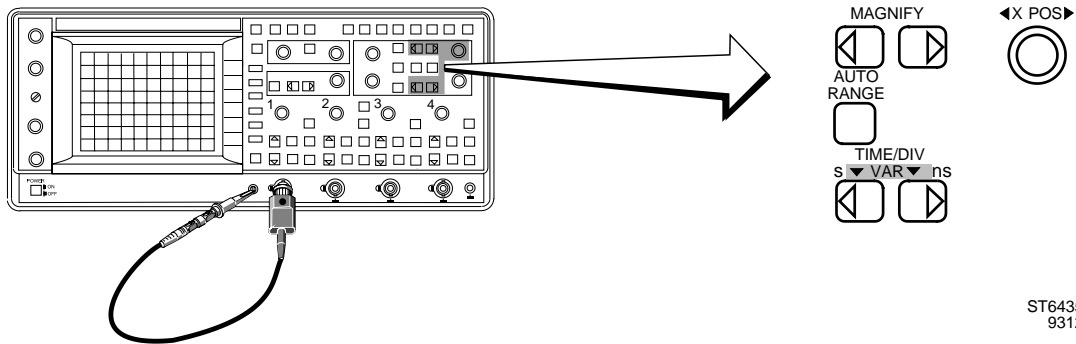

ST6435
9312

Figure 3.6 Timebase setup

- Step 1 Press the **AUTOSET** key.
- Step 2 Use the **TIME/DIV** keys on the right hand side of the instrument to decrease or increase the number of periods of the signal on the screen.

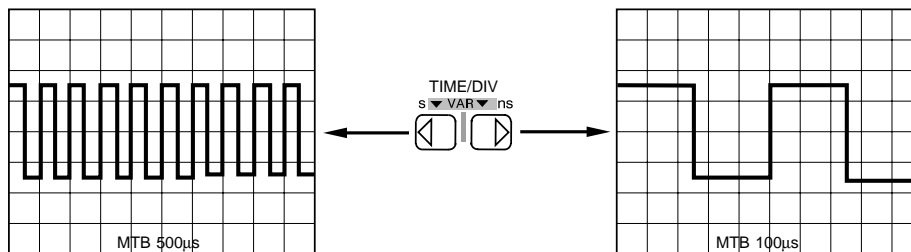

ST6683

- Step 3 Select a timebase of 1 ms/div.
- Step 4 Press **AUTO RANGE** and see the signal display change to a more suitable timebase. The AUTO RANGE function automatically selects a timebase that displays 2 to 6 signal periods.
- Step 5 Press the **ANALOG** key to switch the scope to the analog mode.
- Step 6 Turn the **X POS** control to shift the signal horizontally (left or right) across the screen.

3.8 MAGNIFY (EXPAND)

- Step 1 You can use the **MAGNIFY** keys to expand the signal on the screen. The 'MGN' indication and the corrected timebase setting are displayed in the text line.
In the analog mode, magnification is limited to *10. The right key will activate the magnification. The left key will turn off the MAGNIFY function. On or off is indicated by 'MGN' in the bottom of the screen.
- Step 2 Press the **ANALOG** key to switch the scope to the digital mode.
- Step 3 In the digital mode, pressing the right **MAGNIFY** key expands the signal in *1, *2, *4 ...steps to a maximum of *32 times. Pressing the left **MAGNIFY** key compresses the signal to *1 again. When you operate the **MAGNIFY** buttons, or when you turn the **X POS** control, a bargraph is displayed showing which part of the digital trace is expanded.

NOTE: The **MAGNIFY** key and **X POS** control can also be used after the oscilloscope is **STOPped**.

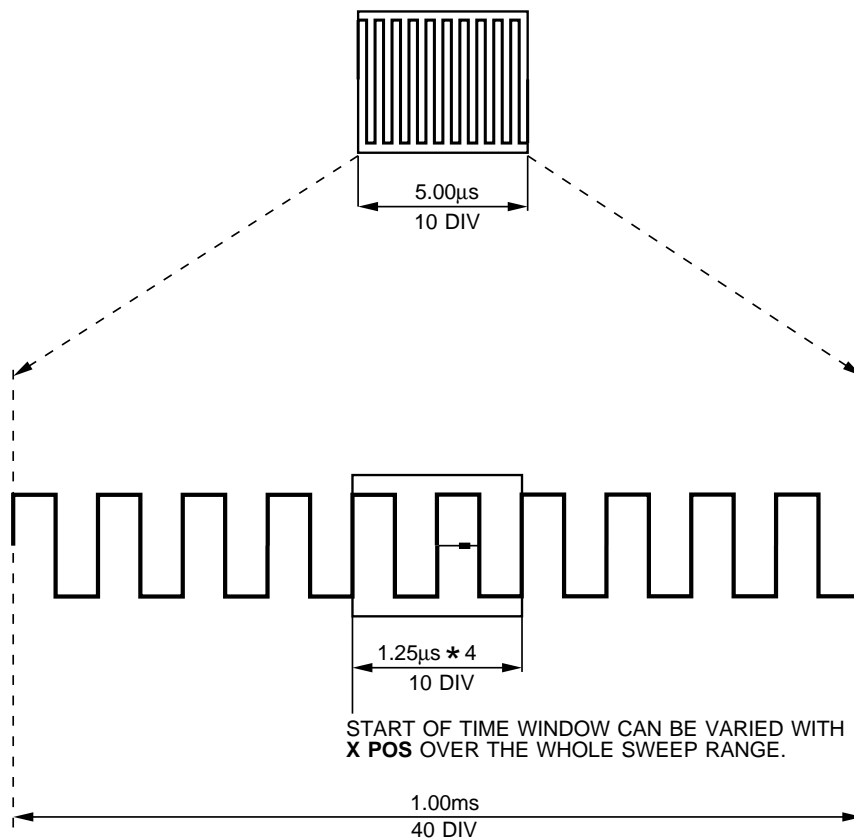

ST6684

3.9 DIRECT TRIGGER SETUP

Now you are ready to set your trigger conditions. You will use one of the channel selection keys (**TRIG1**, **TRIG2**, **TRIG3**, **TRIG4** or **EXT TRIG**) and the **TRIGGER LEVEL** control.

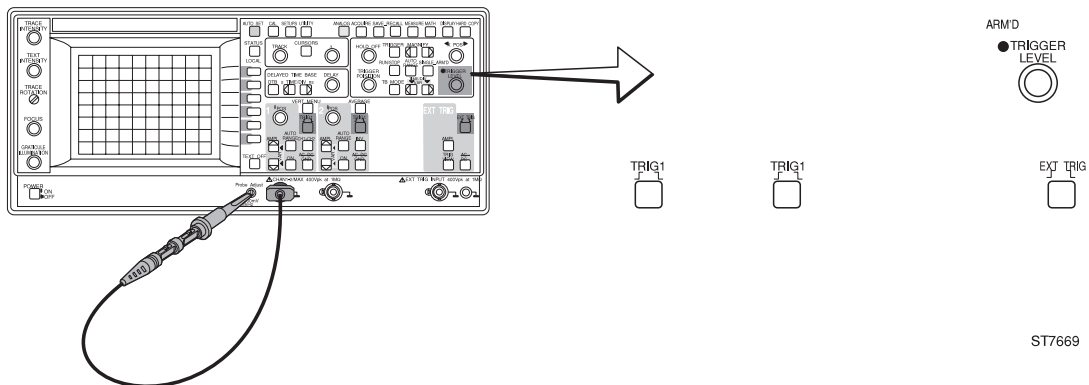
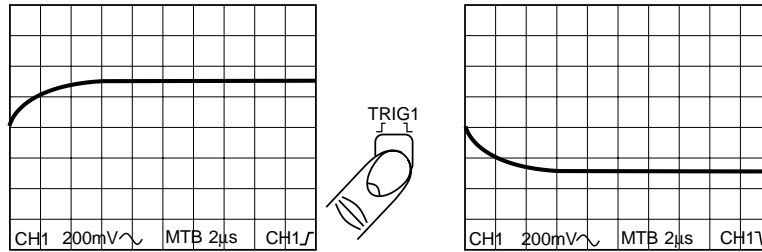

Figure 3.7 Direct trigger setup

- Step 1 Press the **AUTOSET** key. The square-wave signal of the Probe Adjust output is now displayed on channel 1. Turn channel 2 on to display a second horizontal trace (channel 2 has no input signal).
- Step 2 Press the **TRIG2** key so that channel 2 is selected as the trigger source. The result is that the signal on channel 1 is no longer triggered (not stable). The **ARM'D** LED is on, to indicate that the oscilloscope is not triggered. Check also that the right side of the bottom text line indicates the trigger source ('ch2').
- Step 3 Only in 2 channel models
Press **EXT TRIG** key to select External Trigger input as the trigger source. Check that the rightside of the bottom textline indicates the trigger source 'EXT'.
- Step 4 Press the **TRIG1** key. Channel 1 is now selected as the trigger source. The 'ch1' symbol is displayed in the bottom text line. Triggering resumes. Turn channel 2 off, by pressing **ON** again.
- Step 5 Press the **ns** key of the MainTB **TIME/DIV** keys until the timebase is set to '2 μ s/div'.

- Step 6 The same **TRIG1** key that was used to select the trigger source is also used to select the trigger slope. Repeatedly pressing the **TRIG1** button changes the triggering so that it occurs on the leading or trailing edge of the input signal. Note that the slope is also displayed in the bottom text line.



ST6685

- Step 7 For repetitive signals, you obtain a stable display when each successive timebase sweep is triggered at the same stable level of the input signal. You use the **TRIGGER LEVEL** control to adjust the level. Turn the control. The precise position in relation to the maximum signal amplitude (between +100 % and -100 %) is displayed on the screen.

SUMMARY

The previous steps covered the **basic adjustments**. Now you are ready to look at the special features of the oscilloscope. This includes the use of the cursors, advanced trigger functions and using the second (delayed) timebase for signal details.

3.10 PRE-TRIGGER VIEW

One of the powerful features in the digital mode is the ability to capture and view signal contents prior to the actual trigger. The amount of pretrigger information can be as long as one full acquisition/record. The trigger position is adjusted with the **TRIGGER POSITION** control.

- Step 1 Turn the **TRIGGER POSITION** control counter clockwise. Now the triggering edge shifts to the center of the screen. A trigger point marker (s) indicates the trigger point. The part to the left of the marker is called pretrigger view. The pretrigger view is indicated in the bottom of the screen (in divisions)

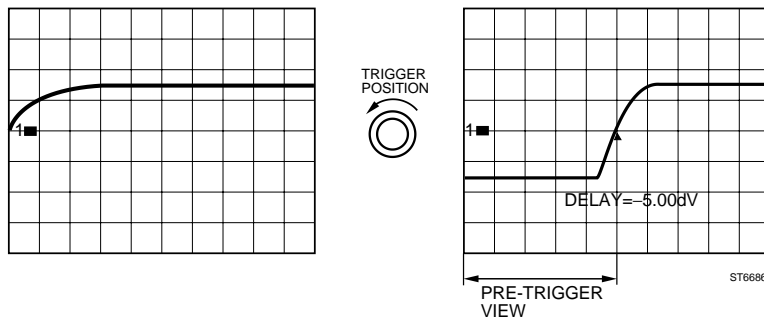

- Step 2 The **TRIGGER POSITION** control can also be used to adjust time delay. Rotate the **TRIGGER POSITION** control clockwise until the readout displays "0". When you continue to turn the **TRIGGER POSITION** control clockwise, a positive delay between trigger point and acquisition is set. The delay is no longer read out in divisions of pretrigger information, but in seconds, or fractions of seconds to indicate how much delay is used.

3.11 MORE ADVANCED FEATURES

All basic functions are accessed by dedicated keys for fast and easy operation. Some of the more advanced features are menu operated. Menus are called up by pressing one of the keys identified with **blue** text on the front panel. After you press one of these keys, a menu is displayed on the right side of the screen. This menu gives you access to the more advanced functions of the oscilloscope. Use the blue softkeys to the right of the screen to select the desired functions; the selected function is indicated by the highlighted text.

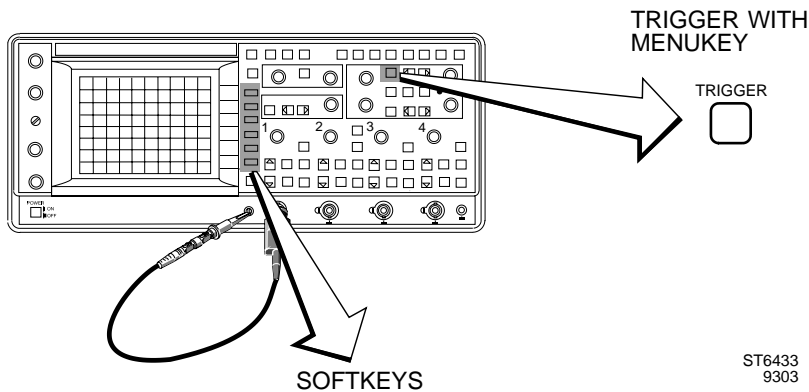

Figure 3.8 Menu keys and softkeys

Step 1 Press the key marked **TRIGGER**. Check that the 'TRIGGER MAINTB' menu is displayed at the right side of the screen.

After changing the setting, you can deactivate the menu again to use the full screen for the signal.

There are two ways to do this:

- Press the **TRIGGER** key once again.
- Press the **TEXT OFF** key.

The **TEXT OFF** key operates in a 1-2-3 cycle, and allows you to blank the bottom text line as well.

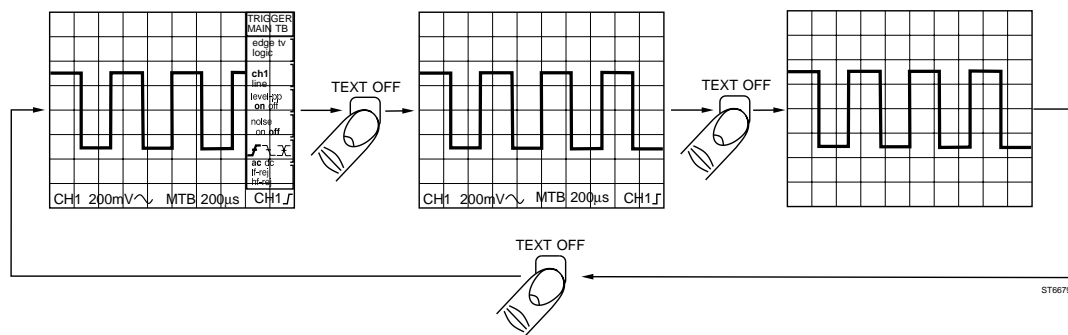

Step 2 Use both methods to familiarize yourself with turning the menus and the bottom text line on and off.

3.12 CURSOR OPERATION

Cursors are used for accurate amplitude or time measurements of the signal.

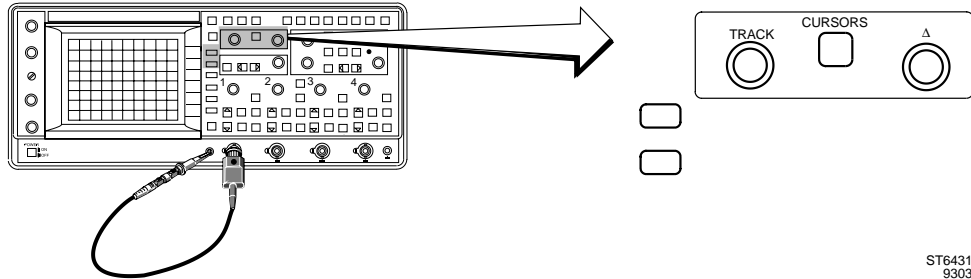

Figure 3.9 Cursor setup

Step 1 Before you continue, reset the instrument with the **STANDARD SETUP**. To do this, press the **STATUS** key and **TEXT OFF** key simultaneously. Now the instrument is set in the default condition and operates in analog mode.

Step 2 Press the **AUTOSET** key.

Step 3 Press the **CURSORS** key to enter the cursors menu. The menu is now displayed on the screen and the cursors are turned on.

Step 4 Use the second blue softkey from the top to select one of the three cursor modes:

- Amplitude cursor measurements, indicated by '='.
- Time cursor measurements, indicated by '||' for measuring time or frequency.
- Amplitude **and** time measurements, indicated by '#'. The top text line displays the result of the measurements (ΔV or ΔT).

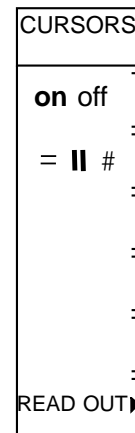

ST6430

Step 5 Press the second bluesoft key until '||' is highlighted.

Step 6 The **TRACK** control moves both cursors at the same time. For example, to measure the period time of the input signal, set the left (reference) cursor to a rising edge of the signal.

Step 7 The Δ control moves the right cursor only. Set this cursor the next rising edge of the signal.

- Step 8 The top text line now shows the pulse repetition time of the signal (e.g., ch1: $\Delta T = 500 \mu\text{s}$).

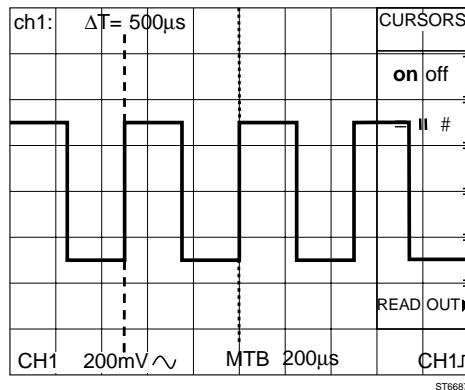

- Step 9 Press the second blue softkey until '=' is highlighted. Now perform a peak-to-peak measurement and check that the amplitude of the signal (' ΔV ') is 600 mV.

NOTE: When you select '#', the fifth blue softkey is automatically activated so that you can choose between using the controls for positioning the vertical cursors ('|') or the horizontal cursors ('=').

The 'READOUT' submenu is explained in Chapter 4.

- Step 10 Select the vertical cursors again.
- Step 11 Now switch to the digital mode. Notice the changing readout and the 'X' indicating where the trace and the cursors intersect. Since the trace is digitized, the cursors can be really smart. In the digital mode you can measure time differences (ΔT) and amplitude differences (ΔV) at the same time.

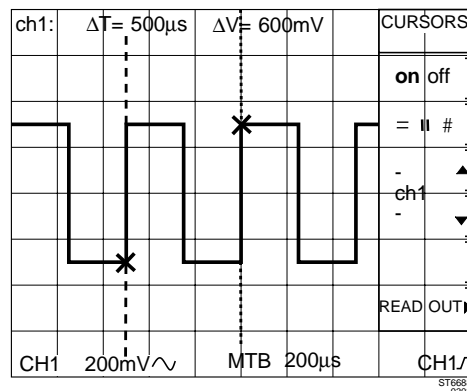

- Step 12 Use the first blue softkey to turn the cursors off. The cursor menu disappears.

3.13 MORE ADVANCED TRIGGER FUNCTIONS

Most of the trigger functions (source, slope, and level) can be controlled with direct access to the functions (see Section 3.9). A CRT menu is used for more advanced trigger functions.

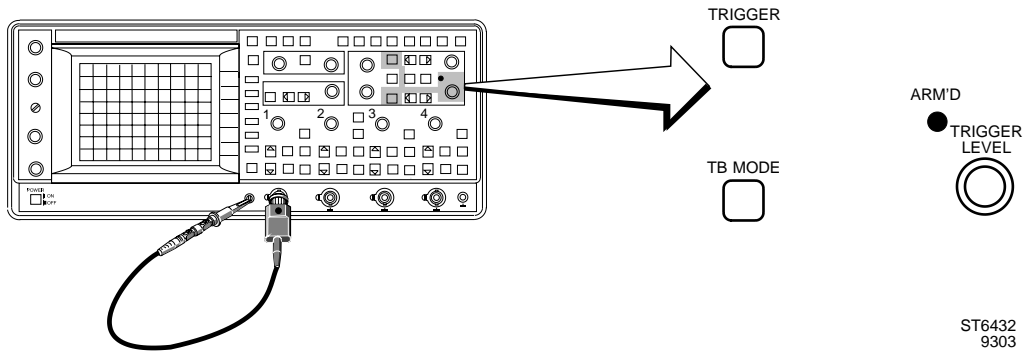
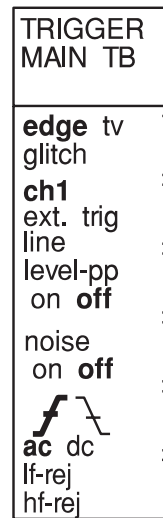

Figure 3.10 More advanced trigger setup

Press the menu key **TRIGGER**. This turns the menu on. An extensive set of functions is now displayed.



ST7688

All functions are explained in Chapter 4. For most applications, this menu is not needed.

3.14 MORE SIGNAL DETAIL WITH THE DELAYED TIMEBASE

When you need to study a part of a signal in more detail, a second (delayed) timebase is available. This timebase has its own timebase settings and trigger level adjustment. Additional selections are made in the DELAYED TIMEBASE menu.

ST6439
9303

Figure 3.11 Delayed timebase setup

- Step 1 Press the **STATUS** key and **TEXT OFF** key at the same time for STANDARD SETUP.
Then shift to trace to the upper half of the screen as indicated.

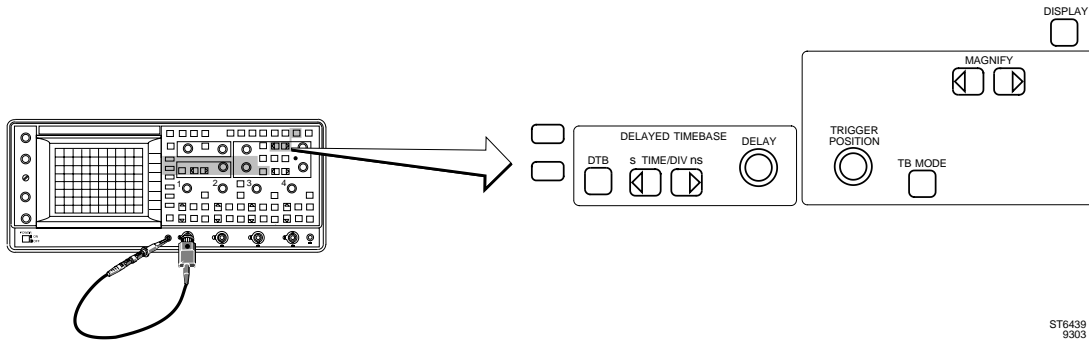
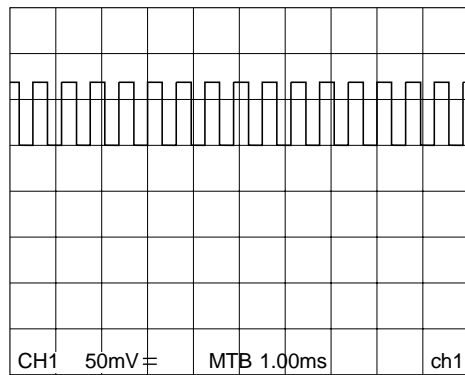

ST6690

- Step 2 Press the **DTB** key. The DELAYED TIME BASE menu is now displayed on screen. Turn the delayed time base on with the first softkey.

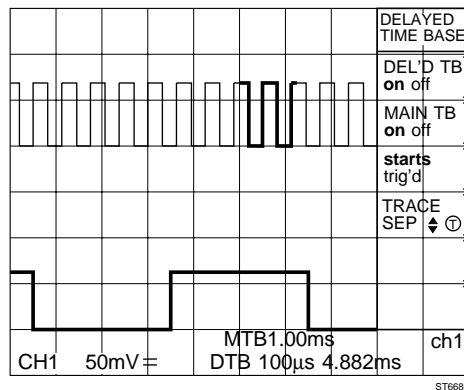

The upper trace is the main timebase trace. This first trace shows an intensified part. Adjust the **TRACE INTENSITY** with the control as necessary. The lower trace is the delayed timebase trace and is an expanded representation of the intensified part in the upper trace.

- Step 3 Turn the **DELAY** knob to shift the intensified part and to select which part of the main timebase you want to magnify.
- Step 4 The delayed timebase **TIME/DIV** keys are used to select the 'magnification factor'. Notice the changing delayed timebase 'TIME/DIV' readout at the bottom of the screen.
- Step 5 The 'T' symbol at the fourth blue softkey indicates that the cursor **TRACK** control can be used to make adjustments. In this menu the cursor **TRACK** control is used to change the TRACE SEPARation, which is the distance between the main timebase and the delayed timebase.

The delayed timebase can be used in the triggered mode. The triggered mode is selected with the **STARTS/TRIG'D** softkey. The function of the triggered mode will be explained in Chapter 4. For this part of "Getting Started", remain in the STARTS mode.

- Step 6 Switch the menu off with the **TEXT OFF** key. Notice that the delayed timebase is still active and that the most important functions (**DELAY** control and **TIME/DIV** key pair) still allow you to operate the delayed timebase.

3.15 TRACE STORAGE

In the digital mode you not only have the ability to store traces on the screen (using the **RUN/STOP** key), but also to store traces in memory for later use.

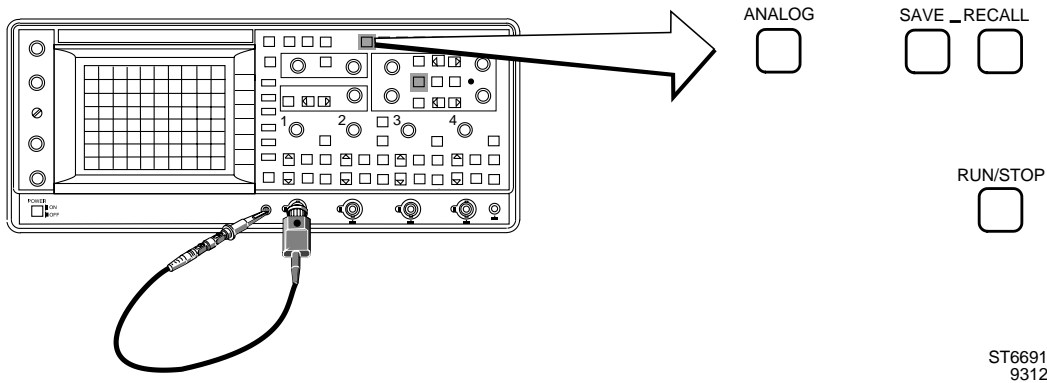

Figure 3.12 Digital memory setup

Store traces on screen:

- Step 1 Press **AUTOSET**.
- Step 2 Make sure that the scope is in the digital mode. If not, press the **ANALOG** key to enter the digital mode.
- Step 3 With the **RUN/STOP** key, new acquisitions are stopped and the display is frozen. Removing the input signal or pressing a key has no effect on the display. Stopping the acquisition is very useful to do measurements on the signal or to make a hard copy.
- Step 4 Press the **RUN/STOP** key to reactivate the acquisition.

Store traces in memory:

- Step 5 For this step-by-step introduction you will first clear all memory locations so that all unnecessary traces are removed.
 - press the **SAVE** menu key.
 - select **CLEAR & PROTECT**.
 - select **CLEAR ALL**.
 - in the confirm menu, select **YES**.
 Sometimes there will be a second confirm menu. Select **YES** again to clear protected traces as well.
 Press the **TEXT OFF** key to turn the menu off.

Here is how traces are stored in memory:

Step 6 Use the **TRACK** control to select an empty memory location such as m1, m2, or m3. Empty locations are marked with a circle in front of the memory location number (e.g., ○ m3).

Step 7 Press the second blue softkey ('save'). You have now saved the acquisition signal into memory 'register' m3. A single register can contain a set of up to three traces (e.g., CH1, CH2, and EXT (trigger view)). In this case only one input channel was turned on, so that only one was stored.

Step 8 Remove the probe from CH1. Now recall the stored trace.

Step 9 Press the **RECALL** key.

Step 10 Select the previously filled memory register m3 with the **TRACK** control. A memory register with trace information is indicated with ◉

Step 11 Press the second blue softkey to turn on the display of this register. Indicated by ●

Step 12 Turn the Δ control to separate the acquisition (live signal) and the trace recalled from memory.

NOTE: *You are now able to operate nearly all the oscilloscope's functions in most routine applications. Please continue with Chapter 4 for a more detailed description of the oscilloscope's many advanced features.*

Memory indications:

- Empty register
- ◉ Filled register
- Displayed register

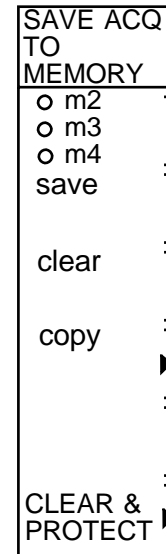

ST6705

4 HOW TO USE MORE ADVANCED FUNCTIONS OF THE INSTRUMENT

This chapter allows more experienced oscilloscope users to learn more about the advanced features of this instrument and how to use them. For a complete description of each function, refer to the next chapter in this manual: "Function Reference".

This chapter explains the basics of each function and gives examples are given in a step by step sequence.

Less experienced oscilloscope users should read Chapter 3 before beginning this chapter.

4.1 INTRODUCTION

All of the oscilloscope models in the PM337xB, PM338xB and PM339xB family combine the features and operation of an analog oscilloscope with that of a full-featured Digital Storage Oscilloscope (DSO). Switching between one mode of operation to the other is done by pressing one (yellow) push button.

Most signal acquisition functions are identical for both modes of operation, even though the digital mode allows for pretrigger acquisition and display, plus more powerful logic triggering.

Delayed sweep operation is available in both operating modes.

Cursors operate in both modes.

The digital mode provides access to many powerful calculated measurement and signal analysis functions.

It also has a completely new feature called AUTO RANGE.

AUTO RANGE automatically adjusts the attenuator or the timebase setting when the amplitude or the frequency of the signal has changed.

This family of oscilloscopes is available with a 60 MHz, 100 MHz or 200 MHz bandwidth. There are full four-channel instruments as well as 2+2 channel models.

The economy version have 2 full channels and an external trigger channel.

PM3394B 200 MHz Full Four Channel Oscilloscope.

The PM3394B offers a 200 MHz bandwidth. Four channels provide equal bandwidth, and sensitivity ranges. Each channel has full AC/DC/GND coupling capabilities.

In VERTMENU each channel is set to 50 Ω or 1 M Ω input impedance.

PM3390B 200 MHz 2 Channel Oscilloscope

The PM3390B has the same capabilities as the PM3394B on the channels 1 and 2. The channels 3 and 4 are replaced by an external trigger channel. This channel can only be used as an additional trigger input channel. Signal manipulation as in the full channels 1 and 2 is not possible. The external trigger signal can be displayed by using the function TRIG VIEW.

PM3384B 100 MHz Full Four-Channel Oscilloscope

Bandwidth is 100 MHz.

The PM3384B has the same capabilities as the PM3394B. VERT MENU only offers BW LIMIT selection.

PM3380B 100 MHz 2 Channel Oscilloscope

The PM3380B has the same capabilities as the PM3384B on the channels 1 and 2. The channels 3 and 4 are replaced by an external trigger channel as in the PM3390B. VERT Menu offers only BWLIMIT selection.

PM3370B 60 MHz 2 Channel Oscilloscope

The PM3370B has a bandwidth of 60 MHz. All other features are equal to those of the PM3380B.

FRONT PANEL LAYOUT

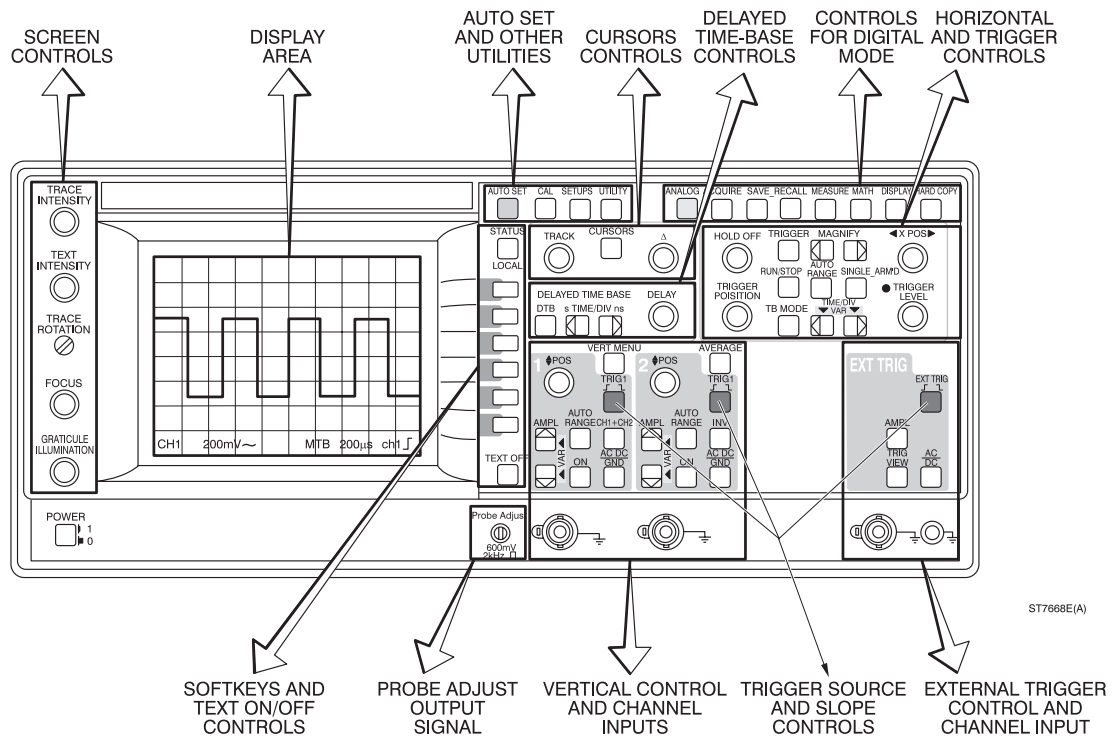

The controls on the front panel are grouped by function. In this chapter, a description for each group of controls is given in the following sequence:

- Display and probe adjustment (see section 4.2)
- Analog and digital modes (see section 4.3)
- Vertical deflection (see section 4.4)
- Horizontal deflection and triggering (see section 4.5)
- Digital acquisition and storage (see section 4.6)
- Advanced vertical functions (see section 4.7)
- Advanced horizontal and trigger functions (see section 4.8)
- Memory functions (see section 4.9)
- Cursor functions (see section 4.10)
- Measurement functions (see section 4.11)
- Processing functions (see section 4.12)
- Display functions (see section 4.13)
- Delayed timebase (see section 4.14)
- Hard copy facilities (see section 4.15)
- AUTOSET and other utilities (see section 4.16)

Study the front panel of your oscilloscope and observe what functions the different controls and push buttons (keys) perform. There are three different styles of push buttons, plus the blue softkeys adjacent to the screen. The push button functions are as follows:



Direct function key. These keys provide direct access to specific functions as labeled on the front panel. Examples include AUTOSET for automatic setup of the oscilloscope and AC DC (GND) for selection of the instrument's input coupling.



Menu initialization key, with blue text. Press to produce a menu on the screen from which you can select functions that are related to the function name of this key.



Key pair. These pairs serve as up/down controls. They are used to select a value from a range.



Softkey. Press to select a function from the menu that has been initialized by pressing one of the menu initialization keys.



Rotary control. Used for continuously variable control of a function.

4.2 DISPLAY AND PROBE ADJUSTMENTS

To help you follow the step-by-step descriptions, each section begins by recalling the standard setting as outlined below.

If you get "lost", you can return to the beginning of each section, because all functions are set to a predefined state to create a correct start situation.

RECALL STANDARD SETTING

- **Simultaneously press the STATUS and TEXT OFF keys.**

Recalling the standard setting always results in a trace on the display, even with no signal applied to the oscilloscope inputs. Refer for a list of the standard setting to the section "STANDARD SETUP/FRONT PANEL RESET" of Chapter 5.

DISPLAY ADJUSTMENT

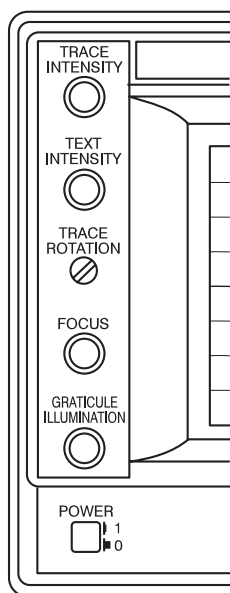

ST6156A

Before going through the examples that introduce you to features of this oscilloscope, adjust the display as follows:

- **Turn the TRACE INTENSITY control for optimum trace brightness.**
- **Turn the TEXT INTENSITY control for optimum display brightness of the text.**
- **Adjust trace alignment with the graticule by using the screwdriver control TRACE ROTATION.**
- **Turn the FOCUS control until a sharp trace is obtained.**
- **You can turn the GRATICULE ILLUMINATION control to illuminate the graticule lines as desired.**

DISPLAY LAYOUT

The following illustration shows the layout of the display with a maximum amount of text.

Most text is active only when specific functions are activated.

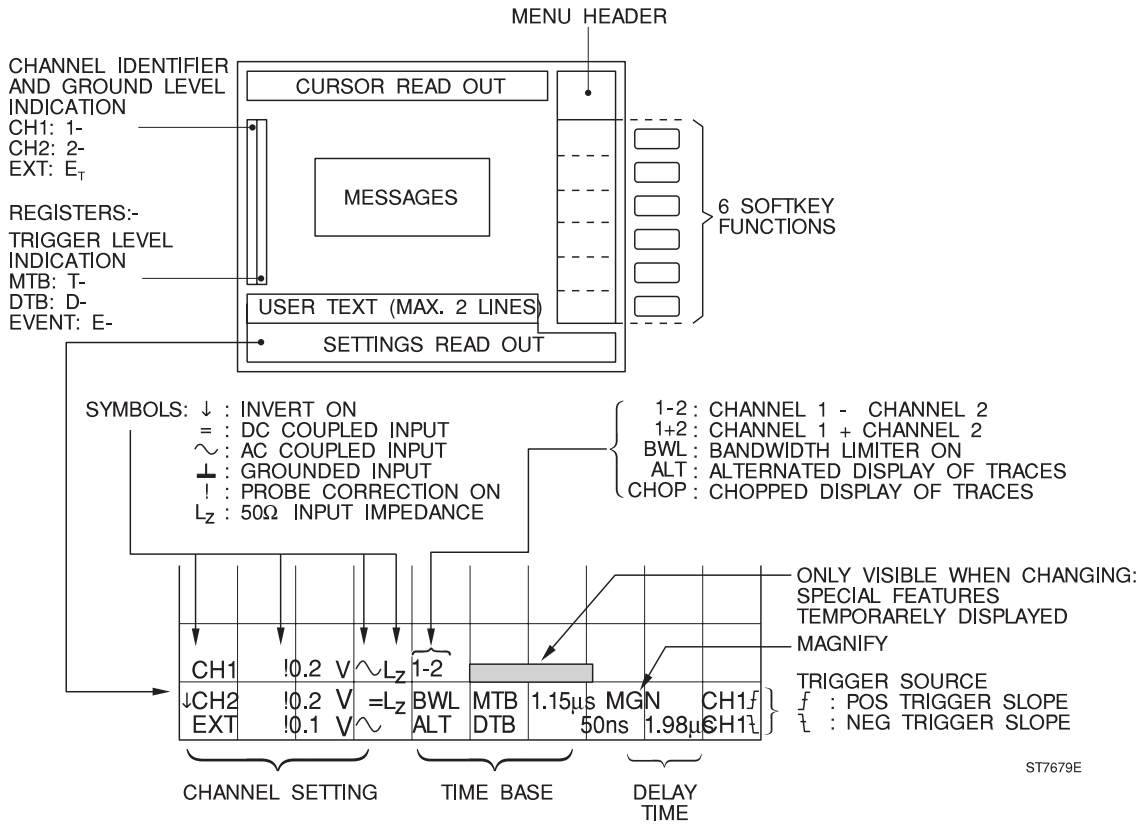

ST7679E

MENUS**TEXT OFF**

A menu appears when a key with blue text is pressed.

The menu functions can be selected by pressing the blue softkeys to the right side of the screen.

- **Press the ANALOG key to select the digital mode.**
- **Press the DISPLAY key to activate the menu.**

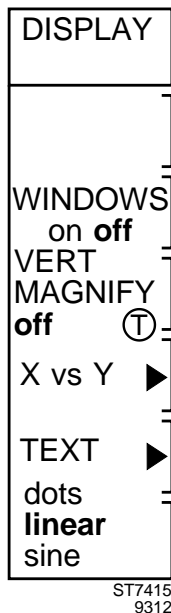

Each menu starts with a menu name, which corresponds with the key that was used to select the menu. This is sometimes followed by a second name of the softkey that initialized a submenu.

The windows function can be switched on and off by pressing the corresponding blue softkey.

Ⓣ indicates that a selection must be made with the TRACK control.

The arrow (▶) behind TEXT indicates that there is a submenu.

The bottom softkey switches (toggles) between the three functions.

You can turn off the text by pressing the TEXT OFF key. This can be done to free up the display area.

- **Press the TEXT OFF key three times.**

Observe that the text mode follows the following sequence: menu off, settings off, both on.

CAL SIGNAL AND PROBE ADJUSTMENT

Each measuring probe has been checked and adjusted before delivery. However, to match the probe to your oscilloscope, you must perform the following procedure to optimize the pulse response of the combination of oscilloscope input and probes.

- **Connect the probe body to channel 1.**
- **Connect the probe tip to the Probe Adjust output of the oscilloscope.**
- **Press the AUTOSET key.**

If the display looks like one of the two displays shown on the left, you must adjust your probe to get the display shown on the right.

The probe output impedance can be adjusted through a hole in the compensation box of the probe to obtain optimum pulse response. Refer to the following figure.

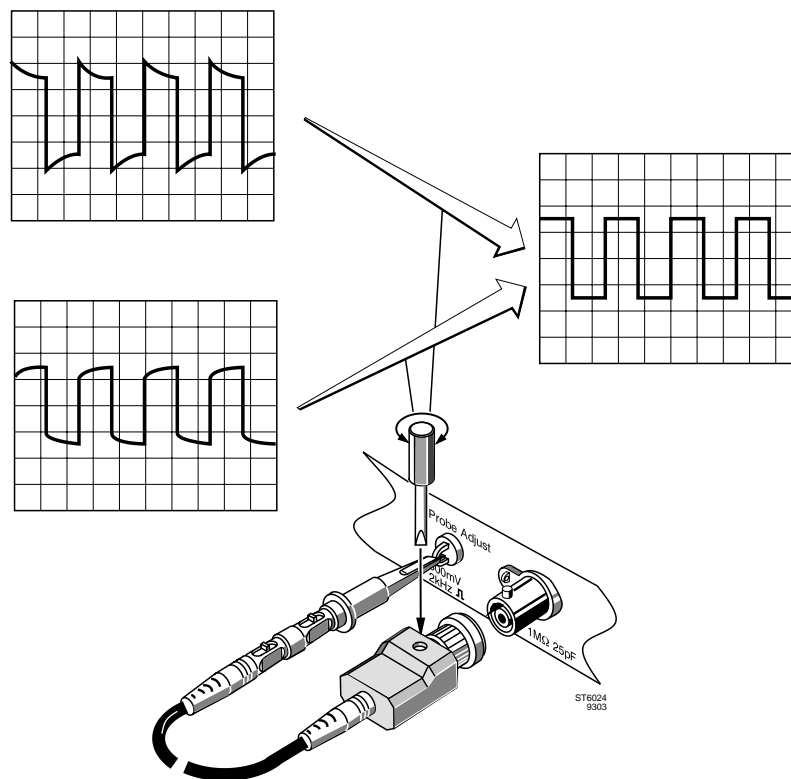

- **Adjust the probe until the screen shows the correct compensation.**

The probe is now adjusted for optimum pulse response with this oscilloscope. If you connect the probe to another channel or oscilloscope, it must be adjusted again to that oscilloscope input.

- **Repeat this adjustment for the second probe.**

4.3 ANALOG AND DIGITAL MODES

ANALOG



This instrument is a combination of an analog real-time oscilloscope and a digital storage oscilloscope, which offers a variety of additional features. The combination of analog and digital modes in one instrument gives you the advantages of both modes.

In the **ANALOG MODE** the signal is directly written on the screen. The result is the "traditional" real-time signal representation. Because of the high update rate and infinite resolution, this image gives signal details that are visible only on true analog oscilloscopes.

In the **DIGITAL MODE** the input signal is sampled. These samples are stored in memory so that mathematics, calculated measurements, printing, and other memory functions can be performed on the trace.

You can use the yellow ANALOG push button to switch from the analog mode to the digital mode and back at any time. The signal acquisition and display functions of both operating modes are very similar. However, the nature of the signals you are using may determine which operating mode you prefer to use. For more information, refer to the following table:

SIGNAL CRITERIA	ANALOG MODE	DIGITAL MODE
Repetitive signals of 30 Hz and higher	Usable	Usable
Repetitive signals below 30 Hz	Causes display flickering	Preferred
Single events	Display for duration of the event	Can capture and display for long term
Repetitive signals that are amplitude modulated	Preferred	May cause aliasing. Use Peak detect or Envelope mode
Repetitive signals that are modulated in frequency	Preferred	May cause aliasing. Use Envelope mode.
Long serial data streams	Preferred when Delayed sweep is not used.	When using delayed sweep to observe details, Digital mode provides better light output.

SIGNAL CRITERIA	ANALOG MODE	DIGITAL MODE
Video signals	Preferred when Delayed sweep is not used.	When using delayed sweep to observe details, Digital mode provides better light output.
OTHER CRITERIA		
Need to see pretrigger information	Not possible	Up to one screen
You need to make adjustments to the circuitry and watch the signal change	Fastest display update	Slower display update
Automatic measurements	Can't use	Fully implemented
Signal Math Add, Subtract, Multiply	Add, Subtract only	All functions
Signal Analysis Integration, Differentiation, FFT	Not available	Full analysis, with Math Plus option installed
Automatic Pass/Fail test	Not available	Fully implemented, with Math Plus option installed
Autorange attenuator	Not available	Results in a displayed signal with an amplitude of 2 to 6.4 divisions
Autorange timebase	Not Available	Results in a signal display of 2 to 6 waveform periods

STANDARD SETTING

- **Simultaneously press the STATUS and TEXT OFF keys.**
- **Connect the Probe Adjust signal to channel 1.**

The Probe Adjust signal, now supplied to the input, is a square wave with a lower level of 0V and a top level of 600 mV. The oscilloscope always operates in analog mode after a recall of the standard setting.

- **Press the AUTOSET key for optimum signal display.**

ANALOG TO DIGITAL MODE SWITCHING

Switching from analog to digital mode and vice-versa can be done by pressing the yellow **ANALOG** key. If no Digital mode-only features were activated, you can switch between the modes with no changes in the display.

- **Press the ANALOG key again.**

The oscilloscope is automatically set in the digital mode. This is indicated by a message 'DIGITAL MODE' that appears briefly on the screen.

TRACE STORAGE**RUN/STOP**

The digital mode offers a set of powerful features. One of the most important advantages is that you can store one or more traces in memory or on screen.

- **Press the RUN/STOP key to stop the signal acquisition and freeze the display on the screen.**

The trace is frozen and stays on the screen. Observe that the signal stays stored even when you remove the probe.

Now the instrument has been STOPped, and most keys have been disabled. The only keys that continue to function are those directly related to display functions. This includes trace shift using the **POS** control. All measurement functions are still operable.

A frozen trace can be used for comparisons with other traces, mathematics, cursor measurements, automatic measurements and more.

The **RUN/STOP** key is used to end the STOP mode and start the acquisition again.

- **Press the RUN/STOP key.**

This starts the acquisition again so that the actual input signal is displayed. You can use the RUN/STOP key at any time.

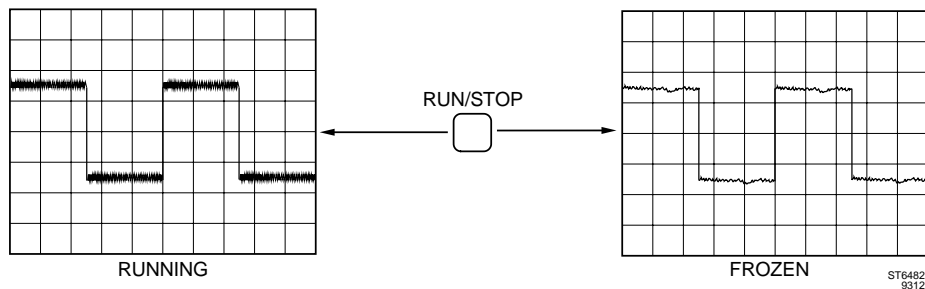

NOTE: *The following section explains the basic functions regardless of operating mode. The oscilloscope will react almost identically in either mode. Where necessary, different behavior will be explained.*

4.4 VERTICAL DEFLECTION

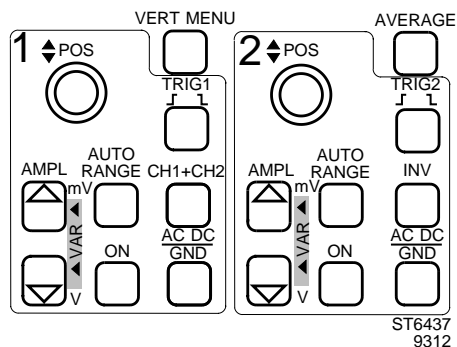

The section shown on the left contains all direct vertical deflection controls for the input channels 1 and 2.

Refer to Section 4.1 for the differences between model numbers.

To start this section with the settings in a predefined state, you must recall the standard setting.

STANDARD SETTING

- **Simultaneously press the STATUS and TEXT OFF keys.**
- **Connect the Probe Adjust signal to channel 1.**

The Probe Adjust signal, now supplied to the input, is a square wave with a lower level of 0V and a top level of 600 mV.

- **Press the AUTOSSET key.**

VERTICAL COUPLING

AC, DC, GND

The input coupling after AUTASET is ac. Since the Probe Adjust signal is a pulse type signal with a 50% duty cycle, its mean value is at the signal's 50% amplitude level. When the input is ac coupled, the mean value will be displayed at the ground level of the oscilloscope. As a result of this, the displayed waveform is centered on the screen.

AC coupling can be used to examine small ac components that are superimposed on large dc voltages.

- **Press the AC DC GND key once for DC input coupling.**

Since the Probe Adjust signal is a pulse-type signal with a lower level of 0V, and a higher level of 600 mV, and since the oscilloscope adjusts the display position of the ground level to coincide with the screen center, switching from ac coupling to dc coupling results in an upward shift of the display position of the signal.

The coupling sign in the lower left hand corner of the screen changes from ~ (ac) to = (dc).

The ground level for each of the channels is indicated by a dash after the channel identifier, i.e., '1-' for the ground level of channel 1.

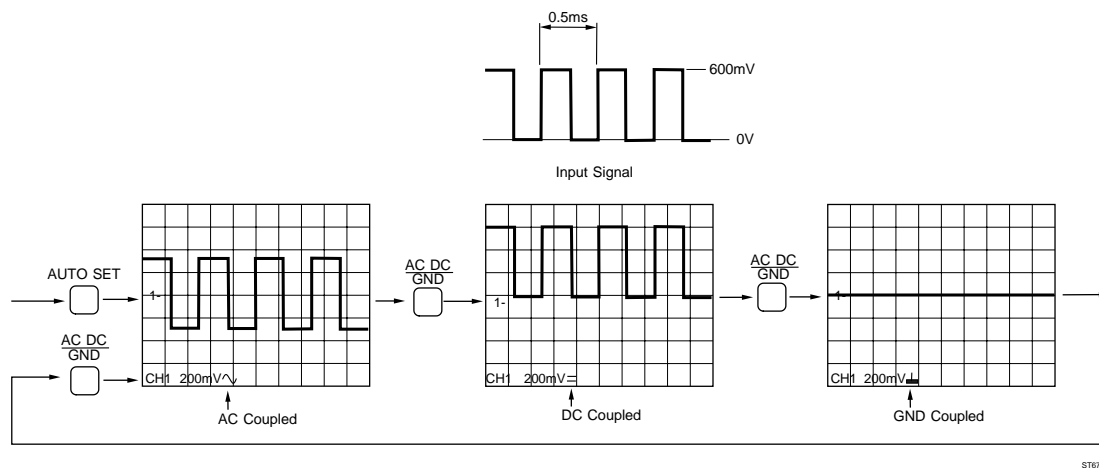

- **Press the AC DC GND key to obtain ground coupling.**

A straight line is now displayed. This is the 0V (ground) level of the input. This level serves as the 0 volt reference for amplitude measurements.

The coupling sign '⊥' now indicates ground coupling.

VERTICAL**POSITION**

◆ POS



Use the POS control to adjust the ground level to any desired vertical position on the screen.

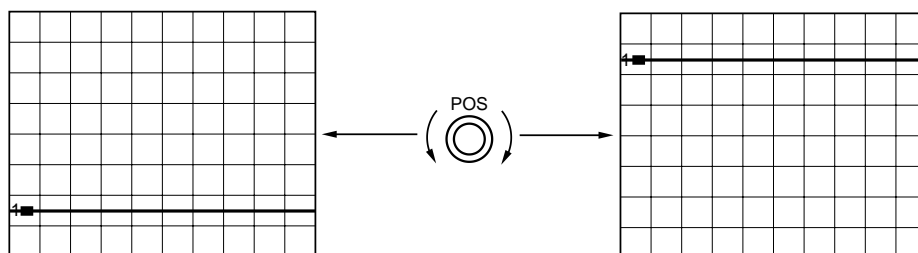

MAT4171

- **Use the position control to position the line in the middle of the screen.**

Observe that the channel identifier '1-' shifts with the trace.

- **Press the AC DC GND key again to obtain ac input coupling.**

Since the Probe Adjust signal is a pulse type signal with a 50% duty cycle, its mean value is at the 50% amplitude level of the input signal. When the input is ac coupled, the mean value will be displayed at the ground level of the oscilloscope. As a result of this, the displayed waveform is centered on the screen.

VERTICAL**AMPLITUDE**

- Press the upper key of the AMPL keys



Pressing the upper key increases the amplitude of the displayed waveform. As the amplitude of the displayed waveform changes, the screen readout of the input sensitivity changes as well.

If you adjust the displayed amplitude to 6 divisions, you will notice that the readout in the lower left hand corner of the screen reads 100 mV/div. The amplitude of the signal is then: 100 mV/div times 6 div = 600 mV.

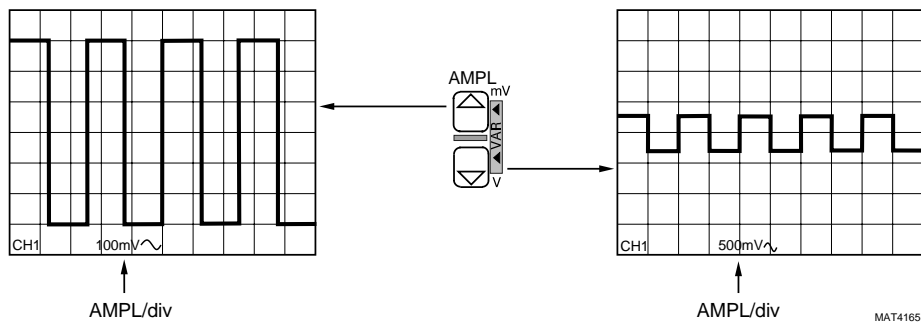

Try other sensitivity settings as follows :

- Use the AMPL keys to step through the attenuator range.

Observe that the sensitivity readout changes in steps following a 1, 2, 5 sequence. The AMPL keys allow you to step up and down through the sensitivities from 5 V/div to 2 mV/div and vice-versa. This sequence enables a quick selection between the oscilloscope's sensitivity positions and are such that almost every input signal can be made visible with sufficient amplitude.

- Adjust AMPL to 100 mV.

A waveform with an amplitude of six divisions is displayed.

VERTICAL**AUTO RANGE**

The AUTO RANGE function results in an amplitude display of 2 to 6 divisions.

- **Press the AUTO RANGE key.**

Observe that the amplitude of the signal changes from 6 divisions to 3 divisions. In the upper right corner of the display ATT 1 is displayed. This indicates that the AUTO RANGE function is active on input channel 1.

- **Press the upper AMPL key once.**

The AUTO RANGE function is switched off and the ATT 1 indication disappears. The attenuator is now back in manual control.

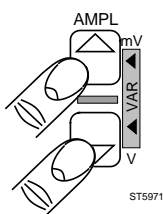
VERTICAL**VARIABLE AMPLITUDE**

Press both AMPL buttons simultaneously to select the VARiable mode. This mode is used to make fine adjustments of the input amplitude settings between the 1-2-5 steps.

When the VARiable mode is turned off, the oscilloscope selects the nearest '1-2-5' value.

- **Enter the VAR mode by simultaneously pressing both AMPL keys.**
- **Adjust amplitude with either AMPL key.**

Observe that the sensitivity steps that can be selected are much finer than before and that the displayed amplitude is continuously adjustable.

Note: The VAR values are calibrated amplitude settings as well. This enables you to make accurate measurements and readouts even when intermediate settings are used.

- **Adjust AMPL to 220 mV.**
- **Press both AMPL keys to turn the VARiable mode off.**

VERTICAL**CH1+CH2**

- Using two probes, connect the Probe Adjust signal to Ch1 and Ch2.
- Press **AUTOSET**.
- Both Ch1 and Ch2 are now displayed.
- Adjust **POS** and **AMPL** to get a display as illustrated on the left below.
- Press the **CH1+CH2** key.

In the analog mode, a third trace will appear on the screen. This trace has twice the amplitude of the Probe Adjust signal. The position of the third trace is affected by the position controls of both Ch1 and Ch2.

The display mode is indicated in the screen as '1+2'.

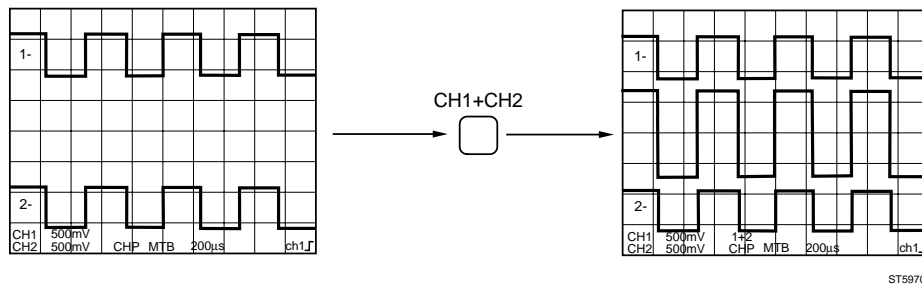

- Press the **ANALOG** key to switch to the Digital mode.

Observe that switching to the digital mode turns off the third trace. The '1+2' indication disappears.

- Press the **CH1+CH2** key once again.

Observe that in the digital mode the (CH1+CH2) trace can be used as well. Simultaneous display of both channels together with the sum of both channels is not possible in the digital mode.

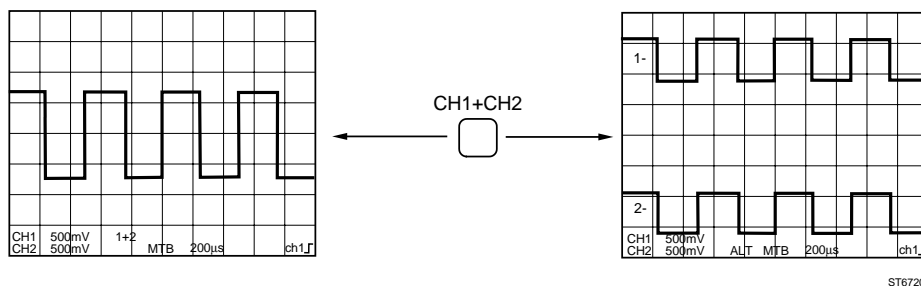

- Press the **ANALOG** key to return to the analog mode.

VERTICAL**INVERT**

The INVERT function in Channel 2 can be used to make it easier to do out-of-phase signal comparisons. The most common use of the INVERT function is to obtain the display or make the acquisition of the voltage difference between two channels. This is done by displaying or capturing the sum of Ch1 and Ch2 as follows. (This is referred to as the differential mode.)

- **Using two probes, connect the Probe Adjust signal to Ch1 and Ch2.**
- **Press AUTOSET.**
- **Both Ch1 and Ch2 are now displayed.**
- **Adjust POS and AMPL to get a display as illustrated on the left below.**
- **Press the CH1+CH2 key.**
- **Press the INV key of channel 2.**

Since channel 2 is inverted before it is added to channel 1, the result will be CH1-CH2. This is indicated as '1-2' on the screen. The signals on both inputs are the same, resulting in a straight line at ground level.

(If the line is not straight, this may be an indication that the probes are not correctly adjusted. When one of the probes is not properly adjusted, the input signals at the input connectors of the oscilloscope will be unequal. The difference of the two input signals shows up in the differential mode).

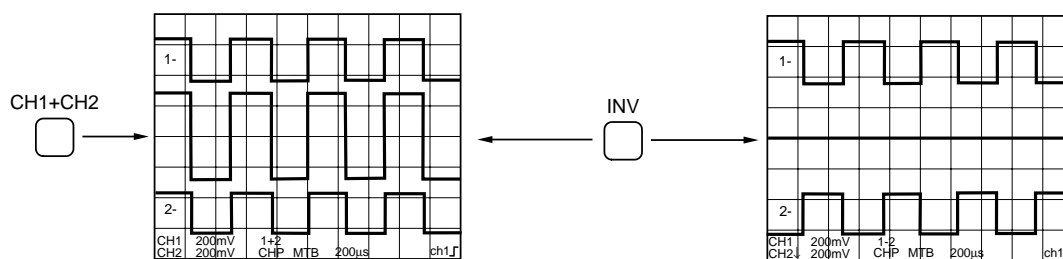

ST5969

VERTICAL MENU

BANDWIDTH LIMITER

The Bandwidth Limiter reduces the bandwidth of the vertical channels to 20 MHz. This is done by activating a filter in the vertical channels. This feature can be used both in analog mode and in digital mode to suppress high frequency noise. For repetitive signals and when in the digital mode, **averaging** is the preferred method to reduce noise without limiting the bandwidth.

- **Press the 'BW LIMIT' softkey to turn it on.**

Observe that the displayed line becomes "thinner" as an indication that the amount of noise is reduced.

The text 'BWL' appears in the bottom of the screen to indicate that the function is active.

- **Press the 'BW LIMIT' softkey to turn it off again.**

VERTICAL MENU**50Ω**

The 200 MHz models offer the selection of an input impedance of 50Ω on all input channels. The EXTTRIG input has no 50Ω possibility. The impedance selection is a subfunction in VERT MENU.

The 50Ω input impedance is used to obtain a correct impedance to match signal sources of the same impedance. For interconnection, a coaxial 50Ω cable must be used. The 50Ω position is indicated on the display with the Lz sign (Low Z = Low Impedance).

- **Disconnect all signals from the inputs.**
- **Using a 50Ω coaxial cable, connect a 4 Vpp, 2 kHz signal from a generator with 50Ω output impedance to channel 1.**
- **Press the AUTOSSET key.**
- **Press VERT MENU.**
- **Press the 50Ω CH1 softkey.**

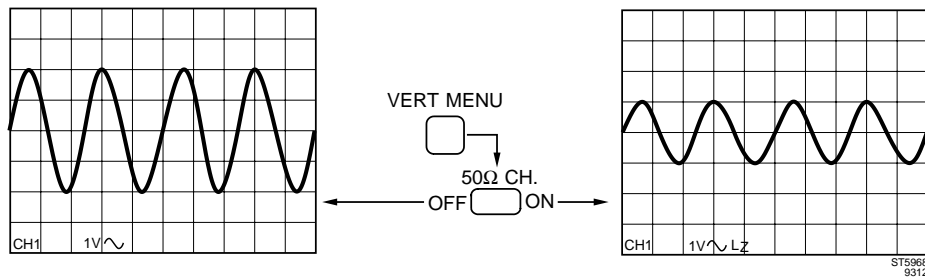

Observe that the displayed signal amplitude changes to half of the original amplitude. This is caused by the change of the input impedance to 50Ω, which results in a voltage division between the 50Ω output of the generator and the 50Ω input of the oscilloscope.

- **Remove the input signal from CH1.**

VERTICAL**PROBE RANGE INDICATOR**

- **Connect the probe again.**

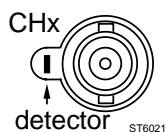

Since the 10:1 probe delivered with the instrument is a high impedance probe, the 50Ω termination is automatically turned off. At the same time, the sensitivity readout is adjusted automatically when a 10:1 or 100:1 probe is used. This way you don't have to multiply the displayed amplitude by 10 or 100 when you use a Fluke probe with range indication.

4.5 HORIZONTAL DEFLECTION AND TRIGGERING

Before starting with the horizontal deflection functions, you must set the instrument to a predefined state to create a correct start situation.

STANDARD SETTING

- Simultaneously press the **STATUS** and **TEXT OFF** keys.
- Connect the **Probe Adjust** signal to channel 1.

The Probe Adjust signal, now supplied to the input, is a square wave with a lower level of 0V and a top level of 600 mV.

- Press **AUTOSET**.

TIMEBASE

TIME/DIV

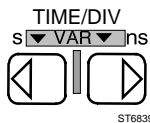

4 periods/cycles of the square wave are displayed on the screen.

- Press the 's' (left) key of the MainTB TIME/DIV key pair a few times.

The more you press the left ('s') key, the slower the timebase will run. This results in the number of displayed periods/cycles of the input signal to increase.

- Press the 'ns' (right) key of the MainTB TIME/DIV key pair a few times.

The number of displayed periods/cycles decreases as the timebase speed increases.

Observe that the timebase speeds are adjustable in steps following a 1-2-5 sequence.

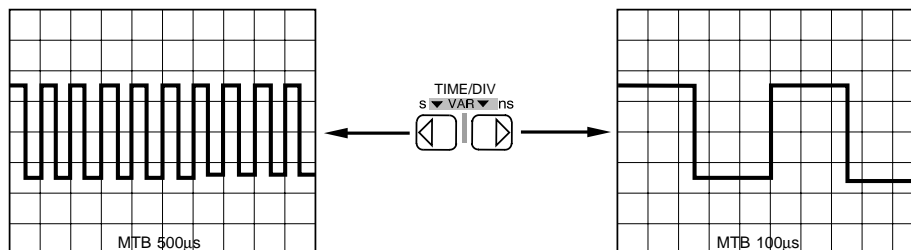

ST6709

- Set the timebase to **200 µs**.

The signal is displayed with four periods on the screen.

TIMEBASE**AUTO RANGE**

The AUTO RANGE function continuously adjusts the timebase to a display of 2 to 6 waveform periods.

- **Press the AUTO RANGE key.**

Observe that the timebase of the signal display changes to display 2 to 6 signal periods. AUTO TB in the upper right corner of the display indicates that the AUTO RANGE timebase function is active.

- **Press one of the TIME/DIV keys.**

The AUTO RANGE function is switched off and the AUTO TB indication disappears.

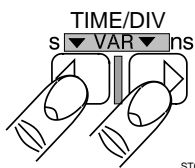
TIMEBASE**MAIN TB VAR**

Fine adjustment of timebase speeds between the 1-2-5 steps can be made by simultaneously pressing the MainTB TIME/DIV keys.

- **Activate the VAR function by simultaneously pressing the TIME/DIV keys.**
- **Press one key of the MainTB VAR keys.**

Observe that the timebase indication is now changing continuously instead of following the 1-2-5 step sequence.

The VAR timebase readout values are calibrated values. This enables accurate timing measurements using VAR timebase settings.

- **Adjust MainTB VAR to 850 μ s/div.**
- **Turn off the VAR function by pressing the MainTB TIME/DIV key pair simultaneously.**

Observe that the timebase is set to the nearest step value (1 ms/div).

In the Digital mode, the timebase speeds are determined by an XTal oscillator.

TIMEBASE**MAGNIFY****MAGNIFY**

ST6711

The displayed signal can be expanded horizontally so that more signal detail becomes visible. In the analog mode, a *10 magnification is possible and the entire sweep length can be made visible by turning the X POS control.

- **Press the right MAGNIFY key.**

The text 'MGN' appears in the bottom of the screen to indicate that the function is active. Observe that the timebase indication is changed from 1.00 ms/div to 100 μ s/div.

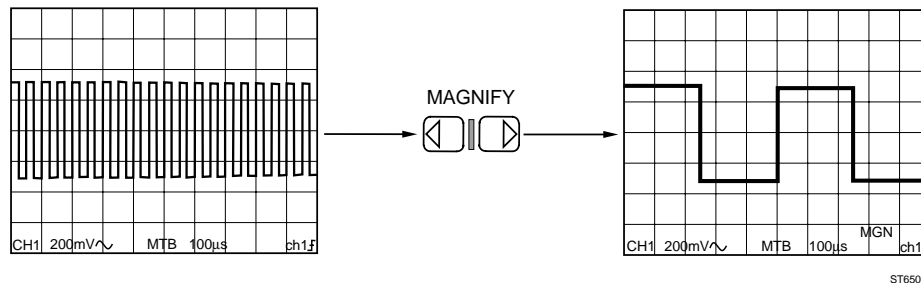

ST6504

- **Press the ANALOG key to set the scope in the digital mode.**
- **Press the right MAGNIFY key.**

Observe that the signal expands in *1, *2, *4 ... steps to a maximum of 32 times. This magnification factor is displayed briefly on the screen.

- **Set the MAGNIFY to *4.**

TIMEBASE
X POS



With X POS the displayed signal is shifted horizontally across the display.

- Turn the X POS control clockwise.

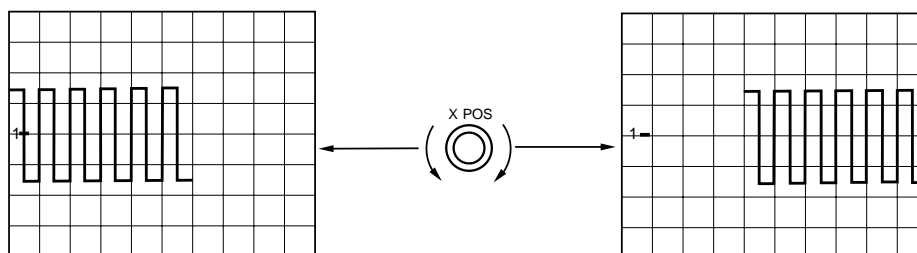

MAT4199

Observe that a bar graph (—■—) is displayed. The block on the bar graph shows which part of the digital trace is displayed as expanded. This block on the bar graph moves as you use the XPOS control.

- Press the RUN/STOP key.

Observe that the MAGNIFY key and the X POS control can still be used after the acquisition has STOPped. This allows you to look at signal details even after the signal has been acquired.

- Press the RUN/STOP key.

TRIGGERING

- Simultaneously press the STATUS and TEXT OFF keys.
- Press AUTOSET.

TRIGGER**SOURCE**

- Press the TRIG 2 key in the CH2 section of the front panel to select channel 2 as trigger source.

The indication in the lower right hand readout area of the screen now displays 'ch2'. Observe that the signal is not triggered. The ARM'D LED is on.

- Press the TRIG 1 key in the CH1 section of the front panel to select channel 1 as trigger source.

Observe that the indication has now changed into 'ch1' and the signal is triggered again.

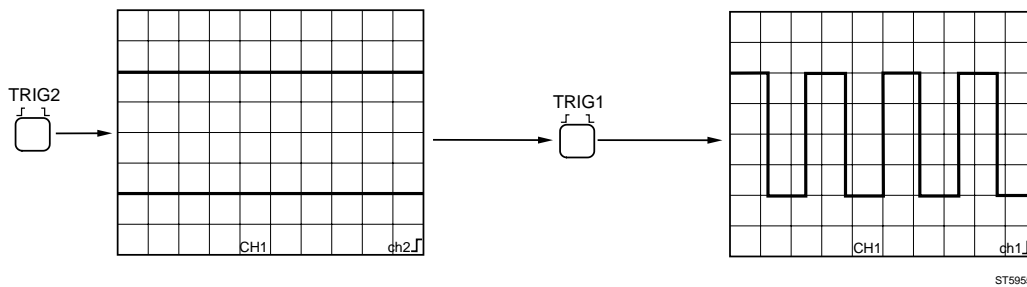
**TRIGGER****SLOPE**

 The trigger source selection key is also used to select the trigger slope between the positive- and negative-going edge of the triggering signal.

- Press the TRIG 1 key in the CH1 section of the front panel a second time.

Observe that the signal now starts with the trailing edge instead of a leading edge. Also the trigger slope symbol in the lower right hand corner of the readout area indicates a trailing edge.

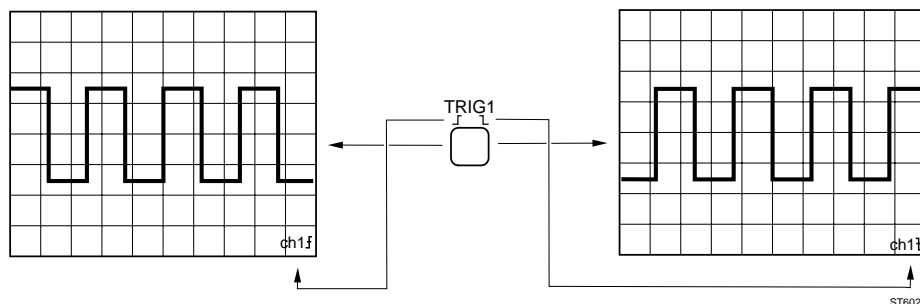

TRIGGER**TRIGGER LEVEL****TRIGGER
LEVEL**

After each AUTOSET, the trigger level is always clamped within the signal amplitude range to assure stable triggering on most signals. The trigger level is adjustable, but it is limited between the minimum (-100%) and the maximum (+100%) amplitude levels of the signal.

- Turn the TRIGGER LEVEL control.

As you turn the trigger level control, the trigger level readout in the bottom of the screen shows the trigger level relative to the signal amplitude. For example, it may appear as 'Level=+ 14%'.

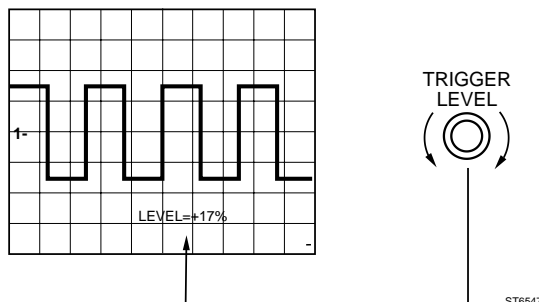

TRIGGER

TRIGGER POSITION

TRIGGER
POSITION

- **Press the ANALOG key to select the digital mode.**
- **Turn the TRIGGER POSITION control counterclockwise.**

One of the outstanding capabilities of a Digital Storage Oscilloscope is the ability to capture and display signal details before the trigger moment.

When you turn the TRIGGER POSITION control counterclockwise, the trigger point (▲) is shifted to the right. This allows you to look at the signal before the trigger point. The pretrigger view is displayed in the bottom of the screen, and calibrated in divisions. The trigger point is indicated on the screen with an arrow. Pretrigger recording can be adjusted and is limited to one full screen, or -10 divisions.

- **Turn the TRIGGER POSITION control clockwise.**

When the control is rotated clockwise, delay is added. The trigger point shifts to the left. The delay can be adjusted to a maximum of 1000 divisions, so that it is outside the screen. Positive trigger delay is indicated in seconds or in fractions of seconds.

- **Set the delay to 0 with TRIGGER POSITION**

TRIGGER**SINGLE SHOT**

- **Make sure the instrument is in the Digital Mode.**
- **Press AUTOSET.**

This sets up the scope with the proper amplitude and timebase settings.

- **Remove the probe tip from the Probe Adjust output.**
- **Turn the TRIGGER POSITION to mid-screen (counterclockwise).**
- **Press the SINGLE key.**

This **automatically** prepares the scope for a single acquisition.

Observe that the screen has been cleared, and that the ARM'D LED is on. This indicates that the scope is armed and waits for a trigger. The trigger level is automatically set to .5 divisions (indicated by 'T-').

- **Look at the screen and touch the Probe Adjust output with the probe tip.**

Observe that the oscilloscope 'runs' once and that a signal appears on the screen. The ARM'D LED is turned off. At the moment you touched the Probe Adjust output with the probe, the scope was triggered. The trigger moment is displayed in the center of the screen. The left side of the screen displays the part of the signal before triggering (pretrigger information).

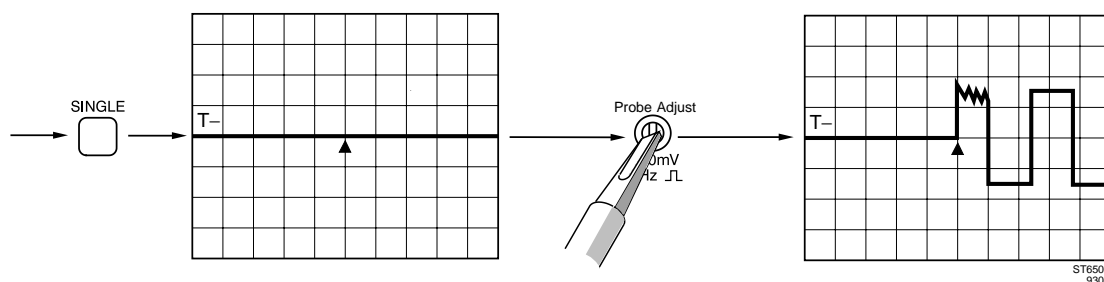

In SINGLE SHOT also 'Dual Slope' triggering is possible. See chapter 5 TRIGGER MAIN TB function.

4.6 DIGITAL ACQUISITION AND STORAGE

This section gives you a short introduction to digital acquisition and storage in order to provide the basic knowledge and terms. This information is necessary for you to understand all digital statements in the following sections of the manual.

ANALOG:



DIGITAL:

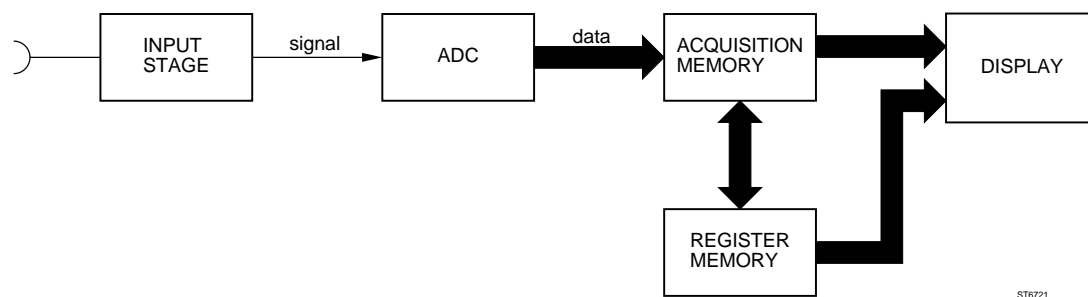

ST6721

In the **analog** mode the input signals are directly displayed on the screen.

In the **digital** mode the channels are applied to the input stage of the digital circuit: the analog-to-digital convertors (ADC's). The ADC's convert the analog signal(s) into digital data. Depending on the selected timebase speed, this sampling and conversion is done at a rate of up to 200 million samples per second (200 MS/s). This high sampling rate allows you to observe fast signal variations.

Digital information from the adc is then stored in a Acquisition Memory. The data acquisition in this memory can be stopped to freeze the trace on the screen. You can also store (save) complete registers or separate signals into a "background" memory, called Register Memory. Traces can be stored as long as you like and can be recalled at any time.

The CombiScopes in this range have a standard memory of 8K. The record length for each trace is the maximum number of samples divided by the number of traces. With the standard scope, the memory depth of 8K is available for two channels. The memory is partitioned so that 1x8K, 2x4K or 4x2K records can be captured. For maximum update rate, records can be made as short as 512 points. If the memory expansion option is installed, the record length can be adjusted between 32K and 512 points.

4.7 ADVANCED VERTICAL FUNCTIONS

All basic functions of the oscilloscope are accessible via direct action front panel keys.

More advanced functions are easily accessible via the menus behind the menu initialization keys (keys with their function name in blue text).

STANDARD SETTING

Before continuing with the advanced vertical functions, you must set the instrument to a predefined state to ensure a correct start situation.

- **Simultaneously press the STATUS and TEXT OFF keys.**
- **Connect the Probe Adjust signal to channel 1.**

The Probe Adjust signal, now supplied to the input, is a square wave with a lower level of 0V and a top level of 600 mV.

- **Press AUTOSET.**

ACQUIRE**AVERAGE**

The **average** function averages the input data over a number of successive acquisitions. The average function is used to reduce the influence of random noise in the input signal. There is no loss of bandwidth when the average function is activated, but the signal must be repetitive. The number of samples over which the average is calculated can be selected by the user.

- Use the probe to connect Ch1 to the Probe Adjust output.
- Press **AUTOSET**.
- Connect the second probe to channel 2, but do not connect it to a signal!
- Press the **CH1+CH2** key to add Ch1 and Ch2 together.
- Press the **mV** key of the **CH2 AMPL** keys so that the noise picked up by the probe tip of the second probe appears on the **CH1+CH2** trace.
- Press the **AVERAGE** key.

For maximum ease of use, the scope offers **direct** access to the important **average** feature.

The text 'Average = 8' appears in the bottom of the screen to indicate that the function is active. The default value is 8. The indication changes into 'AVG'. Observe that the noise on the trace is reduced.

- To change the Average constant, press the **ACQUIRE** key.
- Turn the **TRACK** control clockwise.

The Average factor increases when the **TRACK** control is turned clockwise. Observe that this reduces noise on the trace even more.

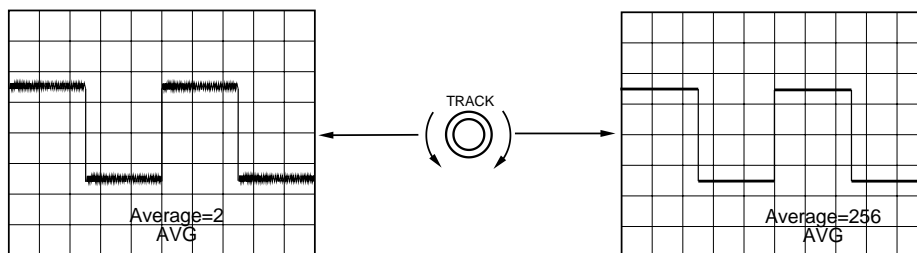

ST6481

- Turn the **TRACK** control counterclockwise so that the Average factor is 8 again.

ACQUIRE**ENVELOPE**

The **ENVELOPE** mode records the minimum and the maximum of the signal over a number of acquisitions.

- Press the **ACQUIRE** key.
- Press the **'ENVELOPE'** softkey to turn it on.

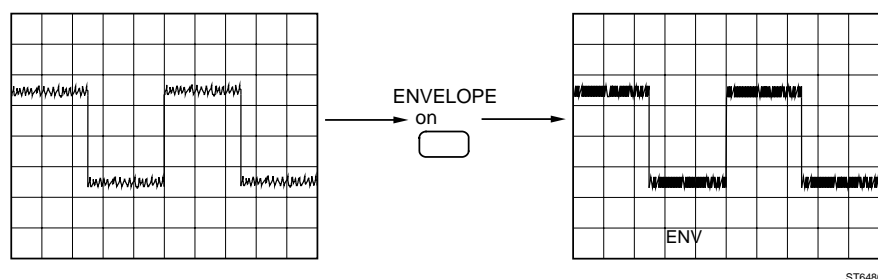

The **AVERAGE** mode and the **ENVELOPE** modes are mutually exclusive. Observe that **AVERAGE** is automatically switched off. The text **'ENV'** appears in the bottom of the screen to indicate that the function is active.

The minimum and maximum of the input signal is stored and becomes visible on the screen. This process continues until it is turned off by the user.

- Turn the **POS control of Ch1**.

Observe that every time you change the settings of the scope (like trace **POS**) the **ENVELOPE** process automatically starts again.

- Press the **'ENVELOPE'** softkey to turn off the **ENVELOPE** mode.

ACQUIRE**PEAK DETECTION**

PEAK DETECTION automatically catches peak values (up to glitches of 10 ns width) of the input signal during a single acquisition.

- Press the **'PEAK DET'** softkey to turn it on.

The text **'PKD'** appears in the bottom of the screen to indicate that the function is active. Observe that any glitch on the input signal becomes visible on the screen.

Note: Regardless of the timebase speed selected, the scope is set to the highest sample rate, so that glitches up to the sample frequency can be caught (5 ns at 200 MS/s).

- Press the **'PEAK DET'** to turn it off again.

4.8 ADVANCED HORIZONTAL AND TRIGGER FUNCTIONS

All basic timebase and trigger functions of the oscilloscope are accessible via direct action front panel keys. More advanced functions are easily accessible via the menus behind the menu initialization keys (keys with the function in blue text).

STANDARD SETTING

Before continuing with the advanced functions, you must set the instrument to a predefined state to ensure a correct start situation.

- **Simultaneously press STATUS and TEXT OFF.**
- **Connect the Probe Adjust signal to channel 1.**
- **Press the AUTOSET key.**

TRIGGER

MODE

- **Press the TRIGGER key.**

On the screen the 'TRIGGER MAIN TB' menu is displayed. The menu functions can be selected by pressing the blue softkeys to the right of the screen. The top softkey selects the trigger mode ('edge' or 'tv'). The lower part of the menu is optimized for the selected trigger modes.

- **Press the first softkey to select 'tv' trigger mode.**

Observe that the lower part of the menu is optimized for tv applications.

- **Press the first softkey to return to 'edge'.**

Note : In the Digital mode, an additional selection is available. This is called "logic" or "glitch". A full description of the Logic and Glitch triggering functions can be found in Chapter 5.

TRIGGER**LEVEL**

- Press the 'level-pp' softkey to turn it off.

TRIGGER LEVEL  The automatic level detection circuitry is turned off. The trigger level is no longer clamped within the peak-peak range of the signal. You must adjust the proper trigger level. While you turn the TRIGGER LEVEL control, the actual trigger level is displayed in (m)V.

An indicator 'T-' is displayed next to the channel identifier when the combination of trigger coupling and channel input coupling is useful (both ac coupled or both dc coupled).

When the 'T-' is within the signal range, a stable display of the signal is obtained. When proper triggering takes place, the ARM'D LED is off.

Use the TRIGGER LEVEL control to move the indicator (T-) vertically.

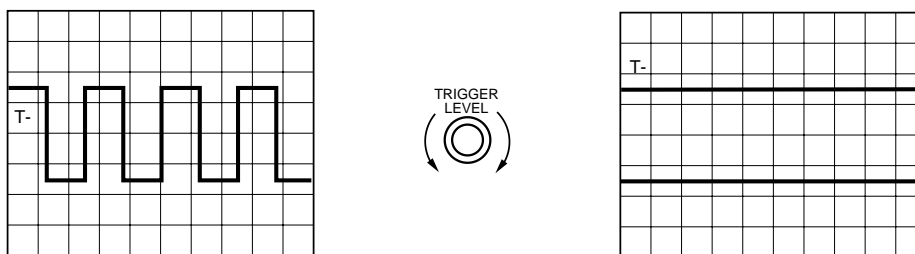

ST6738

When the trigger level indicator (T-) is outside the signal range, triggering is lost. Because of the nature of the (Probe Adjust) input signal, it appears that only two lines are drawn. The timebase is not properly triggered, as is indicated by the ARM'D LED being turned on.

Note: 'T-' is an indication for reference only. Its position can differ slightly from the actual trigger level.

TRIGGER MODE**TRIGGERED**

- Press the TB MODE key.

TB MODE



In the screen, the timebase mode (TB MODE) menu appears. 'auto' is intensified. With the "auto" mode turned on, the timebase will run free as soon as no triggering signal is detected, in order to provide a base line. The 'Auto' mode works well with most signal that have frequencies of 30 Hz or higher.

- Press the softkey next to the 'auto trig single' function to select 'trig'.

In the triggered mode, a signal is visible only when proper triggering occurs.

- Move the indicator (T-) in and out of the signal range.

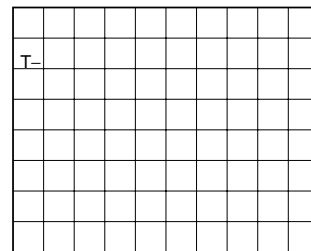
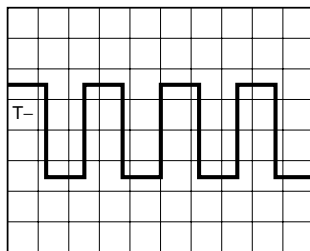

ST6737

In the **Analog** mode, the result is a stable and triggered signal when the indicator is inside the signal range, and no trace appears on the screen when the indicator is outside the signal range.

Disabling the 'auto' function by selecting 'trig' can be useful for displaying very low frequency signals. The scope waits for a real trigger before the sweep starts even if the signal frequency is very low.

In the **Digital** mode, the same criteria exist for the use of the 'auto' function and the 'trig' function, but there is a difference. When the scope is in the 'trig' mode and triggering is lost, the acquisition will stop, but the display will reflect the last information before the triggering stopped. This may lead you into thinking that the scope is properly triggered because the display appears to be stable, while in fact, you are displaying stored information only. Watch the ARM'D LED !

TRIGGER MODE

ROLL

- **Press the ANALOG key to select the digital mode.**
- **Press the TB Mode key to enter the TB mode menu**

The TB MODE menu is extended with extensive timebase modes. The differences are as follows:

- A Roll mode
 - Selection of 'Real-time only'
 - Delay by events
 - Selection of Acquisition length
- **Press the softkey next to the 'ROLL on off' function to select 'on'.**

The 'ROLL on' function is now intensified.

Observe that the timebase is automatically set to 200 ms. The trace moves from the right to the left.

- **Press the 'STOP ON TRIGGER' softkey to select 'yes'.**

The trace stops when the trigger (in this case the start of the first period) reaches the left of the screen.

Using the roll mode, you can monitor signals like temperature changes and chemical processes at low timebase speeds. In this mode the scope operates like a four-pen plotter. Over 36 hours of events can be recorded in memory and plotted later.

Unlike a paper and pen plotter, the scope can record glitches as narrow as 5 ns, and the record can be stopped when a trigger condition is met.

TRIGGER

LINE

- **Connect a sine-wave signal of 4 V/300 Hz to channel 1.**
- **Simultaneously press the STATUS and TEXT OFF keys.**
- **Press AUTOSET.**
- **Select a timebase speed of 1 ms/div.**
- **Press the TRIGGER key.**
- **Press the softkey next to the function 'ch1 line' to select 'line'.**

When 'line' is selected, this function is intensified. The line frequency is used as the trigger source.

- **Slowly vary the frequency of the sine-wave input signal.**

Observe that when the input frequency is close to an integer multiple of the line frequency, the running sine wave slows down or even stands still. Line triggering can be used to display signals or signal components that are related to the line frequency (e.g., hum or power supply ripple).

4.9 MEMORY FUNCTIONS

The next section deals with storing and recalling traces in memory for later use. Functions related to trace storage and recall are easily accessible via the menu selection keys labeled 'SAVE' and 'RECALL'.

STANDARD SETTING

Before continuing with the memory functions, you must first set the instrument to the default setting to ensure a correct start situation.

- **Simultaneously press the STATUS and TEXT OFF keys.**
- **Connect the Probe Adjust signal to channel 1.**
- **Press AUTOSET.**

The Probe Adjust signal, now supplied to the input, is a square wave with a lower level of 0V and a top level of 600 mV.

TRACE STORAGE

CLEAR & PROTECT

SAVE



- **Press the ANALOG key to select the digital mode.**
- **Press the SAVE key to enter the 'SAVE ACQ TO MEMORY' menu.**

To be sure that all unnecessary stored traces are removed, you first will clear all memory locations.

- **Press the 'CLEAR & PROTECT' softkey.**
- **Press the 'clear all' softkey.**

The scope now displays the confirmation submenu to prevent you from removing traces you did **not** want to remove.

- **Press the 'yes' confirm softkey.**

If any memory locations were protected ('PROTECT ON' in CLEARS PROTECT MEMORY submenu), a second confirmation must be given.

- **Press the 'yes' confirm softkey again.**

TRACE STORAGE

SAVE

- Turn the **TRACK** control to select the memory location in which to store the trace data.

Observe that eight memory locations 'm1 to m8' (or 50 memory locations when extended memory is installed) scroll through the menu. All locations are marked with a circle before the memory number.

- **Select memory location 'm1'.**
- **Press the 'save' softkey.**

The signal is saved in memory location m1.

Observe that the circle before 'm1' is solid now to indicate that this memory location is occupied.

- **Set the MainTB to 500 μ s.**
- **Select location 'm2'.**
- **Press the 'save' softkey.**
- **Set the MainTB to 200 μ s/div.**
- **Select location 'm3'.**
- **Press the 'save' softkey.**

Observe that memory locations 'm2' and 'm3' are now solid bullets as well.

TRACE STORAGE

CLEAR

You can also clear a memory location.

- **Select location 'm2'.**
- **Press the 'clear' softkey.**

This clears memory location 2. This is indicated by the open circle.

TRACE STORAGE

COPY

A trace can be copied from one memory location to another.

- **Press the 'COPY' softkey.**

The 'COPY MEMORY' is now displayed. The source ('FROM') and destination ('TO') memory locations can be selected in this submenu.

- **Turn the TRACK control to select 'm3' as source from.**
- **Turn the Δ control to select 'm2' as destination to.**
- **Press the 'copy' softkey.**

The contents of 'm3' have now been copied into 'm2' without destroying the data in 'm3'.

TRACE STORAGE**RECALL****RECALL**

If you completed all of the previous steps, three memory locations are occupied by trace information. You can display these stored traces at any time and in any combination.

- **Press the RECALL key.**
- **Turn the TRACK control to select 'm1'.**
- **Press the 'DISPLAY on off' softkey to display m1.**

Observe that the stored trace on memory location 'm1' is displayed and that the circle before m1 is solid.

An open circle indicates an empty memory location.

A circle with a dot indicates that there is a trace stored, but it is not displayed.

A solid circle indicates trace data in memory are displayed on the screen.

Empty memory locations cannot be displayed.

You can shift traces separately over the screen by means of the Δ control.

- **Turn the POSition control**

The live trace shifts.

- **Turn the TRACK control to select 'm2'.**
- **Press the 'DISPLAY on off' softkey to on.**
- **Turn the Δ control.**

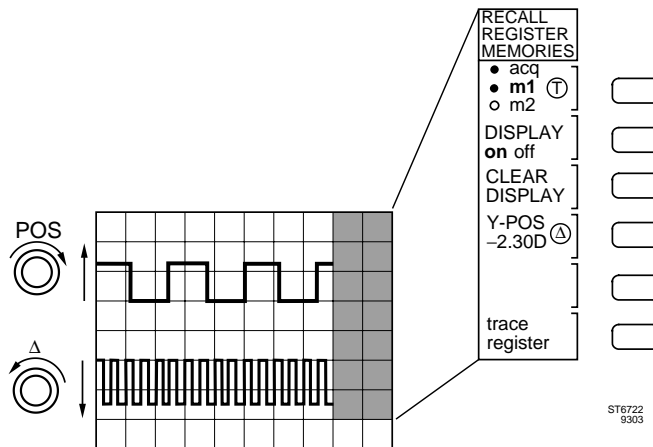

Observe that the second stored trace shifts.

TRACE STORAGE**SAVING MULTIPLE TRACES**

Each memory location can store two channels.

- **Connect the probe to channel 1.**
- **Press AUTOSET.**
- **Switch on channel 2.**
- **Turn the channel 2 POS control counterclockwise.**

The upper trace displays the signal of channel 1, and the lower line represents channel 2.

- **Press the SAVE key.**
- **Turn the TRACK control to select memory location 'm1'.**
- **Press the 'save' softkey to store two traces in 'm1'.**

Observe that m1 was already filled, so the confirmation submenu is displayed.

- **Press the softkey next to 'yes'.**

This overwrites memory 'm1' with the new traces.

TRACE STORAGE**RECALLING MULTIPLE TRACES**

- **Press the RECALL menu key.**

The memory location is already preset to the last saved (m1).

- **Press the 'DISPLAY on off' softkey so that 'm1' is displayed.**
- **Turn the Δ control counterclockwise.**

Observe that both traces are displayed and shifted to the lower screen.

- **Press the softkey next to 'trace register' to select 'trace'.**

Observe that the menu displays both traces of register 1 (m1.1 and m1.2). Both are filled: m1.1 with the signal of channel 1 and m1.2 with the signal from channel 2.

- **Turn the TRACK control to select m1.1.**
- **Press the 'DISPLAY on off' softkey to off.**

Observe that the stored trace of channel 1 is not displayed any more.

- **Press the 'CLEAR DISPLAY' softkey to clear all stored traces before continuing to the next section.**

4.10 CURSORS FUNCTIONS

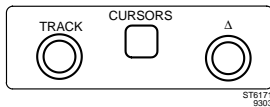

Cursors are provided to make fast and accurate amplitude and time measurements. These can be done in digital mode as well as in analog mode.

The **analog** mode of the oscilloscope is often used to accurately display complex waveforms, such as in AM, FM, and Video.

The **digital** mode will often be the preferred operating mode for single accuracies which have to be studied or analyzed.

When operating in **digital** mode, the cursors are always set to the optimum place for that particular measurement and the readout is directly displayed on the screen.

This is the fastest and easiest way for most of the measurements .

But for measurements on very complex signals with different waveforms in a trace, the **analog** cursor measurements gives you a very helpful tool to find your measurement.

STANDARD SETTING

Start with the standard setting. This ensures you have the correct start condition.

- **Press the STATUS and TEXT OFF keys simultaneously.**
- **Connect the Probe Adjust signal to channel 1.**

The Probe Adjust signal now supplied to the input is a square wave with a lower level of 0V and a top level of 600 mV.

- **Press the AUTOSET key.**

CURSORS**ON/OFF**

There are two sets of cursors : amplitude cursors and time cursors. Amplitude cursors are two horizontal lines, and Time cursors are two vertical lines. The dashed lines are referred to as reference cursors and the dotted lines are referred to as delta (Δ) cursors.

Cursor measurements can be made in both operating modes of the instrument. Amplitude and time cursors can be displayed at the same time.

- Press the **ANALOG** key to set the scope in mode.
- Press the **CURSORS** key to enter the cursors menu.

The menu is now displayed. Time cursors ('||') are selected by default. In the digital mode, two 'x's mark the actual measuring point where the cursors intersect with the signal. In the analog mode these 'x' indicators are not available.

CURSORS**TIME**

Using the TRACK and Δ controls, you can adjust the position of the cursors. The time and amplitude difference between the cursors is read in the top of the screen. Cursor readout parameters can be changed and are selected via the 'READ OUT' softkey.

- Turn the **TRACK** control and observe that both cursors move.
- Turn the **Delta (Δ)** control and observe that only the delta cursor moves.

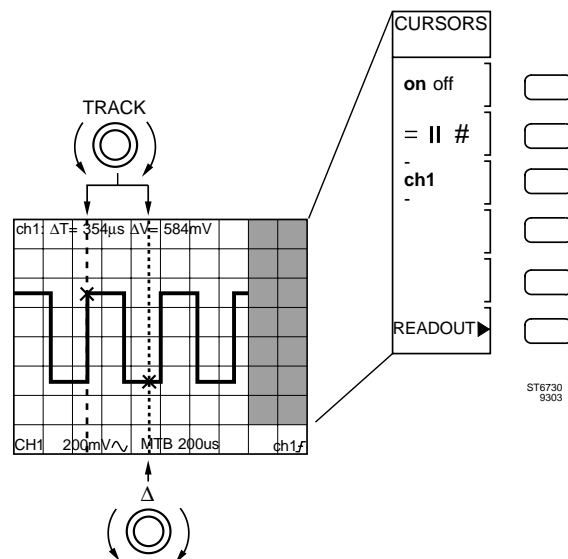
ST6730
9303

CURSORS**VOLT**

- Use the softkeys, to select the amplitude cursors ('=' intensified).

Two amplitude cursors will appear in the display.

The menu permits the channel to be selected for which the amplitude cursors apply.

When channel 1 is the only channel displayed, 'ch1' is the only selection.

- Turn the TRACK control to move both cursors, and turn the Delta (Δ) control to move only the Δ cursor.

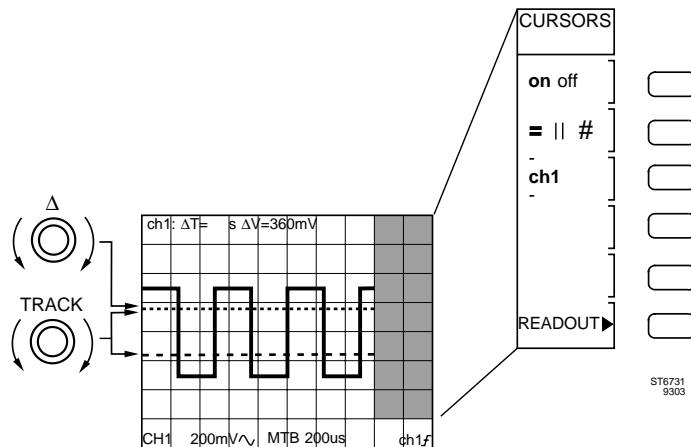
**CURSORS****AMPLITUDE & TIME**

Amplitude and Time cursors can be displayed at the same time. When both amplitude and time cursors are displayed, you must select which cursors are affected by the TRACK and Δ controls. This selection is made by toggling the softkey 'CONTROL'.

Channel selection applies only to the voltage cursors. The time cursor always applies to all channels.

To use both types of cursors at the same time, do the following:

- Press the softkey next to '= || #' so that '#' is intensified.
- Press the CONTROL softkey so that '=' is intensified.
- Turn the TRACK control and observe that only the amplitude cursors move.
- Press the CONTROL softkey so that '||' is intensified.
- Turn the TRACK control and observe that only the time cursors move.

CURSORS**READOUT**

- Press the softkey next to 'READOUT'.

The 'CURSOR READOUT' selection menu for horizontal and vertical measurements is now displayed. You can make the following selections from this menu: ΔT , $1/\Delta T$, ΔT -ratio, T-trg and phase for time measurements. ΔV , V1, V2, ΔV -ratio for voltage measurements.

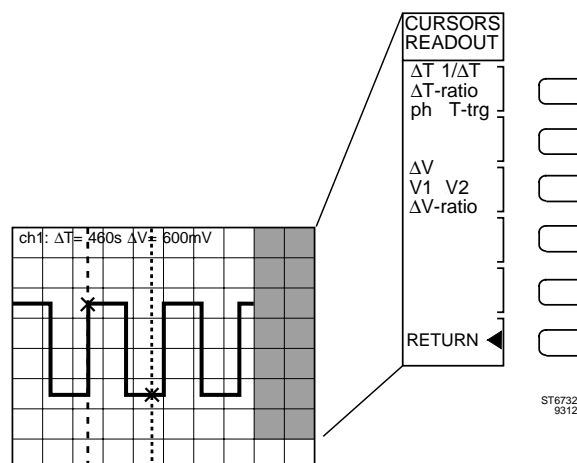

ΔT is the time difference between the time cursors. The readout is in seconds (s) or fractions of seconds.

$1/\Delta T$ results in the inverted value of the time difference, and is displayed in Hz. When the time cursors are set exactly one period apart this represents the frequency of the signal.

ΔT -ratio allows for a relative measurement of two cursor readings. It is displayed as a percentage.

Phase is used to measure a phase difference between two signals, or to determine the phase of a detail within one signal.

T-trg gives the time difference between the cursors and the trigger point.

ΔV is the voltage difference between the voltage cursors (readout: $\Delta V=...V$).

V1, V2 displays the absolute voltages for each voltage cursor in relation to ground (readout: $V1=V_{reference}$, $V2=V_{\Delta}$).

ΔV -ratio allows for a relative measurement of two cursor readings. It is displayed as a percentage.

ST6732
9312

CURSORS READOUT **ΔT -RATIO/PHASE**

First, the reference distance between the two cursors is set. This then is set to 100 % (360°) by pressing the $\Delta T=100\%$ (360°) softkey. Changing the distance between the cursors now results in a % ($^\circ$) reading of the reference.

- Press the softkey next to ΔT until ΔT -ratio (phase) is intensified.
- Set the time cursors to be exactly one signal period apart.
- Press the softkey next to $\Delta T=100\%$ (360°).

In the cursor readout line of the screen, the value for ΔT is now ' $\Delta T=100\%$ ' ($\Delta T=360^\circ$)

Observe that the 100% (360°) reference does not change when the TRACK control is turned.

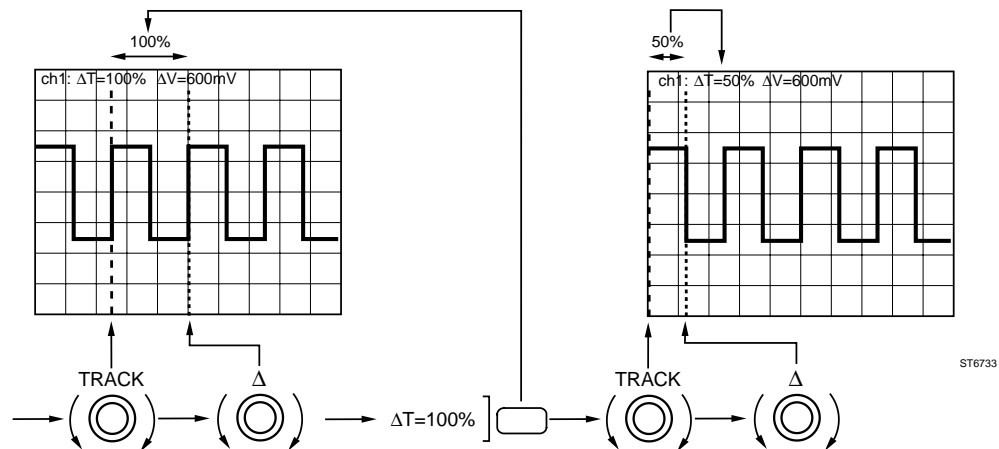

- Adjust the cursors to a distance of half a signal period.

Now the ΔT in the readout area will read ' $\Delta T=50\%$ ' ($\Delta T=180^\circ$)

This is the way to use the cursors for duty cycle measurements.

4.11 MEASUREMENT FUNCTIONS

When operating in the **analog** mode, you can use the cursors to measure amplitude and time data.

When operating in the **digital** mode, the scope has an extensive set of **fully automated** amplitude and time measurement functions. You can select two measurements to be performed simultaneously. These measurements are updated automatically, so that when signals change, the measured values automatically changed at the same time. The read- outs are displayed in the upper section of the screen.

STANDARD SETTING

Start with the standard setting. This ensures a correct start.

- **Simultaneously press the STATUS and TEXT OFF keys.**
- **Connect the Probe Adjust signal to channel 1.**

The Probe Adjust signal now supplied to the input is a square wave with a lower level of 0V and a top level of 600 mV.

- **Press AUTOSET.**

MEASURE

MEAS1-PKPK

MEASURE



- **Press the ANALOG key to select the digital mode.**
- **Press the MEASURE key.**

The displayed menu gives access to the two measurements MEAS 1 and MEAS 2. Each measurement can be independently turned on and off. In this menu, you can select the measurement in MEAS 1 and MEAS 2 function.

Observe that the measurements are linked to the active channel. The two default measurements are 'pkpk' and 'freq'.

- **Press the second softkey to turn MEAS1 to 'on'.**

The screen automatically displays the result of the peak-to-peak measurement: 'ch1: pkpk=mV'.

- **Press the softkey next to 'MEAS1'.**

The menu displays the 'SELECT MEAS 1" submenu. You can choose from three main measurements: volt, time, or delay. The lower part of the menu optimizes to the selected main measurement.

The actual type of measurement is selected by using the 'TRACK' control. The following voltage measurements are available : dc, root- mean square, minimum peak, maximum peak, peak-to-peak, low level, high level.

The following time measurements are available : frequency, period, pulse width, rise time, fall time, duty cycle.

The 'delay' measurements include the time delay between leading or trailing edges between any two channels or traces. (Channel or trace **must** be on the display)

MEASURE

MEAS1-RMS

- **Select 'volt' measurements.**
- **Turn the TRACK control to select 'rms'.**

Observe that the screen displays the result of the rms measurement: 'ch1 rms =V'.

MEASURE**MEAS 2-FREQ**

- Press the 'RETURN' softkey to return to the 'MEASURE' menu.
- Turn on MEAS 2.

MEAS 2 performs a frequency measurement on the same signal. The screen displays this result as : 'ch1 freq=kHz'.

- Remove the Probe Adjust signal from channel 1

Because of the absence of an input signal, no frequency can be measured. This results in the display 'ch1 freq= ----Hz'.

MEASURE**DELAY**

- Connect the Probe Adjust signal to channels 1 and 2.
- Turn on channel 2.
- Shift the signal on channel 1 to the upper half of the screen and the signal on channel 2 to the lower half of the screen.
- Press the softkey next to MEAS1.

The SELECT MEAS1 submenu is displayed.

- Press the first softkey to select 'delay'

The delay measurement is performed automatically. Observe that the first measurement is linked to the channel 1 signal (on positive slope) and the second is listed to the channel 2 signal (on negative slope). The delay is displayed in the top corner of the screen 'ch1: del = μ s'.

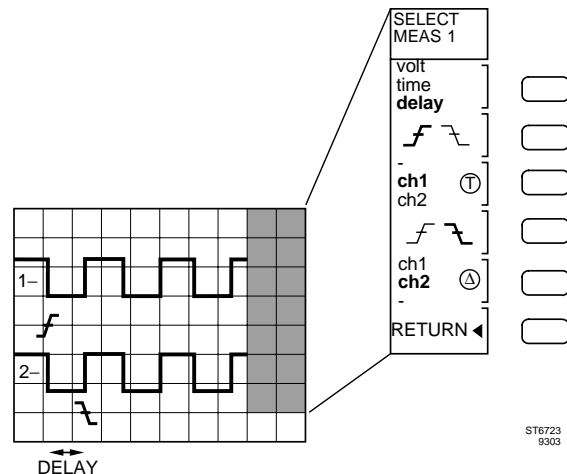

- Press the RETURN softkey to return to the MEASURE menu.

This measurement is very useful when you must compensate unequal cable delays.

MEASURE**CURSOR LIMIT**

With cursor limited measurements it is possible to perform measurements on a part of the waveform.

- **Press the softkey next to CURSOR LIMIT& STATIST.**
- **Set CURSOR LIMITED to 'yes'.**
- **Turn the Δ control to reduce the area between the cursors.**

Notice that the measurement result shows dashes when the area between the cursors gets too small.

- **Press the RETURN softkey to return to the MEASURE menu.**
- **Turn off the measurements MEAS1 and MEAS2.**
- **Disconnect the probe from channel 2 before continuing to the next section.**

MEASURE**TOUCH, HOLD & MEASURE™**

The probes delivered with the oscilloscope offer a unique and innovative way to perform a number of functions directly from a push button mounted on the side of the probe. One of these functions is called 'TOUCH HOLD and MEASURE™'. The TOUCH HOLD & MEASURE™ function is a very quick way to instantly display the four main measurements. You need only one single push button. This push button is located nearest to the place of measurement on the probe; therefore, this button is referred to as COMMAND switch.

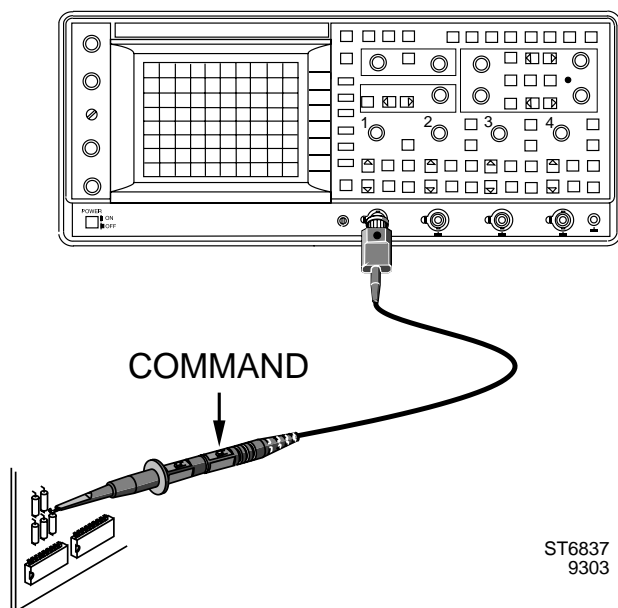

Before using the COMMAND switch on the probe, you must first adapt the instrument's reaction to this function. This is done in the 'UTILITY >> PROBE' menu.

The procedure to set up for TOUCH, HOLD and MEASURE™ is:

- Press the **UTILITY** key.
- Press the softkey labeled '**PROBE**'.
- Select '**q.meas**'.
- Press the **COMMAND** push button on the probe.

Observe that the screen displays the signal frequency and amplitude dc voltage level (dc, pkpk, rms, and freq) measurements.

The probe **COMMAND** switch gives you the fastest and easiest method of trouble-shooting. You can keep your eyes on the circuit to be measured without having to move your eyes to press a push button on the scope.

NOTE: The probe COMMAND switch can also be used for other functions. Programming of other functions is done in the UTILITY menu (see section 5)

4.12 PROCESSING FUNCTIONS

MATH



Most oscilloscopes, including most Digital Storage Oscilloscopes, limit their capabilities to the display of amplitude (in volts), versus time.

In addition to those traditional oscilloscope functions, this range offers capabilities to mathematically change the contents of each memory location. To do so, the functions under 'MATHEMATICS' allow you to calculate new waveforms from existing other traces serving as input data.

If your oscilloscope is equipped with the MATH + option, more functions are available than the ones described in this section. Additional information on the additional functions is described in a separate manual.

The section below describes the mathematical functions implemented in the standard oscilloscopes versions.

Two mathematical functions MATH 1 and MATH 2 can be used as two independent processes. They can be used in series or in parallel.

The result of MATH 1 is always stored in memory location 'm1'.

The result of MATH 2 is always stored in memory location 'm2'.

When used for mathematical functions, existing memory locations are overwritten. (Use the 'Copy' function to save important traces in another memory location, before using the mathematical functions.)

STANDARD SETTING

Start with the standard setting to ensure that you have the correct start condition.

- **Simultaneously press the STATUS and TEXT OFF keys.**
- **Connect the Probe Adjust signal to channel 1.**
- **Press AUTOSET.**

The Probe Adjust signal now supplied to the input is a square wave with a lower level of 0V and a top level of 600 mV.

MATHEMATICS**FILTER**

- Press the **ANALOG** key to select the digital mode.
- Press the **MATH** menu key.

The MATH menu is displayed on the screen. Observe that MATH 1 is the default.

- Press the softkey next to **MATH 1** to enter the **MATH 1** submenu.

This menu is used to select one of the four mathematic functions: 'add, sub, mul, filter'.

Observe that the default process for MATH 1 is the 'filter' function. Typical use of the digital low-pass filter is to suppress noise even after a (single shot) acquisition has to be captured.

You can select between the acquired signal or a stored signal to be the source. The trace information in the source trace is mathematically filtered by a low-pass filter.

The resulting trace is automatically stored in memory location 'm1' and displayed on the screen.

- Turn the **TRACK** control to select 'acq'.
- Press the '**ENTER**' softkey.
- Press the key next to 'on off' to turn **MATH 1** on.

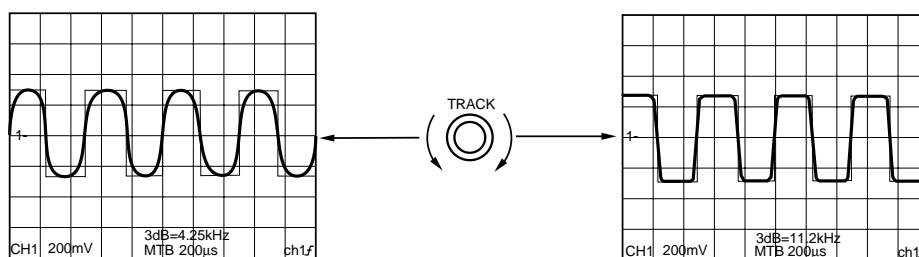

ST6745

- Turn the **TRACK** control to change the cut-off frequency.
- Switch off **MATH 1** again before continuing to the next section.

MATHEMATICS**MULTIPLY**

You can activate a second process MATH 2. This way, two processes can run at the same time.

- **Connect the Probe Adjust signal to channel 1 and channel 2 and turn on both channels.**
- **Press the 'MATH 2' softkey in the MATH menu.**

The menu displays the MATH 2 functions. MATH 2 offers the same functions and parameters as MATH 1.

For MATH 2 the default parameter is 'mult'.

Using 'MULT' means that two selected traces are multiplied together and that the result is stored in 'm2'.

- **Press the softkey next to MATH 2 to enter the MATH 2 submenu.**

Observe that the submenu is now optimized for the multiplying process. You can select between all active traces or memory locations to be the source traces.

- **Turn the TRACK control to select ch1.**
- **Turn the Δ control to select ch2.**
- **Press the ENTER softkey to return to the main menu.**
- **Press the softkey next to 'on off' to turn MATH 2 on.**

The multiplied trace of channel 1 and channel 2 is instantly displayed on the screen. At this time the resulting trace is stored in memory location 'm2'.

One example of this process is to multiply voltage across a component and current through that component to find dissipated instantaneous power.

- **Switch MATH 2 off again.**

4.13 DISPLAY FUNCTIONS

When operating in the **analog** mode, you can set the scope to display XY displays by selecting 'X DEFLECTION' mode. In this mode the horizontal deflection is obtained from one of the input signals, while the analog timebase generator is turned off.

In the **digital mode** the 'DISPLAY' menu is extended.

STANDARD SETTING

Start with the standard setting. This ensures that you have the correct start.

- **Simultaneously press the STATUS and TEXT OFF keys.**
- **Connect the Probe Adjust signal to channel 1.**
- **Press AUTOSET.**

The Probe Adjust signal now supplied to the input is a square wave with a lower level of 0V and a top level of 600 mV.

ANALOG DISPLAY

X-DEFL

In X-DEFLECTION mode, 'XY' displays are used for direct comparisons of two or more signals : one as a function of one or more others.

Vertical deflection is selected in the same way as for 'normal' displays using the timebase. Horizontal deflection is obtained by selecting one of the sources as displayed in the X-DEFL menu on the screen.

- **Connect a sine wave of approx 300 Hz to channel 2.**
- **Press AUTOSET.**

Observe that the scope displays the two traces on the screen in analog mode.

- **Press the DISPLAY key to enter the analog DISPLAY MENU.**
- **Press the X-DEFL softkey to enter the X-DEFL sub menu.**
- **Press the 'on off' softkey so that 'on' is intensified.**

Two vertical lines appear on the screen.

The menu now displays the source for the X-axis intensified ('X=ch1').

The signal on channel 1 is a square wave. Consequently, there will be only two vertical levels to display. The signal on channel 2 is a sine wave, which is now displayed as a function of the square wave on channel 1.

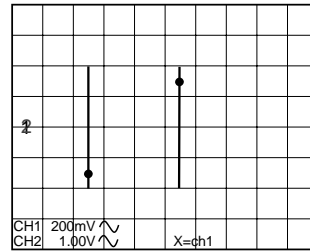

- Press the X SOURCE softkey so that 'line' is inten
- Turn off channel 1.

ST6739

Horizontal deflection is now obtained from the line voltage. On the screen channel 2 (sine-wave) is displayed against the line voltage. The signals on the horizontal deflection (line) and the vertical deflection (ch2) have different frequency.

- Vary the frequency of the generator to get an almost stable picture.

The displayed figure is called a Lissajous figure. This lissajous figure has 5 (60 Hz line) or 6 (50 Hz line) tops depending on the line frequency. The number tops multiplied by the horizontal (line) frequency results in the frequency of the vertical signal.

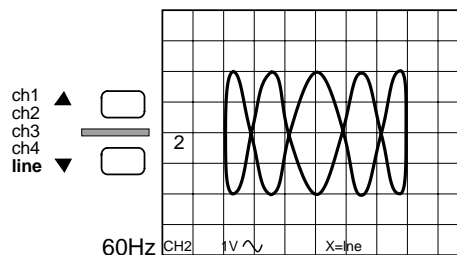
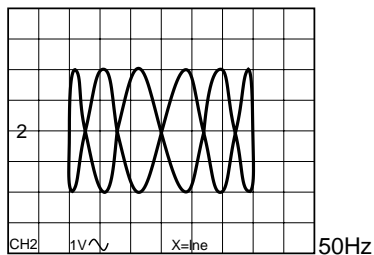

ST6006

If the generator is equal or close to the line frequency, the Lissajous figure is an ellips whose shape depends on the phase difference. Measuring phase difference using the X Deflection mode is one of the typical applications for this mode.

DIGITAL DISPLAY**X versus Y**

Similar to the analog mode, the digital mode allows you to display one trace as a function of another.

The source for vertical direction (Y) is selected by the TRACK control. It can be the acquired trace or a saved track in a memory location (e.g., m3).

For horizontal direction (X) you can choose from an active channel signal saved in memory (e.g., m3.1).

- **Press the ANALOG key to select the digital mode.**
- **Press the DISPLAY key.**
- **Press the X vs Y softkey.**
- **Press the 'on off' softkey to turn it on.**
- **Press the X SOURCE softkey to select 'ch1'.**

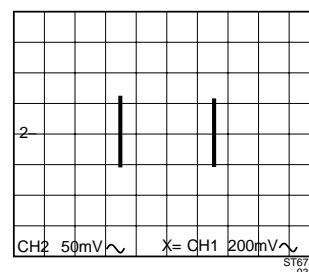

Now two horizontal lines (Ch 1 against Ch 2) are displayed. Horizontal deflection is determined by the amplitude of the sine wave.

The X vs Y submenu displays the selection menu for the X and Y sources. Observe that you can select the Y source (REGISTER) using the TRACK control. Use the softkeys to choose the X source.

- **Remove the signal from channel 2.**

DIGITAL DISPLAY**VERT MAGNIFY**

In the digital mode, the displayed signal can be expanded vertically after it has been captured. This allows you to look to signal details. Please note that the magnified representation of the signal has the same resolution as the originally acquired signal.

- Press the **ANALOG** key to select the digital mode.
- Press **AUTOSET**.
- Remove the probe tip from the **Probe Adjust** output.
- Turn the **TRIGGER POSITION** control to mid screen (counterclockwise).
- Press the **SINGLE** key to prepare the scope for a single acquisition.
- Touch the probe tip to the **Probe Adjust** output.

The scope 'runs' once and a signal appears on the screen.

- Press the **DISPLAY** key.
- Press the **VERT MAGNIFY** softkey to turn it on.
- Turn the **TRACK** control clockwise.

The signal magnifies a maximum of 32 times. The magnification factor is displayed in the **DISPLAY** menu. At the same time the vertical deflection in the bottom text area reflects the expanded deflection factor.

- Use the **TRACK** control to adjust **VERT MAGNIFY** to 8.

Observe that you can observe the signal in more detail. It has the same vertical resolution as when captured. Notice the adc noise being displayed.

Vertical magnify is very useful when you want to observe a signal detail with very high resolution. You can use it in combination with the horizontal **MAGNIFY** function.

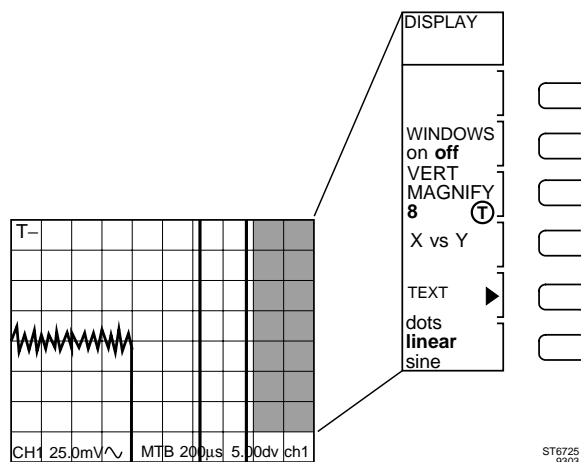

Note: If you want to adjust the displayed position of the magnified trace, you must enter the **Recall** menu, and use the Δ control to make any adjustments to the **Y** position.

DIGITAL DISPLAY**INTERPOLATION**

Interpolation is a mathematical way to calculate displayed dots between actually captured signal samples. Interpolated displays help in the recognition of trace waveforms, even when the number of samples is too low to render an accurate representation of the signal.

Use the bottom key in the DISPLAY menu to control whether or not interpolation is used. You can choose between dots, linear, and sine interpolation.

The default is linear interpolation. Linear interpolation fills the spaces between each sample on the screen with additional dots that are interpolated linearly. This is used to obtain a smoothed display.

- **Use the MAGNIFY keys to set the horizontal magnify to *4.**
- **Turn the X POS control clockwise to display the adc noise only.**

The noise is displayed as continuous trace. This is because the space between the samples is interpolated with additional dots and this filled with a continuous line.

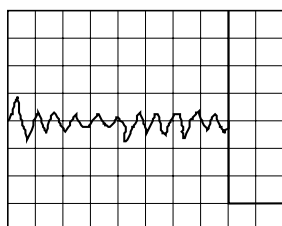

LINEAR

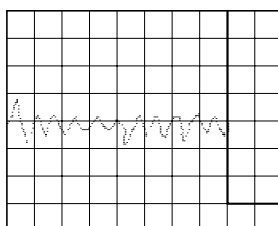

DOTS

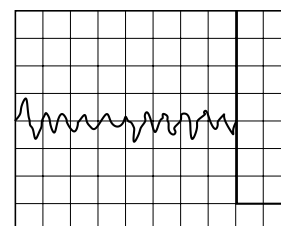

SINE

ST6736

- **Press the bottom softkey to select 'dots'.**

Observe that only the sample dots are displayed and the space between the dots is blanked.

- **Press the bottom softkey to select 'sine'.**

Observe that the trace is smoothed again, but because of a different calculation, it is 'roundedoff' as compared to the linear interpolation.

Sine interpolation is recommended for signals primarily containing sine waves or combinations.

DIGITAL DISPLAY**WINDOWS**

- **Connect the Probe Adjust signal to channels 1 and 2.**
- **Press AUTOSET.**

The screen displays the two Probe Adjust signals in the center of the screen.

- **Press the TEXT OFF key, to turn off the bottom text.**
- **Switch on the channels 3 and 4, when present.**

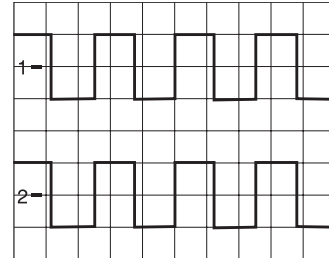

ST7678

The screen displays two or four traces now.

- **Press the DISPLAY key.**
- **Press the key next to 'WINDOWS' to 'on'.**

The screen is automatically divided into two windows of four or four of two divisions each. Each window displays one trace. Observe that the amplitude of the signal has been adjusted to the actual window space.

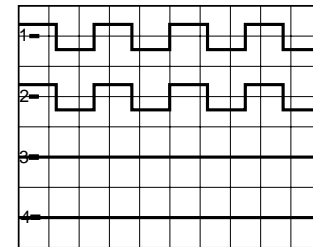

ST6740

- **Turn the Y POS control of channel 2 and observe that you can shift the trace within, but not outside the window.**

Use the window function for logic applications where amplitude accuracy is less important than clear timing comparisons.

- **Switch the WINDOWS off again.**
- **Disconnect the probe from channel 2 before continuing to the next section.**

4.14 DELAYED TIMEBASE

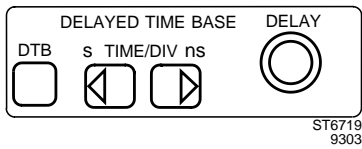

The Delayed Timebase (DEL'DTB) has two basic functions:

- To magnify and display any detail of the signal displayed with the main timebase.
- To permit more accurate timing measurements.

STANDARD SETTING

To start from a predefined state, you must recall the standard front setting.

- Simultaneously press the **STATUS** and **TEXT OFF** keys.
- Connect the **Probe Adjust** signal to channel 1.
- Shift the trace to the upper half of the screen as indicated.

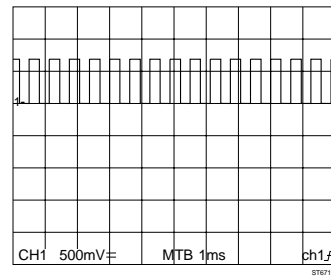

DELAYED TIMEBASE

MainTB and Del'dTB

- Press the **Delayed Timebase DTB** key to enter the **DELAYED TIMEBASE** menu.
- Press the **'DEL'D TB on off'** softkey to turn on the **Delayed Timebase**.

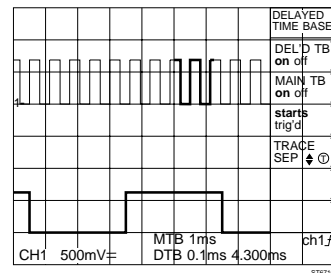

The main timebase trace and delayed timebase trace are displayed simultaneously.

The upper trace is the Main Timebase trace. The Main Timebase trace shows an intensified portion. It may be necessary to adjust the trace intensity with the **TRACE INTENSITY** control to the left of the screen.

The lower trace is the Delayed Timebase trace. This represents the intensified part of the upper trace.

Since all primary functions have dedicated keys and controls on the front panel, the menu can now be turned off.

- Press the **TEXT OFF** button to turn off the menu.

DELAYED TIMEBASE**DELAY**

Use the DELAY control to select the start of intensified part of the signal in the upper trace. The intensified part acts like a window over the Main Timebase trace.

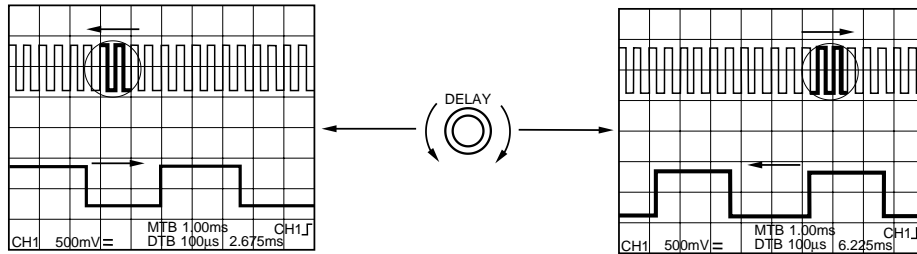

ST6726

DELAYED TIMEBASE**TIMEBASE**

- Press either key of the Del'dTB TIME/DIV keys.

When you press the left key, the intensified part of this signal gets longer. More periods of the signal are displayed on the Delayed Timebase. When you press the right key, the intensified part of this signal gets shorter and fewer periods of the signal are displayed on the Del'dTB. This way you can select any small portion of a signal and capture and display it with a higher resolution.

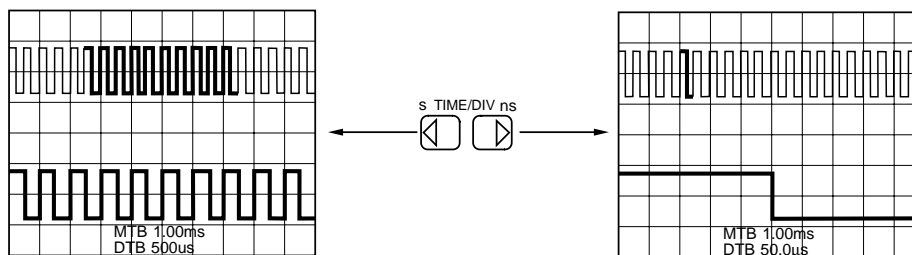
ST6727
9303

DELAYED TIMEBASE**TRACE SEP**

The traces displayed by the Main Timebase and Delayed Timebase can be separated with TRACE SEP.

If the DELAYED TIMEBASE menu is activated, you will see the $\text{\textcircled{T}}$ symbol next to the TRACE SEP text. The $\text{\textcircled{T}}$ indicates that the TRACK control can be used to adjust the trace separation.

- Turn the TRACK control and observe that the DTB trace shifts.

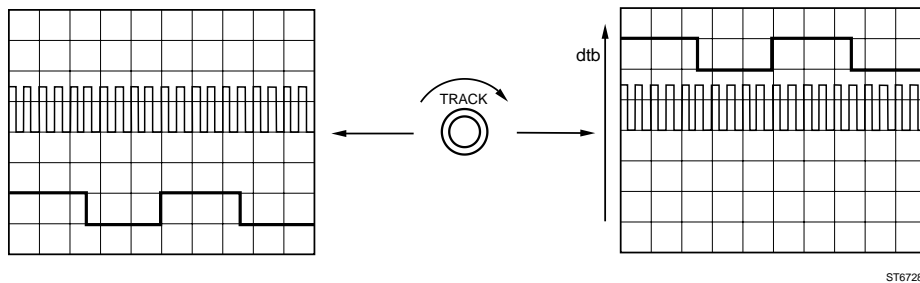

ST6728

DELAYED TIMEBASE**TRIGGER**

Using the Delayed Timebase (Del'd) to select, capture, and display a small portion of the Main Timebase display results in a magnification of the intensified part. Depending on the ratio between the MainTB and Del'dTB settings, this magnification can be very significant.

If the input signal contains jitter or any other form of timing instability, this jitter will be magnified in the same ratio. This can be so much, that the display becomes unusable. To address such a problem, the Delayed Timebase (Del'dTB) can be made to trigger on the input signal after the delay time has passed.

Start with the STANDARD SETUP.

- Connect the Probe Adjust signal to the Channel 1 input.
- Simultaneously press the STATUS and TEXT OFF keys.
- Switch channel 1 to AC coupling (\sim).
- Shift the trace to the upper half of the screen.
- Press the Delayed Timebase (DTB) key to enter the DELAYED TIMEBASE menu.
- Turn on the Delayed Timebase.

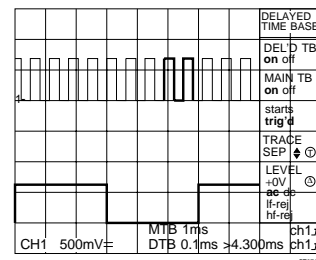

ST6727

The third softkey in the menu is labeled '**starts/trig'd**'. 'Starts' is highlighted as default. This is an indication that the Delayed Timebase starts immediately after the delay time has passed. For most signals, the 'starts' mode can be used.

- **Press the softkey to select the TRIG'D mode.**

When the triggered mode is selected for the Del'dTB, the start of the Del'dTB is postponed until the first trigger occurs after the delay time. A valid trigger depends on the proper setting of the trigger source, slope and level.

The delayed timebase trigger source and slope can be selected with the same TRIG 1, TRIG 2, TRIG 3, TRIG 4 or EXT TRIG buttons as are used for Main Timebase triggering.

When the DELAYED TIMEBASE is active, operation of the Del'dTB triggering is similar to that of the Main Timebase trigger source and slope.

In the lower right hand corner of the screen, the delayed timebase trigger readout is displayed under the readout for the Main Timebase triggering.

- **Press the TRIG 1 key in the CH1 section a few times.**

Observe that the trigger slope for the Delayed Timebase changes.

DELAYED TIMEBASE**TRIGGER LEVEL**

Just as is the case for Main Timebase triggering, proper triggering of the Delayed Timebase depends on the selection of the proper trigger level.

The Δ symbol in the Delayed Timebase trigger menu indicates the Δ control to be used to adjust the trigger level.

If the coupling for the vertical channel and the triggering are the same, a trigger level indicator is visible (D-).

If you have set up for triggered operation of the Del'dTB as described in the previous section, and the Del'dTB trace is not displayed, the trigger level needs adjustment.

Adjust the Δ control until the Del'dTB signal is visible.

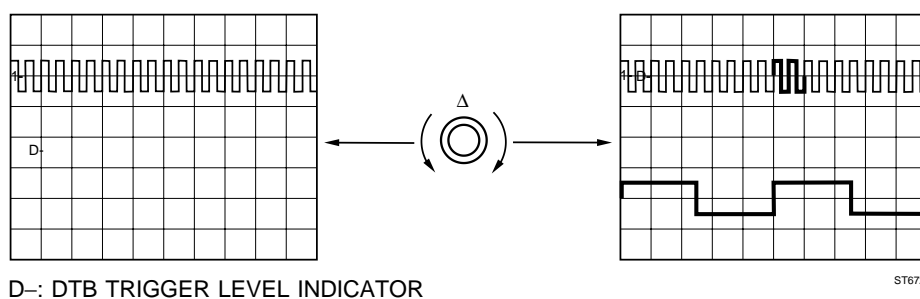
**DELAYED TIMEBASE****COUPLING**

The Del'dTB permits the same trigger coupling selection as for the MainTB (ac, dc, LF-rej, HF-rej). The level indication 'D-' (for Del'dTB) is present only when the combination of the Del'dTB trigger coupling and the input coupling is useful.

4.15 HARD COPY FACILITIES

The oscilloscope offers the capabilities to make a hard copy of the screen information on a printer or a plotter. The hard copy can include the recorded waveform(s), the relevant scope settings, trace identification, cursors, measurement results and screen graticule.

Before you are able to print or plot a hard copy of the information on the CRT it is necessary to make some preparations:

- Oscilloscope and printer/plotter must be connected through a suitable cable.
- The oscilloscope and the printer/plotter must be set up to the correct interface parameters.

All setup actions are done in the UTILITY menu.

SET STANDARD

First set the instrument to the standard setting.

- **Simultaneously press the STATUS and TEXT OFF keys.**
- **Connect the Probe Adjust signal to channel 1.**

The Probe Adjust signal, now supplied to the input, is a square wave with a lower level of 0V and a top level of 600 mV.

- **Press AUTOSET.**

UTILITY

PRINT SETUP

The oscilloscope must first be set to the correct interface parameters. Your instrument is always equipped with an RS 232 interface as standard. The following procedure describes how to set up the oscilloscope to use a printer through the RS 232 interface.

- **Press the ANALOG key to select the digital mode.**
- **Press the UTILITY key.**
- **Press the softkey 'PRINT&PLOT&CLK'.**
- **Select 'print' with the first softkey.**

Using the TRACK control, you can choose from the following models or emulations: **HP 2225, FX 80, LQ 1500, HPLASER and HP540 Deskjet.**

- **Turn TRACK to select the printer you wish to use.**
- **Press the softkey next to 'RS 232/IEEE' to select RS 232.**

The RS 232 settings of the oscilloscope and the printer must match. To set the RS 232 parameters do the following:

- **Press RETURN to go to the UTILITY main menu.**
- **Press the 'RS 232 SETUP' softkey.**

If the IEEE option is present, the RS 232 SETUP softkey is reached via the REMOTE SETUP softkey.

- **Set the RS 232 parameters (baud rate, data bits, parity, connector type, and XON/XOFF).**
- **Press the RETURN softkey.**

If you don't know what to choose, the mostly used "default" parameters are: **9600, 8, N, 3wire, XON/XOFF=ON.**

To set up the layout of the printer hard copy.

- **Press the LAYOUT softkey.**
- **Set the layout parameters (grid, paper length and trace info).**
- **Press the RETURN softkey.**

Now you are ready to make the hard copy.

- **Press the HARD COPY key.**

The printer starts printing.

Observe that the screen displays : 'HARDCOPY BUSY : ..% DONE' to indicate the progress of the printing.

The preceding section describes the setup of a printer using the RS 232 interface. If you wish to use an IEEE-488 equipped printer, all steps are the same, except for the RS 232 setup.

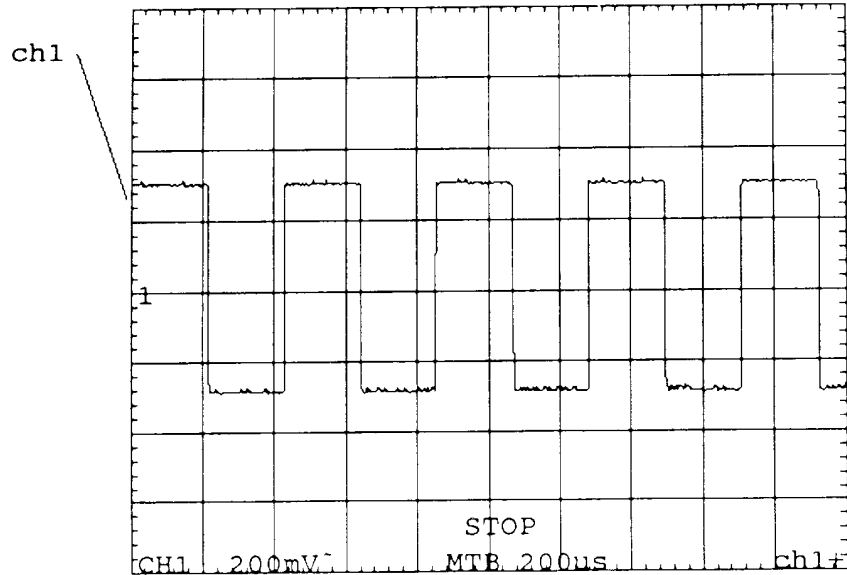

Y/Div:	Timebase:	TRACE
200mV	200us	ch1

ST6836
9303

UTILITY

PLOT SETUP

For a hard copy with a plotter, please refer to the previous section on how to set up the oscilloscope to be used with a printer. Instead of selecting a printer, you can select a plotter from the following models or emulations : **HP7440, HP7550, HP7475A, HP7470A, HPGL (= standard HPGL), PM8277 and PM8278.**

4.16 AUTOSET AND SETUP UTILITIES

This oscilloscope has a number of utilities that assist you to quickly get to the setup you need.

One utility is the SET STANDARD utility to set the oscilloscope to a factory-defined, known state.

The most frequently used utility will be AUTOSET. AUTOSET is user programmable as outlined below.

SET STANDARD

- **Simultaneously press the STATUS and TEXT OFF keys.**

The standard setting feature resets all functions to a predefined state. At this time it must be used to ensure that the standard setup condition applies before proceeding. SET STANDARD also resets the autoset function to the standard autoset condition.

AUTOSET

STANDARD

AUTO SET The AUTOSET function automatically sets all relevant functions of the oscilloscope as they apply to the input signal. This includes the selection of channels, input sensitivity, timebase setting, trigger source, trigger slope, and trigger level for an optimum trace.

- **Connect the Probe Adjust output to channel 1.**
- **Press the AUTOSET key.**

The result is a stable display with a number of signal periods. The amplitude is well within the display range. In this example the Probe Adjust signal is displayed with four periods/cycles on the screen and an amplitude of three divisions. This operating mode is referred to as AUTOSET after the SET STANDARD.

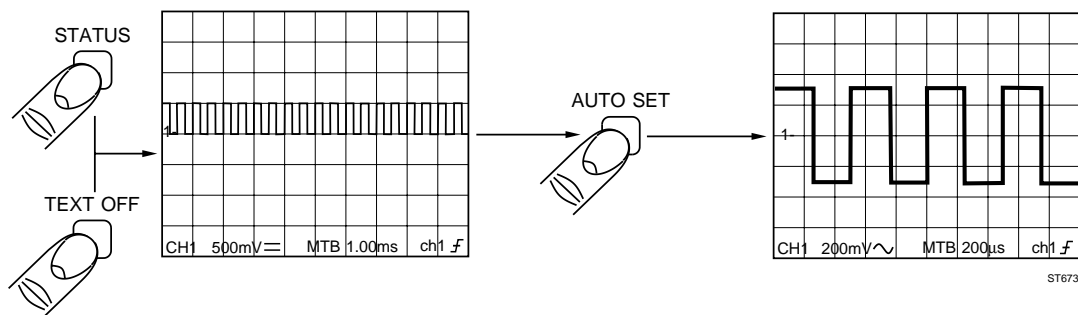

AUTOSET**USER PROGRAMMABLE**

The AUTOSET function can also be programmed so that certain functions switch to a predefined position after an AUTOSET.

USERPROG allows the user to customize the AUTOSET function for specific applications.

Example: To program the AUTOSET function for dc coupling of the inputs, do the following:

- **Press the UTILITY key.**
- **Press the softkey labeled 'AUTOSET'.**
- **Select 'userprog'**
- **Press the 'VERT >' softkey; select 'dc', and press RETURN.**
- **Press the AUTOSET key.**

The Probe Adjust signal is now displayed as dc coupled, instead of ac coupled as would be the case after a STANDARD AUTOSET.

SETUPS

SETUPS



All settings of all controls can be stored in any of 10 memory locations. This is a useful feature when performing routine tasks involving complex setup procedures. Rather than changing all parameters to go from one measurement to another, the oscilloscope can recall even the most complex settings combinations with the touch of one button.

The SETUPS key is used to store and recall previously defined instrument settings.

First clear all memory locations.

- **Press the SETUPS key.**
- **Press the 'CLEAR&PROTECT' softkey.**
- **Press the 'clear all' softkey.**
- **Press the 'yes' confirm softkey.**

Example: Set the attenuator to 500 mV/div, and set the timebase to 500 μ s/div.

- **Position the trace in the bottom of the screen.**

This setup can be saved in memory as follows:

- Turn the TRACK control until memory location 's7' is selected.
- Press the softkey 'save'.

The actual setting of the front is now stored in memory location 's7'. The indication in front of memory location number 's7' changes from an open circle to a closed circle.

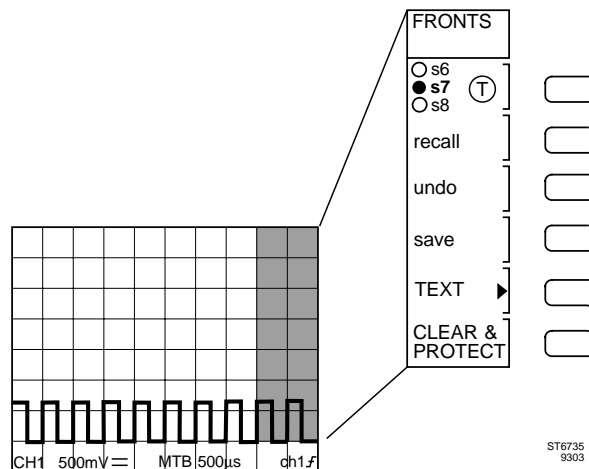

ST6735
9303

To recall a previously stored setting :

- Press the **AUTOSET** key.

The signal is displayed again with an amplitude of three divisions and with four periods.

- Press the **SETUPS** key.
- Use the TRACK control to select the same front number 's7' as in the previous example.
- Press the softkey next to 'recall'.

The stored settings are recalled and the trace is displayed in the same way as when the setup was stored.

A STANDARD FRONT setup can be recalled at any time by pressing the STATUS and TEXT OFF keys simultaneously.

SETUP

TEXT LABEL

In the setup menu each stored setups can be given a label of user defined text. This is done in the submenu TEXT of the SETUP menu. The cursor controls are used for editing text. The TRACK control is used as "cursor", The Δ control is used for selecting the character.

SETUP

RECALL A SEQUENCE

You can create a sequence of setups by storing setups to successive locations (e.g. s1, s2, s3) and clearing the next location (e.g. s4). The AUTOSET key then can be programmed to step through this sequence. This is very useful for semi automated manufacturing. To program the AUTOSET to be used for STEP-TO-NEXT-SETUP-IN-THE-SEQUENCE select the UTILITY >> AUTOSET submenu and select setups.

AUTOCAL

The AUTOCAL function is used for fine adjustment of the oscilloscope's input, trigger, and timebase circuitry. This allows you to achieve the high accuracies specified for this instrument, even under extreme environmental conditions like very high or very low temperatures.

When the oscilloscope is always kept under the same environmental conditions (e.g. in a workshop or lab.), it is sufficient to perform this AUTOCAL once every month.

It is recommended that you perform an AUTOCAL after the instrument has warmed up.

To perform an AUTOCAL :

- **Press the CAL key for at least 2 seconds.**

The calibration is fully automatic and takes about 4 minutes.

For purposes of full traceability, an official calibration in a fully equipped and traceable calibration laboratory should be done once a year or after every 2000 hours of use.

OTHER FEATURES

You are now an experienced user of this Fluke oscilloscope.

The following features were not covered by this step-by-step introduction:

- Trigger and ground level indicators
- TV and HDTV trigger modes and line selection
- Trigger filters
- State pattern and glitch triggering (Glitch only in 2 ch. models)
- Event counter delay
- Record length selection 8k/4k/2k/512 samples
- User text
- Intensity ratio Main/Delayed Timebase
- Probe correction
- Beep and click signals
- Noisy signal triggering
- Confidence check

Most of these functions can be operated via the UTILITY menu.

For further information on all of these features, refer to the cross-reference index and Chapter 5. This chapter describes all oscilloscope functions in alphabetical order.

This oscilloscope has been designed to give you many years of dependable service. We are sure that you will feel confident with your Fluke oscilloscope. Fluke is in the process of constantly improving products and documentation. For any problems or suggestions, please contact the Fluke Service Center nearest you. A complete listing of addresses for the Fluke Service Centers can be found in the Reference Manual.

5 FUNCTION REFERENCE

This chapter contains an alphabetized description of each oscilloscope function. For easy reference, the functions are organized in the following order:

1. The Function description

Explanation and detailed information about the function.

2. Key sequence

Tells the operator which keys/controls to use to select the desired function. The first key/control mentioned is always one of the front panel menu selection keys, and the other keys are the softkeys.

3. Remote commands

Gives information about the command to be programmed for the operation of the relevant function via a remote control interface. For more detailed programming information, see Chapter 6.

Note 1: Finding your way through the menus.

Some functions are attained via successive steps through a tree structure of menus. An example is how to activate the key CLICK function:

- Press the UTILITY menu key.
- Press the SCREEN & SOUND softkey.
- Press the SOUND softkey.
- Press the CLICK softkey to activate 'on'.

The shortform annotation for these steps is 'UTILITY >> SCREEN & SOUND >> SOUND >> CLICK on'.

Note 2: A complete function index is part of this Operating Manual. This function index contains all function names and reference words in alphabetical order including the relevant chapter and page number where more detailed information can be found. It can be found at the end of this manual.

ACQUISITION LENGTH

Description:

The oscilloscope allows the user to select the acquisition length, or record length that best suits the needs of the application. The default acquisition length is 512 data points for each trace. It is possible to increase the length of a trace from 512 points up to a maximum 8K points (or 32K points if the memory expansion option is installed). This results in a trace length of 16 screens, or 160 divisions.

The TB MODE menu offers four choices to select the acquisition length. This menu is accessed via the key sequence 'TB MODE >> ACQ LENGTH >> ..' Selection of the desired acquisition length is then made with the soft keys as indicated. Note that all registers will be cleared when the length is changed. The user must confirm the change of the acquisition length.

The X POS control is used to move the trace in horizontal direction and to display any desired part. A bar graph shows which part of the trace is displayed on the screen. By using the MAGNIFY key pair, you can expand the trace up to 32 times to look at signal details. The MAGNIFY keys can also be used to compress the signal to fit the display width and look at the total waveform. This is realized without the loss of vertical information.

The 8K acquisition memory is shared between all channels. In the '2ch@4K pts' mode the entire memory is used for the two channels, so trigger view of the external trigger channel is not possible.

In the standard mode the trace length is 512 samples and all channels can be acquired simultaneously. In this mode, more traces can be stored in the reference memory, and the screen update rate increases. This mode also supports delayed timebase operation. This way, acquisition can consist of up to eight traces, four Main TB and four Delayed TB traces (for the 2 channel models: six traces, two Main TB traces, two Delayed Time Base traces and two Trigger View (MTB+DTB) traces).

The following table shows the selection possibilities for a standard oscilloscope with 8K acquisition memory.

Acquisition length	Reference memory	Traces *)
8K	2 registers of 1 trace each	3 (3)
4K	2 registers of 2 traces each	6 (6)
2K	2 registers of 4 (3) traces each	12 (9)
512	8 registers of 4 (3) traces each	40 (30)

*) memory plus acquisition; 2 ch. models between brackets

MEMORY EXPANSION

With the Extended Memory Option installed, the acquisition memory can be made as long as 32K. When shorter acquisitions are selected, more traces can be stored in memory with a maximum of 208 (156) traces.

Acquisition	Reference memory	Traces *)
1 x 32K	2 registers of 1 traces each	3 (3)
2 x 16K	2 registers of 2 traces each	6 (6)
3 x 8K	2 registers of 4 (3) traces each	12 (9)
3 x 512	50 registers of 4 (3) traces each	208 (156)

*) memory plus acquisition; 2 ch. models between brackets

Key sequence:

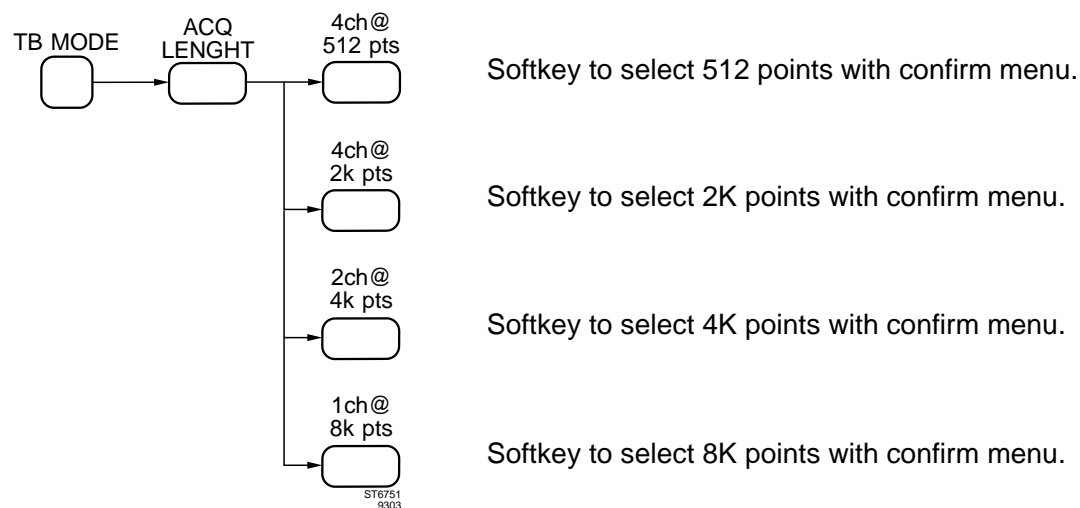

ADD INVERT SUBTRACT

Description:

The CH1 + CH2 (CH3 + CH4) key in the control section for CH1 (CH3) can be used to display additional traces of the sums of these channels. CH3 + CH4 is only present in the 4 channels models.

The invert key (INV) in the control section for CH2 (CH4) can be used for signal inversion.

A differential mode is provided by adding CH1 (CH3) and 'Inv' CH2 (CH4) together.

In analog mode the two channel and the added trace are displayed at the same time. In digital mode however channel and added trace are displayed separately. Switching between both is done with the CH1+CH2 (CH3 + CH4) toggle key. Activating the function will turn off AUTO RANGE AMPL.

Suppression of common mode components in two signals using the differential mode.

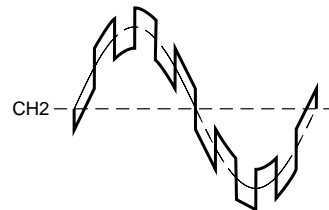
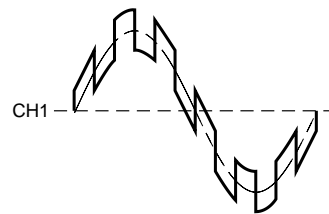

MAT4202

Key sequence:

CH... + CH...

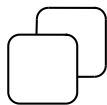

Toggle key to switch the addition of CH1 and CH2 or CH3 and CH4 on/off

INV



Toggle key to switch the inverted display of CH2 (CH4) on/off

ADD (MATHEMATICS)

Description:

The ADD function performs a point-to-point addition of two traces, related to the two ground levels (indicated as '-'). The result of the ADD function is a new trace in a different register. This trace can be scaled and positioned.

Scaling is the correction of the resultant trace to fit in the screen. The TRACK control adjusts scaling.

Vertical positioning is called offset. It offsets each sample in the resultant trace with a value so that the trace can be "moved" vertically. The Δ control adjusts the vertical positioning. The scale factor and the offset factor are displayed in the 'MATH SCALE' menu. Pressing the 'autoscale' softkey automatically selects the settings so the trace fits the screen.

When you add signals with different amplitude settings, the smaller signal is automatically adapted to the larger signal.

Either newly acquired traces or previously stored traces can be used as the sources for this process and each can be selected with the control. The resulting trace is automatically written in a register memory (m1 for math1 or m2 for math2).

To see the result more clearly, you can use the DISPLAY SOURCE on/off softkey to turn off the two source traces.

Mathematical description:

Result = S1 + S2

Key sequence:

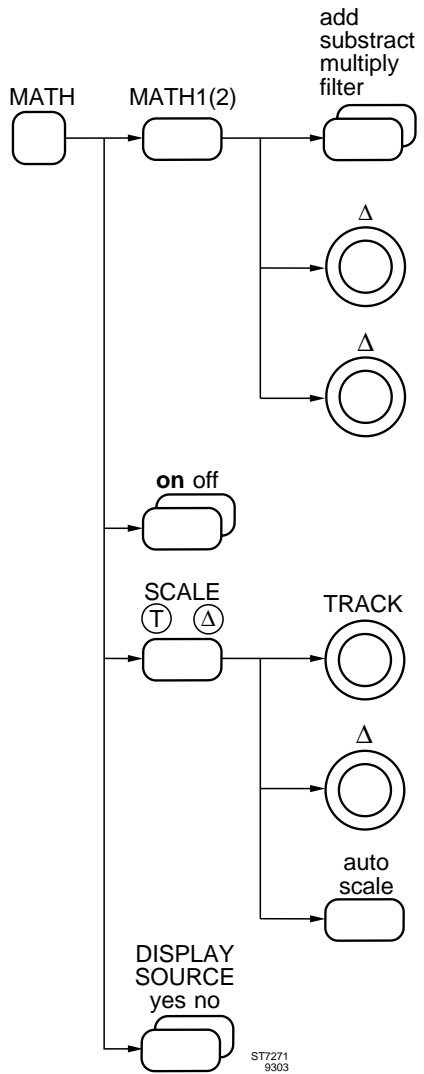

Control to select the ADD process.

Control to select the first source trace.

Control to select the second source trace.

Toggle softkey to switch the ADD function on.

Control to adjust the scale factor.

Control to adjust the offset factor.

Toggle softkey to select the autoscaling.

Toggle softkey to switch the source traces on and off.

Remote commands:

CPL: QW (Command to query a waveform).

Refer to Chapter 6 for full details

ALT/CHOP

Description:

In the analog mode, when two or more channels are selected, the oscilloscope displays multiple channels in a 'time shared' mode. This implies that a fast electronic switch connects each input signal to the output amplifier in turn. This can be done at the end of every sweep, or at a high frequency. The display modes are referred to as Alternate or Chop modes.

Alternate mode: After each sweep of the time base has been completed, the channel switch selects the next channel to be displayed during the next sweep. The result is that each channel is displayed one after the other. At fast timebase speeds this mode assures maximum intensity, while slow timebase speeds in alternate mode result in a flickering display.

Chopped mode: In this mode, the channel selector switch operates at a high frequency, and is not coupled to the time base sweep. This mode is recommended for slow timebase speeds. The display switches very fast (1 MHz) between the channels, which results in what appears to be a simultaneous display of all channels.

ALT/CHOP is not available with single trace display.

In the digital mode channel 1 and channel 2 each have their own digitizer for simultaneous sampling on both channels. In this two-channel mode ALT/CHOP is not active.

If a combination of channel 1 or 2, and channel 3 or 4 is selected, the ALT/CHOP is active and functions in the following way:

ALT results in a complete memory acquisition of channel 1 or 2 simultaneously sampled, followed by a complete memory acquisition of channel 3 or 4, also simultaneously sampled.

CHOP results in a single sample being made on channel 1 or 2 followed by a single sample on channel 3 or 4. This continues until the acquisition memory for each channel is filled. This ALT/CHOP function is valid only for the real-time sampling timebase speeds.

NOTE: For further details on three or four channel operation, also refer to the ACQUISITION LENGTH and PEAK DETECTION functions.

The alternate and chopped modes are shown in the figures below.

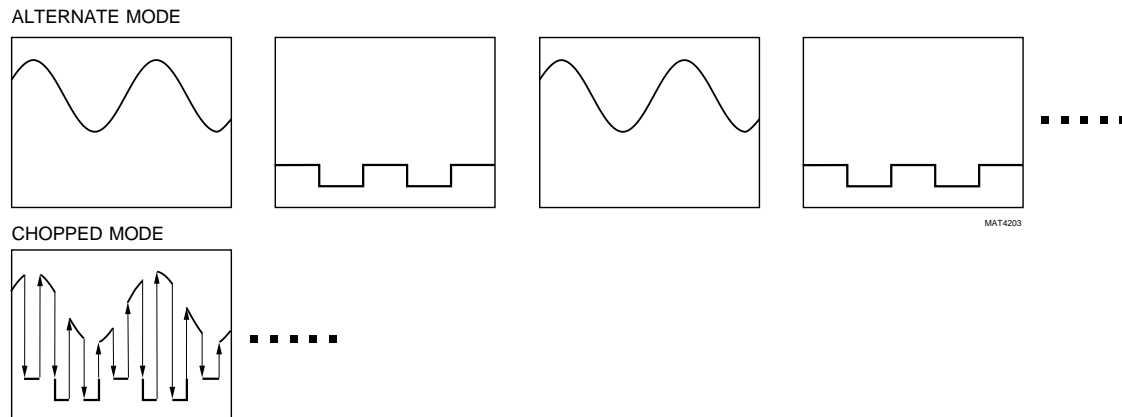

Key sequence:

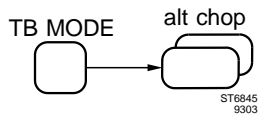

Toggle softkey to select ALternate or CHOPped mode.

ANALOG MODE

Description:

You can use the yellow ANALOG key to switch from the analog mode to the digital mode and back at any time. The signal acquisition and display functions of both operating modes are very similar. Depending on the nature of the signal used or the choice of the measurement, you may prefer the analog mode.

This is especially true for the following types of signals:

- amplitude modulated signals
- frequency modulated signals
- fast sweeps
- long serial data streams
- most video signals
- observing signal changes (e.g., adjustments)

The same waveform is usually displayed in the same manner, whether you select the analog or the digital mode. However, some functions are not implemented in both modes. For instance, the digital mode permits the viewing of pre-trigger information. The digital mode also offers auto-range for main time base and vertical channels. These functions are not available in the analog mode.

If switching from one mode to another results in an unsatisfactory display, press the yellow key a second time to return to the original situation.

Key sequence:

Toggle key to switch between analog mode and digital mode.

AUTO RANGE

Description:

The AUTO RANGE function automatically selects the input sensitivity of the vertical channels and time/div of the main timebase to obtain an optimum display of the input signal(s). AUTO RANGE is a continuous function: vertical channel or time/div settings are adapted if the input signal changes.

The AUTO RANGE function of the vertical channels automatically selects the input sensitivity. The result is that the input signal is displayed with 2 to 6.4 divisions of amplitude. The amplitude is between 1 and 3.2 divisions with DISPLAY WINDOWS on. AUTO RANGE can be turned on separately for each vertical channel. AUTO RANGE functions at input sensitivities between 5V and 50 mV/div. Input coupling is put to ac if AUTO RANGE is switched on: dc or ground coupling can be selected manually. AUTO RANGE is switched off after operation of the AMPL key, the AUTOSSET key, the channel's AUTORANGE key, channel ADD key or changing Acquisition length.

The AUTO RANGE function of the main timebase (MAIN TB) adjusts the timebase automatically so that 2 to 6 waveform periods are displayed. To turn off AUTO RANGE, press the TIME/DIV key, the AUTOSSET key, or the main timebase AUTORANGE key.

In VARiable timebase mode the AUTO RANGE function tries to keep the displayed trace unchanged.

Key sequence:

Toggle key to switch the AUTO RANGE function of main timebase and vertical channels.

AUTOSET

Description:

The AUTOSET function sets the oscilloscope so that an optimum display of the input signals is obtained within the same mode analog or digital. Operating the AUTOSET key results in:

- Channels with an input signal are switched on; others are switched off.
- Input coupling is set to ac; because of this autosest does not function at very low signal frequencies.
- Input impedance is set to 1 M Ω
- Input attenuator settings are optimized; VAR function off.
- Bandwidth limiter and INVert are switched off.
- ALT or CHOP mode selected to most optimal display.
- Vertical POS selection in center screen.
- Edge triggering on positive slope is activated.
- Trigger source is the channel with the lowest frequency; at equal frequency the lower channel number is selected. Trigger source is EXT TRIG input when a signal is present, and Trigger View becomes active.
- Trigger coupling is set to ac and level-pp on.
- Horizontal mode is switched to MAIN TB only.
- Cursors and usertext are switched off; settings display is switched on.

These settings are suitable for most signal conditions. You can also customize AUTOSET to your own application or preference. For information about AUTOSET programming, refer to AUTOSET USERPROG.

Key sequence:

AUTOSET



Key to start the autosest

Remote commands:

CPL: AS (Command for Auto Setup)

Refer to Chapter 6 for full details.

AUTOSET SEQUENCE

Description:

If front panel settings are stored in memory locations 's1 to s5' and 's6' is cleared, then the range of 's1 to s5' becomes a sequence of front panel settings. Such a sequence can be used as (part of) a step-by-step testing procedure. The two following methods can be used to quickly step through such a sequence. This saves time by not without having to recall each setting from a menu:

- Programming the AUTOSET key to be used as the 'recall next setup' key. This selection is done in the UTILITY >> AUTOSET menu.
- Using a special probe with a COMMAND switch. Two probes with COMMAND switch are delivered with each oscilloscope as standard accessory. The appropriate mode for this probe command can be selected in the UTILITY >> PROBE menu.

To return to the 'normal' oscilloscope mode, press the STATUS and TEXT OFF key simultaneously to recall the STANDARD SETUP.

AUTOSET USERPROG

Description:

A number of instrument settings after AUTOSET can be customized to your special needs when the standard default settings do not fit on your application.

The selections are reached via the key sequence 'UTILITY >> AUTOSET >> userprog'. This gives access to VERT, TRIG and PROBE submenus where the selections are made. The following table shows possible selections. Unaffected means that existing selections are not overruled by AUTOSET.

Description	Standard AUTOSET	Userprog alternatives	Menu UTILITY>>AUTOSET >>userprog>>.
Channel selection	volt/div, on/off	unaffected	VERT
Input coupling	ac	dc, unaffected	VERT
Input Impedance	1 M Ω	50 Ω , unaffected ¹⁾	VERT
Bandwidth limiter	off	on, unaffected	VERT
Triggering	edge, ac, level-pp on, auto, LEVEL MTB center	unaffected	TRIG
Probe	manual probe selection set to 1:1	unaffected manual probe selections	PROBE

¹⁾ 200 MHz models only

Key sequence:

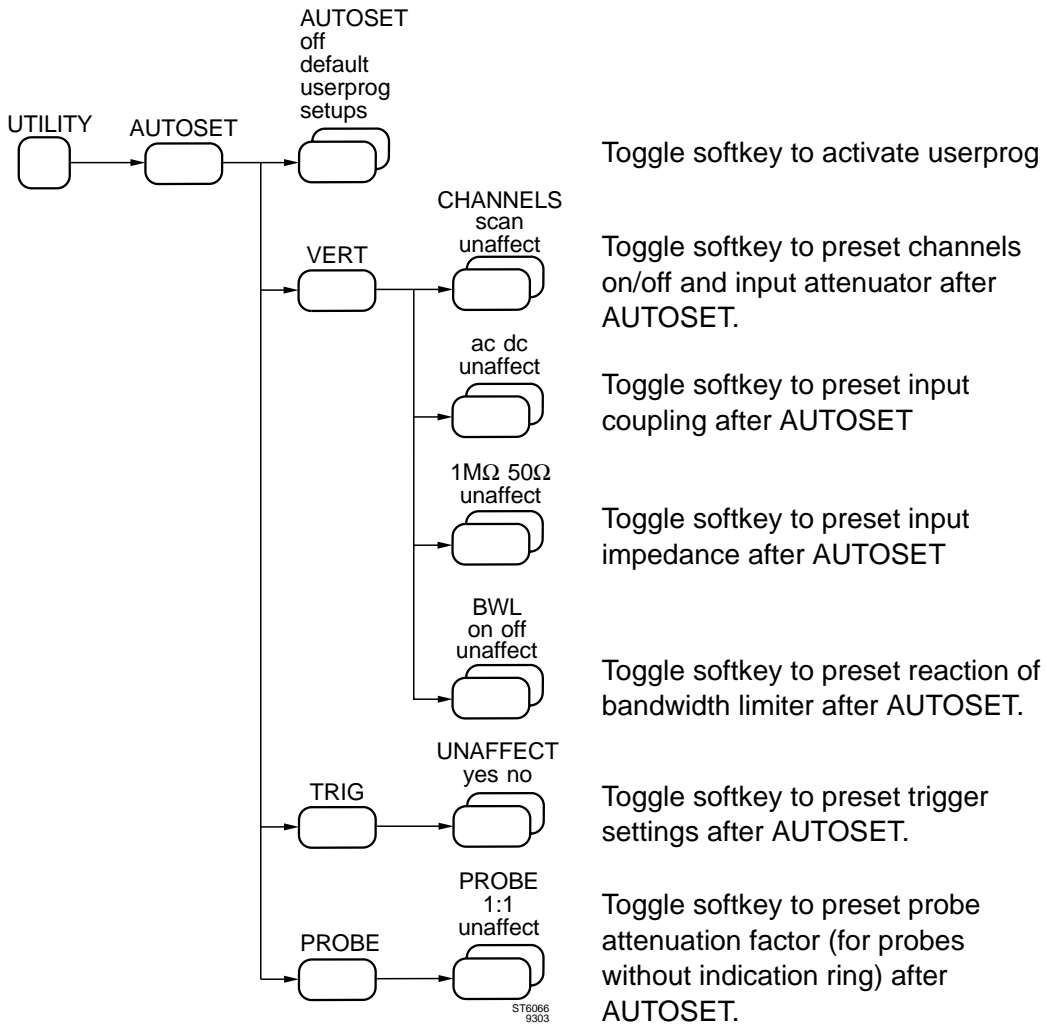

Remote commands:

CPL: AS (Command for an Auto Setup)

Refer to Chapter 6 for full details.

AVERAGE

Description:

Valid in digital mode only.

Averaging is a process to reduce random noise without losing bandwidth. Averaging can only be used for repetitive signals.

Every sample point is calculated after every subsequent acquisition as follows:

$$\text{new} = \text{previous} + \frac{\text{measured} - \text{previous}}{C}$$

In this formula "previous" is the result of the average function after the previous acquisition, on the same sample position as the measured one. "C" is the average-factor. Noise is reduced by a factor which is equal to the square root of "C".

Average values for "C" can be selected from 2 to 4096 in a binary sequence. To do so, use the TRACK control in the ACQUIRE menu.

Averaging also results in a higher vertical resolution resulting in higher measurement accuracy.

Averaging can be quickly switched on and off with the direct access key (AVERAGE) on the front panel, or via the ACQUIRE menu. Once activated, average is a continuous process until it is switched off. However, whenever the display is changed (e.g. POS, AMPL/DIV) the average process will restart.

AVERAGE is mutually exclusive with ENVELOPE. If the ENVELOPE mode is selected, AVERAGE is automatically switched off.

Key sequence:

AVERAGE



Key to switch the AVERAGE function on or off.

ACQUIRE



TRACK



Control to select the AVERAGE factor.

ST8655
9303

BANDWIDTH LIMITER

Description:

The bandwidth limiter cuts the bandwidth of all vertical channels to 20 MHz and makes noisy input signals look smoother. The bandwidth limiter does not affect triggering. The following figure shows the effect of the bandwidth limiter.

Effect of bandwidth limiter

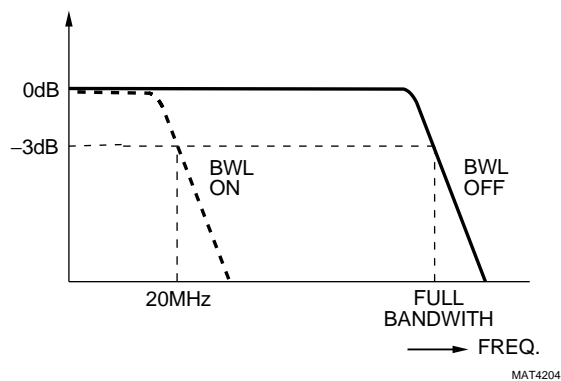

Key sequence:

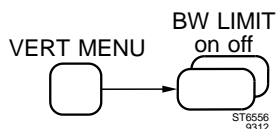

Toggle softkey to switch the vertical bandwidth limiter on/off

CALIBRATION AUTOCAL

Description:

The CAL key is used to make a fine adjustment of the oscilloscope's input, trigger, and timebase circuitry to achieve high accuracy even under extreme environmental conditions such as very high or very low temperatures. In a workshop or laboratory environment, a fine adjustment once a week or even every month is sufficient.

It is recommended that you do the fine adjustment after the instrument has warmed up. For a complete calibration (advised once a year or every 2000 service hours), a special submenu is available in the maintenance menu. Calibration data are protected by a keyword and a seal. Calibration should be done by qualified personnel only. For details, refer to the chapter 'Calibration Adjustment Procedure' in the service manual.

Attention: Calibration autocal data disappears after having removed back up batteries while the oscilloscope is not powered by line.

Key sequence:



Key to start the fine adjustment procedure. Press this key for at least 2 seconds to start the procedure.

Remote commands:

CPL: CL (Command for Calibrate)

Refer to Chapter 6 for full details

CHANNEL/TRACE SELECTION

Description:

In this family of instruments, the distinction is made between 'channel' and 'trace'. A channel is referred to as an input channel, complete with AMPL and POS settings. A trace represents a waveform which has been stored in one of the register memories. Once such a waveform is recalled from memory, it is displayed on the screen as a trace.

Each channel can be turned ON and OFF by the ON key located near the channel keys on the front panel. In the digital mode, this key switches the acquisition and the display on/off.

In the **digital** mode, a waveform which has been previously stored in a register, can be recalled and displayed via the RECALL menu. One of the registers (M0) is the acquisition register, where the newly acquired data from the input channels is stored.

The RECALL function only switches on and off the display of the trace and does not influence the acquisition. It allows the running acquisition to be hidden to give a better view of the processed results calculated from an acquisition running in the 'background'.

In addition to the acquisition register (M0), the scope provides eight different register memory locations (50 for the extended memory version). Each memory location can hold a maximum of one of the following:

4 (3) waveforms of 512 samples.

4 (3) waveforms of 2K samples.

2 (2) waveforms of 4K samples.

1 (1) waveform of 8K samples.

The number of stored waveforms depends on the selected acquisition length and the number of channels that were active at the moment of the acquisition.

To switch single traces on and off instead of a total register, the bottom key in the RECALL menu can be used to select TRACE instead of REGISTER. The RECALL menu is then trace oriented instead of register oriented.

Example : m1 changes in m1.1 and m1.2, representing the labels for the ch1 trace in m1 and the ch2 trace in m1, respectively. Label m1.e is for the External Trigger input signal in m1.

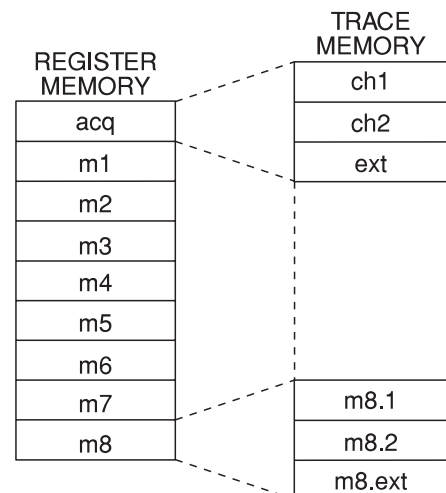

ST7700

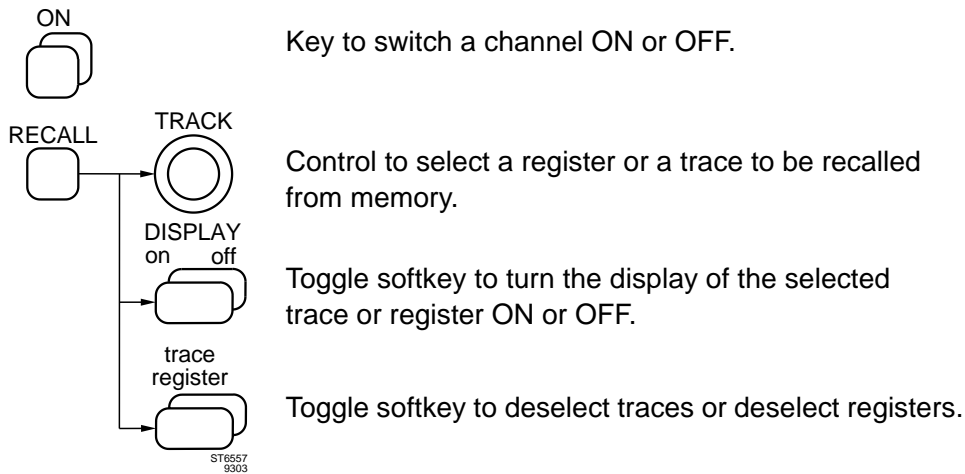
Key sequence:

CONFIDENCE CHECK

Description:

After turning the oscilloscope on, a confidence check starts automatically. The following is tested in sequence:

- The instrument's internal control bus.
- The communication between front panel and internal microprocessor.
- The settings in the memory (with backup batteries installed only).
- Interface to digitizer circuitry.

The selftest takes less than a second. A message appears on the screen when errors are found.

The settings stored in memory become active with backup batteries installed. These are the same settings present when the instrument was last switched off. With no batteries present, the standard default setting 'std' is activated. Refer to STANDARD SETUPS for details.

Key sequence:

POWER ON OFF

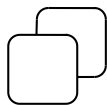

Toggle key to switch the oscilloscope on/off. Starts confidence check

CURSORS

Description:

Cursors are on-screen measuring lines. They can be moved using the TRACK and Δ controls. Cursors can be positioned on signal details of interest and can be used for accurate measurements.

Basically there are two types of cursors: vertical lines (||) called time cursors and horizontal lines (=) called volt cursors. A simultaneous display of both cursor types (#) is possible.

If the acquisition length in digital mode is more than 10 horizontal screen divisions, it is possible to position the cursors horizontally along the complete acquisition. When a cursor that is visible on the screen is moved outside the screen, it will drag the trace with it. This means that the X POSition is changed. A bar graph shows the display window and cursor positions in relation to the total acquisition length. The cursors are trace oriented rather than display oriented. The acquisition length can be selected via the TB MODE menu.

The readout of the delta between the cursor lines is shown in the cursor display area (upper part of the CRT viewing area). In analog mode the display can be in voltage or time, and is in digital mode in voltage and time at the same time. In this way cursors can be used for accurate on-screen measurements without using the graticule. Additional readout information can be selected under the READOUT softkey. For details see the CURSOR READOUT function.

The cursors are activated via the menus under the CURSORS menu key. The structure of the menu is shown in Appendix B.

Activating the cursors is made with the 'CURSORS on/off' menu selection.

CURSORS

TIME

The time cursors are used for time measurements. The example shows the required softkey settings for period measurements. The cursor positioning with the TRACK and Δ controls is also shown.

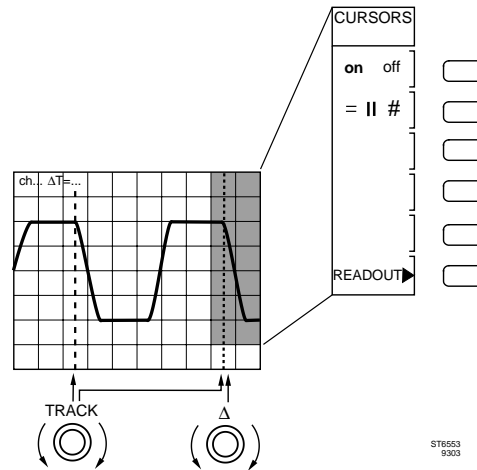
ST6553
9303

CURSORS

VOLT

The volt cursors are used for voltage measurements. When more than one channel is on, the desired channel for voltage readout must be selected with the ch1, ch2 pair of softkeys. When more than one channel is on, the desired channel for voltage readout must be selected with the ch1, ch2 pair of softkeys. In digital mode stored traces can

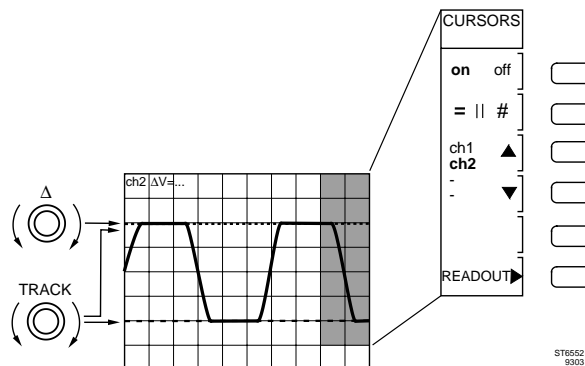
ST6552
9303

also be used for voltage measurements. The figure shows the required settings. The cursor positioning with the TRACK and Δ controls is also shown. The example shows how peak-peak voltage measurement is done.

CURSORS

BOTH

In this mode, both voltage and time cursors are active. The TRACK and Δ controls operate as in VOLT or TIME mode, as selected with the CONTROL key.

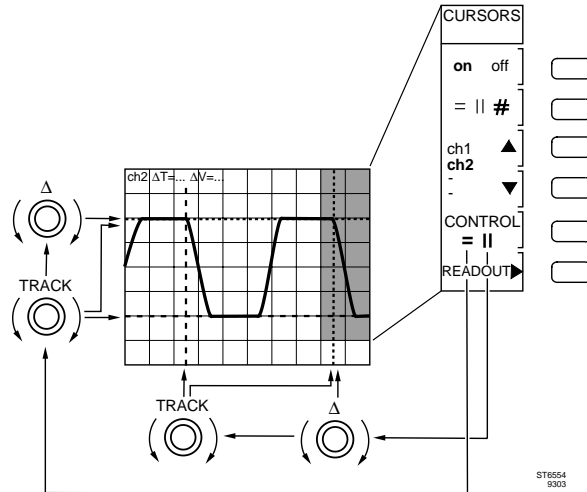

Key sequence:

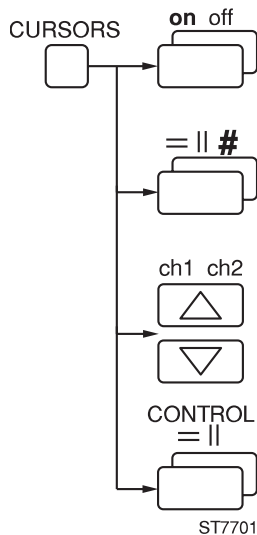

Toggle function softkey to switch between cursors on and off.

Toggle function softkey to switch between volt, time or both cursors.

Softkey pair to select CH1 or CH2 for measurements. Selects in digital mode also stored traces.

Toggle function softkey to switch between volt and time cursors for positioning. This selection is usable only in the 'both' cursor mode.

TRACK



Control to shift both cursors simultaneously, or to shift the track cursor only. Selection in the CURSORS READOUT menu determines one of the two.



Control to shift the Δ cursor.

Remote commands:

CPL: QM (command to query measured values)

Refer to Chapter 6 for full details.

CURSORS READOUT

Description:

The cursors offer a wide variety of voltage and time readouts. For comparison of signal details the ratio mode is very suitable. When in analog mode time or volt cursors have been selected, only the relevant readouts are displayed in the READOUT menu. In digital mode all readouts are displayed at the same time.

The various readout selections for time, volt and 'both' are reached via the key sequence 'CURSORS >> READOUT'.

CURSORS READOUT

TIME

Three time interval readouts can be selected:

- ΔT : Gives the time between the cursors.
- $1/\Delta T$: This results in a frequency readout. The readout is correct when the distance between the cursors equals one signal period.
- ΔT -ratio: The readout is a percentage that can be reset by using the ' $\Delta T=100\%$ ' softkey. This mode can be used for time comparisons. The figure shows an example of a duty cycle measurement. First the cursors are positioned at the period and the readout is set to 100%. Then the pulse width is measured.
- Phase (ph): The readout is a number of degrees that can be reset using the ' $\Delta T=360^\circ$ ' softkey.
- T-trg (time to trigger): The readout gives the time between the trigger point and each time cursors.

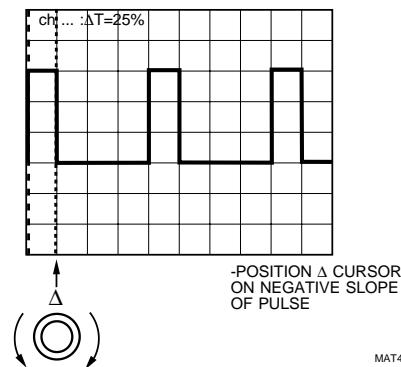
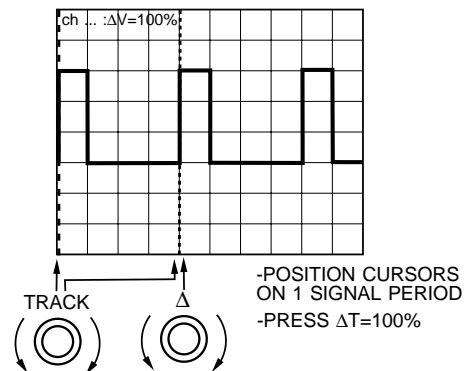

MAT4210

CURSORS READOUT

VOLT

Three readouts can be selected:

- ΔV : Gives the voltage difference between the cursors.
- V1 V2: Gives the absolute voltage with respect to ground for each cursor. V1 and V2 have to be selected separately.
- ΔV -ratio: The readout is a percentage that can be reset using the ' $\Delta=100\%$ ' softkey. This can be used for amplitude comparisons. The figure shows an example: the percentage of overshoot compared with 100% pulse amplitude is determined.

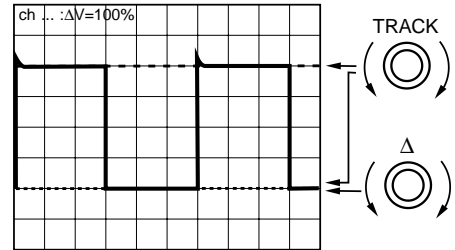

-POSITION CURSORS ON TOP/BOTTOM OF SIGNAL
-PRESS $\Delta V=100\%$

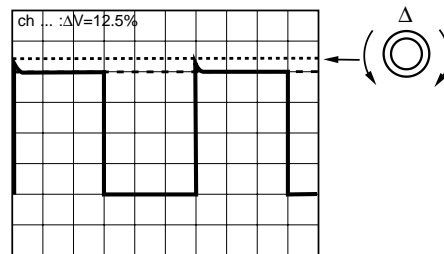

-POSITION Δ CURSOR ON TOP OF OVERSHOOT

MAT4211

Key sequence:

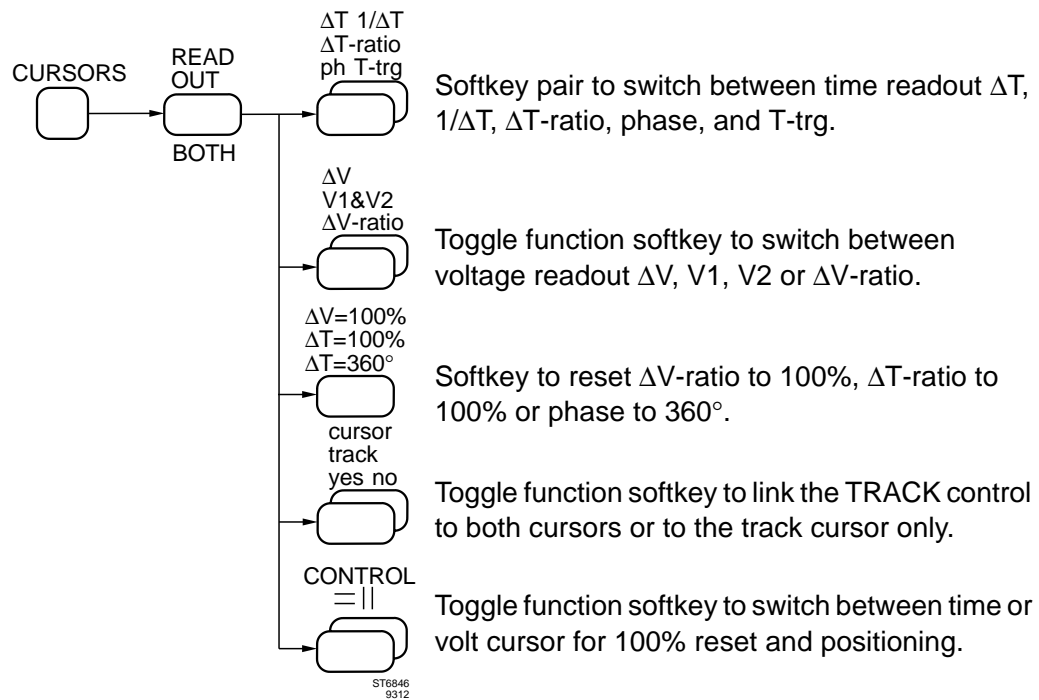

Remote commands:

CPL: QM (command to query measured values)

Refer to Chapter 6 for full details.

DELAY

Description:

Delay is the term that is used to define the time difference between the trigger point of an acquisition and the starting point of the resulting trace. In an analog oscilloscope, the trigger point is at the beginning of a trace, and the delay is said to be zero. The use of a Delayed Timebase introduces a delay between the trigger point of the Main Timebase and the start of the trace which is displayed with the Delayed Timebase.

Three types of Delay.

This family of oscilloscopes has three types of adjustable delay :

1. Delay controlled by the DELAY control on the front panel. This is the amount of time delay between the start of the Main Timebase and the Delayed Timebase. This delay applies to the Analog mode, as well as to the Digital mode.
2. A delay between the trigger point and a signal acquisition. This delay is used to 'position' the acquired input signal with respect to the trigger point. This type of delay can be 'positive', as well as 'negative'. The result is the acquisition of posttrigger or pretrigger waveform data, respectively. This delay is available in the digital mode only and is controlled with the TRIGGER POSITION control.
3. Delay caused by counting EVENTS. Available in the digital mode only. The use of EVENTS delay causes the acquisition to start after a user selectable number of events has been counted.

Delay

A full description is given under Delayed Timebase.

Trigger position

Pretrigger is used to observe a portion of the signal that occurs before the trigger point. This trigger point is then indicated in the screen by a marker (s). The maximum pretrigger is the acquisition length. In this case, the trigger point marker is positioned on the right side of the screen and the entire record contains pretrigger information. The pretrigger view is indicated (in divisions) in the bottom of the screen.

Posttrigger is used for time delay and is expressed in seconds or fractions thereof. The maximum delay depends on the setting of the main timebase. Maximum trigger delay is 100 divisions; the resolution is 1/50 of the timebase TIME/DIV setting.

Event delay

Event delay postpones triggering until a specific number of trigger events have occurred. The trigger event is defined in the EVENT DELAY sub menu of the TB MODE. Its definition consists of a signal source and a trigger level (event level).

Every time the signal crosses this level the event counter is incremented by one. When the event counter reaches the selected delay value, the scope triggers and a new signal acquisition is started. The number of events to be counted before the acquisition starts is selected by using the Δ control in the EVENT DELAY sub menu.

Event delay and trigger position can be used in combination to offer powerful delay capabilities.

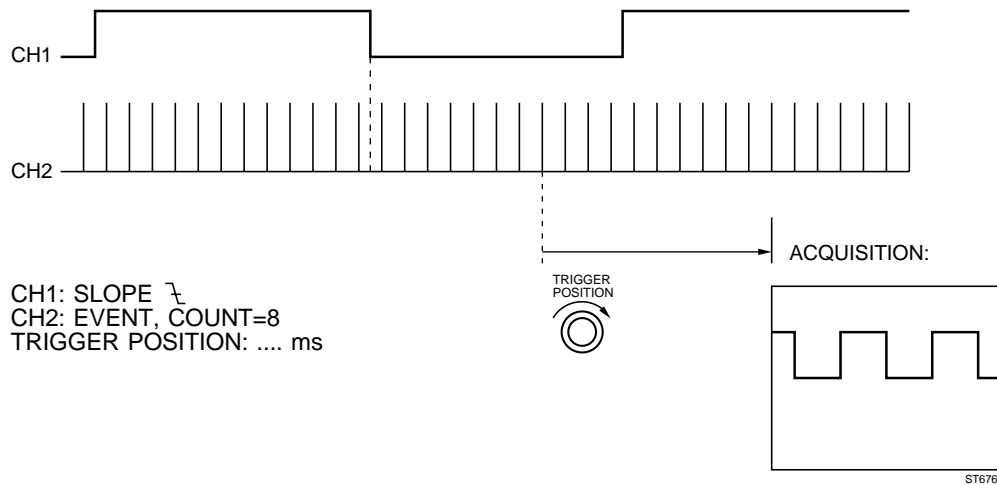

Key sequence:

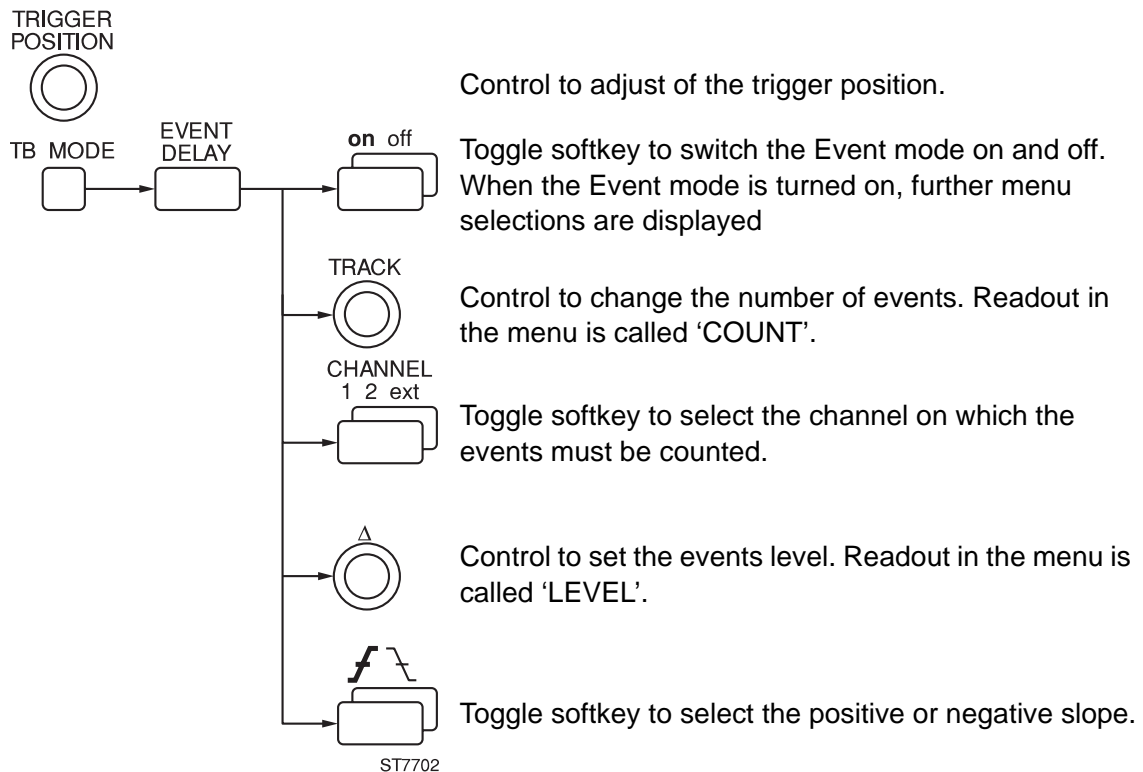

DELAY MEASUREMENT

Description:

In the **digital** mode, the MEASURE menu provides a 'delay' measurement. This is an automatic measurement of the time between two 50% levels ("mesials") of the first leading or trailing edge of two signals. The menu is reached with the key sequence 'MEASURE >> MEAS1(2) >> delay'. The lower part of the menu is then automatically changed to the delay measurement.

Newly acquired signals or signals stored in memory can be used as sources for this measurement. The Δ and TRACK controls are used to select the two sources. Sources have to be traces in the same register memory to avoid any possible error of making delay measurements between traces that were not part of the same acquisition.

For each source there is a softkey to select the slope of the edge (leading edge or trailing edge).

The delay is displayed in the top left corner of the screen ('del = ... μ s').

Delay = (leading/trailing edge S1 - leading/trailing edge S2)

where: S1 and S2 are source signals S1 and S2

Refer to section MEASURE MENU for details of signal parameters.

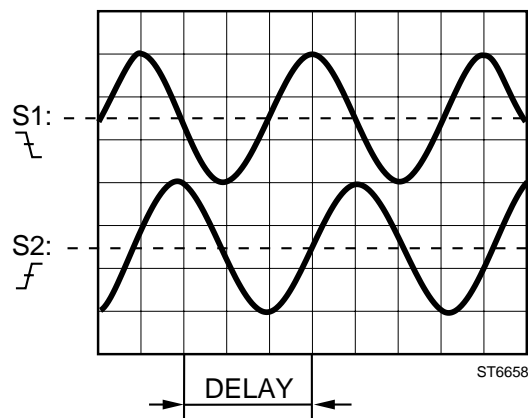

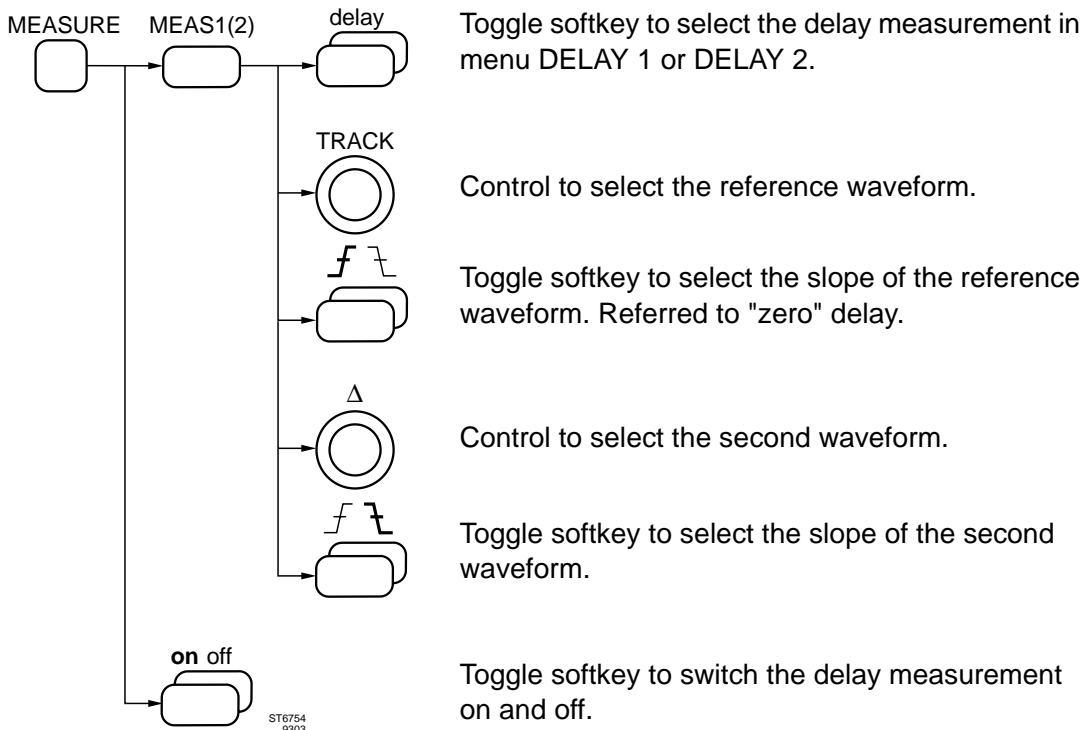
Key sequence:**Remote commands:**

CPL: QM (Command to query a measurement)

Refer to Chapter 6 for full details.

DELAYED TIMEBASE (DEL'D TB)

Description:

The Delayed Timebase (DEL'D TB) is used to examine a signal detail of interest. The detail to be examined is indicated as an intensified part of the MAIN TB trace and is displayed on the full screen width using the DEL'D TB time scale.

The DELAY control adjusts the delay between the start of the MAIN TB and DEL'D TB sweep. Refer to the TRIGGER DEL'D TB function for more details.

The DEL'D TB time scale is adjusted in steps with the delayed timebase TIME/DIV key pair.

In the DELAYED TIMEBASE menu, which is selected with the DTB key, the delayed timebase can be switched on. This is done with the first softkey called 'DEL'D TB on/off'. Once activated, the delayed timebase trace is displayed. The main timebase trace can be switched off using the 'MAIN TB on/off' softkey. If both main and delayed time bases are displayed, you can separate them by using the TRACE SEP function.

Function of 'mtb+dtb', DELAY and TRACE SEP.

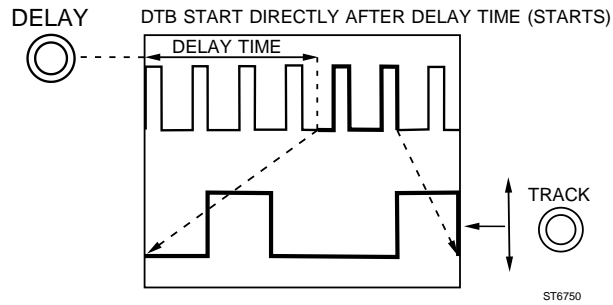

Key sequence:

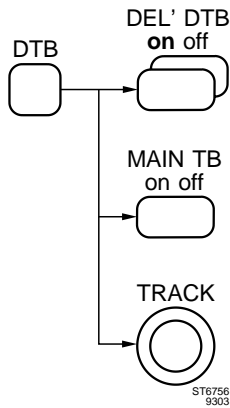

Toggle softkey to switch the delayed timebase on or off.

Toggle softkey to switch the main timebase on or off.

Control to adjust the vertical distance (TRACE SEP) between MAIN TB and DEL'D TB traces.

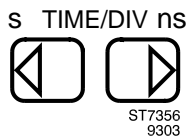

Key pair to adjust the DEL'D TB time scale.



Control to adjust delay time between start of MAIN TB and DEL'D TB sweeps.

DIGITAL MODE

Description:

The yellow ANALOG key is used to switch from the analog mode to the digital mode and back at any time. The signal acquisition and display functions of both operating modes are very similar. However, the nature of the signal used or the choice of the measurement may determine when it is best to use the digital mode.

Digital storage is used for the following:

- recording of single events, or very low frequencies
- pretrigger and posttrigger view
- glitch triggering
- saving, recalling and comparing multiple traces
- automatic measurements
- signal mathematics
- signal analysis
- making hard copies (plot/print)
- digital mode offers the convenience of the auto range function for the vertical channels and the main time base.

The same waveform is usually displayed in the same manner, regardless of the operating mode selected. However, some functions are not implemented in both modes. In the analog mode, for instance, no 'pretrigger' information can be made visible.

If switching from one mode to another results in an unsatisfactory display, press the yellow key once more to return to the previous situation.

Key sequence:



Toggle switch to switch between analog mode and digital mode.

DISPLAY MENU

Description:

The DISPLAY menu offers a set of powerful display functions for the analog mode and the digital mode.

In the **analog** mode, the scope can be set to the X DEFLECTION mode. In this mode XY displays can be generated from a combination of any of the input channels for X and Y, while the analog timebase generator is turned off.

In the **digital** mode, the display menu is extended with additional display functions such as: WINDOWS, VERTICAL MAGNIFY, X vs Y, TEXT GENERATOR and INTERPOLATION.

For the **X DEFLECTION** function for the analog mode, refer to X DEFLECTION further on in this chapter.

WINDOWS automatically separates the traces on the screen when more than one trace is displayed. Each trace is then displayed in a window.

When two channels are displayed, one is displayed in the upper half of the screen, and the other is displayed in the bottom half. When three traces from different channels are displayed, the screen is divided into four windows of two divisions each.

Even when only two divisions are allocated to a trace, for each trace is displayed with the full dynamic range of 8 bits and the full 256 ADC levels are still used. The displayed amplitude of the signal and its screen readout, has however, been adapted to the new window space. Also the range of the POS controls is limited to the new window. The windows mode is especially useful in multichannel applications. It eliminates trace positioning and scaling, while retaining maximum resolution, accuracy and trigger sensitivity.

VERT MAGNIFY is used to vertically expand signals without changing the AMPL/DIV setting of the input channels. It can be used to study signal details in high resolution acquisitions such as an averaged waveform. The signals can be expanded up to 32 times, and the magnification factor is displayed in the DISPLAY menu. At the same time the vertical deflection (volts/div) in the bottom text area is adjusted.

X versus Y is an XY display capability in the digital mode. It is similar to X deflection in the analog operating mode. The TRACK control is used to select the source for vertical direction (Y). The source can be any newly acquired trace but it can also be a saved trace in a memory location (e.g., m3). For horizontal direction (X) you can choose from any active channel or a signal saved in memory (e.g., m3.1) as well.

Horizontal source selection is made with softkeys. X and Y sources must always be traces from the same register memory.

This is done to avoid errors because the traces have to be sampled simultaneously to give a useful and correct X vs Y display.

The **TEXT** submenu allows you to display 'user text' as additional information in the viewing area. This can be very useful when making photographs or hard copies on printers or plotters. For a detailed description, refer to the USER TEXT function. The submenu is also used for on/off switching of the trigger level indicators for MAIN TB-, DEL'D, TB- and EVENT- triggering, and the ground level indicators for each channel.

INTERPOLATION determines if and how the spaces between sample points are displayed. The choices can be dots (samples only - interpolation tuned off), linear or sine interpolation activated. Linear interpolation is the default. The following description applies:

- dots: The space between the sample points is blanked. Only the real samples are shown.
- linear: The space between the sample points is interpolated linearly. Straight lines are drawn between sample points.
- sine: The space between the sample points is interpolated using a sine wave interpolation algorithm. This mode is used to obtain a more accurate display of mainly sinusoidal signals which were undersampled.

Key sequence:

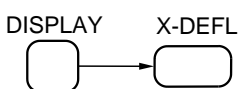

Softkey to select the X-DEFLECTION mode, refer to the X- DEFLECTION function (in analog mode only).

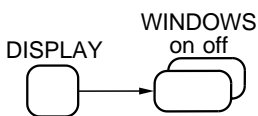

Separates the displayed signals and sets them in a window (in digital mode only).

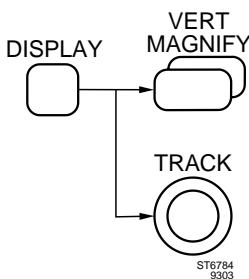

Softkey to turn on the vertical magnification (in digital mode only).

Control to determine the magnification factor.

ST6784
9303

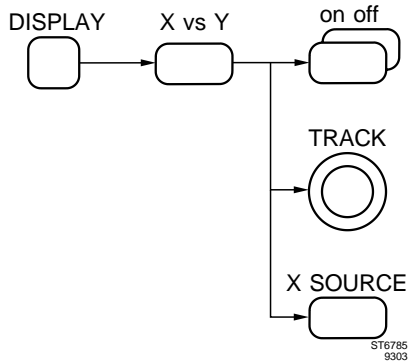

Softkey to select the X vs Y mode, see function X-DEFLECTION (in digital mode only).

Control to select the Y source.

Softkey to select the X source.

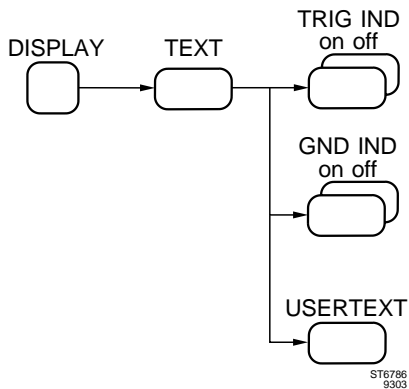

Toggle softkey to display trigger level indication.

Toggle softkey to display or blank ground level indicators.

Access to editing menu for USERTEXT (refer to the USER TEXT function).

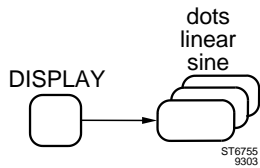

Softkey to select sine-, linear-, or no interpolation (in digital mode only).

ENVELOPE

Description:

If a waveform is changing over time (because of drift, jitter, or intermittent faults), the 'history' of the changing waveform can be collected using the envelope mode. In the envelope mode the minimum and maximum signal values are stored, taking the values of a large number of successive waveform acquisitions. If an interpolation mode is switched on, the area between the maximum and minimum values is shaded.

Each time the settings of the scope are changed (like trace POS), the envelope process is restarted by clearing the acquisition register. A new envelope process starts and continues until stopped or until a change of settings is made.

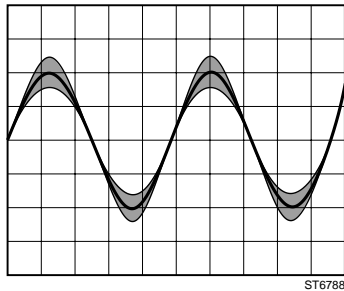

Display of signal with amplitude variation (AM).

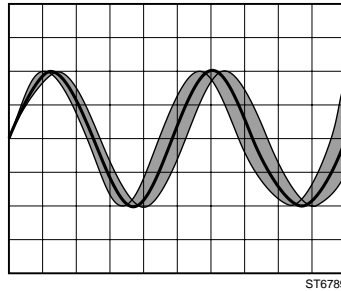

Display of signal with frequency variation (FM or jitter).

ENVELOPE and AVERAGE functions are mutually exclusive. When the AVERAGE function is selected, the ENVELOPE mode is automatically switched off.

Key sequence:

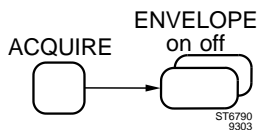

Toggle softkey to switch Envelope on or off.

EXTERNAL TRIGGER (2 CHANNELS MODELS ONLY)

Description:

The External Trigger input provides an extra input that can be used as the trigger source for the Main Time Base (MTB).

The External Trigger input characteristics are similar to those of the input channels 1 and 2. The input has probe range indication detection and two attenuator positions (0.1 V/div. and 1 V/div.). If External is selected as trigger source the same trigger modes (Edge, TV and Glitch) are available as for the trigger sources CH1 and CH2.

When the External Trigger input is selected as trigger source, the signal on this input can be made visible by pressing the function key TRIG VIEW. When another Trigger source is selected, Trigger View is automatically switched off.

Trigger View can be used in Single- and Multiple shot in timebases up to 10 μ s/div. In the other timebase modes Trigger View automatically selects Alternating mode for timebases faster than 10 μ s/div. This result in the simultaneous acquisition of the External Trigger input.

Key sequence:

EXT TRIG

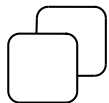

Key to select the external trigger input as trigger source. Selects trigger slope when External trigger is selected.

TRIG VIEW

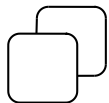

Key to turn on and off the display of the external trigger signal.

AMPL

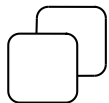

Toggle key to switch between the attenuator settings 1 V/div and 0.1 V/div.

FILTER

Description:

The FILTER function is a waveform MATH function. It is a post- acquisition algorithm which can be used to simulate the effect of a low-pass filter process on a trace. The cut-off frequency of the low-pass filter can be adjusted and the result trace is stored as a new trace in a separate register. This implies that the original waveform or trace is never disturbed by the process, allowing you to "experiment" with different filter factors.

A typical use of this digital low pass filter is to suppress noise even after a signal acquisition. Since the FILTER function is a post acquisition process, it can also be used on single event waveforms.

Any newly acquired trace or previously stored trace can be used as the source for the filter process.

The result trace is automatically written in memory location m1 for MATH1 and m2 for MATH2 and instantly displayed on the screen.

For each sample point of the trace, a $(1 - \cos X)$ weighted sum is calculated over a window of N samples (convolution). N is adjusted with the Δ control. The window value is displayed in the 'MATH FILTER PARAM' menu. The resulting cut-off frequency is the result of the sample rate set by the time base and N. The -3 dB point is displayed in the bottom area of the screen.

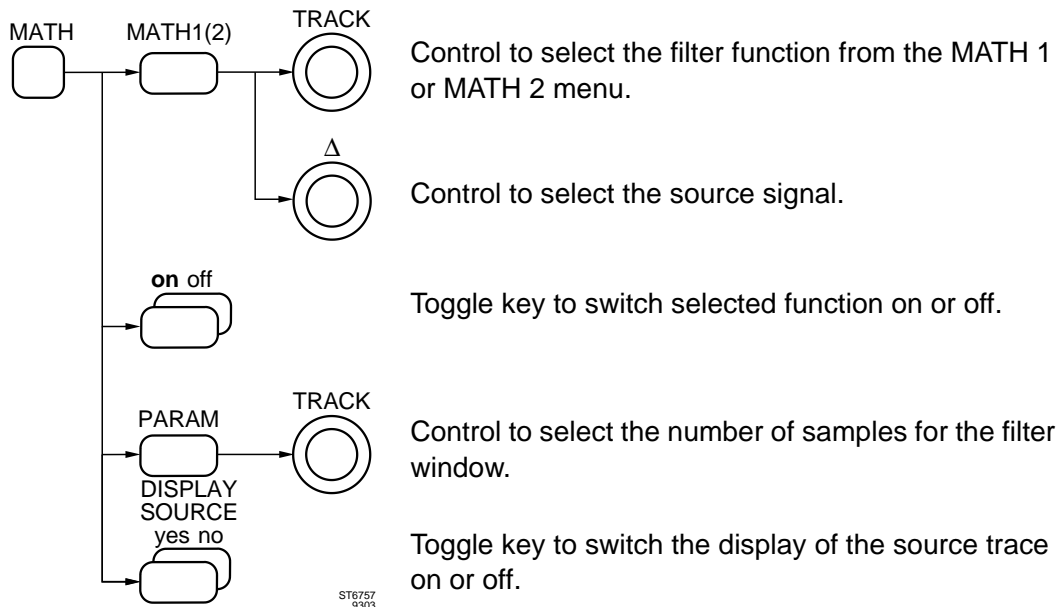
Key sequence:

Control to select the filter function from the MATH 1 or MATH 2 menu.

Control to select the source signal.

Toggle key to switch selected function on or off.

Control to select the number of samples for the filter window.

Toggle key to switch the display of the source trace on or off.

Remote commands:

CPL: QW (Command to query a waveform)

Refer to Chapter 6 for full details.

GLITCH TRIGGER

Glitch triggering examines a single channel, on one or more time conditions.

Any one of the channel inputs can be used as trigger source and is selected with the keys 'TRIG1, TRIG2' or EXT TRIG. The same keys are used to toggle between positive and negative glitch triggering.

Time qualification is selected with softkeys. These time conditions are:

- n>t1** triggers when the glitch is longer than the selected time t1. The TRACK control is used to adjust t1.
- n<t2** triggers when the glitch is shorter than the time t2. The TRACK control is used to adjust t2.
- range** triggers when the glitch duration is between two time limits as specified by t1 and t2. The TRACK control is used to adjust t1 and the control is used to adjust t2.

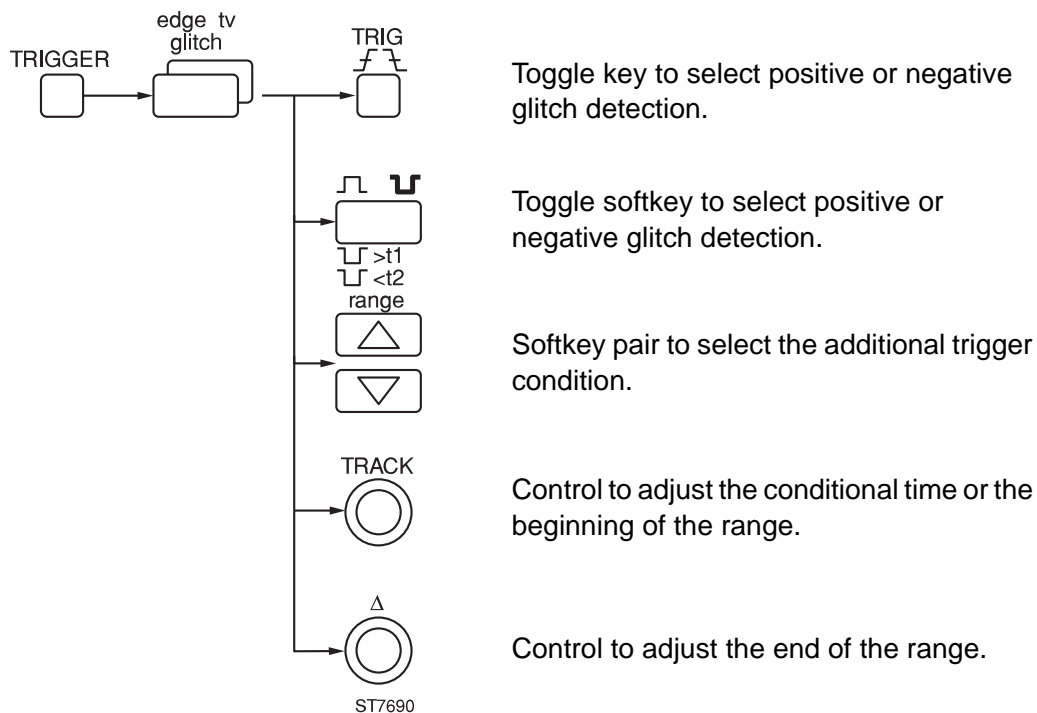
Key sequence:

HOLD OFF

Description:

The HOLD OFF control determines the hold off time.

In the **analog** mode, the hold off time is an additional 'dead' time after each timebase sweep during which the MAIN TB trigger is inhibited. Variable HOLD OFF enables the user to synchronize the display rate to the signal being examined. This eliminates the problem of 'double' triggering on pulse train information as shown in the figure.

For most signals the hold off must be minimal (0%), so that the sweep repetition rate can be the highest permitted by the trigger signal. Turning the HOLD OFF control clockwise increases the hold off time. When the hold off time is set longer than is necessary to synchronize the signal, loss of light output will result.

In the **digital** mode, the variable hold off time serves a similar function, and the extra time is used for processing previously captured data.

In digital mode, triggering on certain pulses can be achieved via the logic trigger mode 'pattern'. For details refer to the LOGIC TRIGGER function.

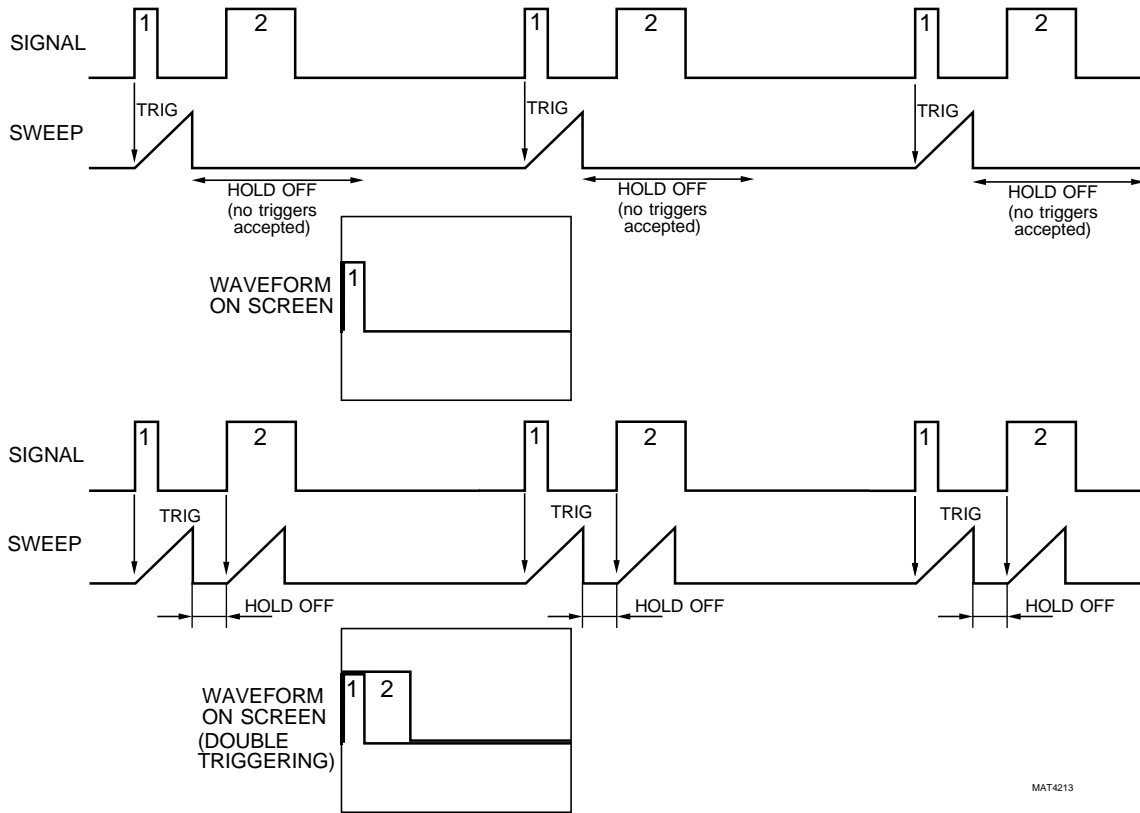

MAT4213

Using HOLD OFF to suppress double triggering.

Key sequence:

HOLD OFF



Control to adjust MAIN TB hold off time.

INPUT ATTENUATOR**MANUAL + AUTOMATIC****Description:**

The oscilloscope's input has a wide range of sensitivities. This enables signals of different amplitudes to be displayed on the available screen area. Sensitivity adjustment is done with key pair AMPL/VAR or a single AMPL toggle key (for the External Trigger input).

Input sensitivity increases when the top key (mV) is pressed; it decreases when the lower key (V) is pressed. The sensitivity adjustment can be done in steps or continuously; switching between these modes is done by pressing both keys simultaneously. The CRT readout resolution correspondingly changes. The amplitude of a signal can be determined as described under the 'SCREEN CONTROLS AND GRATICULE' function. The AUTO RANGE key activates a continuous automatic adjustment of input sensitivity. The result is a signal amplitude on the screen between 2 and 6.4 divisions. This functions in digital mode for input sensitivities up to 50 mV/div. For more information, refer to the AUTO RANGE function.

For the External Trigger input, the input sensitivity can be adjusted to the two most commonly used settings (1 V/div and 100 mV/div). Selection is done with a single toggle key AMPL.

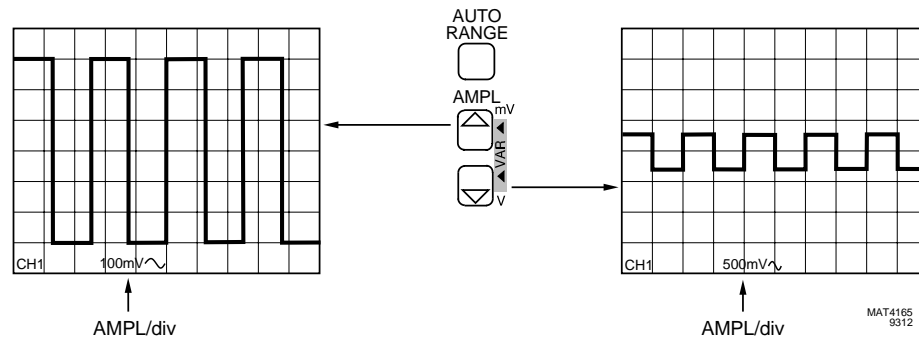

Function of key pair AMPL/VAR

Key sequence:

Key pair to adjust the vertical input sensitivity in coarse or fine steps.

AUTO
RANGE



Toggle key to switch the AUTO RANGE function on/off

AMPL

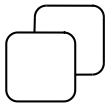

Toggle key to switch between two vertical input sensitivities of the External Trigger input channel.

INPUT COUPLING

Description:

The characteristics of the oscilloscope's inputs can be selected for each channel. A channel can be switched on/off with the toggle key ON. Display of the External Trigger input signal is switched on/off with the toggle key TRIG VIEW. CH1 is always switched on when all other channels are switched off.

In the dc coupled mode the complete signal including dc components and extremely low frequencies (<10 Hz) are displayed. In the ac coupled mode, dc components are suppressed. This results in a display of the ac components (≥ 10 Hz).

Ground coupling (GND) interrupts the input signal. The position of the trace is at the 0 volt level. A continuous ground level indication for each channel can also be activated. Refer to the description of the UTILITY>>SCREEN&SOUND MENU function.

The selections are made with the toggle keys AC/DC/GND for the channel inputs, or AC/DC for the External Trigger input.

The type of coupling is given in the readout area using the symbols \sim (ac), = (dc) and \perp (GND).

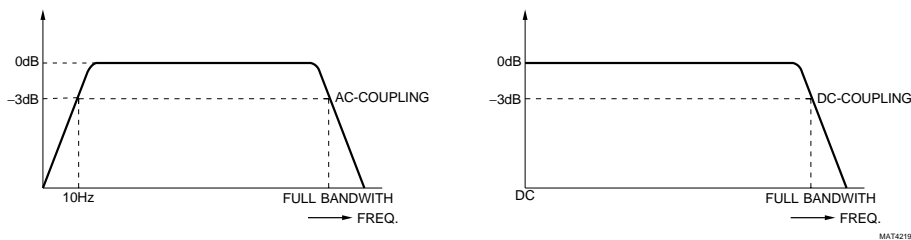

Effect of ac/dc input coupling

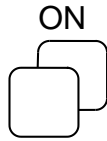
Key sequence:

Toggle key to switch a channel on/off.

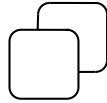
TRIG VIEW

Toggle key to switch the display of the External Trigger signal on/off.

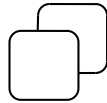
AC/DC/GND

Toggle key for vertical input coupling of the input channels.

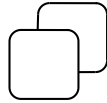
AC/DC

Toggle key for vertical input coupling of the External Trigger input.

INPUT IMPEDANCE (200 MHZ MODELS ONLY)

Description:

For high-frequency measurements the input impedance can be switched from 1 M Ω to 50 Ω . Input impedance is automatically adapted to the type of probe. Manual switching is done with the toggle key 50 Ω in the VERT MENU menu. The 50 Ω input is not available for the EXT TRIG.

The input is protected in the 1 M Ω as well as the 50 Ω setting:

- 1 M Ω : protected for signals up to 400V.
- 50 Ω : protected for peak voltages up to 50V or up to 5V rms.

For details, refer to the Reference Manual.

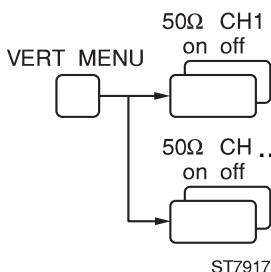
Key sequence:

Toggle key to switch 50 Ω input impedance of CH1.

Toggle key to switch 50 Ω input impedance of CH..

ST7917

LOGIC TRIGGER (4 CHANNELS MODELS ONLY)

Description:

Logic triggering enables triggering on a combination of the four input signals. Each input is compared with a trigger level and is recognized as being either HIGHER or LOWER than the trigger level. The four input signals together can be regarded to be a 4-bit digital 'word'. If this 'word' matches a certain pattern triggering occurs. The 4-bit trigger pattern can be edited with the TRIG buttons in each of the channel sections and is displayed in the lower right hand corner of the screen with each input being identified as H=High, L=Low, or X=Don't care. (Example: HHxL).

There are three logic trigger modes: pattern, state, and glitch.

To enter the logic trigger mode select 'logic' from the TRIGGER MAIN TB menu. The menu now displays the choices, and you use a softkey to select one of the three logic trigger modes: pattern, state, or glitch.

- State

State triggering, sometimes called conditional triggering, is used in applications with clocked or synchronous systems. One of the four input signals must be selected as the 'clock' signal. Triggering occurs on this clock edge, when the other 3-inputs match the selected three bit pattern (i.e., are TRUE). The clock edge may be chosen as a rising or falling clock edge. In this menu you use a softkey pair to select the trigger slope in combination with the keys TRIG1 through TRIG4 that give the state (HIGH, LOW, or don't care) for the three other trigger sources.

Example of a STATE trigger word: HLL, in which ch1 is used as positive clock edge.

- Pattern

The PATTERN mode is used to trigger the oscilloscope when a combination of up to four signals is true for a specified amount of time. In other words, triggering occurs only when two conditions are met; the combination and the time limits. The trigger pattern is set as a combination of HIGH, LOW, or don't care, of the four input channels of the oscilloscope.

Example of a PATTERN: HHxL.

The PATTERN condition is set or edited with the TRIG buttons in each of the vertical channel sections.

When the PATTERN condition is true for a specified amount of time, the oscilloscope triggers.

The time condition can be set in the softkey menu.

- enter triggers when the pattern becomes true.
- exit triggers when the pattern changes from true to false.
- if>t1 triggers when the pattern is true and its duration exceeds a specified time. The TRACK control is used to adjust time limit t1.
- if<t2 triggers when the pattern condition exists for a time which is shorter than t2. Triggering actually occurs when the pattern changes from true to false in a time shorter than t2. The TRACK control is used to adjust t2.
- range triggers when pattern remains true for a time longer than t1 and shorter than t2. Triggering actually occurs when the pattern changes from true to false within the specified time limits. The TRACK control is used to adjust t1, and the control is used to adjust t2.

Glitch

Refer to GLITCH TRIGGER function.

Key sequence:

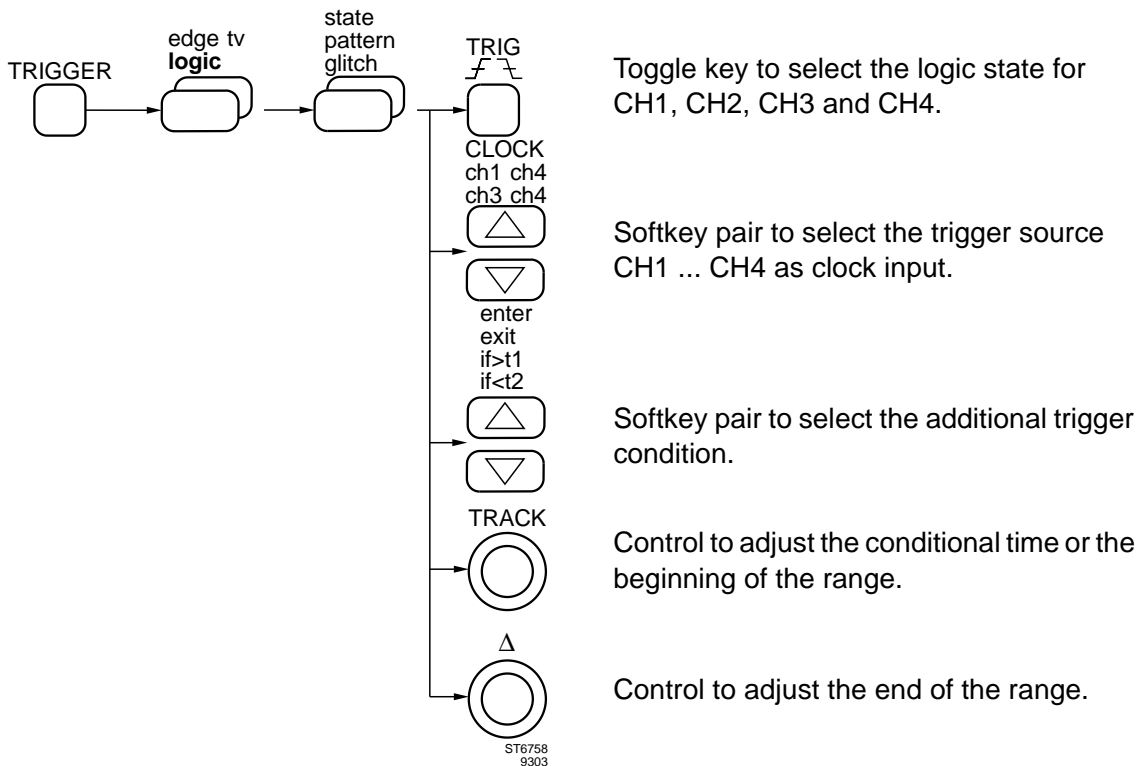

Toggle key to select the logic state for CH1, CH2, CH3 and CH4.

Softkey pair to select the trigger source CH1 ... CH4 as clock input.

Softkey pair to select the additional trigger condition.

Control to adjust the conditional time or the beginning of the range.

Control to adjust the end of the range.

MAGNIFY HORIZONTAL

Description:

In the **analog** mode, the MAGNIFY key pair switches between the normal trace and horizontal expansion of the trace by a factor of 10. The maximum timebase speed is then increased from 20 ns/div to 2 ns/div.

In the **digital** mode, the same MAGNIFY key pair gives horizontal expansion of x1, x2, x4 up to 32 times for detailed viewing of captured signals. This results in an expansion of the timebase range from 2 ns/div to 62.5 ps/div. The MAGNIFY keys also allow horizontal compression of up to 32 times so that full records of 8K (32K optional) can be displayed on a single screen without loss of information. The current magnification factor is temporarily displayed on the screen when you are making a change. When the magnify function is active, the magnification factor is permanently displayed on the screen.

In both analog and digital modes, the X POS control positions the trace with respect to the screen to display the part of interest. When you adjust X POS, a bargraph is temporarily displayed to show which part of the trace is currently being displayed.

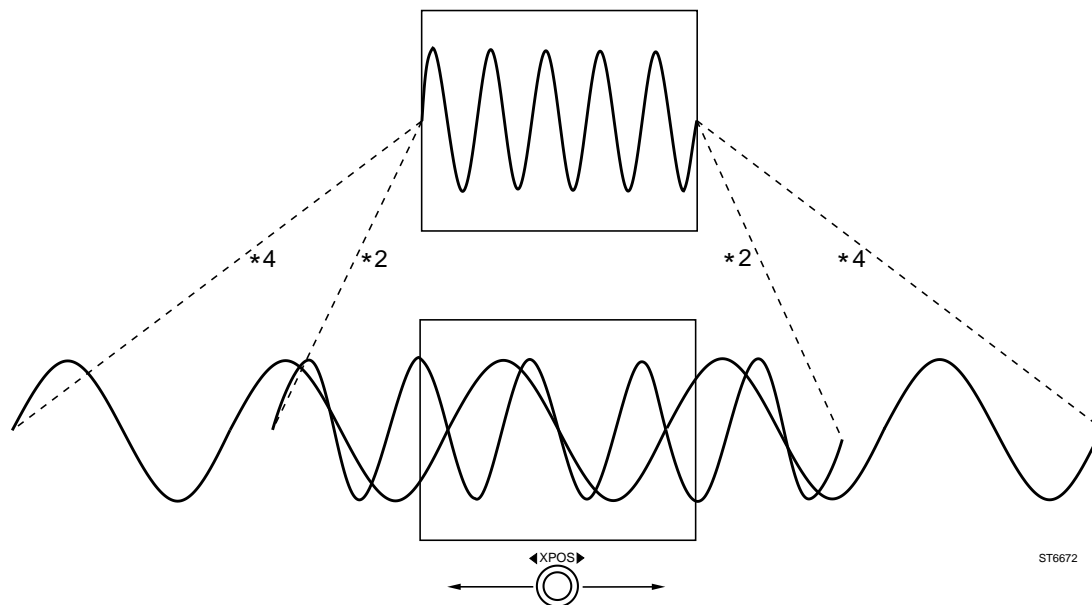

Function of the timebase magnifier and X POS control

Key sequence:

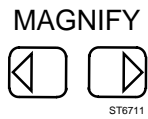

Key pair to adjust the horizontal magnification.
 Analog mode: Right side switches x10 MAGNIFY on.
 Left side switched x10 MAGNIFY off.
 Digital mode: Right side increases the MAGNIFY factor.
 Left side decreases the MAGNIFY factor.

MAGNIFY VERTICAL

Description:

In the digital mode the displayed signal(s) can be expanded vertically up to 32 times for detailed signal examination. Vertical magnification is activated in the DISPLAY menu.

The TRACK control is then used to select the magnification factor in a x1, x2, x4 ... x32 sequence. The selected factor is displayed in the DISPLAY menu. The actual vertical deflection coefficient in V/div is automatically updated and displayed in the text area at the bottom of the screen.

You can use the POS control of the displayed channel(s) to move the trace and display the part of interest.

If you selected a trace stored in one of the memory locations m1 ... mn, using the RECALL menu, to be displayed and magnified, you can change the position of such magnified traces using the Y POS control as indicated in the RECALL menu.

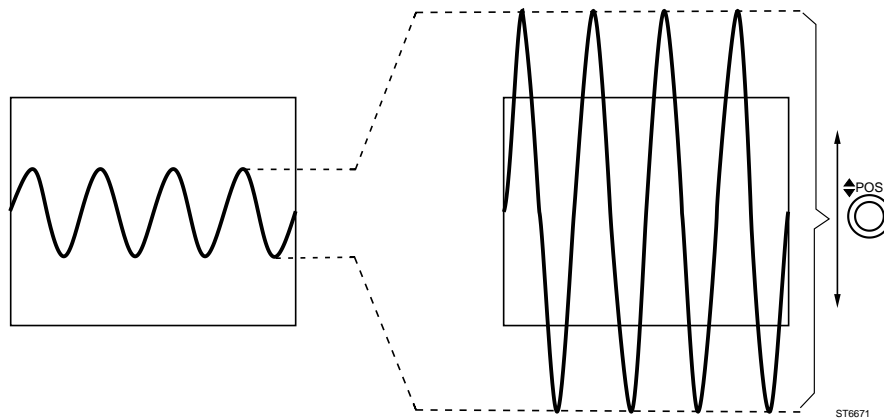

Function of vertical magnifier and Y POS control

Key sequence:

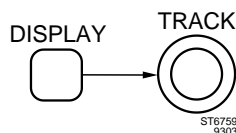

Control to select the vertical magnification.

MAIN TIMEBASE**MANUAL + AUTOMATIC****Description:**

The Main Timebase (MAIN TB) has a wide range of time/div settings. This enables the display of signals of various frequencies to be displayed with optimum resolution. The time scale is adjusted with the key pair TIME/DIV (VAR). Adjustment can be done in steps or in a continuous range (VAR). Switching between these modes is done by pressing both keys simultaneously. For low frequency signals, the MAIN TB speed must be slow; this is obtained by pressing the 's' side of the key pair. For high frequency signals, the 'ns' side is pressed. Time values of a signal can be determined as described under the 'screen controls and graticule' function. The AUTO RANGE key activates a continuous automatic adjustment of the TIME/DIV of the main timebase. The result is a display of between 2 and 6 waveform periods on the screen. This functions in digital mode. For more information, refer to the AUTO RANGE function. If AUTO RANGE is turned on when VAR is active, the timebase is changed in such a way that the trace on display is kept unchanged.

In the digital mode, the timebase speeds are determined by an XTal oscillator. VARIABLE control of the timebase speeds in digital mode happens in bigger steps than in analog mode

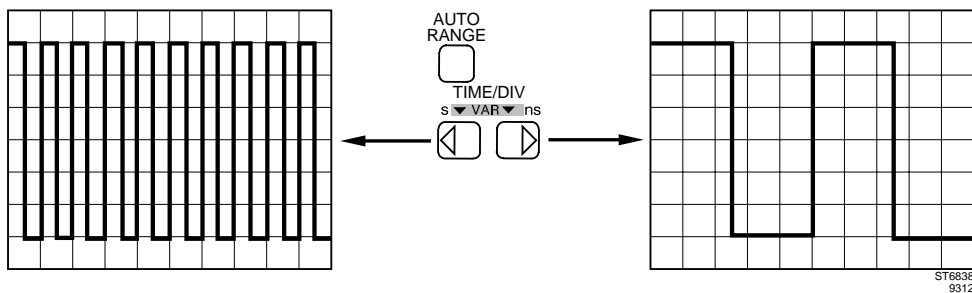

Function of key pair TIME/DIV (VAR).

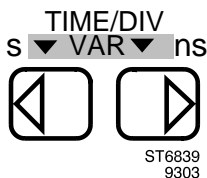
Key sequence:

Key pair to adjust the MAIN TB time scale for fine or coarse steps



Toggle key to switch the AUTO RANGE function of main timebase.

MATHEMATICS

Description:

Two mathematical functions (MATH 1 and MATH 2) are independent waveform processes. These can be used separately, or be chained together if required. Each offers a choice of four mathematical functions (add, subtract, multiply, filter). The result of each function is always placed in a separate register.

Independent operation allows two separate processes to be performed at the same time. By placing the result of a mathematical function in a register memory, it is possible to chain functions together. An example is Ch1xCh2 with its result being filtered to remove noise. In this example, MATH 1 is the multiply function with the product placed in m1 and MATH 2 is the filter process, filtering the contents of m1 and placing its results in m2.

Appendix D gives the complete menu structure of the MATH menu.

When the oscilloscope has been delivered with the optional 'MATH +' menu, the set of functions is expanded with integration, differentiation, Fast Fourier Transformation (FFT) analysis, and histogram analysis processes. For more details of these, see the separate MATH PLUS manual.

MEASURE MENU

Description:

In the digital mode the oscilloscope can perform two calculated measurements (MEAS1 and MEAS2) simultaneously. These measurements are in addition to the cursor measurements described under CURSORS. Each calculated measurement can be individually selected. Once selected, the results are automatically updated with each new signal acquisition and the result is displayed in the top left corner of the screen.

Measurements can be performed on live signals or signals stored in any of the registers. It is possible to perform measurements on the part of the waveform between the two cursors. This function is called cursor-limited measurements and is turned on via the key sequence MEASURE >> CURSOR LIMIT & STATIST >> CURSOR LIMITED yes. Cursor operation is done via the TRACK and Δ controls and via the CURSOR menu.

There are three measurement dimensions: amplitude (volt), time, and delay. The lower part of the menu reflects the type of measurement selected.

The following measurements are available:

volt: dc, rms, min peak, max peak, pk-pk, low level, high level, overshoot (positive and negative), preshoot (positive and negative)
 time: frequency, period, pulse width, rise time, fall time, duty cycle
 delay: channel to channel on leading or trailing edges

Refer to the functions TIME MEASUREMENT, VOLT MEASUREMENT, and DELAY MEASUREMENT for more information.

Execution of these measurements can also be controlled by pressing the command switch on the measuring probe in the TOUCH, HOLD & MEASURE™ mode. (Refer to the appropriate function for more information.)

Appendix E gives the complete menu structure of the MEASURE menu.

All calculated measurements are made using the HISTOGRAM method. The HISTOGRAM method is used to assure that measurements on signals with distortion, overshoot, ringing, or noise, establish the most probable signal levels as references for the 0 % and 100 % amplitude levels.

The next figure shows all parameters used in this method.

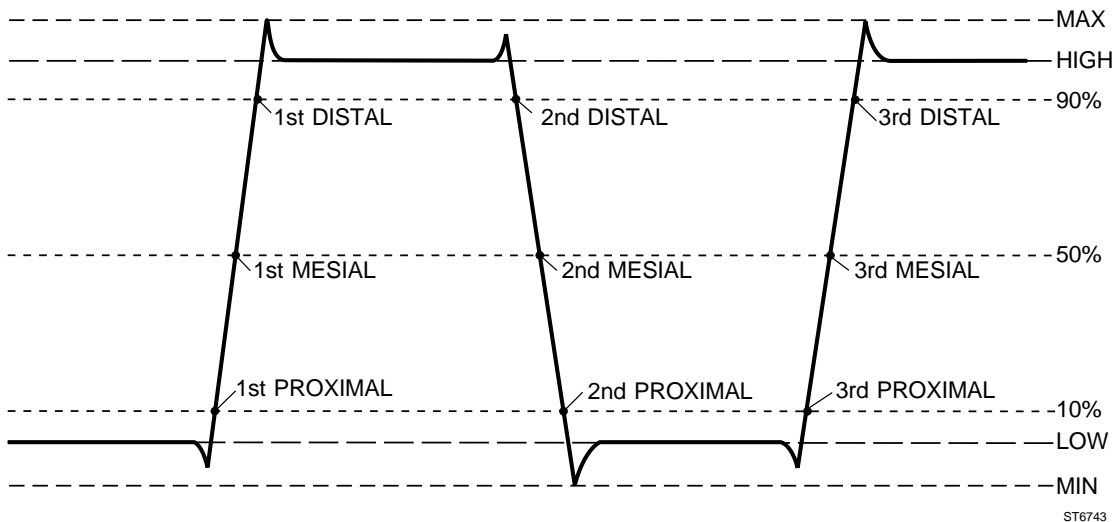

All calculated measurements are made following a fixed sequence:

1. Using the HISTOGRAM algorithm, determine the HIGH-LOW levels and the MIN-MAX levels. These parameters are used to define the 0% and 100% voltage levels of the signal.
2. Calculate the MESIAL, DISTAL, and PROXIMAL levels. These voltage levels are derived from the HIGH and LOW.

3. Calculate all other signal parameters. The formulas for all time and volt measurements are given in the sections for DELAY MEASUREMENT, TIME MEASUREMENT, and VOLT MEASUREMENT.

The HISTOGRAM method determines the voltage levels. This method is as follows:

- The input data (= trace) is used to create a histogram. This histogram evaluates all signal amplitude values that occur in a given signal, plus the number of occurrences for each amplitude value found in the trace. The highest number of occurrences at the high end of amplitude range determines the HIGH level, when the count is over 5% of the total number of samples. Under the same condition, the highest count in the low end of the amplitude range determines the LOW level..
- If the 5% limit is not reached by any count, the HIGH level is set to the MAX level and LOW is set to the MIN level. MAX and MIN are the highest and the lowest detected amplitude levels. This occurs for example when the signal is a sinewave.
- The DISTAL, MESIAL, and PROXIMAL level are now derived as follows:
DISTAL = $0.9 * (\text{HIGH} - \text{LOW})$
MESIAL = $0.5 * (\text{HIGH} - \text{LOW})$
PROXIMAL = $0.1 * (\text{HIGH} - \text{LOW})$

Remote commands:

CPL: QM (Command to query a measurement)

Refer to Chapter 6 for full details.

MULTIPLY (MATHEMATICS)

Description:

The MULTIPLY function performs a point-to-point multiplication of two traces. The value of each data point is related to ground. The result of the MULTIPLY function is a trace in a register.

The result trace can be scaled and positioned.

Scaling is the correction of the resulted trace to fit in the screen. The TRACK control is used to adjust scaling.

Vertical positioning is called offset. It offsets each sample in the resulting trace with a certain value so that the trace can be "moved" vertically. The Δ control is used to adjust vertical positioning.

The scale factor and the offset factor are displayed in the 'MATH SCALE' menu. Pressing the 'autoscale' softkey automatically selects the settings for the trace to fit in the screen.

Newly acquired traces or previously stored traces can be used as source for this process and can be selected with the Δ control. The resulting trace is automatically written in a register memory (m1 for math1 or m2 for math2).

To see the result more clearly, use the 'DISPLAY SOURCE on/off' softkey to turn off the two source traces.

One example of using the MULTIPLY function is the measurement of dissipated power, by taking the voltage across a device and multiplying it by the current through the same device.

Mathematical description:

$$\text{Result} = S1 \times S2$$

Key sequence:

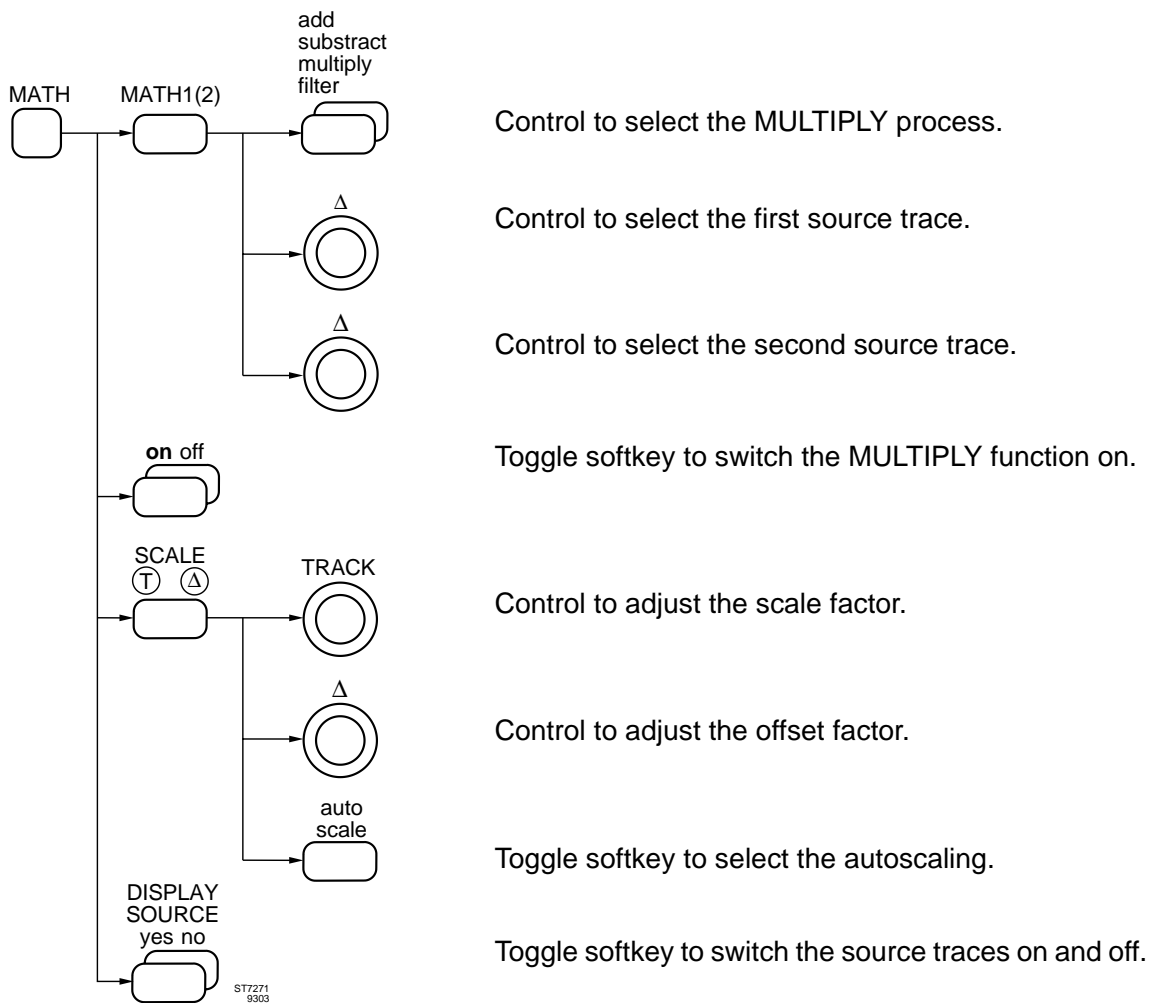

Control to select the MULTIPLY process.

Control to select the first source trace.

Control to select the second source trace.

Toggle softkey to switch the MULTIPLY function on.

Control to adjust the scale factor.

Control to adjust the offset factor.

Toggle softkey to select the autoscaling.

Toggle softkey to switch the source traces on and off.

Remote commands:

CPL: QW (Command to query a waveform)

Refer to Chapter 6 for full details.

PEAK DETECTION

Description:

This function is available only in the digital mode.

In the acquisition system of a Digital Storage Oscilloscope, the sample distance is determined by the time base speed. At higher time base speeds, the distance between the samples is short; at lower time base speeds, the sample distance is longer.

To capture high frequency signals, or signal details of short duration, a high time base speed is usually selected. A high time base speed captures a time 'window' that is usually equivalent to the length of the screen. So at higher time base speeds, the time 'window' is shorter than at lower time base speeds.

Some applications require the time 'window' to be long. This is then achieved by selecting a slow time base speed, to fit the requirement. But at lower time base speeds, the time distance between the actual samples increases. The result is, that signal details shorter than the sample distance will be missed.

The peak detection mode allows the Analog to Digital Convertors (ADC) to operate at their highest speed, even when a lower time base speed has been selected. The result is that, even at lower time base speeds, the maximum or minimum peaks of the signals are placed in memory and displayed. This technique is referred to as oversampling.

Using peak detection (PEAK DET) allows you to capture peak values of the input signal which may otherwise occur between the samples. PEAK DET operates on repetitive signals as well as on signals taken in a single acquisition.

The shortest events (or 'glitches') that can be captured are 5 ns in the single channel mode and 10 ns in the dual channel mode. Selection of peak detection is made from the ACQUIRE menu.

The following is an overview of peak detection possibilities:

Mode of use	Description	Peak detection speed
one channel	any channel	5 ns
two channels	Ch1 & Ch2 or Ch3 & Ch4	10 ns
three channels	ALT mode	10 ns
	CHOP mode	not applicable
four channels	ALT mode	10 ns
	CHOP mode	not applicable

See the function ACQUISITION LENGTH for additional information

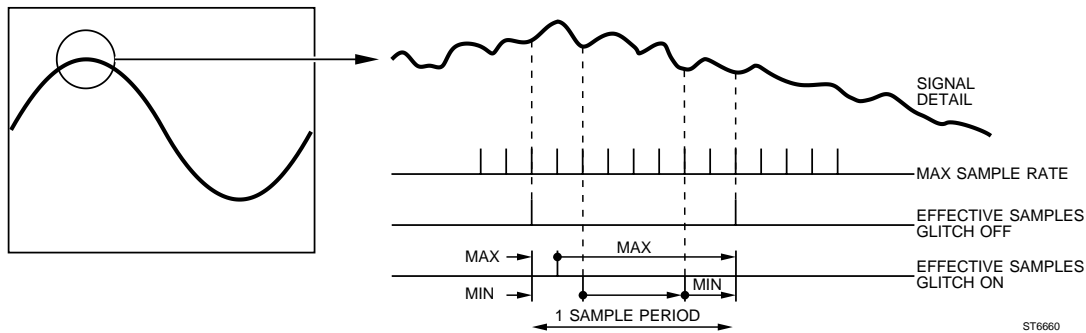

Key sequence:

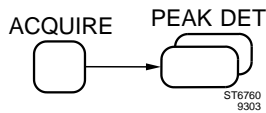

Toggle key to switch the peak detection on/off.

POSITION

Description:

Position controls allow the signals to be shifted across the screen to align signals with the measuring graticule to make time and voltage measurements.

Vertical positioning is done for each channel with the POS controls.

Horizontal positioning of all signals is done with the X POS control.

Key sequence:

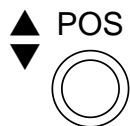

Control to adjust vertical position of a channel.



Control to adjust the horizontal position of all the channels

POWER SUPPLY

Description:

The instrument can be used at any nominal line voltage between 100 Vac and 240 Vac, with no switching and no fuse changes. After the instrument is turned on by pressing the POWER ON/OFF switch, an automatic power-up test is started. For detailed information, refer to the 'CONFIDENCE CHECK' function.

The oscilloscope starts up with its previous settings when backup batteries are installed. In the absence of batteries, the standard default setting 'std' becomes active. Refer to STANDARD FRONT for details.

Key sequence:

POWER ON OFF

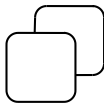

Toggle key to switch the oscilloscope on/off.

PRINTING AND PLOTTING

Description:

In the digital mode a hard copy of the information on the CRT can be made to a printer or a plotter. The hard copy can consist of trace(s), the trace settings, trace identification, cursors, measurement results, and the screen graticule.

The oscilloscope and printer/plotter must be interconnected via a suitable cable and must be set up to the correct interface parameters. The setup of the print or plot action is made in the UTILITY >> PRINT & PLOT & CLOCK menu. The setup of the interface parameters is made in the UTILITY >> REMOTE SETUP or the UTILITY >> RS232 SETUP menu. This is described under the REMOTE CONTROL IEEE 488.2 and RS-232 functions. The settings of the printer or plotter are described in the manual that comes with the printer or plotter.

The front panel key HARDCOPY is used to start a print or plot. During the plot action, the screen shows the message 'HARDCOPY BUSY: ..% DONE,' and during a print or plot action, all front panel keys except HARDCOPY are inactive. Pressing the HARDCOPY key again stops the hard copy action. Before continuing, wait for the message 'HARDCOPY DONE'.

Interface

The instrument is equipped with an RS-232 Interface as standard. This interface can be used with an RS-232 printer or plotter.

The IEEE 488.2 Interface is available as factory installable option. This interface can be used with IEEE-488 compatible printers or plotters.

For correct functioning, correct interface parameters must be set. This is done in the menu UTILITY >> PRINT&PLOT&CLOCK.

Press the IEEE / RS232 softkey to select the IEEE or the RS232 interface.

Printer or plotter

This selects the menu to set up a printer or plotter being used.

Printer type	Supported printers: HP2225, FX80, LQ1500, HPLASER (150 dpi), HP540 DeskJet or compatibles. The TRACK control is used to make the selection.
Plotter type	Supported plotters: HP7440, HP7550, HP7475A, HP7470A, HPGL (Can be used to import screenplots in a suitable word processing files), PM8277, PM8278 and dump-m1. This selects a trace dump to arbitrary waveform generator PM5150. The dump action is started with the front panel key HARD COPY or PLOT. Data transfer is possible via RS232 or IEEE option. The TRACK control is used to make the selection.

Layout

A submenu is provided to customize the output to the printer or plotter. This submenu changes, depending on the printer or plotter that has been selected.

Grid	If 'yes', the complete grid (screen graticule) with divisions is printed/plotted. If 'no', only the square border in printed/plotted.
Paper size	This can be 11" or 12" for printer and A4 (A size) or A3 (B size) for plotters.
Plot format (plotters only)	This can be 1:1 and 2:1.
Trace information	If 'yes', the settings readout and measuring results are printed/plotted.
Colors (plotters only)	If 'yes', the traces are plotted in different colors. If 'no', all traces are plotted in one color.

Real-time clock

The real-time clock is used to make time stamps on a hardcopy. Hardcopies will be stamped with two timestamps: the time of operation of the HARD COPY key and the time of trigger of the acquisition.

Adjust block

Three softkeys are used to adjust the clock. The softkey in the middle determines if the adjustment is done for day, month, year, hour, minutes or seconds. The item to be adjusted is displayed intensified. The adjustment is done with the upper and lower softkey. The upper softkey *s* gives an increase, the lower softkey *t* a decrease.

Date format

The date can be selected to be in the European format (day:month:year), USA format (month:day:year) or Japanese format (year:month:day).

Confirm

The adjusted time becomes active after pressing the softkey ENTER & RETURN.

Key sequence:

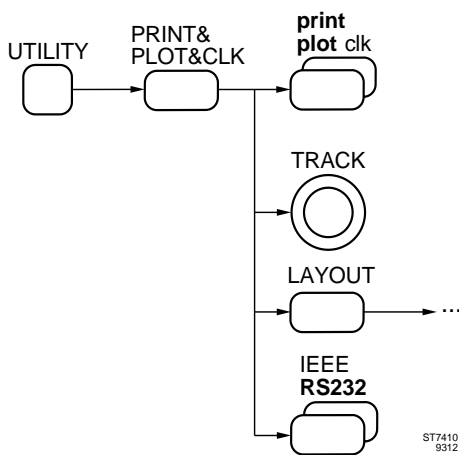

Toggle softkey to select printer, plotter or clock menu.

Control to select printer (plotter) type.

Access to LAYOUT menu for printer or plotter.

Toggle softkey to select IEEE or RS-232 interface (only visible if IEEE interface is present).

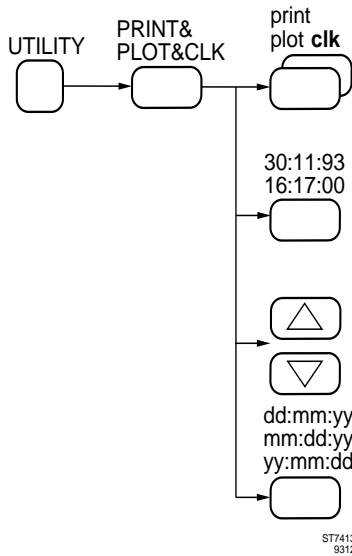

Toggle softkey to select printer, plot, or clock menu.

Toggle softkey to select the clock (time stamp) to be adjusted with the up/down softkey pair.

Up/down softkey pair to adjust the time.

Toggle softkey to select European, USA, or Japanese format of the date.

ST7413
9312

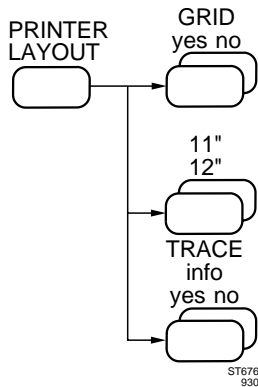

Toggle softkey to print the grid.

Toggle softkey to select paper length.

Toggle softkey to print trace information.

ST6763
9303

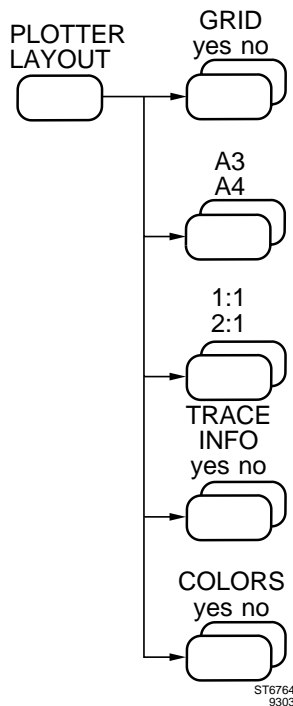

Toggle softkey to plot the grid.

Toggle softkey to select paper size.

Toggle softkey to select plot format.

Toggle softkey to plot trace information.

Toggle softkey to plot traces in colors.

ST6764
9303

PROBE UTILITIES

Description:

The 'PROBE SWITCH' setting of the 'UTILITY >> PROBE' menu determines the instrument's reaction when you press the command button on the probe. You can select between the start of AUTOSET, performing a TOUCH, HOLD & MEASURE™, selecting the next setup or switching between analog and digital mode.

For non-Fluke probes or probes without an indication ring, the attenuation factor can be programmed. As a result, the combined input sensitivity of the probe and oscilloscope is given in the readout area. The selections in the UTIL PROBE CORR menu are reached via the key sequence 'UTILITY >> PROBE >> PROBE CORR'. Attenuation factors 1:1, 10:1, 20:1, 50:1 and 100:1 can be selected. This can be done for each channel individually.

Key sequence:

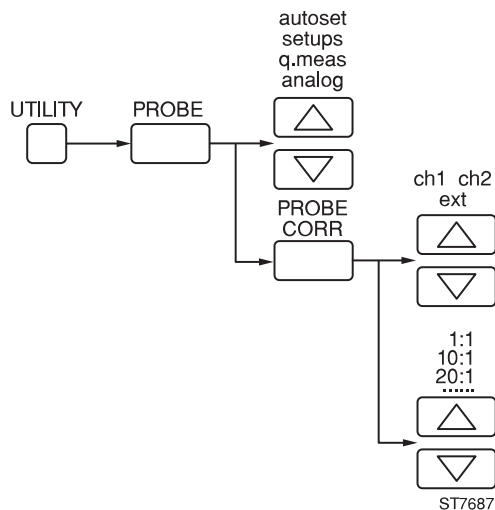

Softkey pair to select oscilloscope's reaction on pressing pushbutton on probe

Softkey pair to select for which channel the probe attenuation is valid (ch1, ch2, ch3, ch4 or Ext Trig)

Softkey pair to select probe attenuation factor (1:1, 10:1, 20:1, ...)

REMOTE CONTROL IEEE 488.2

Description:

An IEEE 488.2 Interface is available as an option. This interface can be used to control oscilloscope functions by an external computer. All of the oscilloscope's current settings can be read by the computer.

The programming language is called SCPI (Standard Commands for Programmable Instruments). SCPI is an IEEE standardized language designed for remote control of programmable test and measuring equipment. General information for SCPI and the instructions are located in a separate programming manual. The 24-pole connector and its connections are shown in the figure below.

For correct functioning in a IEEE 488 environment, the oscilloscope's device address must be selected. This is done in the UTILITY REMOTE CONTRL menu with the TRACK control. This menu is reached via the key sequence 'UTILITY >> REMOTE CONTRL'. To change the IEEE settings, first select IEEE with the 'RS-232 IEEE' softkey.

Operation of front key STATUS LOCAL passes the control of the oscilloscope from the interface (remote) to the front keys (local).

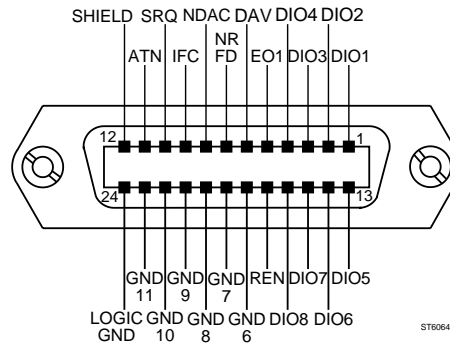

Key sequence:

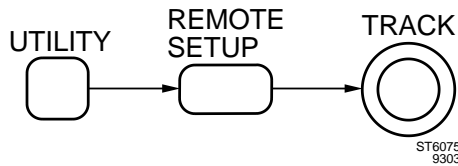

Control to select the IEEE device address.

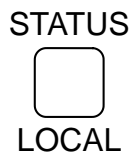

Key to switch from remote to local

REMOTE CONTROL RS-232

Description:

The oscilloscope is equipped with an RS-232 Interface as standard. This can be used for remote control or for setting the readout using an external controller or PC.

The language used is called CPL (Compact Programming Language) and is described in Chapter 6. CPL is a small set of very powerful commands for full remote control of all oscilloscope functions. The male 9-pin connector and its connections are shown in the figure below.

For correct functioning Communication parameters must be adjusted. This is done in the menu UTILITY RS-232 SETUP. This menu is reached via the key sequence 'UTILITY >> RS-232 SETUP >>'. Possible Selections are:

- Baud rate. To be selected with the TRACK control.
- Number of DATAbits and PARITY. Combinations are

dataBITS:	7	7	8	8	8
PARITY:	Odd	Even	Odd	Even	No

 There is always one stopbit.
- Hardware handshake is selected with '3-wire/7-wire'. In the 7 wire position the hardware handshake signals DSR/DTR and CTS are active.
- Software handshake is selected with 'XON-XOFF on off'.

Operation of the front panel key STATUS LOCAL passes the control of the oscilloscope from the interface (remote) to the front panel keys (local).

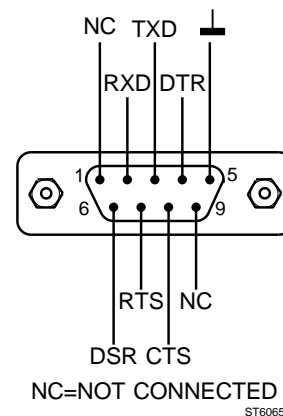

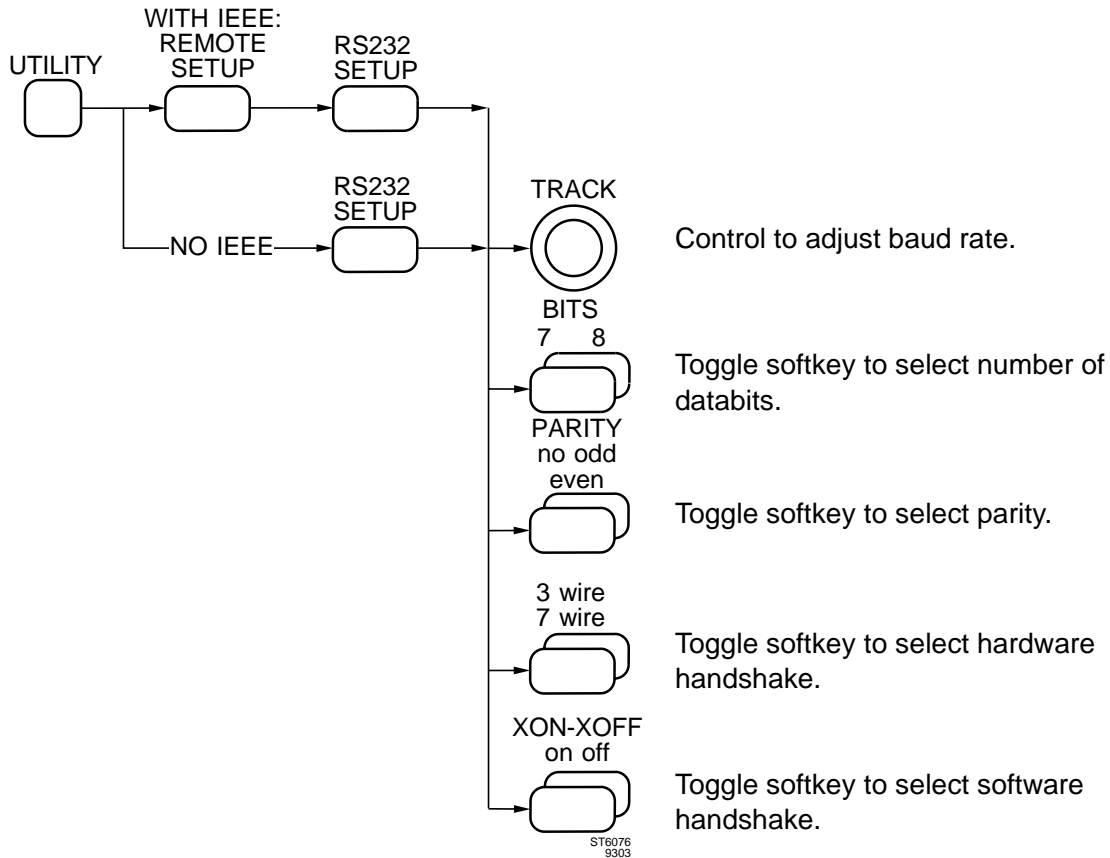
Key sequence:**STATUS**

Key to switch from remote to local.

Remote commands:

- CPL: PC (Command to program communication parameters)
- GL (Has same result as operation of STATUS LOCAL key)
- LL (Inhibits front key STATUS LOCAL)

Refer to Chapter 6 for full details.

RUN/STOP

Description:

The RUN/STOP button operates in the digital mode only. When the STOP function is active, any new signal acquisition is stopped and the trace is 'frozen'. The status of the STOP function is displayed in the bottom right side of the screen.

With the acquisitions STOPped, the following actions are still possible:

- Plot actions
- Display changes (also Y POS)
- Cursor measurements
- Calculated measurements
- Mathematics and signal analysis
- Settings of the acquisition system (actions that influence the contents of the register are not possible).
- Data can be saved in memory
- Front settings actions (also recalls)

Pressing the RUN/STOP key returns the oscilloscope to the acquisition mode that was in effect before the key was pressed.

Key sequence:

RUN/STOP



Key to stop the acquisition and to freeze the trace and to start the acquisition again.

SCREEN CONTROLS AND GRATICULE

Description:

The screen controls are located to the left of the CRT viewing area.

Brightness of trace(s) and text can be adjusted separately with the TRACE INTENSITY and TEXT INTENSITY controls. Intensity of the trace(s) can also be determined by a voltage applied to the rear panel socket Z MOD. Refer to 'Characteristics' Chapter 1 of the Reference Manual for input amplitudes.

The FOCUS control is used to optimize display sharpness.

A graticule is provided with 1cm x 1cm divisions. Each vertical centimeter equals the indicated channel sensitivity. A horizontal centimeter equals the indicated timebase setting. The graticule has 0, 10, 90, and 100 % lines that can be used for risetime measurements. For these, the signal peaks are exactly positioned on the 0 and 100 % lines. The risetime of the pulse is readout between the 10 and 90 % lines as shown in the following figure. Intensity of graticule illumination is controlled with the GRATICULE ILLUMINATION control.

Trace alignment is done with the screwdriver operated TRACE ROTATION control.

Screen controls and function of TRACE ROTATION.

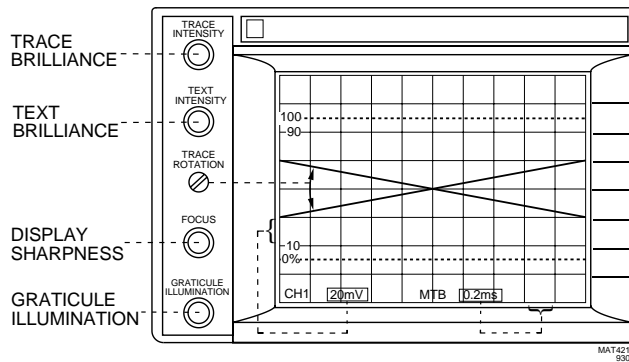

Rise time measurement using the graticule.

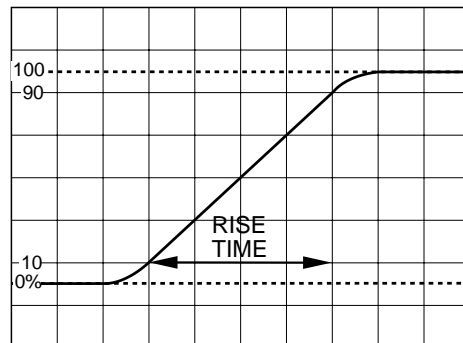

MAT4217

Key sequence:

TRACE INTENSITY



Control for trace intensity.

TEXT INTENSITY



Control for text intensity.

TRACE ROTATION



Screwdriver operated control to align the trace with the graticule

FOCUS



Control for focusing of trace, text and cursors.

GRATICULE
ILLUMINATION

Control for illumination intensity of measuring graticule

SCREEN MESSAGES

Description:

User messages show up in the center of the CRT viewing area. Messages warn of incorrect settings and error conditions. The following table shows the important messages.

Message	Meaning
	Refer to function '...'
ALWAYS PARITY IF 7 BITS	Always parity in case of 7 bits. Function 'REMOTE CONTROL RS-232'.
AUTOCAL...(approx 4 min)	Indicates that autocalibration has started. Function 'CALIBRATION AUTOCAL'.
AUTOCAL NECESSARY	Indication that scope is out of its specified temperature range and that an autocalibration is necessary. Function 'CALIBRATION AUTOCAL'.
AUTO SETTING...	Indicates that instrument performs an autoset. Function 'AUTOSSET'.

AUTO SETTING (USERPROGRAM)	Indicates that instrument performs an userprogrammed autoset. Function 'AUTOSET USERPROG'.
CALIBRATION COMPLETED	Autocalibration is completed. Function 'CALIBRATION AUTOCAL'.
CALIBRATION ERROR ...	Autocal not successfully completed. Function 'CALIBRATION AUTOCAL'.
CH. 50Ω OVERLOAD	Input voltage at 50Ω input impedance is too high. Function 'INPUT IMPEDANCE'
DESTINATION PROTECTED	MATH1 (2) is activated while register M1 (2) is protected. Functions 'ADD', 'FILTER', 'MATHEMATICS', 'MULTIPLY' and 'SUBTRACT'.
FUNCTION ONLY IN ANALOG	Function activated in digital mode, but is only present in analog mode. Function 'ANALOG MODE'.
HARDCOPY ABORTED	Print or plot action has been aborted. Function 'PRINTING AND PLOTTING'.
HARDCOPY BUSY : ..% DONE	Instrument is busy with a print/plot action. Function 'PRINTING AND PLOTTING'.
HARDCOPY DONE	Print/plot or abort action has been done. Function 'PRINTING AND PLOTTING'.
INVALID REGISTER SELECTION	Copying to the same register is not possible.
INVALID SELECTION	Selected source is not valid. Functions 'ADD', 'FILTER', 'MATHEMATICS', 'MULTIPLY' and 'SUBTRACT'.
KEY INACTIVE WHEN STOPPED	Pressed key is inactive when trace is frozen. Function 'RUN/STOP'.
NO AVERAGE IN ROLL MODE	Average and Roll modes cannot be combined. Function 'AVERAGE' and TB MODE'.
NO BATTERY BACKUP	Battery backup not possible because of absence of batteries.

NO DTB, ACQ. TOO LONG	Del'd TB only possible at acquisition length of 512 sample points. Functions 'ACQUISITION LENGTH' and 'DEL'D TB'.
NO DTB IN ROLL MODE	Del'd TB and Roll modes cannot be combined. Function 'DEL'D TB' and 'TB MODE'.
NO ENVELOPE IN ROLL MODE	Envelope and Roll modes cannot be combined. Function 'ENVELOPE' and 'TB MODE'.
NO EVENT DELAY, DUAL SLOPE	Event delay and dual slope cannot be combined. Function 'DELAY'.
NO EVENT DELAY IN TV MODE	Event delay and TV trigger mode cannot be combined. Function 'DELAY' and 'TV TRIGGER'.
NO IND WITH THIS COUPLING	Trigger level indication not possible at dc input coupling and ac or lf-rej trigger coupling. Function 'UTILITY SCREEN & SOUND'.
NOT PART OF X VS Y REGISTER	X-source only possible out of chosen register. Functions 'DISPLAY MENU' and 'X-DEFLECTION'.
PLEASE FIRST SWITCH TO DSO	Activated function only possible in digital mode. Function 'ANALOG/DIGITAL MODE'.
PLOT KEY = ABORT	Indicates that the print/plot action can only be aborted with PLOT key. Function 'PRINTING AND PLOTTING'.
PRESS 2 SEC FOR AUTO CAL	CAL key must be pressed for more than two sec to start autocalibration. Function 'CALIBRATION AUTO CAL'.
PROBE DETECTED, NO CHANGE	The automatic probe detection overrules manual selection when a probe with indication ring is used. Function 'PROBE UTILITIES'.

REGISTER EMPTY	Recalling traces from an empty register is not possible. Protection of an empty register is impossible. Function 'RECALL'.
REGISTER PROTECTED	Register cannot be saved in protected memory location. Function 'SAVE'.
REGISTER USED FOR MATH	Trace cannot be saved in register M1 or M2, because it is in use for a MATH function. Function 'MATHEMATICS'.
SETUP EMPTY	Recalling settings from an empty memory location is not possible. Protection of an empty front is impossible. Function 'SETUPS'.
SETUP PROTECTED	Settings cannot be saved in protected memory location. Function 'SETUPS'.
STD SETUP = RECALL ONLY	Save settings in the 'std' front is not possible. Function 'SETUPS'.
TIME/DIV ADJUSTED FOR ROLL	Set timebase to fastest Roll mode position. Function 'TB MODE'.
TOO MANY TRACES	Maximum allowed traces is eight.

SETUPS

Description:

Ten complete front panel settings can be saved into a battery backed-up memory. This feature is useful for routine measurements. Setups are stored in memory location labeled s1 ... s10. These memories are accessible under the menu key **SETUPS**. The menu structure is shown in Appendix H.

Selection of the memories s1 ... s10 is done with the TRACK control. Memory location 'std' is a factory-stored set of standard settings that can be used to put the instrument in a defined state. For a detailed specification, refer to the STANDARD FRONT function.

save: The actual set of settings is saved in the selected memory location.

recall: The settings saved in the selected memory location become the actual settings.

undo: The settings previous to the last recall action become active again.

CLEAR & PROTECT: in the CLEAR & PROTECT SETUPS submenu 'PROTECT on off' can be used to protect a memory location by prohibiting save actions to this location.

clear all: in the CLEAR & PROTECT SETUPS submenu 'clear all' leads to a confirm menu. The memory locations s1 to s10 are emptied altogether when 'yes' is selected. Selecting 'no' stops the clear action.

Note: Screen messages are given in the CRT viewing area when incorrect commands are given and the action is prohibited. Example: When one attempts to save settings to a protected memory location.

Key sequence:

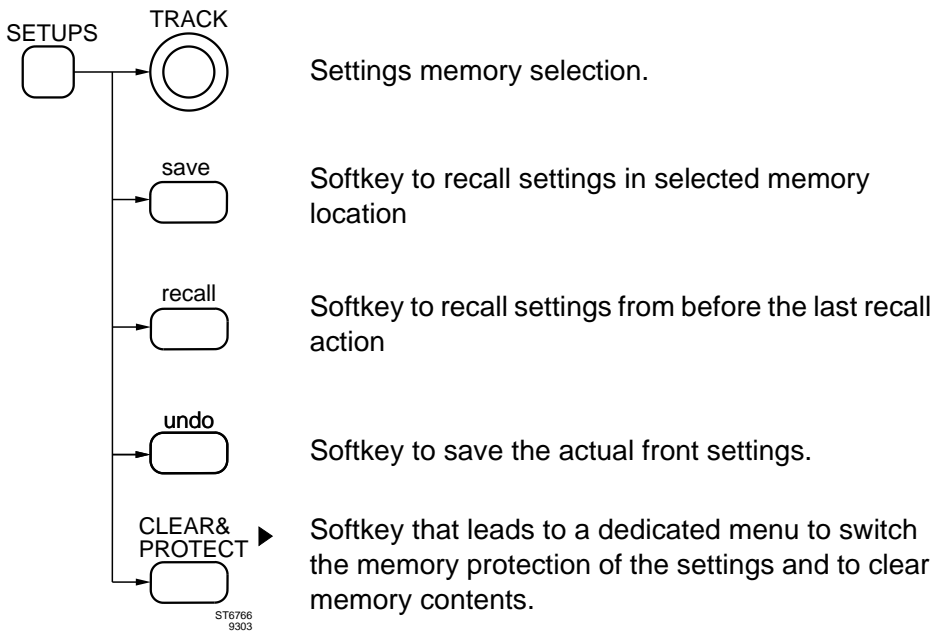

Remote commands:

CPL: SS (To save a front in a desired memory)
 RS (To recall a front from a desired memory)
 PT (To program text into a setup register)
 QT (To query text from a setup register)

Refer to Chapter 6 for details

SETUPS SEQUENCE

Description:

If front panel settings are stored in memory locations 's1 to s5' and 's6' is cleared, then the range of 's1 to s5' is referred to as a sequence. Such a sequence can be used as (part of) a step-by-step testing procedure. There are two possible ways to step through a sequence without have to recall each individual setup using the menus:

- By programming the AUTOSET key to be used as the 'recall next setup' key. This selection can be done in the UTILITY >> AUTOSET menu.
- By using a probe with a COMMAND switch. Each instrument is delivered with two such probes, as standard accessory. The appropriate mode for this probe command can be selected in the UTILITY >> PROBE menu.

To return to the 'normal' oscilloscope mode, recall the STANDARD SETUP by simultaneously pressing the STATUS and TEXT OFF key.

STANDARD SETUP / FRONT PANEL RESET

Description:

A factory-programmed set of default settings is available to put the instrument in a defined state. The default settings (std) are reached in the menu under the SETUPS menu key. Another method to perform a front panel reset is by pressing the STATUS and TEXT OFF keys simultaneously.

The TRACK control is used to Select 'std' and the memories s1 ... s10 (refer to SETUPS). The settings saved in 'std' become the actual settings when the 'recall' softkey is pressed.

The most important 'std' settings are:

- Analog mode.
- AUTOSET USERPROG is set to 'off'.
- Setting readout is switched on.
- Ground indicator is set to 'on'.
- Usertext is set to 'off'.
- Cursors are 'off'.
- Input is dc coupled and input impedance is 1 M Ω .
- Input sensitivity is set to 50mV and VAR off.
- CH1 is on. CH2, CH3, CH4 and EXT TRIG are off.
- Vertical POS is set to center of screen.
- MAIN TB on and X-DEFL 'off'.
- MAIN TB in 1 ms and auto mode. VAR and 10x MAGNIFY are off.
- MAIN TB triggering in edge, level-pp on, positive slope, ac coupled and trigger source CH1.

Note: Error messages appear in the CRT viewing area when incorrect commands are given.

Key sequence:

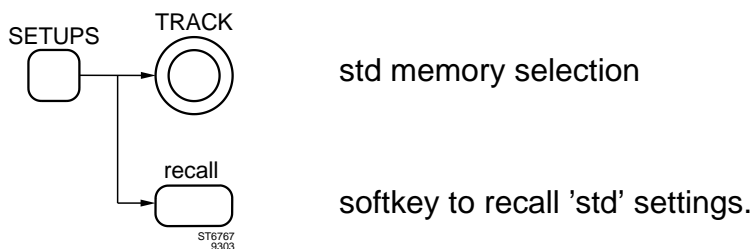

Remote commands:

CPL: DS (Command for a front panel reset).

Refer to Chapter 6 for full details

STATUS SCREEN

Description:

Normally a maximum of four lines of setting information are given in the lower screen area. More extensive setting information can also be displayed. The STATUS toggle key switches between normal and extensive settings information.

The status screen gives the following additional setting readouts:

- Channel input coupling is indicated by AC, DC, or GND instead of symbols.
- Settings of inactive channels are given in addition to the active channels.
- Channel off or on is displayed.
- The probe type is given for each channel.
- A continuous indication of HOLD OFF, LEVEL MAIN TB and LEVEL DEL'D TB is given.
- MAIN TB and DEL'D TB trigger coupling are indicated.
- The trigger position is displayed.
- TV mode settings are displayed.

When the SAVE or RECALL menu is active, the STATUS SCREEN will show the X and Y settings of the displayed traces.

Note: The STATUS key has a third function when the oscilloscope is under remote control. This second function is called 'go to LOCAL' and is indicated in small text below the STATUS key. For more information, refer to the 'REMOTE CONTROL RS-232' and 'REMOTE CONTROL IEEE 488.2' functions.

Key sequence:

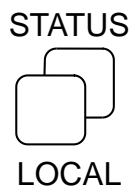

Toggle key to select amount of settings information on screen

SUBTRACT (MATHEMATICS)

The subtract mode is available in the digital mode of operation.

Description:

The SUBTRACT function performs a point-to-point subtraction of two traces. Each point related to the respective ground levels (indicated as '-'). The result of the SUBTRACT function is a new trace in a different register. This trace can be scaled and positioned.

Scaling is the correction of the resultant trace to fit in the screen. Scaling can be adjusted by using the TRACK control.

Vertical positioning is called offset. It offsets each sample in the resultant trace with a certain value so that the trace can be "moved" vertically. It is adjusted with the Δ control.

The scale factor and the offset factor are displayed in the 'MATH SCALE' menu. Pressing the 'autoscale' softkey automatically selects the settings for the trace to fit the screen.

When subtracting signals with different amplitude settings, the size of the smaller signal is automatically adjusted to match the size of the larger signal.

Newly acquired traces or previously stored traces can be used as the source for this process and can be selected with the Δ control. The resulting trace is automatically written in a register memory (m1 for math1 or m2 for math2).

To see the result more clearly, you can turn off the two source traces by pressing the 'DISPLAY SOURCE on/off softkey'.

Mathematical description:

Result = S1 - S2

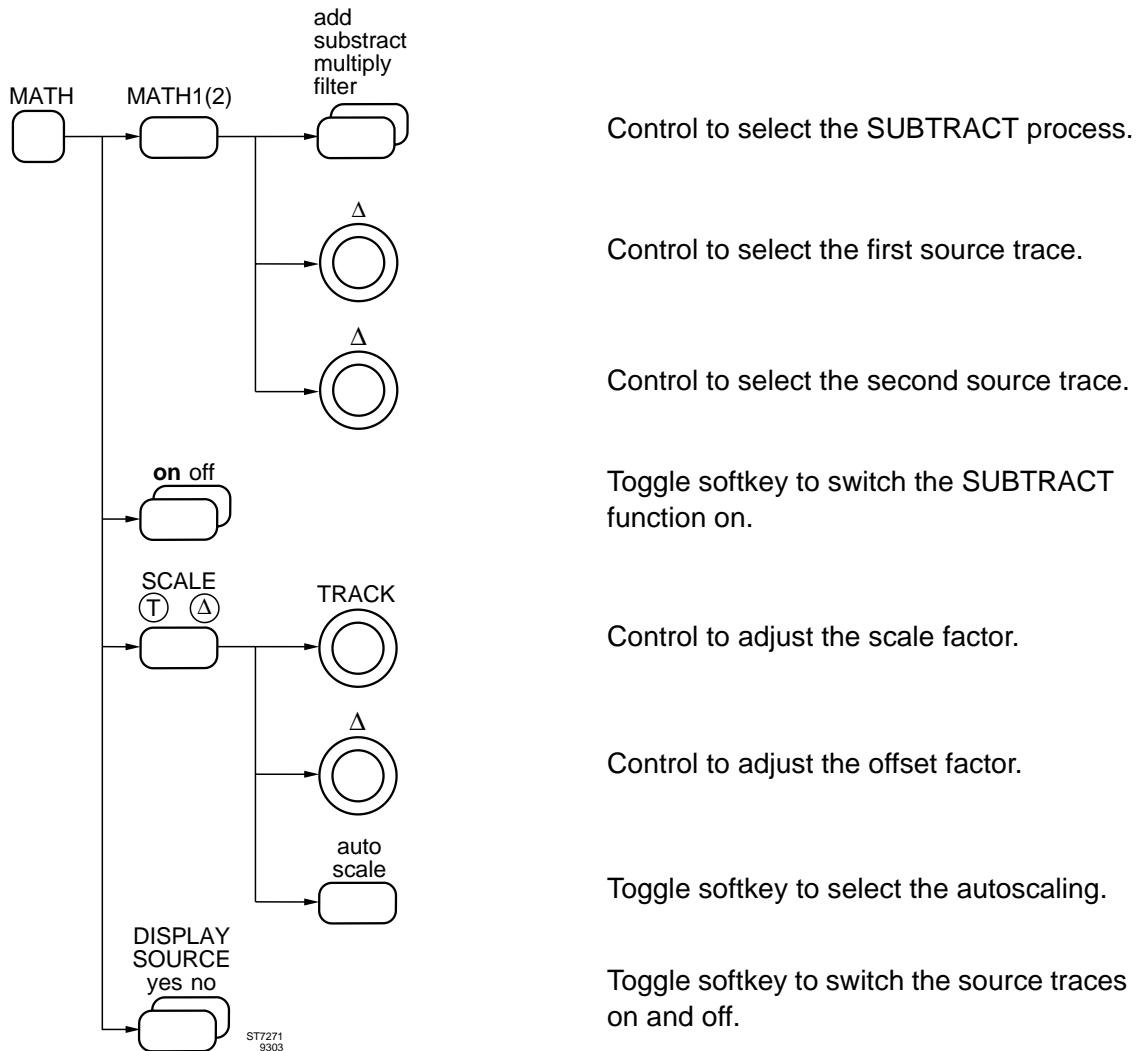
Key sequence:**Remote commands:**

CPL: QW (Command to query a waveform)

Refer to Chapter 6 for full details.

TEXT OFF

Description:

Toggle key to select information in the CRT viewing area. This way, more space is available on screen for trace display. There are three steps in the cycle:

- Softkey menu turned off.
- Instrument settings turned off.
- Both softkey menu and instrument settings turned on again.

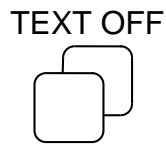
Key sequence:

Toggle key to cycle through three states of information given in CRT viewing area.

TIMEBASE MODES

Description:

The Main Timebase (MAIN TB) can function in three different modes : AUTO, TRIG, or SINGLE. The choice is mainly determined by the frequency of the trigger signal. The modes are explained below.

AUTO In 'auto' mode, the MAIN TB always gives a display, even when no signal is present. It checks for the occurrence of the trigger signal for some 100 ms, but if none is found, it automatically starts a new sweep or acquisition. On repetitive signals this mode is most common except for signal frequencies lower than 10 Hz where unstable displays will occur.

TRIG In the triggered (trig) mode, traces are displayed only when the MAIN TB is actually triggered by a signal. This mode is recommended for frequencies lower than 10 Hz because it assures a stable display. The ARM'D indicator indicates if no trigger occurs.

SINGLE In single shot mode, the MAIN TB runs only once after a trigger. Pressing the SINGLE key resets the scope for single shot operation; the trigger level is automatically set to 0.5 division above ground (indicated by T-). The ARM'D indicator lights when the MAIN TB is waiting for a trigger (MAIN TB armed). The single mode is used to capture and observe (photograph) events that happen only once.

In the digital mode the single mode can be used in combination with pre-triggering to observe and store single events, along with signal information occurring before the trigger point.

Auto, trig, and single can be chosen in the menu under the TB MODE menu key.

In the digital mode the TB MODE menu is expanded to include MULTI (only with the optional MATH+ functions installed), ROLL and REAL TIME ONLY mode.

MULTI Part of **MATH+** option. Refer also to **MATH+ Users Manual**. The **MULTI**ple shot mode enables a number of single shot acquisitions to be made in rapid succession. It is basically the same as **SINGLE** but with automatic rearming following each acquisition. Each acquired waveform is stored in a different memory location.

ROLL In the **ROLL** mode, the **MAIN TB** can be used with sweep speeds from 200 ms/div down to 200 s/div. Initially the trace fills the screen from the right to the left. Once the screen is full, the trace flows 'through' the screen from left to right. When **ROLL** is selected, the **TB MODE** menu provides a 'STOP ON TRIGGER' choice. If this is set to 'off', the trace flows through the screen continuously until you press the **STOP** key. If 'STOP ON TRIGGER' is set to 'on', the trace stops when the scope is triggered and the trigger point reaches the left of the screen.

REAL TIME ONLY In the digital mode the scope operates in random sampling mode for sweep speeds 200 ns and faster. Setting 'REAL TIME ONLY' to 'on' means that these **MAIN TB** positions are inhibited. This measuring errors on signals that are not truly repetitive or identical. **REAL TIME ONLY** also inhibits alternating acquisitions of **MAIN TB** and **DEL'D TB**.

Key sequence:

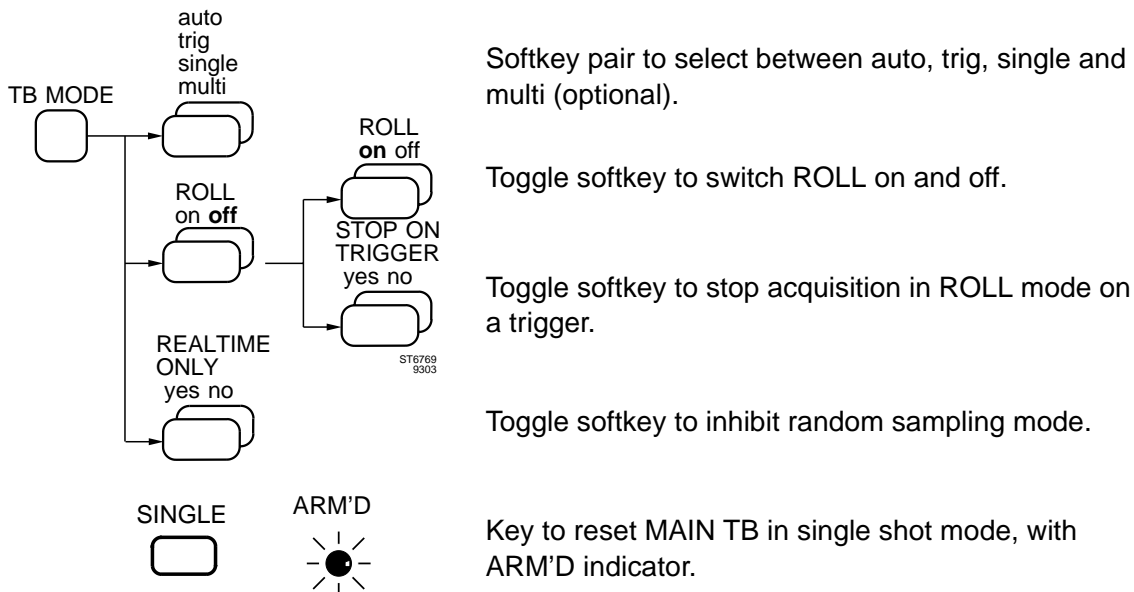

Remote commands:

CPL: AT (has same result as the operation of the **SINGLE** key)

Refer to Chapter 6 for full details.

TIME MEASUREMENTS

Description:

Time measurements can be made using the cursors or using automated, calculated measurement routines. Cursors operate in the **analog** mode as well as in the **digital** mode.

Calculated time measurements are available in the digital mode only.

Using the **cursors**, three time interval readouts can be selected:

- ΔT gives the time interval (seconds) between the cursors.
- $1/\Delta T$ gives an inverted readout of the time interval, and is read in Hz.
- ΔT -ratio gives a percentage (%) that can be reset by using the $\Delta T=100\%$ softkey.

For more details, refer to CURSORS READOUT.

In the **digital** mode, the MEASURE menu accesses automatic time measurements. This menu is reached via the key sequence 'MEASURE >> MEAS 1(2) >> time'. The TRACK control is used to select the type of measurement and the Δ control is used to select the waveform.

The result of the measurement is displayed in the top left corner of the screen.

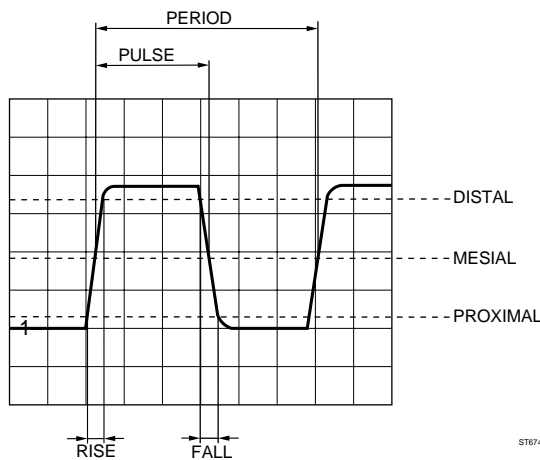

The following measurements are possible:
(Refer to section MEASURE MENU for details of signal parameters).

- freq (FREQUENCY).
Measures the reciprocal of the PERIOD of the signal. Frequency is calculated between the first and third mesial of the signal. At least one complete signal period must be acquired to get a valid measurement.

$$\text{freq} = \frac{1}{\text{time of 3rd mesial} - \text{time 1st mesial}}$$

ST6744

- period (PERIOD).
Measures the time between the first and third mesial of the signal. At least one complete signal period must be acquired to get a valid measurement.

$$\text{period} = \text{time of 3rd mesial} - \text{time of 1st mesial}$$

- pulse (PULSE WIDTH).
Measures the minimum time of the positive part and negative part of the first period of the signal. At least one complete signal period must be acquired to get a valid measurement.

$$\text{pulse} = \min \{ \{ \text{time 2nd mesial} - \text{time 1st mesial} \} \text{ pos part of signal period}, \\ \{ \{ \text{time 2nd mes} - \text{time 1st mes} \} \text{ neg part of signal period} \}$$

Note that the part with the shortest duty cycle is always defined as 'pulse'.

- rise (RISE TIME).
Measures the rise time of a signal. It is calculated between the proximal and distal of the first rising slope of the input signal. At least one rising slope must be displayed on the screen to get a valid measurement.

$$\text{rise} = \text{time of distal of first rising slope} - \text{time of proximal of first rising slope}$$

- fall (FALL TIME).
Measures the fall time of a signal. It is calculated between the proximal and distal of the first falling slope of the input signal. At least one falling slope must be displayed on the screen to get a valid measurement.

$$\text{fall} = \text{time of proximal of first falling slope} - \text{time of distal of first falling slope}$$

- duty (= DUTY CYCLE).

Measures the percentage time of the positive part of the first period of the signal as compared to the period time. At least one complete signal period must be acquired to get a valid calculation.

$$\text{duty} = \frac{\text{2nd mesial of pos part} - \text{1st mesial of pos part}}{\text{time of 3rd mesial} - \text{time 1st mesial}} * 100\%$$

It is possible to perform measurements on the part of the waveform between the two cursors. This function is called cursor-limited measurements and is turned on via the key sequence MEASURE >> CURSOR LIMIT & STATIST >> CURSOR LIMITED yes. Cursor operation is done via the TRACK and Δ controls and via the CURSOR menu.

Results of the measurements MEAS1 and MEAS2 are displayed in the top left corner of the screen. When you press the key sequence MEASURE >> CURSOR LIMIT & STATIST >> STATIST on, the screen displays three values per MEAS function. These values are measured over the total number of acquisitions for that particular measurement and are updated instantly. The statistic measurement values are as follows:

- absolute minimum value
- absolute maximum value
- mean value

Key sequence:

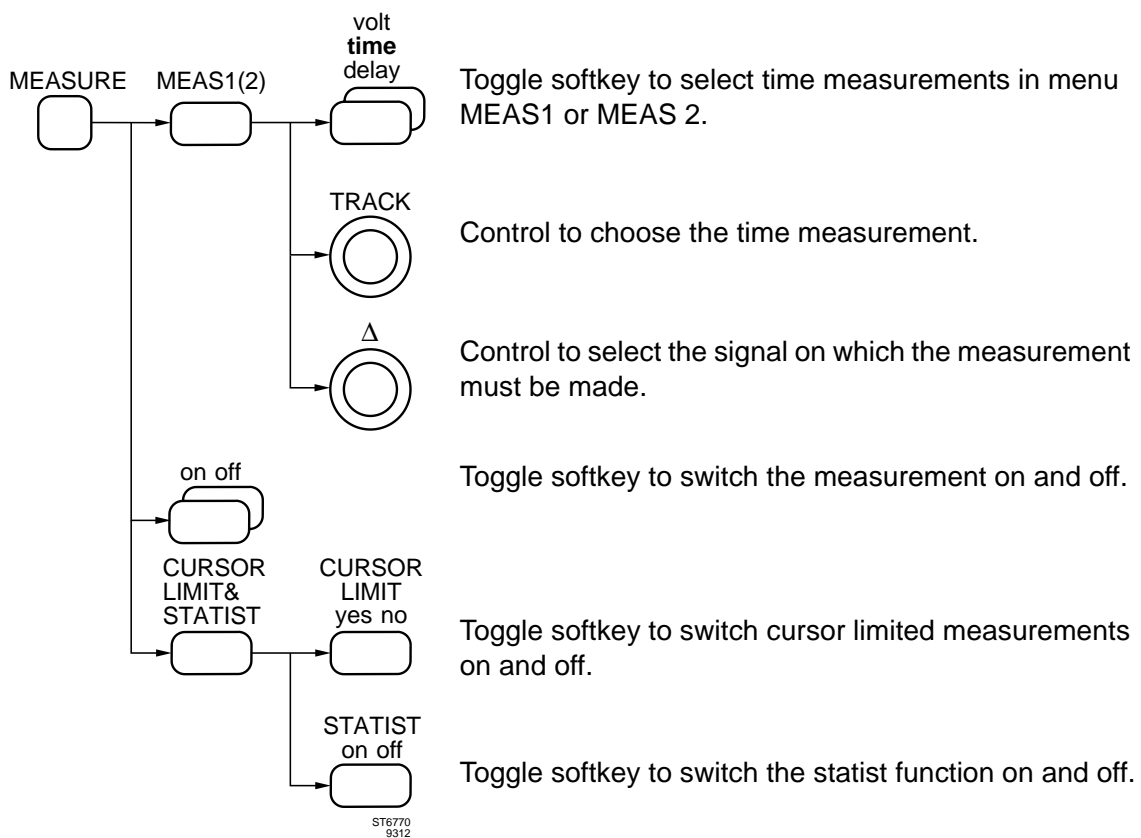

Remote commands:

CPL: QM (Command to query a measurement)

Refer to Chapter 6 for full details.

TOUCH, HOLD & MEASURE™ MODE

Description:

The TOUCH, HOLD & MEASURE.™ mode is a quick way to freeze the trace and to display four main measurements instantly. This is done by pressing the COMMAND switch on the measuring probe of the required channel.

The four measurements are: dc voltage level, peak-to-peak value, rms value, and frequency. The four values are displayed in the upper left corner of the screen.

This function is a fast and easy way of troubleshooting. The COMMAND switch is always where it should be: near the place to be measured (not on the oscilloscope). This feature enables accurate signal probing and display freezing without having to reach and touch the oscilloscope control.

NOTE: The 'PROBE SWITCH' setting of the 'UTILITY >> PROBE' menu must first be set to 'q.meas' in order to obtain a reading on the oscilloscope when you press the COMMAND switch on the measuring probe.

Press the COMMAND switch again to go to RUN mode. TOUCH, HOLD & MEASURE™ results are deleted from display.

Key sequence:

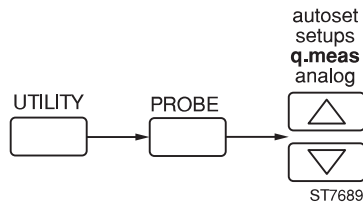

Toggle softkey to select the TOUCH, HOLD & MEASUREMENT™ mode reaction of the oscilloscope on pressing the COMMAND switch on the measuring probe.

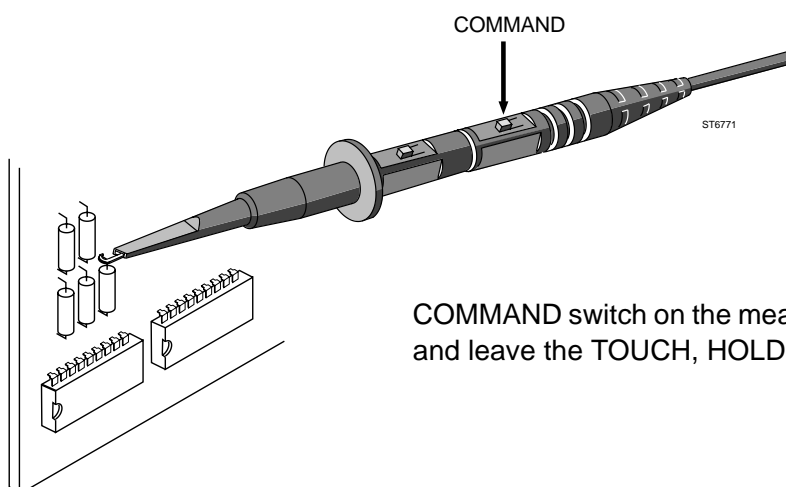

COMMAND switch on the measuring probe to activate and leave the TOUCH, HOLD & MEASURE™ mode.

TRIGGER COUPLING

Description:

Trigger coupling is used to optimize the trigger stability for different signal types.

The filter modes ac and dc are identical to those of the vertical inputs. Refer to function INPUT COUPLING.

Lf-reject cuts off lower frequencies; triggering occurs on signals between 30 kHz and full bandwidth.

Hf-reject cuts off higher frequencies; triggering occurs on signal frequencies lower than 30 kHz. The following figure explains ac, lf-reject, and hf-reject.

Noise 'on' improves trigger stability for noisy signals. By enlarging the trigger gap (of MAIN TB and DEL'D TB) the triggering becomes less sensitive to noise.

The MAIN TB trigger coupling can be selected in the menu under the TRIGGER menu key. For DEL'D TB, the menu under the DTB menu key is used; the selection is possible in 'triggered' mode (ch1, ch2 and ext trig) only.

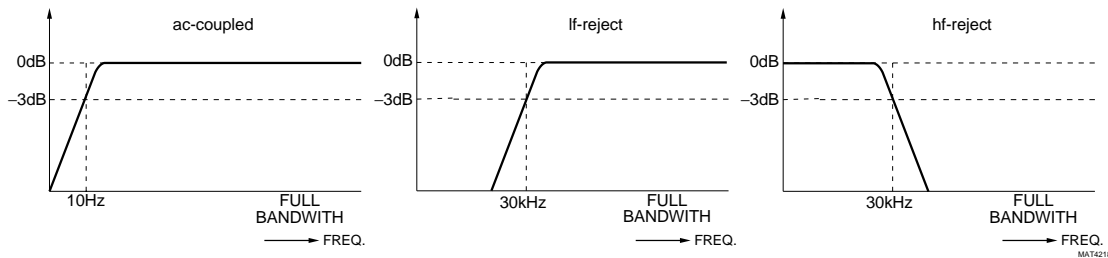

Effect of trigger coupling modes

Presence of trigger level indicators (T-, D-) as a function of trigger coupling and other oscilloscope settings:

Trigger coupling	Vertical input coupling	Trigger level indicator
ac	dc	off
dc	dc	on
lf-rej	dc	off
hf-rej	dc	on
all settings	ac	on
if level-pp is on		off

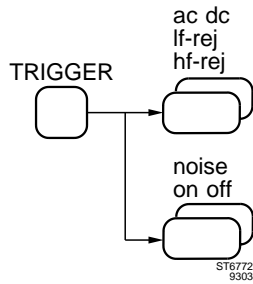
Key Sequence:

Toggle softkey to select MAIN TB trigger coupling modes ac, dc, lf-reject, and hf-reject.

Toggle softkey to switch 'noise' mode for MAIN TB/DEL'D TB.

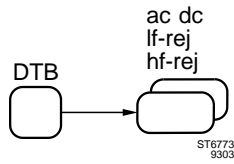

Toggle softkey to select DEL'D TB trigger coupling modes ac, dc, lf-reject and hf-reject. Not selectable when 'starts' is active in the menu under the DTB key.

TRIGGER DEL'D TB

Description:

The Delayed Timebase has two operating modes: starts and triggered. In both modes the main timebase must be triggered first, and the delay time must have expired. The Del'd Time Base modes are selected in the DELAYED TIMEBASE menu after switching the delayed timebase on.

In the "STARTS" mode, the DEL'D TB starts immediately after the DELAY time. This is explained under DEL'D TB. When signal jitter is present, the effect will be magnified by using the DEL'D TB. The jitter is eliminated by changing from the 'starts' to the triggered mode. The start of the DEL'D TB sweep is then 'postponed' to the first DEL'D TB trigger after the delay time.

The triggered mode is activated in the DELAYED TIMEBASE menu by selecting the trigger source (ch1, ch2 and ext trig). For stable triggering, the DEL'D TB trigger level must be adjusted to a proper level. The trigger level for the Del'd Time Base is adjusted with the Δ control. The figure shows the difference between 'starts' and 'trig'd'.

For more explanation of trigger functions, refer to 'TRIGGER MAIN TB' function. For details about trigger coupling, see the appropriate section.

DEL'D TB 'starts' and 'trig'd' modes

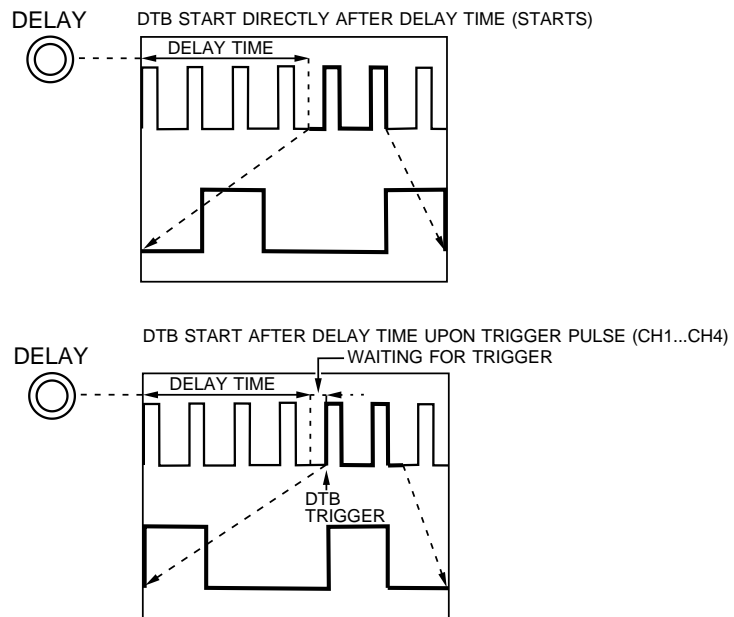

MAT4214

The DEL'D TB trigger source and slope can be selected when:

- The menu is active.
- The 'trig'd' mode is selected.

Source and slope are selected with the same TRIG 1, TRIG .., and EXT TRIG keys that are used for the main timebase trigger source and slope selection. The delayed timebase source and slope have their own readout. This readout can be found at the bottom right corner of the screen, below the readout for the main timebase trigger source and slope.

If the channel and trigger coupling are the same (e.g., both ac or both dc), the trigger level is indicated on the screen by D-.

For more details refer to the DEL'D TB section.

Key sequence:

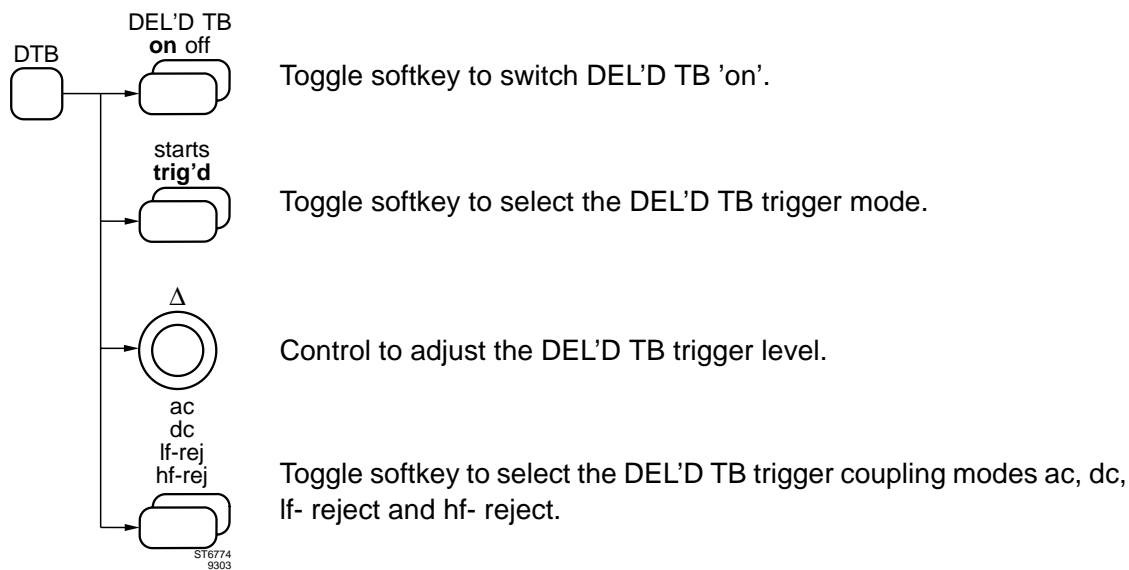

TRIGGER LEVEL

Description:

LEVEL selects the signal level at which the timebase will trigger. For triggering, the level must be within the peaks of the signal.

TRIGGER LEVEL sets the trigger level for the main timebase. In level-pp 'on' mode, the level range is clamped within the peak-peak values of the signal. Then the MTB will always be triggered as shown in the following figure. When level-pp is 'off', the level range is from -8 ... +8 divisions.

Leveling in DEL'D TB is adjusted with the Δ control. It is activated in the triggered DEL'D TB mode. The range is from -8 ... +8 divisions.

Leveling in DEL'D TB is adjusted with the Δ control. It is activated in the triggered DEL'D TB mode. The range is from -8 ... +8 divisions.

Trigger levels for MAIN TB and DEL'D TB can be displayed. Refer to the description of the UTILITY SCREEN & SOUND function.

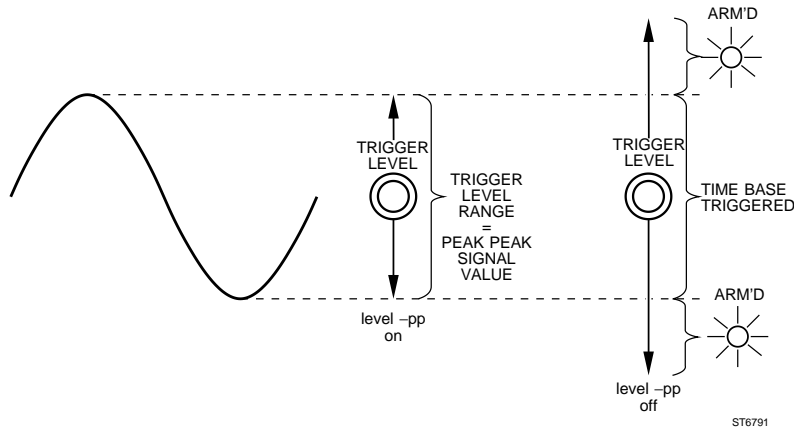

TRIGGER LEVEL control ranges in level-pp on and off

Key sequence:

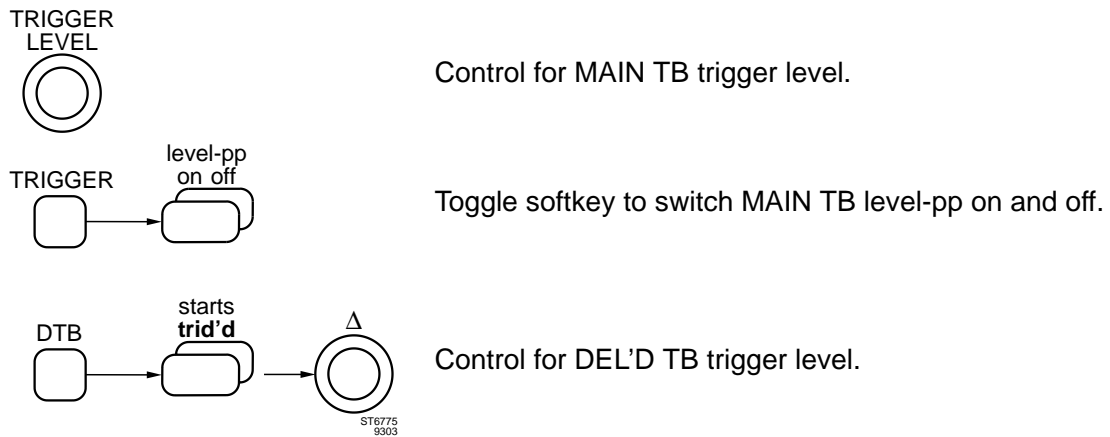

Remote commands:

CPL: TA (Command for trigger Acquisition)

Refer to chapter 6 for more details.

TRIGGER MAIN TB

Description:

This section deals only with 'edge' triggering of the MAIN TB. For TV triggering, Logic triggering or DEL'D TB triggering, refer to the appropriate sections.

In the **analog** mode triggering determines the start point of the MAIN TB sweep. The sweep starts at the moment the signal crosses the trigger level in positive or negative direction. The slope is selectable ($f \searrow$), as is shown in the figure below.

In the **digital** mode, the trigger system determines which part of the trace is acquired and placed in memory. As in every other Digital Storage Oscilloscope, signal acquisition through the ADC system is a continuous process, until it is stopped by the trigger signal. If nothing else would be done, the signal placed in memory would be the signal prior to the trigger moment and the trigger moment would be displayed at the end of the screen. For most oscilloscope users this would be confusing, since most users were taught that the trigger point determines the beginning of a sweep (as is the case for an analog scope).

Therefore, in actuality, a delay time equivalent to the time of one sweep length is added, so that it appears as if the trigger moment is displayed at the beginning of the screen.

The TRIGGER POSITION control allows you to change the time delay between the trigger point and the digital acquisition. If set to zero, the acquisition is stopped after a time equivalent to one sweep length has been added so that the trigger point appears at the beginning of the trace.

Any of the inputs can be used as the trigger source. The source is selected with the keys 'TRIG1, TRIG.. or EXT TRIG' in the respective control sections. The same keys are used to toggle between the positive (f) and negative (\searrow) slope. In the digital mode, dual slope (\times) is available. The oscilloscope must be set to 'REAL TIME ONLY' = yes in the TB MODE menu. Dual slope triggering can be selected only by the TRIGGER menu key and is restricted to the single shot modes. The medium level is adjusted by the TRIGGER LEVEL knob. The trigger gap between positive and negative slope is adjusted by the TRACK knob. For line frequency related signals, a Line trigger source is available. The Line trigger source is selected by a softkey under the TRIGGER menu key. The External Trigger input provides an extra trigger input. This input can be used as the trigger source for the Main TimeBase (MTB) and Delayed Time Base (DTB). The input characteristics are similar to the input channels. To reduce the effect on triggering on noisy signals, trigger filters can be used. For this, lf-rej or hf-rej can be selected.

Refer to TRIGGER COUPLING and TRIGGER LEVEL for details.

The MAIN TB trigger settings are selected in the menu under the TRIGGER menu key. The toggle softkey 'ch...line' selects the trigger source in combination with the keys TRIG1, TRIG.. and EXT TRIG that give direct front panel access to select the trigger source. This is combined with the slope selection.

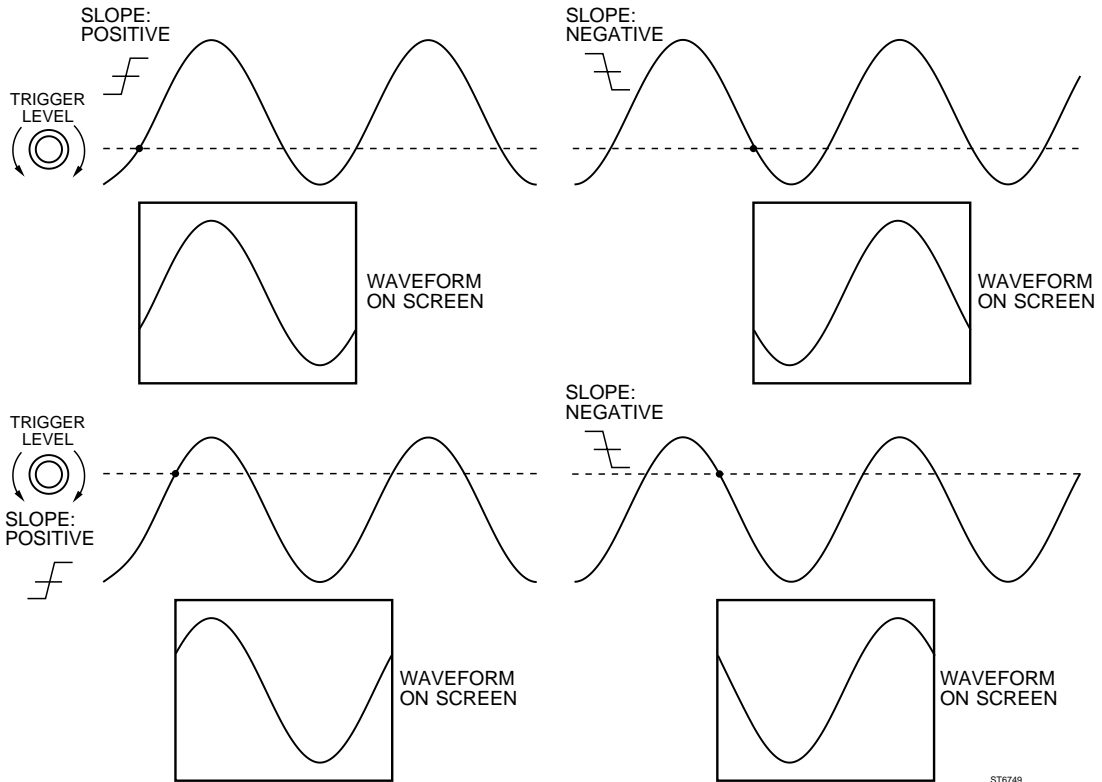

Function of TRIGGER LEVEL and slope

Key sequence:

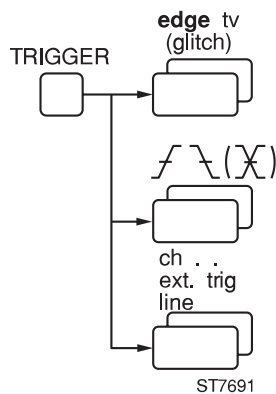

Toggle softkey to select edge or TV triggering. In digital mode also logic triggering.

Toggle softkey to select positive or negative trigger edge (slope). In digital mode also dual slope.

Toggle softkey to select MAIN TB trigger source. CH1 to CH4 are to be selected with TRIG1 to TRIG4.

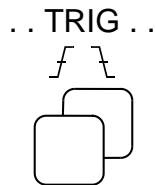

Toggle key to select CH1, CH.. or EXTTRIG as MAIN TB trigger source. Subsequent key presses cause the trigger slope to change between positive and negative trigger edge.

TV TRIGGER

Description:

In addition to edge and glitch triggering (explained under TRIGGER MAIN TB), there are extensive video triggering possibilities. These enable stable triggering on video frames and lines from various TV standards. There is no need to adjust the trigger level.

Triggering is possible on video signals with positive (pos) or negative (neg) signal polarity. Supported video standards include NTSC, PAL, SECAM, and HDTV. For HDTV systems a three-level sync trigger is used, and the line count of the system may be selected.

The MAIN TB can be triggered on a TV line (all lines are superimposed), or field 1 or field 2 of any of the four channels. In the field mode, the TRACK control can be used select triggering on any specific TV line for individual line display.

The TV trigger settings are selected from the menu under the TRIGGER menu key. TV trigger is not available when the optional External Trigger is selected as trigger source.

*Note: A trigger edge can **not** be selected*

Key sequence:

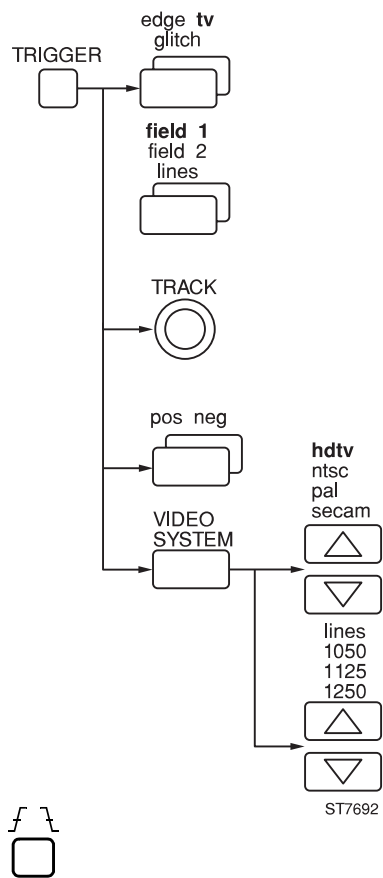

Toggle softkey to switch between edge and tv triggering. In digital mode also glitch triggering.

Toggle softkey to switch between TV triggering on field 1, field 2, or line sync pulses.

Control to select the line number.

Toggle softkey to select between pos(itive) and neg(ative) signal polarity.

Softkey pair for video system selection.

Softkey pair for selection of max. number of HDTV lines.

Selects the channel and toggles between pos(itive) and neg(ative) signal polarity (**no** edge selection)

USERTEXT

Description:

Two lines of user-definable text can be displayed in the CRT viewing area. The text may be useful as additional information when taking photographs. The selections are reached via the key sequence 'UTILITY >> SCREEN & SOUND >> USERTEXT >> on'.

The EDIT USER TEXT menu gives the following editing modes:

- The TRACK control determines the position where text has to be edited. The position is indicated by a flashing cursor.
- The Δ control is used for character selection.
- Softkey 'space' changes the character under the cursor into a space.
- Softkey 'delete' erases text under the cursor.
- Softkey 'insert' adds a space under the cursor.

Key sequence:

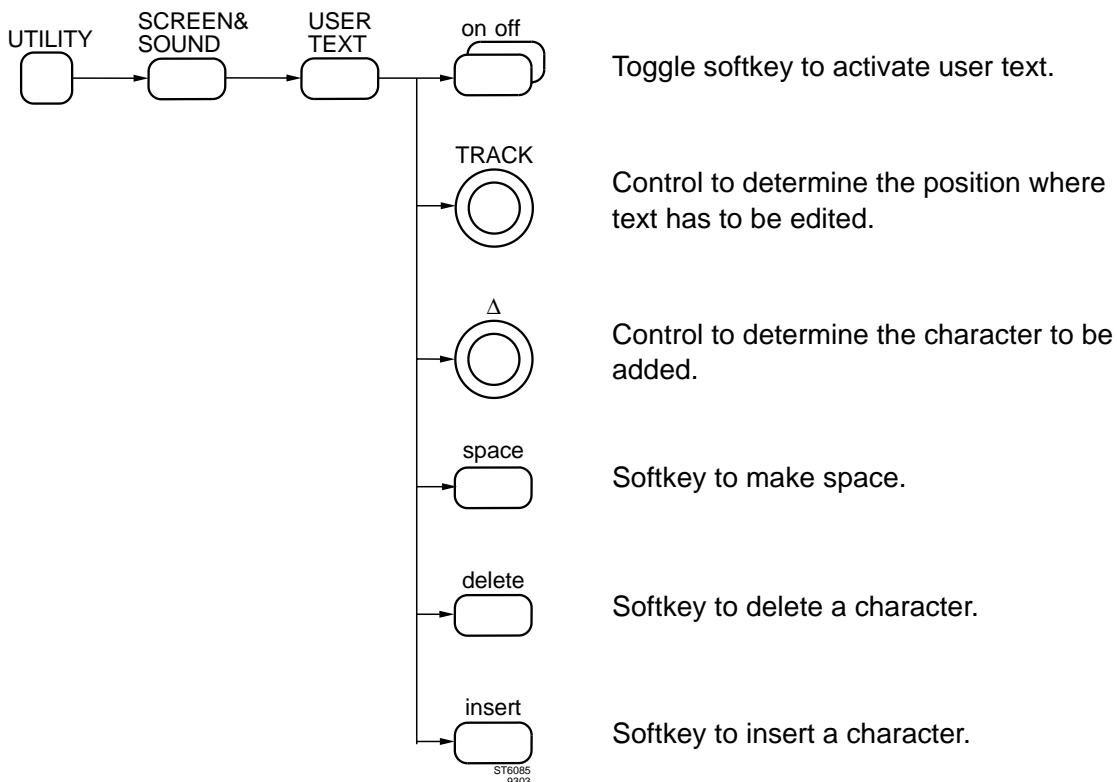

Remote commands:

CPL: PT (command to program user text)
 QT (command to query user text)

Refer to Chapter 6 for full details.

UTILITY MAINTENANCE

Description:

The UTILITY MAINTENANCE menu is used to calibrate the oscilloscope and for repair and testing. Calibration data is protected by a password and by operation of a pinhole switch that can be sealed. Calibration is of vital importance for the instrument's high accuracy. The menu is meant for calibration and for use by service technicians, and is therefore not explained in this Users Manual. An extensive description can be found in the Service Manual.

UTIL MENU

Description:

The UTIL menu is used to make presettings for instrument settings that do not need to be changed frequently:

- The operation of the AUTOSET key. For a description, refer to the AUTOSET and AUTOSET USERPROG functions.
- Selections in relation to probes. Refer to PROBE UTILITIES function for details.
- Amount of information in CRT viewing area and audio signals. Refer to the UTILITY SCREEN & SOUND function. The UTILITY SCREEN & SOUND menu has a dedicated submenu for usertext. See the USERTEXT function for more information.
- Presettings for the remote control interfaces. Refer to REMOTE CONTROL RS-232 and REMOTE CONTROL IEEE 488.2
- Presetting for suitable printer or plotter and real time clock adjustment.
- Settings for maintenance and repair such as tests and calibration data. Data affecting the instrument's accuracy can only be changed by entering a password. This is explained in detail in the Service Manual.

The UTILITY menu is reached via the UTILITY menu key. The following figure shows the structure of the UTILITY menu related to instrument operation.

Key sequence:

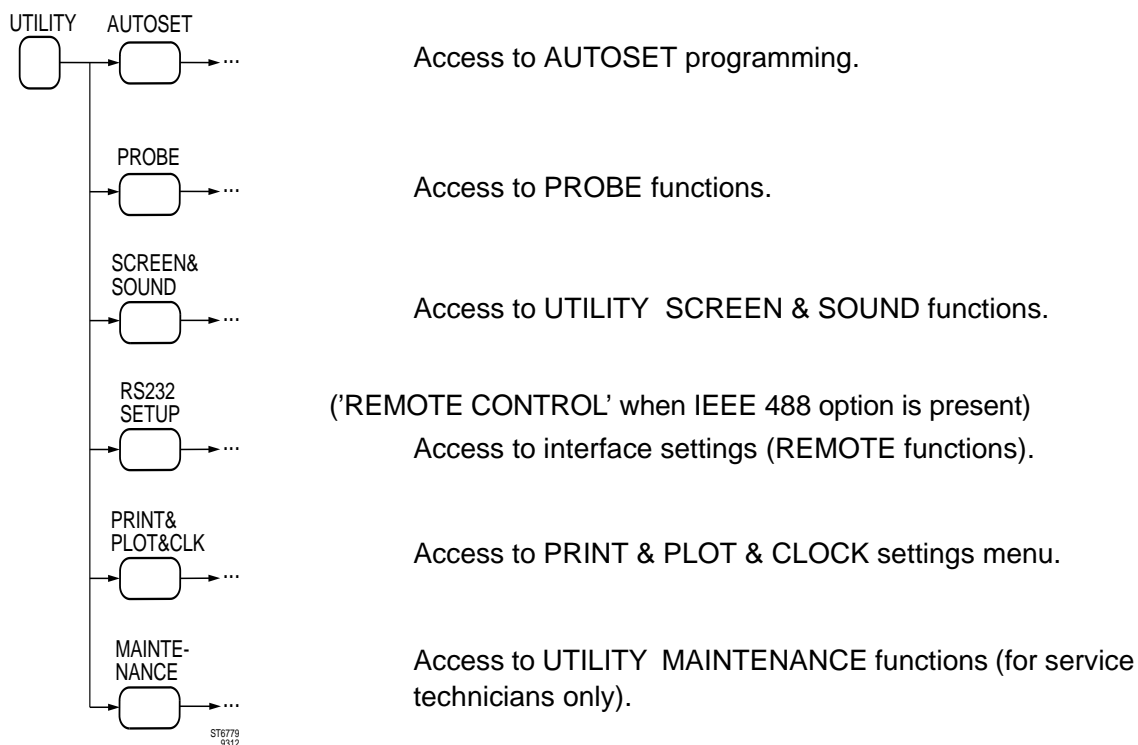

UTILITY SCREEN & SOUND

Description:

The UTILITY SCREEN & SOUND menu is used to select on-screen text, trigger and ground level indicators, and user text. Settings for acoustic feedback (beep and click) are set in this menu. The menu can be reached with the key sequence 'UTILITY >> SCREEN & SOUND'.

The following selections are possible:

- Trigger level indicators (TRIG IND) for MAIN TB and DEL'D TB. Level-pp and TV mode must be off. The horizontal marker is the level position.
- Ground level indicators (GND IND) for each channel are visible only when channel is on. The horizontal line is the ground level position.
- MAIN TB-int contrast between MAIN TB trace and intensified part is adjusted with the TRACK control.
- USERTEXT leads to a submenu for usertext. Refer to the function USERTEXT for more information.

The following audio signals are activated with the key sequence 'UTILITY >> SCREEN & SOUND >> SOUND':

- BEEP on off, the signal sounds to indicate messages or AUTOSSET.
- CLICK on of, the signal indicates operation of keys and rotary controls.

Key sequence:

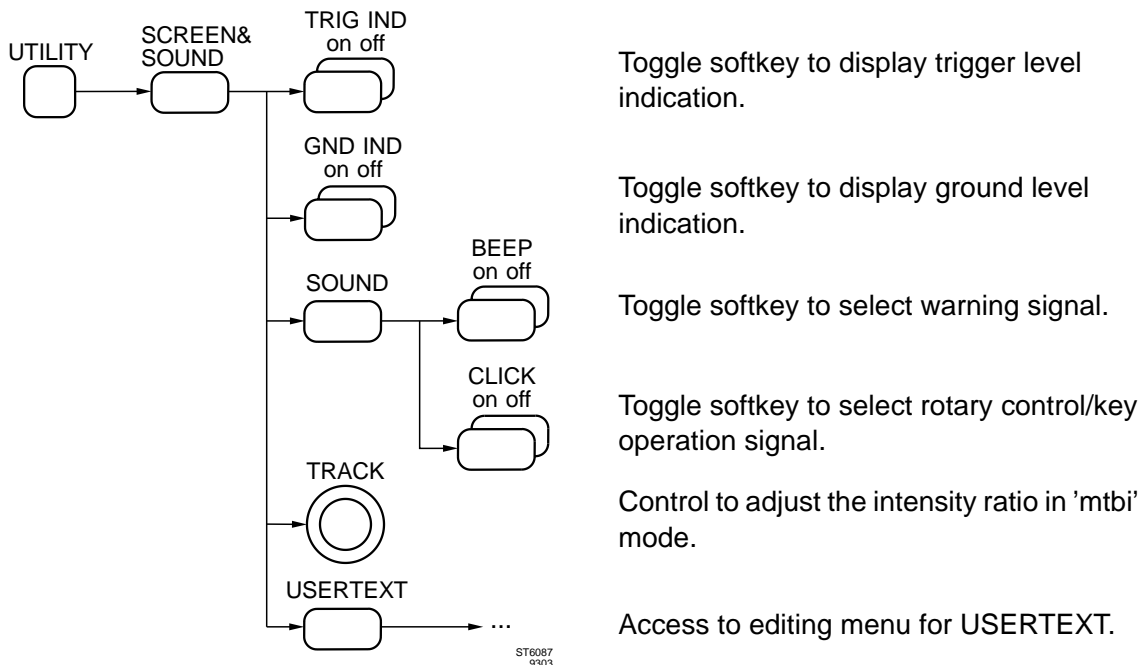

VOLT MEASUREMENTS

Description:

Voltage measurements can be made using the cursors or using automated, calculated measurement routines. Cursors operate in the **analog** mode as well as in the **digital** mode.

Calculated volt measurements are available in the digital mode only.

Using the cursors, three voltage readouts can be selected:

- ΔV gives the voltage difference between the cursors.
- V1&V2 gives the absolute voltage with respect to ground for each cursor.
- ΔV -ratio gives a percentage that can be reset by using the $\Delta V=100\%$ softkey.

For more details refer to the section CURSOR READOUT.

In the **digital** mode, the MEASURE menu provides automatic voltage measurements.

This menu is reached via the key sequence 'MEASURE >> MEAS 1(2) >> volt'.

The TRACK control is used to select the type of measurement, and the Δ control is used to select the waveform.

The result of the measurement is displayed in the top left corner of the screen.

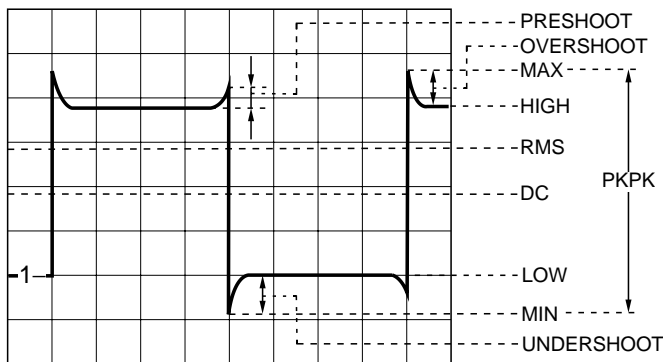

The following measurements are possible: (Refer to section MEASURE MENU for details of signal parameters).

- dc (DC VOLTAGE)

Measures the absolute dc level, related to the ground level of the signal. This is the average voltage of all samples in one period. If no full period is present, all input samples in the signal are included in the calculation.

$$dc = \frac{1}{k-j+1} \times S(n)$$

where: j = 1st mesial crossing [first sample if no full period]
 k = 3rd mesial crossing [last sample if no full period]
 $S(n)$ = nth sample ($j \leq n \leq k$)

ST6670

- rms (ROOT MEAN SQUARE VOLTAGE)
Measures the rms value within one period, related to the ground level of the signal. If no full period is present, all input samples are included in the calculation.

$$\text{rms} = \sqrt{\frac{1}{k-j+1} \times S(n)^2}$$

where: j = 1st mesial crossing [first sample if no full period]
 k = 3rd mesial crossing [last sample if no full period]
 S(n) = nth sample (j<=n<=k)

- min (MINIMUM VOLTAGE)
Measures the minimum voltage level of the signal, including undershoot. It is calculated over all samples of the displayed signal.

$$\text{min} = \min \{S(n)\}$$

where: S(n) = nth sample

- max (MAXIMUM VOLTAGE)
Measures the maximum voltage level of the signal, including overshoot. It is calculated over all samples of the displayed signal.

$$\text{max} = \max \{S(n)\}$$

where: S(n) = nth sample

- pkpk (PEAK-TO-PEAK VOLTAGE)
Measures the peak-to-peak voltage (the difference between the absolute minimum voltage and absolute maximum voltage of the signal).

$$\text{pkpk} = \text{max} - \text{min}$$

- low (LOW LEVEL)
Measures the low level of the signal. The number of samples for each amplitude level is counted. A peak in the number of samples at one level indicates the low level and is referred to 0% level. If no such point is present (e.g., sine wave), it is equal to the minimum voltage.
- high (HIGH LEVEL)
Measures the high level of the signal. The number of samples at each amplitude level is counted. A peak in the number of samples at one level indicates the high level and is referred to the 100% level. If no such point is present (e.g., sine wave), the high level is equal to the maximum voltage.

- oversh (OVERSHOOT)
Measures the overshoot (in %), related to the amplitude of the signal. There are two types of overshoot: rising overshoot and falling overshoot (undershoot).

$$\text{rising overshoot} = \frac{\text{max (of 1st rising slope) - high}}{\text{high - low}} * 100\%$$

$$\text{falling overshoot} = \frac{\text{low - min (of 1st falling slope)}}{\text{high - low}} * 100\%$$

- presh (PRESHOOT)
Measures the preshoot (in %), related to the amplitude of the signal. There are two types of preshoot: rising preshoot and falling preshoot.

$$\text{rising preshoot} = \frac{\text{low - min (of 1st rising slope)}}{\text{high - low}} * 100\%$$

$$\text{falling preshoot} = \frac{\text{max (of 1st falling slope) - high}}{\text{high - low}} * 100\%$$

It is possible to perform measurements on the part of the waveform between the two cursors. This function is called cursor limited measurements and is turned on via the key sequence MEASURE >> CURSOR LIMIT & STATIST >> CURSOR LIMITED yes. Cursor operation is done via the TRACK and Δ controls and via the CURSOR menu.

Results of the measurements MEAS1 and MEAS2 are displayed in the top left corner of the screen. When you press the key sequence MEASURE >> CURSOR LIMIT & STATIST >> STATIST on, the screen displays three values per MEAS function. These values are measured over the total number of acquisitions for that particular measurement and are updated instantly. The statistic measurement values are as follows:

- absolute minimum value
- absolute maximum value
- mean value

Key sequence:

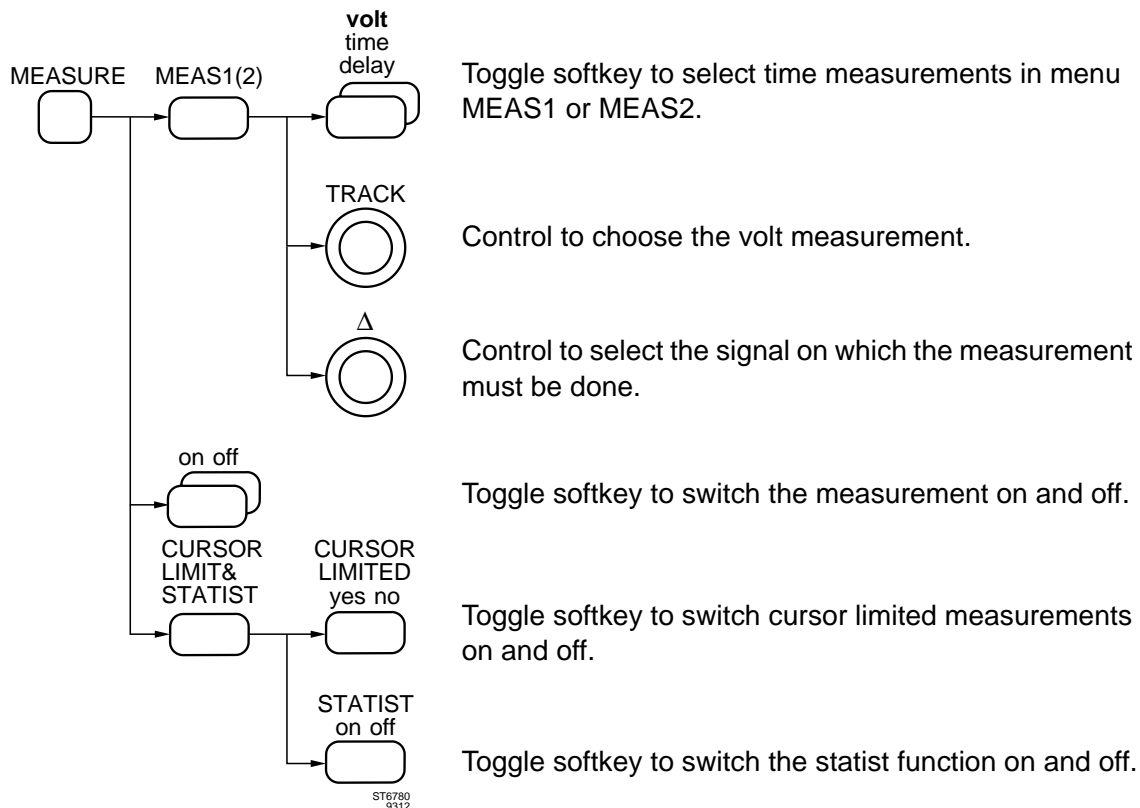

Remote commands:

CPL: QM (Command to query a measurement)

Refer to Chapter 6 for full details.

X-DEFLECTION (X-DEFL, X vs Y)

Description:

X-deflection creates X-Y displays in which one input signal is displayed as function of another. To obtain X-Y displays in the **analog** mode, the oscilloscope can be set to X-DEFlection mode. In the **digital** mode a similar function is called X vs Y mode. In both cases a display of amplitude vs amplitude instead of the display of amplitude vs time is visible.

In the **analog** mode, X-DEFL uses a signal from one of the input channels for horizontal direction. Also the line voltage or EXT TRIG channel can be used for X-deflection. Any of the input channels can be selected for vertical deflection.

In the **digital** mode, X vs Y also uses a signal from one of the input channels. X vs Y displays can also be displayed from signals previously stored in memory. In this case the memory register (e.g., m3) must first be selected with the TRACK control. The horizontal deflection source can then be any of the active trace registers (e.g., m3.2).

The selections are made in the DISPLAY menu under the X-DEFL or X vs Y menu softkey. After the function is switched 'on', the source selection becomes visible. In all cases the active X deflection source is displayed at the bottom right of the screen and the Y deflection source(s) at the bottom left of the screen.

To achieve correct scaling and positioning, use the channel AMPL front panel key pair, their POS controls and the XPOS control in the analog mode. For the digital mode, use the VERT MAGNIFY under the DISPLAY menu and the XPOS control.

Key sequence:

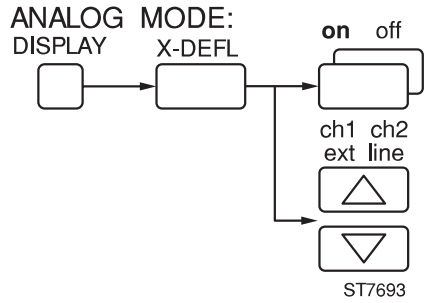

Toggle softkey to switch X- Deflection on.

Softkey pair to select X-DEFL source. Selection is possible only with X- DEFLECTION on.

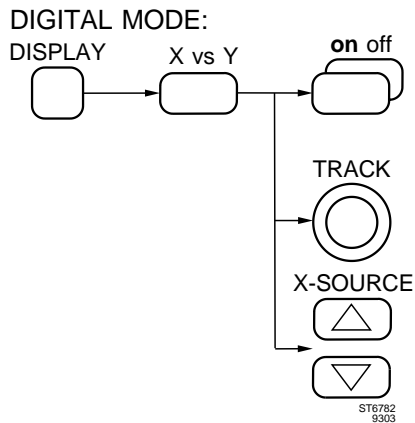

Toggle softkey to switch X vs Y on.

Control to select the register as source for vertical deflection. Selection is possible only with X vs Y on.

Softkey pair to select source for horizontal deflection. Selection is possible only with X vs Y on.

6 THE CPL PROTOCOL

6.1 INTRODUCTION

The oscilloscope can be controlled via the RS-232 serial interface using the Compact Programming Language (CPL) protocol. In this protocol a small but very powerful set of commands is defined.

The main characteristics of the CPL protocol:

It is kept simple and straightforward and is fully tailored to use simple communication facilities like those of BASIC.

Special emphasis is put on the ease of programming:

- easy input format with a 'forgiving' syntax:
 - Commands always consist of two characters that can be **upper or lower** case.
 - Parameters that sometimes follow the command may be separated from it by **one or more** separation characters.
- strict and consistent output format:
 - Alpha character responses are always in UPPERCASE.
 - Parameters are always separated by only one comma ("," = ASCII 44).
 - Responses always end with a carriage return (CR = ASCII 13).
- synchronization between input and output
 - After receipt of every command, CPL returns an acknowledge character and a carriage return (CR = ASCII 13), to indicate reception and/or execution of the command.

Commands

All commands consist of a header of two alpha characters. Some of the commands are followed by parameters to give the oscilloscope more information. The parameters are separated from one another by a PROGRAM DATA SEPARATOR <pds>. At the end of the complete command (i.e., header and parameters) comes the PROGRAM MESSAGE TERMINATOR CR. After the CR is recognized by the oscilloscope, the command will be executed. Then an <acknowledge> and CR is sent to signal the end of the command processing.

- Notes:*
- *Literal characters are placed between double quotes, e.g. "AS".*
 - *Literal characters may be specified in upper and lower case.*

There are several IMPLICIT QUERY commands, which means that the oscilloscope will send data back (i.e., respond) to the computer after receiving and executing the command.

Acknowledge

The <acknowledge> is an automatic response from the oscilloscope to let the computer know that the received command has been executed. The <acknowledge> also contains information about how the command was executed.

An <acknowledge> is always followed by a CR. For more information, see section 6.6 ACKNOWLEDGE.

Responses

The format of the response data depends on the command which invoked the response. When several values or strings are returned they are always separated with a RESPONSE DATA SEPARATOR which is a comma ("," = ASCII 44). To signal the end of the response a RESPONSE MESSAGE TERMINATOR CR (ASCII 13) is sent.

Data Separators

Data Separators are used between parameters sent to the oscilloscope and between values and strings received back from the oscilloscope. The following list gives the possibilities for data separators:

program data separator

space SP (ASCII 32) *)
tab HT (ASCII 9) *)
comma , (ASCII 44)

*) more than one space or more than one tab can be used as a separator

response data separator

comma , (ASCII 44)

Message Terminators:

At the end of a command or response a terminator must be sent. For both programming and response messages the terminator has been defined as:

program message terminator

carriage return CR (ASCII 13)

response message terminator

carriage return CR (ASCII 13)

6.2 EXAMPLE PROGRAM FRAME

In the COMMAND REFERENCE SECTION a very short programming example is given for each command. All examples are written in GW-Basic and able to run on an IBM-compatible PC. The example program expects the oscilloscope to be connected via COM1 port (RS-232) with a RS-232 null modem cable and to be setup at 9600 baud, 8 databits, no parity, 3 wire, xon/xoff = off (Menu UTILITY).

The following program lines are an example frame work. The frame work lets you embed any of the example programs shown in the COMMAND REFERENCE SECTION.

Program frame:

```
10 OPEN "COM1:9600,N,8,1, CS0, DS0, CD0" AS #1:'open serial port *)
```

... Insert Example Programs Here

```
999 END
1000 '- synchronize on acknowledge & handle error:
1010 INPUT#1,ACK
1020 IF (ACK=0) THEN GOTO 1110
1030 IF (ACK<0) OR (ACK>4) THEN GOTO 1100
1040 PRINT "ERROR: ";ACK;
1050 ON ACK GOTO 1060,1070,1080,1090
1060 PRINT "SYNTAX ERROR"           : END
1070 PRINT "EXECUTION ERROR"        : END
1080 PRINT "SYNCHRONISATION ERROR"  : END
1090 PRINT "COMMUNICATION ERROR"    : END
1100 PRINT "UNKNOWN ACKNOWLEDGE"    : END
1110 RETURN
```

First the serial port of the PC is opened (line 10) with the settings of the oscilloscope communication parameters **)

Following that, the example program lines from the COMMAND REFERENCE SECTION can be executed.

The subroutine to synchronize on the <acknowledge> returned from the oscilloscope starts at line 1000.

*) The oscilloscope communication parameters are stored in battery backup memory when the oscilloscope is turned off. On power-up the parameters are restored.

6.3 COMMANDS IN FUNCTIONAL ORDER

group	name	command
Communication	Program Communication	PC
Setup	Auto Setup	AS
	Default Setup	DS
	Program Setup	PS
	Program text	PT
	Query Setup	QS
	Query text	QT
	Recall Setup	RS
	Save Setup	SS
	Calibrate	CL
States	Go to Local	GL
	Go to Remote	GR
	Local Lockout	LL
Measurement	Arm Trigger	AT
	Program Waveform	PW
	Query measurement	QM
	Query Waveform	QW
	Trigger Acquisition	TA
	Query Print	QP
Miscellaneous	IDentification	ID
	RReset Instrument	RI
	SStatus query	ST

6.4 COMMANDS IN ALPHABETICAL ORDER

command	name
AS	Auto Setup
AT	Arm Trigger
CL	Calibrate
DS	Default Setup
GL	Go to Local
GR	Go to Remote
ID	IDentification
LL	Local Lockout
PC	Program Communication
PS	Program Setup
PT	Program text
PW	Program Waveform
QS	Query Setup
QM	Query measurement
QP	Query Print
QT	Query text
QW	Query Waveform
RI	Reset Instrument
RS	Recall Setup (internal)
SS	Save Setup (internal)
ST	STatus query
TA	Trigger Acquisition

6.5 COMMAND REFERENCE

In this section all commands of the CPL protocol available in the oscilloscope are described in alphabetical order.

All command descriptions have the same layout:

NAME	NM
------	----

Purpose:

Explains the command, its parameters and limitations.

Command:

Shows the syntax for the programming command. The parameters are separated by one or more PROGRAM DATA SEPARATORS <pds>. Commands are terminated by a Carriage Return (CR).

Response:

Shows the format of the response coming from the oscilloscope. Responses are terminated by a Carriage Return (CR).

The oscilloscope will <acknowledge> after the receipt of each programmed command. This acknowledgment indicates the status of the oscilloscope after command execution. For more information refer to section 6.6 (ACKNOWLEDGE).

To obtain a more detailed status description, the status can be fetched with the ST command.

Example:

Example lines of programming code are used to demonstrate the function of the **CPL** commands. The examples as shown can be embedded in the Program Frame mentioned in section 6.2.

AUTOSET

AS**Purpose:**

To start the AUTOSET function. With this command the oscilloscope will select the optimum settings (volts, time base, trigger mode, etc.) for the connected signal(s).

The AutoSet (AS) command performs the same function as pressing the front panel AUTOSET button.

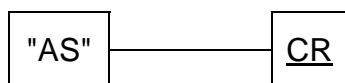
Command:**Response:**

Note: The <acknowledge> will be sent after the AUTOSET has been fully completed.

Example:

```
100 PRINT #1,"AS"      : 'Send command
110 GOSUB 1000         : 'Sync on acknowledge
```

ARM TRIGGER

AT**Purpose:**

Will reset the timebase and rearm the triggering for a new timebase trigger. Issuing this command during a time base sweep will immediately stop the sweep, reset the timebase and rearm the triggering.

The Arm Trigger (AT) command performs the same function as pressing the frontpanel SINGLE-ARM'D button.

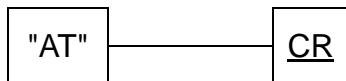
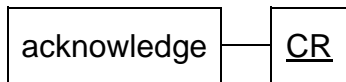
Command:**Response:****Example:**

```
100 PRINT #1, "AT"      : 'Send command
110 GOSUB 1000          : 'Sync on acknowledge
```

CALIBRATE

CL

Purpose:

To start the internal Auto-Calibration procedure. This procedure optimizes the input, trigger and time base circuitry of the oscilloscope. This calibration takes approximately one minute and completion is signalled by the acknowledge.

The Calibrate (CL) command performs the same function as pressing the front panel CAL button for more than 2 seconds.

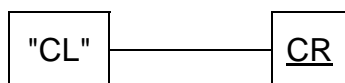
Command:**Response:**

Note: The <acknowledge> will be sent after the calibration has been fully completed. A detailed error report may be queried for using the ST command (only if acknowledge is not zero).

Example:

```
100 PRINT #1,"CL"      : 'Send command
110 GOSUB 1000         : 'Sync on acknowledge
```

DEFAULT SETUP

DS**Purpose:**

Sets the oscilloscope to the default setup conditions.

The Default Setup (DS) command performs the same function as pressing the TEXT OFF and STATUS/LOCAL buttons simultaneously.

The communication interface parameters will not be changed.

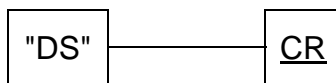
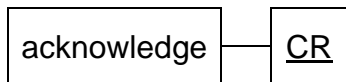
Command:**Response:**

Note: The <acknowledge> is sent after the completion of the change to the default setups.

Example:

```
100 PRINT #1,"DS"      : 'Send command
110 GOSUB 1000         : 'Sync on acknowledge
```

GO to LOCAL**GL****Purpose:**

Puts the oscilloscope in the Local State. In the Local State, all oscilloscope functions are accessible via the front panel buttons and knobs.

The Go to Local (GL) command performs the same function as pressing the STATUS/LOCAL key on the front panel of the oscilloscope, when the oscilloscope is in the Remote State (Refer also to "Go to Remote" and "Local Lockout").

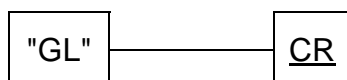
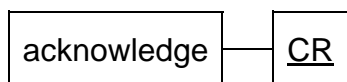
Command:**Response:****Example:**

```
100 PRINT #1, "GL"      : 'Send command
110 GOSUB 1000          : 'Sync on acknowledge
```

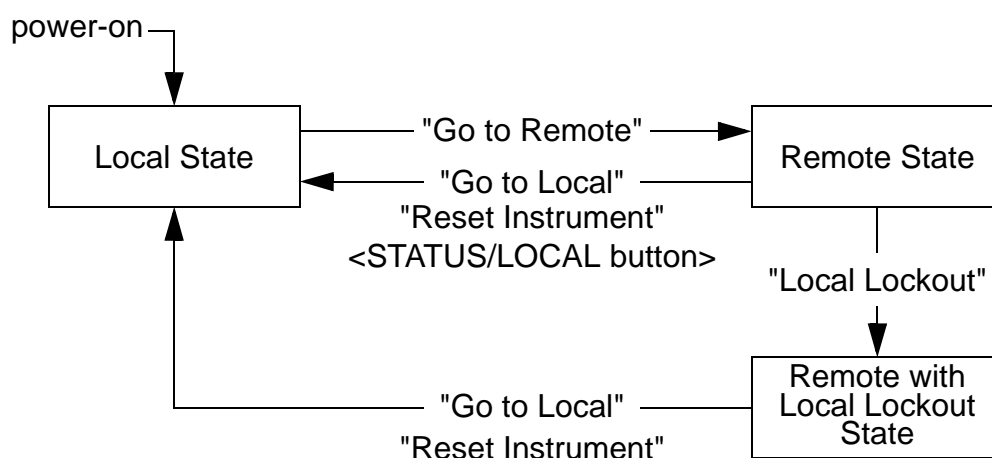
Local, Remote, Remote+Local Lockout States

GO to REMOTE**GR****Purpose:**

Puts the oscilloscope in the Remote State. In the Remote State none of the oscilloscope functions are accessible via the front panel buttons and knobs.

Going back to the Local State is achieved by sending the Go to Local (GL) command or by pressing the STATUS/LOCAL key on the frontpanel (Refer also to "Local Lockout" and "Go to Local").

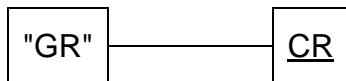
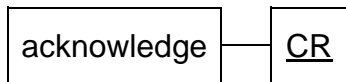
Command:**Response:****Example:**

```
100 PRINT #1,"GR"      :'Send command
110 INPUT #1,ACK       :'Sync on acknowledge
```

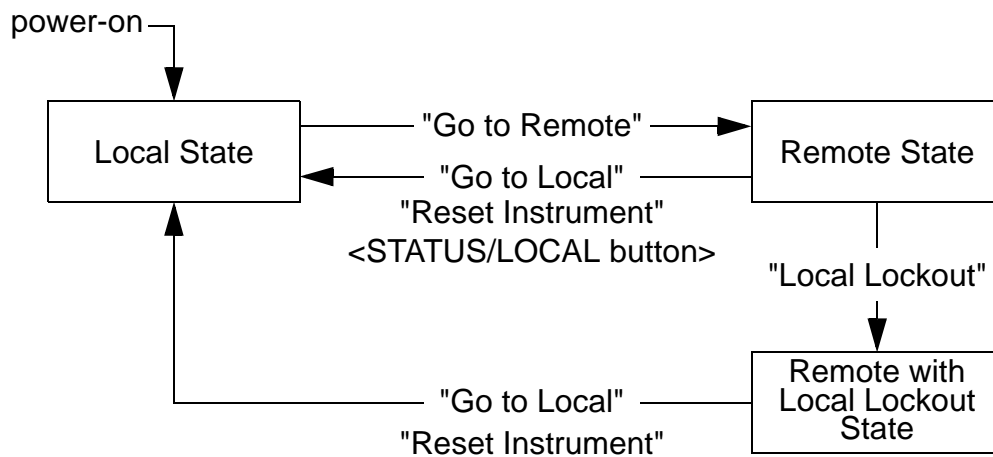
Local, Remote, Remote+Local Lockout States

IDENTIFICATION

ID**Purpose:**

Returns the identification of the oscilloscope. It gives information about the model number, the version numbers of all software modules and the installed options.

This Identification (ID) command gives the same information as can be read from the oscilloscope screen after pressing the frontpanel knob UTILITY and the softkey MAINTENANCE.

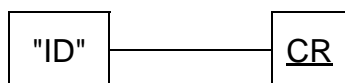
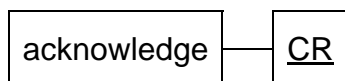
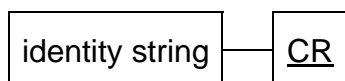
Command:**Response 1:****Response 2:**

Note: The items in the identity string are separated by a ';' (ASCII 59)

Example:

```
100 PRINT #1,"ID"      : 'Send command
110 GOSUB 1000         : 'Sync on acknowledge
120 INPUT #1,ID$      : 'Input Identity string
130 PRINT ID$         : 'Print Identity string
```

example response:

```
FLUKE;PM 3380B;0;SW3394BI V4.0 1996-10-02;UHM V1.0;UFO V2.0;IEEE;EMCR  
└─ 1 ─┘ └─ 2 ─┘ └────────────────── 3 ───────────────────┘ └─ 4 ─┘ └─ 5 ─┘ └─ 6 ─┘
```

- 1 - manufacturer
- 2 - model number of the oscilloscope
- 3 - information about the oscilloscope software
- 4 - information about the micro-controller software
- 5 - information about the frontpanel control software
- 6 - information about installed options, e.g.:
 - IEEE (IEEE interface)
 - EXT (External Trigger option; only in 4 channel models)
 - EM (Extended Memory)
 - MP (Math Plus)

LOCAL LOCKOUT

LL

Purpose:

This instruction will inhibit the Go to Local function of the STATUS/LOCAL key on the frontpanel.

Once activated, the Local Lockout State is disabled by sending the Go to Local (GL), the Reset Instrument (RI) command or by cycling power OFF and ON.
(Refer also to "Go to Remote" and "Go to Local").

There is no front panel equivalent for this command.

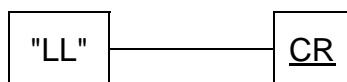
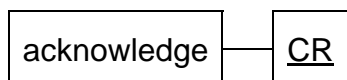
Command:**Response:****Example:**

```

100 PRINT #1,"LL"      : 'Send Command
110 GOSUB 1000         : 'Sync on acknowledge
  
```

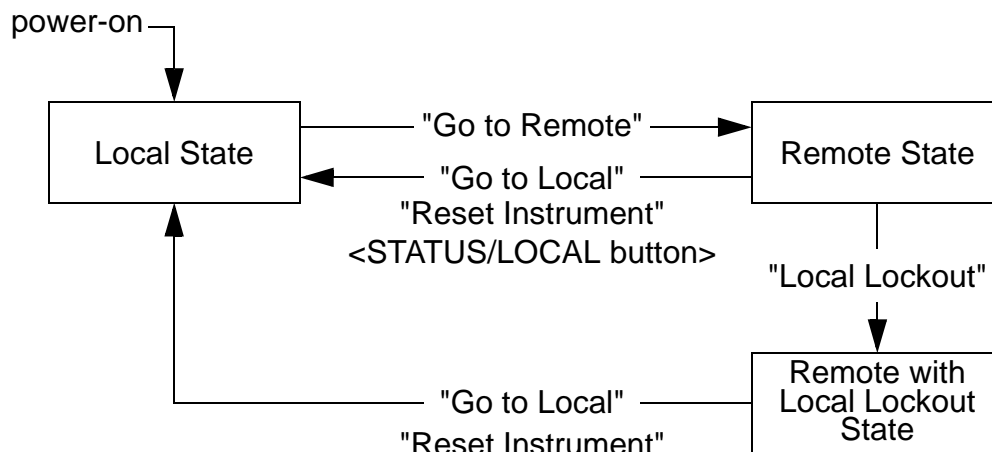
Local, Remote, Remote+Local Lockout States

PROGRAM COMMUNICATION**PC****Purpose:**

To program baudrate, parity mode, number of data and stopbits and the handshake method for computer communication.

After the command is sent, an <acknowledge> will be returned with the old communication parameters still active.

If the <acknowledge> = 0, the new communication parameters will be valid approximately 0.5 seconds later. The communication parameters are stored in battery backup memory and restored on power-up.

This command performs the same function as the UTILITY + RS232 SETUP menu.

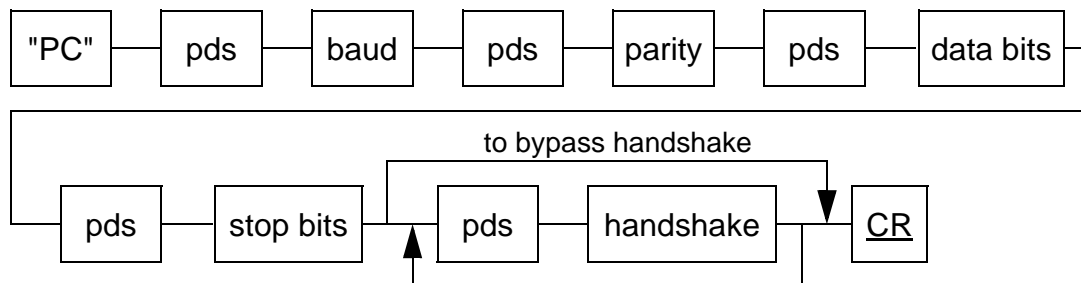
Command:

<baud> = 75, 110, 150, 300, 600, 1200, 2400, 4800, 9600, 19200, 38400
 <parity> = O, E or N
 <data bits> = 7 or 8
 <stopbits> = 1
 <handshake> = XONXOFF to enable Xon/Xoff handshake
 HWL to enable hardwareline handshake
 If left out, both handshake methods are disabled.

Response:

Note: approx. 0.5 sec after an <acknowledge> = 0 is received, the communication parameters are changed to the new values.

Example:

```
100 PAR$="2400,N,8,1"           : 'comm parameters
110 CTL$=" ,XONXOFF"           : 'XONXOFF handshake
120 PRINT #1, "PC", PAR$, CTL$ : 'Send command
130 GOSUB 1000                 : 'Sync on acknowledge
140 CLOSE #1                   : 'Close the COM Port,
150 WT=TIMER
160 WHILE (TIMER-WT) < .5 : WEND : 'Wait 0.5 second
170 COMM$ = "COM1:" + PAR$ + ",CS0,DS0,CD0"
180 OPEN COMM$ AS #1           : 'Reprogram COM Port
```

PROGRAM SETUP**PS****Purpose:**

To configure the oscilloscope using compact setup strings.

This Program Setup (PS) command and the Query Setup (QS) command can be used together to restore and retrieve a complete setup or partial of the oscilloscope.

The format of the programming strings must be the same as the format of the received setup strings. Each setup string describes a "node" in the oscilloscope setup.

It is possible to send back partial setups because the setup nodes can be send individually.

(Refer to "Query Setup" and section 6.8 SETUP)

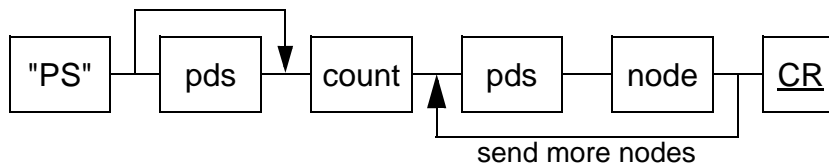
Command:

<count> number of node strings to follow.
 <node> string of hexadecimal characters (0..9,A..F) representing a
 setup node in the oscilloscope.

Response:

Note: The <acknowledge> is sent after the setup has been completed.

Example:

```

100 PRINT #1,"PS";                                : 'Setup command
110 PRINT #1,N;                                    : '# of strings
120 FOR I=1 TO N
130 PRINT #1," ";SETUP$I;                        : 'Send strings sep'd by SP **)
140 NEXT I
150 PRINT #1,""                                    : 'Send CR to end the setup
160 GOSUB 1000                                    : 'Sync on acknowledge
  
```

**) These are the strings that are received after a Query Setup (QS) command

PROGRAM TEXT**PT****Purpose:**

To program text to an oscilloscope.

If the **S** parameter is specified, setup text is programmed. The text will be set into one of the setup registers of the oscilloscope. The parameter **n** specifies the setup register. A maximum number of 22 characters is allowed. The remainder of the text field is set to 'spaces'.

If the **S** parameter is not specified, user text is programmed. The text will be displayed on the screen of the oscilloscope. A maximum number of 64 characters is allowed. The remainder of the text field is set to 'spaces'. The parameter **n** may not be used.

The programmed text can be read with the Query Text (QT) command.

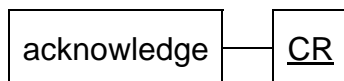
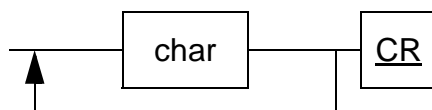
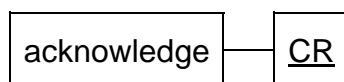
Command 1:**Response 1:****Command 2:****Response 2:**

- "S" setup text will be specified for register n; if "S" and n are left out, user text is specified
- n one of the setup registers, ranging from 0 to 10; n=0 selects the current setup
- char a character byte; range = 0 to 12, 14 to 255 (refer to character code table 6.1)

The following table contains the decimal codes of the character set for the screen of an oscilloscope:

CHAR	CHARACTER DESCRIPTION
0 .. 12	Control up/down character (conform char. 127)
13	Command terminator ASCII <u>CR</u> (may not be used)
14	Control up/down character (conform char. 127)
15 and 16	Positive and negative slope characters
17 and 18	Positive and negative pulse characters
19	Dual slope character
20	Special marker (X)
21, 22, 23	Delta, degrees, micro characters
24 and 25	Low impedance (low_z) and omega (Ohm) characters
26 and 27	Arrow up and down (char. 27 is also <u>ESC</u> character)
28 and 29	AC and ground (channel coupling) characters
30	Register off (but filled) character
31	Filled o character
32	ASCII space character
33 .. 35	ASCII characters ! " #
36	External Trigger char character E _T
37 .. 39	ASCII characters % & '
40 .. 47	ASCII characters () * + , - . /
48 .. 57	ASCII characters 0 1 2 3 4 5 6 7 8 9
58 .. 64	ASCII characters : ; < = > ? @
65 .. 77	ASCII characters A B C D E F G H I J K L M
78 .. 90	ASCII characters N O P Q R S T U V W X Y Z
91 .. 95	ASCII characters [\] ^ _
96	Menu selection indication
97 .. 109	ASCII characters a b c d e f g h i j k l m
110 .. 122	ASCII characters n o p q r s t u v w x y z
123	Menu return indication
124	character
125 and 126	Menu rocker key up and down characters
127	Control up/down character (◆)
128 .. 255	Control up/down character (conform char. 127)

Table 6.1 Character code table for oscilloscopes.

Examples: (of user text)

- 1) Program the following user text to be displayed on the screen of the oscilloscope: **Measurement 15**

```

100 PRINT #1,"PT"           : 'Program user Text command
110 GOSUB 1000              : 'Sync on acknowledge
120 PRINT #1,"Measurement 15": 'Send user text
130 GOSUB 1000              : 'Sync on acknowledge

```

- 2) In the next example user text, containing non-keyboard characters ($\Omega=25$ decimal and $s=125$ decimal), is programmed to be displayed on the screen of the oscilloscope, e.g.: **Ohm(Ω),Up(s)**.

```

100 PRINT #1,"PT"           : 'Program user Text command
110 GOSUB 1000              : 'Sync on acknowledge
120 PRINT #1,"Ohm(" ;CHR$(25);"),Up(" ;CHR$(125);"). "
                            : 'Send user text
130 GOSUB 1000              : 'Sync on acknowledge

```

Example: (of setup text)

Program the following text to set up register 7 of the oscilloscope:
1.25 k Ω (CH1)

```

100 PRINT #1,"SS 7"         : 'Save Setup command
110 GOSUB 1000              : 'Sync on acknowledge
120 PRINT #1,"PT S 7"       : 'Program setup Text command
130 GOSUB 1000              : 'Sync on acknowledge
140 PRINT #1,"1.25 k" ;CHR$(25);" (CH1)"
                            : 'Send setup text
150 GOSUB 1000              : 'Sync on acknowledge

```

PROGRAM WAVEFORM

PW**Purpose:**

To send a waveform to the oscilloscope. This function is referred to as to **P**rogram a complete **W**aveform in the oscilloscope.

A waveform is sent (programmed) in two command sequences. The first sequence selects the waveform register number, programs the waveform administration data, and programs the number of samples. The second sequence programs the samples, including a checksum. Each sequence is synchronized by an acknowledge response.

You can use the **PW** command to send the data received with the **QW** command back to the oscilloscope.

Note: The number of data bits of the RS-232 interface must be 8 (not 7), otherwise, an execution error will occur.

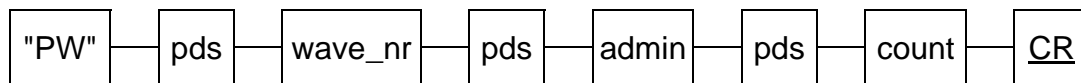
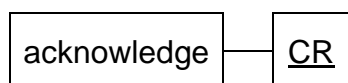
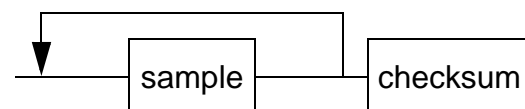
Command 1:**Response 1:****Command 2:****Response 2:**

wave_nr The oscilloscope waveform destination:
 011 - 084 for m1.1 - m8.4 01e - 08e for m1.e - m8.e
 091 - 504 for m9.1 - m50.4 (Extended Memory only)
 09e - 50e for m9.e - m50.e (Extended Memory only)
 (xx.e for 2 ch. models only; xx.3 and xx.4 for 4 ch. models only)

admin 16 parameters, separated by a "pds":

PARAMETER	TYPE	EXAMPLE	ACTION BY	OSCILLOSCOPE NOTES
trace_name	string	m4.1	ignored	
Y_unit	string	V	interpreted	
X_unit	string	s	interpreted	
Y_zero	number	+3	interpreted	
X_zero	number	-8.625E-6	ignored	
Y_resolution	number	78.13E-3	interpreted	
X_resolution	number	1E-6	interpreted	
Y_range	number	65535	ignored	
date	string	25-01-1994	interpreted	3)
time	string	17:10:25:40	interpreted	4)
dT-corr	number	375E-3	interpreted	1)
min/max	number	0	interpreted	2)
mult_shot_tot	number	32	interpreted	
mult_shot_nr	number	5	interpreted	
reserved	string	0	ignored	
reserved	string	0	ignored	

Notes:

- 1) $dT = dT\text{-corr} * X\text{-resolution}$
- 2) 1 = min/max trace envelopes 0 = waveform trace
- 3) date format: European = E25-01-1994
 American = A01-25-1994
 Japanees = J1994-01-25
 for compatibility reasons (initial versions)
 European format without leading character can
 be used.
- 4) for compatibility reasons (initial versions) hundreds of
 seconds can be omitted

count The number of samples in the waveform:
 512, 1024, 2048, 4096, 8192, 16384 or 32768
 (Extended Memory: 2048 and higher)

sample 2 bytes (Most Significant Byte + Least Significant Byte), representing the 16 bit sample value (bit 16 = -32768, bit 15 = 16384, ..., bit 1 = 1). Range: -32k (down) to +32k (up)

Example: 1000000011000111 = value -32569

byte 1	byte 2
--------	--------

byte 1 = 128 (value -32768)

byte 2 = 128+64+4+2+1 = 199 (value +199)

checksum 1 byte checksum of all sample bytes
(add one by one; result modulus 256)

Example:

In this example, a waveform of 512 points is generated in the computer and sent to the oscilloscope. The display of the waveform on the oscilloscope screen consists of two sine waves (amplitude = ± 3 vertical divisions and period (2π) = 5 horizontal divisions). The Y-scale will be set at 500 Volts per division, and the X-scale at 50.0 μ s per division. The following values can be calculated from these settings:

- The number of waveform amplitude points = 3 divisions * 6400 points/div. = 19200 (used in the example program)
- The number of waveform time points = trace length (512) / 2 * 2π) = 40.744 (used in the example program)
- $\langle Y_resolution \rangle = \frac{500 \text{ V/div.}}{6400 \text{ dots/div.}} = 78.13\text{E-}3\text{V}$
- $\langle X_resolution \rangle = \frac{50 \mu\text{/div.}}{50 \text{ dots/div.}} = 1\text{E-}6\text{s}$

After running the example program, perform the following:

- Select the default setup by pressing the front panel keys **STATUS** and **TEXT OFF** at the same time.
- Select the digital mode by pressing the **ANALOG** key.
- Select the recall menu by pressing the **RECALL** key.
Use the **TRACK** button and the software keys to turn the **m4** register display on and the **acq** display off.
- Press the **STATUS** key.

Example program:

```

100 COUNT=512                                :'Number of samples
110 PRINT "Generating trace samples ..."    :'Display operator message
120 DIM WAVE(2*COUNT)                       :'Declare waveform array
130 FOR I=1 TO COUNT                         :'For all samples
140   SAMPLE = INT(19200*SIN(I/40.744))      :'Generate sine value
150   LSB = SAMPLE AND &HFF                  :'Calculate Least Sign. Byte
160   MSB = ((SAMPLE-LSB) / 256) AND &HFF    :'Calculate Most Sign. Byte
170   WAVE(2*I) = LSB                       :'Put LSB in array
180   WAVE(2*I-1) = MSB                    :'Put MSB in array
190 NEXT
200 PRINT "Transmitting trace administration ..."
                                           :'Display operator message
210 PRINT #1,"PW",41,                       :'Program waveform (m4.1)
220 PRINT #1,"m4.1",                       :'Trace_name (ignored)
230 PRINT #1,"V",                          :'Y_unit (Volts)
240 PRINT #1,"s",                          :'X_unit (seconds)
250 PRINT #1,+3,                            :'Y_zero (3 V offset)
260 PRINT #1,-8.625E-6,                    :'X_zero (ignored)
270 PRINT #1,78.13E-3,                    :'Y_resolution
280 PRINT #1,1E-6,                         :'X_resolution
290 PRINT #1,65535,                        :'Y_range (ignored)
300 PRINT #1,"E25-01-1994",                :'Date
310 PRINT #1,"14:32:56:00",                :'Time
320 PRINT #1,375E-3,                       :'Delta T correction
330 PRINT #1,0,                             :'Min Max trace off
340 PRINT #1,32,                           :'Mult_shot_tot
350 PRINT #1,5,                             :'Mult_shot_nr
360 PRINT #1,"0","0",                      :'Reserved field 1,2
                                           (ignored)
370 PRINT #1,COUNT                         :'Number of 16 bit samples
380 GOSUB 1000                             :'Sync on acknowledge
390 SUM=0
400 PRINT "Transmitting trace samples ..."
                                           :'Display operator message
410 FOR I=1 TO 2*COUNT                   :'2 bytes per sample
420   PRINT #1,CHR$(WAVE(I));              :'Send each sample byte
430   SUM=(SUM+WAVE(I))MOD(256)           :'Calculate checksum
440 NEXT I
450 PRINT #1,CHR$(SUM);                    :'Send checksum
460 GOSUB 1000                             :'Sync on acknowledge

```

QUERY MEASUREMENT**QM****Purpose:**

To obtain measurement data from an oscilloscope.

If the **V** (Value) parameter is specified, one measured value will be returned.

If the **L** (Logging) parameter is specified, an infinite number of measured values will be returned. Cancelling is possible by sending the ASCII character ESC.

If no **V** or **L** parameter is specified, one measured value is returned, preceded by its type, and concluded by its suffix.

Note: If averaging is on, the values will be averaged over the number of average counts.

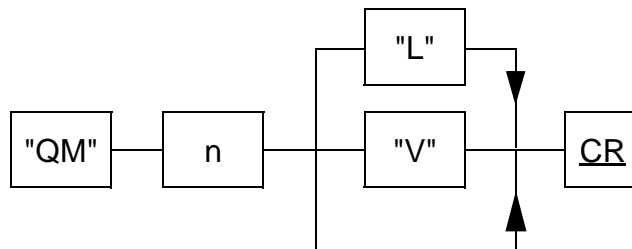
Command:

- "V" only the numerical value of the measurement result is returned
- "L" the numerical values of an infinite number of measurement results is returned; cancelling is possible by sending ASCII character ESC (= 27 decimal)
- n decimal number, specifying the type of measurement to perform (see table on next page)

n	meas_type ¹⁾	suffix_unit ¹⁾	Note:
1	variable	variable	measurement 1
2	variable	variable	measurement 2
10	dV	V	delta Voltage between cursors
11	V1	V	Volt cursor 1
12	V2	V	Volt cursor 2
13	Vdc	V	Volt dc
20	dT	s	delta Time between cursors ²⁾
21	F	Hz	Frequency (1/dT)
30	dX	V	delta X ³⁾
40	dPh	o	Phase difference
51	T1-trg	s	Time between cursor 1 and trigger
52	T2-trg	s	Time between cursor 2 and trigger
60	FFT_freq	Hz	Frequency at cursor ⁴⁾
61	FFT_ampl	dB/dBm/ dB μ V/Vrms	Amplitude at cursor ⁴⁾

Notes: 1) The meas_type and suffix_unit of the measurement 1 and 2 values depend on the selections, made with the MEASURE MENU via the front-panel key MEASURE. Refer to the MEASURE MENU of chapter 5 "FUNCTION REFERENCE".

2) Delta T can only be obtained, if X-Deflection is off.

3) Delta X can only be obtained, if X-Deflection is on.

4) FFT only when MATH+ option is available.

Response 1:

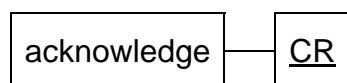

Response 2:

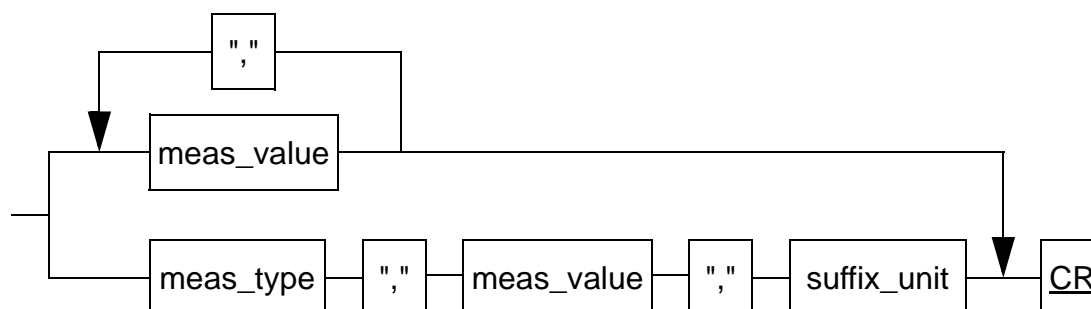

Response 2:	Condition:
type,value,unit	No V or L parameter
value	V parameter specified
value{,value}	L parameter specified

meas_type	string of characters, specifying the type of the measured value, e.g. "Tr"
meas_value	string of characters, specifying the measured value in floating point notation, e.g. "98934E-09"
suffix_unit	string of characters, specifying the unit of the measured value: "V", "s" or "Hz"

Example: (of a single measurement)

```

100 PRINT #1,"QM",21           : 'Query for frequency
                                measurement
110 GOSUB 1000                 : 'Sync on acknowledge
120 INPUT #1,TYPE$,MEAS$,SUFFIX$ : 'Read measured frequency
130 PRINT "Measurement: ";TYPE$;MEAS$;SUFFIX$
                                : 'Print measured frequency

```

Example: (of multiple measurements)

```

100 PRINT #1,"QM",10,"L"      : 'Query for delta-
                                voltage measurement
110 GOSUB 1000                 : 'Sync on acknowledge
120 INPUT #1,MEAS$            : 'Read measured
                                delta-voltage
130 PRINT "Measurement        : ";MEAS$: 'Print measured
                                delta-voltage
140 IF INKEY$="" THEN GOTO 120 : 'Do next measurement
                                until a key is pressed
150 PRINT #1,CHR$(27)         : 'Send ESC character

```

QUERY PRINT

QP**Purpose:**

To obtain the graphical data of the display from the oscilloscope.

The Query Print (QP) command can be used to retrieve a complete display picture, which can be stored as a HPGL file in the PC. This file can then be used in for example FLUKEVIEW, Word Perfect or Word files.

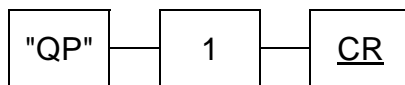
Command:**Response 1:****Response 2:**

print data HPGL data bytes.

In the example below the print data is read byte after byte by the PC and appended to the HPGL.HGL file

null When input buffer stays empty data transfer has ended

Example: Written in Quick Basic;

```
CLS
CLOSE
OPEN "COM2:19200,N,8,1, CS0, DS0, CD0" FOR RANDOM AS #1
OPEN "HPGL.HGL" FOR OUTPUT AS #2 : 'Open output file
PRINT #1, "QP"; 1 : 'Query print
Start! = TIMER
WHILE ((TIMER < Start! + 1) AND (LOC(1) = 0))
WEND
IF LOC(1) > 0 THEN : 'Sync on data
    PRINT "Response = ";
    DO
        Byte$ = INPUT$(LOC(1),#1) : 'Read each data byte
        PRINT Byte$; : 'Display databyte
        PRINT #2, Byte$; : 'Append databyte to file
        Start! = TIMER
        WHILE ((TIMER < Start! + 1) AND (LOC(1) = 0))
        WEND
    LOOP WHILE LOC(1) > 0
ELSE : 'Error message
    PRINT "No Response"
END IF
CLOSE
```

QUERY SETUP**QS****Purpose:**

To query the oscilloscope for its current setup.

This Query Setup (QS) command and the Program Setup (PS) command can be used together in order to retrieve and restore a complete or partial setup of the oscilloscope. Optionally a parameter can be added to the command to query a particular part of the setup. When this parameter is omitted, the complete setup is returned.

The response can be stored as an array of strings in the computer to be sent back later using the PS command. Each string that is received describes a setup node in the oscilloscope.

(Refer to Program Setup (PS) and section 6.8 SETUP)

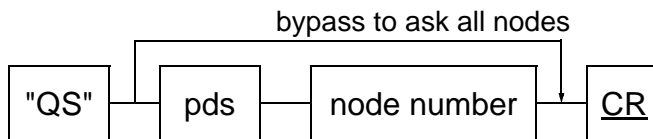
Command:

<node number> optional parameter, in decimal ASCII, to query only one setup node. Refer to section 6.8 SETUP for the setup node numbers.

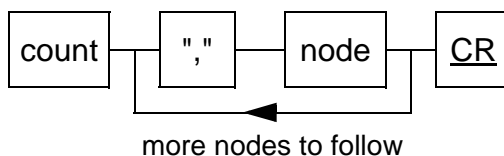
Response 1:**Response 2:**

<count> number of strings to follow
 <node> string of decimal characters representing a setup node in the oscilloscope, e.g. 16 (=10 hex.)

Example:

(Complete setup query)

```

90 DIM SETUP$(25)           : 'Reserve space
100 PRINT #1,"QS"           : 'Send command
110 GOSUB 1000              : 'Sync on acknowledge
120 INPUT #1,N              : 'Read number of node strings
130 FOR I=1 TO N
140   INPUT #1,SETUP$(I)    : 'Read all node strings
150   PRINT "N= ";I;SETUP$(I)
160 NEXT I

```

example response: (PM3394)

```

11,0106hlhl.....,0206hlhl.....,0306hlhl.....CR **)

```

**) These SETUP\$ array elements can be stored and sent back later to the oscilloscope with the "PS" command.

(Optional setup query to read only one setup node)

```

100 PRINT #1,"QS";4        : 'Query setup node 4
110 GOSUB 1000            : 'Sync on acknowledge
120 INPUT #1,N            : 'Read number of setup nodes
130 INPUT #1,SETUP$       : 'Read the setup node
140 PRINT SETUP$          : 'Print the setup string

```

QUERY TEXT**QT****Purpose:**

To query text from an oscilloscope.

If the **S** parameter is specified, setup text is returned. The text will be queried from one of the setup registers of the oscilloscope. The parameter **n** specifies the setup register. A text field of 22 characters is returned.

If the **S** parameter is not specified, user text is returned. The text will be queried from the screen of the oscilloscope. A text field of 64 characters is returned. The parameter **n** may not be used.

The queried text can be programmed again with the Program Text (PT) command.

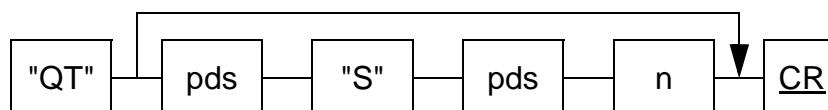
Command:

"S" setup text of register n will be returned; if "S" and n are left out, user text is returned

n one of the setup registers, ranging from 0 to 10;
n=0 selects the current setup

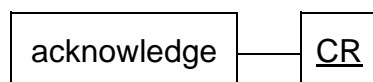
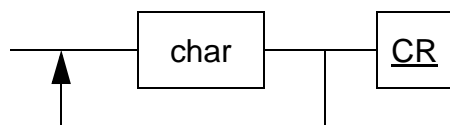
Response 1:**Response 2:**

char a character byte; range = 15 to 127
(refer to PROGRAM TEXT character code table 6.1)

Example: (of user text)

Read the user text from the screen of an oscilloscope:

```

 90 DIM USERTXT$ (64)
100 PRINT #1,"QT"           : 'Query user Text command
110 GOSUB 1000             : 'Sync on acknowledge
120 LINE INPUT #1,USERTXT$ : 'Read text characters
130 PRINT USERTXT$         : 'Print user text

```

The text on the screen of the oscilloscope will be printed, e.g.:
Measurement 15

Note: *The ASCII presentation of the oscilloscope character set is printed, e.g. :*

- *dec 25 = oscilloscope character Ω*
- *dec 25 = ASCII character ↓*

Example: (of setup text)

Read the text from setup register 7 of an oscilloscope:

```

 90 DIM SETUP$ (22)
100 PRINT #1,"QT S 7"       : 'Query setup Text command
110 GOSUB 1000             : 'Sync on acknowledge
120 LINE INPUT #1,SETUP$   : 'Read text characters
130 PRINT SETUP$           : 'Print setup text

```

QUERY WAVEFORM**QW****Purpose:**

To obtain a complete waveform from the oscilloscope.

You can use the **PW** command to send the data received with the **QW** query back to the oscilloscope.

The option ",A" can be used to recall the date and time in the customized format. When compatibility with initial versions of these oscilloscopes is required this ",A" option should be omitted.

Note: The number of data bits of the RS-232 interface must be 8 (not 7); otherwise an execution error will be given.

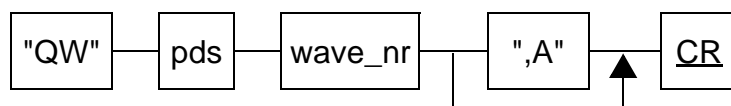
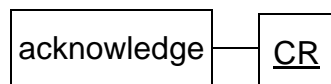
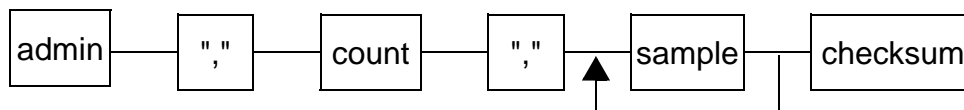
Command:**Response 1:****Response 2:**

Note: A trace transfer can be canceled by sending the ESC character (= 27 decimal).

wave_nr The oscilloscope waveform source:
 001 - 004 for CH1 - CH4 00e for EXT TRIG
 011 - 084 for m1.1 - m8.4 01e-08e for m1.e - m8.e
 091 - 504 for m9.1 - m50.4 (Extended Memory only)
 09e - 50e for m9.e - m50.e (Extended Memory only)
 (xx.e for 2 ch. versions only; xx3 and xx4 for 4 ch. versions only)

admin 16 parameters, separated by a ",":

PARAMETER	TYPE	EXAMPLE	NOTES
trace_name	string	m4.1	
Y_unit	string	V	
X_unit	string	s	
Y_zero	number	3	Y-position (reverse)
X_zero	number	-8.625E-6	Trigger delay
Y_resolution	number	78.13E-3	
X_resolution	number	1E-6	
Y_range	number	65535	
date	string	[F]1994-01-25 ¹⁾	
time	string	17:11:25:40 no",A" option: 17:11:25	
dT-corr	number	375E-3	dT = dT-corr * X-resolution
min/max	number	0	1 = min/max trace
mult_shot_tot	number	32	
mult_shot_nr	number	5	
reserved	string	0	
reserved	string	0	

1) When 'A' option is added; F = date format
 (E = European, A = American, J = Japanese)
 No option then E format.

count The acquisition length: 512, 8192, 16384 or 32768
 (Extended Memory: 8192 and higher)

sample 2 bytes (Most Significant Byte + Least Significant Byte), representing the 16-bit sample value (bit 16 = -32768, bit 15 = 16384, ..., bit 1 = 1).
 Range: -32k (down) ... +32k (up)

Example: 1000000011000111 = value -32569

byte 1	byte 2
--------	--------

byte 1 = 128 (value -32768)

byte 2 = 128+64+4+2+1 = 199 (value +199)

checksum 1 byte checksum over all sample bytes

Example:

```

100 PRINT #1,"QW";74           : 'Query waveform (m7.4)
110 GOSUB 1000                 : 'Sync on acknowledge
120 INPUT #1,NM$               : 'Trace_name
130 INPUT #1,YUNIT$            : 'Y_unit
140 INPUT #1,XUNIT$            : 'X_unit
150 INPUT #1,YZERO             : 'Y_zero
160 INPUT #1,XZERO             : 'X_zero
170 INPUT #1,YRESOL            : 'Y_resolution
180 INPUT #1,XRESOL            : 'X_resolution
190 INPUT #1,YRANGE            : 'Y_range
200 INPUT #1,DT$               : 'Date
210 INPUT #1,TM$               : 'Time
220 INPUT #1,DTC               : 'Delta T correction
230 INPUT #1,MINMAX            : 'Min Max trace
240 INPUT #1,RES1$             : 'Reserved field
250 INPUT #1,RES2$             : 'Reserved field
260 INPUT #1,RES3$             : 'Reserved field
270 INPUT #1,RES4$             : 'Reserved field
280 INPUT #1,COUNT             : 'Sample_count
290 DIM WAVE(2*COUNT)         : 'Declare waveform array
300 SUM=0
310 PRINT "Reading trace samples ..." : 'Display operator message
320 FOR I=1 TO 2*COUNT         : '2 bytes per sample
330   WAVE(I)=ASC(INPUT$(1,#1)) : 'Read each sample byte
340   SUM=(SUM+WAVE(I))MOD(256) : 'Calculate checksum
350 NEXT I
360 CHECKSUM=ASC(INPUT$(1,#1)) : 'Read checksum
370 IF SUM <> CHECKSUM THEN GOTO 380 : 'Test checksum
380 END
390 PRINT "*** Checksum error ***"   : 'Display error message

```

Interpretation of waveform data

As a response to the QW command the oscilloscope sends a set of data describing the waveform. The following example shows the interpretation of that data. The example assumes the Probe Adjust signal to be applied to input channel 1.

For information about MATHPLUS, refer to the supplement for the operation guide.

EXAMPLE:

Settings	Attenuator	200 mV/div
	Coupling	DC
	Offset	-1.5 div = -300 mV offset.
	Time base	200 us/div
	Delay	-2.50 div = 500 us pre-trigger view

Display

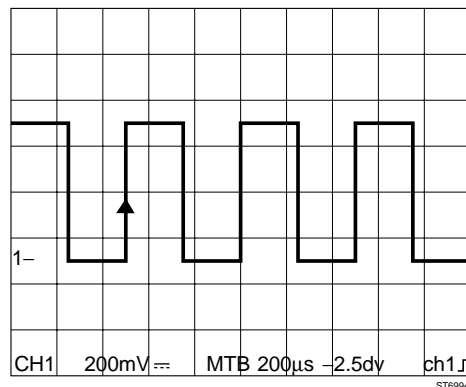

Data	SYMBOL	PARAMETER	VALUE	TYPE
	Yu	Y-unit	V	string
	Xu	X-unit	s	string
	Yz	Y-zero	0.3	number
	Xz	X-zero	-0.0005	number
	Yr	Y-resolution	3.125e-005	number
	Xr	X-resolution	4e-006	number
	Yrng	Y-range	65535	number
	dT-corr	dT-correction	4688E-04	number
	N	sample count	512	number
	Y[1]	sample 1	9603	binary
	Y[2]	sample 2	9612	binary

	Y[N]	sample N	-9599	binary

The following definitions and formula's that enable you to interpret the data above. The same definitions, symbols and formula's will be used to describe the discrete mathematical functions of the MATH+ processing functions.

Definitions

A waveform can be described as a set of two one dimensional arrays: **S[1...N]** and **T[1...N]**. The index *n* corresponds with the number of the samples and is an integer value in the range 1...N. The waveform of a sampled signal describes for a range of sample moments (T[1]...T[N]; usually expressed in seconds) the value of the signal at these moments (S[1]...S[N]; usually expressed in volts).

A waveform is sometimes expressed in other units. An FFT waveform for example gives for a range; of frequencies (T[1]...T[N]; expressed in Hz) the signal amplitude of these frequency components (S[1]...S[N]; expressed in dB). Another example is the possibility to multiply an input voltage with a floating point value of another dimension.

Formula's

S[n] S[n] is the value of sample *n*, expressed in Y-units.
Y-units are usually expressed in volts.

$$\mathbf{S[n] = (Yz + (Y[n] * Yr)) * Yu}$$

Sensitivity Usually the sensitivity is expressed in volt/div. In the oscilloscope, the range of the Y[n] values (Yrng) always equals $2^{16} = 65535$, which corresponds with 10.24 divisions on the screen. This gives a maximum vertical resolution of 6400 'levels' per division.
Sensitivity is expressed in Y-units/division.

$$\mathbf{Sensitivity = 6400 * Yr * Yu/div}$$

Offset Offset is the vertical screen position of the signal ground level, indicated by "1-" (excluding Y-pos shift). The offset can be adjusted with the front panel Y POS controls. For calculated traces the offset can be adjusted with the delta-controls in the MATHematics menu. Offset is expressed in Y-units (volts).

$$\mathbf{Offset = -Yz * Yu}$$

Note: Traces can also be positioned with the Y-pos control in the RECALL menu, but this does not affect the offset. The reason is that Y-pos is a pure display function, which therefore does not affect the signal sampling, nor the calculation of a trace using a mathematics function.

T[n] T[n] is the sample moment, expressed in X-units.
X-units are usually expressed in seconds.

$$\mathbf{T[n] = (Xz + (n-1) * Xr) + (dT-corr * Xr) * Xu}$$

Time base In case of a sampled signal the horizontal scale is called the time base. The time base setting is usually expressed in seconds/division. Without magnification or compression the oscilloscope always displays 50 samples per horizontal division.

Note: The horizontal scale as well as the FFT scale can differ. In that case it is expressed in X-units per division.

$$\text{Time base} = 50 * X_r * X_u/\text{div}$$

Delay Delay is the time delay between the trigger moment and the moment that the first sample is taken. If the delay is negative, the first sample is taken before the trigger moment. This is called pre-trigger view. In case of pre-trigger view the trigger point (horizontal position of which $T[n]=0$) is indicated on the screen. The delay or the position of the trigger point can be adjusted by means of the TRIGGER POSITION control.

Delay is usually expressed in X-units (seconds).

Note: Traces can also be positioned in horizontal direction with the X- POS control, but this does not affect the delay. The reason is that X-POS is a pure display function and therefore does not affect the signal sampling.

$$\text{Delay} = -(X_z + (dT\text{-corr} * X_r)) * X_u$$

$$\text{Trigger pos} = (X_z + (dT\text{-corr} * X_r)) * X_u$$

These values can also be expressed in divisions :

$$\text{Delay} = (-(X_z + (dT\text{-corr} * X_r)) / X_r) * 1/50 * \text{div}$$

$$\text{Trigger pos} = ((X_z + (dT\text{-corr} * X_r)) / X_r) * 1/50 * \text{div}$$

Notes:

- The mathematic functions only give useful results, if there is no conflict between the units. For example, it makes no sense to add amperes to volts.
- The trigger delay and the time base setting of the two traces must be equal. This is always guaranteed, if the traces were acquired at the same time, because the trace elements are from the same register.
- Consider the following useful example of a mathematics function:
 - Perform the multiplication of two traces with different units, i.e. a trace representing volts over time and a trace with amperes over time.
 - The resulting trace is expressed in watts and gives the power over time.
 - After integration this gives the Pulse Power in joules.

RESET INSTRUMENT

RI**Purpose:**

Resets all of the software of the oscilloscope, including the CPL protocol handler and all of the input and output buffers.

Oscilloscope settings remain the same. Interface parameters are not changed in order to keep the communication alive.

When the Reset has been completed the oscilloscope responds with an <acknowledge>.

There is no frontpanel equivalent for this command.

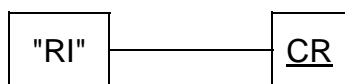
Command:**Response:**

Note: <acknowledge> will be sent after the Reset has been completed

Example:

```
100 PRINT #1,"RI"      : 'Send command
110 GOSUB 1000         : 'Sync on acknowledge
```

RECALL SETUP

RS

Purpose:

To recall an internally stored setup from one of 10 setup registers. This setup must have been stored in the oscilloscope manually or with the Save Setup (SS) command.

The command performs the same as the frontpanel key SETUPS together with the softkey RECALL.

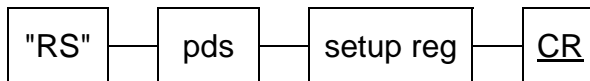
Command:

<setup reg> represents the setup register number ranging from 1...10

Response:

Note: <acknowledge> will be sent after the internal setup has been completed.

Example:

```

100 PRINT #1,"RS";5      : 'Recall setting 5
110 GOSUB 1000           : 'Sync on acknowledge
  
```

SAVE SETUP

SS**Purpose:**

To save the current oscilloscope setup in one of 10 internal setup registers. This setup can be recalled manually or by sending the Recall Setup (RS) command.

The command performs the same as the frontpanel key SETUPS together with the softkey SAVE. An execution error will be returned if the setup register is write protected.

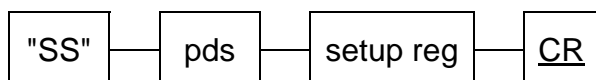
Command:

<setup reg> represents the setup register number, ranging from 1 ... 10

Response:**Example:**

```
100 PRINT #1,"SS";3      : 'Save setup in reg 3
110 INPUT#1,ACK          : Sync on acknowledge
```

STATUS**ST****Purpose:**

To obtain a more detailed status report. The response gives more information about the conditions, causing a wrong acknowledge.

The status is returned as one or more signed decimal integers. Each bit of the equivalent 16-bit binary status word represents a status condition. If a bit is set, the corresponding status event has occurred. The 16-th (sign) bit of a status word indicates that another status word follows. The last status word is the error status.

After the reply, the value of the status is reset to zero. The complete description of the status word can be found in section 6.7 (STATUS).

The function of the front panel key STATUS has no relation with this ST command.

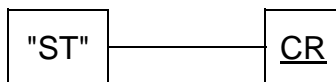
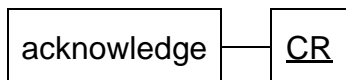
Command:**Response:**

when acknowledge=0 followed by:

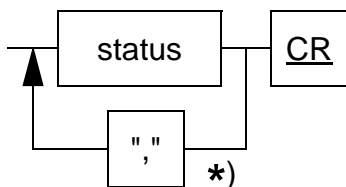

<status> = signed integer,
between -32768 ... 32767

*) when status is negative

Example:

```
100 PRINT #1,"ST"           :'Send command
110 GOSUB 1000              :'Sync on acknowledge
120 INPUT #1,STATUS        :'Read Status word
130 IF STATUS < 0 THEN GOTO 120  :'Fetch next status
140 GOSUB 2000              :'Display Status *)
```

example status:

6CR (= 0000000000000110 in binary)

which means: (because bit 2 and bit 1 are set)

- data out of range and
- data format of the body is wrong

*) See section 6.7 (STATUS) for program example.

TRIGGER ACQUISITION

TA**Purpose:**

To perform a software trigger.

This command causes an acquisition or sweep to be started. It is the software equivalent of a normal trigger pulse. In the single shot mode the AT (Arm Trigger) command is sent to arm the triggering first.

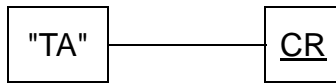
Command:**Response:****Example:**

```
100 PRINT #1,"TA"      :'Send Trigger Acquisition
110 GOSUB 1000         :'Sync on acknowledge
```

6.6 ACKNOWLEDGE

The <acknowledge> is a synchronization reply that is returned after each command sent to the oscilloscope, signalling correct or incorrect operation:

"0"	Ok, normal situation	
"1"	Syntax error	(ST query may give more info)
"2"	Execution error	(ST query may give more info)
"3"	Synchronization error	
"4"	Communication error	

Explanation and examples of the errors:

Syntax Error:

returned when the command is not understood by the oscilloscope for one of the following reasons:

- * Unknown header, wrong instructions
- * Data format of body is wrong, e.g. alpha characters when decimal data expected

Execution Error:

returned when internal processing is not possible:

- * Data out of (internal) range
- * Conflicting oscilloscope settings

Synchronization Error:

returned when the oscilloscope receives a new command while it is still executing the previous one:

- * a new command is sent without waiting for the <acknowledge> synchronization.

Communication Error:

returned when any framing, parity or overrun error occurs in the received data.

When an error is detected during the execution of the command:

- the oscilloscope sends an <acknowledge>,
- the oscilloscope terminates further execution of the command and returns to the idle state,
- the oscilloscope is then ready for a new command.

6.7 STATUS

The Status word gives more information when the acknowledge is non- zero. A certain bit in the word can be found by performing a logical AND of the status word with the mask defined below.

(Logical AND: the words are compared bitwise and only when both bits are 1, the result bit is 1)

Example:

Status = 38 and must be checked for 'data out of range' (4)

```

38      = 0000 0000 0010 0110
4       = 0000 0000 0000 0100
logical AND 0000 0000 0000 0100

```

First status word: CPL status

Bit Position	Mask hex	Value dec	Meaning
0	&H0001	1	Unknown header
1	&H0002	2	Data format of body is wrong
2	&H0004	4	Data out of range
3	&H0008	8	Invalid instruction
4	&H0010	16	-- reserved, normally zero
5	&H0020	32	Invalid number of parameters
6	&H0040	64	Wrong number of databits
7	&H0080	128	Flash ROM not present
8	&H0100	256	Invalid Flash software
9	&H0200	512	Conflicting oscilloscope settings
10	&H0400	1024	User request, front panel key pressed
11	&H0800	2048	Flash write error
12	&H1000	4096	-- reserved, normally zero
13	&H2000	8192	Invalid password entered
14	&H4000	16384	-- reserved, normally zero
15	&H8000	32768	Next status available

Second status word: Auto calibration status

Third status word: Acquisition status

Example program to investigate status:

```
2000 PRINT "STATUS IS: ";STATUS
2010 PRINT "MEANING: ";
2020 IF (STATUS AND &H0001) > 0 THEN PRINT "UNKNOWN HEADER"
2030 IF (STATUS AND &H0002) > 0 THEN PRINT "WRONG DATA FORMAT"
2040 IF (STATUS AND &H0004) > 0 THEN PRINT "DATA OUT OF RANGE"
2050 IF (STATUS AND &H0020) > 0 THEN PRINT "INVALID # PARAMS"
2060 IF (STATUS AND &H0040) > 0 THEN PRINT "WRONG # DATABITS"
2070 IF (STATUS AND &H0200) > 0 THEN PRINT "CONFLICT SETTING"
2080 IF (STATUS AND &H0400) > 0 THEN PRINT "USER REQUEST"
2090 IF ABS (STATUS AND &H8000) > 0 THEN PRINT "MORE STATUS"
2100 RETURN
```

6.8 SETUP

The Query Setup (QS) and Program Setup (PS) commands can be used together in order to retrieve and restore a complete or partial setup of the oscilloscope.

When a setup is requested from the oscilloscope, it will send its setup as a sequence of strings. Each separate string describes a setup node. By adding a parameter to the QS command a particular setup node can be queried.

So the query program could be:

```
PRINT #1,"QS"      Complete setup
PRINT #1,"QS",2    Only node 2 (channel 2 settings)
PRINT #1,"QS",S    Only node S, where S must be one of the
                   values specified below.
```

Node numbers (S) can have the following values:

hex	dec	meaning
01	1	Channel 1 settings
02	2	Channel 2 settings
03	3	Not used
04	4	Ext trig settings (nodes above: attenuator, display on/off, coupling DC/AC, GND, Invert, 50Ω/1 MΩ, continuous(var)/discrete, position control)
0E	14	Probe Scale settings (scale value, scale unit)
0F	15	Common vertical settings (add 1+2, alt/chop, bandwidth limiter on/off, number of traces, average, envelope).
10	16	Common horizontal settings (X-deflection on/off, mode auto/trig/single/multiple, X-deflection source, magnify, acquisition length, X-position).
11	17	Main Timebase settings (timebase speed, triggering edge/TV, MTBI on/off, MAIN TB on/off, trigger slope pos/neg, TV trigger F1/F2/line, noise suppression on/off, continuous(var)/discrete, level-pp on/off, trigger source, trigger coupling, TV trigger normal/hdtv)
12	18	Delayed Timebase settings (timebase speed, trigger mode edge/tv, DEL'D TB on/off, edge trigger slope pos/neg, edge trigger source, trigger coupling)

hex	dec	meaning
13	19	Events Trigger Delay settings (event counter low/high, trigger level low/high, trigger source, event bits, trigger coupling)
14	20	SCPI Trigger Settings (SCPI trigger source low/high)
20	32	Cursor settings (V cursors on/off, T cursors on/off, rise time on/off, control V/T, Vpp on/off, rise time 10-90/20-80, readout Vpp/V+V-, cursors on/off, V readout delta/absolute/ratio, T readout delta/1/delta/ratio, channel FFT read out dBm/dB μ V/Vrms, FFT reference impedance)
21	33	Cursor autosearch settings (on/off, flank selection, reference selection, abs/rel)
31	49	Measurement 1 settings
32	50	Measurement 2 settings (Measure bits, measure type, source 1 low/high, source 2 low/high)
33	51	Pass/fail test settings (on/off, define, action, menu on/off, hardware on/off)
41	65	Mathematics 1 settings
42	66	Mathematics 2 settings (Mathematics bits, mathematics type, source 1 low/high, source 2 low/high, scale low/high, scale minimum low/high, offset low/high, window width low/high)
50	80	Display settings (settings display on/off, ground level indicator on/off, trigger level indicator on/off, dots join on/off, x versus Y on/off, status view on/off, backup status view, window on/off))
51	81	Trace intensity settings (analog trace intensity low/high, mtb/dtb intensity ratio)
52	82	Display trace position setting (X position, Y position)
60	96	Setup label text (max 22 characters)
70	112	Real time clock setting (format)
F0	240	Special node for service purposes

It is NOT necessary to send all strings to the oscilloscope, when a setting must be changed.

Applications: The setup nodes for different timebase settings can be stored separately. They can be used afterwards as fixed 'templates' to change only the oscilloscope timebase setup.

The layout of each setup node string is:

```
nnllxxxxxx.....xx
```

where all characters are in the hexadecimal range (0..9,A..F).
Each pair forms the hexa-decimal representation of a byte, in high-low order
(eg. hex:2A = bin:00101010 = dec:42)

nn the setup node number
ll the number of bytes in the setup node
(each byte is represented by two characters)
xx the actual setup node

Appendix A

ACQUIRE menu structure

DIGITAL MODE:

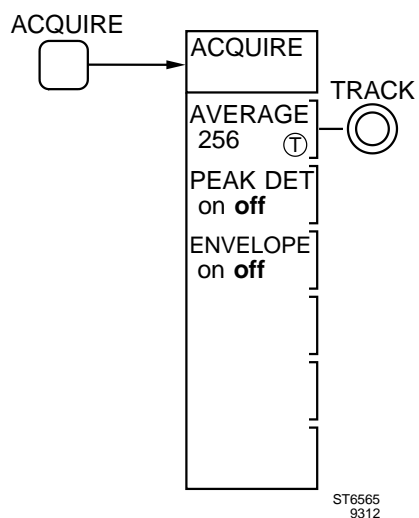

Appendix B

CURSORS menu structure

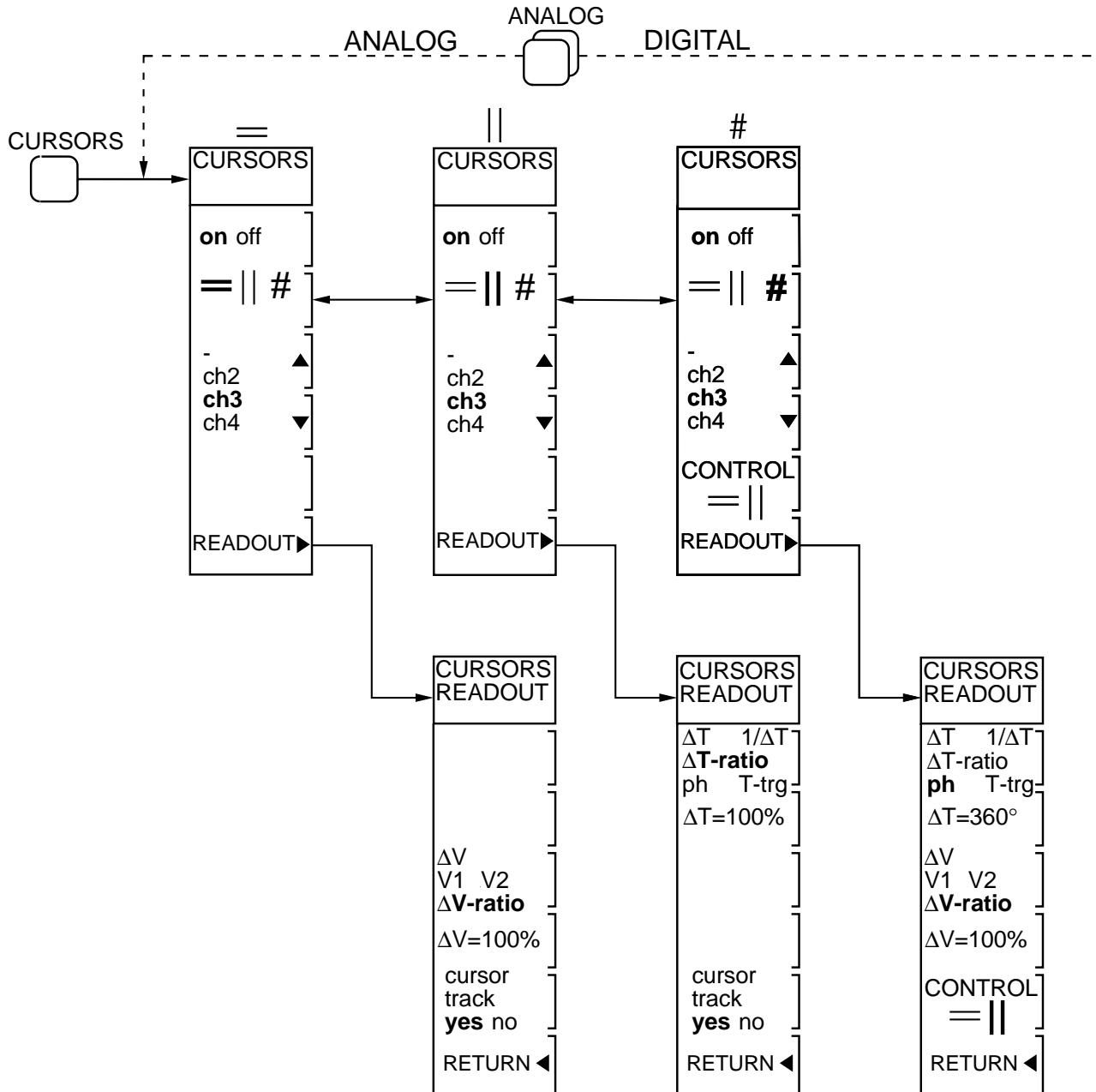

ST6567.1
9312

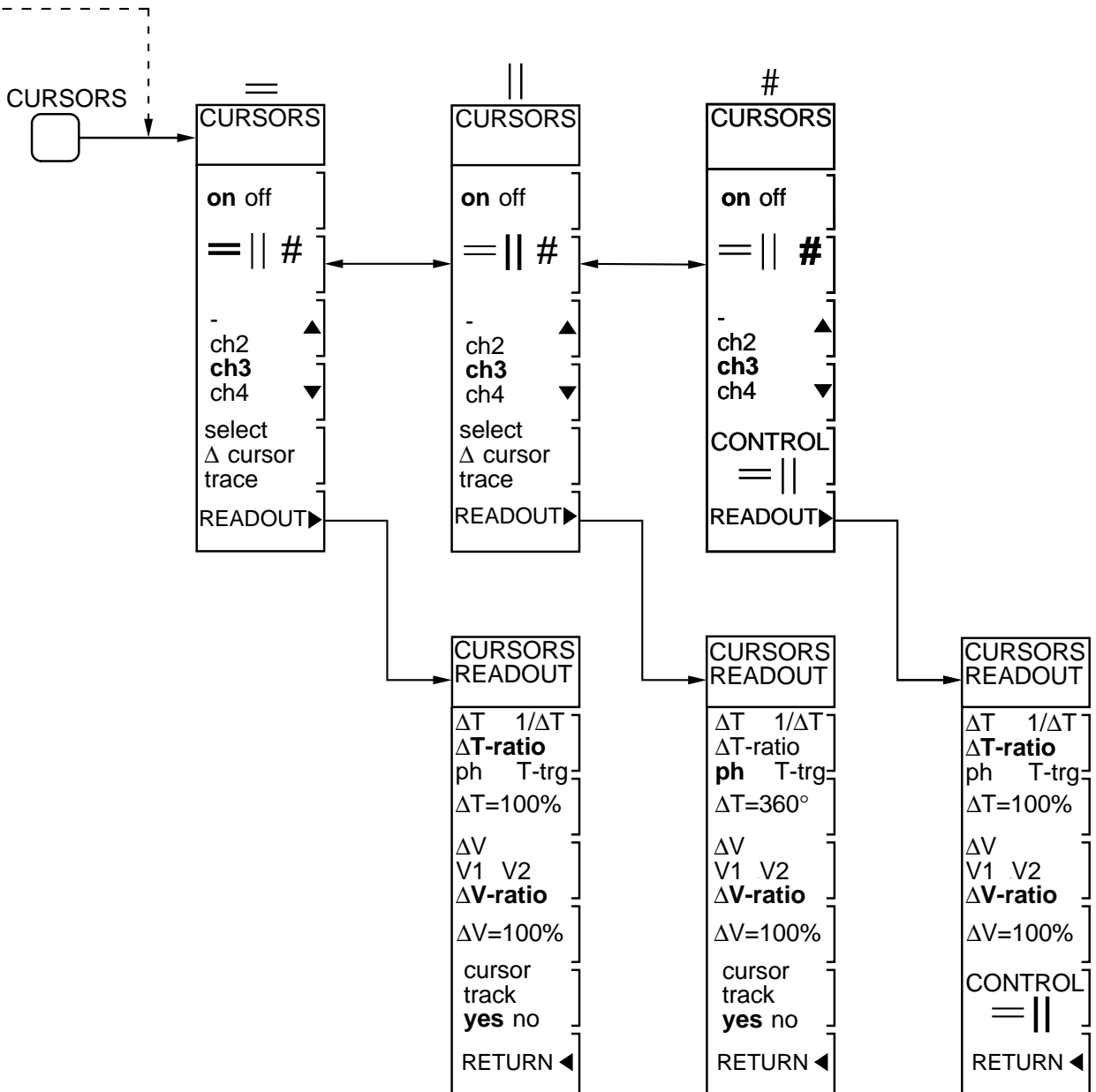

ST6567.2
9312

Appendix C

DISPLAY menu structured

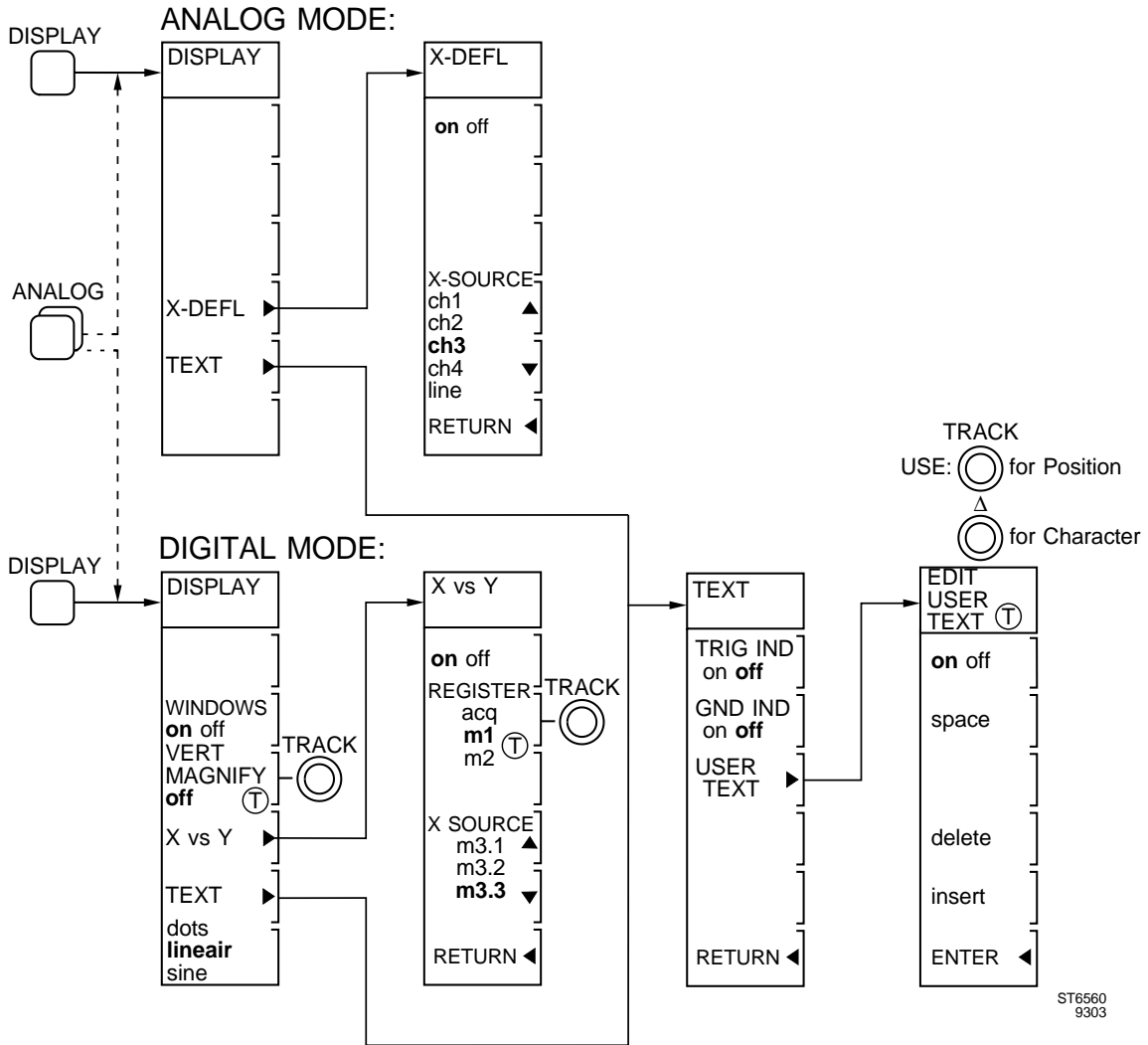

Appendix D

MATHEMATICS menu structure

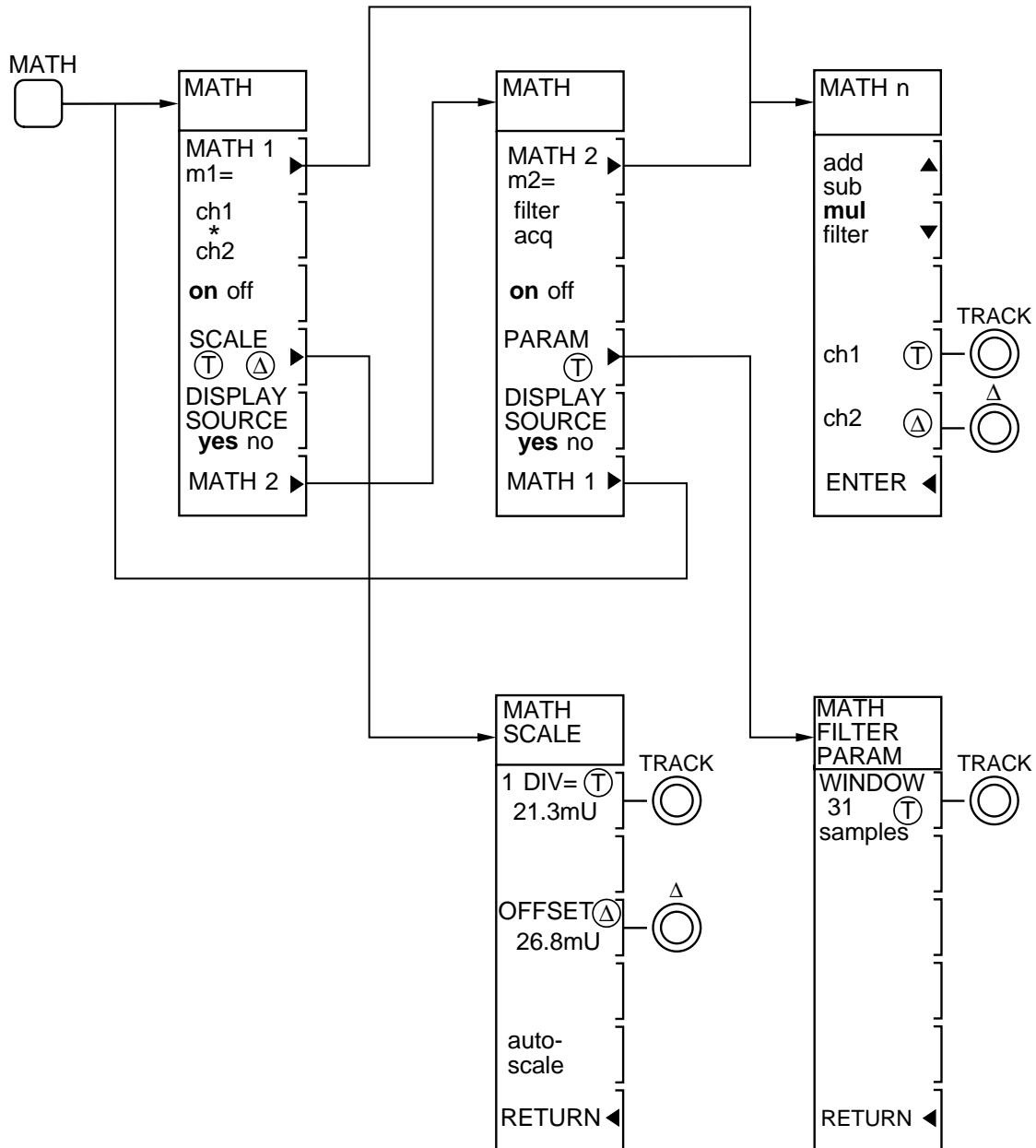

ST6748
9303

Appendix E

MEASURE menu structure

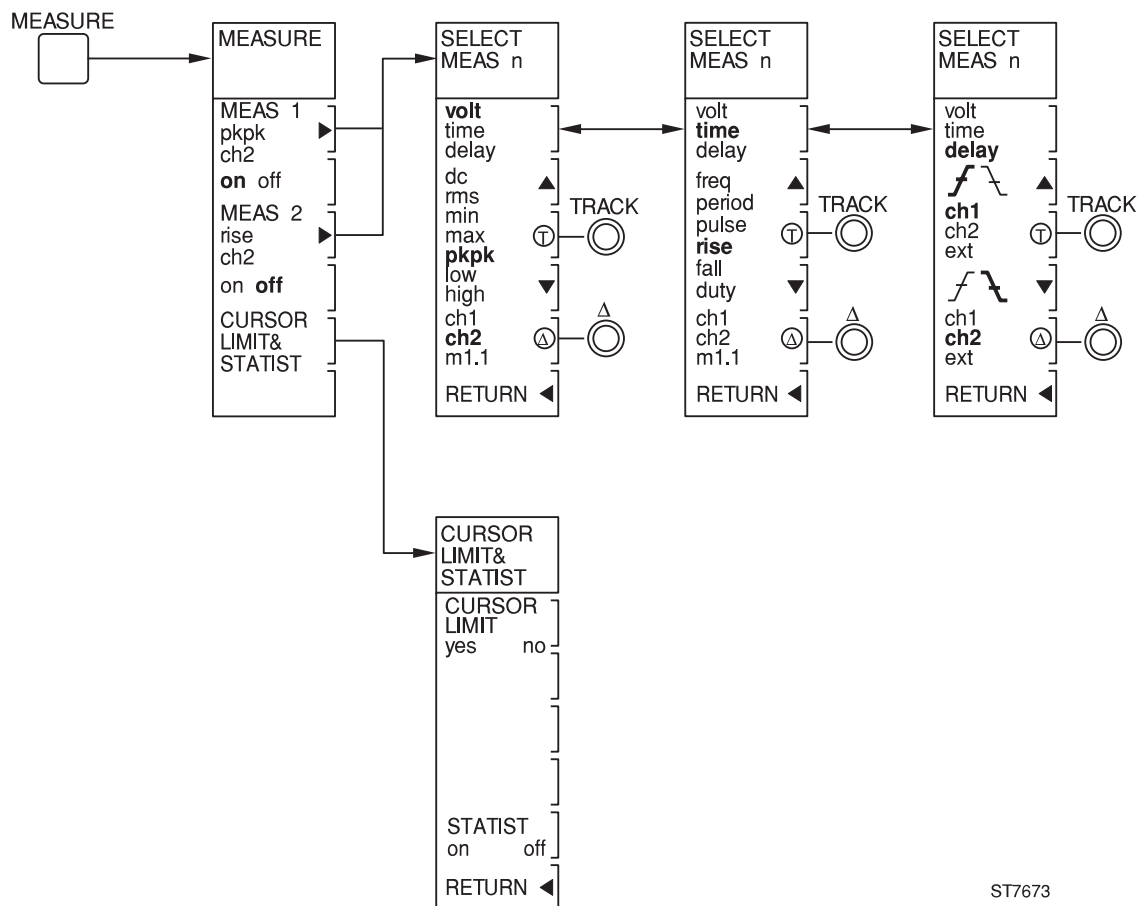

ST7673

Appendix F

DTB (DEL'D TB) menu structure

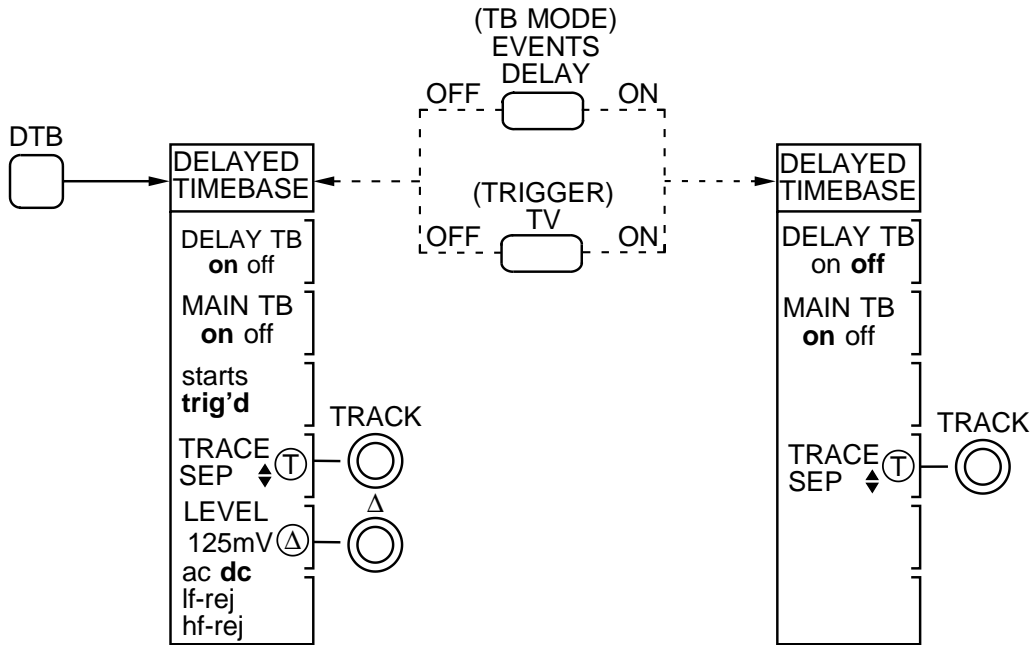

ST6564
9303

Appendix G

SAVE/RECALL menu structure

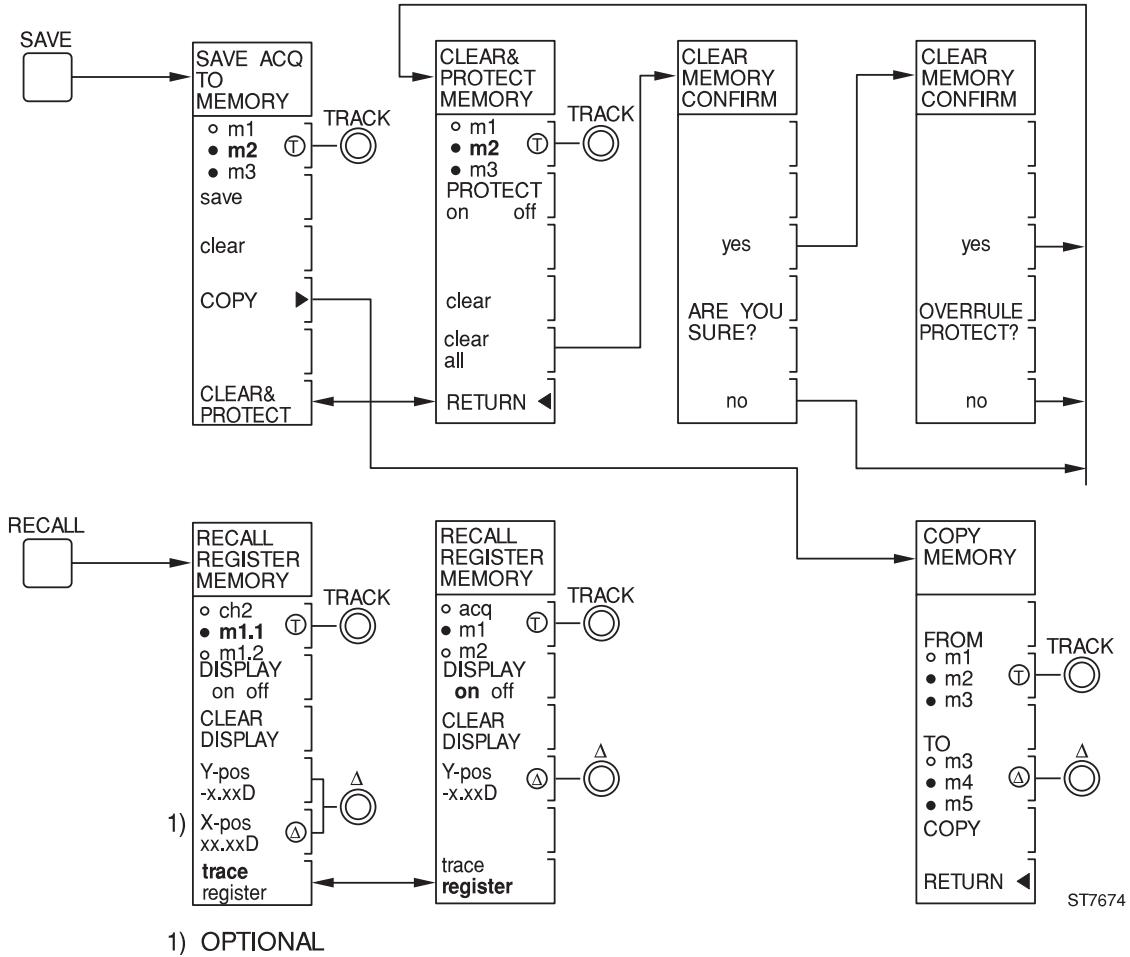

1) OPTIONAL

ST7674

Appendix H

SETUPS menu structure

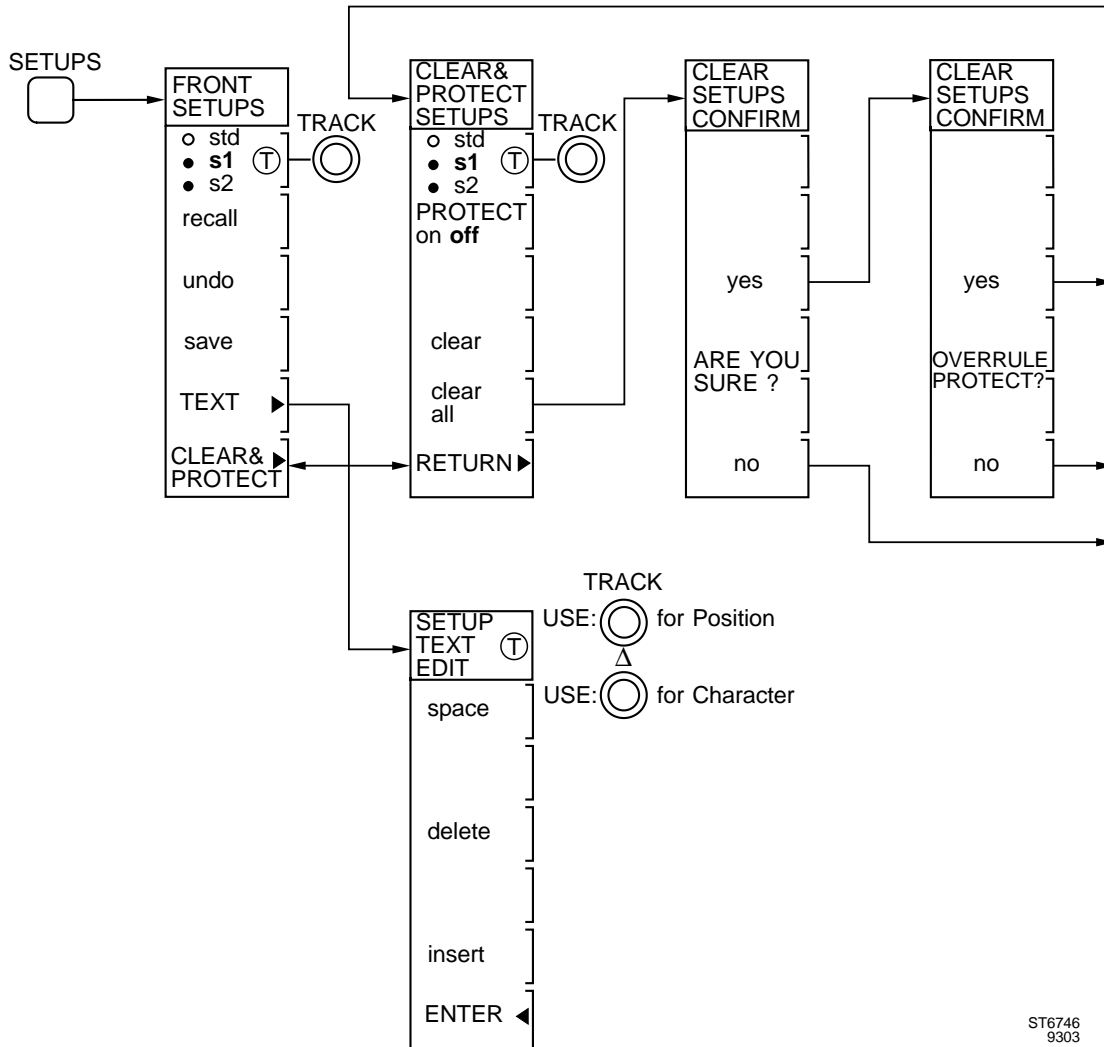

ST6746
9303

Appendix J

TB MODE menu structure

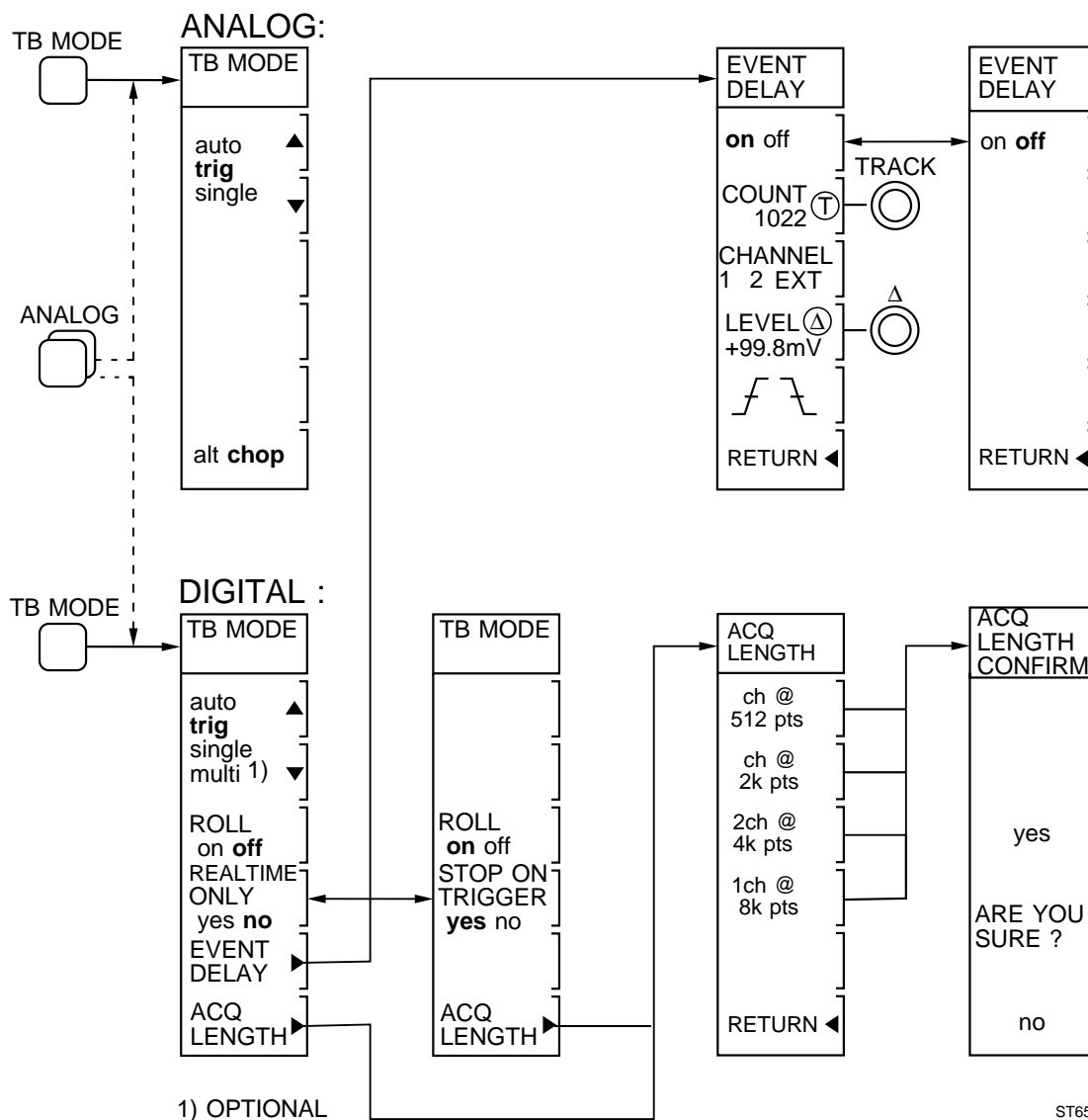

ST6563
9303

Appendix K TRIGGER menu structure

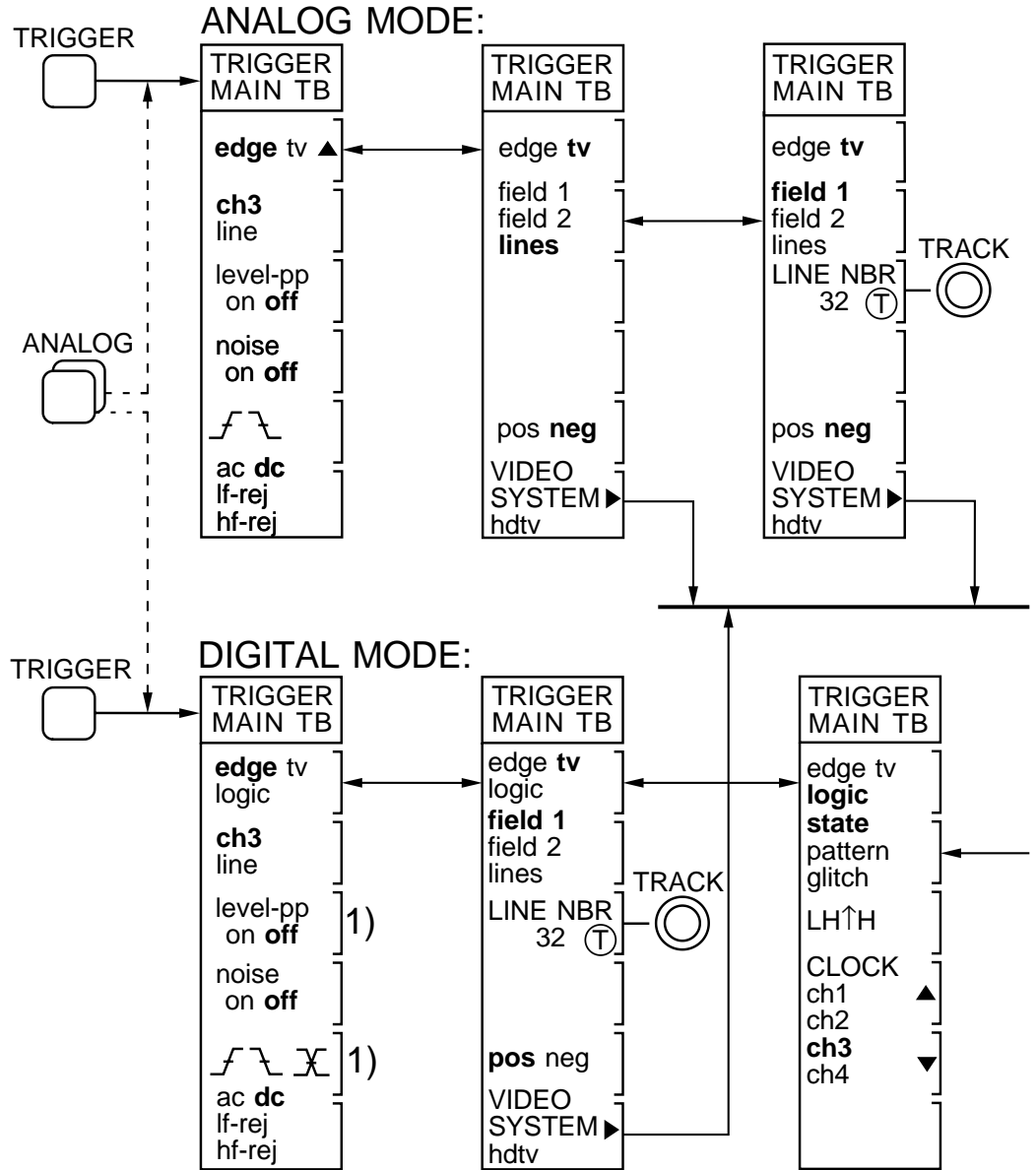

- 1) \times only in SINGLE mode, when 'REAL TIME ONLY' in TB MODE menu is yes.
level-pp is then replaced by:



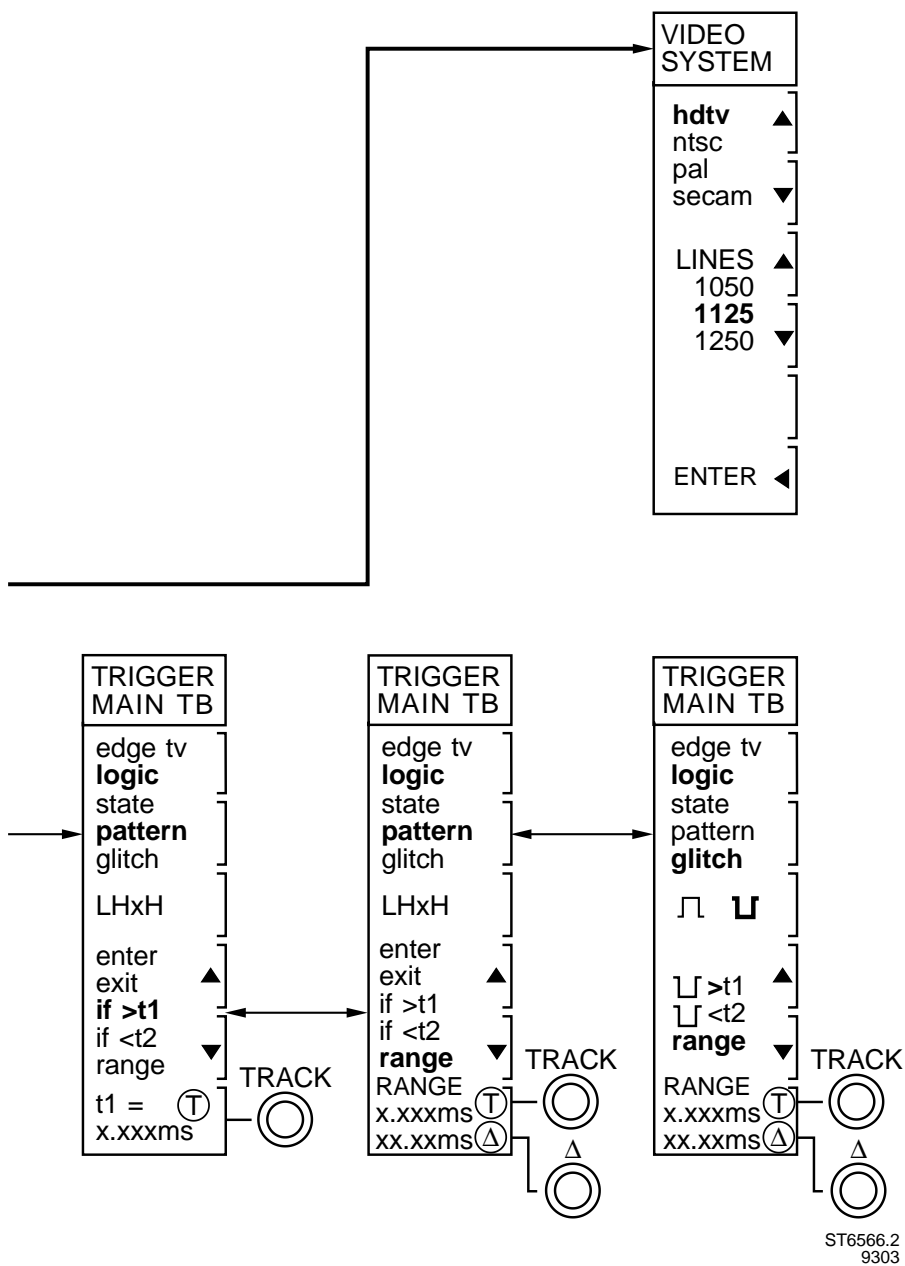

Appendix L

UTILITY menu structure

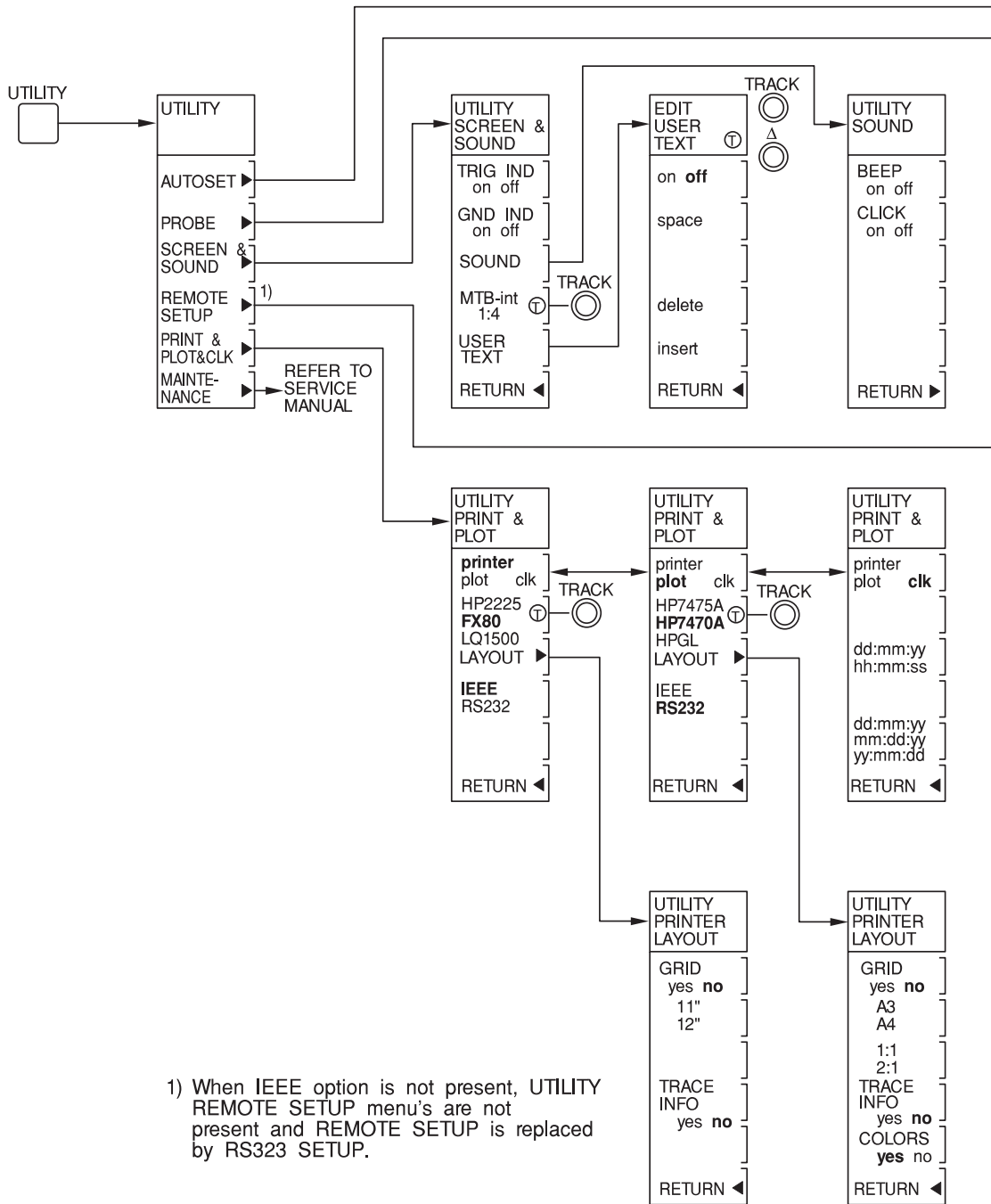

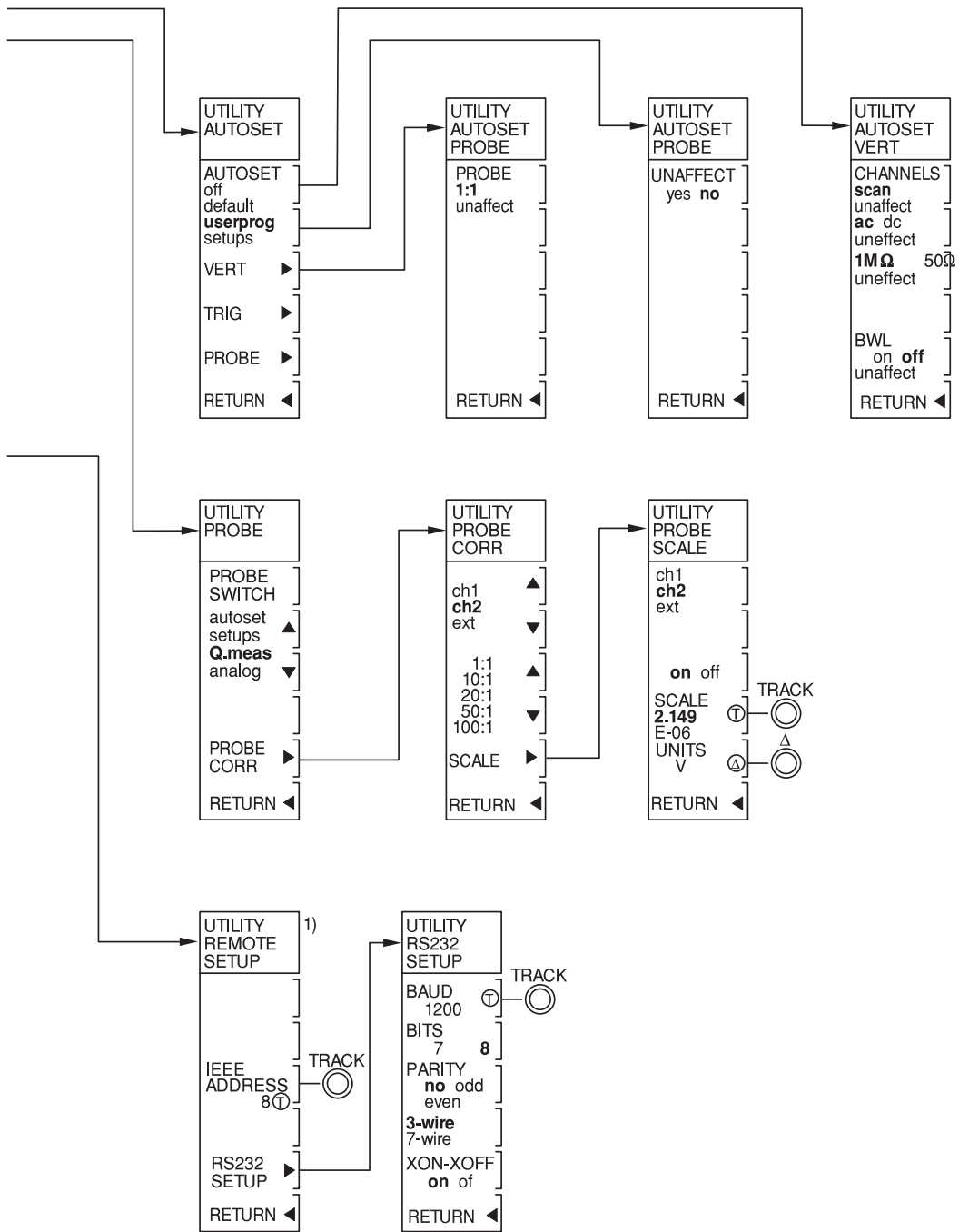

ST7677.2

Appendix M

VERTICAL menu structure

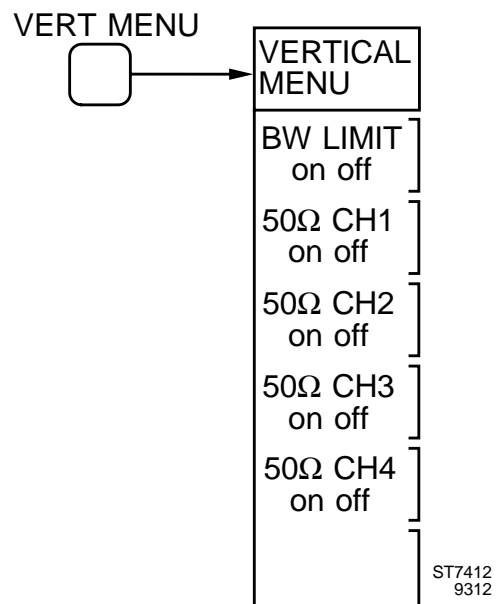

Appendix N

RS-232 Cable configurations

This appendix supplies additional information about the RS-232 cable configurations between the oscilloscope and a connected device. The oscilloscope and most of the devices are Data Terminal Equipment (DTE) configured.

Communication lines:

TxD = Transmitted Data
 RxD = Received Data
 RTS = Request To Send
 CTS = Clear To Send
 DTR = Data Terminal Ready
 DSR = Data Set Ready (= Modem Ready)
 DCD = Data Carrier Detect
 S.GND = Signal ground
 F.GND = Safety ground

A. Cable to printer/plotter/controller with software handshake

parameters: "3-wire/7-wire" = 3-wire
 "XON-XOFF on off" = on

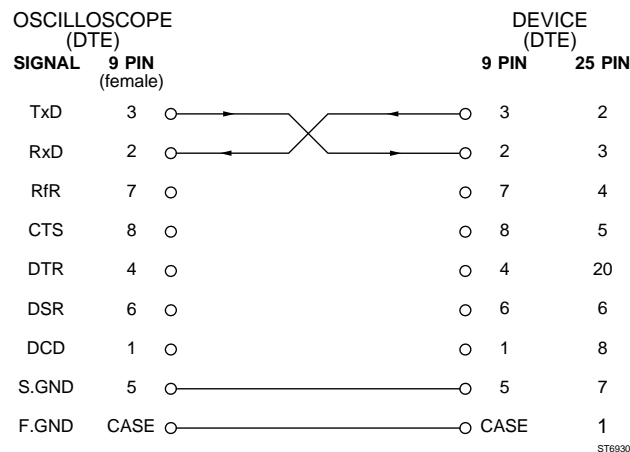

ATTENTION: *The maximum Baud rate for the PM8277 and PM8278 plotters is 4800 baud. For a higher Baud rate you must use a hardware handshake configuration.*

NOTE: *The LQ1500 printer can have a 6-pole DIN connector with the following connections:*

TxD on pin 1 DTR on pin 2
RxD on pin 3 S.GND on pin 5

B. Cable to printer/plotter with hardware handshake

parameters: "3-wire/7-wire" = 7-wire
 "XON-XOFF on off" = on or off

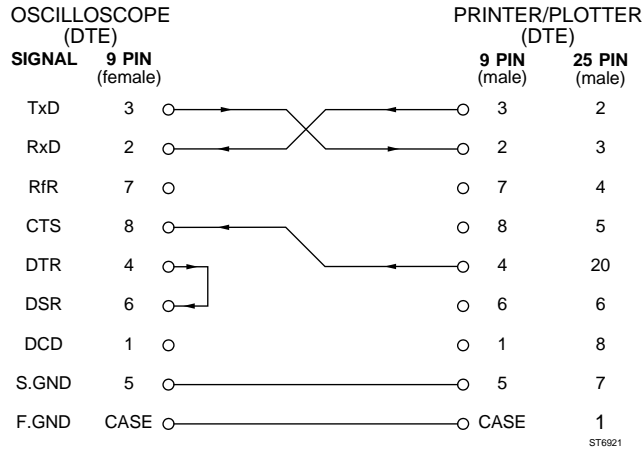

C. Cable to controller with hardware handshake

parameters: "3-wire/7-wire" = 7-wire
 "XON-XOFF on off" = on or off

The communication is confirm the RfR protocol. This means that signal RfR is active when the oscilloscope can receive data.

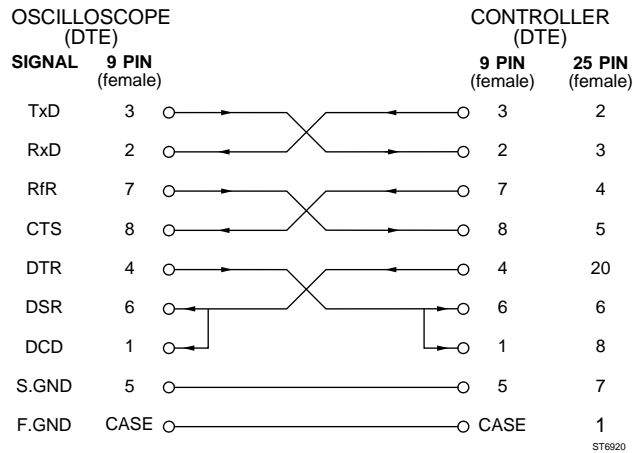

NOTE: When during data transfer the signal DSR on the oscilloscope becomes inactive, the serial communication buffers of the instrument are cleared. The hard copy action or waveform transfer stops then.

Appendix P

CHANNELS SIMULTANEOUSLY SAMPLED AT 100 MS/s

The scope has two 8-bit flash analog-to-digital converters (ADCs), each with a maximum sample rate of 100 MS/s. This allows two channels to be captured simultaneously in single shot mode, with sample rates of up to 100 MS/s for each channel. The horizontal resolution is then 10 ns (i.e., 1/100 MS/s).

DOUBLE SAMPLING MODE FOR 200 MS/s SINGLE CHANNEL ACQUISITIONS

Input stage switching expands the capability of both ADCs so they can be interleaved, allowing a maximum sample rate of 200 MS/s on a single channel. The entire acquisition memory can be used so that the record length for a single channel acquisition is can be equal to the full memory of the instrument (i.e., 8K for the standard instrument, and 32 K for an instrument equipped with Memory Expansion). The interleaving is done by feeding the input signal of a single channel to both ADCs that are sampling at a phase difference of 5 ns.

GLITCH DETECTION

The sampling rate of a DSO decreases when you lower the timebase setting. As long as the glitch capture feature is activated, the ADCs continue to sample at their maximum speed. A fast digital circuit analyzes all of these samples at real-time speed (100-MHz signal processing).

Only the maximum and minimum values (i.e., an envelope of min/max pairs) are stored in memory. Such a glitch detection circuit allows very narrow glitches to be captured even at low timebase settings and even if they occur only once.

The glitch capture circuit can also be used to avoid aliasing. The upper curve and the lower curve of an AM modulated signal appear on screen as an envelope of min/max pairs, and the area in between is shaded.

In the two-channel mode, glitches down to 10 ns (i.e., 1/100 Ms) can be captured. In single-channel mode, even glitches down to down to 5 ns can be captured.

GLITCH CAPTURE IN FOUR CHANNEL MODE

If more than two channels are activated and the glitch detector is switched on, the scope automatically selects the alternating mode. Since the alternate mode allows each ADC to run at full speed, 10 ns glitch detection is now possible on all four channels.

Single-shot acquisition with glitch detection is possible only in one- and two-channel modes.

CHANNEL ACQUISITIONS

For three- or four-channel acquisition, the ADCs are used in conjunction with the chopped mode or alternate mode.

In the chopped mode the first ADC takes a single sample on channel 1, then one on channel 3, then one on channel 1 again and so on. The second ADC chops between channels 2 and 4. The chopping rate is so high that the effective sample rate is 5 MS/s on four channels in parallel. This is more than adequate for single shot capture in most applications (power switching, audio, process control, etc.) and certainly for electro/mechanical applications, which are typically in the kHz range.

The advantage of a high speed chopper is that it allows single shot acquisitions to be taken on four channels simultaneously. The chopper is also an advantage for acquisitions at low timebase speeds.

ALTERNATING ACQUISITION

Some applications require the use of an alternating signal acquisition mode. In this mode each ADC can be used to its highest speed. Channels are acquired in the following sequence :

Channels 1 and 2 are acquired in parallel, with synchronized ADC acquisition, followed by channels 3 and 4. Because each ADC can be used up to 100 MS/s, glitch capture is now possible for glitches down to 10 ns.

RANDOM SAMPLING FOR FULL 200 MHz ACQUISITIONS AT HIGH TIME/DIV AND FOR FOUR CHANNELS IN PARALLEL.

For high timebase settings (200 ns/div to 2 ns/div), real-time signal acquisition would require a real-time sampling rate of 25 GigaSamples/second. Such sample rate is not achievable.

The oscilloscope can be used with time base speeds exceeding the capabilities of the ADCs. For such acquisitions repetitive signals are required. A sampling method known as random sampling is used.

This sampling method is automatically selected at higher time base speeds. In the random sampling mode, the chopper is used to acquire four signals simultaneously without restriction. The glitch detection circuit is not needed at these high timebase speeds because the sample distance is smaller than the glitch capture capability of 10 ns would allow (40 picoseconds at 2 ns/div).

EXPANSION AND INTERPOLATION

Sometimes there is a need to look at a single shot or low repetition rate signal at high timebase speed. This can be done by selecting the 'real time sampling only' mode in the Main Time Base menu. In this mode the scope never switches to random sampling.

In order to capture a longer time 'window' than would be accessible with the given time base speed, the Main Time Base mode menu allows you to select a longer acquisition length.

By means of horizontal magnification (2x, 4x, 8x, up to 32x) you can expand the signal, giving you a higher effective time base speed. In the DOTS mode, single samples become visible, and SINE and LINEAR interpolation can be used to reconstruct a true-to-life waveform. In four channel single shot mode with its maximum sample rate of 5 MS/s, a timebase speed close to 1 μ s/div is no problem. The 8x magnified waveform is then reconstructed out of 62 samples.

FUNCTION INDEX (see Chapter 5)

ACQUISITION LENGTH
ADD INVERT SUBTRACT
ADD (MATHEMATICS)
ALT/CHOP
ANALOG MODE
AUTO RANGE
AUTOSET
AUTOSET RECALL SEQUENCE
AUTOSET USERPROG
AVERAGE

BANDWIDTH LIMITER

CALIBRATION AUTOCAL
CHANNEL TRACE SELECTION
CONFIDENCE CHECK
CURSORS
CURSORS READOUT

DELAY
DELAY MEASUREMENT
DEL'D TB
DIGITAL MODE
DISPLAY MENU

ENVELOPE
EXTERNAL TRIGGER

FILTER

GLITCH TRIGGER

HOLD OFF

INPUT ATTENUATOR
INPUT COUPLING
INPUT IMPEDANCE

LOGIC TRIGGER

MAGNIFY HORIZONTAL
MAGNIFY VERTICAL
MAIN TB TIME/DIV
MATHEMATICS
MEASURE MENU
MULTIPLY

PEAK DETECTION
POSITION
POWER SUPPLY
PRINTING AND PLOTTING
PROBE UTILITIES

REMOTE CONTROL
RUN/STOP

SCREEN CONTROLS AND GRATICULE
SCREEN MESSAGES
SETUPS
SETUPS RECALL SEQUENCE
STANDARD FRONT/FRONT PANEL RESET
STATUS SCREEN
SUBTRACT (MATHEMATICS)

TB MODE
TEXT OFF
TIME MEASUREMENTS
TOUCH,HOLD & MEASURE MODE
TRIGGER COUPLING
TRIGGER DEL'D TB
TRIGGER LEVEL
TRIGGER MAIN TB
TV TRIGGER

USERTEXT
UTILITY MENU
UTILITY SCREEN & SOUND
UTILITY MAINTENANCE

VOLT MEASUREMENTS

X-DEFLECTION

INDEX

The overall index contains all function names and reference words in alphabetical order. It refers to the relevant section and page number, mainly of Chapter 5 (Function Reference). In this chapter more detailed information can be found.

Entry	Refer to chapter/function	Page
50Ω	5 INPUT IMPEDANCE.....	5-41
1 MΩ	5 INPUT IMPEDANCE.....	5-41
A		
a.c.	5 INPUT COUPLING.....	5-40
	5 TRIGGER COUPLING.....	5-79
Acquisition	5 ACQUISITION LENGTH.....	5-2
	5 CHANNEL/TRACE SELECTION.....	5-17
Add	5 ADD INVERT SUBTRACT.....	5-4
	5 ADD (MATHEMATICS).....	5-5
Adjusting the clock	5 PRINTING AND PLOTTING.....	5-55
Alternate	5 ALT/CHOP.....	5-7
Analog	4.3 ANALOG AND DIGITAL MODES.....	4-9
	5 ANALOG MODE.....	5-8
Attenuator	5 INPUT ATTENUATOR.....	5-39
Autocal	5 CALIBRATION AUTOCAL.....	5-16
Automatic attenuators	5 AUTO RANGE.....	5-9
	5 INPUT ATTENUATOR.....	5-39
Automatic timebase	5 AUTO RANGE.....	5-9
	5 MAIN TIMEBASE.....	5-46
Auto range	5 AUTO RANGE.....	5-9
Autoset	4.16 AUTOSSET AND SETUP UTILITIES.....	4-70
	5 AUTOSSET.....	5-10
	5 AUTOSSET SEQUENCE.....	5-11
	5 AUTOSSET USERPROG.....	5-12
Average	5 AVERAGE.....	5-14
B		
Bandwidth	5 BANDWIDTH LIMITER.....	5-15
Bar graph	5 CURSORS.....	5-19
C		
Calibration	5 CALIBRATION AUTOCAL.....	5-16
Channel	5 CHANNEL/TRACE SELECTION.....	5-17
Characteristics	Reference manual	
Checking	5 CONFIDENCE CHECK.....	5-18
Chop	5 ALT/CHOP.....	5-7

Entry	Refer to chapter/function	Page
Clock	5 PRINTING AND PLOTTING.....	5-55
Command switch	5 TOUCH, HOLD & MEASURE™ MODE ..	5-78
Common mode	5 ADD INVERT SUBTRACT.....	5-4
Confidence	5 CONFIDENCE CHECK.....	5-18
Cursor limited measurements	5 MEASURE MENU.....	5-47
	5 TIME MEASUREMENTS.....	5-76
	5 VOLT MEASUREMENTS.....	5-93
Connections	0.....	XI
Cursors	5 CURSORS.....	5-19
	5 CURSORS READOUT.....	5-22
D		
d.c.	5 INPUT COUPLING.....	5-40
DC voltage	5 VOLT MEASUREMENTS.....	5-91
Delay	5 DELAY.....	5-24
Delay measurement	5 DELAY MEASUREMENT.....	5-26
Delayed timebase	4.14 DELAYED TIMEBASE.....	4-62
	5 DELAYED TIMEBASE.....	5-27
	5 TRIGGER DEL'D TB.....	5-81
Differential mode	5 ADD INVERT SUBTRACT.....	5-4
Digital mode	4.3 ANALOG AND DIGITAL MODES.....	4-9
	5 DIGITAL MODE.....	5-29
Display	4.2 DISPLAY AND PROBE ADJUSTMENT...	4-06
	4.13 DISPLAY FUNCTIONS.....	4-56
	5 DISPLAY MENU.....	5-30
Dual slope trigger	5 TRIGGER MAIN TB.....	5-84
dump-m1	5 PRINTING AND PLOTTING.....	5-54
Duty cycle	5 TIME MEASUREMENTS.....	5-76
E		
Envelope	5 ENVELOPE.....	5-33
Event delay	5 DELAY.....	5-24
Expansion	5 ACQUISITION LENGTH.....	5-2
	5 APPENDIX N.....	N-1
External trigger	5 EXTERNAL TRIGGER.....	5-34
F		
Fall time	5 TIME MEASUREMENTS.....	5-76
Filter	5 FILTER.....	5-35
Frequency	5 TIME MEASUREMENTS.....	5-75
Front	4.1.....	4-2
	5 STANDARD FRONT.....	5-69

Entry	Refer to chapter/function	Page
G		
Glitch	5 PEAK DETECTION	5-51
Glitch trigger	5 GLITCH TRIGGER	5-36
GND	5 INPUT COUPLING	5-40
H		
Hard copy	5 PRINTING AND PLOTTING	5-53
High level	5 VOLT MEASUREMENT	5-92
Hold off	5 HOLD OFF	5-37
Horizontal deflection	4.5 HORIZONTAL DEFLECTION	4-21
Horizontal functions	4.8 ADVANCED HORIZONTAL FUNCTIONS .	4-34
I		
IEEE 488.2	5 PRINTING AND PLOTTING	5-54
	5 REMOTE CONTROL IEEE 488.2	5-58
Input attenuator	5 INPUT ATTENUATOR	5-39
Input coupling	5 INPUT COUPLING	5-40
Input impedance	5 INPUT IMPEDANCE	5-41
Interpolation	5 DISPLAY MENU	5-30
Installation	2 INSTALLATION INSTRUCTIONS	2-1
	5 APPENDIX N	N-1
Invert	5 ADD INVERT SUBTRACT	5-4
L		
Logic trigger	5 LOGIC TRIGGER	5-44
Low level	5 VOLT MEASUREMENTS	5-92
M		
Magnify	5 MAGNIFY HORIZONTAL	5-44
	5 MAGNIFY VERTICAL	5-45
Maintenance	5 UTIL MAINTENANCE	5-88
Main Timebase	5 HOLD OFF	5-37
	5 MAIN TIMEBASE	5-46
Mathematics	4.12 PROCESSING FUNCTIONS	4-52
	5 MATHEMATICS	5-47
Maximum voltage	5 VOLT MEASUREMENTS	5-92
Measure	4.11 MEASUREMENT FUNCTIONS	4-49
	5 DELAY MEASUREMENT	5-26
	5 MEASURE MENU	5-47
	5 TIME MEASUREMENTS	5-75
	5 VOLT MEASUREMENTS	5-91

Entry	Refer to chapter/function	Page
Memory	4.9 MEMORY FUNCTIONS	4-49
Memory back-up	2.2 MEMORY BACK-UP BATTERIES	2-3
Memory bar	5 CURSORS	5-19
Memory expansion	5 ACQUISITION LENGTH	5-2
Minimum voltage	5 VOLT MEASUREMENTS	5-92
Multiply	5 MULTIPLY	5-49
O		
Overshoot	5 VOLT MEASUREMENTS	5-93
P		
Peak detection	5 PEAK DETECTION	5-51
Performance test	Reference manual	
Period	5 TIME MEASUREMENTS	5-76
Pkpk voltage	5 VOLT MEASUREMENTS	5-92
Plot	4.15 HARD COPY FACILITIES	4-67
	5 PRINTING AND PLOTTING	5-53
Post-trigger	5 DELAY	5-24
Power up check	5 CONFIDENCE CHECK	5-18
Preshoot	5 VOLT MEASUREMENTS	5-93
Pre-trigger	5 DELAY	5-24
Print	4.15 HARD COPY FACILITIES	4-67
	5 PRINTING AND PLOTTING	5-53
Probe	5 PROBE UTILITIES	5-57
	5 UTILITY MENU	5-89
Pulse width	5 TIME MEASUREMENT	5-76
R		
Random sampling	5 TIMEBASE MODES	5-73
	APPENDIX N	N-1
Readout	5 CURSOR READOUT	5-22
Real time clock	5 PRINTING AND PLOTTING	5-55
Recall	5 CHANNEL/TRACE SELECTION	5-17
	5 SETUPS	5-67
Rise time	5 TIME MEASUREMENTS	5-76
RMS voltage	5 VOLT MEASUREMENTS	5-92
RS-232	5 PRINTING AND PLOTTING	5-54
	5 REMOTE CONTROL RS-232	5-59
Run	5 RUN/STOP	5-61
RS-232 cables	APPENDIX N	N-1

Entry		Refer to chapter/function	Page
S			
Safety	1	OPERATORS SAFETY.....	1-1
Sampling	5	TIMEBASE MODES	5-73
		APPENDIX N	N-1
Save	5	SETUPS	5-67
Screen	5	SCREEN CONTROLS AND GRATICULE .	5-62
	5	SCREEN MESSAGES	5-63
	5	UTILITY SCREEN & SOUND.....	5-90
Setting the clock	5	PRINTING AND PLOTTING.....	5-55
Setups	4.16	AUTOSET AND SETUP UTILITIES	4-70
	5	SETUPS	5-66
	5	SETUPS SEQUENCE	5-68
Single shot	5	TIMEBASE MODES	5-73
Sound	5	UTILITY SCREEN & SOUND.....	5-90
Statistics	5	TIME MEASUREMENTS	5-77
	5	VOLT MEASUREMENTS.....	5-93
Status	5	STATUS SCREEN	5-70
Subtract	5	ADD INVERT SUBTRACT	5-4
	5	SUBTRACT (MATHEMATICS).....	5-71
T			
Text	5	DISPLAY MENU	5-31
	5	TEXT OFF	5-74
	5	USER TEXT	5-88
Timebase	5	TIMEBASE MODES	5-75
	5	DELAYED TIMEBASE	5-27
Time cursors	5	CURSORS	5-19
Time measurements	5	CURSORS READOUT	5-22
	5	MEASURE MENU	5-47
	5	TIME MEASUREMENTS	5-77
Time to trigger	5	CURSORS READOUT	5-22
Touch, Hold & Measure	4.11	TOUCH, HOLD & MEASURE™ MODE ...	4-52
	5	TOUCH, HOLD & MEASURE™ MODE ...	5-78
Trace	5	CHANNEL/TRACE SELECTION	5-17
Trace separation	5	DELAYED TIMEBASE	5-28
Trigger	5	TRIGGER COUPLING	5-79
	5	TRIGGER DEL'D TB.....	5-81
	5	TRIGGER LEVEL.....	5-82
	5	TRIGGER MAIN TB	5-84
	5	DELAY	5-24
Trigger position	5	EXTERNAL TRIGGER	5-34
Trigger View	5	CURSORS READOUT	5-22
T-trg	5	CURSORS READOUT	5-22
TV	5	TV TRIGGER	5-86

U

User text 5 USER TEXT 5-87

V

Vertical deflection 4.4 VERTICAL DEFLECTION 4-13
 Vertical functions 4.7 ADVANCED VERTICAL FUNCTIONS 4-29
 Vertical magnify 5 DISPLAY MENU 5-30
 Volt cursors 5 CURSORS 5-19
 Volt measurements 5 CURSORS READOUT 5-22
 5 MEASURE MENU 5-47
 5 VOLT MEASUREMENTS 5-91

W

Waveform parameters 6 CPL PROTOCOL 6-36
 Windows 5 DISPLAY MENU 5-30

X

X-Deflection 5 DISPLAY MENU 5-30
 5 X-DEFLECTION 5-94
 X vs Y 5 DISPLAY MENU 5-30
 5 X-DEFLECTION 5-94