



# Makita Cordless Drills

**10 mm (3/8") MODEL 6010DW**  
With Fast Charger

**10 mm (3/8") MODEL 6010DWK**  
With Fast Charger and Plastic Case

## INSTRUCTION MANUAL



### SPECIFICATIONS

●Model 6010D Within Reversing Switch & Battery Cartridge 7000					●Battery Cartridge 7000		
Capacities		No load speed	Max. output	Net weight	Overall length	Voltage	Charging time
Steel/Wood	Wood screw						
10 mm (3/8")	4.5 x 20 mm (3/16") x (3/4")	600 R/min.	105 W	1.1 kg (2.4 lbs)	227 mm (9")	7.2 V	1 Hr

●Model DC7010 Fast Charger				
Input	Output	Dimensions (L x W x H)	Net weight	Power supply cord
115V only 50Hz-60Hz	D.C. 7.2 V 1.5 A	145 mm x 80 mm x 61 mm (5-3/4") x (3-1/8") x (2-3/8")	0.8 kg (1.8 lbs)	2 m (6.6 ft.)

\* Manufacturer reserves the right to change specifications of parts and accessories without notice.

\* Note: Specifications of parts and accessories may vary from country to country.

## SAFETY RULES FOR POWER TOOLS

1. **KEEP WORK AREA CLEAN.** Cluttered areas and benches invite accidents.
2. **KEEP CHILDREN AWAY.** All visitors should be kept safe distance from work area.
3. **STORE IDLE TOOLS.** When not in use, tools should be stored in dry, high or locked-up place – out of reach of children.
4. **DON'T FORCE TOOL.** It will do the job better and safer at the rate for which it was designed.
5. **USE RIGHT TOOL.** Don't force small tool or attachment to do the job of a heavy duty tool.
6. **WEAR PROPER APPAREL.** No loose clothing or jewelry to get caught in moving parts. Rubber gloves and footwear are recommended when working outdoors.
7. **USE SAFETY GLASSES** with most tools. Also face or dust mask if cutting operation is dusty.
8. **SECURE WORK.** Use clamps or a vise to hold work. It's safer than using your hand and it frees both hands to operate tool.
9. **DON'T OVERREACH.** Keep proper footing and balance at all times.
10. **MAINTAIN TOOLS WITH CARE.** Keep tools sharp at all times and clean for best and safest performance. Follow instructions for lubricating and changing accessories.
11. **REMOVE ADJUSTING KEYS AND WRENCHES.** Form habit of checking to see that keys and adjusting wrenches are removed from tool before turning it on.
12. **AVOID ACCIDENTAL STARTING.** Don't carry tool with finger on switch.
13. **DO NOT OPERATE** portable electric tools in gaseous or explosive atmospheres. Motors in these tools normally spark, and the sparks might ignite fumes.

## ADDITIONAL DRILL SAFETY RULES

1. Be aware that this tool is always in an operating condition, because it does not have to be plugged into an electrical outlet.
2. When drilling into walls, floors or whatever "live" electrical wires may be encountered. **DO NOT TOUCH THE CHUCK OR ANY FRONT METAL PARTS OF THE DRILL!** Hold the Drill only by the plastic handle to prevent electric shock if you drill into a "live" wire.

1. The Charger and Battery Cartridge are specifically designed to work together. **DO NOT** attempt to charge any other cordless tool or battery cartridge with this Charger. **DO NOT** attempt to charge the Battery Cartridge with any other charger.
2. **NEVER** attempt to connect 2 Chargers together.
3. Do not attempt to open the Battery Cartridge housing.
4. **DO NOT** store the Drill and Battery Cartridge in locations where the temperature may reach or exceed 50°C (122°F) (such as outside sheds or metal buildings in summer.)
5. **DO NOT** charge Battery Cartridge when temperature is **BELOW** 10°C (50°F) or **ABOVE** 40°C (104°F). This is very important.
6. **DO NOT** incinerate the Battery Cartridge even if it is severely damaged or is completely worn out. The battery cartridge can explode in a fire.
7. Avoid dangerous environment. Don't use charger in damp or wet locations.
8. The charger is designed to operate on standard household electrical power (AC only). Do not attempt to use it on any other voltage!
9. Don't abuse cord. Never carry charger by cord or yank it to disconnect from tool. Keep cord from heat, oil and sharp edges.

## CHARGING THE BATTERY CARTRIDGE

**THE BATTERIES IN YOUR NEW BATTERY CARTRIDGE ARE NOT FULLY CHARGED!** First read the Safety Rules above. Then follow charging ways and procedures on page 8.

## Cordless Drill/Screwdriver and Standard Equipment

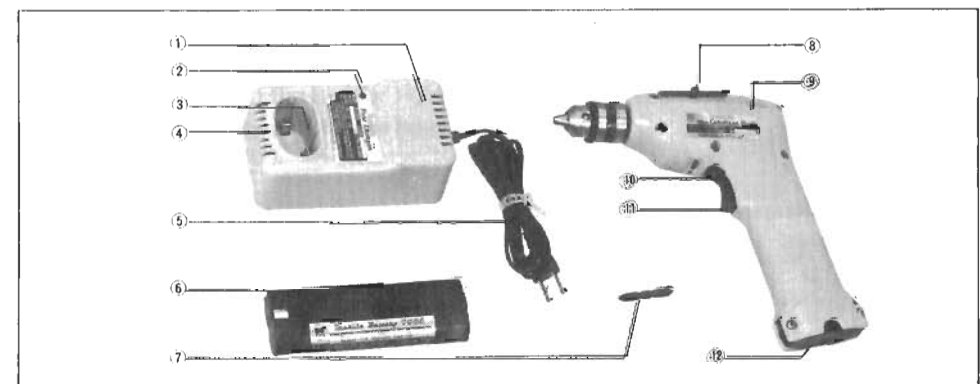

- |                              |                                 |                          |
|------------------------------|---------------------------------|--------------------------|
| ① Fast charger (DC7010)      | ⑤ Cord                          | ⑨ Tool body (6010D)      |
| ② Charging indicator light   | ⑥ Battery cartridge (removable) | ⑩ Reversing switch lever |
| ③ Port for battery insertion | ⑦ ⊕ bit (2-45)                  | ⑪ Trigger switch         |
| ④ Vents                      | ⑧ Clip-on chuck key (S10)       | ⑫ Set plate              |

## HOW TO USE

### Cordless Drill/Screwdriver Itself (Model 6010D)

1. The battery cartridge for your new cordless drill must be charged before you use the tool. Simply use the standard-equipped fast charger. The batteries are affected by temperature, so do not charge them outside or in a location exposed to direct sunlight, or charging time will be shorter and result in less than the full charge.
  - Do not expose batteries to flame, short the circuitry or discard in water or fire.
  - Do not leave your drill out in the hot sun with the battery cartridge loaded.
  - Worn-out batteries, of course, do not provide the ordinary operating time, even with a 1-hour charge. Replace when required with a new Makita battery (7000) cartridge.

### 2. Insertion and removal of cartridge

- Always switch off the tool before insertion or removal of the battery cartridge.
- To remove the battery cartridge, pull out the set plate on the bottom of the tool and grasp both sides of the cartridge while withdrawing it from the barrel.

Be sure to close the set plate fully before using the tool after you insert a cartridge. Failure to do so may result in loss or dangerous dropping of the battery cartridge on the ground.

- Do not force in the battery cartridge when inserting it. Do not attempt to pound it in either.

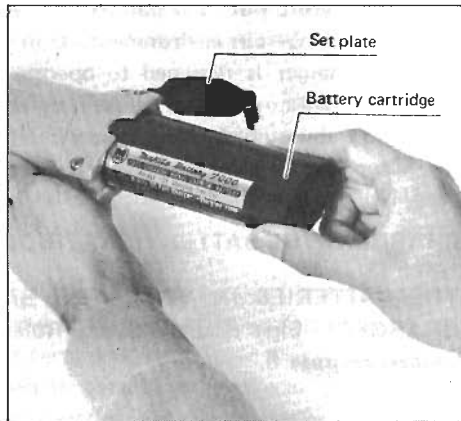

### DC7010 Fast Charger

#### 1. Location

- Perform the charging at a room temperature ranging from 10°C (50°F) to 40°C (104°F).
- Do not allow anything to cover or clog the charger vents. (There are also vents on the bottom.)

#### 2. Charging

- Insert the battery cartridge so that its plus and minus terminal are on the side with the respective indication on the fast charger itself. Insert cartridge fully into the port so that it rests on the charger port floor.
- Check to see that the charging light comes on. When it goes out, you may remove the fully charged battery cartridge.

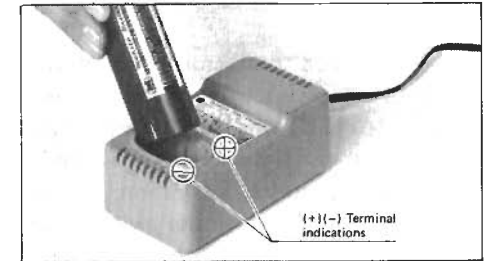

- Sometimes the charging light will not come on after you insert a cartridge from a just-operated tool. Let the cartridge cool off for a while. Then re-insert it and try to charge it once more.
- If you wish to charge two battery cartridges, allow 15 minutes between chargings on the fast battery charger.

#### Bit installation & removal

- Chuck  
When installing a drill bit, notice that there are three holes in the chuck at which you must use the key for tightening. Tighten evenly at all three holes in sequence.

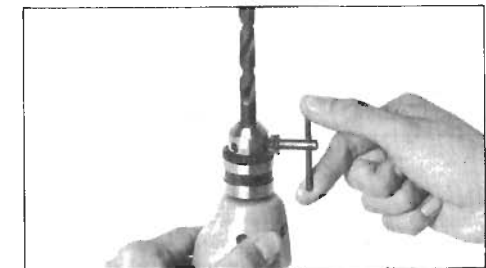

- After use, re-attach the clip-on chuck key in the hole for it on top of the tool.

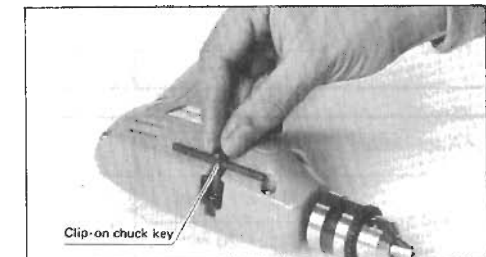

### Overload protector

- The overload protector automatically breaks the electrical circuit and the button pops out, whenever heavy drilling is prolonged. If the button is out either before or during operation, always check to see whether the switch is off before pressing the button.



### Switch operation

- The tool starts when the trigger is pulled and stops when it is released. To reverse the rotation, use the reversing switch lever equipped just above and in front of the trigger switch. However, when changing the rotational direction, be sure the trigger switch is released (OFF) and check the rotational direction. Keep the reversing switch lever in the neutral position whenever you are not using the tool.

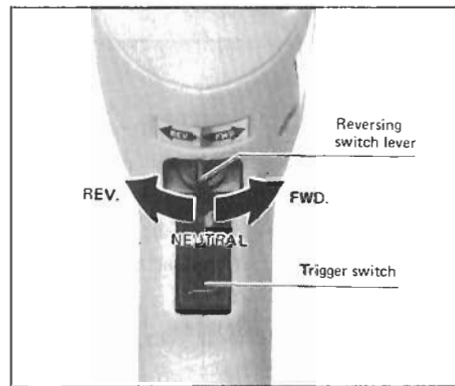

The following reference table indicates the approximate drilling and driving capacities from a single 1-hour battery charge.

Application	Diameter of hole	Material	Sheet/Board	No. holes
Metal	3 mm	Cold-rolled steel sheet or plate	1.6 mm	90
	6.5 mm			30
	3 mm	Aluminum sheet	1.6 mm	430
	10 mm			120
Wood	5 mm	Medium hard wood	2.5 mm	360
	10 mm			200

Application	Dimensions of wood screw	Material	Fastenings
Wood screws	3.5 x 20 mm	Medium hard wood	400 screws
	4.5 x 20 mm		330 screws

### Grip

- The grip shown on the right is recommended.
- Do not push hard enough to stall motor.



- The hole on the heel of the tool is a convenient way to carry it by a cord, hook or other means.

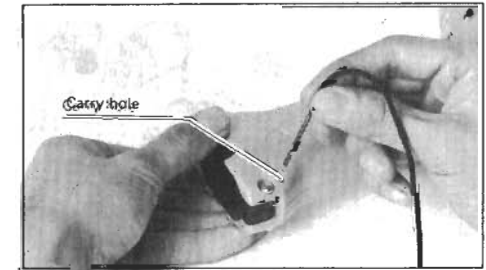

### OPTIONAL ACCESSORIES

CAUTION: The use of any other accessories not specified in this manual might be hazardous.

- Makita Battery cartridge 7000  
Part No. 632003-2



- Fast charger (DC7010) Part No. 113024-8





10 mm ( $\frac{3}{8}$ " )  
**CORDLESS DRILL**  
**Models 6010DW & 6010DWK**  
**Models 6010D Cordless Drill**  
**and DC7010 Charger**

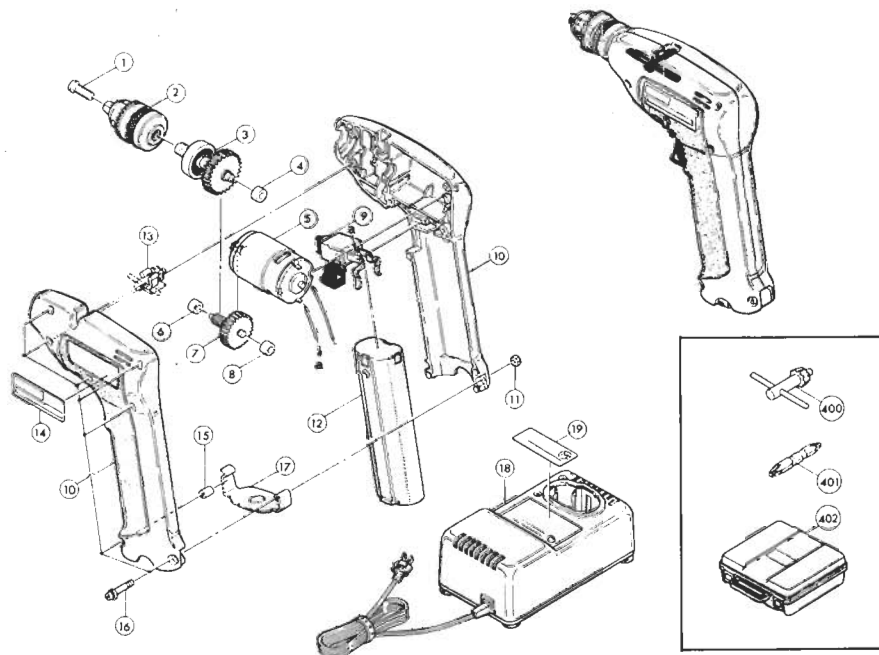

ITEM NO. USED	DESCRIPTION	ITEM NO. USED	DESCRIPTION
<b>MACHINE</b>		<b>MACHINE</b>	
Model 6010D Cordless Drill		Model DC7010 Charger	
1	P. H. Screw M5x18	18	Charger
2	Drill Chuck S10	19	Name Plate
3	Gear (With Ball Bearing 6200ZZ, Spindle & Retaining Ring S10)	<b>ACCESSORIES</b>	
4	Plane Bearing 5	400	Chuck Key S10
5	Motor (17.2 V. D.C.)	401	Bit 2-45
6	Plane Bearing 3	402	Plastic Case For Model 6010DWK
7	Gear T3-58		
8	Plane Bearing 3		
9	Double Pole Switch (With Reversing) TG2A		
10	Housing Set		
11	H. Nut M4		
12	Battery 7000 (7.2 V.)		
13	Holder 6		
14	Name Plate (For Model 6010D)		
15	Sleeve 5		
16	P. H. Screw M4x22 (With Washer)		
17	Set Plate		



**Makita Electric Works, Ltd.**  
 Anjo, Aichi, Japan

883137-068 A

PRINTED IN JAPAN  
 1981-10-N

6010DW



**Makita**  
**Fast Chargers**

**MODEL DC7010**  
**MODEL DC9000**

## INSTRUCTION MANUAL

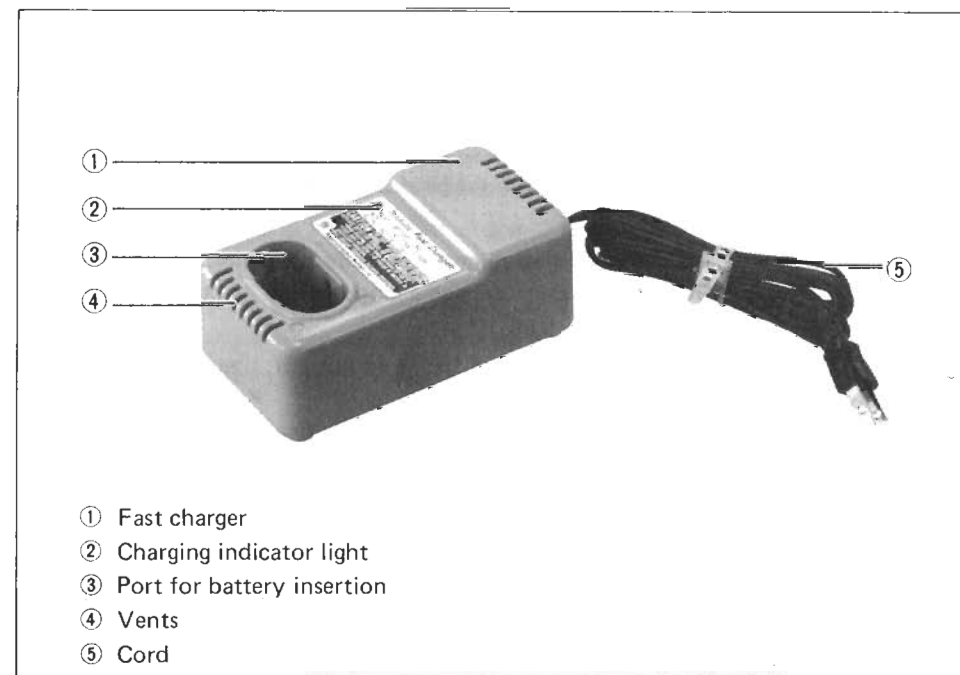

### Specifications

Model	Input	Output	Dimensions (L x W x H)	Net weight	Power supply cord
DC7010	A.C. 115 V 50 Hz - 60 Hz	D.C. 7.2 V 1.5 A	145 mm x 80 mm x 61 mm (5-3/4" x 3-1/8" x 2-3/8")	0.8 kg (1.8 lbs)	2 m (6.6 ft.)
DC9000		D.C. 9.6 V 1.5 A	145 mm x 80 mm x 68 mm (5-3/4" x 3-1/8" x 2-3/4")	1 kg (2.2 lbs)	

\* Manufacturer reserves the right to change specifications of parts and accessories without notice.

\* Note: Specifications of parts and accessories may vary from country to country.

# IMPORTANT SAFETY INSTRUCTIONS

1. **SAVE THESE INSTRUCTIONS** – This manual contains important safety and operating instructions for battery charger Models DC7010 and DC9000.
2. Before using battery charger, read all instructions and cautionary markings on (1) battery charger, (2) battery, and (3) product using battery.
3. **CAUTION** – To reduce risk of injury, charge only MAKITA type rechargeable batteries. Other types of batteries may burst causing personal injury and damage.
4. Do not expose charger to rain or snow.
5. Use of an attachment not recommended or sold by the battery charger manufacturer may result in a risk of fire, electric shock, or injury to persons.
6. To reduce risk of damage to electric plug and cord, pull by plug rather than cord when disconnecting charger.
7. Make sure cord is located so that it will not be stepped on, tripped over, or otherwise subjected to damage or stress.
8. An extension cord should not be used unless absolutely necessary. Use of improper extension cord could result in a risk of fire and electric shock. If extension cord must be used, make sure:
  - a. That pins on plug of extension cord are the same number, size, and shape as those of plug on charger;
  - b. That extension cord is properly wired and in good electrical condition; and
  - c. That wire size is large enough for AC ampere rating of charger as specified in Table 1.

**TABLE 1  
RECOMMENDED MINIMUM AWG SIZE FOR  
EXTENSION CORDS FOR BATTERY  
CHARGERS**

AC Input Rating, Amperes		AWG Size of Cord			
Equal to or greater than	but less than	Length of Cord, Feet			
		25	50	100	150
0	2	18	18	18	16
2	3	18	18	16	14
3	4	18	18	16	14
4	5	18	18	14	12
5	6	18	16	14	12
6	8	18	16	12	10

883137--068 A

AC Input Rating, Amperes		AWG Size of Cord			
Equal to or greater than	but less than	Length of Cord, Feet			
		25	50	100	150
8	10	18	14	12	10
10	12	16	14	10	8
12	14	16	12	10	8
14	16	16	12	10	8
16	18	14	12	8	8
18	20	14	12	8	6

9. Do not operate charger with damaged cord or plug – replace them immediately.
10. Do not operate charger if it has received a sharp blow, been dropped, or otherwise damaged in any way; take it to a qualified serviceman.
11. Do not disassemble charger; take it to a qualified serviceman when service or repair is required. Incorrect reassembly may result in a risk of electric shock or fire.
12. To reduce risk of electric shock, unplug charger from outlet before attempting any maintenance or cleaning. Turning off controls will not reduce this risk.
13. Perform the charging at a room temperature ranging from 10°C (50°F) to 40°C (104°F).
14. Do not allow anything to cover or clog the charger vents. (There are also vents on the bottom.)
15. The Model DC7010 Fast Charger is designed to charge Makita Battery Cartridge 7000 and the Model DC9000 Fast Charger is designed to charge Makita Battery Cartridge 9000. **DO NOT** attempt to charge any other battery with these chargers.

## Operation

- Insert the battery cartridge so that its plus and minus terminal are on the side with the respective indication on the fast charger itself. Insert cartridge fully into the port so that it rests on the charger port floor.

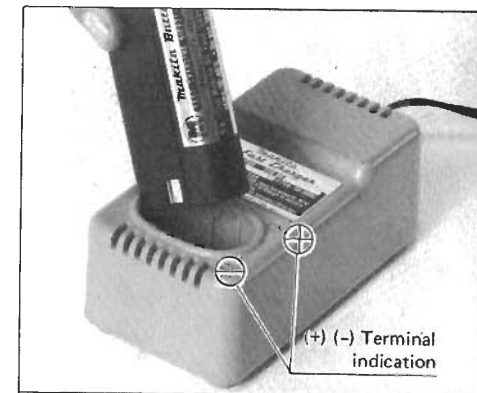

- Check to see that the charging light comes on. When it goes out, you may remove the fully charged battery cartridge.

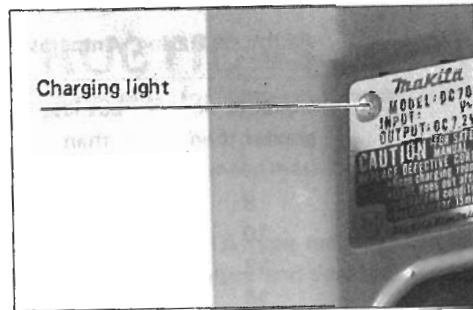

### Storage

- The best storage place is one that is cool and dry — away, from direct sunlight and excess heat or cold.