

HAKKO FX-888

SOLDERING STATION

Instruction Manual

Thank you for purchasing the HAKKO FX-888 Soldering Station.
Please read this manual before operating the HAKKO FX-888.
Keep this manual readily accessible for reference.

1. PACKING LIST AND PART NAMES

HAKKO FX-888 Station	1	Hexagon wrench	1
HAKKO FX-8801 Soldering Iron	1	CAL adjustment driver*	1
Iron holder	1	Cleaning wire	1
Instruction Manual	1	*CAL adjustment driver is attached to the bottom of the station.	

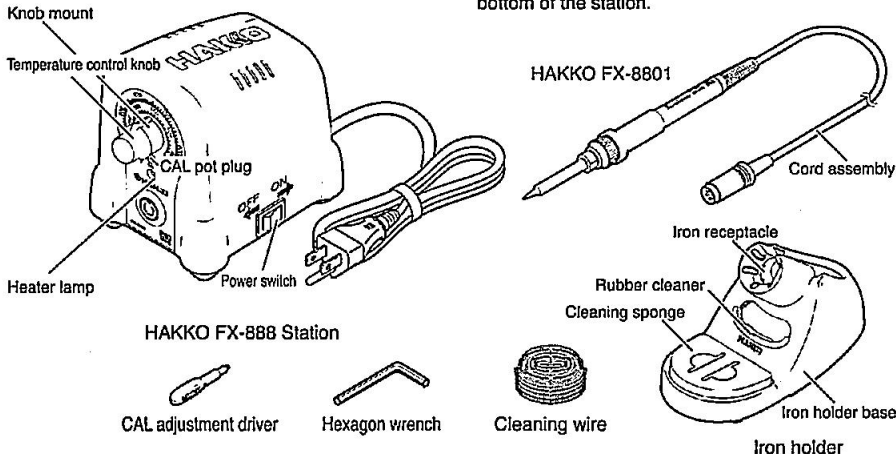

*HAKKO FX-8802 / FX-8803 / FX-8804 (not included) can be connected to HAKKO FX-888 station.
*When using above FX-8802/FX-8803/FX-8804, please use it with the dedicated iron holder.

2. SPECIFICATIONS

Power consumption	70W
Station	
Output	AC26V
Temperature Range	200~480°C (400~900°F)
Temperature Stability	±1°C (1.8°F) at idle temperature
Dimensions (W x H x D)	100(W) x 120(H) x 130(D)mm
Weight(w/o cord)	1.3kg

* The temperature was measured using the FG-100 thermometer.
* This product is protected against electrostatic discharge.
* Specifications and design are subject to change without notice.

HAKKO FX-8801 Soldering Iron	
Power Consumption	AC26V 65W
Tip to Ground Resistance	<2Ω
Tip to Ground Potential	<2mV
Heating Element	Ceramic heater
Cord	1.2m
Total Length (w/o cord)	190mm
Weight (w/o cord)	44g

※ 各言語 (日本語、英語、中国語、フランス語、ドイツ語、韓国語) の取扱説明書は以下のURL、HAKKO Document Portalからダウンロードしてご覧いただけます。(商品によっては設定のない言語がありますが、ご了承ください)
* 各語言(日語、英語、中文、法語、德語、韓語)的使用說明書可以通過以下網站的HAKKO Document Portal 下載參閱。
(有一部分的產品沒有設定外語對照,請見諒)
* Instruction manual for the language, Japanese, English, Chinese, French, German and Korean can be downloaded from the following URL, HAKKO Document Portal.
(Please note that some language may not be available depending on the product.)

<https://doc.hakko.com>

HAKKO CORPORATION
HEAD OFFICE
TEL: +81-6-6561-3225 FAX: +81-6-6561-8486
<http://www.hakko.com> E-mail: sales@hakko.com
OVERSEAS AFFILIATES
U.S.A.: AMERICAN HAKKO PRODUCTS, INC.
TEL: (881) 294-0090 FAX: (601) 294-0090
Toll Free (800)88-HAKKO
<http://www.hakkousa.com>
HONG KONG: HAKKO DEVELOPMENT CO., LTD.
TEL: 2811-5568 FAX: 2590-0217
<http://www.hakko.com.hk>
E-mail: info@hakko.com.hk
SINGAPORE: HAKKO PRODUCTS PTE., LTD.
TEL: 6748-2277 FAX: 6744-0033
<http://www.hakko.com.sg>
E-mail: sales@hakko.com.sg

Please access to the following address for the other Sales affiliates.

<http://www.hakko.com>

中國RoHS: 產品中有毒有害物質或元素的名稱及含量

部件名稱	有毒有害物質或元素					
	鉛Pb	汞Hg	鎘Cd	六價鉻(CrVI)	多環芳烴(PAH)	多環二苯基聯(PBDE)
焊錫部	×	○	○	○	○	○
電路板	×	○	○	○	○	○
插頭	×	○	○	○	○	○

○: 表示該有毒有害物質在該部件所有均質材料中的含量均在SJ/T 11363-2006標準規定的限量要求以下。
×: 表示該有毒有害物質至少在該部件的某一均質材料中的含量超出SJ/T 11363-2006標準規定的限量要求。

7. PARTS LIST

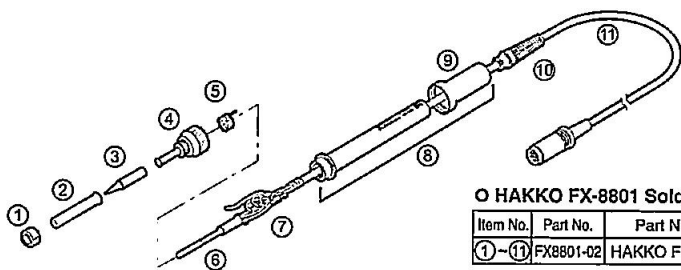

○ HAKKO FX-8801 Soldering Iron

Item No.	Part No.	Part Name	Specifications
①-⑪	FX8801-02	HAKKO FX-8801	With 1.6D tip

○ Soldering Iron Parts

Item No.	Part No.	Part Name	Specifications
①	B1785	Nut	
②	B3469	Tip enclosure	
③		Tip	See *8. TIP STYLES*
④	B2022	Nipple	
⑤	B2032	Grounding spring	
⑥	A1560	Heating element	26V-65W
⑦	B2028	Terminal board	With cord stopper
⑧	B3470	Handle	With handle cover
⑨	B3471	Handle cover	
⑩	B3467	Cord bushing	
⑪	B3468	Cord assembly	

○ HAKKO FH-800 Iron Holder

Item No.	Part No.	Part Name	Specifications
①-⑥	FH800-01BY	HAKKO FH-800	Blue-Yellow

○ Iron Holder Parts

Item No.	Part No.	Part Name	Specifications
①	A1559	Cleaning sponge	
②	B3472	Iron holder base	Blue-Yellow with rubber feet
③	B3474	Rubber cleaner	
④	B3475	Bottom plate	With rubber feet
⑤	B3476	Slide lock	
⑥	A1561	Cleaning wire	

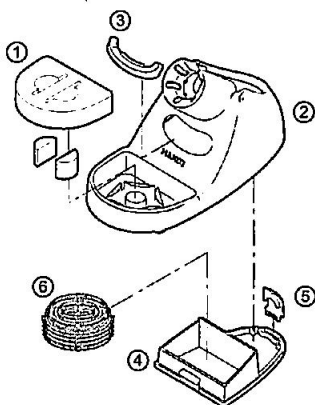

8. TIP STYLES

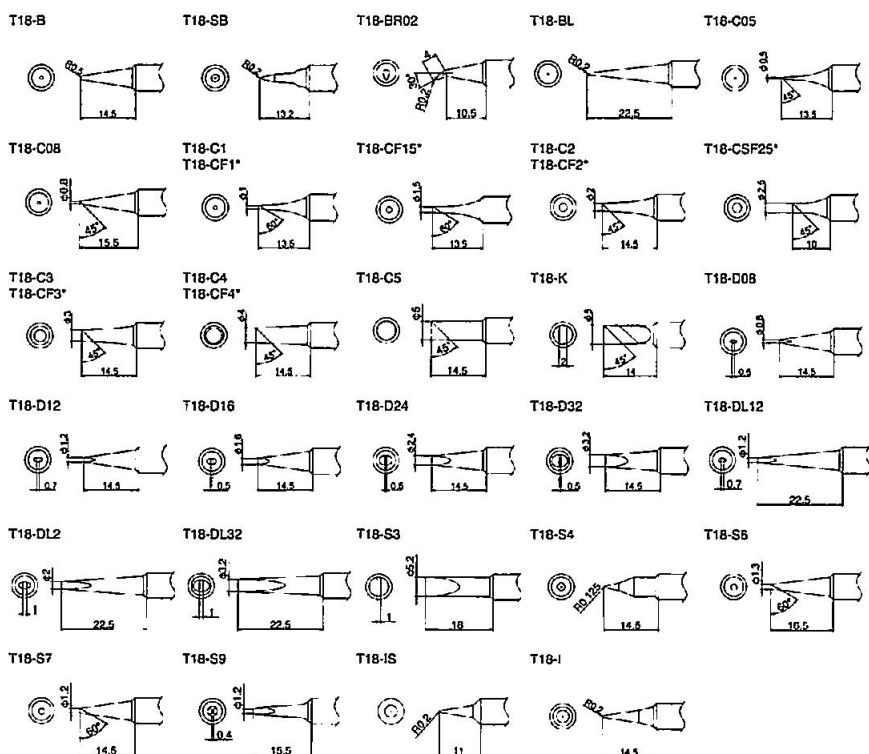

* Tinned on the soldering surface only.

☑ Use only genuine Hakko soldering iron tips. Replacement tips for the HAKKO FX-888 are designated the T18 series.

4. OPERATION

D. Turn on the Power Switch

The heater lamp is on as the tip comes up to the set temperature. The heater lamp blinks on and off when the set temperature is reached. The unit is now ready to perform soldering work.

⚠ CAUTION

- The iron must be placed in the iron holder when not in use.
- Turn the power off when not using the station for a long time.

E. After Use

When done, wipe the tip clean and coat the tip with fresh

5. MAINTENANCE

Performing proper and periodic maintenance extends the products life and contributes to use it always in a good condition. Efficient soldering depends upon the temperature, the quality and quantity of the solder and flux. Apply the following service procedure as dictated by the conditions of the usage.

⚠ WARNING

Since the soldering iron can reach a very high temperature, please work carefully. Except the case especially indicated, always turn the power switch OFF and disconnect the power plug before performing any maintenance procedure.

○ Tip Maintenance

1. Set the temperature to 250°C (482°F).
2. When the temperature stabilizes, clean the tip with the cleaning sponge and check the condition of the tip.
3. If the solder plated part of the tip is covered with black oxide, apply fresh solder, containing flux, and clean the tip again. Repeat until all the oxide is removed, then coat the tip with fresh solder.
4. If the tip is deformed or heavily eroded, replace it with a new one.

⚠ CAUTION

Do not file the tip in an attempt to remove the black oxide.

Use the cleaning sponge that comes with the product to clean the tip. It offers wide-ranging uses, from simple removal of excess solder to complete elimination of matter occurring as a result of oxidation.

Cleaning the tip using the iron holder

1. Using the cleaning sponge

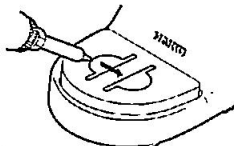

2. Using the rubber cleaner

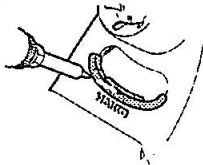

3. Using a cleaning wire

If a cleaning wire is used, place it in the bottom plate as shown on the right.



Alternatively, you can use the rubber cleaner to clean the tip as shown on the left. It is convenient way of removing excess solder.

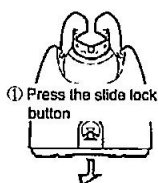

- ② Keep pressing the slide lock button, and remove the bottom plate.

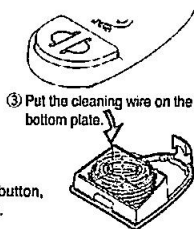

Material that is not removed easily with the cleaning sponge or rubber cleaner can likely be removed using the cleaning wire.

NOTE

If solder debris builds up in the bottom plate, remove the bottom plate in the same way.

○ Calibration of the Tip Temperature

The tip temperature should be recalibrated after changing the iron, or replacing the heating element or tip.

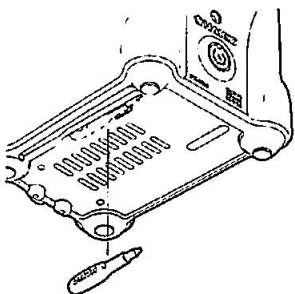

1. Connect the cord assembly to the receptacle on the station.
2. Set the temperature control knob to 350°C (662°F).
3. Turn the power switch to "ON" and wait until the temperature stabilizes. Remove the CAL pot plug.
4. When the iron tip temperature stabilizes, measure the tip temperature using an tip thermometer. As necessary, fit the included CAL adjustment driver in the hole in the station indicated by the CAL marking, and make adjustments so that the tip temperature is 350°C (662°F).

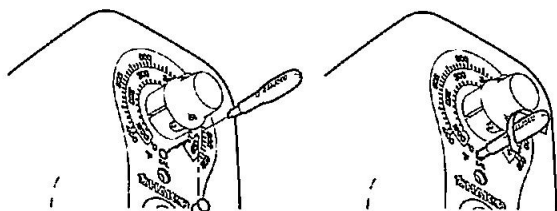

5. MAINTENANCE

Disconnect the plug of the cord assembly and measure the resistance value between the pins of the connecting plug as follows.

If the values of "a" and "b" are outside the value in the table, replace the heating element (sensor) and/or cord assembly.

If the value of "c" is over the value in the table, remove the oxidization film by lightly rubbing with sand-paper or steel wool the points shown in the drawing on the right.

a. Between pins 4 & 5 (Heating Element)	2.5 - 3.5 Ω (at time of room temperature)
b. Between pins 1 & 2 (sensor)	43 - 58 Ω
c. Between pin 3 & Tip	2 Ω or less

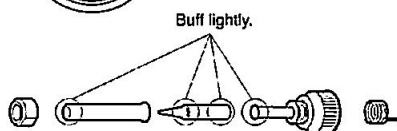
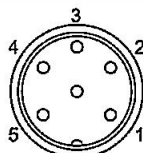

○ Disassembling

1. Broken Heating Element/Sensor

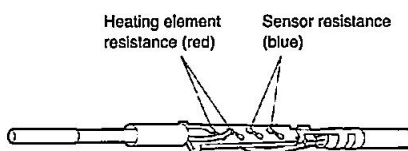
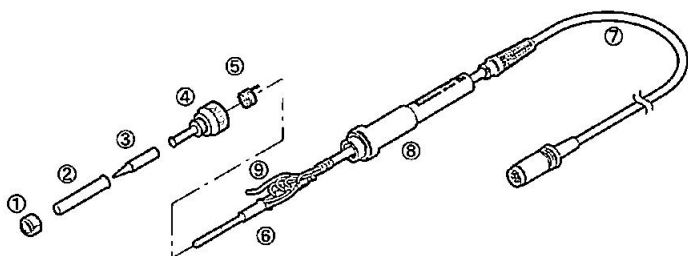

1. Turn the nut ① counterclockwise and remove the tip enclosure ② and the tip ③.
2. Turn the nipple ④ counterclockwise and remove it from the iron.
3. Pull both the heating element ⑥ and the cord assembly ⑦ out of the handle ⑧. (Toward the tip of the iron).
4. Pull the grounding spring ⑤ out of the sleeve of the terminal ⑨.

* Measure when the heating element is at room temperature.

1. Heating element resistance (red) 2.5 - 3.5 Ω
2. Sensor resistance (blue) 43- 58 Ω

If the resistance value is not normal, replace the heating element. (Refer to the instructions included with the replacement part.)

After replacement

- ① Measure the resistance between pins 4 and 1, 4 and 2, 5 and 1, and 5 and 2. If it is not ∞ , the heating element and sensor are touching. This will damage the circuit board.
- ② Measure the resistance "a," "b," and "c" to confirm that the leads are not twisted and that the grounding spring is properly connected.

1. Turn the unit ON and set the temperature control knob to 480°C (900°F). Then bend the iron cord at various locations along its length, including in the strain relief area. If the LED heater lamp flashes, then the cord needs to be replaced.

2. Broken Cord Assembly

There are two methods of testing the cord assembly.

⚠ CAUTION

The power lamp starts to flash when the temperature reaches 480°C (900°F) regardless of the condition of the cord.

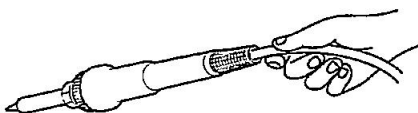

2. Check the resistance between the plug pin and the terminal lead.
Pin 1: Red Pin 2: Blue Pin 3: Green Pin 4: White Pin 5: Black
Resistance: 0 Ω .
If it is higher than 0 Ω or is ∞ , the cord should be replaced.

⚠ CAUTION

This product includes such features as electrically conductive plastic parts and grounding of the handpiece and station as measures to protect the device to be soldered from the effects of static electricity. Be sure to observe the following instructions:

1. The handle and other plastic parts are not insulators, they are conductors. When making repairs or replacing parts, take sufficient care not to expose live electrical parts or damage insulation materials.
2. Be sure to ground the unit during use.

3. WARNINGS, CAUTIONS, NOTES AND EXAMPLES

⚠ WARNING

Warnings, cautions and notes are placed at critical points in this manual to direct the operator's attention to significant items. They are defined as follows:

- ⚠ **WARNING:** Failure to comply with a WARNING may result in serious injury or death.
- ⚠ **CAUTION :** Failure to comply with a CAUTION may result in injury to the operator, or damage to the items involved.

⚠ CAUTION

When power is ON, tip temperatures will be between 200 and 480°C. (400 to 900°F.) To avoid injury or damage to personnel and items in the work area, observe the following:

- Do not touch the tip or the metal parts near the tip.
- Do not allow the tip to come close to, or touch, flammable materials.
- Inform others in the area that the unit is hot and should not be touched.
- Turn the power off when not in use, or left unattended.
- Turn the power off when changing parts or storing the HAKKO FX-888.
- This appliance is not intended for use by persons (including children) with reduced physical, sensory or mental capabilities, or lack of experience and knowledge, unless they have been given supervision or instruction concerning use of the appliance by a person responsible for their safety.
- Children should be supervised to ensure that they do not play with the appliance.
- If the power cord is damaged, it must be replaced by the manufacturer, its service agent or similarly qualified person in order to avoid personal injury or damage to the unit.

To prevent accidents or damage to the HAKKO FX-888, be sure to observe the following:

- Do not use the HAKKO FX-888 for applications other than soldering.
- Do not strike the iron against hard objects to remove excess solder. This will damage the iron.
- Do not modify the HAKKO FX-888.
- Use only genuine Hakko replacement parts.
- Do not allow the HAKKO FX-888 to become wet, or use it with wet hands.
- Remove power and iron cords by holding the plug, not the wires.
- Be sure the work area is well ventilated. Soldering produces smoke.
- While using the HAKKO FX-888, don't do anything which may cause bodily harm or physical damage.

4. OPERATION

A. Iron Holder

○ The sponge is compressed. It will swell when moistened with water. Before using the unit, dampen the sponge with the water.

1. Fit the small sponge in the hollows of the iron holder base.
2. Add an appropriate amount of water into the iron holder base. The small sponge will absorb water to keep the wet state at all times.
3. Dampen the large sponge and place it on the iron holder base.

* When Using a Cleaning Wire
See "3. Using a Cleaning Wire" in section "5. MAINTENANCE"

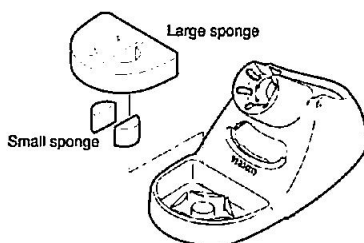

⚠ CAUTION

Be sure the sponge is moistened with water before use to avoid damaging the tip.

B. Connections

⚠ CAUTION

Be sure to turn off the power before connecting or disconnecting the cord assembly for the iron to and from the receptacle to avoid damaging the circuit board.

1. Connect the cord assembly to the receptacle.

⚠ CAUTION

• Do not use an iron other than the HAKKO FX-8801. Doing so may not result in the performance indicated in the specifications.

2. Place the iron into the iron holder.
3. Plug the power cord into the power supply.

⚠ CAUTION

This unit is protected against electrostatic discharge and must be grounded for full efficiency.

Push on the plug until it stops, making sure it is securely connected.

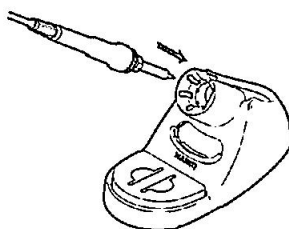

C. Setting the temperature

1. Set the temperature control knob to the desired temperature.

2. Lock the knob.

The HAKKO FX-888 station is equipped with a temperature control knob lock. (See the drawing on the right.)

After setting the desired temperature, tighten the hexagon socket head cap screw on the underside of the knob mount using the supplied hexagon wrench. Turn the nut clockwise to tighten the knob lock.

⚠ CAUTION

- Don't overtighten the hexagon socket head cap screw.
- Don't attempt to turn the knob when the knob lock is on.

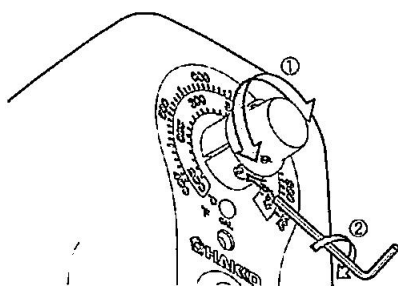

6. TROUBLE SHOOTING GUIDE

⚠ WARNING

- Before checking the below, be sure to disconnect the power plug.
- If the power cord is damaged, it must be replaced by the manufacturer, its service agent or similarly qualified person in order to avoid personal injury or damage to the unit.

- | | |
|---|--|
| <ul style="list-style-type: none"> ○ Nothing happens when the power switch is turned on. | <p>CHECK: Is the power cord and/or connecting plug disconnected?
 ACTION: Connect it.</p> |
| <ul style="list-style-type: none"> ○ The heater lamp lights up but the tip does not heat up. | <p>CHECK: Is the cord assembly broken? Is the heating element/sensor broken?
 ACTION: Refer to "Broken Cord Assembly" and "Broken Heating Element/Sensor."</p> |
| <ul style="list-style-type: none"> ○ The tip heats up intermittently. | <p>CHECK: Is the cord assembly broken?
 ACTION: Refer to "Broken Cord Assembly."</p> |
| <ul style="list-style-type: none"> ○ Solder does not wet to the tip. | <p>CHECK: Is the tip temperature too high?
 ACTION: Set an appropriate temperature.
 CHECK: Is the tip coated with black oxide?
 ACTION: Remove the black oxide. (Refer to "Tip Maintenance.")</p> |
| <ul style="list-style-type: none"> ○ The tip temperature is too low. | <p>CHECK: Is the tip coated with black oxide?
 ACTION: Remove the black oxide. (Refer to "Tip Maintenance.")
 CHECK: Is the iron temperature calibrated correctly?
 ACTION: Recalibrate.</p> |
| <ul style="list-style-type: none"> ○ The tip can not be pulled off. | <p>CHECK: Is the tip seized? Is the tip swollen because of deterioration?
 ACTION: Replace the tip and the heating element.</p> |
| <ul style="list-style-type: none"> ○ The tip doesn't hold the desired temperature. | <p>CHECK: Is the iron temperature calibrated correctly?
 ACTION: Recalibrate.</p> |

7. PARTS LIST

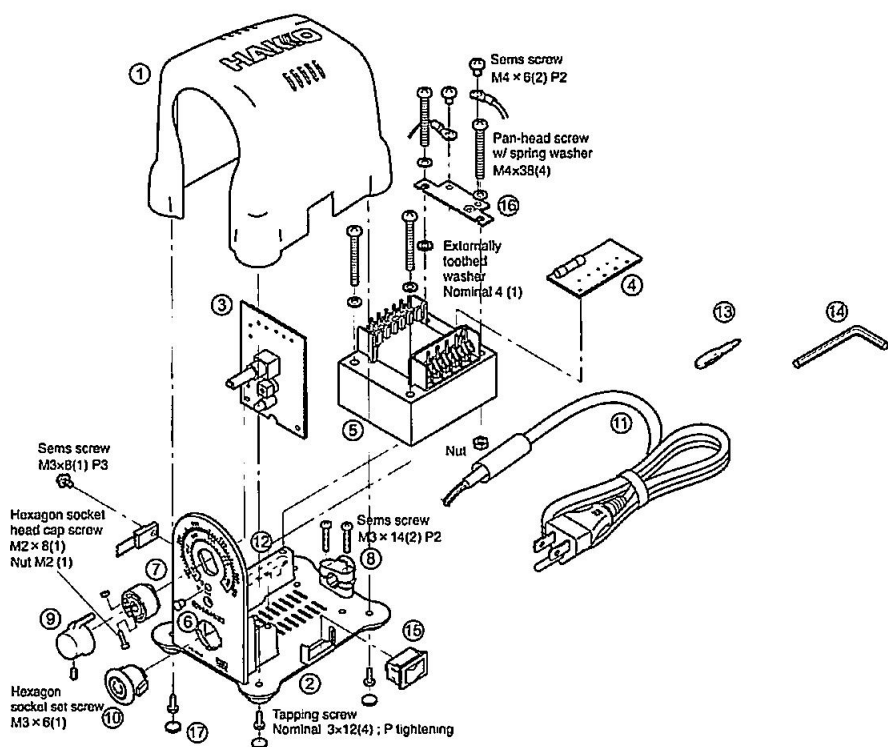

○ HAKKO FX-888 Station

Item No.	Part No.	Part Name	Specifications
①	B3450	Upper case / BY	
②	B3454	Chassis / Yellow	For BY
③	B3456	P.W.B.	For temperature control
④	B3457	P.W.B. / 100-120V	With fuse and rubber feet
	B3490	P.W.B. / 220-240V	With fuse and rubber feet
⑤	B3562	Transformer	120V
	B3491	Transformer	220-240V
⑥	B3459	CAL pot plug	
⑦	B3460	Knob mount	
⑧	B3461	Cord stopper	
⑨	B3462	Knob	With hexagon socket set screw

Item No.	Part No.	Part Name	Specifications
⑩	B3463	Receptacle	
	B3492	Power cord, 3 wired cord & American plug	With tube, USA
	B3493	Power cord 3 wired cord but no plug	With tube
	B3494	Power cord, 3 wired cord & BS plug	With tube
	B3495	Power cord, 3 wired cord & European plug	With tube, CE
	B3496	Power cord, 3 wired cord & BS plug	With tube, CE
	B3497	Power cord, 3 wired cord & Australian plug	With tube
	B3498	Power cord, 3 wired cord & Chinese plug	With tube
	B3499	Power cord, 3 wired cord & SI plug	With tube
	B3500	Power cord, 3 wired cord & American plug	With tube
⑫	B3465	Driver support	
⑬	B3466	CAL adjustment driver	
⑭	B2017	Hexagon wrench	
⑮	B2852	Switch	
⑯	B2227	Grounding plate	
⑰	B2405	Rubber feet	