



ELECTRONICS



for PRESENT and POST-WAR PRODUCTS

An editorial summary of types of electronic tubes
and how they operate. Elementary electronic circuits are presented
and their typical industrial applications indicated.

★ What Electron Tubes and Circuits Can Do

From the standpoint of industrial electronics, the fundamental operations of electron tube circuits can be classified into eight groups as follows:

1. **RECTIFIER OPERATION** — alternating current can be transformed to direct current.
2. **AMPLIFIER OPERATION** — small voltages can be increased by amplification to operate power switches and relays.
3. **OSCILLATOR OR INVERTER OPERATION** — direct current can be changed to alternating current of any desired frequency.
4. **PHOTOTUBE OPERATION** — light can be converted into electrical voltage or current.
5. **CATHODE RAY TUBE OPERATION** — electrical phenomena can be “plotted” on screen of cathode ray tube.
6. **CONTROLLED RECTIFICATION** — alternating current can be changed to any value of direct current at will, within rating of tube.
7. **X-RAY TUBE OPERATION** — electrical energy converted into radiant energy of short wavelength having high penetrating power.
8. **VOLTAGE REGULATION** — voltage can be automatically maintained within a definite and narrow range.

★ How Electron Tubes Operate

The two basic types of electron tubes are the two-element diode and the three-element triode.

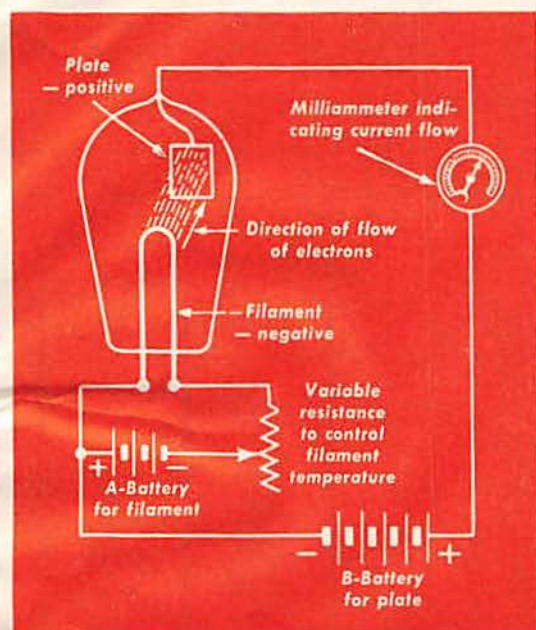

HOW THE DIODE OPERATES

Battery A heats filament of tube causing electrons (negatively charged particles of electricity) to be "boiled off" and surround the filament. Plate, positively charged by battery B, attracts electrons. The flow of electrons from filament to plate constitutes an electric current through tube as indicated by milliammeter. Current through tube will depend upon number of electrons available (determined by filament temperature) and B-battery voltage. Note — Conventional designation for direction of current flow, from positive to negative, was made arbitrarily before true nature of current was established; actually it is known that electrons flow from negative to positive electrodes.

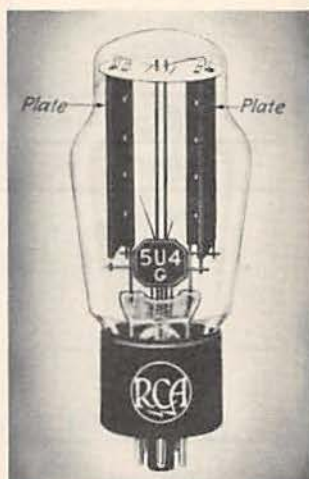

Diode with two plates for full wave rectification. Filament is hidden by the plates.

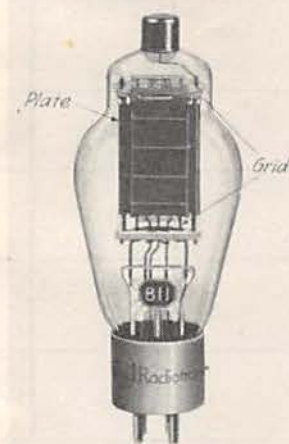

Three element tube or triode. The filament or cathode, providing source of electrons is hidden by the plate.

HOW THE TRIODE OPERATES



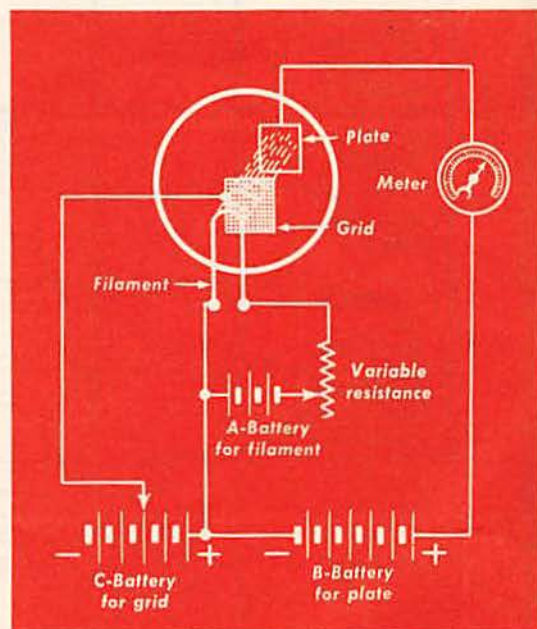









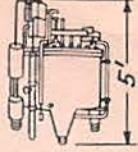











The addition of a grid, between filament and plate, enables the current through the tube to be easily controlled. If the grid is sufficiently negative, relative to filament, it repels all electrons and none can flow to plate. Decreasing the negative voltage on grid permits electrons in increasing numbers to pass through interstices of grid and pass on to plate to establish plate current. Magnitude of plate current (number of electrons flowing between filament and plate) can be controlled by grid-filament voltage. Relatively large power in plate circuit can be controlled by minute changes in grid voltage. Changes in grid voltage require only infinitesimal amounts of power.



OTHER TYPES OF ELECTRON TUBES — From these two basic types of tubes many other industrial electronic devices have been developed. The most common tubes and circuit functions for industrial use are described on the two following pages.

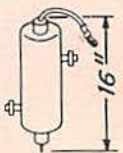

CLASSIFICATION OF ELECTRON TUBES FOR INDUSTRY

APPROXIMATE AVERAGE SIZE		 TUNGAR OR RECTIGON			 KENOTRON		 PLIOTRON		 GRID POOL TUBE	
TYPICAL APPLICATIONS		1. Battery charging installations. 2. Low voltage, high current rectifiers. 3. Relaxation oscillators. 4. Voltage rectifiers for a-c generator sets.			1. High voltage, low current rectifiers for radio receivers. 2. Vacuum tube voltmeters. 3. Power supplies for broadcast and television stations and apparatus.		1. Amplifiers and oscillators for communication. 2. Induction heating. 3. Industrial control applications. 4. Frequency multipliers and dividers. 5. Diathermy uses.		1. High voltage, high current controlled rectifier for large power applications. 2. Railway power supply. 3. Switching and commutation. 4. Current and power control.	
INPUT		ELECTRICAL ENERGY								
OUTPUT		ELECTRICAL ENERGY								
SOURCE OF ELECTRONS		Thermionic Cathode					Pool Cathode			
METHOD OF CONTROL		None			Electrostatic		None	Electrostatic	Igniter Electrode	
CHARACTER OF CONTROLLED REGION OR SPACE		High Pressure Gas	Low Pressure Gas	Vacuum	Gas or Vapor	Vacuum	Vapor	Vapor	Vapor	
TUBE NAME		Tungar or Rectigon	Phanotron	Kenotron	Thyratron	Pliotron	Pool Tube	Grid Pool Tube	Ignitron	
FUNCTION	RECTIFIER OR SWITCH									
	CONTROLLED RECTIFIER									
	AMPLIFIER									
	OSCILLATOR, GENERATOR OR INVERTER									
	VOLTAGE REGULATOR									
	WAVE FORM ANALYSIS									
	LIGHT DETECTION AND MEASUREMENT									
	PRODUCTION OF RADIANT ENERGY (Usually Light)									
TYPICAL APPLICATIONS		1. Voltage limiting or breakdown devices. 2. Pulse generators. 3. Trigger devices. 4. Relaxation oscillators. 5. Visual indicators. 6. Rectifiers.			1. Voltage or phase controlled rectifier. 2. DC to AC inverter. 3. Electronic welding. 4. Commutation and switching. 5. Motor speed control. 6. Electrical timing.		1. High voltage, high current rectifier. 2. Commutation and switching. 3. Power supply for railway and street car systems. 4. Current and power control.		1. Spot welding control. 2. Illumination control. 3. Motor commutation. 4. Frequency transformation. 5. High voltage, high current rectifier. 6. DC to AC inversion.	
APPROXIMATE AVERAGE SIZE		 PHANOTRON		 THYRATRON		 POOL TUBE		 IGNITRON (Sealed off)		



GLOW TUBE

1. Voltage regulator and stabilizer.
2. Visual indicator.
3. Relaxation oscillator.
4. Production of light.
5. Rectification.
6. Protection of circuits.

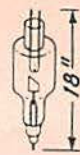

X-RAY TUBE

1. Medical examinations.
2. Industrial examinations of products.
3. Crystal examination.
4. Detection of forged or altered paintings.
5. Diffraction studies.



CATHODE RAY TUBE

1. Television receiving tube.
2. Visual indicator for electrical measurements of all kinds.
3. Application to industrial measurements.
4. Brain wave studies.

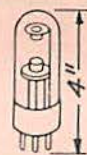

STROBOTRON

1. Control tube for photographic uses.
2. Source of intermittent light flashes.
3. Stroboscopic measurements.
4. "Slowing action" of recurrent moving mechanisms.



VACUUM PHOTOTUBE

1. Measurement of light and color.
2. Picture transmission.
3. Spectro-photometers.
4. Measurement and control of high temperature.
5. Measurement of glare.

ENERGY							RADIANT ENERGY (Light)		
							ELECTRICAL ENERGY		
Cold Cathode		Thermionic Cathode				Cold Cathode	Photoelectric Cathode		
None	Electro-static	None	Electro-static	Electro-static	Electro-magnetic	Electro-static	Radiant Energy (Light)		
Gas	Gas	Vacuum	Vacuum	Vacuum	Vacuum	Gas	Gas	Vacuum	Vacuum
Glow Tube	Grid Glow Tube	X-Ray Tube	Electron Ray Tube	Cathode Ray-Tube	Cathode Ray Tube	Strobo-tron	Phototube	Phototube	Secondary Multiplier

1. Controlled voltage regulator and stabilizer.
2. Relaxation oscillator.
3. Remote control applications.
4. Production of light.
5. Current or power control.

1. Visual indicator of voltage.
2. Bridge balancing indicator.
3. Tuning indicator on radio receivers.
4. Measurement of voltage, current or power.

1. Television tube.
2. Measurement of e/m of electron.
3. Visualizing electrical phenomena.
4. Industrial and electrical measurements.
5. Medical applications.

1. Industrial counting, sorting, weighing.
2. Light control element.
3. Industrial protection and control.
4. Intrusion detector.
5. Sound-on-film uses.

1. Measurement and control of light and color.
2. Measurement of density, transmission, opacity, glare.
3. Light control device of high sensitivity.

GRID GLOW TUBE



ELECTRON RAY TUBE



CATHODE RAY TUBE



GAS PHOTOTUBE



SECONDARY MULTIPLIER

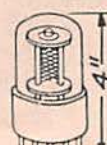

RECTIFIER CIRCUIT

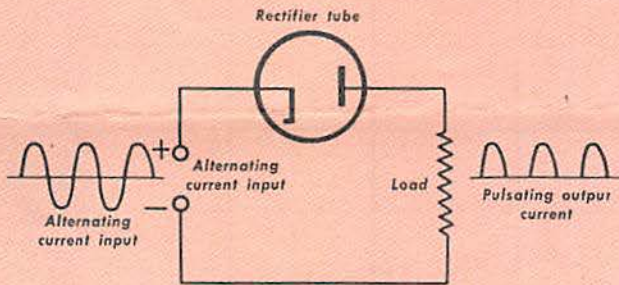
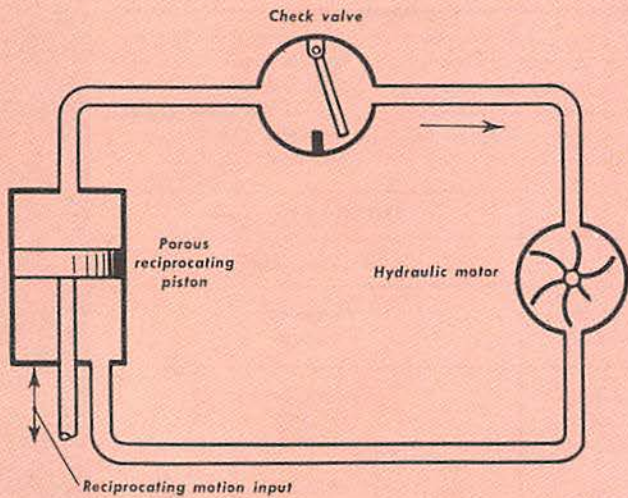

FUNDAMENTAL TUBE CIRCUITS— Operation explained by hydraulic analogs and electronic circuits. Several typical industrial applications are shown for each type of circuit.



Hydraulic Analog— Reciprocating motion imparted to the porous piston tends to cause oscillating flow of water in hydraulic circuit but check valve permits flow in one direction only. When piston moves counter to valve, water passes through porous piston. Thus, a pulsating, unidirectional flow of water is furnished to the hydraulic motor or load.

Electronic Circuit— Alternating voltage tends to cause flow of alternating current, but electrons can flow only from filament to plate. Electron flow is possible in one direction only. Because of this phenomena, a pulsating, unidirectional current is supplied as output to the load.

APPLICATIONS

Rectifiers may be employed wherever d-c operated equipment is to be supplied by an a-c source of power. Typical examples of rectification include:

1. Operation of variable speed d-c motors from a-c power line.
2. Battery chargers.
3. Supplying current for electroplating baths.
4. Providing power for operation of radio receivers from a-c line.
5. Providing d-c power for railways.

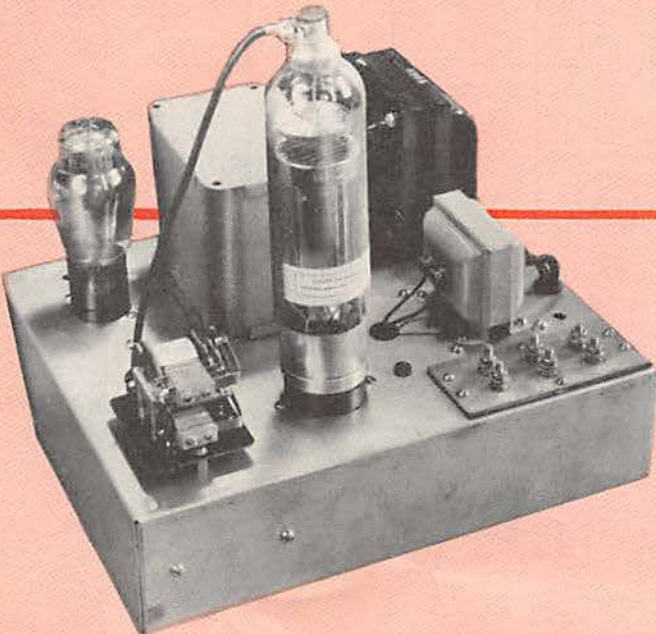

AMPLIFIER CIRCUIT

Hydraulic Analog – Constant pressure from hydraulic pump, and oscillating pressure from reciprocating pump produces varying but unidirectional force on check valve, permitting more or less water to flow in one direction in the output circuit. Thus, the controlled check valve governs the volume of pulsating, unidirectional flow of water from main hydraulic pump to hydraulic motor or load.

Electronic Circuit – Constant voltage from C battery and alternating signal voltage produces varying but unidirectional voltage on grid of tube, thereby governing the quantity of electron flow between filament and plate. Varying grid voltage is thus capable of controlling flow of considerably larger voltages and current in the plate circuit, and for this reason the arrangement is called an amplifier circuit. Grid voltage variations are reproduced in magnified form in plate circuit with power supplied from B battery.

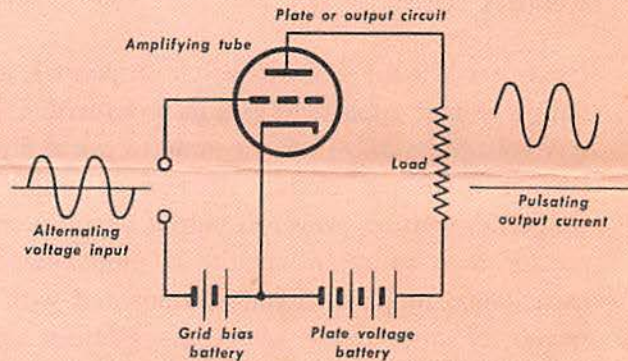
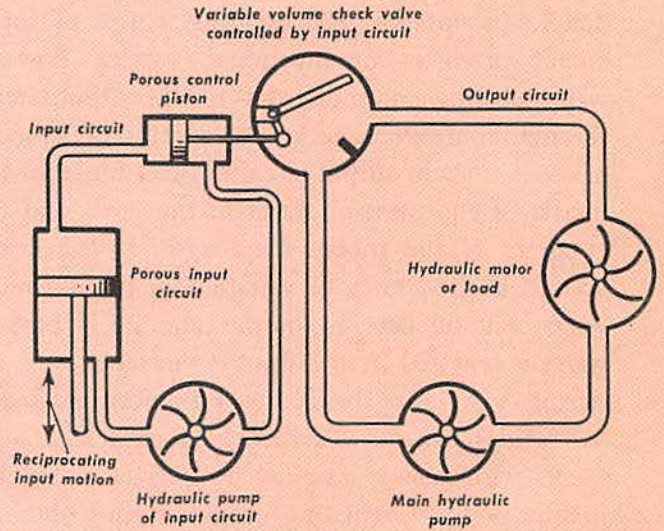

APPLICATIONS

Amplifiers find application wherever small voltages and minute currents must be used to actuate power operated equipment. Typical applications include:

1. Capacity operated protective relays and switches.
2. Intrusion detection devices.
3. Amplification of voltages from electric strain gages.
4. Operation of switches and relays from light beams.
5. Sound amplification in interoffice communication system.
6. Increasing sensitivity of industrial control and recording equipment.

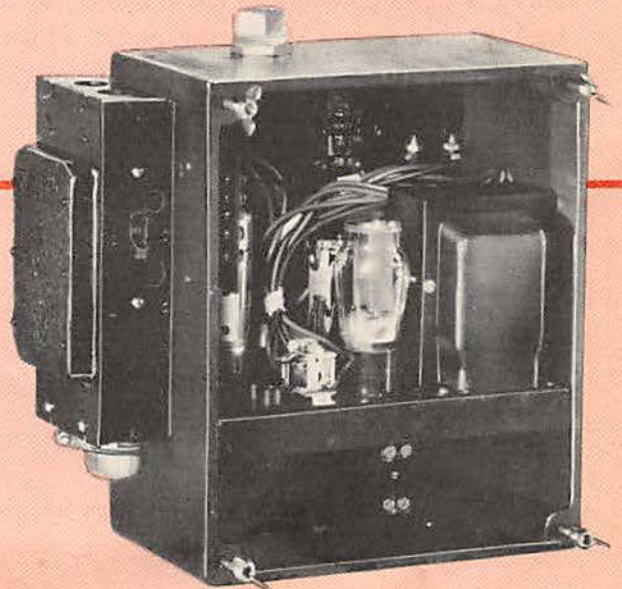

OSCILLATOR or INVERTER CIRCUIT

Hydraulic Analog – With valve on position 1, hydraulic pumps and reciprocating piston of input circuit produces unidirectional, varying flow of water which is communicated to the output circuit through controlled check valve. Natural frequency of oscillations in output circuit is determined by the inertia of the mass of water in the tank, and the elasticity of the rubber diaphragm. If this corresponds to frequency of variation in input circuit, water will oscillate in output circuit. If part of water is now fed from output circuit back to input circuit, valve may be changed to position 2 and oscillations can be sustained by feedback arrangement, with power supplied by output circuit hydraulic pump. Oscillating output is thus obtained from hydraulic pump by resonant tank circuit and feedback system.

Electronic Circuit – With switch on point 1, alternating voltage applied to grid in series with C battery voltage produces varying, unidirectional flow of current in output circuit. Because of amplifying properties of tube, power in output circuit is much greater than in input circuit. If inductance and capacitance in plate circuit is resonated with frequency of input signal voltage, energy from output can be fed back to input circuit, switch can be thrown to position 1 and the circuit will produce alternating or oscillating currents. These oscillating currents are obtained from the B battery by feeding back to grid circuit oscillating power which alternately opens and closes check valve from its mean position, converting d-c into a-c.

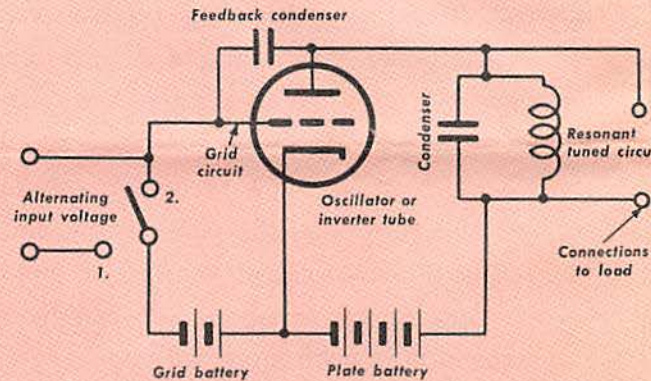
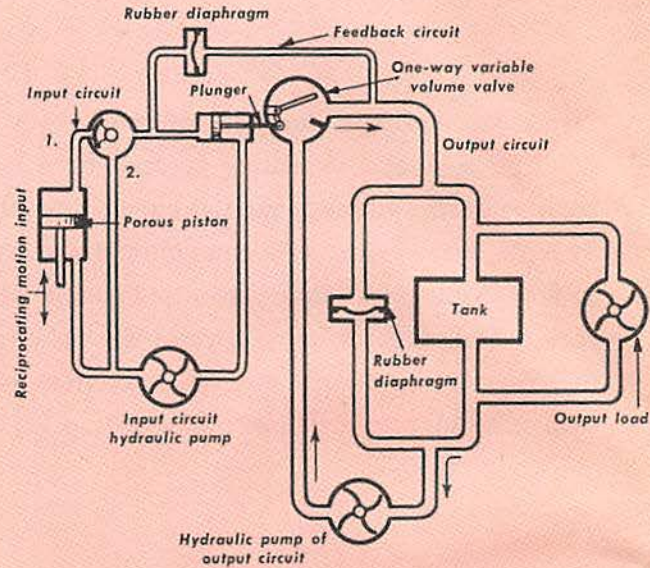

APPLICATIONS

Oscillators or inverters are employed to convert d-c to a-c of any desired frequency throughout a wide range of power. Typical applications include:

1. Inverters for operating a-c equipment from d-c sources of power.
2. Radio and carrier communication.
3. Induction and dielectric heating.
4. Congealing and emulsification at supersonic frequencies.
5. Dehydration of food.

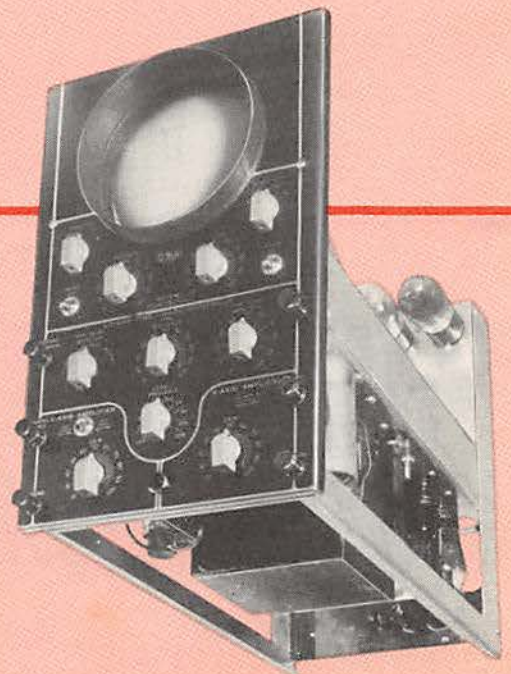

PHOTOTUBE CIRCUIT

Hydraulic Analog— Water, maintained under constant pressure by means of hydraulic pump, flows in one direction only as in the circuits previously described. Air flow, from a pneumatic jet, directed toward the level of a one-way variable volume valve, opens the valve. The stronger the air flow, the larger the valve opening becomes, and the greater is the flow of water in the hydraulic circuit. When there is no air flow, the spring keeps the valve closed, thereby cutting off the flow of water.

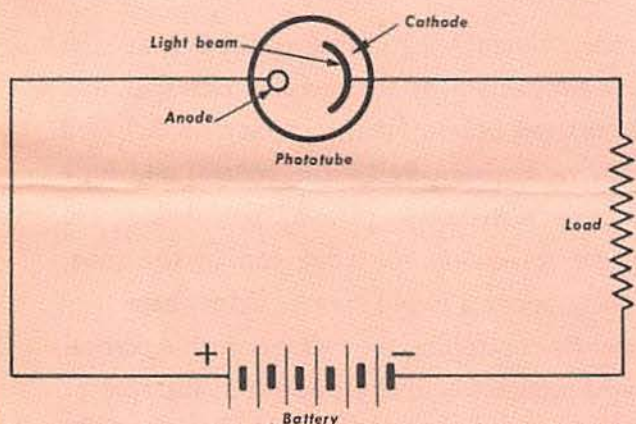
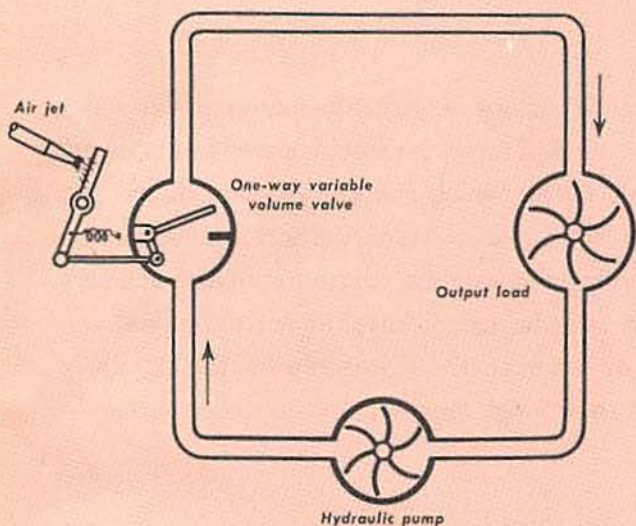

Electronic Circuit— A photosensitive cathode in the phototube releases electrons when light strikes it, the electrons flowing to the positively charged anode or plate under the influence of the battery. In the absence of light, no electrons can be released and no current can flow through the tube. The current through the phototube is proportional to the light striking its cathode.



APPLICATIONS

The phototube finds many industrial applications because of its ability to convert light into an electric voltage or current. Among its many uses are:

1. Safety controls by interruption of light beam.
2. Determination and measurement of color.
3. Measurement of illumination.
4. Transmission of pictures by wire and radio circuits.
5. Control of color registration in multi-color printing.
6. Determination and measurement of high temperatures.

CATHODE RAY TUBE CIRCUIT

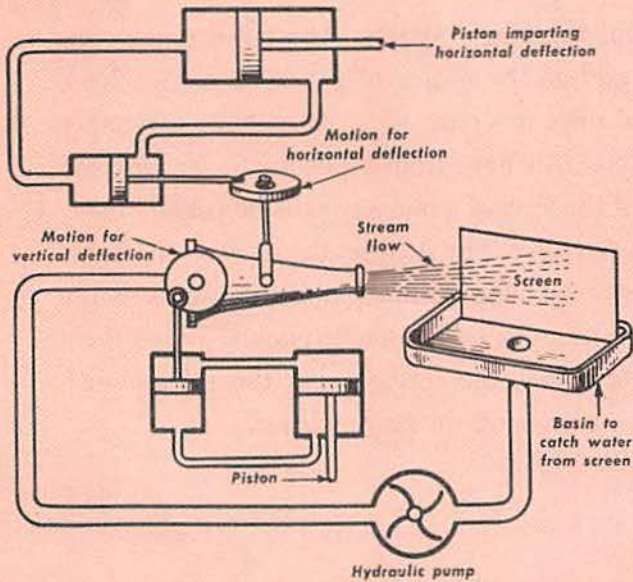

Hydraulic Analog – Hydraulic pump draws water from tank and forces it through swivel-mounted adjustable nozzle which concentrates and directs the stream against the screen. Vertical and horizontal deflection of nozzle are controlled by the auxiliary circuit as indicated. Control in horizontal and vertical direction makes it possible for the stream of water to impinge on any point on screen surface.

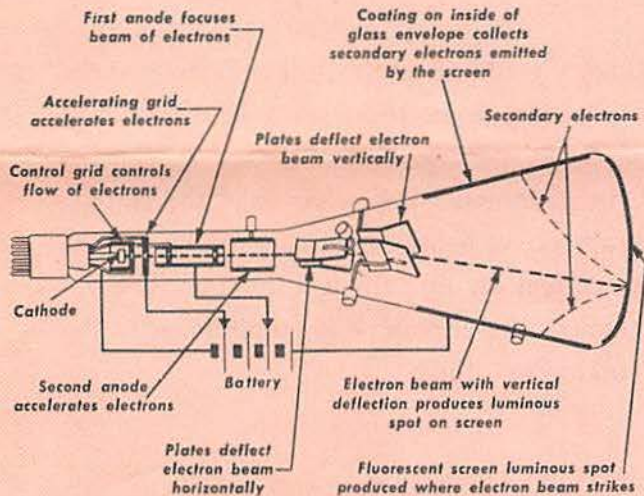

Electronic Circuit – Electrons emitted from the cathode are focused by the focusing electrode into a concentrated beam. The beam may be deflected vertically or horizontally by the vertical and horizontal pairs of deflecting plates. Upon striking the fluorescent screen on the large end of the tube, electrons produce a bright spot of light where they impinge. By controlling the voltages on the vertical and horizontal set of deflecting plates, the spot of light can be made to travel over the surface of the screen as desired. The intensity of the spot can be controlled by varying the number of electrons in the beam by changing voltage on control electrode.

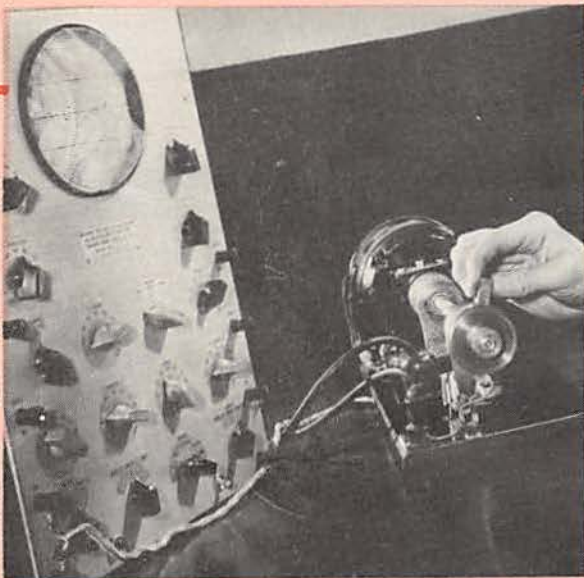

APPLICATIONS

By converting electrical energy into visible light patterns, the cathode ray tube makes possible:

1. Formation of television pictures in the television receiver.
2. Measurements of voltage, current, power, frequency.
3. Electrical measurements of mechanical strain.
4. Determination of noise in internal combustion engines.
5. Determination of mechanical characteristics such as pressure, impact, acceleration, linear and torsional oscillation.
6. Illumination measurements.

CONTROLLED RECTIFIER CIRCUIT

Hydraulic Analog – Reciprocating motion applied to the porous piston tends to produce a pulsating flow of water in the output circuit, but the check valve limits the flow of water in only one direction. The variable pressure hydraulic pump in the input circuit actuates the sliding rod which changes the size of the valve aperture. Thus, water flows in pulses in the output circuit, the amount of flow being controlled by the constant pressure pump in the input circuit. Water is delivered to the motor or load in pulses, so that while the motor rotates in one direction, its speed varies periodically.

Electronic Circuit – Alternating voltage applied between filament and plate of the tube, which acts as a rectifier, creates a unidirectional pulsating current in the plate or output circuit. The magnitude of this plate current depends upon the voltage applied between the grid and filament. Maximum current will be obtained for zero grid voltage, while current can be completely cut off by making the grid sufficiently negative.

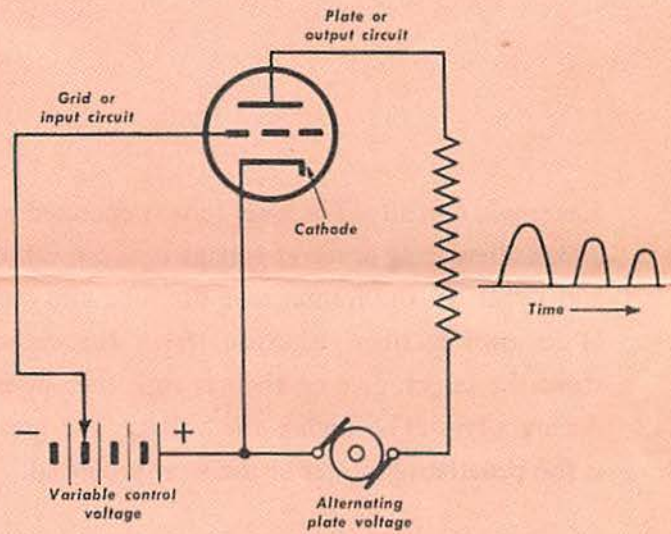
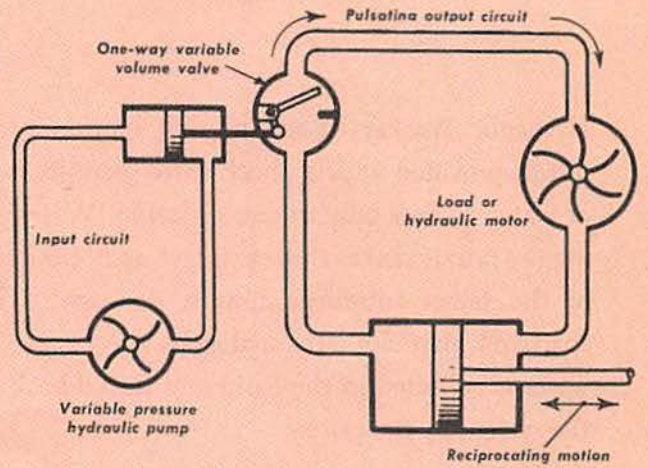

APPLICATIONS

Controlled rectifiers can be used wherever pulsating unidirectional current is desired, such as to:

1. Vary the intensity of artificial illumination.
2. Control the speed of d-c motors operated from a-c lines.
3. Control the charging rate of battery chargers.
4. Produce effective electronic welding control mechanisms.
5. Controlled current for electroplating.

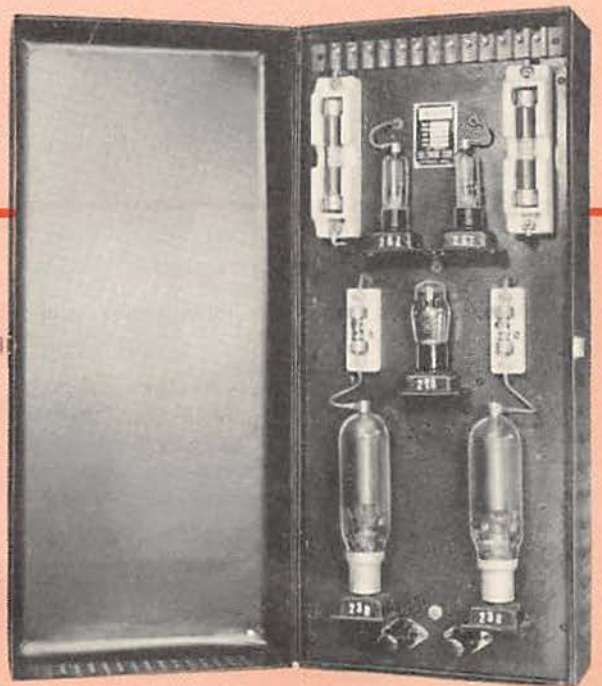

X-RAY TUBE CIRCUIT

Hydraulic Analog — Reciprocating motion of the piston provided with a check valve, permits pulses of water to flow only in one direction. Water leaving the nozzle strikes the soft target, spattering some of the target substance toward the right. These spattered particles are analogous to x-rays. The water is collected in the basin and forced back into the system by the piston.

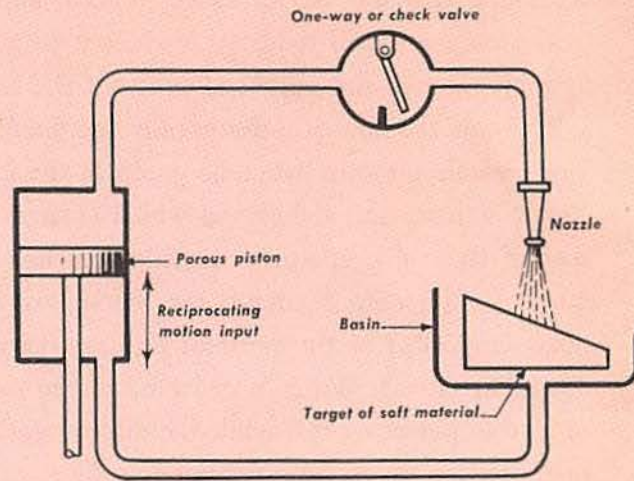

Electronic Circuit — The x-ray tube is operated with a high alternating or direct voltage between cathode and target. In the former case the tube also serves as its own rectifier. Electrons from the cathode strike the target, give up their energy, thereby producing x-rays. The higher the voltage, the greater is the penetrating power of the x-ray produced.

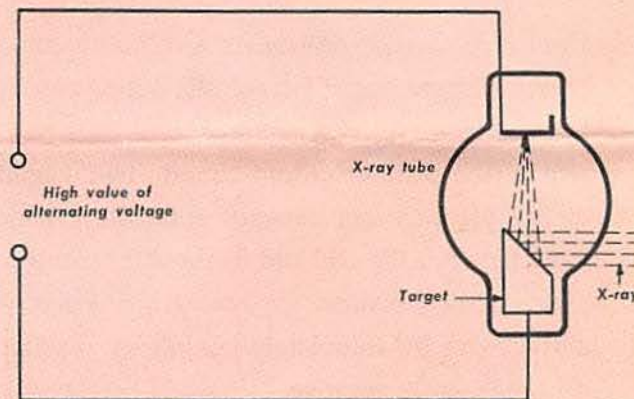

APPLICATIONS

Because x-rays can pass readily through most solid substances, they can be used to:

1. Examine castings and welds for flaws.
2. Study the atomic structure of crystals.
3. Inspect platings for adhesion faults.
4. Study surface corrosion.

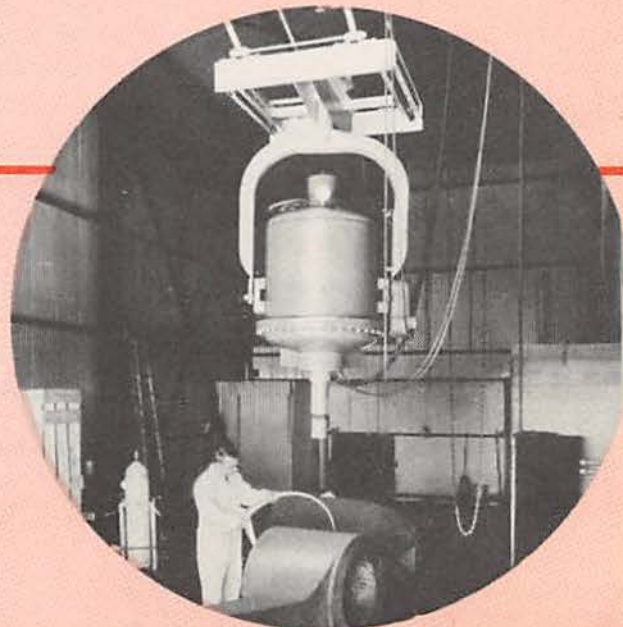

VOLTAGE REGULATOR CIRCUIT

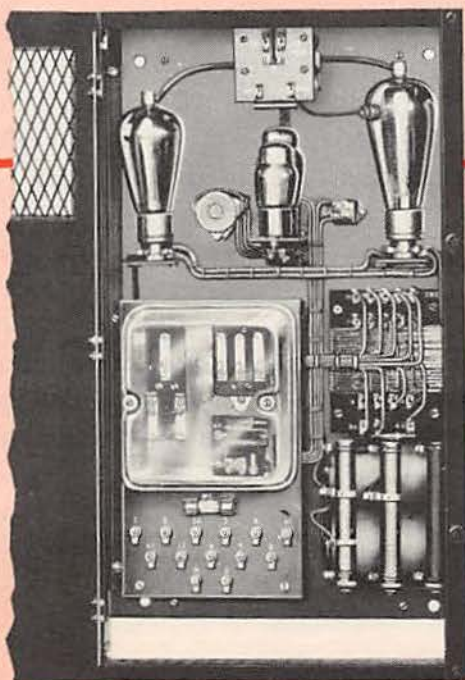
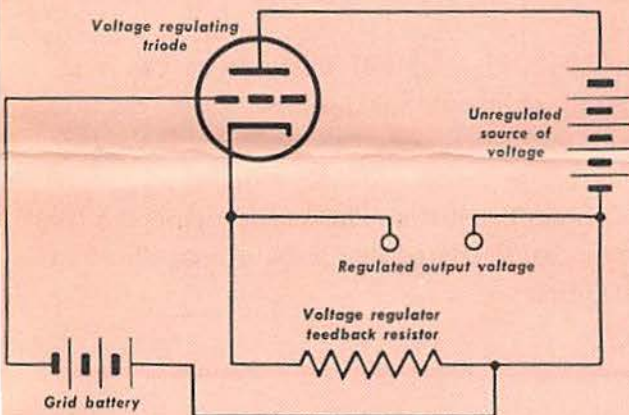
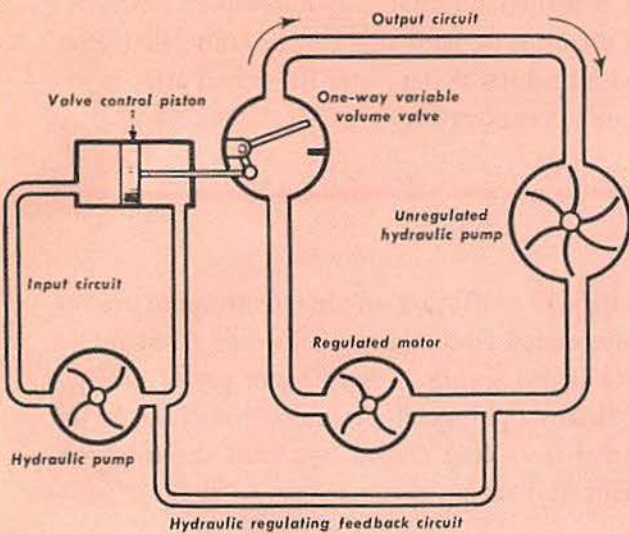

Hydraulic Analog—The constant pressure hydraulic pump circulates fluid through the input circuit, the position of the porous piston determining the port opening of the one-way variable volume valve. If the unregulated hydraulic pump in the output circuit produces a pressure in excess of the amount as regulated, the excess pressure pulse is communicated to the control piston, causing valve to close in proportion to the excess pressure. A decrease in pressure of the unregulated hydraulic pump will open the valve in proportion to decrease in pressure. The effect is to maintain constant the pressure of fluid at the motor or load.

Electronic Circuit—Voltage of the grid battery in the input circuit determines the mean value of regulated current flowing in output or plate circuit. If the unregulated voltage in the plate circuit exceeds the regulated value, the increased voltage is applied to the grid in such a manner as to decrease the flow of current in the plate circuit. A decrease in the normal voltage of the unregulated voltage will increase the flow of plate current in proportion to the decrease in voltage. By this means the current through and the voltage across the load are maintained constant. The feedback resistor can be made variable to permit adjustment of the degree of voltage regulation.

APPLICATIONS

There are many applications requiring constancy of voltage, but for industrial purposes voltage regulators are important in:

1. Controlling the voltage of voltage controlled industrial instruments.
2. Operation of constant speed or variable speed motors.
3. Meter calibration.



CASE HARDENING — High frequency current produced by an oscillator circuit is used to heat the surface of metallic articles to be case hardened. After the part is heated to the proper depth, it is then automatically water quenched. Area and depth of metal to be hardened can be controlled. Photograph shows a bushing being water quenched after it was subjected to induction heating.

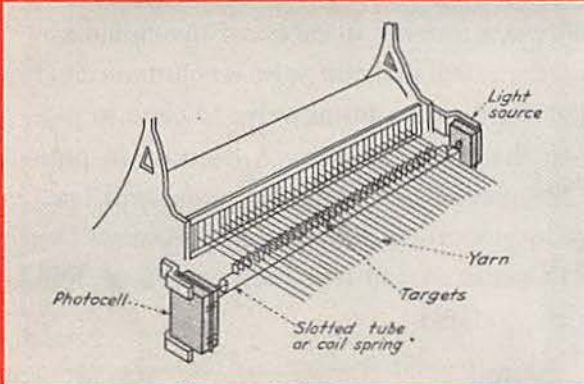

TEXTILE MACHINERY — Riding on threads to loom are targets loosely suspended from the warp threads to fit into a slotted tube or coiled spring. A light beam passes through the tube and strikes a photocell. Should a thread break, the target suspended from that thread falls into the tube, obstructs the light and causes the machine to stop.



ELECTRON MICROSCOPE — Optical microscopes can magnify a maximum of about 1,000 times. Large electron microscope with magnetic or electrostatic lenses, has a wide dispersion of electrons which produces a useful magnification of 20,000 times or greater. The smaller semi-portable electrostatic type, as illustrated, has a useful magnification of about 10,000 times.



COLOR MEASUREMENT AND CONTROL — This recording spectrophotometer measures and classifies color by means of amplified current from a photoelectric tube. The spectrophotometric curve it produces provides a permanent record of the colors in the sample. Instrument can assist in matching or controlling colors in textile, plastic and similar fields. Color can be standardized in terms of graphic charts.



INSPECTION BY X-RAY — Large portable x-ray units, mounted either on trucks or hung from cranes, are brought to large units for examination of welds and metal structure. To inspect small parts they are placed on a conveyor belt that carries them past a small x-ray machine which throws the image on a fluorescent screen.

CONVEYOR CONTROL — This conveyor system is so controlled by photoelectric tubes that if a box should start to transfer from feed conveyor to the main conveyor, no other box can approach on the main conveyor and thereby pile up or jam the system.

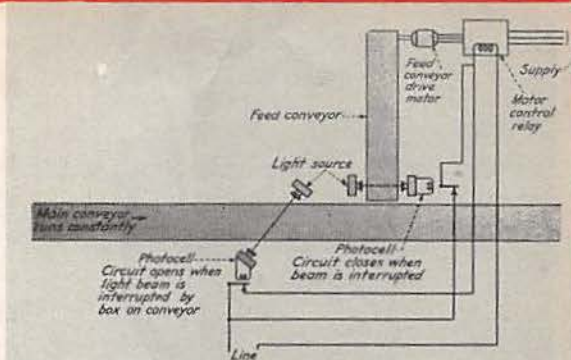

TEMPERATURE REGULATION — Temperature of a rotary cement kiln is controlled by a photoelectric pyrometer. Current from phototube is amplified to operate a recording thermometer.



FACSIMILE TRANSMISSION — It is now possible to write a telegram, drop the message down a chute, and have it reproduced at the receiving end exactly as it was written, and without the services of a telegrapher. Message sheet is automatically wrapped around a drum and is scanned by a light beam. Weather maps can be transmitted by radio to planes in flight and then be reproduced.

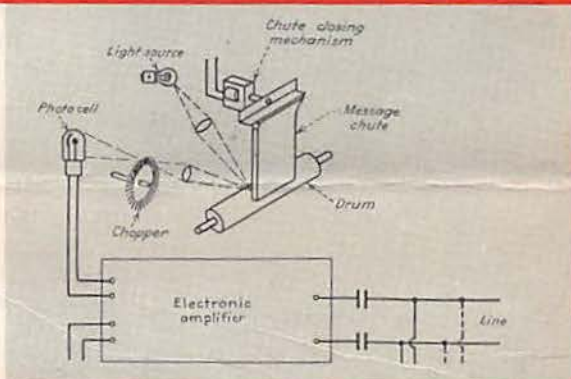

TIME-DELAY RELAY — Circuit consists of a tube to serve as a switch, an adjustable resistance or potentiometer, condenser, transformer and resistors. Time delay is regulated by adjusting potentiometer.

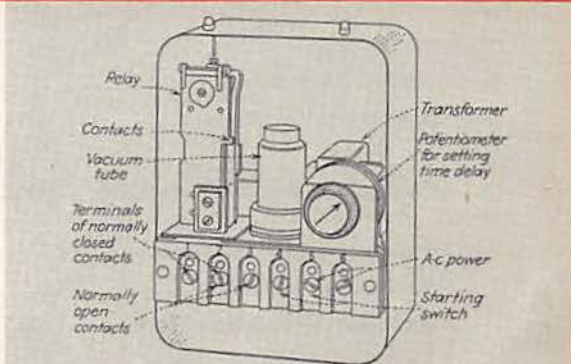

SPOT WELDING — Material previously considered too thin can now be welded by units equipped with electronic controls that automatically regulate the welding time and energy. Illustration shows the welding of two pieces of aluminum each but 0.067 in. thick.





MEASUREMENT OF SPEED—A flashing beam of light in a circuit controlled by an oscillator, is directed at the element, the speed of which is to be measured. The light is mounted in a parabolic reflector of a portable instrument. By turning a knob, the frequency of the oscillator is adjusted to synchronize the neon lamp flashes with the r.p.m. of the rotating element, which then appears to stand still. Speed is read directly. Effective speed range is from 600 to 14,400 r.p.m.



SOUND LEVEL METER—Essentially this instrument consists of a microphone that is actuated by sound pressure, an amplifier to step up the voltages generated by the microphone, and an indicating dial to show the magnitude of the applied signals. Tubes used are of the battery type. Instrument reading gives sound intensity in decibels.

USEFUL REFERENCE BOOKS ON ELECTRONICS

TITLE	AUTHOR	PUBLISHER	PRICE
Applied Electronics.....	E. E. Staff of M.I.T.....	John Wiley and Sons...	\$6.50
Engineering Electronics.....	D. G. Fink.....	McGraw-Hill Book Co....	\$3.50
Electronics	J. Millman and S. Seeley.....	McGraw-Hill Book Co....	\$5.00
Gaseous Conductors, Theory and Engineering Applications	J. D. Cobine.....	McGraw-Hill Book Co....	\$5.50
Principles of Electron Tubes.....	H. J. Reich.....	McGraw-Hill Book Co....	\$3.50
Principles of Electronics.....	R. G. Kloeffler.....	John Wiley and Sons...	\$2.50
Electronics and Electron Tubes.....	E. D. McArthur.....	John Wiley and Sons...	\$2.50
Electron Tubes in Industry.....	Keith Henney.....	McGraw-Hill Book Co....	\$5.00
Industrial Electronics	F. H. Gullikson and E. H. Vedder..	John Wiley and Sons...	\$3.50
Applied X-Rays.....	G. L. Clark.....	McGraw-Hill Book Co....	\$6.00
Principles of Mercury Arc Rectifiers and Their Circuits	D. C. Prince and F. B. Vodges....	McGraw-Hill Book Co....	\$3.00
Photocells and Their Applications.....	V. K. Zworykin and Wilson.....	John Wiley and Sons...	\$3.00
Photoelectric Cell Applications.....	R. V. Walker and T. M. C. Lance..	Pitman Pub. Corp.....	\$4.00



Reprints of this section are available at 10 cents each, special price for quantities. Address publisher—PRODUCT ENGINEERING, 330 West 42nd Street, New York (18) N. Y.