

# CPD-L133

## SERVICE MANUAL

US Model  
Canadian Model  
AEP Model  
Chassis No. SCC-G25C-A

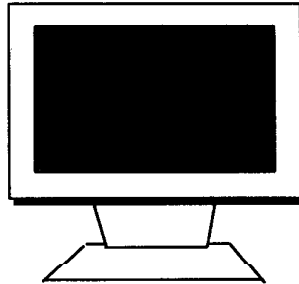

### SPECIFICATIONS

LCD panel	Panel type: a-Si TFT Active matrix Picture size: 13.3 inches
Input signal format	RGB operating frequency: fh: 15.625 KHz (625 interlace signal) 15.75 KHz (525 interlace signal) 30~70 KHz fv: 50~85 Hz
Pixel efficiency	99.99%
Resolution	H: max 1024 dots V: max 768 lines
Power requirements	Operation: AC 100~240 V, 50/60 Hz Input: DC 12 V (using the AC adaptor)
Power consumption	Display only: Max. 30W Including the AC adaptor: Max. 42 W
Dimensions	Including the stand: Approx. 373 x 358 x 165 mm (w/h/d) (14.73 x 14.06 x 6.5 in.) Monitor only: Approx. 373 x 272 x 71 mm (w/h/d) (14.73 x 10.7 x 2.8 in.)
Mass	Approx. 4.9kg (11 lb ) including the stand

Design and specifications are subject to change without notice.

TFT LCD COLOR COMPUTER DISPLAY

**SONY®**

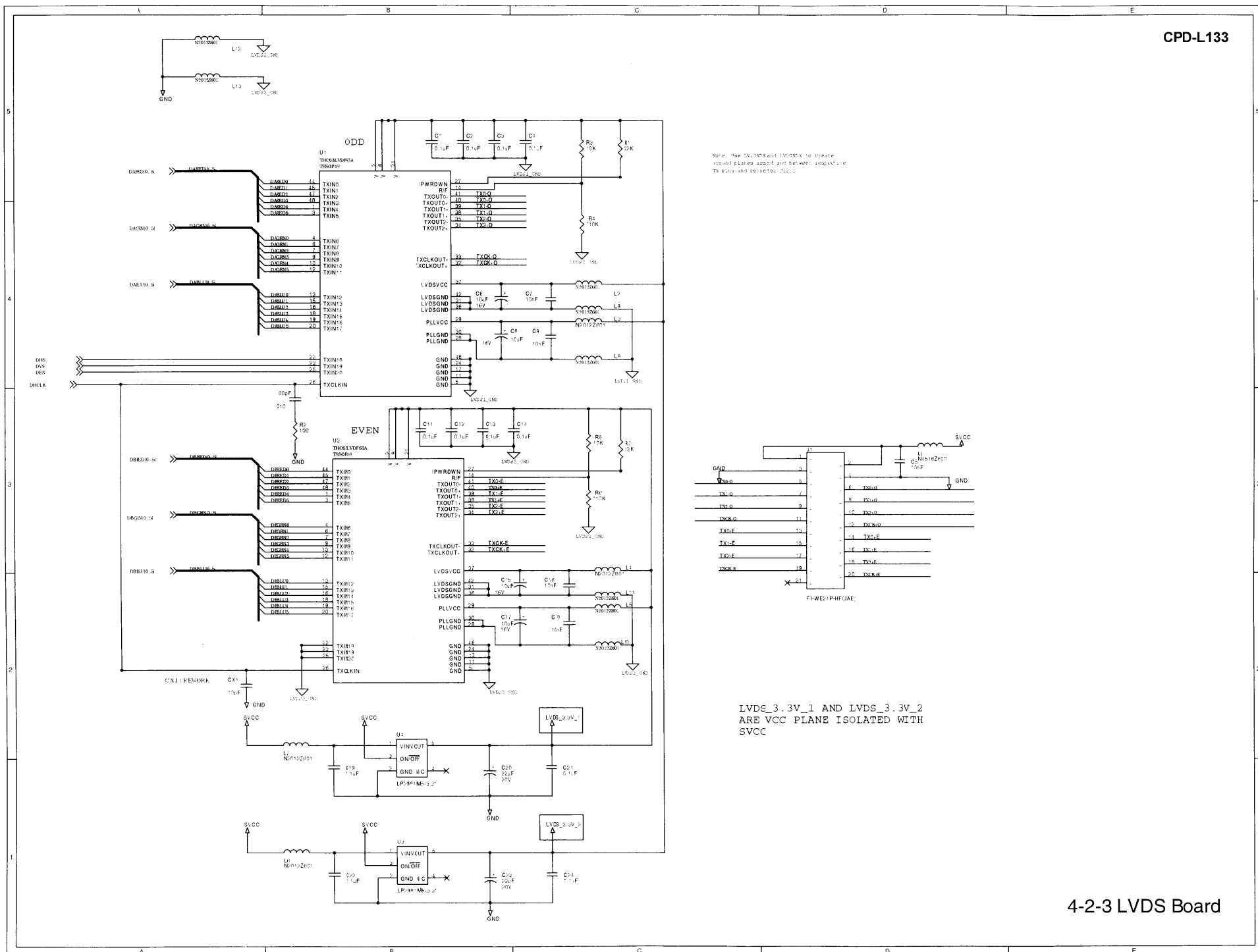

Note: The TXOE and TXCKE to GND connections are shown in the schematic.

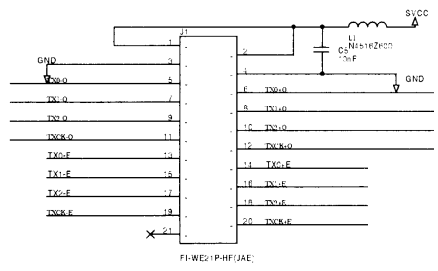

LVDS\_3.3V\_1 AND LVDS\_3.3V\_2 ARE VCC PLANE ISOLATED WITH SVCC

4-2-3 LVDS Board

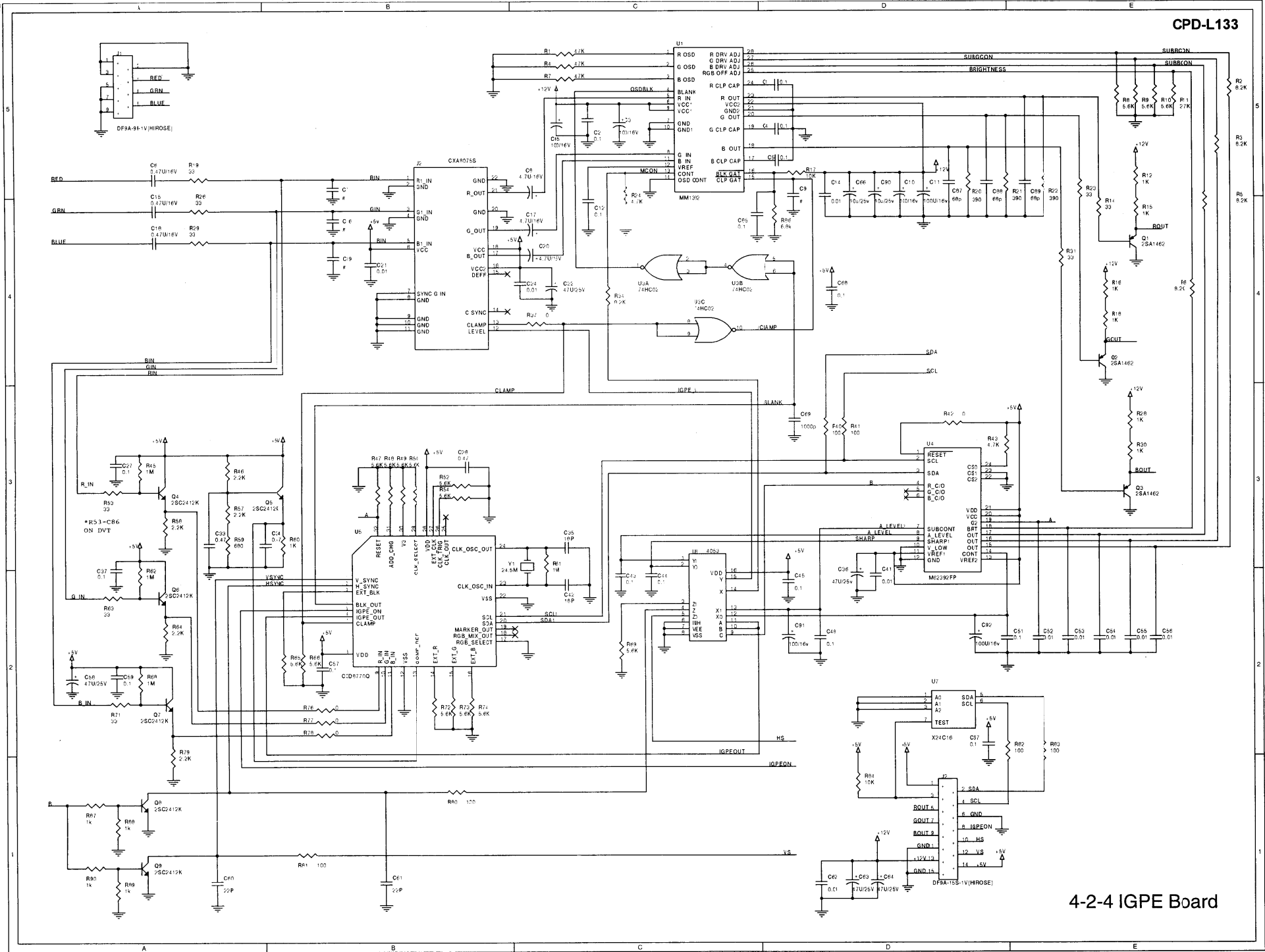

4-2-4 IGPE Board



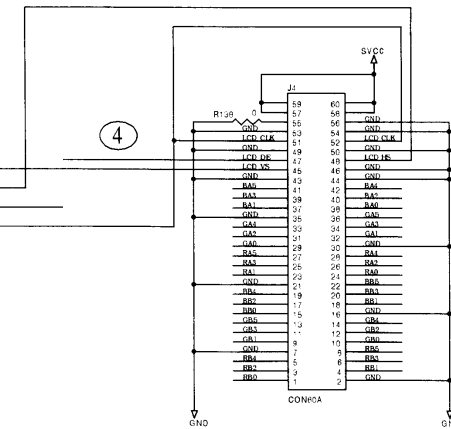
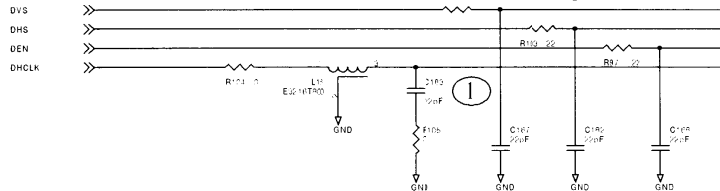
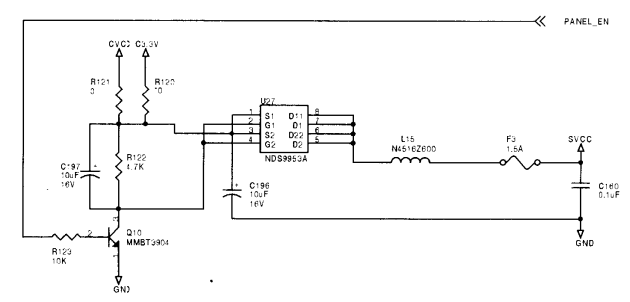
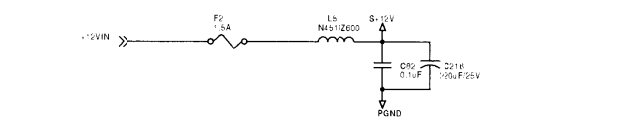
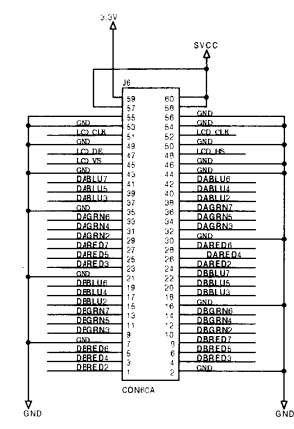
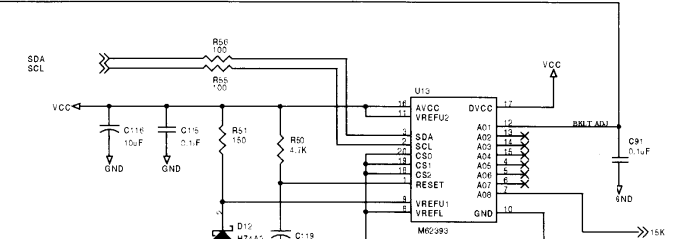
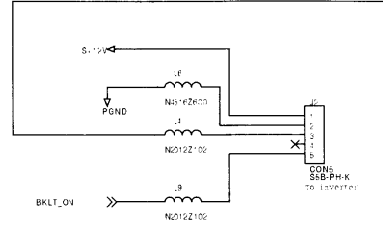
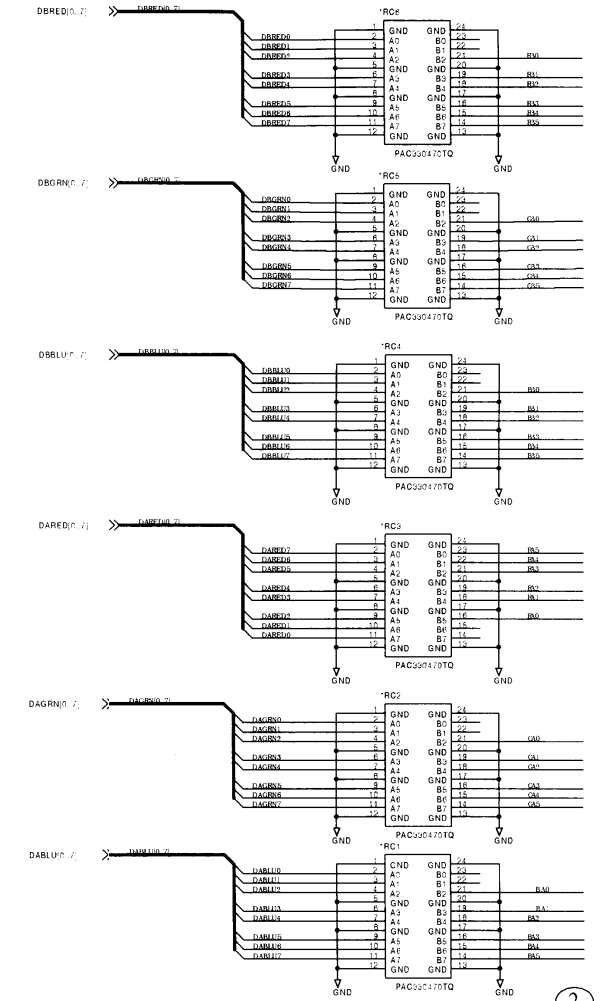

4-2-6 LCD Panel Connector

CPD-L133

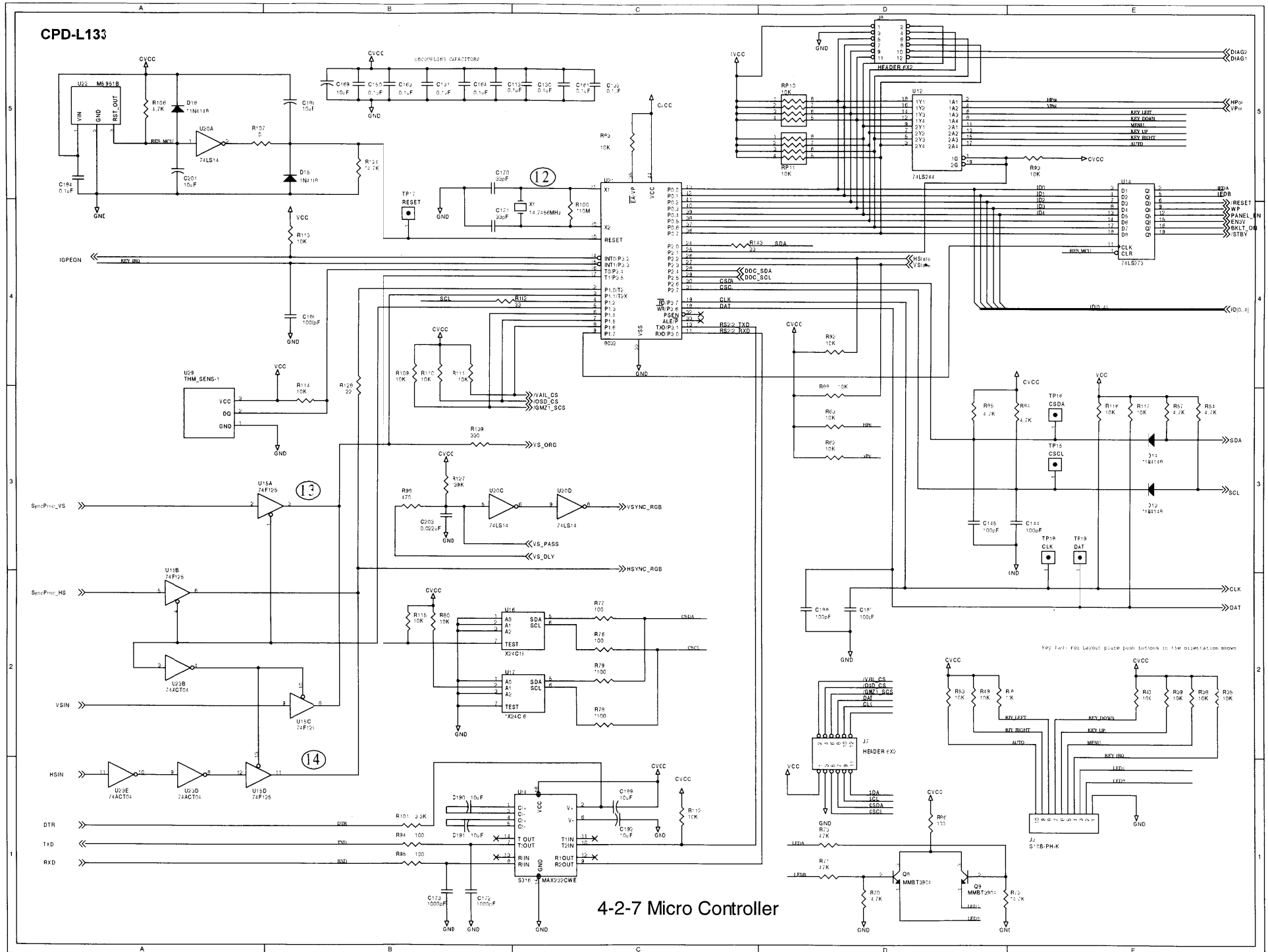

4-2-7 Micro Controller

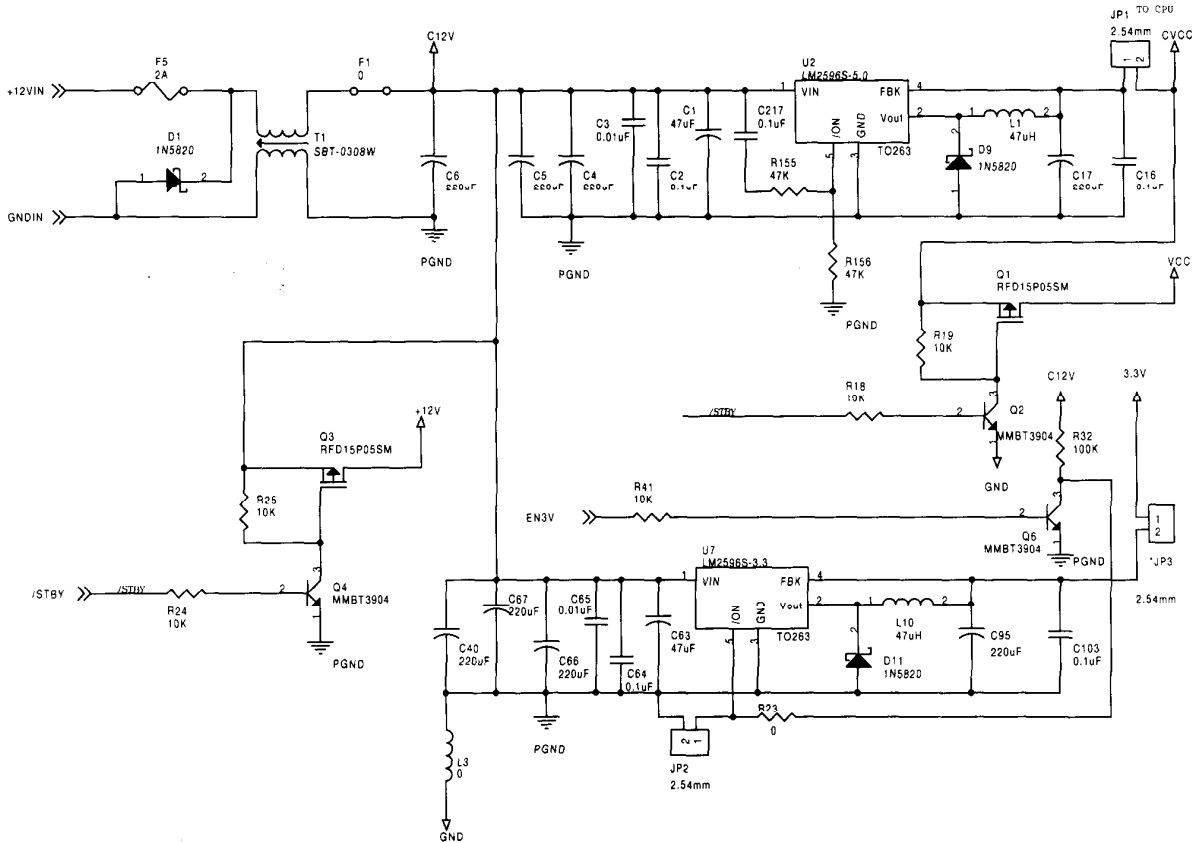

4-2-8 Power

CPD-L133

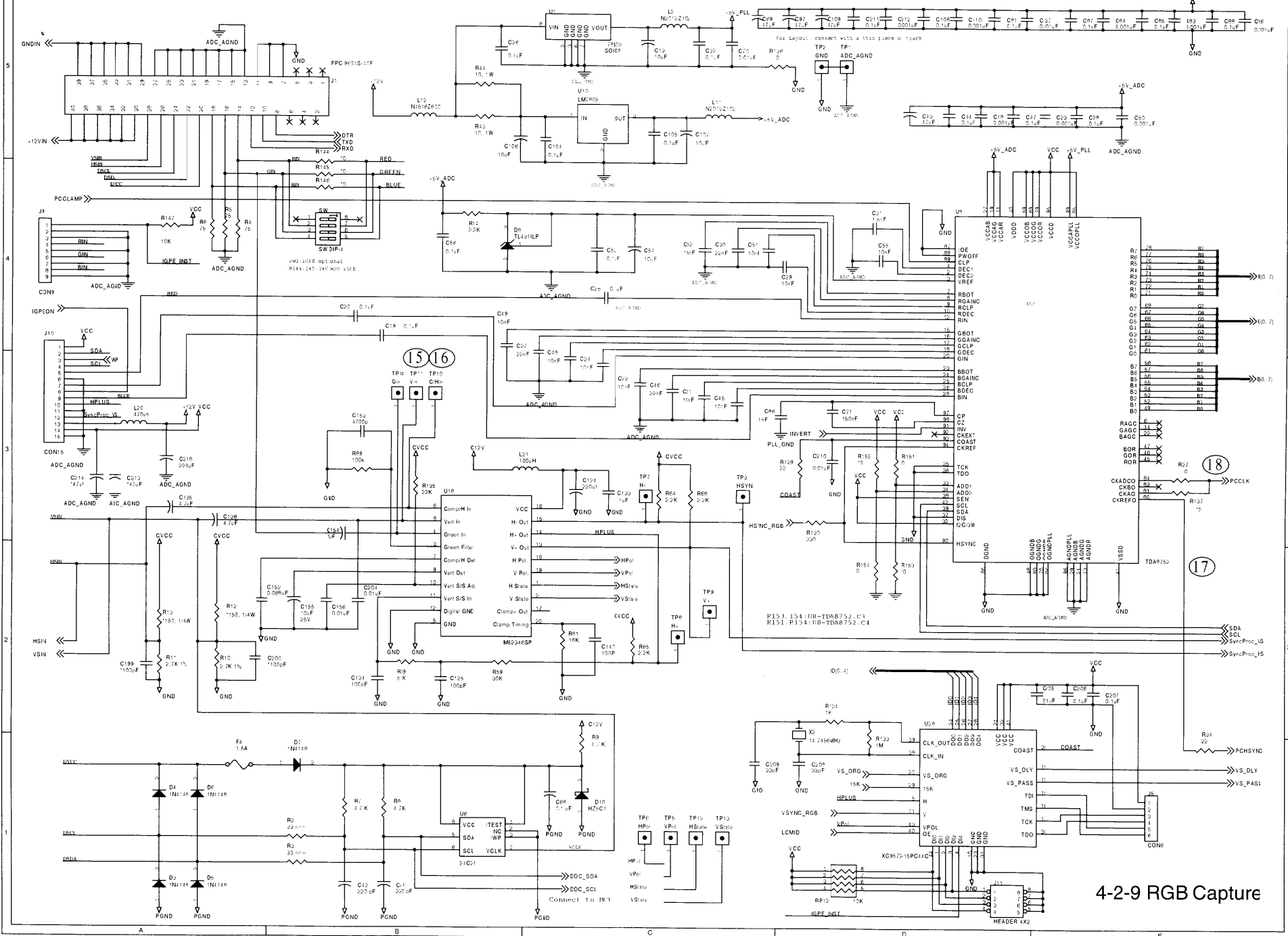

4-2-9 RGB Capture



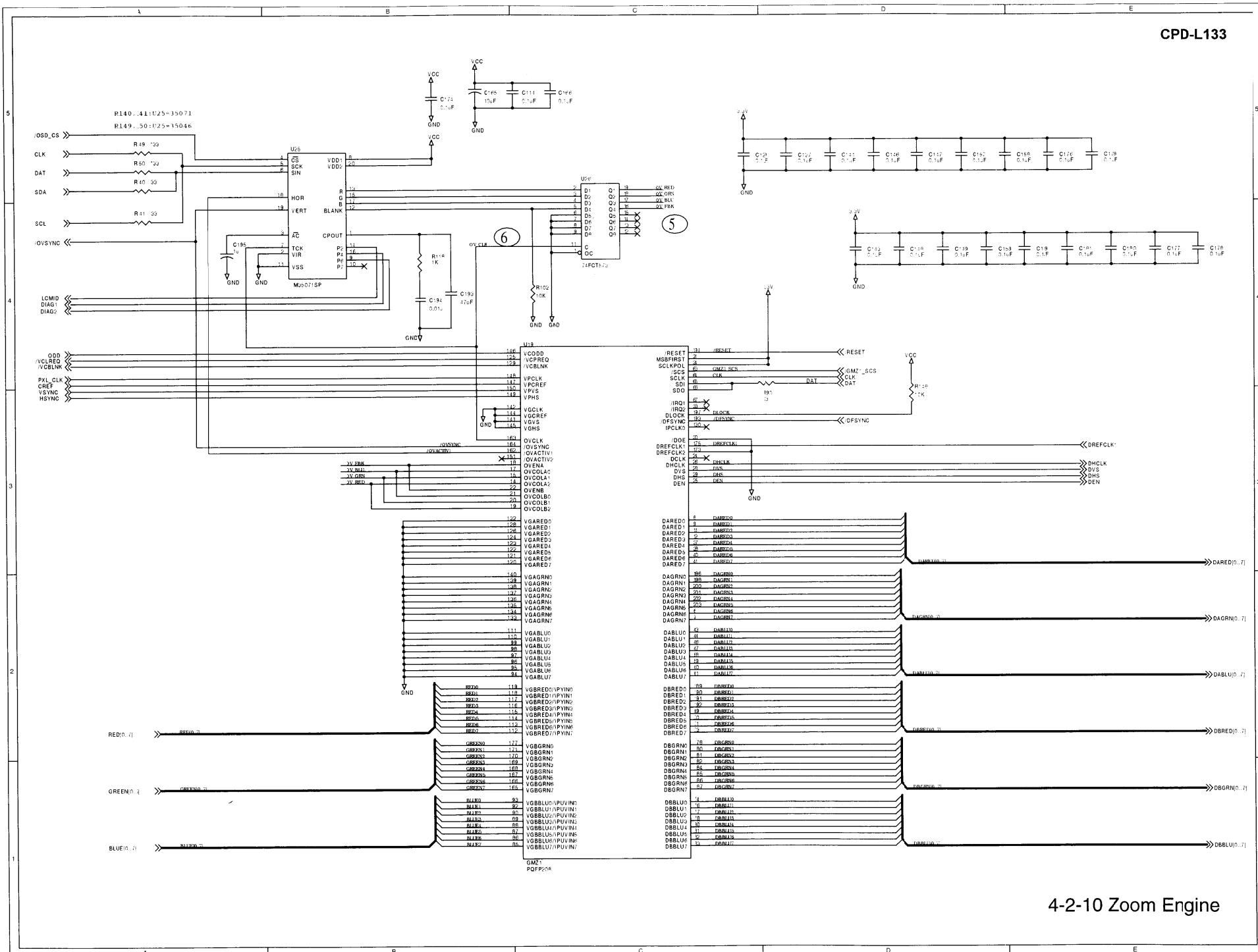

4-2-10 Zoom Engine

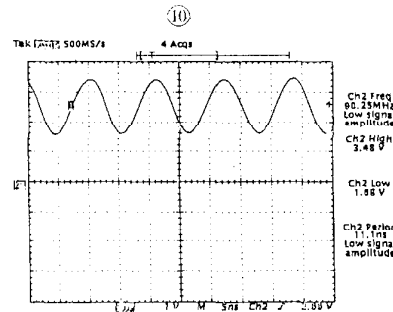
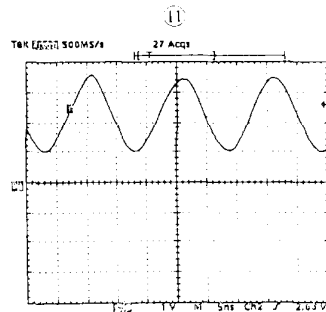
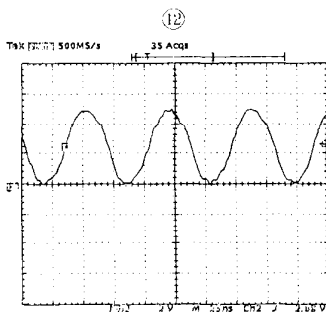
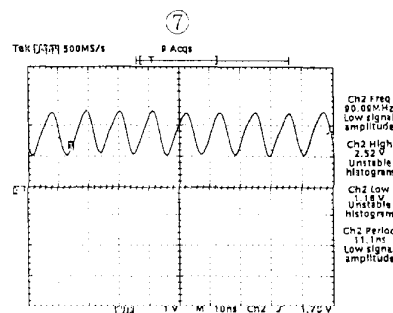
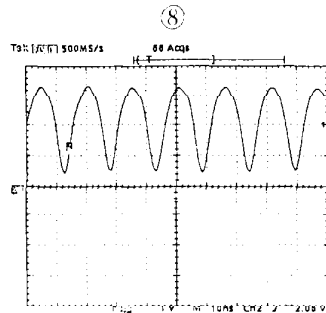
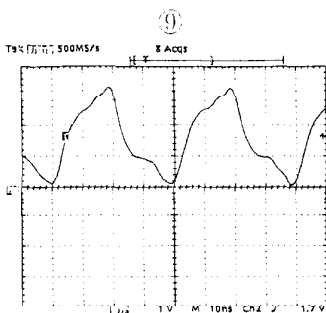
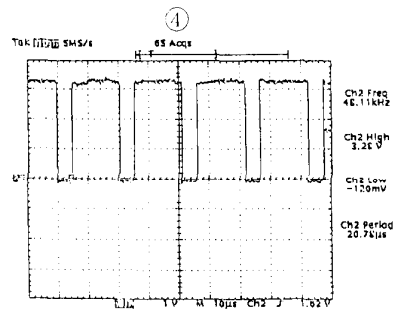
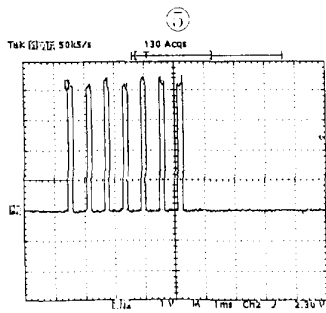
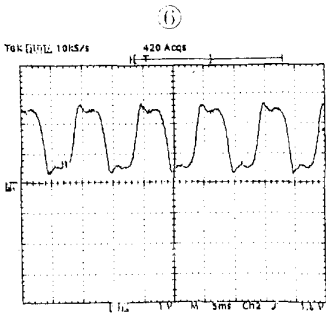
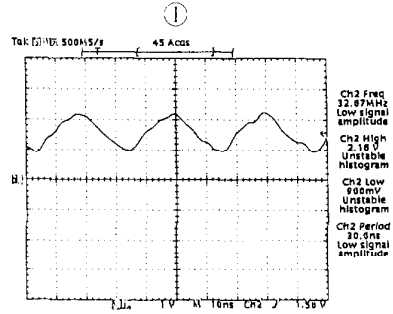
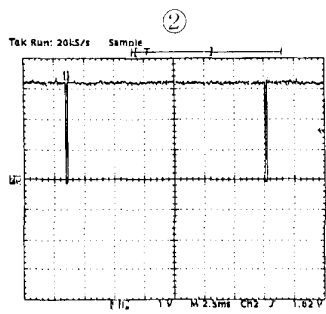
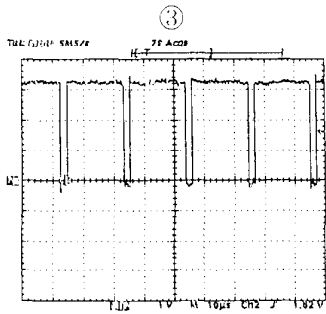

CPD-L133

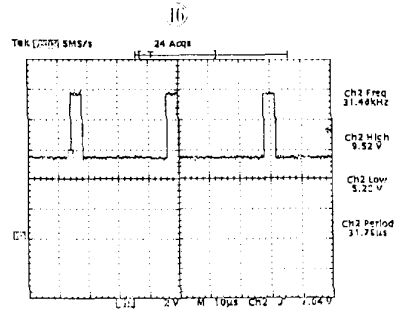
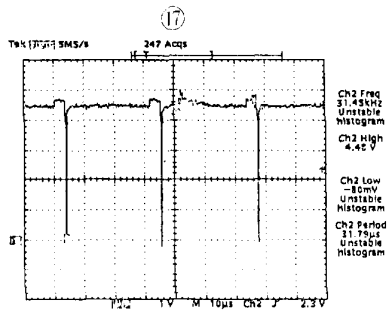
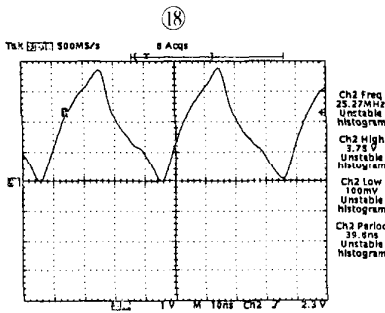
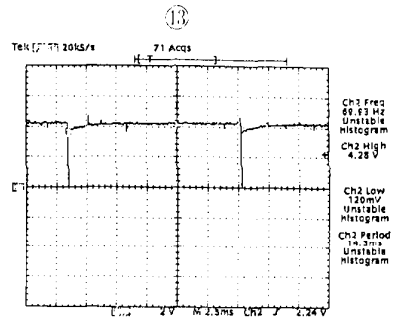
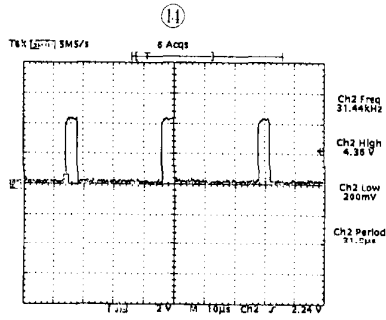
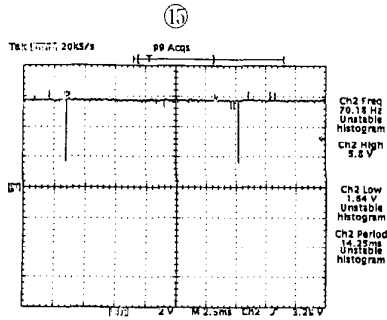

MMBT3904



TOP VIEW

M51951A/BML

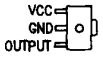

TOP VIEW

RFD15P05SM

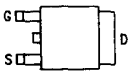

TOP VIEW

LM2937ES-5.0

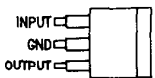

TOP VIEW

LM2596S-5.0  
LM2596S-3.3

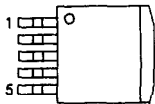

TOP VIEW

SB340  
1N5820

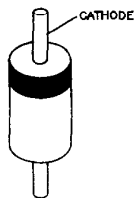

24LC16  
24LC21  
78L05ACM  
NDS9953A



TOP VIEW

PAC330/470TQ24P

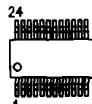

TOP VIEW

74LS14  
74ACT14  
74F125

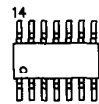

TOP VIEW

LT1181ACSW

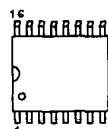

TOP VIEW

AS431CN



M62393FP  
74LS244  
74LS273  
74FCT573  
M35071

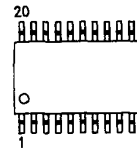

TOP VIEW

M52346SP DIP-20

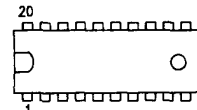

TOP VIEW

UPD4516161G5-A10

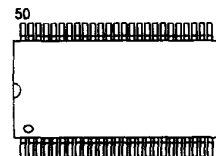

TOP VIEW

LM7805CT

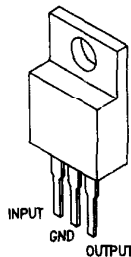

P89C738ABA  
XC9572

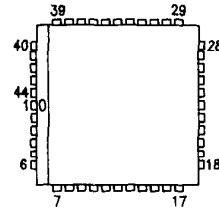

TOP VIEW

TDA8752

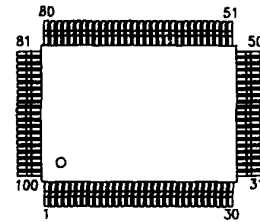

TOP VIEW

GMFC1  
GMZ1

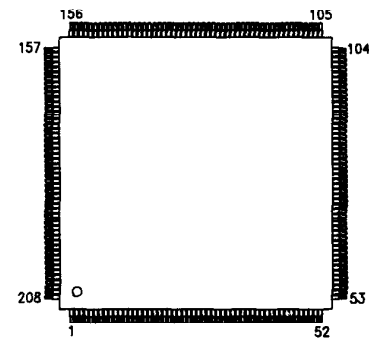

TOP VIEW

1N4148



HZ4A2  
HZ5C1

