

IMPORTANT SAFETY INSTRUCTIONS

- Read Instructions** - All the safety and operating instructions should be read before the appliance is operated.
- Retain Instructions** - The safety and operating instructions should be retained for future reference.
- Heed Warnings** - All warnings on the appliance and in the operating instructions should be adhered to.
- Follow Instructions** - All operating and use instructions should be followed.
- Water and Moisture** - The appliance should not be used near water - for example, near a bathtub, washbowl, kitchen sink, laundry tub, in a wet basement, or near a swimming pool, and the like.
- Carts and Stands** - The appliance should be used only with a cart or stand that is recommended by the manufacturer.
- 6A. An appliance and cart combination should be moved with care.** Quick stops, excessive force, and uneven surfaces may cause the appliance and cart combination to overturn.
- Wall or Ceiling Mounting** - The appliance should be mounted to a wall or ceiling only as recommended by the manufacturer.
- Ventilation** - The appliance should be situated so that its location or position does not interfere with its proper ventilation. For example, the appliance should not be situated on a bed, sofa, rug, or similar surface that may block the ventilation openings; or, placed in a built-in installation, such as a book case or cabinet, that may impede the flow of air through the ventilation openings.
- Heat** - The appliance should be situated away from heat sources such as radiators, heat registers, stoves, or other appliances (including amplifiers) that produce heat.
- Power Sources** - The appliance should be connected to a power supply only of the type described in the operating instructions or as marked on the appliance.
- Grounding or Polarization** - Precautions should be taken so that the grounding or polarization means of an appliance are not defeated.
- Power-Cord Protection** - Power-supply cords should be routed so that they are not likely to be walked on or pinched by items placed upon or against them, paying particular attention to cords at plugs, convenience receptacles, and the point where they exit from the appliance.
- Cleaning** - The appliance should be cleaned only as recommended by the manufacturer.
- Nonuse Periods** - The power cord of the appliance should be unplugged from the outlet when left unused for a long period of time.
- Object and Liquid Entry** - Care should be taken so that objects do not fall, and liquids are not spilled, into the enclosure through openings.
- Damage Requiring Service** - The appliance should be serviced by qualified service personnel when:
 - The power-supply cord or the plug has been damaged; or
 - Objects have fallen, or liquid has been spilled, into the appliance; or
 - The appliance has been exposed to rain; or
 - The appliance does not appear to operate normally or exhibits a marked change in performance; or
 - The appliance has been dropped, or the enclosure damaged.
- Servicing** - The user should not attempt to service the appliance beyond that described in the operating instructions. All other servicing should be referred to qualified service personnel.



DISC FORMATS

The unit can playback.



Region Management Information

Region Management Information: This unit is designed and manufactured to respond to the Region Management Information that is encoded on DVDs. If the Region number printed on the DVD does not correspond to the Region number of this unit, it cannot play that disc.

The region number of this unit is 1.

Disc Function or Operation that is Not Available

When the symbol appears on the screen, it indicates that the function or operation attempted is not available at that time. This occurs because the DVD manufacturer determines the specific functions of DVDs. Certain functions may not be available on some DVDs. Be sure to read the documentation provided with the DVD.

Icons Used on DVDs

Sample Icons

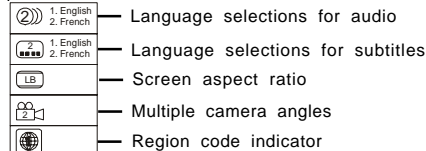

- Note:**
- When playing back a CD-G (Graphics) or CD EXTRA disc, the audio portion will be played, but the graphic images will not be shown.

Title, Chapter and Tracks

DVDs are divided into "titles" and "chapters". If the disc has more than one movie on it, each movie would be a separate "title". "Chapters" are sections of titles.

Audio CDs are divided into "tracks". A "track" is usually one song on an Audio CD.

- Note:**
- Numbers identify each title, chapter, and track on a disc. Most discs have these numbers recorded on them, but some do not.

Notes on Unauthorized Discs
You may not be able to play some DVDs on this unit, particularly if they were purchased from outside your geographic area or made for business purposes.

ACCESSORIES

Please check and identify the supplied accessories.

- To order accessories contact web site (<http://www.venturersupport.com>)

<input type="checkbox"/> Remote control (with battery)	x 1
<input type="checkbox"/> AC adapter	x 1
<input type="checkbox"/> Car plug adapter	x 1
<input type="checkbox"/> Rechargeable battery	x 1

REMOTE CONTROL

Using the Remote Control

- Point the remote control at the REMOTE SENSOR located on the unit.
- When there is a strong ambient light source, the performance of the infrared REMOTE SENSOR may be degraded, causing unreliable operation.
- The recommended effective distance for remote operation is about 16 feet (5 meters).

Remove the PVC sheet before operating the Remote Control.



Note:

- If the remote control is not to be used for a long time, remove the battery to avoid damage caused by the corrosive effects of battery leakage.

WARNING: Do not dispose of battery in fire, battery may explode or leak.

TO CHANGE REMOTE BATTERY

- Open the battery door.
- Insert one CR2025 (3V) size battery.

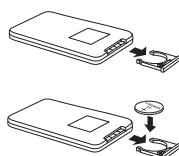

BATTERY REPLACEMENT

When the battery becomes weak, the operating distance of the remote control will be greatly reduced and you will need to replace the battery.

CONTROL REFERENCE GUIDE

Remote Control

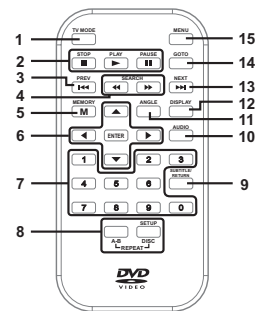

- TV MODE button**
In stop mode, select whether to output the video signal in PAL or NTSC. When the TV shows "AUTO" this means the output signal depends on the DVD. If the TV shows "PAL" or "NTSC" it means the output signal is fixed to either "PAL" or "NTSC". For best results, keep this set on "AUTO" or "NTSC".
- STOP button**
Stop playing a disc.
▶ **PLAY button**
Press to start or resume playback a disc.
⏸ **PAUSE button**
Pause playback, frame advance.
- PREV button**
Move back through titles, chapters or tracks on a disc.
- SEARCH buttons**
◀◀ **SEARCH**: Fast reverse playback.
▶▶ **SEARCH**: Fast forward playback.
- MEMORY button**
In stop mode, enter the number of a selected chapter or track.
- Cursor (▼, ▲, ◀, ▶) buttons**
Use to highlight selections on a menu screen and adjust certain settings.
- ENTER button**
Confirm selections on a menu screen.
- Number (0 - 9) buttons**
Use when creating programmes, and entering a parental level password. Also use to select a CD track directly.
- SETUP button**
In stop mode, open and close the SETUP menu.
REPEAT A-B button
Perform point-to-point repeat playback on a DVD or CD.
REPEAT DISC button
Repeat chapter or title of a DVD.
Repeat single track or whole CD.
- SUBTITLE button**
Select one of the subtitle languages programmed on a DVD.
RETURN button
Return to the normal operation after using the SETUP menu of a DVD.
- AUDIO button**
Select one of the audio sound tracks programmed on a DVD or select the audio output mode on an AUDIO CD.
- ANGLE button**
Switches between multiple camera angles when the DVD you are playing has multiple camera angles recorded.
- DISPLAY button**
Change disc status information displayed on the screen.
- NEXT button**
Move forward through titles, chapters or tracks on a disc.
- GOTO button**
Skip directly to a location on a DVD.
- MENU button**
Open and close DVD menu.

Unit

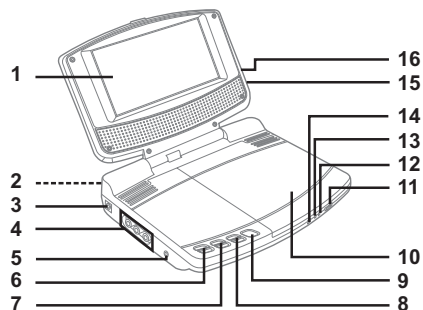

- TFT cover**
- Rechargeable battery**
- DC IN 9V / Car Plug 12V jack**
- AUDIO OUT L / R jacks**
VOL MAX
Adjust the VOLUME to MAX when connecting the unit to another device.
VIDEO OUT jack
- Headphone jack**
- VOLUME +/- controls**
- PREV button**
Press ◀◀ **PREV** button to go back to previous chapters / tracks. Press and hold ◀◀ **PREV** button to begin fast scan.
▶▶ **NEXT button**
Press ▶▶ **NEXT** button to advance chapters / tracks. Press and hold ▶▶ **NEXT** button to begin fast scan.
- II PAUSE button**
Press to pause playback of disc. Each time you press the PAUSE button the picture advances one frame. Press the PLAY ▶ button to resume playback.
- STOP button**
Stop playing a disc.
- PLAY button**
Press to start or resume playback a disc.
- Disc Door**
- POWER ON / OFF switch**
- POWER ON indicator**
When the POWER ON / OFF switch is in the ON position, the light will illuminate.
- CHARGING indicator**
Charge the rechargeable battery before using them for the first time. The normal charging time should be completed at least 4-5 hours. The green charging light will go out when the battery becomes fully charged.
- Remote sensor**
Receives the remote control unit signals.
- BRIGHTNESS button**
Adjust the relative lightness or darkness of the colour.
- Screen switch**
WIDE : Wide screen
NORMAL : Normal screen

POWER SUPPLY

A. Using the AC adapter

This AC adapter operates on AC 100V -120V.

Cautions:

- The included AC adapter is for use with this unit only. Do not use them with other equipment.
- When the unit is not going to be used for long time, disconnect the AC adapter from the AC outlet.
- When the AC adapter is plugged in, the apparatus is not completely disconnected from the main, even when the power is turned off.

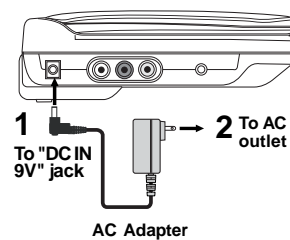

B. Using a car plug adapter

A 12V car plug adapter allows the unit to be used with vehicles that have a 12V, negative ground electrical system.

WARNING: Disconnect the car plug adapter when not in use. Not for use in 24V vehicles.

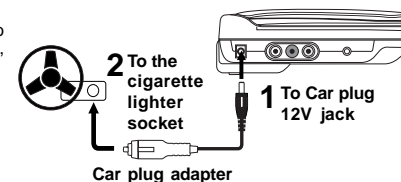

Cautions:

- Use this unit only with the included car plug adapter, use with other car adapter could damage the unit or even your vehicle.
- The included car plug adapter are for use with this unit only. Do not use them with other equipment.
- In the interest of traffic safety, do not operate this unit or view videos while driving a vehicle.
- Make sure the unit is fastened securely to prevent it from falling or flying through the air in the event of an accident.
- When the inside of the cigarette lighter socket is dirty with ashes or dust, the plug section may become hot due to poor contact. Be sure to clean the cigarette lighter socket before use.
- After use, disconnect the 12V car plug adapter from both the unit and cigarette lighter socket.

C. Using the rechargeable battery

- Charge the rechargeable battery before using them for the first time. The normal charging time should be completed at least 4-5 hours. The green charging light will go out when the battery becomes fully charged.
- The rechargeable battery is suitable when adapting the unit for portable use and when it is convenient for you to enjoy the unique functions of the unit out of doors.

To recharge the battery

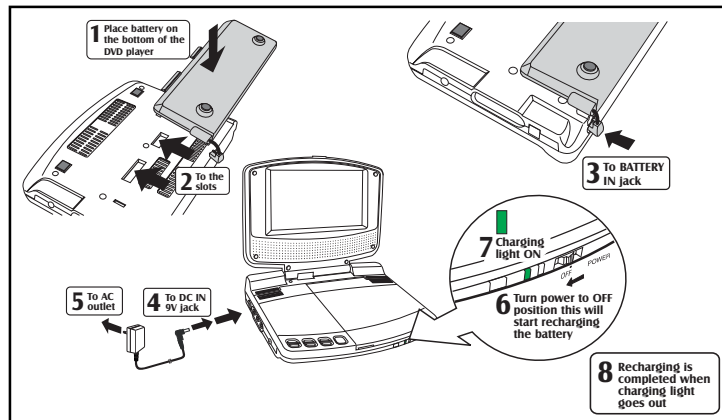

Warnings:

- It could only be recharged when the unit is OFF and using the AC adapter.
 - The rechargeable battery cannot be recharged when the unit is ON.
- Cautions:**
- The included AC adapter is for use with this unit only. Do not use them with other equipment.
 - When the unit is not going to be used for long time, disconnect the AC adapter from the AC outlet.
 - When the AC adapter is plugged in, the apparatus is not completely disconnected from the main, even when the power is turned off.

Condition and attention:

- When rechargeable battery power is low, the unit will stop playing.
- Do not short-circuit the terminals.
- Recharge the battery when you are ready to use it again.
- While using the rechargeable battery, the environmental temperature should be 5°C (41°F) to 35°C (95°F).
- To get the longest service life of the rechargeable battery, charge at indoor-temperature.
- Never dispose the rechargeable battery in fire or water. Never heat up the rechargeable battery.
- Do not open the rechargeable battery, refer servicing only to qualified service personnel.

Turning on the unit

- Slide the POWER ON/OFF switch on the front of the unit to the "ON" position.
- The DVD logo (start-up picture) will appear on the screen.

CONNECTIONS

A. Connecting a TV

- If your TV has audio/video inputs, you can also connect the unit to your TV using an audio/video cable.
- You must adjust the VOLUME to MAXIMUM when you connect this unit to other equipment.
- Put down the TFT cover when the playback mode is chosen.

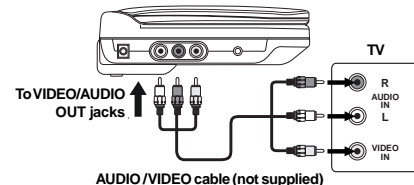

Watching a DVD on your TV

- Turn on the unit.
- Turn on the TV and set it to DVD mode.

B. Using Headphones / Earphones

- Turn down the volume before connection, and then adjust the level.
- When headphones / earphones are connected, no sound will be output from the unit's speaker.

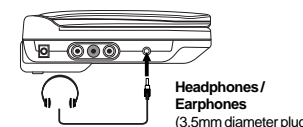

Caution: Avoid listening to sound at levels which may be harmful to your ears.

SOUND SYSTEM

Dolby Digital

Dolby Digital is a technology developed by Dolby Laboratories. Soundtracks encoded in Dolby Digital can reproduce from one to 5.1 discrete channels of excellent quality audio. The unit automatically recognizes the Dolby Digital bitstream and provides a downmix suitable for two-channel listening. An additional Dolby Digital decoder is required for reproduction of the discrete multi-channel soundtracks available on many DVDs.



Manufactured under license from Dolby Laboratories. 'Dolby' and the double-D symbol are trademarks of Dolby Laboratories.

PLAYING A DISC Basic playback

This owner's manual explains the basic instructions for operating this unit. Some DVDs are produced in a manner that allows specific or limited operation during playback. Therefore, this unit may not respond to all operating commands. THIS IS NOT A DEFECT. Please refer to the instructions accompanying the specific DVD in question for more information about the options available on that DVD. " " may appear on the screen during operation. A " " means that the desired operation is not permitted by the unit or disc.

Playing a Disc

- Slide the POWER ON/OFF switch on the front of the unit to the ON position. See CUSTOMIZING THE FUNCTION SETTINGS before proceeding to step 2.
- Open the disc door.
- Hold the disc by its sides and carefully place it onto the spindle with the label side facing up, pushing gently until you hear a "click".
- Close the disc door.
It takes a short while for your unit to load the disc. After loading, the unit will automatically either bring you to the main menu of the DVD, or start playing the DVD.
- If the unit does not automatically start playing the DVD, press the ▶ **PLAY** button.

Pausing playback (still mode)

Press the ⏸ **PAUSE** button. To resume normal playback, press the ▶ **PLAY** button. Each time you press the ⏸ **PAUSE** button, the picture advances one frame.

Stopping playback

Press the ■ **STOP** button at the location where you want to interrupt playback. To resume playback at the position where the disc was stopped, press the ▶ **PLAY** button. If you press the ■ **STOP** button twice, the unit's memory will be cleared and pressing the ▶ **PLAY** button will reset the disc to the beginning.

Skipping to a different track

- Press the ◀◀ **PREV** button repeatedly to skip to the start of the current or previous track.
- Press the ▶▶ **NEXT** button to skip to the next track.
- For audio CDs, use the number buttons on the remote control to jump immediately to the desired track number.

Fast Forward/Fast Reverse

- Press the ◀◀ **PREV** or ▶▶ **NEXT** button when a disc is playing.
 - The disc begins a fast scan at two times normal (x2) speed.
 - Four speeds are available. Each time the **SEARCH** button is pressed, the speed of the fast scan changes in the following sequence:

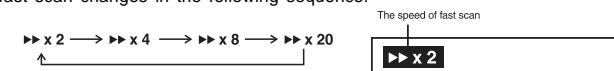

Notes:

- You also can press and hold ◀◀ / ▶▶ (**PREV/NEXT**) buttons repeatedly to select different fast scan speeds.
- Press the ▶ **PLAY** button when you reach the desired point to resume playback at normal speed.

SKIP (Forward / Reverse)

While you are playing a disc, press the ▶▶ **NEXT** button to move to the beginning of the next chapter or track. Press the ◀◀ **PREV** button to move to the previous chapter or track and automatically start playing it.

Audio selection

On some discs, the sound is recorded in two or more formats. Follow the directions below to select the type of playback.

- While a disc is playing, press the **AUDIO** button to show the current audio format number.
- Press the **AUDIO** button repeatedly to select the desired audio format.



Notes:

- If only one audio format is recorded, the number does not change.
- About two seconds later, playback continues in the new audio format.

Subtitle selection

- While a DVD is playing, press the **SUBTITLE / RETURN** button to display the current language setting, as shown in the example below.
- Press the **SUBTITLE / RETURN** button repeatedly to select the desired subtitle language.



Notes:

- If only one language is recorded, the language does not change.
- About two seconds later, playback continues with the new subtitle you selected.
- The number of languages recorded differs depending on the disc.
- If no button is pressed within a few seconds, playback continues without changing the current subtitle.
- This function can only be used for discs on which subtitles have been recorded in multiple languages.
- On some DVDs, subtitles are activated from the main menu of the DVD. Press the **MENU** button to activate the main menu.

Angle selection  Some DVDs contain scenes which have been shot from a number of different angles. For these discs, the same scene can be viewed from each of these different angles.

- While you are playing a DVD with different angles recorded, press the **ANGLE** button to view the number of the current angle available.
- Press the **ANGLE** button repeatedly to change the scene to the next recorded angle.
 - After approx. two seconds, playback will continue from the new angle you selected.
 - If no button is pressed within 10 seconds, playback continues without changing the current angle.

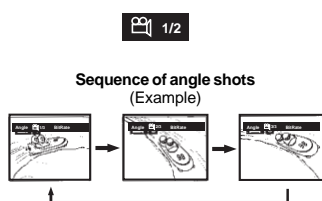

- Notes:**
- This function can only be used for discs on which scenes shot from multiple angles have been recorded.
 - If only one angle is recorded, "1/1" is displayed.

SPECIAL FUNCTIONS Basic playback

DISPLAY function

Using DISPLAY, you can check and change the current settings of the following items: ANGLE, AUDIO, SUBTITLE and BITRATE.

- While the disc is playing, press the **DISPLAY** button to display the screen shown below.

Elapsed time: Elapsed time from the beginning of the chapter which is currently playing.
Remaining time: Remaining time of the title which is currently playing.

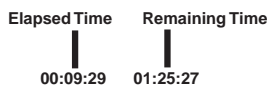

GOTO function

This function allows you to skip directly to any part of the disc while a disc is playing. Press ◀ or ▶ button to highlight time.

- Notes:**
- After adjusting the settings, press the **DISPLAY** button again to return to the normal screen.

Locating a specific title

If a DVD contains title numbers, you can locate a specific title by directly selecting its title number.

- In stop mode, press the **GOTO** button.
- Press ◀ or ▶ button to highlight a specific field and press the corresponding number button(s) for the title you want.
- Press the **ENTER** button to confirm. The unit will start playback about 3 seconds later.

Title/Chapter ---/---

Locating a specific title / chapter / track

If you know the title/chapter/track number for the title/chapter/track that you want to play, you can locate it by directly selecting that number.

- Press the **GOTO** button to search for your desired title/chapter/track.
- Press ◀ or ▶ button to highlight a title/chapter/track and press the corresponding number button(s) for the chapter you want.
- Press the **ENTER** button to confirm. The unit will start playback about 3 seconds later.

DVD

Title/Chapter ---/---

CD

Track ---

Locating a specific time

You can move to a specific location by entering its corresponding time (hours, minutes, seconds)

- Press the **GOTO** button.
- Press ◀ or ▶ button to highlight time.
- Press the corresponding number buttons for the setting point you want.
- Press the **ENTER** button to confirm. The unit will start playback about 3 seconds later.

Time ---:--:--

Notes :



- Some discs may not respond to this process.
- Some scenes may not be located as precisely as you specified.
- This method for accessing specific locations is available only within the current title of the DVD disc.

CD/DVD PROGRAMMABLE MEMORY

Programmable memory

The two types of programmed playback provided by this Unit are title programmed playback and chapter programmed playback.

Title / Chapter programmed playback

- Press the **MEMORY** button while the disc is stopped.
- Enter the title numbers in . Use ◀ or ▶ button to highlight your desired chapter and enter the chapter numbers in .
- Use ◀, ▶, ▲ or ▼ button to move to another field.
- Repeat steps 2 to 3.
- Press the **PLAY** button to start the programmed playback.

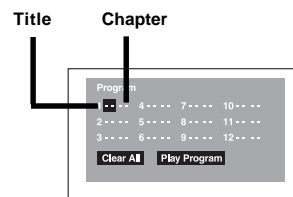

Notes :

- If you press the **STOP** button twice, the programmed selections will be cleared.

Track programmed playback

- Press the **MEMORY** button while the disc is stopped.
- Enter the track numbers in .
- Use ◀, ▶, ▲ or ▼ button to move to another field.
- Repeat steps 2 to 3.
- Press the **PLAY** button to start the programmed playback.

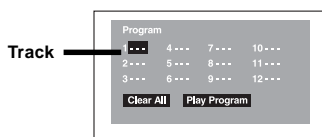

REPEAT PLAYBACK

You can play a specific title or chapter repeatedly. (Title repeat, chapter repeat, A-B repeat)

Repeating a chapter

You can play the same chapter repeatedly.

- While the disc is playing, press the **REPEAT DISC** button until the "Repeat Chapter" indicator displays on the screen. The current chapter is played repeatedly.

Repeating a title

You can play the same title repeatedly.

- While the disc is playing, press the **REPEAT DISC** button until the "Repeat Title" indicator displays on the screen. The current title is played repeatedly.

To resume normal playback

- While the disc is playing, press the **REPEAT DISC** button until the "Off" indicator displays on the screen.

You can play a single track or the whole DVD repeatedly.

Repeating a single track

You can play the same track repeatedly.

- While the disc is playing, press the **REPEAT DISC** button until the "Repeat Single" indicator displays on the screen. The current track is played repeatedly.

Repeating a whole disc

- While the disc is playing, press the **REPEAT DISC** button until the "Repeat All" indicator displays on the screen. The whole disc is played repeatedly.

To resume normal playback

- Press the **REPEAT DISC** button until the "Off" indicator displays on the screen.

Repeating a specific section

You can play a specific section repeatedly.

- While the disc is playing, press the **REPEAT A-B** button at the beginning of the section ((Rep A-) is displayed) you want to play repeatedly.
- Press the **REPEAT A-B** button again at the end of the section ((Rep A-B) is displayed). The Unit will immediately begin replaying your selection.
- To resume normal playback
- While the disc is playing, press the **REPEAT A-B** button until the "Off" indicator displays on the screen.

Notes:

- A-B repeat can only be used within the same title. If the start and end of the section to be repeated are in different titles, A-B repeat is cancelled.
- The A-B repeat function does not operate in scenes where different camera angles are recorded.

PLAYING MP3 AND PICTURE FILE DISC

This unit can play MP3 and Picture files recorded on CD-R and CD-RW discs.

Playing an MP3/Picture file disc

- Slide the **OPEN** switch to open the disc door.
- Hold an MP3 /Picture file disc by its edge and gently push it onto the spindle with the label side facing up until you hear a "click".
- Close the disc door.
- The unit will load the disc and automatically display the contents of the disc on the screen, while also beginning to play the first MP3 file or Picture files. These files will then be played back one by one.
- Press the ▲, ▼, ◀ or ▶ **CURSOR** button to view and select the files that you want to listen to, then press the **ENTER** button to confirm the selected file.

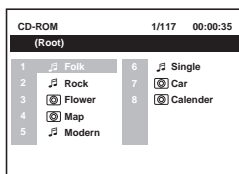

Notes:

- You can press the **II PAUSE** button to interrupt playback, and press the **PLAY** button to resume playback.
- You also can use the **GOTO** function or use the numbered buttons to enter a photo number and quickly select any image.
- Press the **ANGLE** button on the remote control to rotate the picture orientation by 90°.

Playable files

The ability of this unit to read MP3 discs is dependent on the following:

- The Bit Rate must be within 64 - 256 kbps.
- The total number of files on the disc should not exceed 254.
- The maximum number of directories should not exceed 32.
- The maximum depth level of directories should not exceed 4.
- File names should be named using 7 or fewer letters and/or numbers, and must incorporate the "MP3" file extension. EXAMPLE: "*****.MP3" where each * is a letter or number.
- Use only letters and / or numbers in file names. If you use special characters, the file and/or folder names may not be displayed correctly on the on-screen display.
- When recording on CD-R discs, use 74-minute (650MB) discs.
- The CD-R or CD-RW discs should be "finalized" on the computer using "single session format".
- See your CD/MP3 creation software for more information.

CUSTOMIZING THE FUNCTION SETTINGS

LANGUAGE setting

- Press the **SETUP** button in stop mode.
- Use ▲ or ▼ button to select a language, then press the **ENTER** button. The screen will change to your selected language immediately.
- To exit the SETUP MENU and return to the normal screen, press the **RETURN** button.

Language

English
Deutsch
Français
Español
Italiano
Svenska
Português

VIDEO setting

- Press the **SETUP** button in stop mode.
- Use ◀ or ▶ button to select **Video**, then press the **ENTER** button.
- Use ▲ or ▼ button to select the options (**TV Shape**, **Brightness** or **Edges**) to be adjusted by pressing ▲ or ▼ button, then press the **ENTER** button. (The screen will change to your desired setting).
- Repeats step 2 and 3 above to adjust other options.
- To exit the FUNCTION SETUP MENU and return to the normal screen, press the **RETURN** button.

Pan Scan

- When wide-screen video is played, this mode clips the right and left sides of the image so that it can be viewed on a conventional screen.
- Some wide-screen DVDs that do not permit Pan Scan mode playback are automatically played in letterbox mode (black bands top and bottom).

Letter Box

- When wide-screen video is played in this mode on a conventional screen, black bands appear at the top and bottom of the screen.

Wide-screen

- This is the correct mode for playing wide-screen videos on a wide-screen.

Notes :

- The visible picture size is preset on the DVD disc. Therefore the playback picture of some DVD discs may not conform to the picture size you select.
- When you play DVD discs recorded in the 4:3 aspect ratio, the playback picture will always appear in the 4:3 aspect ratio regardless of the TV shape setting.

RATING

DVD discs equipped with a password function and are rated according to their content. The contents allowed by parental lock level and the way a DVD disc is controlled may vary from disc to disc. For example, if the disc allows, you could lock-out violent scenes unsuitable for children or you could lock out playback of the disc altogether.

- Press the **SETUP** button in stop mode.
- Use ◀ or ▶ button to select **Rating**, press the **ENTER** button.
- Use ▲ or ▼ button to select parental lock and then press the **ENTER** button repeatedly to set the parental lock level.
- Use ▲ or ▼ button to shift and select Password, enter your 4-digit security code and then press the **ENTER** button.

Password ----
Parental lock 8. Adult
Factory Set No

If you forget the password, you can erase your current password by pressing number button 8 on the remote four times, then press the **ENTER** button to confirm the setting (PASSWORD : 8 8 8 8).

The parental lock levels are equivalent to the following ratings.

Level 1 : Kid Safe Level 5 : PG-R
Level 2 : G Level 6 : R
Level 3 : PG Level 7 : NC-17
Level 4 : PG-13 Level 8 : Adult

Notes :

It takes 3-5 seconds to reset the unit to the factory default.

TROUBLE SHOOTING GUIDE

SYMPTOM

CAUSE (AND REMEDY)

No power.

- Check that the AC adapter is connected.
- The unit is not turned on.

The remote control does not function.

- Remove any obstacles between the remote and the unit.
- Use the remote near the unit.
- Point the remote at the remote sensor on the unit.
- Replace all the battery in the remote with new ones.

DVD

No sound or only a very low-level sound is heard.

- Make sure that you select DVD mode.
- The system is in pause mode. Press the **PLAY** button to return to normal play mode.
- The unit is in fast-forward or fast-reverse mode. Press the **PLAY** button to return to normal play mode.
- Make sure that AUDIO / VIDEO output connections are correct.
- The DTS DVD disc cannot be decoded to have speaker output.
- The unit is too hot, shut off the unit for 30 minutes to cool it down.

No picture

- The region number of the disc doesn't match the region number of this unit. 

The picture is not clear

- Clean the disc.
- The disc is scratched.

Severe hum or noise is heard.

- The plugs and jacks are dirty. Wipe them with a cloth slightly moistened with alcohol.
- Clean the disc.

The disc does not play.

- There is no disc inside ("No Disc" appears on the screen).
- Insert the disc correctly with the playback side facing down.
- Clean the disc.
- A non-NTSC disc has been inserted. The unit and disc region number are incompatible.
- Condensation may have formed inside the unit due to a sudden change in temperature. Wait about an hour for it to clear and try again.

Specifications and external appearance are subject to change without notice.

Need More Help?
DO NOT RETURN THIS TO THE STORE
Please visit online help at
<http://www.venturersupport.com>

PORTABLE DVD PLAYER

DOLBY DIGITAL

COMPACT DISC DIGITAL AUDIO

DIGITAL PHOTO STORE

CD-R/RW

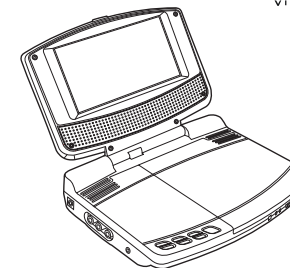

OWNER'S MANUAL

SAFETY PRECAUTIONS



The lightning flash with an arrowhead symbol, within the equilateral triangle, is intended to alert the user to the presence of uninsulated "dangerous voltage" within the product's enclosure that may be of sufficient magnitude to cause an electric shock.

The exclamation point within the equilateral triangle is intended to alert the user to the presence of important operating and maintenance (servicing) instructions in this owner manual.

SEE BOTTOM OF UNIT FOR GRAPHIC SYMBOLS

CLASS 1 LASER PRODUCT

This product contains a low power laser device.

WARNING: TO REDUCE THE RISK OF ELECTRIC SHOCK, DO NOT REMOVE COVER (OR BACK). NO USER-SERVICEABLE PARTS INSIDE. REFER SERVICING TO QUALIFIED SERVICE PERSONNEL.

WARNING: TO PREVENT FIRE OR SHOCK HAZARD, DO NOT EXPOSE THIS APPLIANCE TO RAIN OR MOISTURE. DO NOT PLACE OBJECTS FILLED WITH LIQUIDS ON OR NEAR THIS UNIT.

CAUTION: DANGER OF EXPLOSION IF BATTERY IS INCORRECTLY REPLACED. REPLACE ONLY WITH THE SAME OR EQUIVALENT TYPE.

CAUTION INVISIBLE LASER RADIATION WHEN OPEN AND INTERLOCKS DEFEATED. AVOID EXPOSURE TO BEAM.

On Placement

- Do not use the unit in places which are extremely hot, cold, dusty, or humid.
- Do not restrict the air flow of the unit by placing it in a place with poor air flow, by covering it with a cloth, or by placing it on carpeting.

FCC Information

This device complies with Part 15 of FCC Rules.

Operation is subject to the following two conditions:

- This device may not cause harmful interference, and
- This device must accept any interference received, including interference that may cause undesirable operation.

On Safety

- When connecting or disconnecting the AC adapter, grip the plug and not the cord itself. Pulling the cord may damage it and create a hazard.
- When you are not going to use the unit for a long period of time, disconnect the AC adapter.

On Condensation

- When left in a heated room where it is warm and damp, water droplets or condensation may form inside the unit. When there is condensation inside the unit, the unit may not function normally. Let the unit stand for 1 to 2 hours before turning the power on, or gradually heat the room up and dry the unit before use.

Rating Plate Location

- The rating plate is located on the bottom of unit.

WARNING: Should any trouble occur, disconnect the AC adapter and refer servicing to a qualified technician.

Notes on Copyright

It is forbidden by law to copy, broadcast, show, broadcast on cable, play in public, rent copyrighted material without permission.

Apparatus Claims of U.S. Patent Nos. 4,631,603; 4,577,216; 4,819,098 and 4,907,093 licensed for limited viewing uses only.

DVD video discs are copy protected, and any recordings made from these discs will be distorted. This product incorporates copyright protection technology that is protected by method claims of certain U.S. patents and other intellectual property rights owned by Macrovision Corporation and other rights owners. Use of this copyright protection technology must be authorized by Macrovision Corporation, and is intended for home and other limited viewing uses only, unless otherwise authorized by Macrovision Corporation. Reverse engineering or disassembly is prohibited.

MAINTENANCE

Cleaning Disc

A defective or soiled disc inserted into the unit can cause sound to drop out during playback.

Handle the disc by holding its inner and outer edges.

- Do NOT touch the surface of the unlabeled side of the disc.
- Do NOT stick paper or tape on the surface.
- Do NOT expose the disc to direct sunlight or excessive heat.
- Clean the disc before playback. Wipe the disc from the center outward with a cleaning cloth.
- NEVER use solvents such as benzene or alcohol to clean the disc.
- Do NOT use irregular shape discs (example : heart shaped, octagonal, etc.). They may cause malfunctions.

Cleaning the unit

- Be sure to turn the unit off and disconnect the AC adapter before maintaining the unit.
- Wipe the unit with a dry soft cloth. If the surfaces are extremely dirty, wipe clean with a cloth which has been dipped in a weak soap-and-water solution and wrung out thoroughly, then wipe with a dry cloth.
- Never use alcohol, benzene, thinner, cleaning fluid or other chemicals. Do NOT use compressed air to remove dust.

Important Note

Before transporting the unit, remove any disc from the disc compartment.

