

DVD
DVD
DVD
DVD
DVD
DVD
DVD
DVD
DVD
DVD
DVD
DVD

PORTABLE DVD PLAYER WITH 5" LCD SCREEN



DVD
VIDEO

DD DOLBY
DIGITAL

COMPACT
disc
DIGITAL AUDIO

CD-R/RW

OWNER'S MANUAL

SAFETY PRECAUTIONS

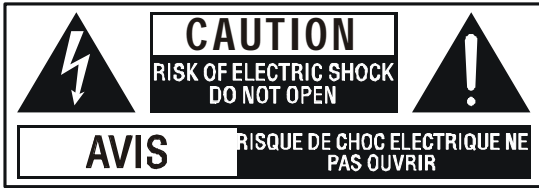

WARNING: TO REDUCE THE RISK OF ELECTRIC SHOCK, DO NOT REMOVE COVER (OR BACK). NO USER-SERVICEABLE PARTS INSIDE. REFER SERVICING TO QUALIFIED SERVICE PERSONNEL.

WARNING: TO PREVENT FIRE OR SHOCK HAZARD, DO NOT EXPOSE THIS APPLIANCE TO RAIN OR MOISTURE.

CAUTION: DANGER OF EXPLOSION IF BATTERY IS INCORRECTLY REPLACED. REPLACE ONLY WITH THE SAME OR EQUIVALENT TYPE.



The lightning flash with an arrowhead symbol, within the equilateral triangle, is intended to alert the user to the presence of uninsulated "dangerous voltage" within the product's enclosure that may be of sufficient magnitude to cause an electric shock.



The exclamation point within the equilateral triangle is intended to alert the user to the presence of important operating and maintenance (servicing) instructions in this owner manual.



This product contains a low power laser device.

*** SEE BOTTOM OF UNIT FOR GRAPHIC SYMBOLS ***

On Placement

- Do not use the unit in places which are extremely hot, cold, dusty, or humid.
- Place the unit on a flat and even surface.
- Do not restrict the air flow of the unit by placing it in a place with poor air flow, by covering it with a cloth, or by placing it on carpeting.

FCC Information

This device complies with Part 15 of FCC Rules.

Operation is subject to the following two conditions:

- (1) This device may not cause harmful interference, and
- (2) This device must accept any interference received, including interference that may cause undesirable operation.

On Safety

- When connecting or disconnecting the AC adapter, grip the plug and not the cord itself. Pulling the cord may damage it and create a hazard.
- When you are not going to use the unit for a long period of time, disconnect the AC adapter.

On Condensation

- When left in a heated room where it is warm and damp, water droplets or condensation may form inside the unit. When there is condensation inside the unit, the unit may not function normally. Let the unit stand for 1 to 2 hours before turning the power on, or gradually heat the room up and dry the unit before use.

Rating Plate Location

- The rating plate location is on the bottom of unit.

WARNING:

- Should any trouble occur, disconnect the AC adapter and refer servicing to a qualified technician.

Notes on Copyright

It is forbidden by law to copy, broadcast, show, broadcast on cable, play in public, rent copyrighted material without permission.

Apparatus Claims of U.S. Patent Nos. 4,631,603; 4,577,216; 4,819,098 and 4,907,093 licensed for limited viewing uses only.

DVD video discs are copy protected, and any recordings made from these discs will be distorted. This product incorporates copyright protection technology that is protected by method claims of certain U.S. patents and other intellectual property rights owned by Macrovision Corporation and other rights owners. Use of this copyright protection technology must be authorized by Macrovision Corporation, and is intended for home and other limited viewing uses only, unless otherwise authorized by Macrovision Corporation. Reverse engineering or disassembly is prohibited.

IMPORTANT SAFETY INSTRUCTIONS

1. **Read Instructions** - All the safety and operating instructions should be read before the appliance is operated.
2. **Retain Instructions** - The safety and operating instructions should be retained for future reference.
3. **Heed Warnings** - All warnings on the appliance and in the operating instructions should be adhered to.
4. **Follow Instructions** - All operating and use instructions should be followed.
5. **Water and Moisture** - The appliance should not be used near water - for example, near a bathtub, washbowl, kitchen sink, laundry tub, in a wet basement, or near a swimming pool, and the like.
6. **Carts and Stands** - The appliance should be used only with a cart or stand that is recommended by the manufacturer.
- 6A. An appliance and cart combination should be moved with care. Quick stops, excessive force, and uneven surfaces may cause the appliance and cart combination to overturn.
7. **Wall or Ceiling Mounting** - The appliance should be mounted to a wall or ceiling only as recommended by the manufacturer.
8. **Ventilation** - The appliance should be situated so that its location or position does not interfere with its proper ventilation. For example, the appliance should not be situated on a bed, sofa, rug, or similar surface that may block the ventilation openings; or, placed in a built-in installation, such as a book case or cabinet, that may impede the flow of air through the ventilation openings.
9. **Heat** - The appliance should be situated away from heat sources such as radiators, heat registers, stoves, or other appliances (including amplifiers) that produce heat.
10. **Power Sources** - The appliance should be connected to a power supply only of the type described in the operating instructions or as marked on the appliance.
11. **Grounding or Polarization** - Precautions should be taken so that the grounding or polarization means of an appliance are not defeated.



12. **Power-Cord Protection** - Power-supply cords should be routed so that they are not likely to be walked on or pinched by items placed upon or against them, paying particular attention to cords at plugs, convenience receptacles, and the point where they exit from the appliance.
13. **Cleaning** - The appliance should be cleaned only as recommended by the manufacturer.
14. **Power Lines** - An outdoor antenna should be located away from power lines.
15. **Outdoor Antenna Grounding** - If an outside antenna is connected to the receiver, be sure the antenna system is grounded so as to provide some protection against voltage surges and built up static charges. Section 810 of the National Electrical Code, ANSI/NFPA No. 70, provides information with respect to proper grounding of the mast and supporting structure, grounding of the lead-in wire to an antenna discharge unit, size of grounding conductors, location of antenna-discharge unit, connection to grounding electrodes, and requirements for the grounding electrode. See Figure 1.
16. **Nonuse Periods** - The power cord of the appliance should be unplugged from the outlet when left unused for a long period of time.
17. **Object and Liquid Entry** - Care should be taken so that objects do not fall, and liquids are not spilled, into the enclosure through openings.
18. **Damage Requiring Service** - The appliance should be serviced by qualified service personnel when:
 - A. The power-supply cord or the plug has been damaged; or
 - B. Objects have fallen, or liquid has been spilled, into the appliance; or
 - C. The appliance has been exposed to rain; or
 - D. The appliance does not appear to operate normally or exhibits a marked change in performance; or
 - E. The appliance has been dropped, or the enclosure damaged.
19. **Servicing** - The user should not attempt to service the appliance beyond that described in the operating instructions. All other servicing should be referred to qualified service personnel.

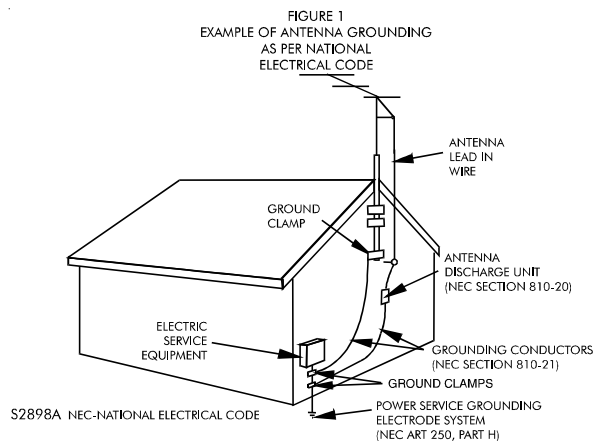

TABLE OF CONTENTS

Safety Precautions	1	Repeat Playback	20
Important Safety Instruction	2	Repeating a title/chapter (DVD)	20
Table Of Contents	3	Repeating a single track/whole disc (CD)	20
Disc Formats	4	Playing MP3 and Picture File Disc	21-22
Accessories	5	Playing a MP3 file disc	21
Remote Control	5	Playing a Picture file disc	22
Control Reference Guide	6-7	Playing a MP3/Picture file disc	22
Power Supply	8-10	Customizing the Function Settings	23-26
Using the AC adapter	8	LANGUAGE setting	23
Using the car power adapter	8	VIDEO setting	23-24
Using the rechargeable battery pack	9-10	AUDIO setting	24-25
Turning on the unit	10	RATING setting	25-26
Connections	11-12	Language Code List for Disc Language	27
Connecting a TV	11	27
Another source connection	11	Maintenance	28
Using headphones/earphones	12	Cleaning Disc	28
Sound System	12	Cleaning the Unit	28
Playing a Disc	13-15	Important Note	28
Playing a Disc	13	Trouble Shooting Guide	29
Pausing playback (still mode)	13		
Stopping playback	13		
To skip to a different track	13		
Fast Foward/Fast Reverse	14		
Skip (Forward/Reverse)	14		
Zooming into an image	14		
Angle selection	15		
Audio selection	15		
Subtitle selection	15		
Special Functions	16-18		
Display function	16		
Locating a specific title	17		
Locating a specific title/chapter/track	17		
Locating a specific time	18		
Angle setting	18		
Audio setting	18		
Subtitle setting	18		
CD / DVD programmable memory	19		
DVD programmable memory	19		
CD programmable memory	19		

DISC FORMATS

The unit can playback.



DVDs
[8cm/12cm disc]

CD-R CD-RW
Compatible



Audio CDs
[8cm/12cm disc]

Region Management Information

Region Management Information: This unit is designed and manufactured to respond to the Region Management Information that is encoded on DVD discs. If the Region number printed on the DVD disc does not correspond to the Region number of this unit, this unit cannot play that disc.



The region number of this unit is 1.

Disc Function or Operation that is Not Available

When the  symbol appears on the screen, it indicates that the function or operation attempted is not available at that time. This occurs because the DVD disc manufacturer determines the specific functions. Certain functions may not be available on some discs. Be sure to read the documentation provided with the DVD.

Icons Used on DVDs

Sample Icons

	1. English 2. French	Language selections for audio
	1. English 2. French	Language selections for subtitles
		Screen aspect ratio
		Multiple camera angles
		Region code indicator

Notes:

- This Unit supports 2-channel (L/R) audio and 5.1ch (Multi-channel) MPEG Audio 1/2 (only when the DIGITAL AUDIO OUT coaxial jack is used for connection). It does not support 7.1 channel MPEG Audio Version 2.0.
- When playing back a CD-G (Graphics) or CD EXTRA disc, the audio portion will be played, but the graphic images will not be shown.

Title, Chapter and Tracks

- DVDs are divided into “titles” and “chapters”. If the disc has more than one movie on it, each movie would be a separate “title”. “Chapters” are sections of titles.

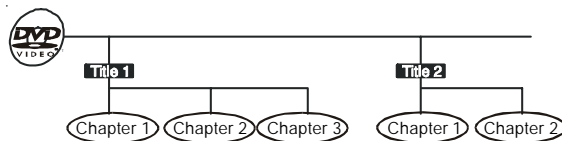

- Audio CDs are divided into “tracks”. A “track” is usually one song on an Audio CD.

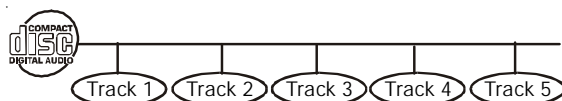

Note :

- Numbers identify each title, chapter, and track on a disc. Most discs have these numbers recorded on them, but some do not.

Notes on Unauthorized Discs

You may not be able to play back some DVD discs on this unit if they were purchased from outside your geographic area or made for business purposes.

ACCESSORIES

Please check and identify the supplied accessories.

Use numbers indicated in parentheses when asking for replacement parts.

• To order accessories contact 1-800-252-6123 or web site (<http://www.18002526123.com>)

- Remote control (with battery) (043-R13232-020) x 1
- AC adapter (133-010901-000) x 1
- Rechargeable battery pack (Model no.: RCBP-02) x 1
- Car power adapter x 1

REMOTE CONTROL

Using the Remote Control

- Point the Remote Control at the REMOTE SENSOR located on the unit.
- When there is a strong ambient light source, the performance of the infrared REMOTE SENSOR may be degraded, causing unreliable operation.
- The recommended effective distance for remote operation is about 16 feet (5 meters).

Take out the PVC sheet before operating the Remote Control.

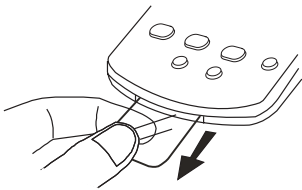

TO CHANGE REMOTE BATTERY

1. Open the battery door.
2. Insert one CR2025 (3V) size battery.

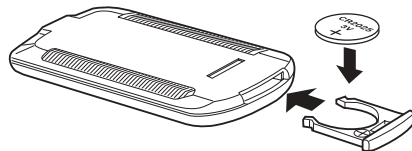
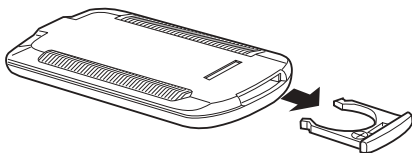

BATTERY REPLACEMENT

When battery becomes weak, the operating distance of the Remote Control will greatly reduced and you will need to replace the battery.

NOTE:

- If the Remote Control is not to be used for a long time, remove the battery to avoid damage caused by battery leakage corrosion.
- **WARNING:** Do not dispose of battery in fire, battery may explode or leak.

CONTROL REFERENCE GUIDE

Remote Control

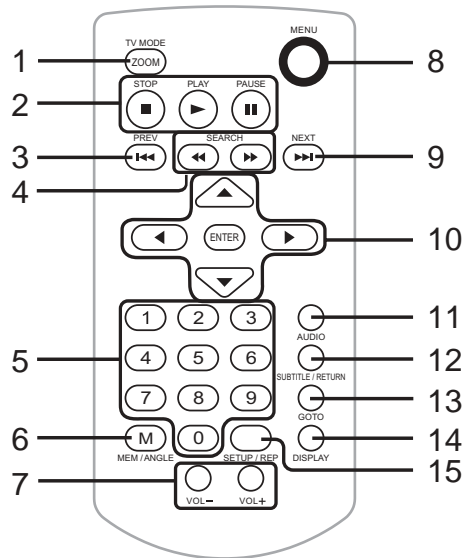

1) ZOOM button

Zoom into an image of a DVD.

TV MODE button

In stop mode, select whether to output the video signal. TV shows "AUTO" means output signal depends on DVD (either NTSC or PAL). TV shows "PAL" or "NTSC" which means output signal fixed to PAL or NTSC.

2) ■ STOP button

Stop playing a disc.

▶ PLAY button

Press to start or resume playback a disc.

|| PAUSE button

Pause playback, frame advance.

3) ◀◀ PREV button

Move reverse through titles, chapters or tracks on a disc.

4) ◀◀ / ▶▶ SEARCH buttons

◀◀ SEARCH: Fast reverse playback.

▶▶ SEARCH: Fast forward playback.

5) Number (0 - 9) buttons

Use when creating programs, and entering a parental level password. To select a CD/MP3 track directly.

6) MEM (MEMORY) button

In stop mode, enter the number of a selected chapter or track.

ANGLE button

During DVD playing, switch the camera angle of the video presentation when scenes with multiple camera angles are recorded on a DVD.

7) VOLUME +/- controls

Adjust the volume.

8) MENU button

Open and close DVD menu.

9) ▶▶ NEXT button

Move forward through titles, chapters or tracks on a disc.

10) Cursor (▼, ▲, ◀, ▶) buttons

Use to highlight selections on a menu screen and make adjust certain settings.

ENTER button

Confirm selections on a menu screen.

11) AUDIO button

Select one of the audio sound tracks programmed on a DVD or selects the audio output mode on a AUDIO CD.

12) SUBTITLE button

Select one of the subtitle languages programmed on a DVD.

RETURN button

Return to the normal operation after using the SETUP menu of a DVD.

13) GOTO button

Skip directly to a specific location on a DVD disc.

14) DISPLAY button

Change disc status information displayed on the screen.

15) SETUP button

In stop mode, Open and close the SETUP menu of the unit.

REP (REPEAT) button

Repeat chapter or title of a DVD.
Repeat single track or whole CD.

CONTROL REFERENCE GUIDE

Unit

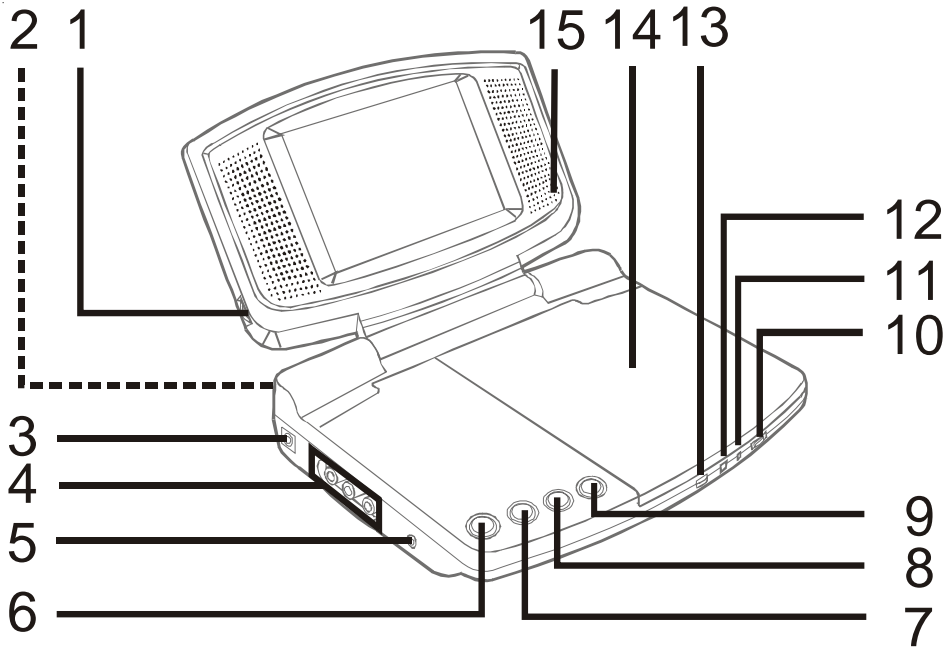

- 1) **BRIGHTNESS button**
Adjust the relative lightness or darkness of the colour.
- 2) **DIGITAL OUT jack**
- 3) **DC IN 9V-12V jack**
- 4) **AV OUT (AUDIO L / R / VIDEO) jacks**
LINE OUT (VOL MAX)
Adjust the VOLUME to MAX position when connect to other equipment.
- 5) **Headphone jack**
- 6) **VOLUME + / - controls**
Adjust the volume.
- 7) **▶▶ NEXT button**
Press ▶▶ **NEXT** button to advance to chapters / tracks. Press and hold ▶▶ **NEXT** button to begin fast scan. Four speeds are available.
◀◀ PREV button
Press ◀◀ **PREV** button to go back to previous chapters / tracks. Press and hold ◀◀ **PREV** button to begin fast scan. Four speeds are available.
- 8) **⏸ PAUSE button**
Press to pause playback of disc. Each time you press the PAUSE button the picture advances one frame. Press the PLAY ▶ button to resume playback.
■ STOP button
Stop playing a disc.
- 9) **▶ PLAY button**
Press to start or resume playback a disc.
- 10) **POWER ON / OFF switch**
- 11) **POWER ON indicator**
Slide the **POWER ON/OFF** switch to ON position, the light will illuminate.
- 12) **Remote sensor**
Receive the remote control unit signals.
- 13) **OPEN button**
Open the disc door.
- 14) **Disc Door**
Close tray by pushing the disc door.
- 15) **TFT cover**

POWER SUPPLY

A. Using the AC adapter

This AC adapter operates on AC 100V - 120V.

- The AC adapter must be connected to a 120V AC outlet only.

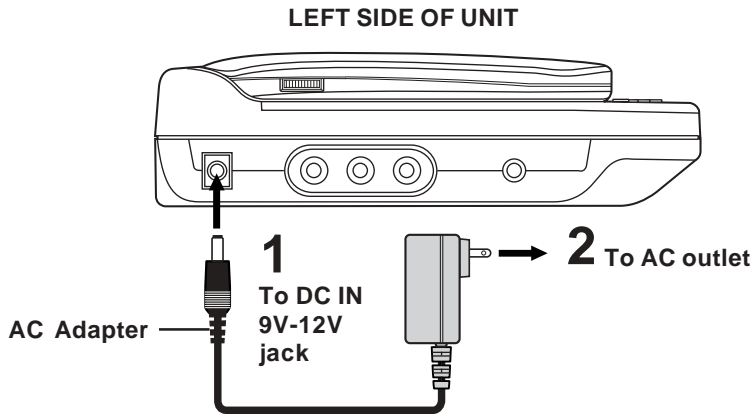

Cautions:

- The included AC adapter is for use with this unit only. Do not use them with other equipment.
- When the unit is not going to be used for long time, disconnect the AC adapter from the AC outlet.

B. Using the car power adapter

The 12V car power adapter is designed for use with vehicles that have a 12V, negative ground electrical system.

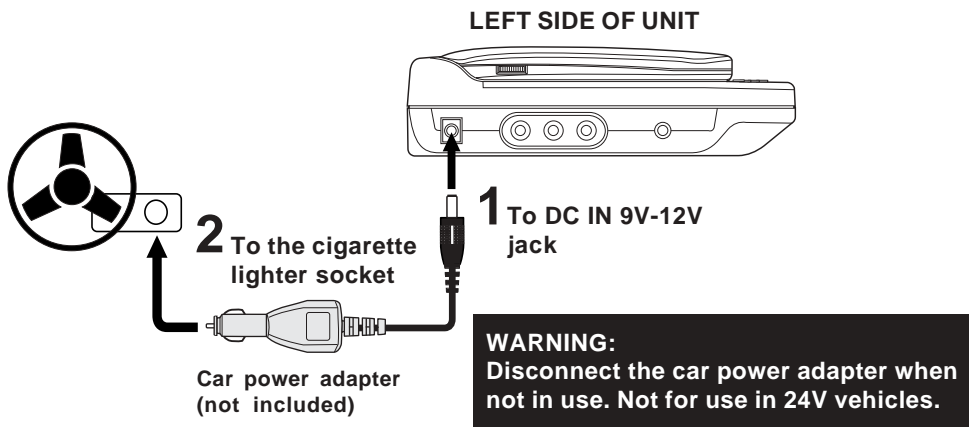

Cautions:

- Use this unit only with the 12V car power adapter, use with other car adapter could damage the unit.
- The 12V car power adapter are for use with this unit only. Do not use them with other equipment.
- In the interests of the traffic safety, do not perform operations on the unit or view video software while driving a vehicle.
- Make sure the unit is fastened correctly to prevent from falling in the vehicle in the event of an accident.
- When the inside of the cigarette lighter socket is dirty with ashes or dust, the plug section may become hot due to poor contact. Be sure to clean the cigarette lighter socket before use.
- After use, disconnect the 12V car power adapter from both the unit and cigarette lighter socket.

POWER SUPPLY

C. Using the rechargeable battery pack

- Charge the rechargeable battery pack before using them for the first time.
- The rechargeable battery pack is suitable when adapting the unit for portable use and when it is convenient for you to enjoy the unique functions of the unit out of doors.
- To recharge the battery
 - Remove the rechargeable battery pack from the unit (if being used).

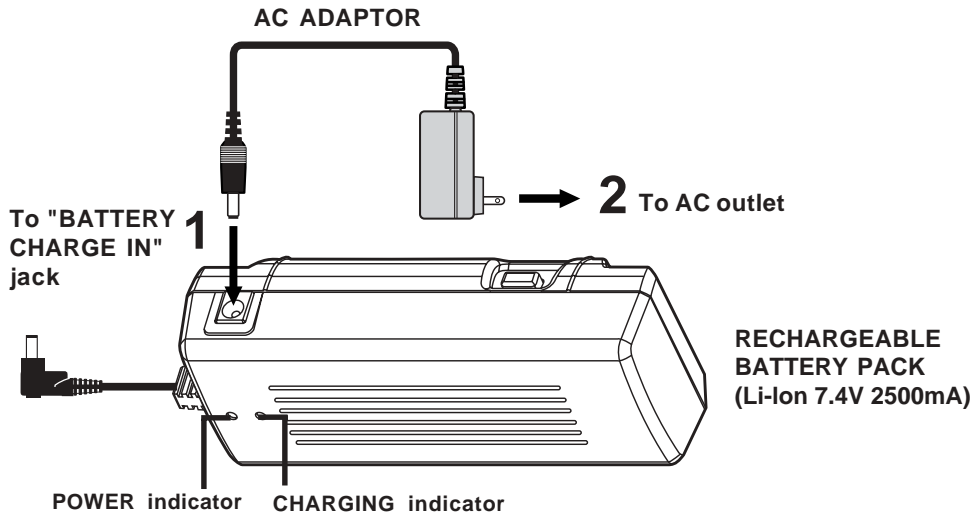

Cautions:

- The included AC adaptor is for use with this unit only. Do not use them with other equipment.
 - When the unit is not going to be used for long time, disconnect the AC adaptor from the AC outlet.
 - You must disconnect the rechargeable battery pack from the unit when you recharge the battery.
-
- Recharging is complete when charging indicator goes out. Unplug the AC adaptor from the rechargeable battery pack.
 - To attach rechargeable battery pack
 - Attach it at the corresponding position at the back of the unit.

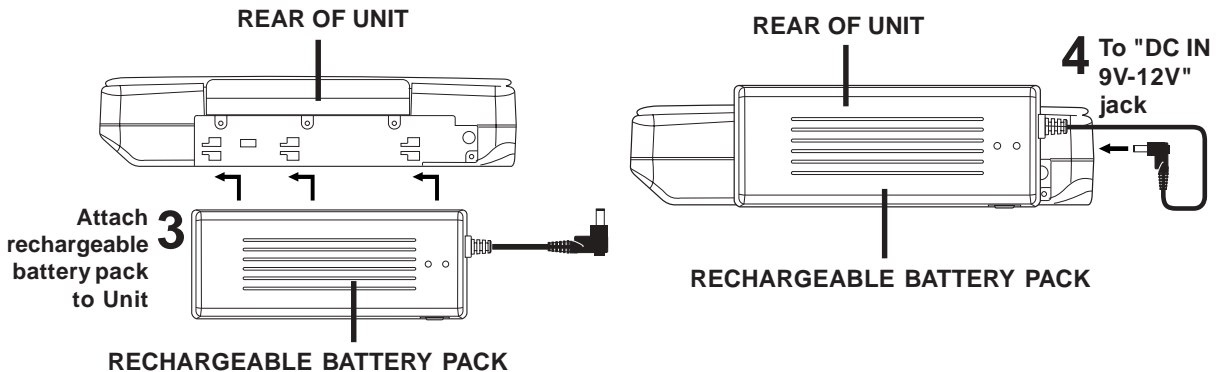

POWER SUPPLY

- Disconnecting the rechargeable battery pack from the unit.

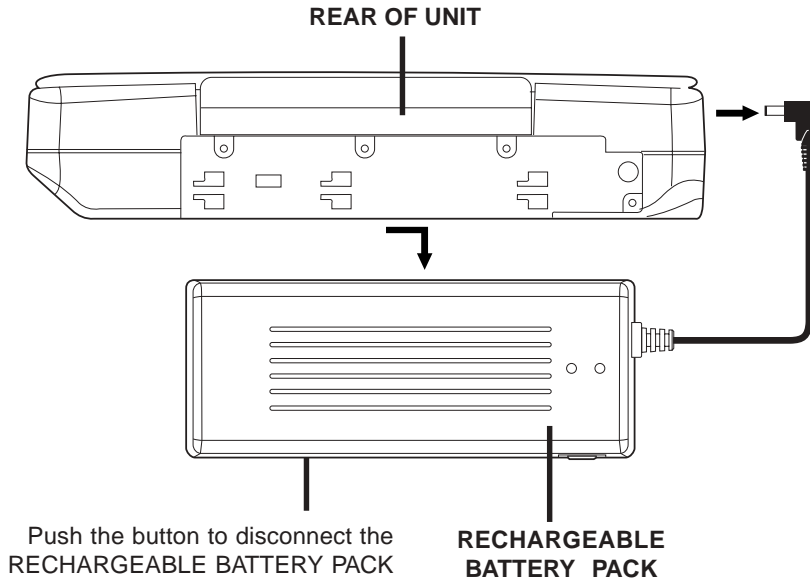

Condition and attention:

- When RECHARGEABLE BATTERY PACK battery is low, player will stop playing.
- Do not short-circuit the terminals.
- Use only the supplied AC ADAPTOR and RECHARGEABLE BATTERY PACK to recharge the rechargeable battery pack.
- Detach the rechargeable battery pack. (Even if the unit is off, it still uses some power. This can lead to over discharging of the battery and malfunction.)
- Recharge the rechargeable battery pack when you are ready to use it again.
- If the rechargeable battery pack is not to be used for a long period of time, discharge it and store it in a place that is cool, dry and dark.
- While using the rechargeable battery pack, the environmental temperature should be 5°C (41°F) to 35°C (95°F).
- To get the longest service life of the rechargeable battery pack, charge it under or close to indoor-temperature.
- Never dispose of in fire, water or heat up.
- Do not open the rechargeable battery pack, refer servicing only to qualified service personnel.

Turning on the unit

1. Slide the **POWER ON/OFF** switch to "ON" position on the front of unit.
2. The DVD logo (start-up picture) will appear on unit screen.



CONNECTIONS

A. Connecting a TV

- If your TV has Audio/Video inputs, you can also connect the unit to your TV using Audio/Video cable.
- You must turn the VOLUME control in MAX position when you connect to TV.
- Put down the TFT cover when the playback mode is chosen.

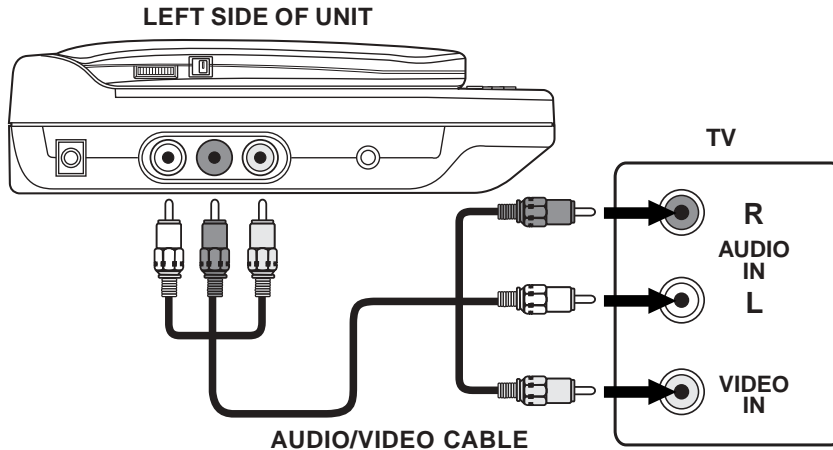

Watching a DVD on your TV

1. Turn on the unit.
2. Turn on the TV and fset it to DVD mode.

B. Another source connection

Digital connection

This unit can play Dolby Digital, but only in two channels.

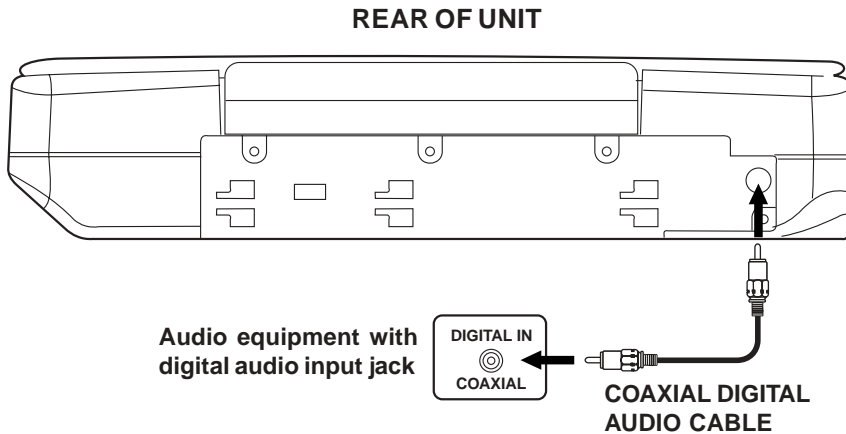

Listening to another audio equipment

1. Turn on the Unit.
2. Turn on your audio equipment and follow the instructions included with it to select the DIGITAL IN function.

Notes:

- If the external equipment is a television and this audio system is close to it, you may experience interference if the tuner function is selected while the television is working.
- Due to copyright protection, DVD movies cannot be copied. If you copy a DVD movie onto a videotape, the resulting copy will be unclear, with poor sound quality. This is NOT caused by a defective DVD system.

CONNECTIONS

Using Headphones/Earphones

- Turn down the volume before connection, and then adjust the level.
- When headphones / earphones are connected, no sound will be output from the unit's speaker.

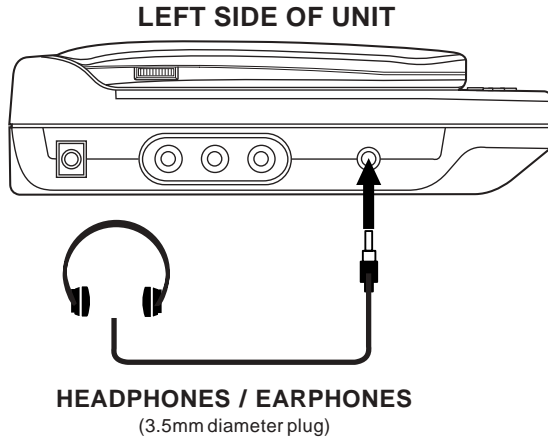

Caution:

- Avoid listening to sound at levels which may be harmful to your ears.

SOUND SYSTEM

Dolby Digital

Dolby Digital is a technology developed by Dolby Laboratories. Soundtracks encoded in Dolby Digital can reproduce from one to 5.1 discrete channels of excellent quality audio.

The unit automatically recognizes the Dolby Digital bitstream and provides a downmix suitable for two-channel listening. An additional Dolby Digital decoder is required for reproduction of the discrete multi-channel soundtracks available on many DVDs.



Manufactured under license from Dolby Laboratories.

'Dolby' and  the double-D symbol are trademarks of Dolby Laboratories.

This owner's manual explains the basic instructions of this unit. Some DVD discs are produced in a manner that allows specific or limited operation during playback. Such as, the unit may not respond to all operating commands. This is not a defect in the unit. Refer to the instruction notes of discs.

“” may appear on the screen during operation. A “” means that the desired operation is not permitted by the unit or disc.

Playing a Disc

1. Slide the **POWER ON/OFF** switch on the left side of the unit into “ON” position.

See **CUSTOMIZING THE FUNCTION SETTINGS** (page 23 to 26) before proceeding to step 2.

2. Slide the **OPEN** switch to open the disc door.

3. Hold the disc by its sides and carefully place it onto the central support in compartment with the label side facing up until you hear a “click”.

4. Close the disc door.

It takes a short while for your unit to load the disc. After loading, some discs will automatically start playback.

5. Press the **▶ PLAY** button.

Pausing playback (still mode)

Press the **II PAUSE** button. To resume normal playback, press the **▶ PLAY** button.

Stopping playback

Press the **■ STOP** button at the location where you want to interrupt playback. To resume playback at the position where the disc was stopped, press the **▶ PLAY** button.

If you press the **■ STOP** button twice, the unit's memory will be cleared and pressing the **▶ PLAY** button will reset the disc to the beginning.



To skip to a different track

- Press the **◀◀ PREV** button repeatedly to skip to the start of the current or previous track.
- Press the **▶▶ NEXT** button to skip to the next track.
- For audio CD disc, use the number buttons (remote control only) to jump straight to that track number.

PLAYING A DISC

Fast Forward/Fast Reverse

1. Press the **SEARCH**  or **SEARCH**  button when a disc is playing.

- The disc begins fast scan at x2 speed.
- Four speeds are available. Each time **SEARCH**  or **SEARCH**  button is pressed, the speed of fast scan changes in the following sequence:

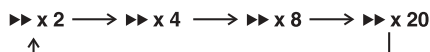

The speed of fast scan



Note:

You also can press and hold **◀◀** / **▶▶** (**PREV** / **NEXT**) buttons on the unit repeatedly to select different fast scan speeds.

2. Press the **▶** **PLAY** button when you reach the desired point to resume playback at normal speed.

SKIP (Forward / Reverse)

While you are playing a disc, press the **▶▶** **NEXT** button to move to the beginning of the next chapter or track. Press the **◀◀** **PREV** button to move to the previous chapter or track and automatically start playing it.

Zooming into an image

While a disc is playing, press the **ZOOM** button.

- While an image is zoomed, you can use **▲**, **▼**, **◀** and **▶** buttons to shift the view and display the part you want.
- To return to the normal view, press the **ZOOM** button until the “**Q.off**” symbol shows. The screen will return to normal.

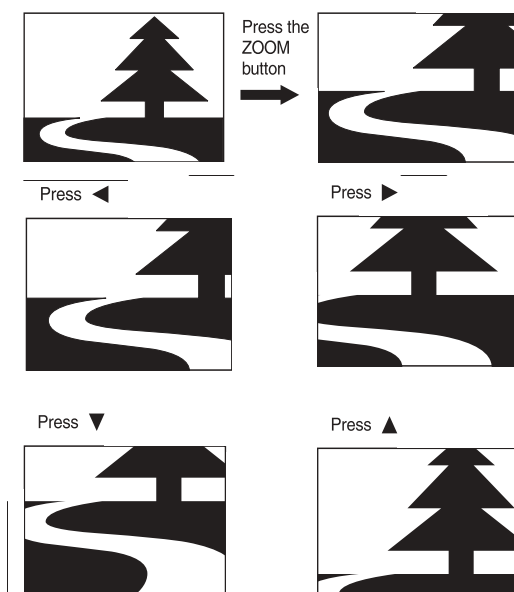

- When you reach the edge of the image, the display will not shift anymore in that direction.

Angle selection

Some DVDs contain scenes which have been shot from a number of different angles. For these discs, the same scene can be viewed from each of these different angles.

1. While you are playing a DVD with different angles recorded, press the **MEM / ANGLE** button to view the number of the current angle.
2. Press the **MEM / ANGLE** button repeatedly to change the scene to the next angle.
 - About two seconds later, playback continues from the new angle you selected.
 - If no button is pressed within 10 seconds, playback continues without changing the current angle.

Sequence of angle shots

(Example)

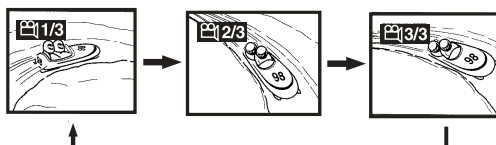
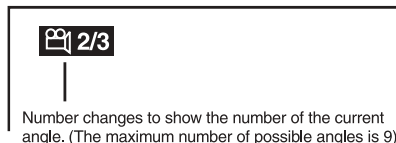

Notes:

- This function can only be used for discs on which scenes shot from multiple angles have been recorded.
- If only one angle is recorded, “ 1/1 ” is displayed.

Audio selection

On some discs, the sound is recorded in two or more formats. Follow the directions below to select the type of playback.

1. While a disc is playing, press the **AUDIO** button to show the current audio format number.
2. Press the **AUDIO** button repeatedly to select the desired audio format.

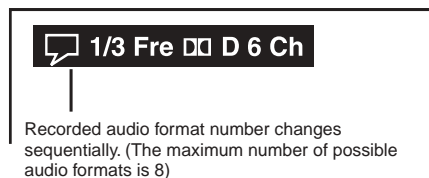

Notes :

- About two seconds later, playback continues in the new audio format.
- If only one audio format is recorded, the number does not change.

Subtitle selection

1. While a DVD is playing, press the **SUBTITLE / RETURN** button to display the current language setting, as shown in the example below.
2. Press the **SUBTITLE / RETURN** button repeatedly to select the desired subtitle language.

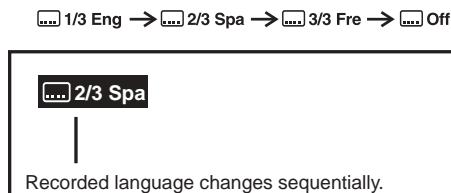

Notes :

- If only one language is recorded, the language does not change.
- About two seconds later, playback continues with the new subtitle you selected.
- The number of languages recorded differs depending on the disc.
- If no button is pressed within a few seconds, playback continues without changing the current subtitle.
- This function can only be used for discs on which subtitles have been recorded in multiple languages.
- On some DVDs, subtitles are activated from the main menu of the DVD. Press the **MENU** button to activate the main menu.

DISPLAY function

Using DISPLAY, you can check and change the current settings of the following items: ANGLE, AUDIO and SUBTITLE.

- While the disc is playing, press the **DISPLAY** button to display the screen shown below.
Elapsed time: Elapsed time from the beginning of the chapter which is currently playing.
Remaining time: Remaining time of the title which is currently playing.



- Press the **DISPLAY** button twice to display the screen shown as below.
- Press the **ANGLE**, **AUDIO** and **SUBTITLE** button to change the selected item.

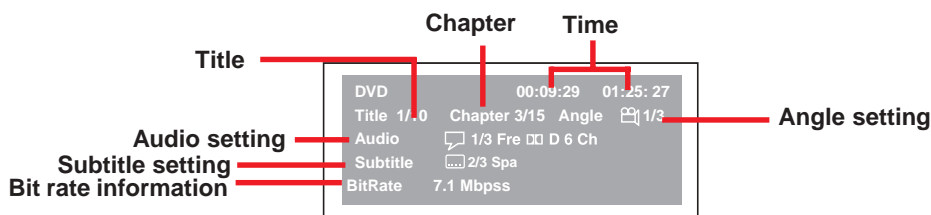

Title skip

- The number of the title currently playing and total titles of disc.
- Press the **GOTO** button to set your desired title, then press the **ENTER** button to confirm.

Chapter skip

- The number of the chapter currently playing and total chapters of the currently played title.
- Press the **GOTO** button to set your desired chapter, then press the **ENTER** button to confirm.

Time skip

- Elapsed time from the beginning of the currently playing chapter and the remaining time from the beginning of the currently playing title.
- Press the **GOTO** button to set your desired point to start playback, then press the **ENTER** button to confirm.

Angle setting

- The current angle is displayed. When a disc with only one angle is played back, "1/1" is displayed.
- Press the **ANGLE** button to select the desired angle.

Audio setting

- The type of audio currently selected is displayed.
- Press the **AUDIO** button to select your desired type of audio.

Subtitle setting

- The subtitle number and language currently selected is displayed. When a disc with only one subtitle is played back, "1/1 Eng" is displayed.
- Press the **SUBTITLE** button to select your desired language.

Bit rate information

- Amount of picture, sound and subtitle data in the DVD video disc transferred per second. The larger the value is, the more data processed, but this does not necessarily insure better picture quality.

GOTO function

This function allows you to skip directly to any part of the disc while a disc is playing.

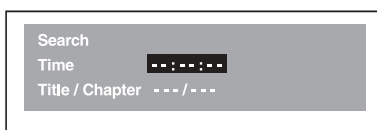

Note :

- After settings, press the **DISPLAY** button again to return to the normal screen.

Locating a specific title

If a DVD disc contains title numbers, you can locate a specific title by directly selecting a title number.

1. In stop mode, press the **GOTO** button.
2. Press **▼**, **◀** or **▶** button to highlight a specific field and press the corresponding number button(s) for the title you want.
3. Press the **ENTER** button to confirm. The Unit will start playback about 3 seconds later.

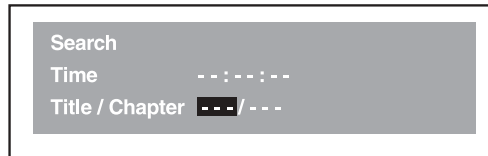

Locating a specific title / chapter / track

If you know the title / chapter / track number you want to play, you can locate a specific title / chapter / track by directly selecting a title / chapter / track number.

1. Press the **GOTO** button to search your desired title / chapter / track.
2. Press **▼**, **◀** or **▶** button to highlight a title / chapter / track and press the corresponding number button(s) for the chapter you want.
3. Press the **ENTER** button to confirm. The Unit will start playback about 3 seconds later.

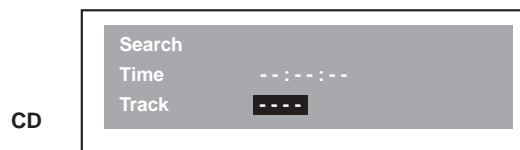
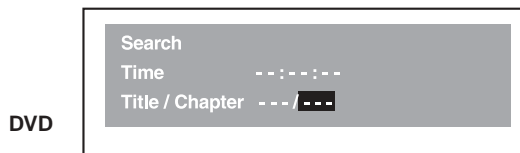

Locating a specific time

You can move to a specific location by entering its corresponding time (hours, minutes, seconds)

1. Press the **GOTO** button.
2. Press **▲** or **▼** button to highlight time.

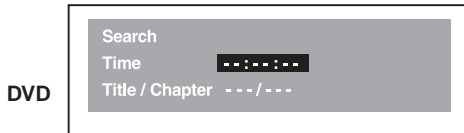

3. Press the corresponding number buttons for the setting point you want.
 - The first two numbers you entered represent hours.
 - The second two numbers you entered represent minutes.
 - The third two numbers you entered represent seconds.
4. Press the **ENTER** button to confirm. The Unit will start playback about 3 seconds later.

Notes :

- Some discs may not respond to this process.
- Some scenes may not be located as precisely as you specified.
- This method for accessing specific locations is available only within the current title of the DVD disc.
- You can move through the menu by pressing the **▲** and **▼** buttons.

Angle setting

1. Press the **DISPLAY** button twice. The **FUNCTION** menu is displayed on the screen and you can see how many angles are recorded on the disc.
2. Press the **ANGLE** button repeatedly to select your desired angle.
3. The Unit change to your desired angle at once.

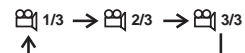
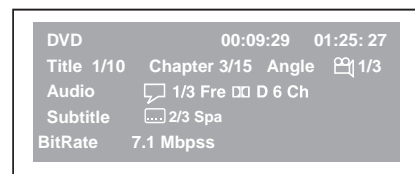

Audio setting

1. Press the **DISPLAY** button twice. The **FUNCTION** menu is displayed on the screen and you can see how many audio formats are recorded on the disc.
2. Press the **AUDIO** button repeatedly to select your desired type of audio.
3. The Unit change to your desired type audio at once.

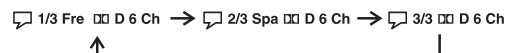
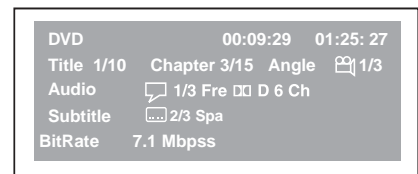

Subtitle setting

1. Press the **DISPLAY** button twice. The **FUNCTION** menu is displayed on the screen and you can see how many subtitle formats are recorded on the disc.
2. Press the **SUBTITLE** button repeatedly to select your desired language.
3. The Unit will change to your desired language about 3 seconds later.

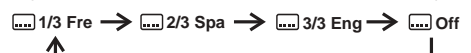
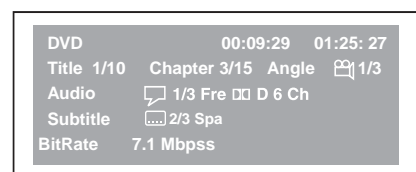

Programmable memory

The two types of programmed playback provided by this Unit are title programmed playback and chapter programmed playback.

Title / Chapter programmed playback

1. Press the **MEM / ANGLE** button while the disc is stopped.
2. Enter the title numbers in **--**. Use **◀** or **▶** button to move the highlight to chapter and enter the chapter numbers in **--**.

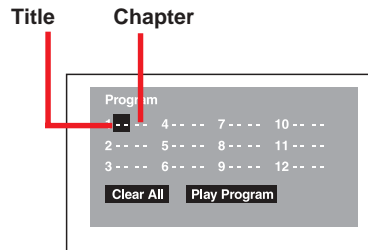

3. Use **◀**, **▶**, **▲** or **▼** button to move to the other field.
4. Repeat steps 2 to 3.
5. Press the **▶ PLAY** button to start the programmed playback.

Note :

- If you press the **■ STOP** button twice, the programmed selections will be cleared.

Programmable memory

Track programmed playback

1. Press the **MEM / ANGLE** button while the disc is stopped.
2. Enter the track numbers in **---**.

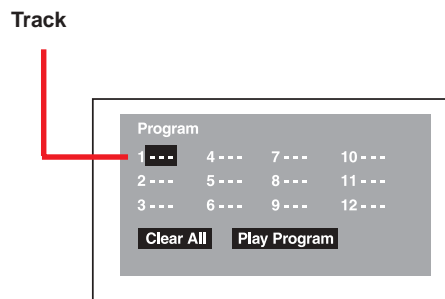

3. Use **◀**, **▶**, **▲** or **▼** button to other field.
4. Repeat steps 2 to 3.
5. Press the **▶ PLAY** button to start the programmed playback.

You can play a specific title or chapter repeatedly.
(Title repeat, chapter repeat)

Repeating a chapter

You can play the same chapter repeatedly.

1. While the disc is playing, press the **SETUP/REP** button until the **Repeat Chapter** indicator displays on the screen. The current chapter is played repeatedly.



Repeating a title

You can play the same title repeatedly.

2. While the disc is playing, press the **SETUP/REP** button until the **Repeat Title** indicator displays on the screen. The current title is played repeatedly.



To resume normal playback

3. While the disc is playing, press the **SETUP/REP** button until the **Off** indicator displays on the screen.



You can play a single track and whole disc repeatedly.

Repeating a single track

You can play the same track repeatedly.

1. While the disc is playing, press the **SETUP/REP** button until the **Repeat Single** indicator displays on the screen. The current track is played repeatedly.



Repeating a whole disc

2. While the disc is playing, press the **SETUP/REP** button until the **Repeat All** indicator displays on the screen. The whole disc is played repeatedly.



To resume normal playback

3. Press the **SETUP/REP** button until the **Off** indicator displays on the screen.



PLAYING MP3 AND PICTURE FILE DISC

This unit can play MP3 and Picture files recorded on CD-R and CD-RW discs.

Playing a MP3 file disc

1. Slide the **OPEN** switch to open the disc door.
2. Hold a MP3 file disc by its sides and carefully place it onto the central support in disc compartment with the label side facing up until you hear a “click”.
3. Push the door to close.
4. The unit will take a short while to load the disc, automatically begin playback and screen display of MP3 files.
5. Press the **▲**, **▼**, **◀** or **▶** CURSOR button to view and select the files, you want to listen to then press **ENTER** button to confirm and this selected file will be playedbacked.

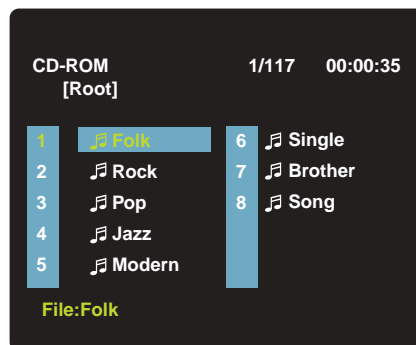

To pause playback

- Press the **⏸ PAUSE** button. To resume playback again, press the **▶ PLAY** button.

To stop playback

- Press the **■ STOP** button.

To skip to the next or previous file

- Press the **▶▶ NEXT** button on the remote control or on the top of unit briefly while playing, to skip ahead to the beginning of the next file. Each time you press the button consecutively, the beginning of the next file is located and played back.
- Press the **◀◀ PREV** (Previous) button on the remote control or on the top of unit briefly while playing, to skip back to the beginning of the previous file. Each time you press the button consecutively, the beginning of the previous files is located and played back.
- You also can press the **GOTO** button, set the track number you want and then press the **ENTER** button.

1. You can not play in Fast reverse or Fast forward during MP3 playback.
2. During MP3 playback, if you press the **■ STOP** button twice and then press **▶ PLAY** button again, it will start to play from the beginning of the file which you stopped. If you press the **■ STOP** button once and then press **▶ PLAY** button again. It will resume playback from the location where you stopped playback.

Notes:

The ability of this unit to read MP3 discs is dependent on the following:

- The Bit Rate must be within 64 - 256 kbps.
- The total number of files on the disc should not exceed 254.
- The maximum number of directories should not exceed 32.
- The maximum depth level of directories should not exceed 4.
- File names should be named using 7 or fewer letters and/or numbers, and must incorporate the “MP3” file extension. EXAMPLE: *****.MP3 where each * is a letter or number.
- Use only letters and / or numbers in file names. If you use special characters, the file and/or folder names may not be displayed correctly on the on-screen display.
- When recording on CD-R discs, use 74-minute (650MB) discs.
- The CD-R or CD-RW discs should be “finalized” in computer by “single session format”.
- See your CD/MP3 creation software for details.

PLAYING MP3 AND PICTURE FILE DISC

Playing a Picture file disc

1. Slide the **OPEN** switch to open the disc door.
2. Hold the Picture file disc by its sides and carefully place it onto the central support in disc compartment with the label side facing up until you hear a “click”.
3. Push the door to close.
4. The unit will take a short while to load the disc then automatically begin playback. The next picture will automatically display after 6 seconds.

Full-Screen Review



Thumbnail Review

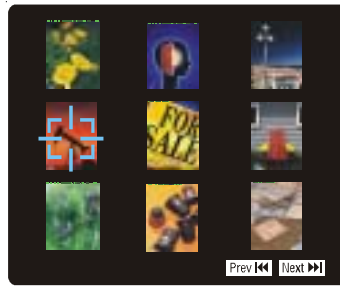

Notes:

- If you press the **MENU** button on the remote in full-screen review, the Unit will display a menu of 9 thumbnail images.
- Use the **cursor** to highlight **▶▶ NEXT** or **◀◀ PREV** in thumbnail screen and then press the **ENTER** button to review other images. If you want to review one image in full-screen, you can use the **CURSOR** **◀, ▶, ▲** or **▼** buttons to highlight the image and then press the **ENTER** button to confirm. The image you selected will show on TV in Full-Screen and automatically display one by one again in about 6 seconds intervals.
- You can press the **PAUSE** button to interrupt playback, and press the **▶ PLAY** button to resume playback.
- You also can use **GOTO** function or use the numbered buttons to enter the number to quickly select any image.
- You can press the **ZOOM** button to enlarge the picture in 3 levels.
- Press the **ANGLE** button on the remote control to rotate the picture orientation by 90°.

Playing a MP3/Picture file disc

1. Slide the **OPEN** switch to open the disc door.
2. Hold a MP3 files/Picture file disc by its sides and carefully place it onto the central support in disc compartment with the label side facing up until you hear a “click”.
3. Push the door to close.
4. The unit will take a short while to load the disc then automatically begin playback. The MP3 files or Picture files will be playback one by one.

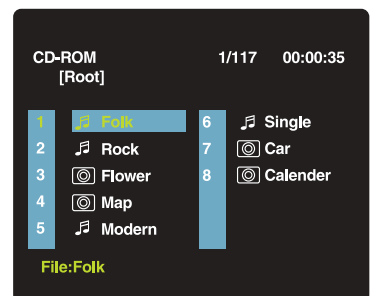

CUSTOMIZING THE FUNCTION SETTINGS

LANGUAGE setting

1. Press the **SETUP** button in stop mode.
2. Use **▲** or **▼** button to select one language, then press the **ENTER** button. The screen will change to your selected language immediately.
3. To exit the **SETUP MENU** and return to the normal screen, press the **RETURN** button.

STEP 1

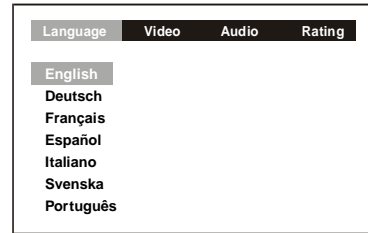

VIDEO setting

TV Shape (Aspect Ratio)

1. Press the **SETUP** button in stop mode.
2. Use **◀** or **▶** button to select **Video**, then press the **ENTER** button.
3. Use **▲** or **▼** button to select **TV Shape**, then press the **ENTER** button.
4. Use **▲** or **▼** button to shift and select the TV type, then press the **ENTER** button.
5. To exit the **FUNCTION SETUP MENU** and return to the normal screen, press the **RETURN** button.

STEP 2

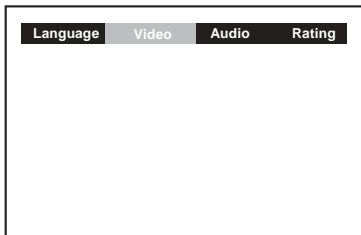

STEP 3

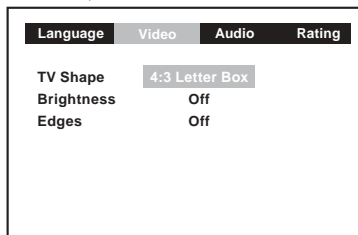

STEP 4

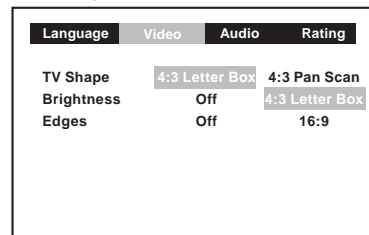

Cut off when a wide-screen video image is played.

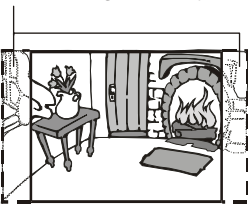

4:3 Pan Scan

- When wide-screen video material is played, this mode clips the right and left sides of the image so that it can be viewed on a conventional screen.
- Some wide-screen DVDs that do not permit Pan Scan mode playback are automatically played in letterbox mode (black bands top and bottom).



4:3 Letter Box

- When wide-screen video material is played in this mode on a conventional screen, black bands appear at the top and bottom of the screen.

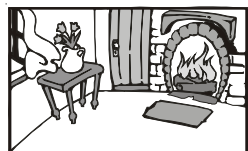

16:9 Wide-screen

- This is the correct mode for playing wide-screen videos on a wide-screen.

Notes :

- The picture size is preset on the DVD disc. Therefore the playback picture of some DVD discs may not conform to the picture size you select.
- When you play DVD discs recorded in the 16:9 picture size only, the playback picture always appears in the 16:9 picture size regardless of the TV shape setting.

CUSTOMIZING THE FUNCTION SETTINGS

Brightness

1. Press the **SETUP** button in stop mode.
2. Use ◀ or ▶ button to select **Video**, then press the **ENTER** button.
3. Use ▲ or ▼ button to select **Brightness**, and then press the **ENTER** button.
4. Use ▲ or ▼ button to shift and select the **Off** or **On**, then press the **ENTER** button.
5. If you want to exit the SETUP MENU and return to the normal screen, press the **RETURN** button.

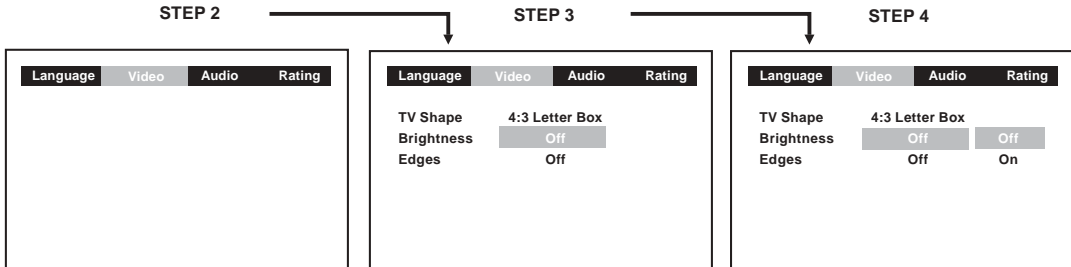

On : Picture will be brighter to clarify details.

Off : Picture will have deepened colors.

Edges

1. Press the **SETUP** button in stop mode.
2. Use ◀ or ▶ button to select **Video**, then press the **ENTER** button.
3. Use ▲ or ▼ button to select **Edges**, and then press the **ENTER** button.
4. Use ▲ or ▼ button to shift and select the **Sharpen** or **Soften** or **Off**, then press the **ENTER** button.
5. If you want to exit the SETUP MENU and return to the normal screen, press the **RETURN** button.

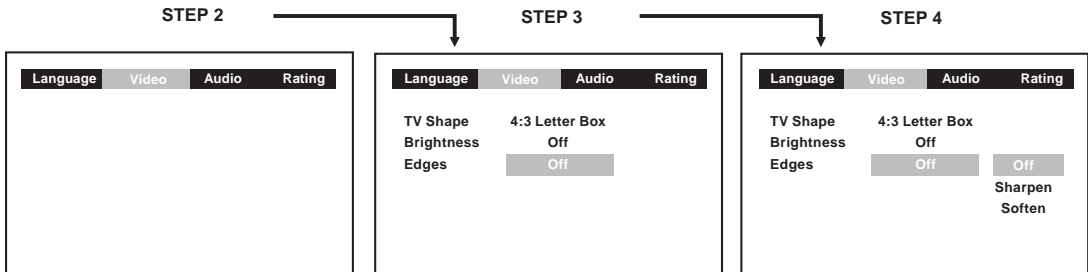

Sharpen : Fine detail will be easier to see.

Soften : Soft-focus effect.

Off : Picture will be returned to normal.

AUDIO setting

Digital Out

1. Press the **SETUP** button in stop mode.
2. Use ◀ or ▶ button to select **Audio**, press the **ENTER** button.
3. Press the **ENTER** button repeatedly to select Digital Out type.
4. To exit the FUNCTION SETUP MENU and return to the normal screen, press the **RETURN** button.

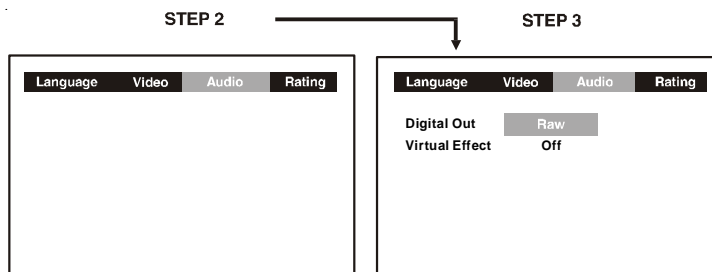

Raw : Use this setting when the unit is connected to an external Dolby Digital decoder.

PCM : Use this setting when the unit is connected to an external surround decoder or stereo.

CUSTOMIZING THE FUNCTION SETTINGS

Virtual Effect (for CD and DVD only)

If you want to obtain expansive virtual surround sound effects from just two speakers.

1. Press the **SETUP** button in stop mode.
2. Press ◀ or ▶ button to select **Audio**, press the **ENTER** button.
3. Press ▲ or ▼ button to select **Virtual Effect**, then press the **ENTER** button.
4. Press ▲ or ▼ button to select **On** or **Off**, then press the **ENTER** button.
5. To exit the SETUP MENU and return to the normal screen, press the **RETURN** button.

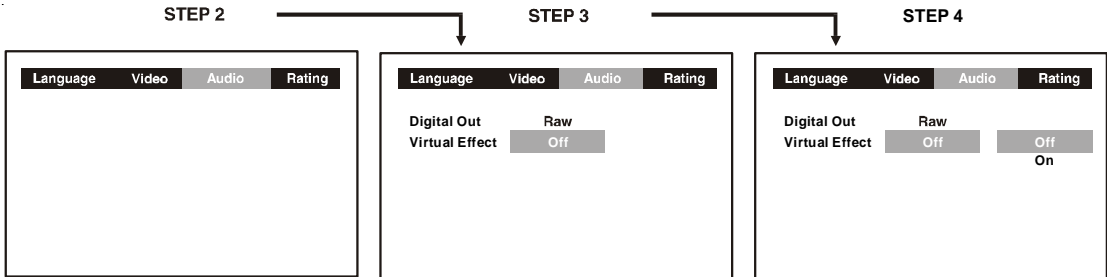

RATING setting

Factory Set

If you want to return the initial language setting to the factory default, do the following:

1. Press the **SETUP** button in stop mode.
2. Use ◀ or ▶ button to select the **Rating**, then press the **ENTER** button.
3. Use ▲ or ▼ button to shift and select the **Factory Set**, then press the **ENTER** button.
4. Use ▲ or ▼ button to shift and select **Yes**, then press the **ENTER** button.
5. To exit the SETUP MENU and return to the normal screen, press the **RETURN** button.

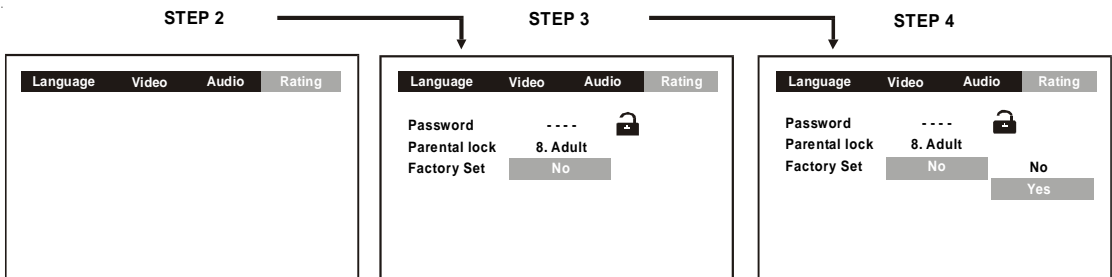

Note:

When you reset the Unit to the factory default, the Unit will take 3-5 seconds to reset.

CUSTOMIZING THE FUNCTION SETTINGS

Password / Parental lock

DVD discs equipped with the password function are rated according to their content. The contents allowed by a parental lock level and the way a DVD disc can be controlled may vary from disc to disc.

For example, if the disc allowed, you could edit out violent scenes unsuitable for children and replace them with more suitable scenes, or you could lock out playback of the disc altogether.

1. Press the **SETUP** button in stop mode.
2. Use ◀ or ▶ button to select **Rating**, press the **ENTER** button.
3. Use ▲ or ▼ button to select **Parental Lock** and then press the **ENTER** button repeatedly to set the parental lock level.
4. Use ▲ or ▼ button to shift and select **Password**, enter your 4-digit security code and then press the **ENTER** button.

You cannot play DVD discs rated higher than the level you selected unless you cancel the parental lock function.

The parental lock level is equivalent to the following ratings.

Level 1 : Kid Safe

Level 2 : G

Level 3 : PG

Level 4 : PG_13

Level 5 : PG_R

Level 6 : R

Level 7 : NC_17

Level 8 : Adult

5. To exit the SETUP MENU and return to the normal screen, press the **RETURN** button.



Indicates Parental lock is NOT active.



The Parental lock is active.

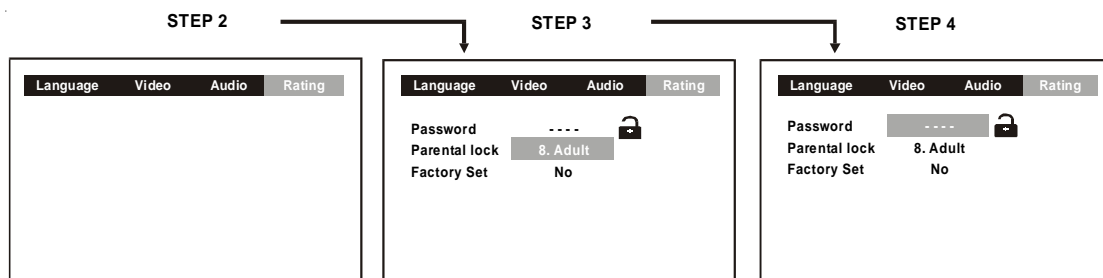

If you forget the password, you can erase your current password by pressing number button 8 on the remote four times, then press the ENTER button to confirm the setting.

PASSWORD : 8 8 8 8

LANGUAGE CODE LIST FOR DISC LANGUAGE

Code	Language Name	Code	Language Name	Code	Language Name	Code	Language Name
AA	Afar	FY	Frisian	MG	Malagasy	SL	Slovenian
AB	Abkhazian	GA	Irish	MI	Maori	SM	Samoa
AF	Afrikaans	GB	Scots Gaelic	MK	Macedonian	SN	Shona
AM	Ameharic	GL	Galician	ML	Malayalam	SO	Somali
AR	Arabic	GN	Guarani	MN	Mongolian	SQ	Albanian
AS	Assamese	GU	Gujarati	MO	Moldavian	SR	Serbian
AY	Aymara	HA	Hausa	MR	Marathi	SS	Siswat
AZ	Azerbaijani	HI	Hindi	MS	Malay	ST	Sesotho
BA	Bashkir	HR	Croatian	MT	Maltese	SU	Sundanese
BE	Byelorussian	HU	Hungarian	MY	Burmese	SV	Swedish
BG	Bulgarian	HY	Armenian	NA	Nauru	SW	Swahili
BH	Bihari	IA	Interlingua	NE	Nepali	TA	Tamil
BI	Bislama	IE	Interlingue	NL	Dutch	TE	Telugu
BN	Bengali	IK	Inupiak	NO	Norwegian	TG	Tajik
	Bangla	IN	Indonesian	OC	Occitan	TH	Thai
BO	Tibetan	IS	Icelandic	OM	(Afan) Oromo	TI	Tigrinya
BR	Breton	IT	Italian	OR	Oriya	TK	Turkmen
CA	Catalan	IW	Hebrew	PA	Panjabi	TL	Tagalog
CO	Corsican	JA	Japanese	PL	Polish	TN	Setswana
CS	Czech	JI	Yiddish	PS	Pashto, Pushto	TO	Tonga
CY	Welsh	JW	Javanese	PT	Portuguese	TR	Turish
DA	Danish	KA	Georgian	QU	Quechua	TS	Tsonga
DE	German	KK	Kazakh	RM	Rhaeto- Romance	TT	Tatar
DZ	Bhutani	KL	Greenlandic			TW	Twi
EL	Greek	KM	Cambodian	RN	Kirundi	UK	Ukrainian
EN	English	KN	Kannada	RO	Romanian	UR	Urdu
EO	Esperanto	KO	Korean	RU	Russian	UZ	Uzbek
ES	Spanish	KS	Kashmiri	RW	Kinyarwanda	VI	Vietnamese
ET	Estonian	KU	Kurdish	SA	Sanskrit	VO	Volapük
EU	Basque	KY	Kirghiz	SD	Sindhi	WO	Wolof
FA	Persian	LA	Latin	SG	Sangho	XH	Xhosa
FI	Finnish	LN	Lingala	SH	Serbo- Croatian	YO	Yoruba
FJ	Fiji	LO	Laothian			ZH	Chinese
FO	Faroese	LT	Lithuanian	SI	Singhalese	ZU	Zulu
FR	French	LV	Latvian, Lettish	SK	Slovak		

MAINTENANCE

Cleaning Disc

A defective or soiled disc inserted into the unit can cause sound to drop out during playback.

Handle the disc by holding its inner and outer edges.

- Do NOT touch the surface of the unlabeled side of the disc.
- Do NOT stick paper or tape on the surface.
- Do NOT expose the disc to direct sunlight or excessive heat.
- Clean the disc before playback. Wipe the disc from the center outward with a cleaning cloth.
- NEVER use solvents such as benzine or alcohol to clean the disc.
- Do NOT use irregular shape discs (example : heart shaped, octagonal, etc.). They may cause malfunctions.

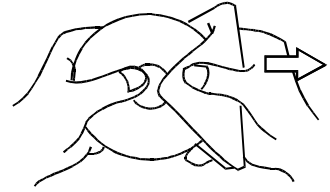

Cleaning the unit

- Be sure to turn the unit off and disconnect the AC power cord before maintaining the unit.
- Wipe the unit with a dry soft cloth.
If the surfaces are extremely dirty, wipe clean with a cloth which has been dipped in a weak soap-and-water solution and wrung out thoroughly, then wipe with a dry cloth.
- Never use alcohol, benzine, thinner, cleaning fluid or other chemicals. Do NOT use compressed air to remove dust.

Important Note

Before transporting the unit, remove disc from the disc compartment.

TROUBLE SHOOTING GUIDE

SYMPTOM

CAUSE (AND REMEDY)

No power.

- Check that the AC adapter is connected.
- You did not turn on the unit.

The remote does not function.

- Remove any obstacles between the remote and the unit.
- Use the remote near the unit.
- Point the remote at the remote sensor on the unit.
- Replace all the battery in the remote with new ones.

DVD

No sound or only a very low-level sound is heard.

- Make sure that you've select DVD mode.
- The system is in pause mode. Press the ► **PLAY** button to return to normal play mode.
- Fast forward or fast reverse is performed. Press the ► **PLAY** button to return to normal play mode.
- Make sure that AUDIO / VIDEO output connections are correct.
- The DTS DVD disc cannot be decoded to have speaker output.
- This unit is too hot, shut off the unit for 30 minutes to cool down.

No picture

- The region number of the disc doesn't match the region number of this unit.



The picture is not clear

- Clean the disc.
- The disc is scratched.

Severe hum or noise is heard.

- The plugs and jacks are dirty. Wipe them with a cloth slightly moistened with alcohol.
- Clean the disc.

The disc does not play.

- There is no disc inside ("No Disc" appears on the screen).
- Insert the disc correctly with the playback side facing down.
- Clean the disc.
- A non-NTSC disc has been inserted. The unit and disc region number are incompatible.
- Condensation may have formed inside the unit due to a sudden change in temperature. Wait about an hour for it to clear and try again.

**Need More
Help?**

DO NOT RETURN THIS TO THE STORE

Please call Customer Service at 1-800-252-6123

or visit online help at <http://www.18002526123.com>