

SONY

3-769-534-22 (1)

ED Beta Video Cassette Recorder

EDV-9500

Operating Instructions

Before operating the unit, please read this manual thoroughly, and retain it for future reference.

Owner's Record

The model number is located at the rear.
The serial number is located inside the front panel.
Record the serial number in the space provided below.
Refer to these numbers whenever you call upon your Sony dealer regarding this product.

Model No. EDV-9500 Serial No. _____



ED Beta

WARNING

To prevent fire or shock hazard, do not expose the unit to rain or moisture.



CAUTION

RISK OF ELECTRIC SHOCK
DO NOT OPEN



CAUTION : TO REDUCE THE RISK OF ELECTRIC SHOCK,
DO NOT REMOVE COVER (OR BACK).
NO USER-SERVICEABLE PARTS INSIDE.
REFER SERVICING TO QUALIFIED SERVICE PERSONNEL.



This symbol is intended to alert the user to the presence of uninsulated "dangerous voltage" within the product's enclosure that may be of sufficient magnitude to constitute a risk of electric shock to persons.



This symbol is intended to alert the user to the presence of important operating and maintenance (servicing) instructions in the literature accompanying the appliance.

Notes on recording and playback formats

- This unit can be used with any video cassette tapes having the mark **ED Beta** or **B**.
- The recording/playback are performed in ED Beta format with **ED Beta** cassettes and in **B** format with **B** cassettes. The ED Beta or **B** format is selected automatically when a cassette is inserted.
- Recording in **B I** or **B Is** mode is not available with this unit.
- The SUPER BETA button does not function for the ED Beta format recording

INFORMATION

This equipment generates and uses radio frequency energy and if not installed and used properly, that is, in strict accordance with the manufacturer's instructions, may cause interference to radio and television reception. It has been type tested and found to comply with the limits for a Class B computing device in accordance with the specifications in Subpart J of Part 15 of FCC Rules, which are designed to provide reasonable protection against such interference in a residential installation. However, there is no guarantee that interference will not occur in a particular installation. If this equipment does cause interference to radio or television reception, which can be determined by turning the equipment off and on, the user is encouraged to try to correct the interference by one or more of the following measures :

Reorient the receiving antenna

Relocate the equipment with respect to the receiver

Move the equipment away from the receiver

Plug the equipment into a different outlet so that equipment and receiver are on different branch circuits.

If necessary, the user should consult the dealer or an experienced radio/television technician for additional suggestions. The user may find the following booklet prepared by the Federal Communications Commission helpful :

"How to Identify and Resolve Radio-TV Interference Problems".

This booklet is available from the U.S. Government Printing Office, Washington, DC 20402, Stock No. 004-000-00345-4.

The recording/playback modes available with **ED Beta** and **B** cassettes

	Recording modes	Playback modes
ED Beta cassettes	B II, B III	B II, B III
B cassettes	B II, B III	B I, B Is, B II, B III

Table of Contents

Precautions	4
Features	5
Location and function of parts and controls	6
Front.....	6
Display window	8
Tuning compartment	8
Inside the front panel	9
Inside the drawer	10
Rear	11
Wireless Commander RMT-164.....	12

Connections

Antenna/cable and TV connection.....	13
Connecting a color monitor	17
Connecting TV equipped with video/audio input jacks ..	18
Connection to an audio system	19
Power connection	20
AC outlet.....	20

Preparations

Adjusting the TV.....	21
Presetting the active channels in your area	22
Before presetting.....	22
Adding channels.....	22
Erasing channels.....	23
Cable TV channel chart	23
Date and clock setting.....	24
Data screen display	25
To select the items to be displayed.....	25
Handling the video cassettes	26
Cassette insertion.....	26
Cassette ejection.....	26
Recording time available in each mode	26
To avoid erasing a recording	26
Remote control operation	27
Battery insertion.....	27
Operation	27
For owners of other Sony video equipment or TV.....	28

Basic operations

Recording TV programs.....	29
Before recording.....	29
Operation	30
Note on SUPER BETA button	31
To start recording from a particular point.....	31
To stand by correctly at the desired point	31
To record multichannel TV sound (MTS) broadcasts (stereocasts).....	32
To view one TV program while recording another	32
Playback	33
Operation	33
To select the monitor sound	33
To view a TV program during playback.....	34
When you play back a tape recorded on another VCR.....	34
Auto play	34
Various playback modes	35
Digital Betascan	35
Digital SkipScan	35
Digital freeze picture.....	35
Stop-action advance picture	35
Variable speed playback.....	35
Locked picture search	35
Digital scan	35
Various speed playback using the JOG dial and SHUTTLE ring	36
Viewing digital pictures	37
Stop motion	37
Flash motion	37
Use of the tape counter	38
To index the tape contents	38
To determine the remaining recording or playback time	38
Tape return/tape return play	39
Time search	40
Timer-activated recording	41
Timer setting.....	43
Before the timer-activated recording starts.....	45
During recording.....	45
Specific notes on timer-activated recordings	45
Quick timer recording.....	46
To use quick timer from the tape stop mode.....	46
To use quick timer while recording	46
Index function	47
To mark index signals automatically.....	47
To mark index signals manually.....	47
Index scan	47
Index search	48
To erase index signals	49

Advanced operations

Beta hi-fi audio recording	50
Recording from your audio system.....	50
FM simulcast recording.....	51
Timer-activated FM recording.....	51
PCM recording and playback	52

Editing

Tape editing	53
To edit a home movie tape from another VCR to this VCR.....	53
To edit a home movie tape from this VCR to another VCR.....	54
Various tape editing modes.....	55
Editing with another EDV-9500 or SL-HF1000.....	56
What is a pre-roll?.....	56
Connecting two EDV-9500 VCRs	57
Connecting using one monitor TV for two VCRs	58
Automatic assemble editing.....	59
Operation	60
For accurate presetting of editing points	61
After presetting the editing points	62
Automatic insert editing.....	63
Audio/video insert modes	63
Operation	64
Simple editing.....	66
Simple assemble editing.....	66
Simple insert editing.....	66
Continuous editing (butt edit).....	66
Editing with a Sony VCR equipped with a control terminal.....	67
Connecting a VCR equipped with a control S IN jack.....	67
Connecting a VCR equipped with a CAMERA REMOTE jack.....	67
Manual insert editing	68
Connection.....	68
Operation	68
Tape editing techniques	70
Minimizing loss of picture and sound quality	70
Camera recording	71
Connections	71
Operation	71
Frame-by-frame shooting.....	71

Others

Using the Sony control system.....	72
Operating by remote control through a TV set or component TV tuner	72
Editing the recording on 8 mm format tapes onto IB tapes with the video editing controller.....	72
ED Beta format.....	73
Super high quality picture.....	73
Use of metal tape	74
S VIDEO input/output connectors	74
Compatibility with conventional VCRs.....	74
Cassette detection hole	74
Rack mounting	75
Specifications.....	76
Trouble checks	77

On safety

- Operate the unit only on 120 V AC, 60 Hz.
- Should any solid object or liquid fall into the cabinet, unplug the unit and have it checked by qualified personnel before operating it any further.
- One blade of the plug is wider than the other for the purpose of safety and will fit into the power outlet only one way. If you are unable to insert the plug fully into the outlet, contact your dealer.
- Unplug the unit from the wall outlet if it is not to be used for an extended period of time. To disconnect the cord, pull it out by the plug. Never pull the cord itself.

On installation

- Allow adequate air circulation to prevent internal heat build-up.
- Do not place the unit on surfaces (rugs, blankets, etc.) or near materials (curtains, draperies) that may block the ventilation slots.
- Do not install the unit near heat sources such as radiators or air ducts or in a place subject to direct sunlight, excessive dust, mechanical vibration or shock.
- The unit is designed for operation in a horizontal position. Do not install it in an inclined position.
- Keep the unit and cassette tapes away from equipment with strong magnets, as for example a microwave oven or a large loudspeaker.
- Do not place any heavy object on the unit.

On operation

- When the unit is not in use, turn the power off to conserve energy and to extend its useful life.
- Remove and store video cassettes after recording or playback.
- Store the cassettes in their cases and keep them in an upright position to prevent intrusion of dust and uneven winding.

On cleaning

Clean the cabinet, panel and controls with a dry soft cloth, or a soft cloth lightly moistened with a mild detergent solution.

Do not use any type of solvent, such as alcohol or benzene, which might damage the finish.

On repacking

Do not throw away the carton and packing materials. They make an ideal container in which to transport the unit. When shipping the unit to another location, repack it as illustrated on the carton.

If you have any questions about this unit, contact your Sony service facility.

Features

ED (Extended Definition) Beta Format

Super high quality picture obtained with ED Beta format

- 9.3 MHz Hi-Band recording assures high resolution of more than 500 lines (horizontal resolution).
- Metal **ED Beta** tape allows high definition recording.
- TTS (Tilted Sendust-Sputtered) heads make the most of the high quality potential in metal tape.
- With the S VIDEO connector, the luminance and chrominance signals are input and output separately to ensure high picture quality.

High quality sound obtained with Beta Hi-fi recording

- Dynamic range more than 90 dB
- Tape stabilizer assures stable tape transport and greatly reduces modulation noise.

For further details, see "ED Beta Format" on page 73.

Professional-Quality Editing

Twin flying erase heads

Color streaks and blurs which were conventionally caused by continuous recordings or insert editings are eliminated with the twin flying erase heads.

Tape counter with frame digits

The tape counter displayed on the monitor screen indicates the position of the tape in unit of frames. This allows an accurate search of editing points.

Automatic assemble editing of up to 8 scenes

Framing servo

The framing servo allows highly accurate connection between two continuous editings.

Versatile Functions

Data screen

The information of timer programs, editing points, etc. are displayed on the monitor screen for easy presetting and checking.

Remaining tape counter

The remaining tape counter indicates the length of recording or playback time possible from the actual point on the tape to its end.

Time search function

Using the time search function the tape can be advanced or rewound to the desired point automatically by assigning the time.

Multi-function Wireless Commander



The Wireless Commander controls almost all functions of the VCR including editing, and can also be used with other Sony remote control VCRs and TVs.

Location and Function of Parts and Controls

For details on the use of each control, refer to the pages indicated in the black circles (●).

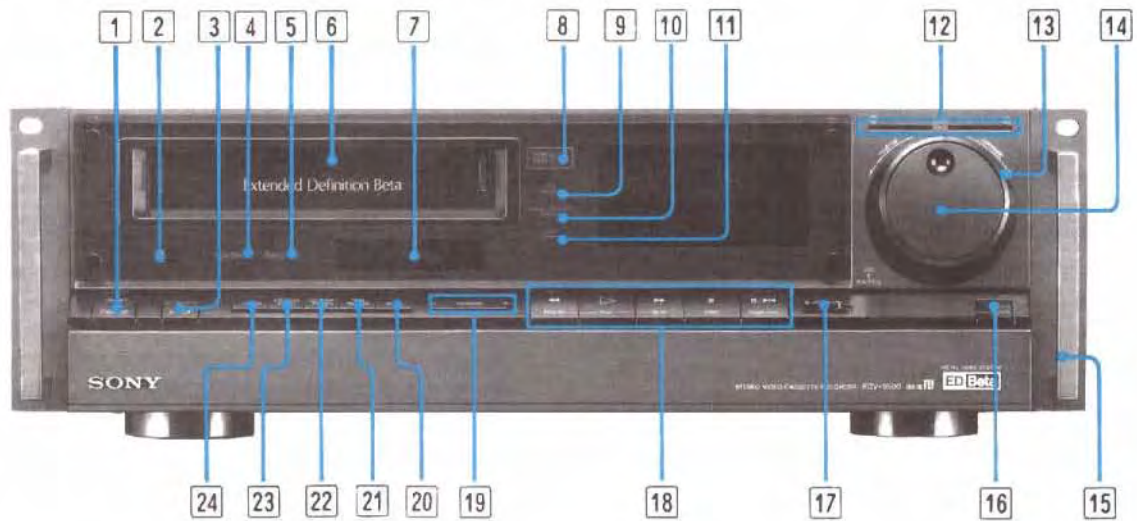
Front



- 1 POWER switch and indicator**
- 2 Remote sensor**
- 3 ▲ EJECT button**
Press to eject the cassette.
This button does not function during recording.
- 4 SuperBeta indicator**
Lights when the SUPER BETA switch is set to ON.
- 5 Beta hi-fi indicator**
Lights to indicate Beta hi-fi recording and playback.
- 6 Cassette compartment**
- 7 Peak program meter**
Shows the peak input level of the right and left channels during Beta hi-fi recording.
- 8  Beta indicator**
Lights to indicate that the ED Beta recording and playback format is selected. The indicator goes off when a  format cassette is inserted.
- 9 VTR indicator**
Lights to indicate the VTR mode.
- 10 DIGITAL PICTURE indicator**
Lights when the digital picture function is in use.
- 11 EDIT indicator**
Lights when the EDIT switch is set to ON.
- 12 Playback indicators**
Indicate the direction of playback (including various playback modes and playback pause mode).
- 13 SHUTTLE ring**
Select the playback speed in various playback modes or during editing.
- 14 JOG dial**
Used to select the channels, set the date and clock and set the timer programs. This dial is also used to select the playback speed in various playback modes or during editing.
- 15 Handle**
- 16 PUSH OPEN button**
Press this button to open the drawer. For the controls inside the drawer, see page 10.
- 17 ● REC switch**
Slide to the right to start recording.
- 18 Tape transport buttons and indicators**
◀ REW (rewind), ▶ PLAY, ▶▶ FF (fast-forward), ■ STOP, || / ▶ PAUSE/STILL
- 19 CHANNEL + / - buttons**
Press to select the channels, to set the date, clock or timer program. And press + to advance and - to reverse.
- 20 INDEX button**
Used for the index scan or index search operation.
- 21 TAPE RETURN button**
In the stop mode, press this button to advance or rewind the tape to the counter zero point.
- 22 COUNTER/REMAIN button**
Press to change the tape counter display to the approximate recording or playback time remaining on the tape.
- 23 COUNTER RESET button**
Press to reset the tape counter to "0H00M00S" and "0:00:00:00" on the TV screen.
- 24 TV/VTR button**
Press to watch the program selected on the recorder so that the VTR indicator lights up (VTR mode). To watch a different TV program while recording another, press this button again so that the indicator goes off.

Display Window

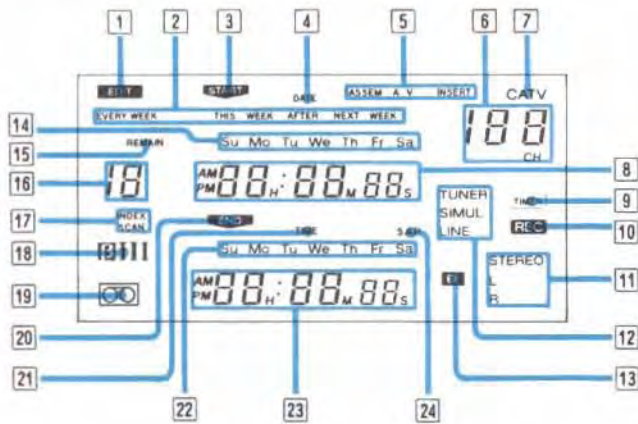

- 1 Automatic editing mode indicator
- 2 Week indicator
- 3 This indicator appears when the starting time of a timer recording or the starting point of the automatic editing is displayed.
- 4 This indicator appears when the date is displayed.
- 5 Editing mode indicators: ASSEM (assembly editing), A (audio insert), V (video insert)
- 6 Channel number or the L1 (line 1)/L2 (line 2) input indicator
- 7 CATV (cable TV) indicator
- 8 Date, starting time of a timer recording, starting point of the automatic editing, tape counter or remaining time counter

- 9 This indicator appears during timer setting or checking. "TIMER REC" will appear when a timer recording is activated.
- 10 This indicator appears during recording.
- 11 Channel of the stereo program
- 12 Input mode indicators
- 13 EE mode* indicator
- 14 Day-of-the-week indicator
- 15 This indicator appears when the remaining time counter is displayed.
- 16 Timer program number for timer-activated recording, index number for index searching or scanning, or scene number for automatic assemble editing
- 17 Index scan or index search indicator
- 18 Tape speed indicator
- 19 This indicator indicates that a cassette is inserted.
- 20 This indicator appears when the ending time of a timer recording or the ending point of the automatic editing is displayed.
- 21 This indicator appears when the current time is displayed.
- 22 Day-of-the-week indicator
- 23 Current time, ending time of a timer recording, or ending point of the automatic editing
- 24 SAP (Second Audio Program) indicator

* EE (Electric-to-Electric) mode: The input signals (which are not the signals recorded on the tape) are displayed on the monitor screen.

Tuning Compartment

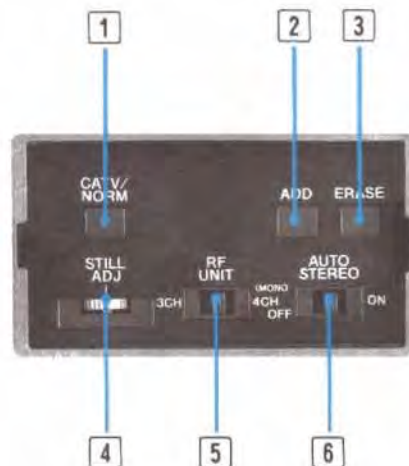
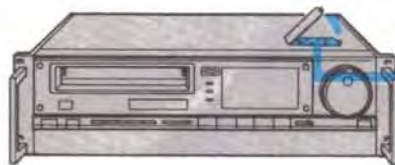

- 1 CATV/NORM (normal) selector
- 2 ADD button
- 3 ERASE button
- 4 STILL ADJ (freeze picture adjustment) control
- 5 RF UNIT selector
- 6 AUTO STEREO switch
Normally set to ON. When the signal is weak on a particular channel, set to OFF.

Inside the Front Panel

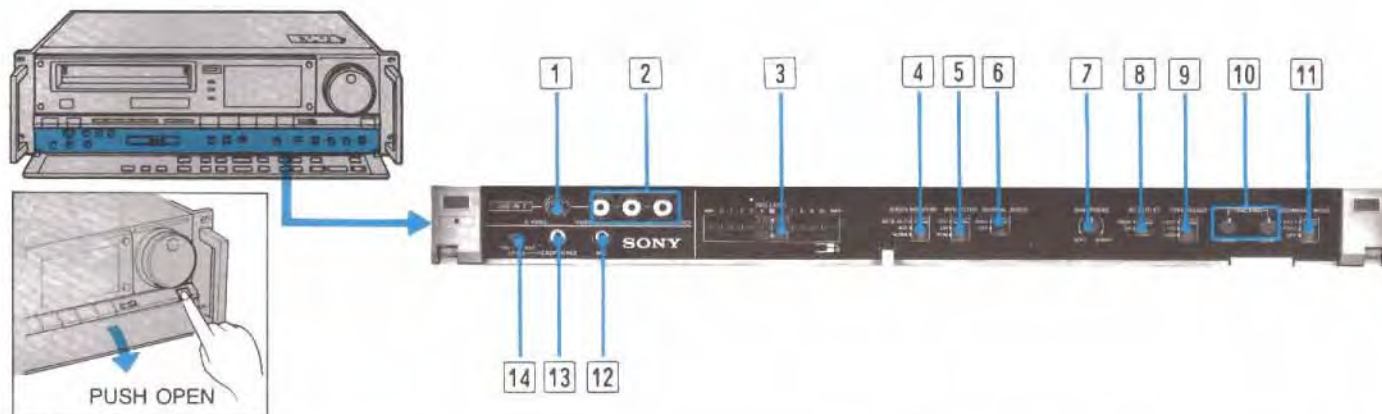

1 LINE IN 2 S VIDEO connector (4-pin mini-DIN)

When editing, connect to the S VIDEO output connector of another VCR.

2 LINE IN 2 VIDEO/AUDIO jacks (phono type)

Connect to the video/audio output jacks of another VCR or video camera.

The signal cannot be input from this VIDEO jack when external equipment is connected to the LINE IN 2 S VIDEO connector.

3 REC LEVEL controls

Adjust the audio recording level. Normally keep these controls at the center detent position **5**.

4 AUDIO MONITOR BETA HI-FI/MIX/NORM selector

Select the sound to be monitored.

BETA HI-FI: Normally set to this position for Beta hi-fi sound

MIX: To monitor the sound recorded on both the video track in Beta hi-fi and the conventional audio track

NORM: To monitor the sound recorded on the conventional audio track only.

5 MPX FILTER/PCM selector

When making a recording other than regular TV recordings, set the selector as follows:

OFF: For recording the sound from a record player or a compact disc player

ON: For recording FM radio broadcast programs (If your FM tuner is provided with an MPX filter, set this selector to OFF.)

PCM: For PCM recording and playback

Note

Regardless of the setting of this selector, TV programs are automatically recorded in MPX FILTER ON mode.

6 NORMAL AUDIO selector

Select the sound to be recorded on the conventional audio track. Normally set to MAIN. To record SAP (Second Audio Program), set to SAP.

7 SHARPNESS control

Use to adjust the sharpness of the picture if necessary. Normally set the control at the center detent position.

8 AC OUTLET selector

SW (switched): The AC OUTLET on the rear is controlled by the front panel POWER switch.

UNSW (unswitched): The AC OUTLET is not controlled by the POWER switch and always supplies AC power.

9 TAPE SELECT switch

When using the remaining tape counter, set this switch according to the length of the tape being used.

10 TRACKING controls

Normally keep these controls at the center detent position. Turning either of these controls may help clear possible streaks on the screen especially for tapes recorded on other VCRs.

NORM (normal): For normal and double speed playback.

SLOW: For slow speed playback by turning the JOG dial or SHUTTLE ring, x1/5 and x1/10 speed playback, and freeze picture.

11 COMMAND MODE selector

To remotely control this VCR with the supplied Wireless Commander, set this selector to the same position as that on the Commander.

12 MIC jack (mini type)

Connect a microphone to record the sound from this microphone on the conventional audio track.

13 HEADPHONES jack (stereo mini type)

14 LEVEL (headphone level) control

Inside the Drawer

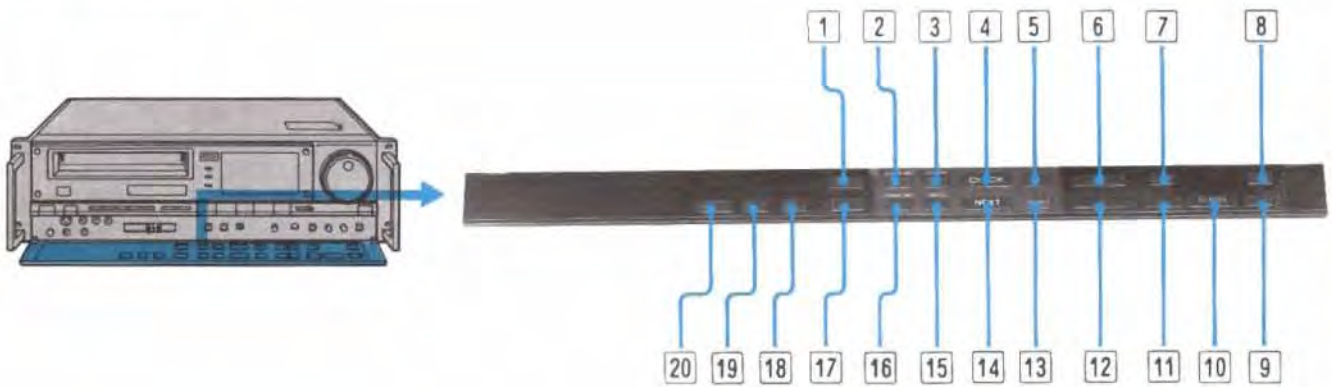

- 1 REC MODE button**
 Press to select the recording tape speed, **II** or **III**. The playback speed will be set automatically regardless of the setting of this button.
- 2 CLOCK SET button**
 Press to start the setting of the date and clock.
- 3 CLEAR button**
 Press to clear the timer setting.
- 4 CHECK button**
 Press to check the contents of the preset timer programs and the starting and ending points of the automatic assemble editing.
- 5 QUICK TIMER button**
 Press to start a quick timer recording and then set the duration of the recording.
- 6 INDEX MARK and ERASE buttons**
 Press MARK to mark an index signal at the desired point on a tape during recording or playback. To erase a pre-recorded index signal, locate the index signal and press the ERASE button.
- 7 DATA SCREEN button**
 The channel number, tape operation mode, tape counter, index function, display for setting and checking timer recording programs and display for automatic editing are displayed on the TV or monitor screen together with a picture. To turn off the display, press this button. To resume the display, press it again.
- 8 EE button**
 During tape playback (except digital pictures) keep this button pressed to momentarily view and listen to the TV program received by the built-in tuner or the program input from the LINE IN 1 or LINE IN 2 jacks. When the button is released, the playback picture will return on the TV screen.
- 9 EDIT START button**
 Press to start the automatic assemble editing or automatic audio/video insert operation.
- 10 EDIT MARK button**
 Use to mark the starting and ending points for the automatic assemble editing and automatic audio/video insert operation. Locate the desired editing point and press this button.
- 11 EDIT ASSEMBLE button**
 Press to set the unit to automatic assemble editing mode.
- 12 INSERT AUDIO and VIDEO buttons**
 Use to "insert" a new recording onto a portion of a recorded tape.
AUDIO: To insert sound on the conventional audio track
VIDEO: To insert picture and/or Beta hi-fi sound on the video track
- 13 TIMER REC button**
 Press to activate the timer recording.
- 14 NEXT button**
 Press to advance to the next item to be set during date, clock or timer setting or automatic assemble editing.
- 15 BACK button**
 Press to go back to the item previously set during date, clock or timer setting, or automatic assemble editing.
- 16 TIMER SET button**
 Press to start the setting or resetting of timer programs.
- 17 INPUT SELECT button**
 Press to select the program to be recorded so that the desired input mode indicator appears in the display window.
TUNER: For recording TV programs
SIMUL: For recording the sound from LINE IN 1 AUDIO and the picture of a TV program (FM simulcast recording)
LINE L1 (line 1): For recording signals from LINE IN 1
LINE L2 (line 2): For recording signals from LINE IN 2 inside the front panel

18 AUDIO MONITOR L/R button

Select the channel(s) of the Beta hi-fi sound to be monitored so that the desired indicator appears in the display window.

STEREO: To monitor in stereo mode

L: To monitor the L (left) channel of a stereo program

R: To monitor the R (right) channel of a stereo program

19 EDIT button

Normally keep this button at OFF (i.e. the EDIT indicator is off). When editing a tape onto another recorder, press the button so that the EDIT indicator lights.

20 SUPER BETA button

Normally keep this button at ON (i.e. the SuperBeta indicator lights).

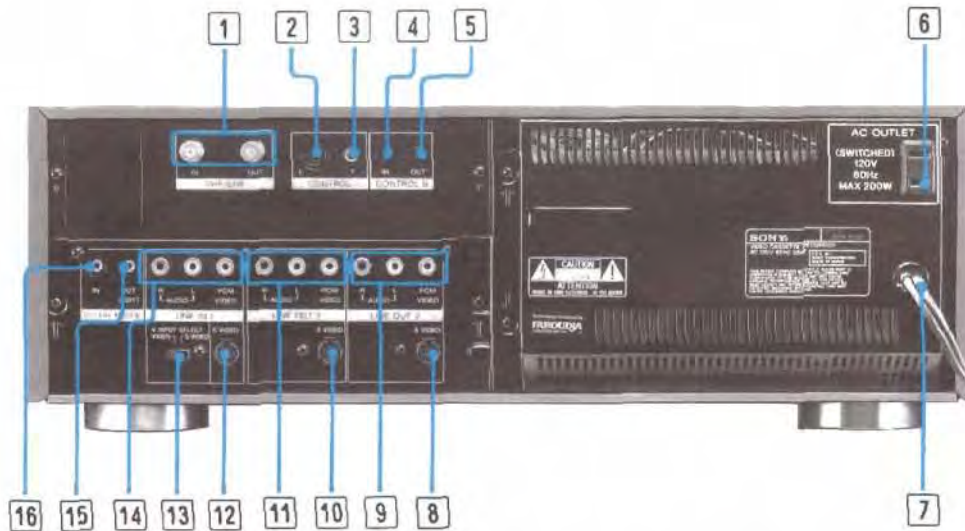
Rear**1 VHF/UHF IN and OUT connectors (F type)****2 CONTROL L connector (5-pin DIN)**

Connect to the CONTROL L connector of an optional video editing controller or other Sony products for various systematic operations.

3 CONTROL T jack (stereo mini type)

Connect to the CONTROL T jack of another EDV-9500 or SL-HF1000 for automatic editing.

4 CONTROL S IN jack (mini type)

Connect to the CONTROL S output jack of a program timer or other Sony products for various systematic operations.

5 CONTROL S OUT jack (mini type)

Connect to the CONTROL S input jack of other Sony products for automatic assemble editing and other systematic operations.

6 AC OUTLET

Supplies AC power to video or audio equipment.

7 AC power cord**8 LINE OUT 2 S VIDEO connector (4-pin mini-DIN)**

Connect to the S VIDEO IN connector of a TV or color monitor.

9 LINE OUT 2 AUDIO and VIDEO/PCM jacks (phono type)**10 LINE OUT 1 S VIDEO connector (4-pin mini-DIN)**

Connect to the S VIDEO IN connector of a TV or color monitor.

11 LINE OUT 1 AUDIO and VIDEO/PCM jacks (phono type)**12 LINE IN 1 S VIDEO connector (4-pin mini-DIN)**

When editing, connect to the S VIDEO OUT connector of another VCR, etc.

13 V INPUT SELECT (video input select) switch

When external equipment is connected to the LINE IN 1 S VIDEO connector, set to S VIDEO. The signal cannot be input from the LINE IN 1 VIDEO/PCM jack. Be sure to reset to VIDEO when the S VIDEO connector is not to be used.

14 LINE IN 1 AUDIO and VIDEO/PCM jacks (phono type)**15 CAMERA REMOTE OUT (EDIT) jack (special mini type)**

Connect to the CAMERA PAUSE or CAMERA PAUSE IN jack of another Sony VCR for editing.

16 CAMERA REMOTE IN jack (special mini type)

When recording with a video camera, connect the Sony HVA-220 AC adaptor to this jack.

Wireless Commander RMT-164

The buttons without explanation have the same function as the buttons on the VCR with the similar name or mark.

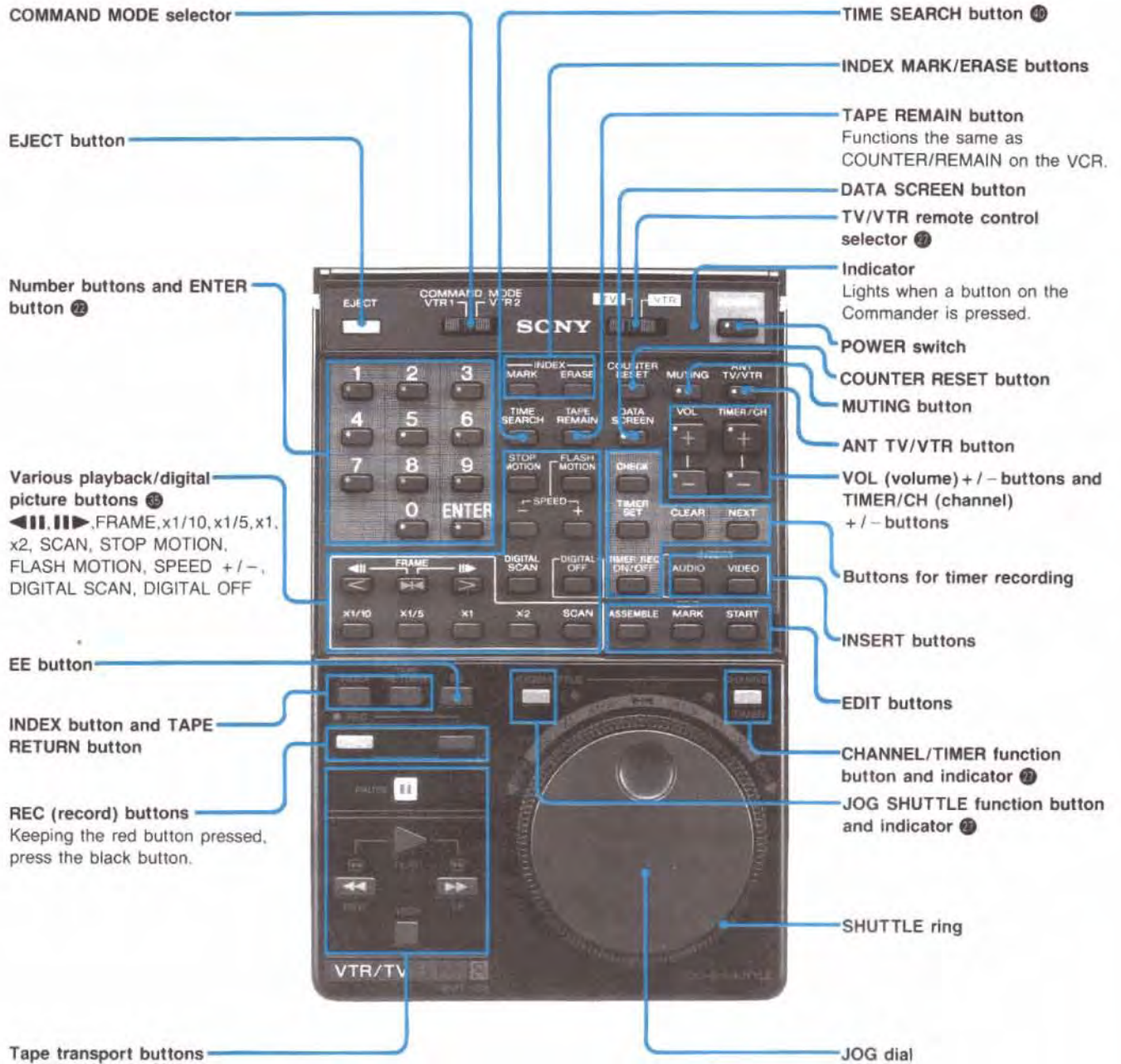

The buttons with an orange dot can be used to operate certain Sony remote control TVs. See page 28.

Antenna/Cable and TV Connection

Before making connections

- Turn off all equipments.
- Do not connect the AC power cord to a wall outlet until all the connections of the video cassette recorder and the TV have been completed.
- Make connections firmly. Loose connections may cause a distorted picture.

Disconnect the TV antenna cable from the TV receiver and connect them to the recorder. Then connect the recorder and the TV.

Combination VHF/UHF antenna

Most combination antennas are equipped with a U/V band separator (signal splitter). Take off the separator and connect the cable directly to the recorder.

Use the removed separator to connect the recorder and the TV.

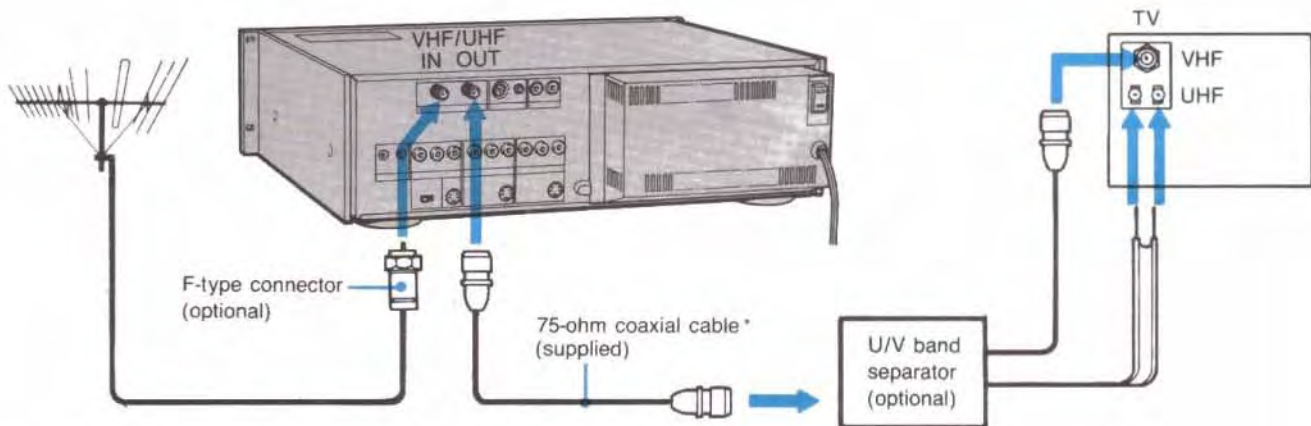

If you need a separator or a complete antenna system, consult your Sony dealer or a qualified technician.

* Use an optional RFC-8 extension cable, 8 m (25 ft) long, if the supplied 75-ohm coaxial cable is not long enough.

VHF antenna

When the cable is a 300-ohm ribbon type lead-in (flat)



When the cable is a 75-ohm coaxial type (round)

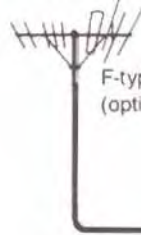

F-type connector (optional)

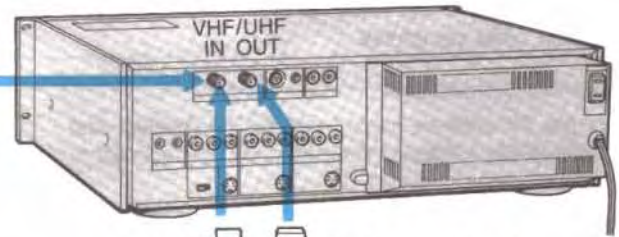

Antenna connector (supplied)
75-ohm coaxial cable (supplied)

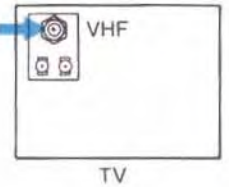

TV

UHF antenna

1 Attach an optional EAC-66 U/V band separator to the VHF/UHF OUT connector of the recorder.

2 Connect the separator to the VHF and UHF antenna terminals of the TV.

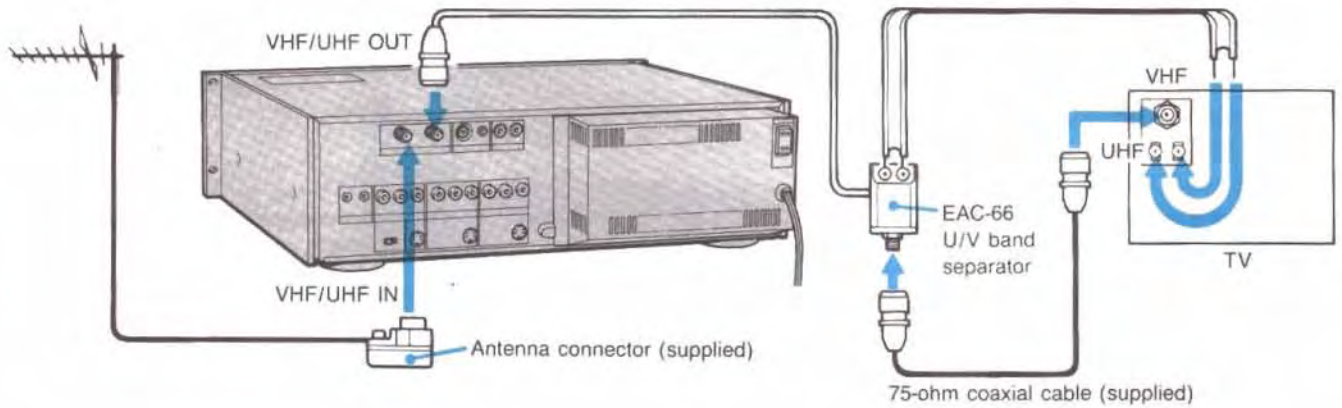

When both VHF and UHF antennas are connected

- 1 Attach an optional EAC-66 U/V band separator (mixer) to the VHF/UHF IN connector of the recorder.
- 2 Connect the antennas to the U/V band separator.
- 3 Attach another optional U/V band separator to the VHF/UHF OUT connector of the recorder.
- 4 Connect it to the VHF and UHF antenna terminals of the TV.

When a TV has a 75-ohm UHF/VHF antenna terminal
Easy connection of the recorder to the TV can be made with the supplied 75-ohm coaxial cable regardless of the types of antenna.

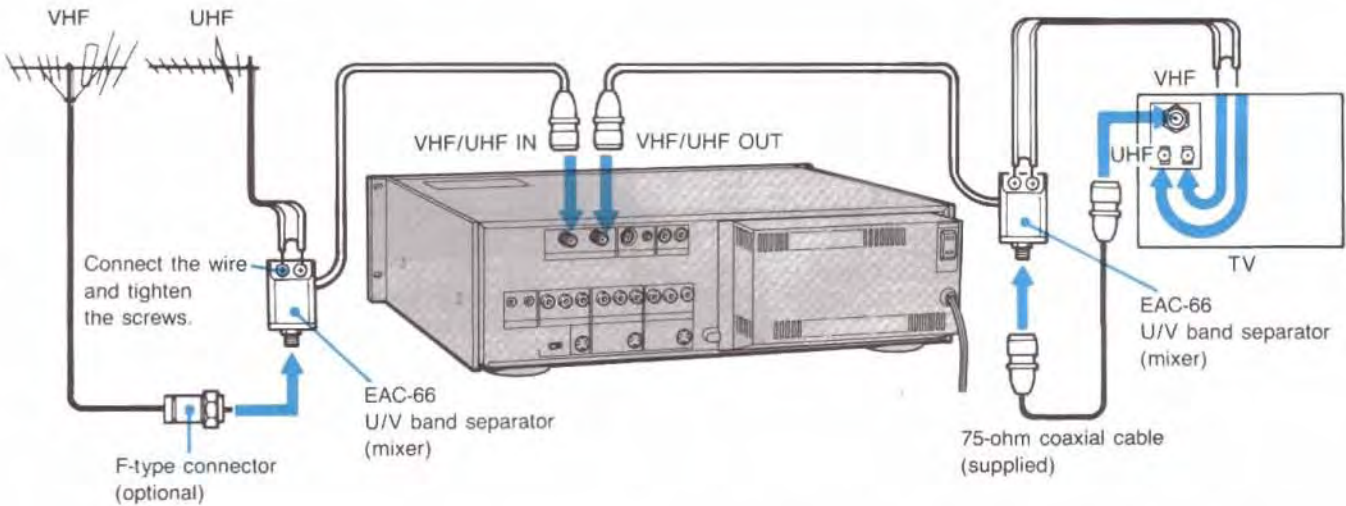

Caution

Connections between the recorder VHF/UHF OUT connector and the antenna terminals of a TV receiver should be made only as shown in these instructions. Failure to do so may result in operation that violates the regulations of the Federal Communications Commission regarding the use and operation of rf devices. Never connect the output of the recorder to an antenna or make simultaneous (parallel) antenna and recorder connections at the antenna terminals of your receiver.

Once the connections explained above have been made, the antenna TV signals, as well as the signal from the recorder, will be fed to the TV and you can view TV programs in the usual way.

Note

Keep the VCR away from the TV, if the display or sound is affected.

How to attach an F-type connector

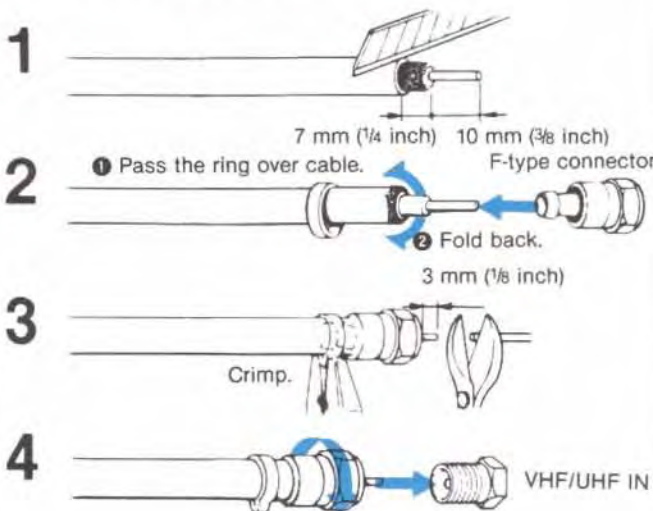

How to attach an external antenna connector

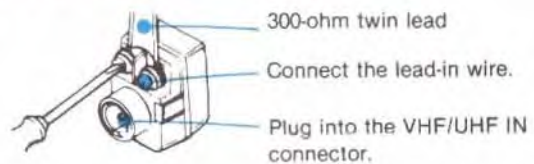

How to attach an EAC-66 U/V band separator (mixer)

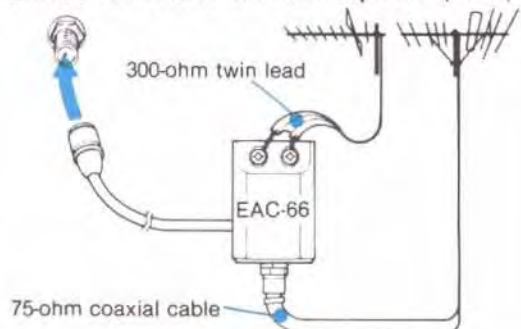

CATV cable

We recommend that you consult your cable company to make sure that the cable is properly connected.

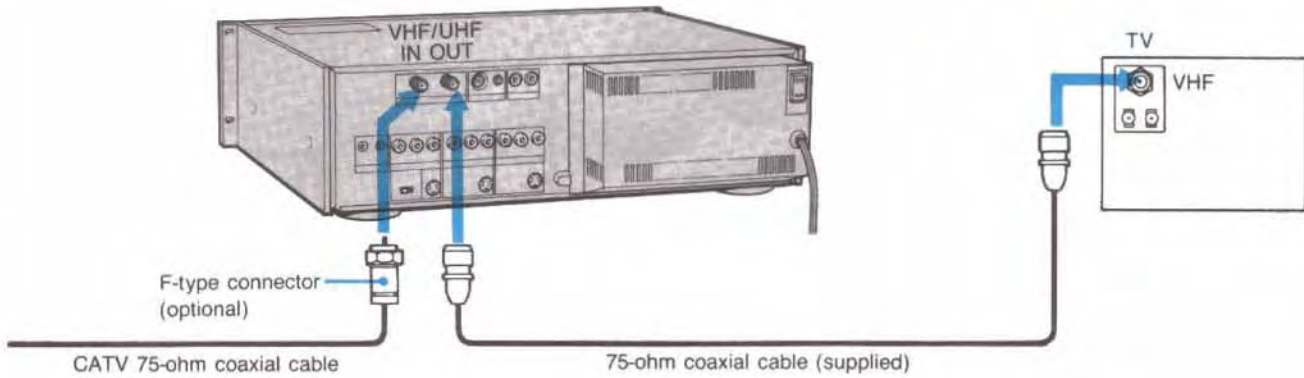

When a TV is not a cable TV compatible type

Connect the cable TV channel converter between the recorder and the TV so that you can watch another cable TV program while recording one cable TV program.

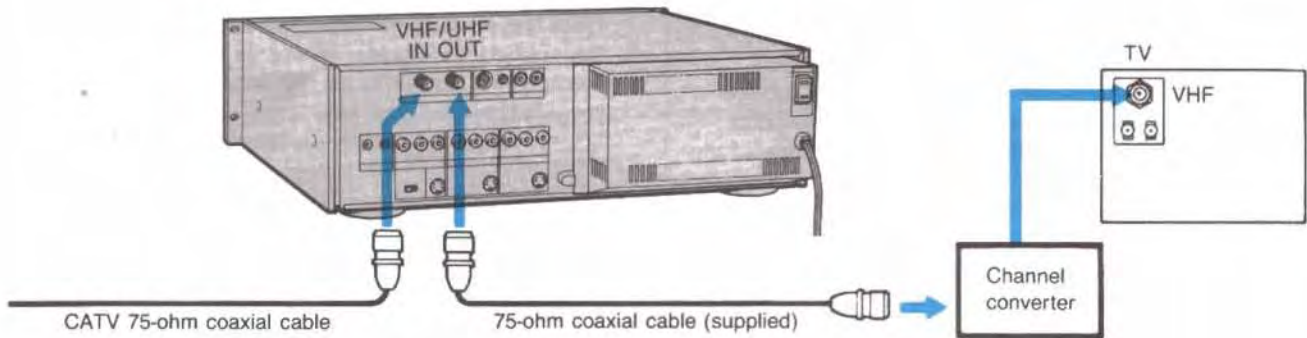

Note to CATV system installer in the U.S.A.

This reminder is provided to call the cable TV system installer's attention to Article 820-22 of the NEC that provides guidelines for proper grounding and, in particular, specifies that the cable ground shall be connected to the grounding system of the building, as close to the point of cable entry as practical.

Connecting a Color Monitor

To obtain a better-quality picture, connect a color monitor, such as the Sony Profeel Trinitron Component TV. When a component TV is combined with the speaker system as illustrated, you can enjoy tapes recorded with Beta hi-fi stereo.

To use a component TV tuner together with the monitor, make the same connection as in the case of the recorder and the conventional TV receiver described on pages 13 to 15.

For details on the connection of the TV tuner and the monitor, refer to the instruction manual of the TV tuner.

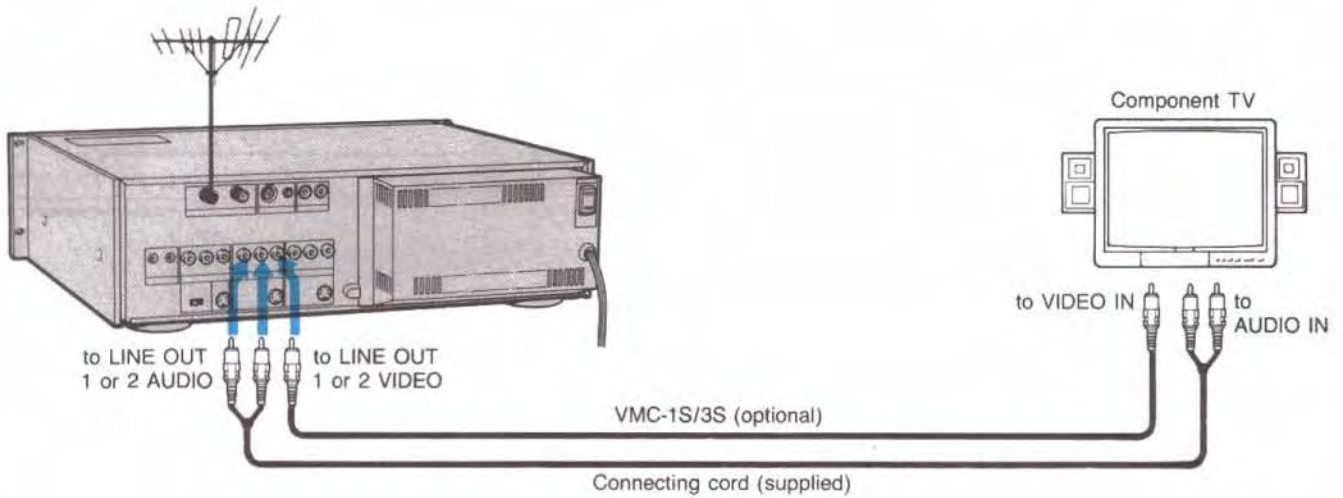

Note

With a color monitor, you cannot view a TV program while recording another program.

Connecting TV Equipped with Video/Audio Input Jacks

With the following connection, the picture and sound quality will be better than that when the TV is connected only to the VHF/UHF OUT terminal on the VCR. To view the playback picture, set the TV/VIDEO input selector on the TV to VIDEO.

Connecting a TV equipped with a phono-type video input jack

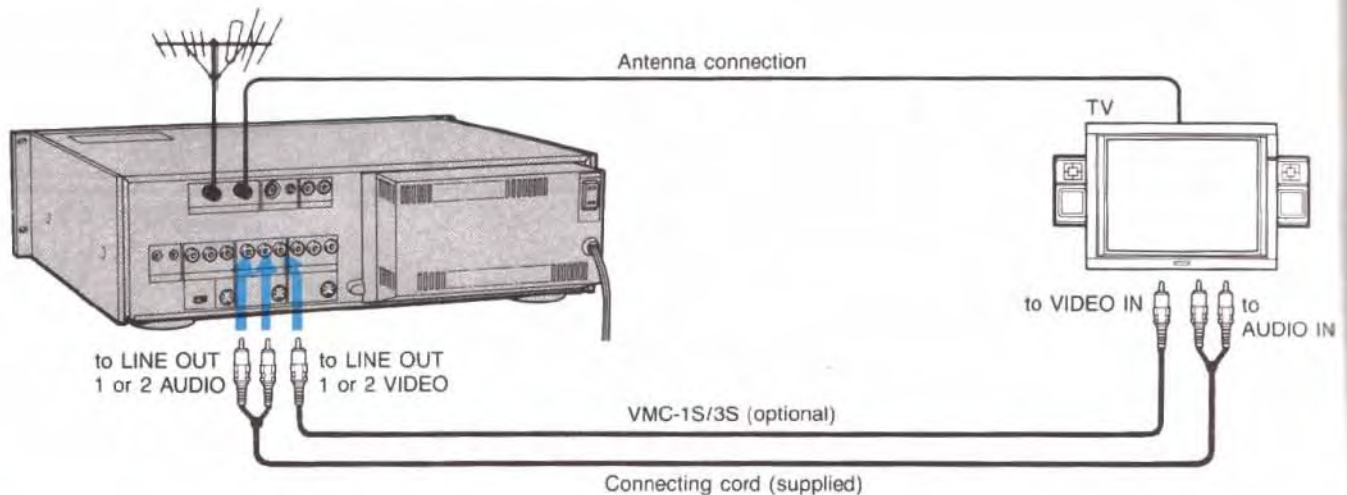

Connecting a TV equipped with an S VIDEO input connector

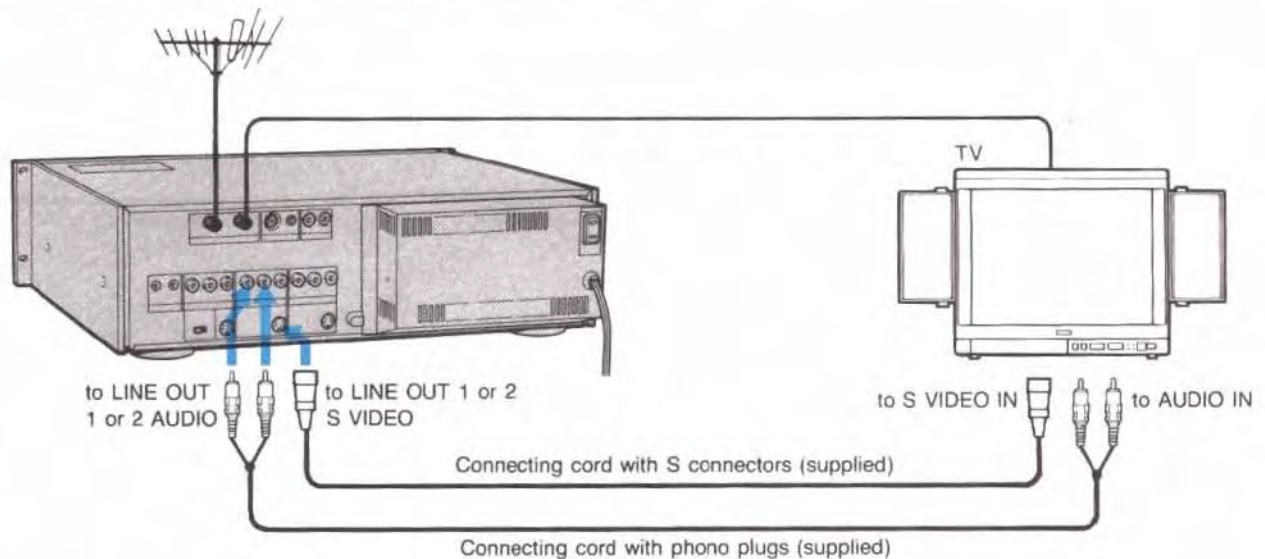

To cancel the automatic TV/VTR mode selection of this VCR

This VCR is preset at the factory so that it will be automatically set to VTR mode when playback starts. To cancel this function, proceed as follows:

- 1 Turn off the VCR.
- 2 Keeping the TV/VTR button depressed, press the POWER switch.
The VTR indicator blinks and the function is cancelled.

When playing back a tape, press TV/VTR to set to VTR mode.

To resume the automatic TV/VTR mode selection, repeat steps 1 and 2.

Connection to an Audio System

You can enjoy tapes recorded with Beta hi-fi stereo when the recorder is connected to your audio system.

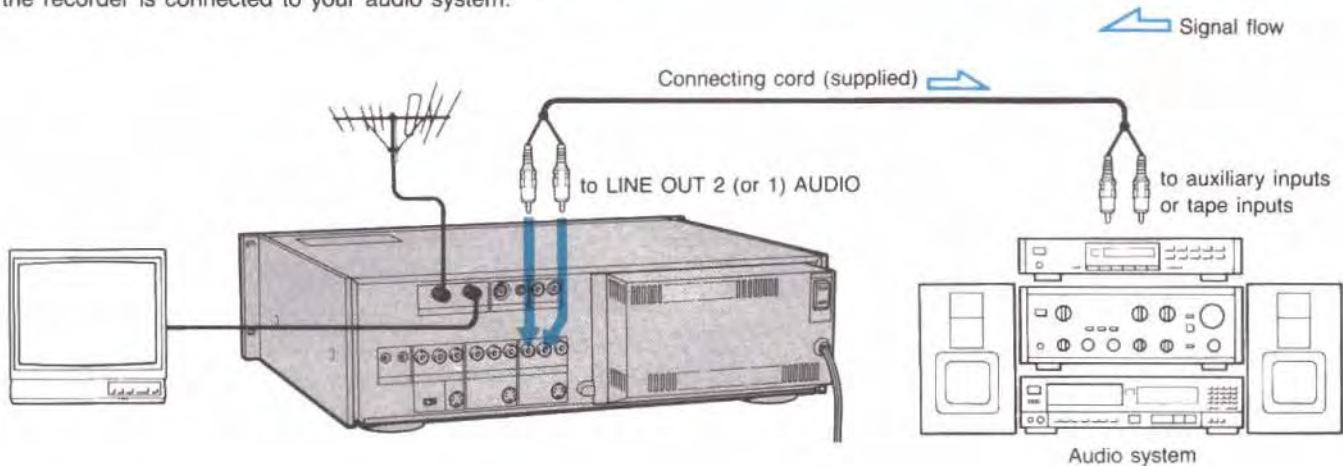

To record audio signals from your audio system

You can record from an audio source such as an FM tuner, CD player, with the Beta hi-fi system without recording video signals.

The audio system can also be connected to the front panel LINE IN 2 AUDIO jacks. This connection is convenient for temporary use.

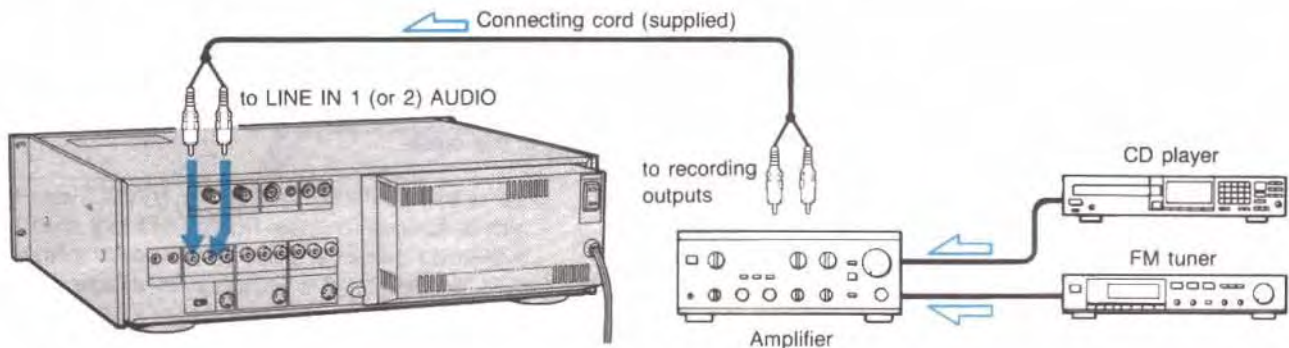

Connecting notes

- If the VCR is installed near a tuner or a radio, noise may be heard in AM reception. In this case, keep the VCR away from the tuner or the radio, adjust the AM antenna for minimum noise, or connect an external AM antenna to the tuner.
- Before connecting or disconnecting the power cord of the VCR, be sure to turn off the connected amplifier.

Note on speaker system

A Beta hi-fi recorded tape has a wide dynamic range. Before playing back a tape, turn down the volume on the amplifier to avoid damaging the speakers.

Power Connection

AC Outlet

The AC OUTLET on the rear panel provides a convenient AC power source for other video or audio equipment whose power consumption is under 200 watts.

Select the function of the AC OUTLET with the AC OUTLET selector inside the front panel.

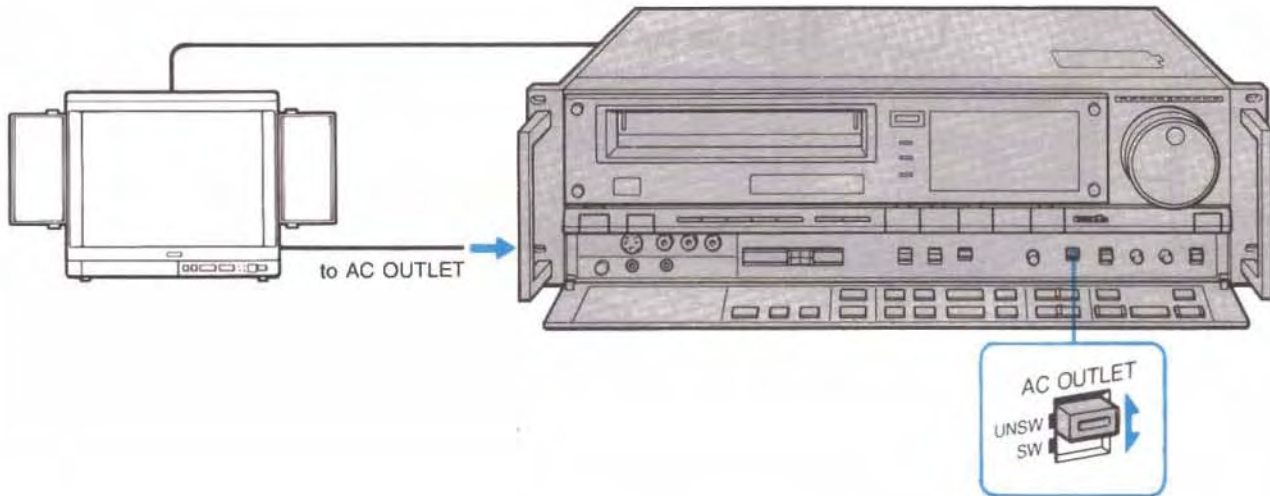

Set to SW to switch on and off the power supply from the AC OUTLET with the front panel POWER switch. Set to UNSW so that the power is supplied even when the POWER switch is turned off.

Caution

Do not connect any electric home appliances whose power consumption exceeds 200 watts, such as an electric iron or fan, to this outlet.

Adjusting the TV

Your TV receiver must be adjusted to receive the signal from your recorder. If you connect a color monitor or a TV

equipped with video/audio input jacks, it does not need adjusting.

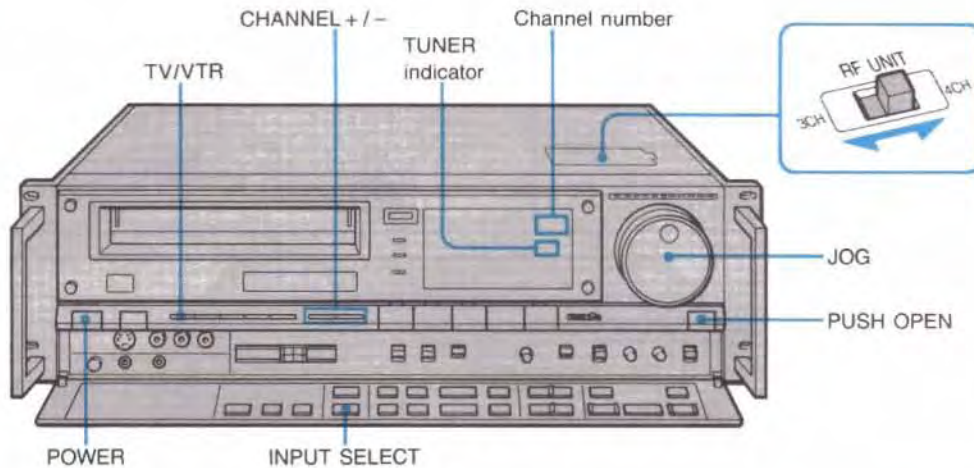

If you do not have a recorded video cassette tape

If you have a recorded video cassette tape

- 1 Set RF UNIT located in the tuning compartment to 3 CH or 4 CH whichever channel is not active in your area.
- 2 Press POWER. The indicator lights.

- 3 Press TV/VTR so that the TV/VTR indicator lights.
- 4 Check that the TUNER indicator appears in the display window, then select an active channel in your area by turning JOG or by pressing CHANNEL +/- .
(If the TUNER indicator does not appear, press PUSH OPEN to open the drawer and press INPUT SELECT until TUNER appears.)

- 3 Insert the cassette.
See page 26.
- 4 Press ► PLAY.

- 5 Turn on the TV.
 - 6 Set the TV to either VHF channel 3 or 4 to agree with the RF UNIT setting.
The TV program selected on the recorder or the tape program will be displayed on the TV screen. If a picture does not appear on the TV screen or if the display is not clear, fine-tune the channel on the TV.
- For details about TV channel adjustment, see the instruction manual of the TV receiver.

Check!
Check that the program displayed on the screen changes when a different channel is selected on the recorder.
If the program does not change, repeat the preceding steps.

Check!
Check that the display on the screen changes when you stop the tape by pressing ■ STOP on the recorder. (To eject the cassette, press ▲ EJECT.)
If the program does not change, repeat the preceding steps.

Now your TV receiver is tuned to the recorder. Whenever you use the video recorder, you should set the TV to the channel which you have chosen above.

Presetting the Active Channels in Your Area

Your recorder is capable of receiving VHF channels 2–13, UHF channels 14–69 and cable TV channels 1–125 (A–8 to W+84). See cable TV channel chart on page 23. By adding and erasing channels, you can preset the

recorder so that only the desired channels will appear in sequence when you select a channel later with CHANNEL +/- on the recorder, or TIMER/CH +/- or JOG dial on the Wireless Commander.

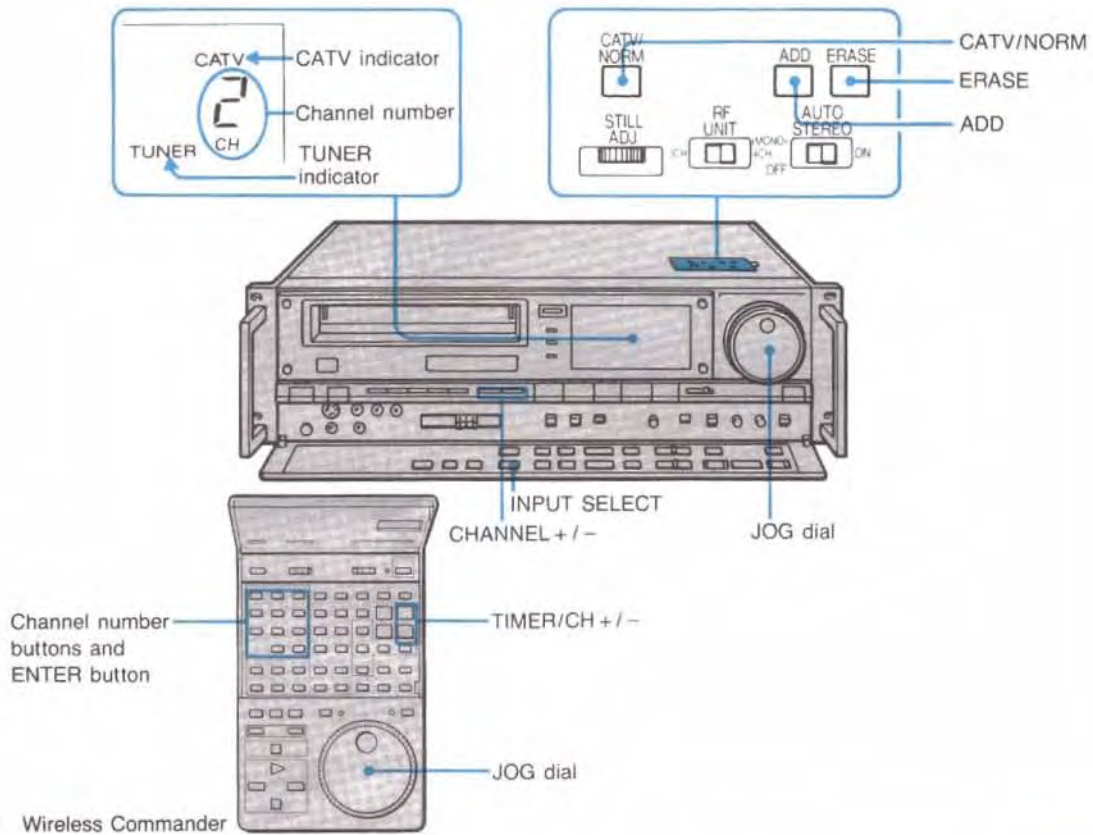

Before Presetting

- Turn on the recorder and the TV. Make sure that the TV is set to the correct channel (channel 3 or 4) for the recorder.
- Press INPUT SELECT so that the TUNER indicator and channel number appear in the display window.
- For presetting cable TV channels, press CATV/NORM to display the CATV indicator in the display window. For off-the-air TV channels, press it again to turn off the CATV indicator.

Adding Channels

- 1 Select the channel to be added with the number buttons and ENTER on the Commander.

e.g. To select channel 16

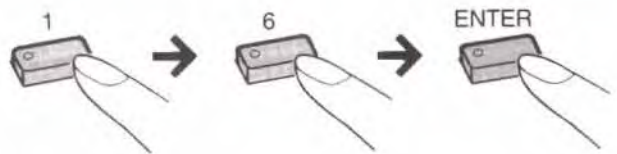

- 2 Press ADD. The "--" indication appears momentarily, indicating that the channel has been added.

Repeat steps 1 and 2 for other channels to be added.

Erasing Channels

- 1 Select the channel to be erased.
- 2 Press ERASE.
The "--" indication appears momentarily, indicating that the channel has been erased.

Repeat steps 1 and 2 for other channels to be erased.

Cable TV Channel Chart*

Cable TV systems use letters or numbers to designate channels. To tune in a channel, refer to this chart.

Number on this VCR	1	5	6	14
Corresponding cable TV channel	A-8	A-7	A-6	A

15	16	17	18	19	20	21	22	23	24
B	C	D	E	F	G	H	I	J	K

25	26	27	28	29	30	31	32	33	34
L	M	N	O	P	Q	R	S	T	U

35	36	37	38	39	93	94	95
V	W	W+1	W+2	W+3	W+57	W+58	A-5

96	97	98	99	100	101	102	123
A-4	A-3	A-2	A-1	W+59	W+60	W+61	W+82

124	125
W+83	W+84

Check with your local cable TV company for more complete information on the available channels.

*The designation of the cable TV channels conforms to the EIA/NCTA recommendation.

Note

Pay cable TV systems use scrambled or encoded signals and require special converters (decoders) in addition to the normal cable connection.

Date and Clock Setting

When you connect the AC power cord to wall outlet, the clock indicates "Su AM 12:00 and it will blink to show that the clock is ready to be set.

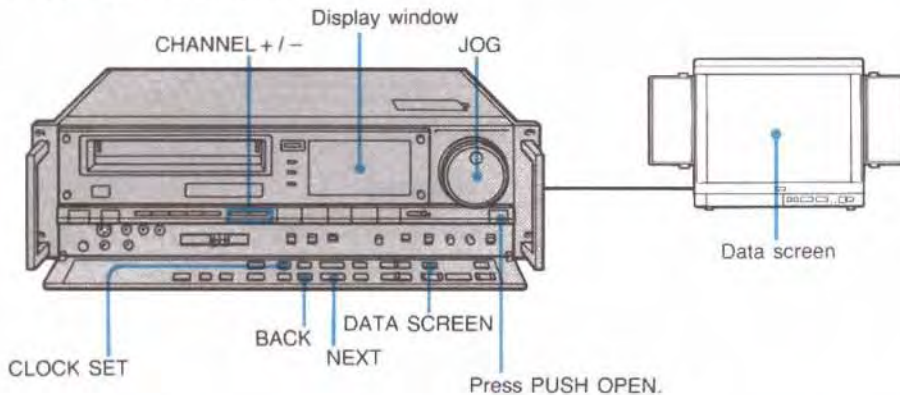

JOG dial

Turn clockwise to advance the digits, and counterclockwise to reverse them.

CHANNEL +/- buttons

Press "+" to advance the digits, and "-" to reverse them. If the button is kept depressed, the digits will advance or reverse continuously.

To turn on and off the data screen display, press DATA SCREEN.

Example: to set the date/clock to 3:30 p.m., October 19, 1988

1 Press CLOCK SET.

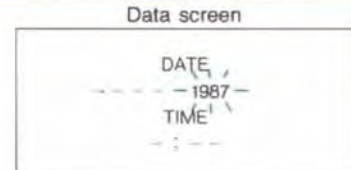

2 Set the year by turning the JOG dial or pressing CHANNEL +/- until "88" appears. Then press NEXT.

00 = 2000

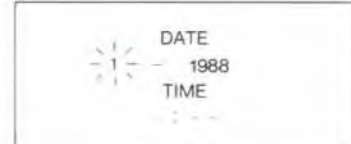

3 Set month, day, hour and minute in sequence. First adjust the blinking item by turning the JOG dial or pressing CHANNEL +/-, and then press NEXT.

AM12:00 = midnight

PM12:00 = noon

The day of the week is automatically set when the year, month and day are registered.

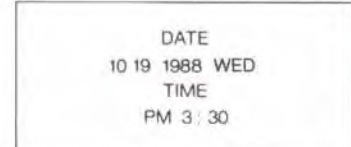

4 For accurate setting, after adjusting the minute digit, press NEXT at the same time as an announced time signal.

The clock will now start and the dots of the colon will alternately blink every 30 seconds.

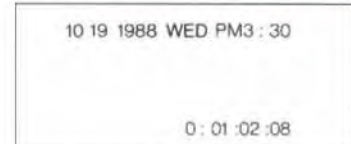
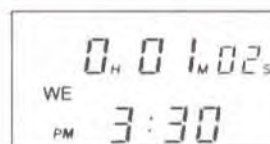

To readjust the previously set item during clock setting
Press BACK. The previously set item will blink and can be readjusted. Press BACK repeatedly until the desired item blinks.

When "AM 12:00" blinks in the display window

There has been a power interruption for more than 10 minutes or the power cord has been disconnected for more than 10 minutes. In this case, readjust the clock.

To readjust the date or clock after the setting has been completed

Press CLOCK SET. The hour digits will blink. To change the year, month or day, press BACK. Readjustment procedure is the same as above.

Data Screen Display

Once the date and clock are set, the following items will be displayed on the monitor screen. When the display does not appear, press DATA SCREEN.

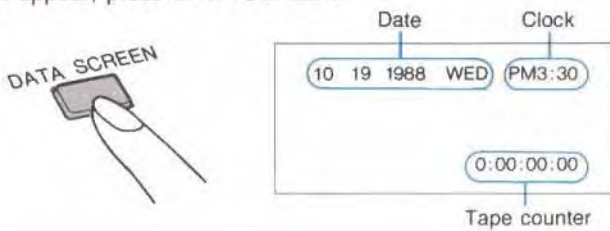

Examples of data screen display

- When a tape starts running

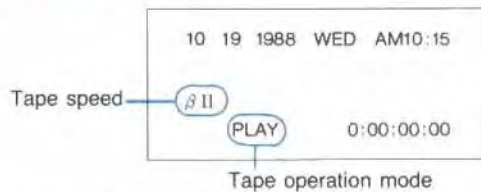

- When a TV channel is selected



- When the input is changed by pressing the INPUT SELECT button

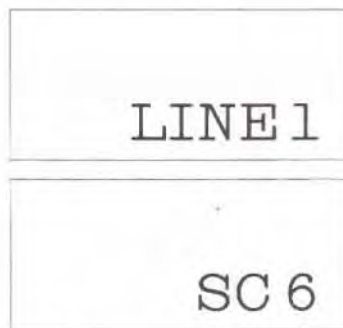

The previous display will resume in five seconds.

To Select the Items to be Displayed

You can select the items to be displayed on the data screen from among date, clock and tape counter, as well as the black background.

- 1 While pressing NEXT, press DATA SCREEN. The cursor will blink on the screen.

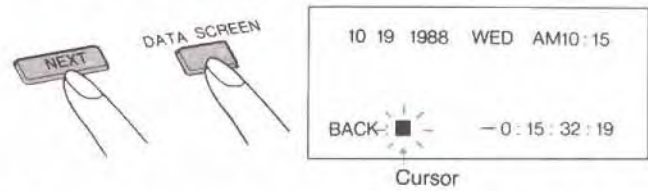

- 2 Select the background of characters by turning JOG. The background will change each time JOG clicks.

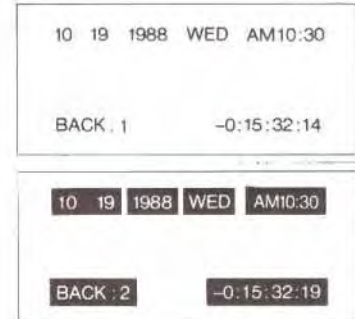

- 3 Press NEXT.

- 4 Select if the date is to be displayed or not by turning JOG. The date disappears and reappears each time JOG clicks.



- 5 Press NEXT.

- 6 Select if the clock is to be displayed or not by turning JOG.

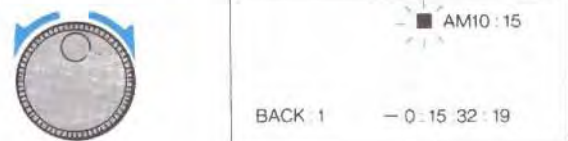

- 7 Press NEXT.

- 8 Select if the tape counter is to be displayed or not by turning JOG.

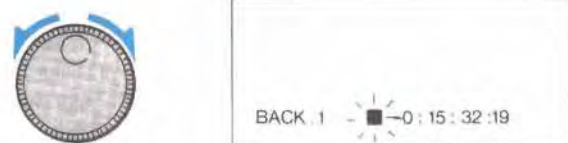

- 9 Press NEXT.

To turn off the data screen display

Press DATA SCREEN.

To reset to the initial display

Repeat steps 1 through 9 and display all the items.

Handling the Video Cassettes

Cassette Insertion

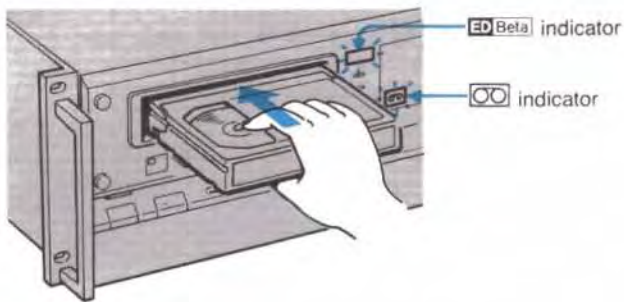

Insert a cassette. The power will be turned on automatically.
 The **OO** indicator lights when the cassette is in.
 The **ED Beta** or **B** cassette is detected automatically.
 When a **B** cassette is inserted, the **ED Beta** indicator will go off.

Cassette Ejection

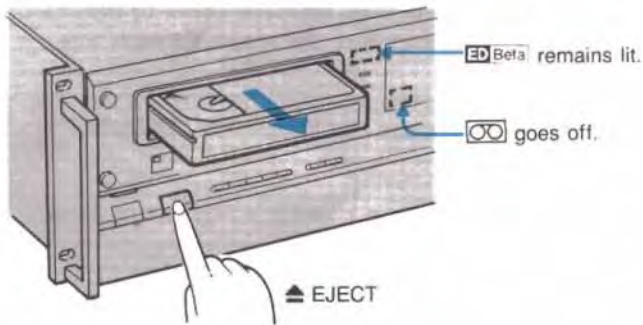

Press **EJECT**. The cassette will be ejected.
EJECT functions even when the power is turned off.

Recording Time Available in Each Mode

By selecting the recording speed, **BII** or **BIII**, with the REC MODE button, you can decide the recording time.

Cassette used	B I and B IS modes (playback only)	B II mode	B III mode
EL-250	—	1 hr.	1 hr. 30 min.
EL-500	—	2 hr.	3 hr.
L-125	15 min.	30 min.	45 min.
L-250	30 min.	1 hr.	1 hr. 30 min.
L-500	1 hr.	2 hr.	3 hr.
L-750	1 hr. 30 min.	3 hr.	4 hr. 30 min.
L-830	1 hr. 40 min.	3 hr. 20 min.	5 hr.

The playback speed is automatically set.

To Avoid Erasing a Recording

When a new recording is made on a pre-recorded cassette, the previous recording will be erased automatically. To avoid erasing a recording, the cassettes incorporate a record prevention system.

ED Beta cassette

To avoid erasing, depress the red button. To re-record on the cassette, press to release the button.

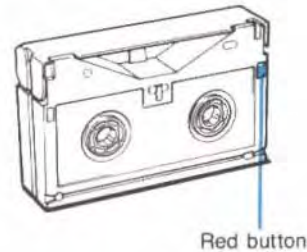

Conventional **B** cassette

To avoid erasing, break off the safety tab using a screwdriver or similar.
 To re-record on the cassette, cover the opening where the safety tab has been removed with a piece of plastic tape.

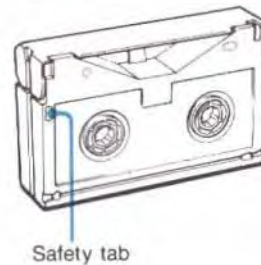

When the inserted cassette is in record prevention mode

- If you activate **REC**, **QUICK TIMER** or **TIMER REC**, THE **OO** indicator will blink and the cassette will be automatically ejected.
- If you activate **VIDEO** or **AUDIO INSERT**, the **OO** indicator will blink and the unit will not enter insert mode. The cassette will not be ejected automatically.

Remote Control Operation

Battery Insertion

1 Open the lid.

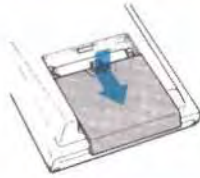

2 Insert three size AA (IEC designation R6) batteries with correct polarity.

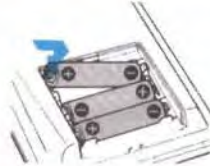

3 Slide and close the lid.

Battery life

In normal operation, batteries will last for three months. When the batteries are exhausted, the JOG dial and SHUTTLE ring on the Commander will not function, and then the indicator will not light when the buttons on the Commander are pressed.

If the Wireless Commander is not to be used for a long period of time, remove the batteries to avoid possible damage from battery leakage.

Operation

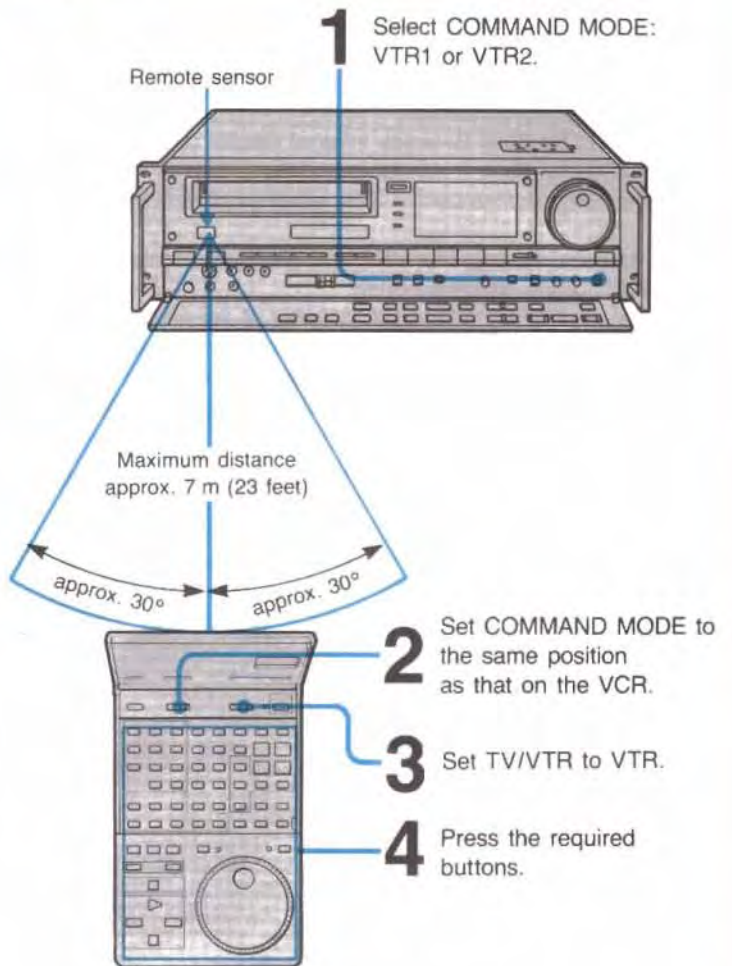

To use the JOG dial and SHUTTLE ring on the Commander

- When using JOG for timer setting or channel selection: Press the CHANNEL/TIMER function button so that the associated indicator lights.
- When using JOG and SHUTTLE for various speed playback: press the JOG SHUTTLE function button so that the associated indicator lights.
- After using JOG and SHUTTLE, press the same button again to turn off the indicator. The indicator will go off automatically in about 1 minute without pressing CHANNEL/TIMER or JOG SHUTTLE.

To avoid having this VCR being remotely controlled
Select COMMAND MODE on the VCR to OFF. The remote sensor on the VCR will become ineffective.

For Owners of Other Sony Video Equipment or TV

To remotely control the equipment without the command mode selector

Set the COMMAND MODE selector on the Wireless Commander as follows:

VTR1: for Sony Betamax infrared remote control VCRs

VTR2: for Sony 8 mm format VCRs

For Sony remote control TVs, either position will do.

To avoid having this VCR and the other equipment functioning simultaneously

Set the COMMAND MODE selector of this VCR to a different command mode position from the command mode of the other equipment. Simply by switching the command mode selector on the Wireless Commander, you can control two VCRs separately.

To control Sony remote control TVs

The buttons marked with an orange dot on the Wireless Commander can be used to operate certain Sony remote control TVs. To operate a TV, set the remote control TV/VTR selector on the Commander to TV. The functions of the buttons are limited by the functions on the TV.

POWER: Press to turn the power on and off.

MUTING: Press to mute the sound. Press again to restore the sound.

TV/VTR: Press to select the input mode.

VOL +/- : Press "+" for more volume, and "-" for less volume.

TIMER/CH +/- and JOG: Select the channel.

DATA SCREEN: Press to retain or extinguish the on-screen display.

Number buttons and ENTER: Select the channel.

Recording TV Programs (Beta hi-fi recording)

Make sure that you have finished all the connections and adjustments on pages 13 through 28.

Caution

Television programs, films, video tapes and other materials may be copyrighted. Unauthorized recording of such material may be contrary to the provisions of the copyright laws.

Also, use of this recorder with cable television transmission may require authorization from the cable television transmitter and/or program owner.

Before Recording

- Turn on the TV and select the channel for the recorder or select the VCR input on the TV.
- Check the positions of the selectors.

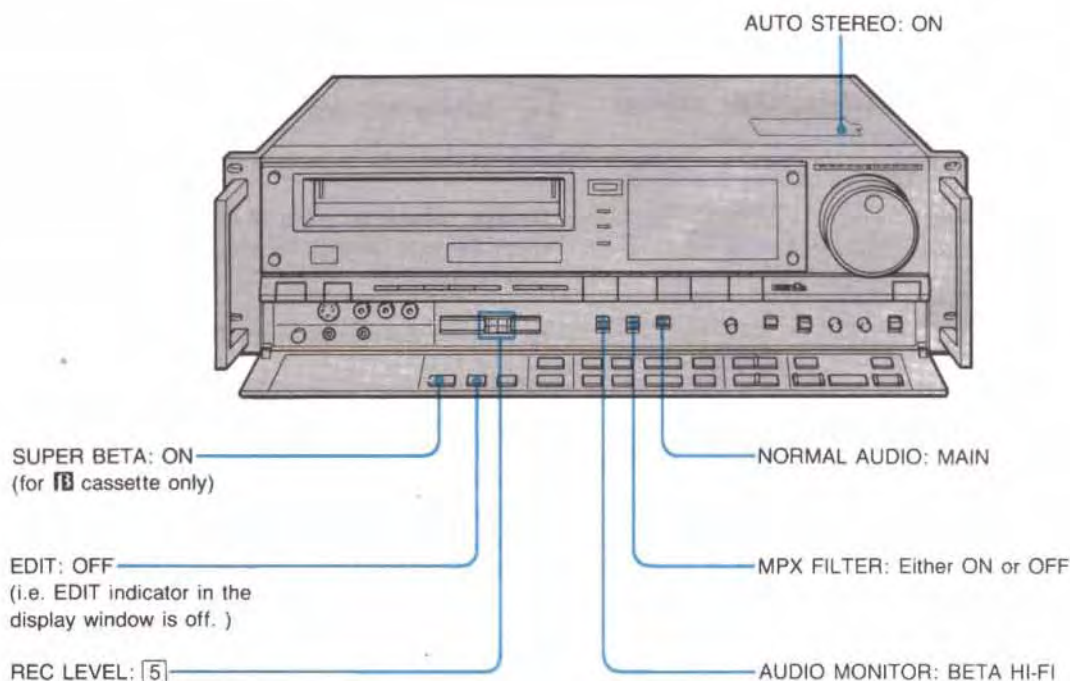

Operation

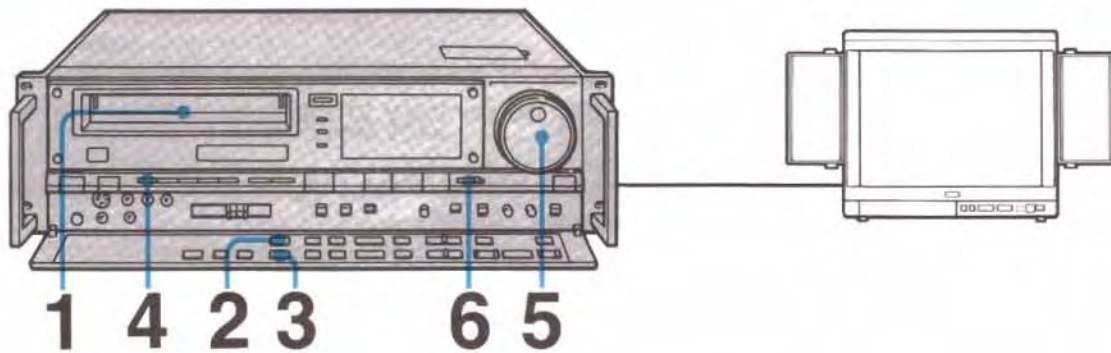

<p>1 Insert an ED Beta cassette.</p>	<p>4 Press TV/VTR so that the VTR indicator lights (VTR mode).</p>
<p>2 Select the recording speed, II or III, with REC MODE.</p>	<p>5 Select the channel to be recorded with JOG (or CHANNEL + / -).</p>
<p>3 Press INPUT SELECT so that the TUNER indicator appears in the display window.</p>	<p>6 Slide ● REC to the right. Recording will begin.</p>

Check in the display window

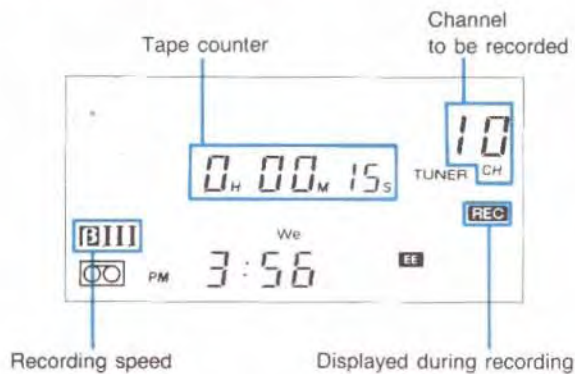

To stop recording, press ■ STOP.

When the tape reaches its end, it will be rewound to the beginning.

To turn off the power, press POWER.

To stop the tape momentarily

Press **II/III** PAUSE/STILL. The TV program can still be seen on the TV, but the picture will not be recorded. To resume recording, press **II/III** PAUSE/STILL again. To protect the video heads and the tape, the pause mode will be automatically released after about 8 minutes and recording will stop.

How to select the channel

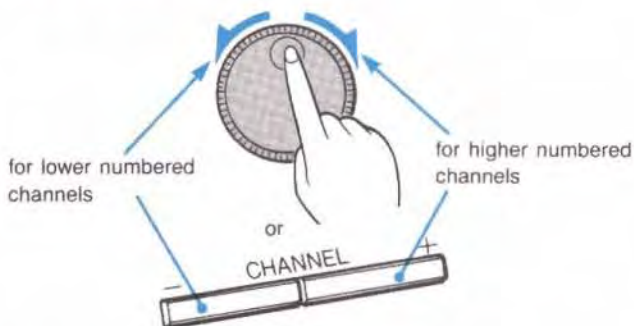

With JOG on the recorder, all the channels are received. With JOG on the Wireless Commander, preset channels are received.

In case you want to record with a **B** tape which is to be played back on another recorder from the very beginning of the tape, run the tape for about 15 seconds before starting recording. Otherwise you may miss the starting point during playback on the other machine.

Note on SUPER BETA Button

The SUPER BETA button is effective for **B** cassettes only.

For recording

- Set to ON to make high picture quality recordings.
- Set to OFF if you intend to play back the tape on a non-SuperBeta VCR. A tape recorded with the SUPER BETA button set to ON may cause some over-modulation noise when played back on a non-SuperBeta VCR.

For playback

- Normally set to the position in which the tape was recorded.
- Set to ON if the tape was recorded in the **BIS** mode.
- Set to OFF if the tape was recorded in the **BI** mode, or if the tape was recorded on a non-SuperBeta VCR.

To Start Recording from a Particular Point

You can decide the starting point for recording while watching the picture.

- 1 Play back the tape and locate the point where you wish to start recording on the tape.
- 2 Press **II/PAUSE/STILL** to stop the tape where you wish to start recording.
- 3 Slide **● REC** to the right. The recorder will enter recording pause mode.
- 4 Press **II/PAUSE/STILL** at the desired point to release the pause mode. Recording will begin.

To Stand by Correctly at the Desired Point

When you started recording of an unnecessary program, you can return the tape to the desired point and set the VCR to recording standby mode.

- 1 Set the VCR to recording pause mode.
- 2 Press **▶ PLAY**. The VCR will enter playback pause mode.
- 3 Locate the desired point where you wish to start recording by turning the JOG dial. (See page 36)
- 4 Slide **● REC** to the right. The VCR will enter recording pause mode.
- 5 Press **II/PAUSE/STILL** at the desired point. Recording will begin.

To Record Multichannel TV Sound (MTS) Broadcasts (Stereocasts)

In the years to come, an increasing number of programs will be broadcast in stereo. Called Multichannel TV Sound or MTS, the new technology will greatly enhance TV viewing by bringing you programs with high fidelity stereo sound.

MTS also provides for an extra channel called the Second Audio Program or SAP which broadcasters can use to transmit a second language for bilingual transmissions or any other sound track.

To record a stereo broadcast

When a stereo program is received, the STEREO indicator will appear in the display window. With the usual recording procedure, the program will be recorded in stereo on the video track, and in monaural on the conventional audio track.

- Make sure AUTO STEREO in the tuning compartment is set to ON.
- The recording procedure is the same as usual.

Note

If a stereo program is noisy, set AUTO STEREO to OFF. The noise will be reduced though the program is heard in monaural.

To record a SAP (Second Audio Program) broadcast

Set NORMAL AUDIO inside the front panel to SAP. The SAP indicator will appear in the display window.

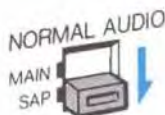

If recording is made when there is a SAP broadcast, the SAP sound will be recorded on the conventional audio track while the MAIN sound is recorded on the video track in Beta hi-fi. To listen to the SAP sound, set AUDIO MONITOR BETA HI-FI/MIX/NORM to NORM.

To record a MAIN broadcast only

Set NORMAL AUDIO to MAIN. The MAIN sound will be recorded on the video track and the conventional audio track.

Note

When a SAP sound is not be recorded, be sure to set NORMAL AUDIO to MAIN. If it is set to SAP and there is no SAP broadcast, no sound is recorded on the conventional audio track.

To View One TV Program While Recording Another

Press TV/VTR so that the VTR indicator goes off, then select the channel you want to view on the TV.

- If your TV is equipped with a TV/VTR input selector, simply set the selector to "TV" and select the desired channel on the TV.

Operation

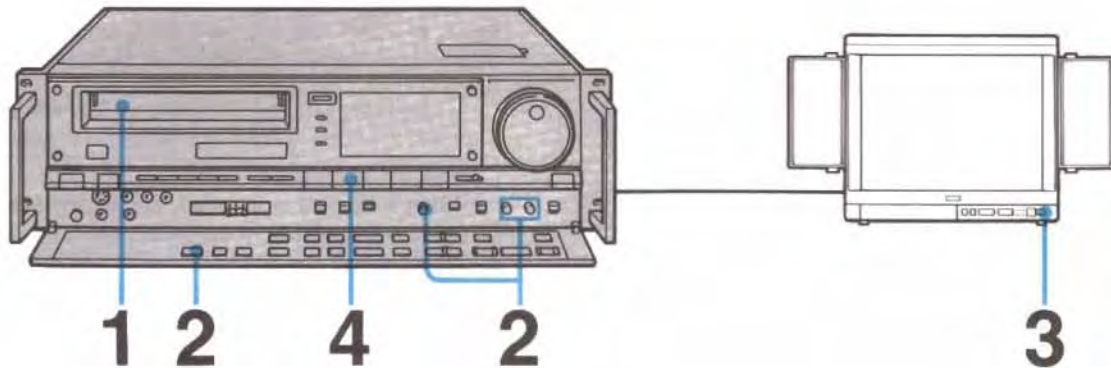

1 Insert a **Beta** or **B** cassette.

2 Check the positions of the following controls.

- SHARPNESS: center position
- TRACKING: center position
- SUPER BETA (for **B** cassette only): Set to the position in which the cassette is recorded.

3 Turn on the TV and select the channel for the recorder or select the input for the recorder.

4 Press **▶ PLAY**. Playback will begin.

To Select the Monitor Sound

Playback of Beta hi-fi stereo sound programs

Inside the front panel



Set **AUDIO MONITOR** or **BETA HI-FI** or **MIX**. When the recorder is connected to a Component TV, a stereo system or stereo headphones, you can enjoy stereo sound reproduction.

When a conventional (monaural) TV is connected, the sound of the left and right channels are mixed so that monaural sound comes from the TV speaker.

To select the left or right channel of stereo programs

Inside the drawer



Display window

STEREO
L
R

Select the desired channel by pressing **AUDIO MONITOR L/R**. Each time the button is pressed, the indicator of the selected channel, **STEREO**, **L** (left) or **R** (right) will appear in the display window.

Playback of SAP sound

To listen to the **SAP** sound that was recorded with **NORMAL AUDIO** set to **SAP**, set **AUDIO MONITOR** to **NORM** (for the **SAP** sound only) or **MIX** (for both the **SAP** and **MAIN** sounds).

To View a TV Program during Playback

During playback, press EE inside the drawer or on the Wireless Commander. The EE indicator will appear in the display window. While the button is kept pressed, the program of the TV channel selected by the VCR is seen on the monitor screen. Release the button to view the playback picture.

When You Play Back a Tape Recorded on Another VCR

- If the VCR on which the tape was recorded is not equipped with the Beta hi-fi system, this recorder will play back the tape in the conventional way automatically. The Beta hi-fi indicator does not light.
- If streaks or snow appears, adjust TRACKING NORM for the best possible picture. Return the control to the center position after viewing that tape.
- To get a sharp picture, turn SHARPNESS toward SHARP.

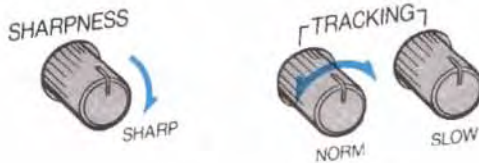

Auto Play

—To play back a tape from the beginning of the tape after rewinding

Press ► PLAY keeping ◀ REW depressed. After the tape is completely rewound, it will be automatically played back.

Notes on playback

- When a **IB** tape is inserted, the SuperBeta indicator lights automatically. If the tape has been recorded in **IB** mode on this VCR or on a non-SuperBeta VCR, press the SUPER BETA button to turn off the SuperBeta indicator.
- To change to channel 3 or 2 on your TV from the channel on which you have been viewing something from the video recorder, be sure to press TV/VTR first and then change to channel 3 or 2 is set on your TV. If TV/VTR is pressed after channel 3 or 2 is set on your TV, you might not get a picture. In this case, change your TV channel to another channel and then come back to channel 3 or 2.

Various Playback Modes

—Using the Buttons on the VCR or Wireless Commander

Digital Betascan

—Viewing the picture at a fast speed to find a particular scene

Keep pressing ►► FF or ◀◀ REW during playback. When you release the button, the normal playback will be resumed.

Digital Beta SkipScan

—Viewing the picture momentarily during fast-forward or rewind

Keep pressing ►► FF or ◀◀ REW during fast-forward or rewind mode.

When you release the button, the fast-forward or rewind mode will be resumed.

Streaks will appear and sound will be muted in the Betascan and Beta SkipScan pictures. (Especially a wide noise band will appear with a tape recorded in **BI** mode.)

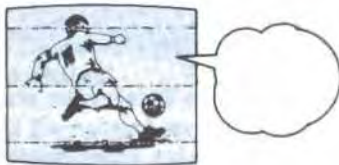

Digital Freeze Picture (playback pause)

Press **II/II** PAUSE/STILL during playback. The sound is muted.

Press **II/II** PAUSE/STILL again or press ► PLAY to resume normal playback.

To protect the video heads and the tape, the pause mode will be automatically released after about 8 minutes and playback will be resumed.

TO OBTAIN BETTER PLAYBACK PICTURE

—In various playback modes

- If the freeze picture appears to shake...
Turn STILL ADJ in the tuning compartment until the picture stabilizes.
As long as the same TV or color monitor is used, readjustment should not be necessary.
- If streaks or noise bands appear in freeze, stop-action advance, or 1/10 or 1/5 speed picture...
Set to 1/10 or 1/5 speed picture mode and adjust SLOW TRACKING inside the front panel.
- If streaks or noise bands appear in normal (x1) or double speed (x2) picture...
Adjust NORMAL TRACKING inside the front panel.

—Using the Buttons on the Wireless Commander only

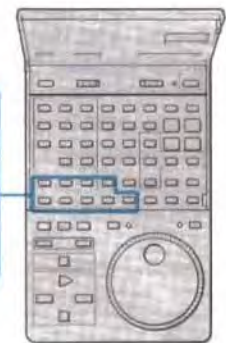
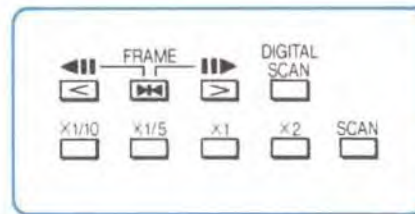

Stop-action Advance Picture

Press FRAME **II►** (forward) or **◀II** (reverse) in freeze picture mode.

Press ► PLAY to resume normal playback.

Variable Speed Playback

Press the desired speed button during playback or in freeze picture mode. The sound is muted (except in x1 picture).

- ◀II: freeze picture
- x1/10: slow motion picture at 1/10 normal speed
- x1/5: slow motion picture at 1/5 normal speed
- x1: normal speed picture
- x2: double speed picture
- SCAN: continuous Betascan picture

- The x2 button will not function for tapes recorded in the **BI** or **BIS** mode. Though "x2" appears on the monitor screen when x2 is pressed, normal playback will be carried out.

To reverse the direction of the variable speed playback, press **◀II**. To resume forward playback, press **II►**.

To change the playback speed, simply press the desired speed button.

To resume normal playback, press ► PLAY.

Locked Picture Search

—Viewing the picture during fast-forward or rewind

In normal playback or various playback modes, press **II► (>)** (forward) or **◀II (<)** (reverse) to select the tape transport direction and press SCAN. To resume normal playback, press ► PLAY.

Digital Scan

—Viewing a very high speed picture

Press DIGITAL SCAN momentarily in fast-forward or rewind mode. To resume normal fast-forward or rewind mode, press DIGITAL SCAN again.

Various Speed Playback Using the JOG Dial and SHUTTLE Ring

Use the JOG dial and SHUTTLE ring either on the VCR or on the Wireless Commander.

To use JOG and SHUTTLE on the Commander

First press the JOG SHUTTLE function button on the Commander so that the associated indicator lights. The VCR will enter the freeze picture mode.

on the VCR

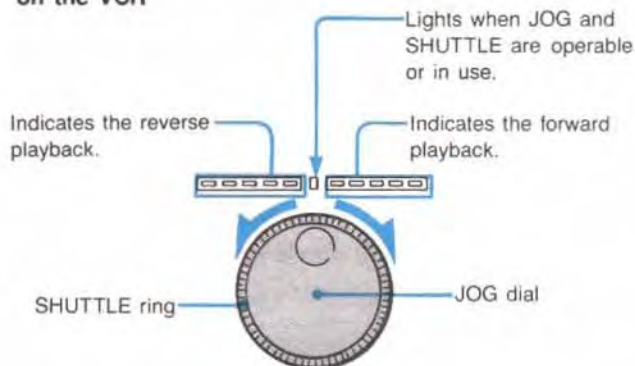

Using the JOG dial

- 1 Set the VCR to the freeze picture mode. (Press **II/PAUSE/STILL** on the VCR or press JOG SHUTTLE on the Commander.)
- 2 Turn the JOG dial. The tape will be played back at the speed at which you are turning the dial (1/10, 1/5 or normal speed). Turn it clockwise for forward playback, or counterclockwise for reverse playback.



- 3 When you stop turning the JOG dial, the picture will freeze again.

Using the SHUTTLE ring

- 1 Set the VCR to the freeze picture mode. (Press **II/PAUSE/STILL** on the VCR or press JOG SHUTTLE on the Commander.)
- 2 Turn the SHUTTLE ring and hold it at the position where the desired playback speed is obtained. You can select 1/10 (with SHUTTLE on VCR only), 1/5, normal, double or continuous Betascan speed. Turn it clockwise for forward playback, or counterclockwise for reverse playback.



Use the speed indications on the Commander as a guide.

- 3 When the SHUTTLE ring is released, the picture will freeze again.

Notes on JOG and SHUTTLE

- If JOG and SHUTTLE on the Commander are not used for more than one minute, their function will be released automatically in order to prevent undue battery wear. To use JOG and SHUTTLE again, press the JOG SHUTTLE function button once more.
- JOG and SHUTTLE will function in freeze picture and variable speed playback modes.
- 1/10 speed playback is not possible with SHUTTLE on the Commander.
- The tape transport buttons do not function when JOG or SHUTTLE is in use.

Notes on various playback modes

- In various playback modes, Beta hi-fi is selected automatically and the Beta hi-fi indicator lights even with a non-Beta hi-fi recorded tape. When playing back a non-Beta hi-fi recorded tape, set AUDIO MONITOR to NORM.
- In various playback modes, some picture frames may be skipped where the tape speed is changed on the tape. This is due to digital image processing.
- The tape speed of x1 and x2 reverse playback in **BI** mode, and the tape speed of x1 reverse playback in **BI** mode are not exactly the same as those of normal playback and x2 forward playback.
- In digital scan mode, the top and bottom portions of the picture may be defective or the width of the picture may vary.

Viewing Digital Pictures

The digital picture function performs digital image processing of the received TV signals, VCR playback signals or signals from the line inputs, stores the processed signals in the digital frame memory and displays them on the screen.

Use the buttons on the Commander for the digital picture function.

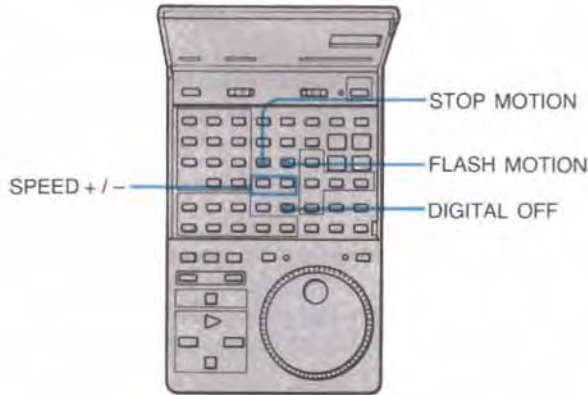

Stop Motion

—to freeze a picture

While viewing a VCR playback, a TV program or a picture from external equipment, **press STOP MOTION**.

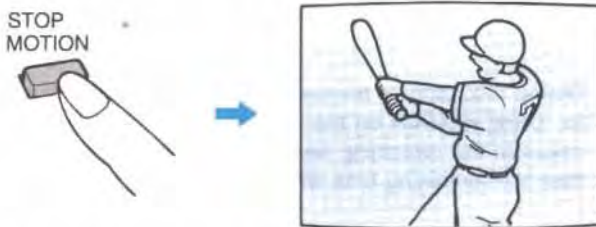

The picture freezes. The sound continues to be heard.

To resume normal viewing

Press **DIGITAL OFF**.

- When the stop motion mode is cancelled, VCR playback is resumed from the advanced portion of the taped program, since the tape continues running even in stop motion mode. In the case of a TV program, the scene being broadcasted will appear.

Flash Motion

—to view freeze pictures successively at specific intervals

While viewing a VCR playback, a TV program or a picture from external equipment, **press FLASH MOTION**.

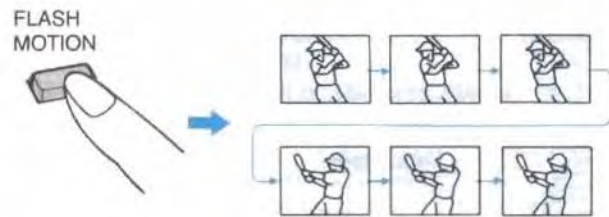

The picture freezes, and after a given period of time, the next freeze picture will appear. The sound continues to be heard.

To change the intervals at which the freeze picture is switched

By pressing **SPEED +**, the interval becomes shorter, and by pressing **SPEED -**, it becomes longer. Six intervals can be selected between approximately 1/8 and 4 seconds.

To resume normal viewing

Press **DIGITAL OFF**.

Notes

- The digital picture function cannot be activated in various playback modes or recording mode.
- The digital pictures cannot be recorded with this unit. They can be recorded with another recorder, but may not be played back correctly.
- The digital picture obtained from the playback of an external video equipment may be distorted.
- If the Betascan is activated while a digital picture is displayed, normal playback will be resumed.
- When a digital picture function button is pressed with no video signal input, the picture may not be stored correctly or the previously stored picture may appear on the screen.

Use of the Tape Counter

The tape counter indicates the approximate running time of the tape and the relative position of programs on the tape.

Display window

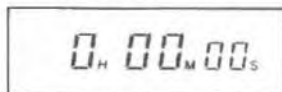

Data screen

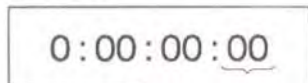

Frame digits

To Index the Tape Contents

Before starting recording or playback, press COUNTER RESET to set the counter to zero. By noting the counter reading at the desired point, you can easily find that point later by referring to the counter. Use the label on the cassette to list the programs and their counter readings.



Notes on counter reading

- The counter reading is automatically reset to zero when a cassette is newly inserted.
- The counter reading will be retained in the memory even after the power is turned off, as long as the cassette is kept inserted in the cassette compartment.
- The counter will not advance during any portion of a tape that is blank or unrecorded.
- The counter reading will not exactly correspond to the position of the tape after the tape has been stopped or run repeatedly in fast-forward or rewind mode.

To display the counter on the TV screen, press DATA SCREEN inside the drawer.

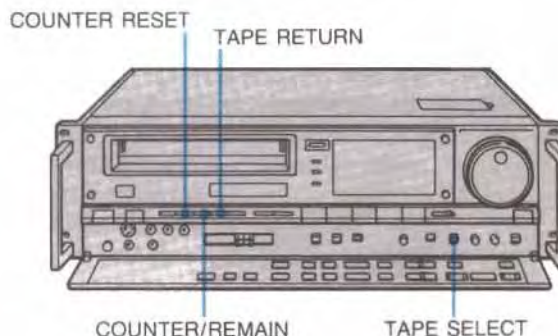

To Determine the Remaining Recording or Playback Time

- 1 Set TAPE SELECT inside the front panel according to the length of the tape being used.
L500: for EL-500, EL-250, L-500, L-250 and L-125 cassettes
L750: for L-750 cassettes
L830: for L-830 cassettes



- 2 During recording or playback, press COUNTER/REMAIN (or TAPE REMAIN on the Commander). The unit will calculate the remaining recording or playback time, and then the remaining time will be displayed.



During calculation
(15 seconds max.)

The remaining time will decrease as the recording or playback goes on.

To display the normal tape counter, press COUNTER/REMAIN (or TAPE REMAIN) again.

Notes

- The remaining time will be changed to “-H-M” when the unit is set to x1 reverse playback in **ⓑI**, **ⓑIS** or **ⓑII** mode, Betascan in **ⓑI** mode, or x2 reverse playback.
- The remaining time may not be calculated correctly if a blank portion of the tape (with no CTL signal recorded) is played back or the recorded tape speed is changed.
- The remaining tape counter will stop when the VCR is set to one of the following modes: stop, freeze picture, stop-action advance picture, slow motion picture, Betascan in **ⓑII** or **ⓑIII** mode, x2 reverse playback, and x1 reverse playback in **ⓑII** mode. If normal or x2 playback is activated after these modes are set, the counter may take several seconds to restore the correct display.

Notes on the accuracy of the remaining time counter

The accuracy of the remaining time counter will vary depending on the type of the tape being used.

- For commercially available recorded tapes, the counter will not indicate the exactly same time as the recorded time labeled on the tape.
- For damaged tapes and non-standard tapes, the accuracy will be degraded.
- At the beginning of a tape, especially when the tape has just been rewound, the remaining time will be calculated greater than the actual time (by several minutes max.).

Tape Return/Tape Return Play

Tape return

—To stop the tape at a particular point or play back from a particular point

- 1 During recording or playback, press COUNTER RESET at the point you want to locate later.
- 2 When recording or playback is finished, press **■** STOP and press TAPE RETURN.
The tape will be rewound or advanced close to the counter zero point.



Tape return play

—To start playback automatically from the counter zero point

Press **▶** PLAY after pressing TAPE RETURN. The indicator on **▶** PLAY will blink and the **◀◀** indicator will light when the tape is being rewound.

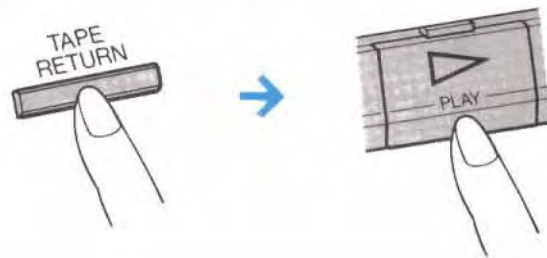

Note

The tape return and tape return play cannot be activated when the counter reading is within $\pm 0H00M04s$.

Time Search

The tape can be advanced rapidly or rewound for the required length of time. This function is useful for verifying the picture on the specified point of the tape.

To set the length of time, use the Wireless Commander.

1 Stop the tape.

2 Press TIME SEARCH on the Commander.

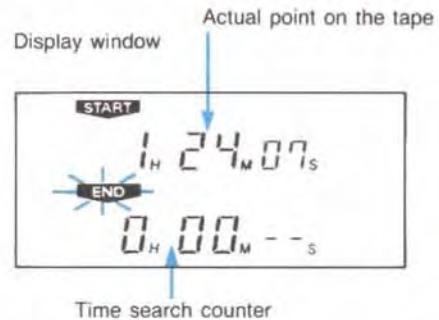
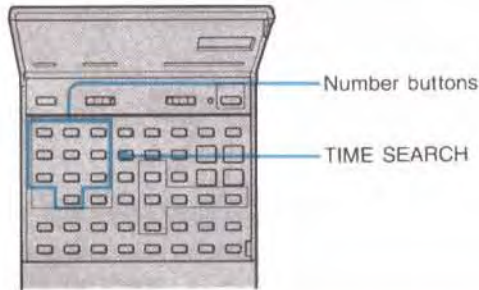

3 Set the time (hour and minutes) for which you want to advance or rewind the tape by pressing the number buttons on the Commander.

e.g. 1 hour 30 minutes

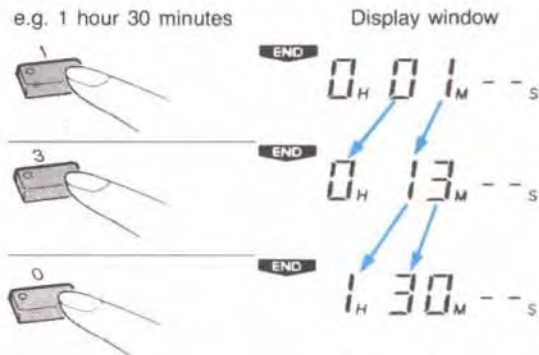

Data screen

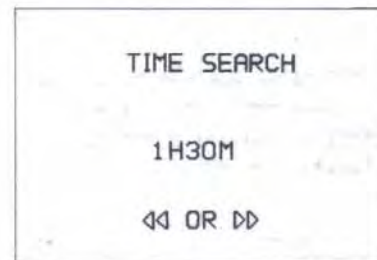

If an incorrect digit is input, press "0" twice and then press the correct number button.

4 Press ►► FF or ◀◀ REW.

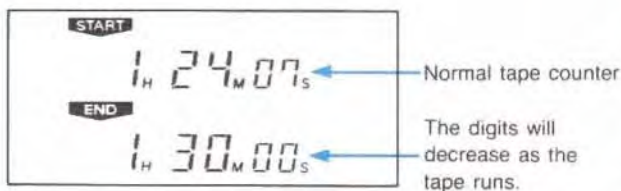

To start playback automatically from the assigned point
Press ►► PLAY after pressing ►► FF or ◀◀ REW. The indicator on ►► PLAY will blink.

To cancel the time search operation before pressing ►► FF or ◀◀ REW
Press TIME SEARCH again.

The tape will stop automatically at the time search counter zero point.
The time search counter will immediately change to the clock display.

Timer-Activated Recording

Eight recordings can be preset to be made between today and Saturday of the week after next.

Su	Mo	Tu	Today We	Th	Fr	Sa
			1	2	3	4
5	6	7	8	9	10	11
12	13	14	15	16	17	18
19	20	21	22	23	24	25
26	27	28	29	30		

This week: 8-11
Next week: 12-18
The week after next: 19-25

The date and clock must be set correctly. For the setting, see page 24.

Check before setting the timer

- Make sure the cassette tape is long enough to record all the programs.
- Be sure that the cassette is not in record prevention mode.
- Set the selectors and controls as in "Before recording" on page 29.

Buttons for timer setting

You can use the buttons and JOG dial either on the recorder or on the Wireless Commander.

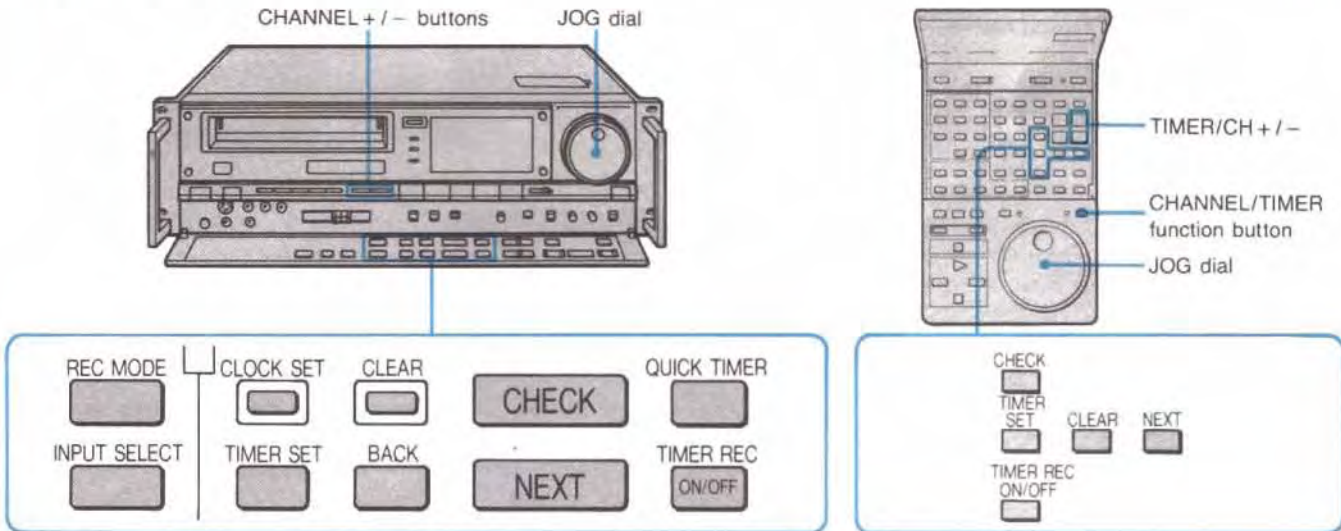

CHANNEL +/- buttons (or TIMER/CH +/- buttons on the Commander)

To set the week and day, the turn-on and turn-off times and the channel, press "+" to advance, and "-" to reverse.

JOG dial

To set the week and day, the turn-on and turn-off times and the channel, turn clockwise to advance, and counterclockwise to reverse.

When using the JOG dial on the Commander, first press the CHANNEL/TIMER function button.

NEXT button

Every time you press the NEXT button, the item to be set will blink.

BACK button

To change the item set in the previous step, press this button until the desired item blinks.

CLEAR button

To cancel the timer setting mode during setting, press this button to turn off the TIMER indicator.

Timer-Activated Recording

Data screen display for timer setting

To obtain the data screen display, press DATA SCREEN inside the drawer or on the Commander.

Week and day setting

The screenshot shows the following information:

- Current date and time: 11 16 1988 WED AM 9:00
- Days of the week: SU MO TU WE TH FR SA
- Days being set: 22, 23, 24 (with a bracket under '23')
- Timer set date: 25 26 27 28 29 30 31
- Week: 1 2 3 4 5 6 7
- Time program number: 8 . WEEK 1 WED 11/16 PII
- Channel: -- -- -- CH

Annotations:

- Current date and time: points to the top line.
- Indicates the day being set: points to the '23' in the second row.
- Timer set date: points to the '29' in the third row.
- Week: points to the '1' in the fourth row.
- Time program number: points to the '8' in the fifth row.

Hour setting

The screenshot shows the following information:

- Current date and time: 11 16 1988 WED AM 9:00
- AM hours (midnight to noon): AM 0 3 6 9 0
- PM hours (noon to midnight): PM 0 3 6 9 0
- Turn-on hour: 8 . WEEK 1 - WED 11/16 PII
- Turn-off hour: AM 8
- Channel: -- -- -- CH

Annotations:

- AM hours (midnight to noon): points to the 'AM 0 3 6 9 0' row.
- Indicates the hour being set: points to the '8' in the PM row.
- PM hours (noon to midnight): points to the 'PM 0 3 6 9 0' row.
- Turn-on hour: points to the '8' in the fifth row.
- Turn-off hour: points to the 'AM 8' in the sixth row.

Minute setting

The screenshot shows the following information:

- Current date and time: 11 16 1988 WED AM 9:00
- Minute: 0 15 30 45 60
- Turn-on minute: 8 . WEEK 1 - WED 11/16 PII
- Turn-off minute: AM 8:30
- Channel: -- -- -- CH

Annotations:

- Minute: points to the '0 15 30 45 60' row.
- Indicates the minute being set: points to the '30' in the minute row.
- Turn-on minute: points to the '8' in the fifth row.
- Turn-off minute: points to the 'AM 8:30' in the sixth row.

Timer Setting

Suppose you want to make a recording of channel 8 from 7:30 P.M. to 8:56 P.M. today (Wednesday, November 16).

Operation	Display window	Data screen
1 Press TIMER SET.	<p>Timer program number</p>	<p>Current date and time</p> <p>Timer program number</p>
2 Select REC MODE, III or II .	<p>Recording tape speed</p>	<p>Recording tape speed</p>
3 Set the week and day with +/– or JOG. (See “To set the week and day” on page 44. Then press NEXT.		
4 Set the turn-on hour with +/– or JOG. AM 12:00 = midnight PM 12:00 = noon Then press NEXT.		
5 Set the minute with +/– or JOG. Then press NEXT.		
6 Set the turn-off hour with +/– or JOG. Then press NEXT.		
7 Set the minute with +/– or JOG. Then press NEXT.		
8 Set the channel to be recorded with +/– or JOG. Then press NEXT.		
To preset another program, repeat steps 1 to 8. Up to 8 programs can be preset.		
9 Press TIMER REC.	<p>Preset turn-on time of program 1</p> <p>Current time</p>	<p>Timer recording standby indicator</p>

Recording will start at the preset time and will automatically stop when the recording is completed. The memory of the program will be erased if it is for only one day and the timer program numbers will advance one by one.

NOTICE:

ONCE THE **TIMER** INDICATOR HAS BEEN DISPLAYED, only the functions of CHECK and TIMER REC can be activated. For the usual manual operations, press TIMER REC again so that the indicator goes off, and then turn on the power.

Notes on timer setting

- To change the item set in the previous step, press the BACK button until the desired item blinks.
- Timer recordings of the signals input from the LINE IN 1 or LINE IN 2 jacks can be made. During timer setting, select the L1 or L2 LINE input with the INPUT SELECT button and skip step 8.
- Timer setting can be made during playback, if the recording tape speed for timer programs is the same as that of the on-going playback. The other tape speeds cannot be preset.
- REC MODE and INPUT SELECT can be set any time during timer setting. When a timer recording starts, the preset modes are selected automatically.

Troubles when TIMER REC is pressed

The cassette will be ejected automatically.

The cassette inserted is in record prevention mode (i.e. the red button is depressed for an **ED** Beta tape, or the safety tab is removed for a **FB** tape.)

The **TIMER** indicator disappears.

No cassette is inserted.

The tape is at its end.

The turn-on time has been set before the current time.

To set the week and day

The week and day indications change in the direction of the arrow, starting from today, when you press "+" or turn JOG clockwise; and in the reverse direction when you press "-" or turn JOG counterclockwise.

The day(s) you want the recording(s) made	Display window	Data screen
At the same time every day from Monday to Saturday	EVERY WEEK Mo Tu We Th Fr Sa	MON-SAT
At the same time every day from Monday to Friday	EVERY WEEK Mo Tu We Th Fr	MON-FRI
At the same time on the same day every week	EVERY WEEK Su ... Fr Sa	EVERY-SUN ... SAT
At the same time every day	Su Mo Tu We Th Fr Sa	EVERY-DAY
Only one day	THIS WEEK We Th ... Sa (today) NEXT WEEK Su ... Sa WEEK AFTER NEXT Su ... Sa	WEEK 1 WED THU ... SAT (today) WEEK 2 SUN ... SAT WEEK 3 SUN ... SAT

Before the Timer-Activated Recording Starts

To check the timer settings

Press CHECK.

Every time you press CHECK, each program will be displayed in the display window or the selected program number will blink on the data screen.

After checking the desired settings, press CHECK repeatedly until the current time appears in the display window.

To change the settings

- 1 Press TIMER REC. The **TIMER** indicator goes off.
- 2 Press CHECK to select the program to be changed.
- 3 Press TIMER SET.
- 4 Press NEXT until the item to be changed blinks.
- 5 Change the setting with + / - or JOG.
- 6 Press NEXT so that the tape counter and the current time appear in the display window.
- 7 Press TIMER REC again to reactivate the timer.

To erase the memory of a particular program

- 1 Press TIMER REC. The **TIMER** indicator goes off.
- 2 Press CHECK to select the program to be erased.
- 3 Press CLEAR. The memory of the program will be eliminated.
- 4 If other programs have been preset for recording, press TIMER REC again to reactivate the timer.

During Recording

To stop during the timer recording

Press TIMER REC. The recording will stop and the power will be turned off.

When the tape ends during timer recording

The tape stops but the tape will not be rewound.

The **STOP** and **PAUSE/STILL** buttons do not function during a timer recording.

Specific Notes on Timer-Activated Recordings

When the presets of your timer-activated recordings overlap

The recording of program 2 will begin before program 1 is finished.

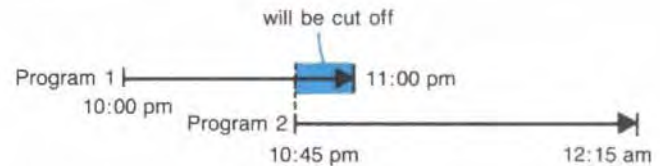

If the turn-on time of two programs are the same

The recording of the program having the lower program number will be made. The memory of the program having the higher number will be cleared.

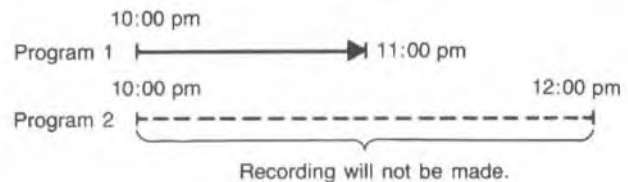

If the turn-on time of one program is the same as the turn-off time of another program

When a timer recording starts, the unit is set to recording pause mode 6 seconds before the preset turn-on time. The pause mode is released exactly at the preset turn-on time and recording starts approximately 1 second later. Therefore, the end of the first program will not be recorded for 6 seconds. Both recordings, however, will be made smoothly.

If a power interruption occurs before a timer recording

The clock will stop and "AM 12:00" will blink. This means that the memory of the timer programs has been completely erased. Reset the clock and timer programs.

A short power interruption of less than approximately 10 minutes will not affect the memory. The clock will show the correct time and the timer programs will be performed.

If the power was interrupted during a timer recording or quick timer recording

Recording will stop and the power will be turned off. If the interruption was less than approximately 10 minutes, the recording will resume.

Note

After a power interruption, SUPER BETA is automatically set to ON even if it was set to OFF. Press SUPER BETA inside the drawer to turn off the SuperBeta indicator.

Quick Timer Recording

Use this function to begin recording a program immediately. You can start timer recording just by pressing QUICK TIMER.

The recording duration can be set for up to 5 hours by 30 minutes. You can also use this function to stop the non-timer recording by presetting the recording duration. Before operating, set the clock.



To Use Quick Timer from the Tape Stop Mode

Make sure the following:

- A cassette is inserted.
- INPUT SELECT is set TUNER (i.e. TUNER indicator appears.)
- REC MODE is **BI** or **BIII**.
- The **TIMER** indicator is not displayed. (Quick timer does not function in timer recording standby mode. To cancel, press TIMER SET.)

- 1 Press QUICK TIMER.
The power will be turned on, if it was turned off.

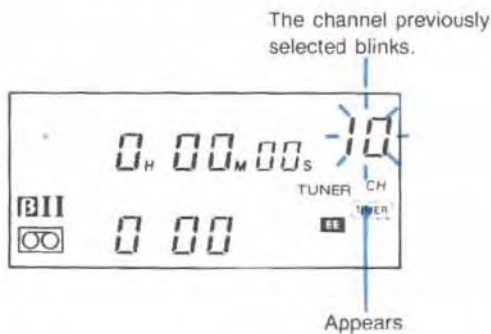

If you do not advance to the next step within 30 seconds, the power will be turned off.

- 2 Choose the channel to be recorded with JOG or CHANNEL + / -.
- 3 Press QUICK TIMER so that the recording starts. Now decide the recording duration.

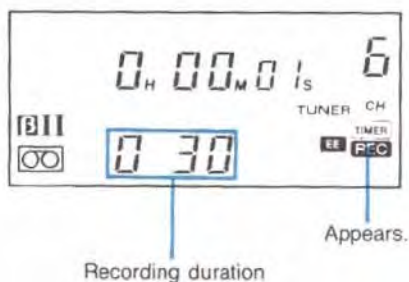

Recording duration indication

Every time you press QUICK TIMER, the recording duration indication changes as follows:

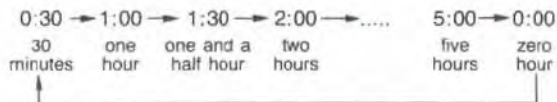

When the recording starts

The duration indication decreases minute by minute to 0:00 and the power will be turned off automatically about 30 seconds after the recording has finished.

When the tape reaches its end during quick timer recording

The recording stops and the power is turned off. The tape will not be rewound.

To Use Quick Timer While Recording

By pressing QUICK TIMER, you can set the duration so that the recording stops and the power turns off after the preset duration.

Once the quick timer recording has started

- Only the following function buttons can be activated:
- QUICK TIMER..... to change recording duration
 - TIMER REC..... to interrupt quick timer recording
 - II/III PAUSE/STILL... to stop quick timer recording momentarily
 - CHECK..... to check timer programs preset
 - COUNTER RESET..... to reset the tape counter to zero
 - INDEX MARK..... to record an index signal

Index Function

The desired program can be easily located by the index signal marked on the tape.

To Mark Index Signals Automatically

An index signal is automatically marked on the tape when ● REC is slid to the right or when a timer recording starts.

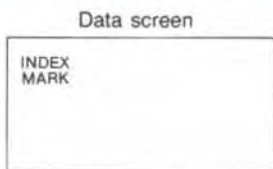

Blinks while the index signal is being marked.

Notes

- Index signals will not be marked automatically on the tape when the recording is started by releasing the recording pause or playback pause mode.
- The index function operates also with the index signals marked using the index function of other recorders.

To Mark Index Signals Manually

Index signals can be marked at any desired point on the tape during recording, timer recording or normal playback.

At the point where an index signal is to be marked, press INDEX MARK.



Blinks while the index signal is being marked.

Notes

- An index signal will be recorded for the following period according to the tape speed.
ⓂI, ⓂIS : Approx. 4 sec.
ⓂII : Approx. 8 sec.
ⓂIII : Approx. 12 sec.
- The sound recorded on the conventional audio track will be muted while the index signal is being marked during playback, but the recording will not be affected.
- Index signals can be marked on cassette tapes having the record prevention system engaged (including commercially available prerecorded video tapes).
- An index signal cannot be marked on the unrecorded portion of the tape where no control signal has been recorded.
- An index signal may not be marked immediately before a point on the tape where the tape speed (**ⓂIS**, **ⓂII** or **ⓂIII**) changes.

Index Scan

—To play back the beginning of each program in sequence

- 1 Insert a cassette that has index signals marked.
- 2 Press INDEX once.



Blink alternately.

- 3 To scan the previous programs, press ◀◀ REW. To scan the programs ahead, press ▶▶ FF. The tape will be rewound or rapidly advanced to the next index signal marked.

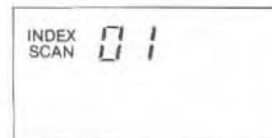

Blink simultaneously during scanning.



The tape will be played back for approximately 10 seconds, and then rewound or advanced to the next index signal.

Every time an index signal is detected and playback begins, the displayed index number increases.

- 4 At the desired program, press ▶ PLAY. Normal playback of that program will begin.

Index Search

—To locate the desired program

You can locate the desired program and play it back automatically by designating the number of its index signal. Up to the 19th index signal from the present position on the tape can be located.

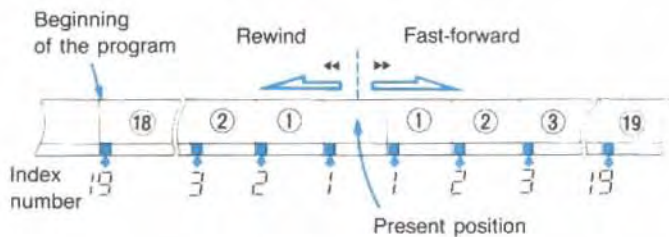

- 1 Insert a cassette that has index signals marked.
- 2 Press INDEX several times until the index number of the desired program is displayed.
For instance, to locate the second program ahead, two index signals should be detected, so press INDEX until "2" is displayed. On the other hand, to locate the second program behind, three signals should be detected, so press the button until "3" is displayed.

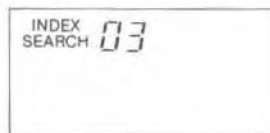

Lights steadily.

- If you enter an incorrect index number, press ■ STOP to reset the display.
- 3 To locate a previous program on the tape, press ◀◀ REW.
To locate a program ahead, press ▶▶ FF.

The tape will be rewound or rapidly advanced. Every time an index signal is detected, the displayed number will decrease. When the number reaches 0, playback of your desired program will begin.

Notes

- The index scan and index search can be activated during playback, as well as from stop mode.
- While the index signals are being scanned or located, the recorder is set to EE mode.
- If the tape is rewound to the beginning during index scan or index search, playback will begin automatically.
- If the tape reaches the end during index scan or index search, the tape will be rewound automatically.

When the desired program cannot be played back with the index function

Is there a space of more than 2 minutes between two index signals? If there is more than one index signal marked within an interval of 2 minutes of the normal tape-run, the mechanism may not function properly.

To Erase Index Signals

Erasing while index scanning—To erase the index signals in sequence

- 1 Stop the tape with ■ STOP.
- 2 Press INDEX once.
- 3 Press ◀ REW or ▶ FF.
The tape will be rewound or rapidly advanced to the next index signal and playback will begin.
- 4 Within approx. 10 seconds, while the tape is being played back, press INDEX ERASE.

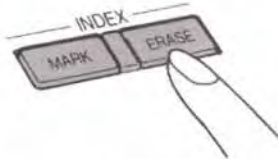

Blinks, while the index signal is being erased.



Lights steadily.

After the erasure, index scan will resume. At each index signal located, press INDEX ERASE.
To stop index scanning, press ■ STOP.

Notes

- Press INDEX ERASE more than 2 seconds after the playback starts.
- The index signal cannot be erased if it is recorded immediately after an unrecorded portion on a tape, or on a portion where the recording tape speed has been changed or two recordings have been made continuously.
- If the playback picture is distorted during index erasing, immediately stop the tape with ■ STOP. The index signal at the distortion cannot be erased.
- While an index signal is being erased, the sound recorded on the conventional audio track is not heard, but it will not be erased.

Erasing while index searching—To erase a particular index signal

- 1 Stop the tape with ■ STOP.
- 2 Press the INDEX button several times until the number of the index signal to be erased is displayed.
- 3 Press ◀ REW or ▶ FF.
The tape will be rewound or rapidly advanced until the designated index signal is located, and playback will begin.
- 4 Within approx. 10 seconds, while the tape is being played back, press INDEX ERASE.

While the index signal is being erased



Blinks.

After the erasure, normal playback will begin.

Beta Hi-Fi Audio Recording

Recording from Your Audio System

To connect the VCR to your audio system, see page 19. Set the switches as shown below. To start recording, insert a cassette and slide ● REC to the right.

Manually adjust REC LEVEL so that the first red element lights up only at the highest signal level.

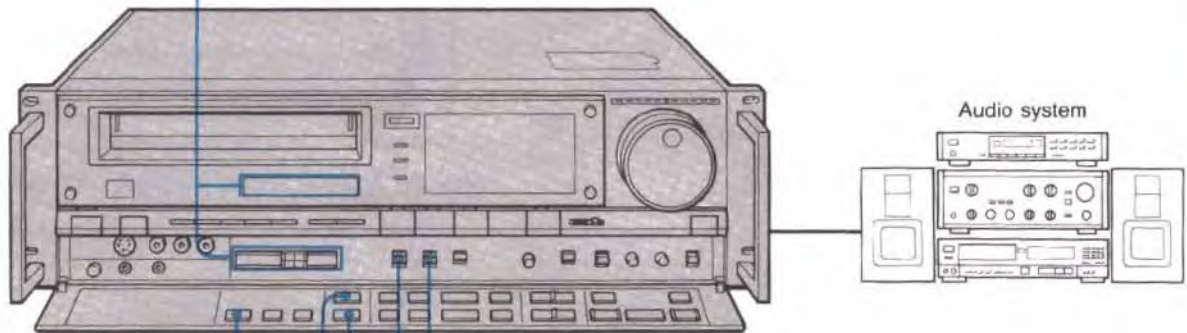
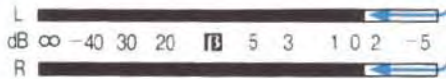

SUPER BETA: ON
(for IB tape only)

REC MODE: IB I or IB III

INPUT SELECT: LINE L1 or L2
(according to the line inputs connected to the audio system)

MPX FILTER:
Normally set to OFF.
When recording from an FM tuner set to ON. (If your FM tuner has an internal MPX filter, set to OFF.)

AUDIO MONITOR: BETA HI-FI and STEREO

What is Beta Hi-Fi Recording?

In conventional recording, audio signals are recorded on the audio track and video signals on the video track. In Beta hi-fi recording, audio signals are recorded on the video track together with the video signals using 2 rotary video heads.

The Beta hi-fi audio signals are frequency-modulated and recorded on 2 channels, so that you can record a stereo program with sound quality far superior to that of the conventional audio recording.

Beta hi-fi recording pattern on the video tape

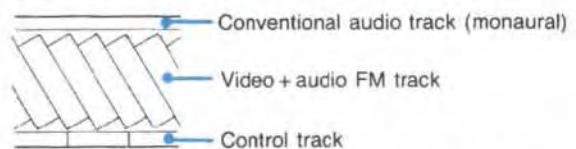

This recorder automatically records audio signals on the video track (Beta hi-fi recording) and on the conventional audio track at the same time, so that these tapes can also be played back on any ordinary video cassette recorder without a Beta hi-fi system.

FM Simulcast Recording

By connecting an FM tuner to the LINE IN 1 or 2 AUDIO jacks besides the CATV cable connection, you can record a cable TV program with stereo sound, such as MTV (music TV), whose audio signals are divided into the FM tuner from the cable.

For FM simulcast recording, press INPUT SELECT so that "SIMUL" appears in the display window.

Set the other switches and controls as in "Recording from Your Audio System" on page 50.

The picture of the cable TV program and the sound from the FM tuner are recorded on the video track. The sound of the cable TV program is recorded on the conventional audio track.

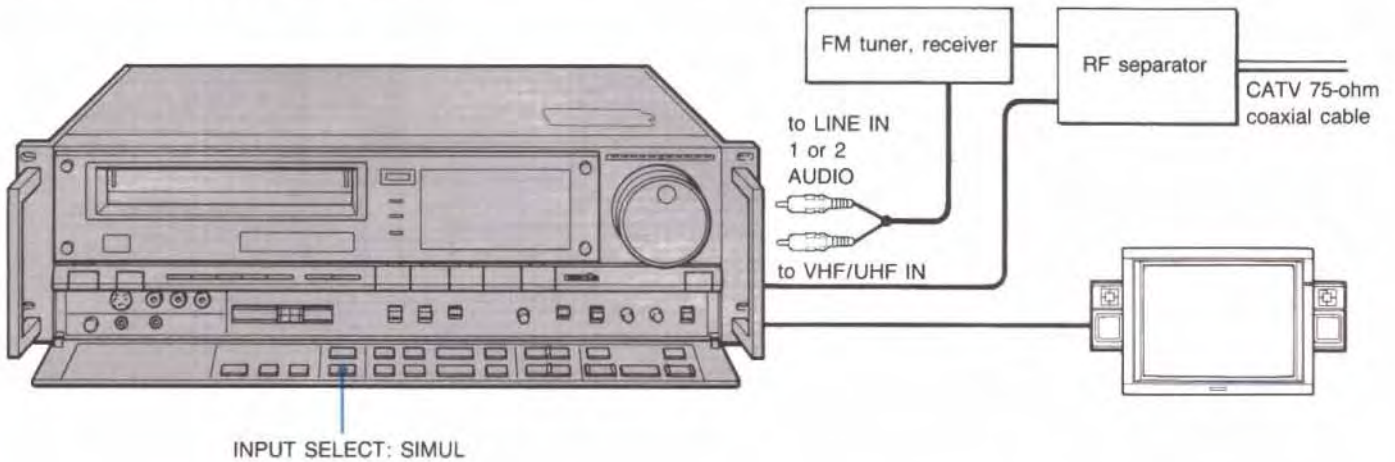

Timer-Activated FM Recording

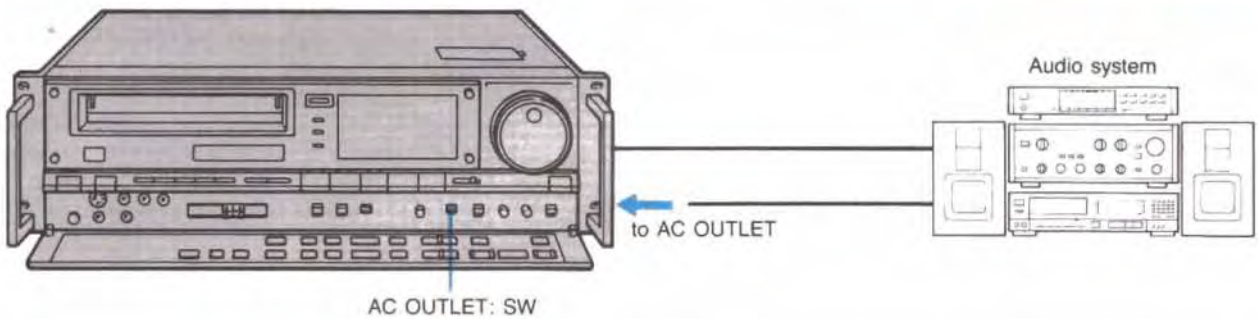

- 1** Connect the audio system to the AC OUTLET on the rear of the recorder.
- 2** Set the AC OUTLET selector to SW.
- 3** Turn on the recorder and the audio system.
- 4** Tune in the desired FM station on the FM tuner.

- 5** Insert a cassette and set the timer on the recorder. See page 43. The setting of the controls is the same as in "Recording from Your Audio System" on page 50.

At the preset turn-on time, the recorder and the audio system will be turned on and recording will start.

PCM Recording and Playback

Connect a PCM digital audio processor as shown below.

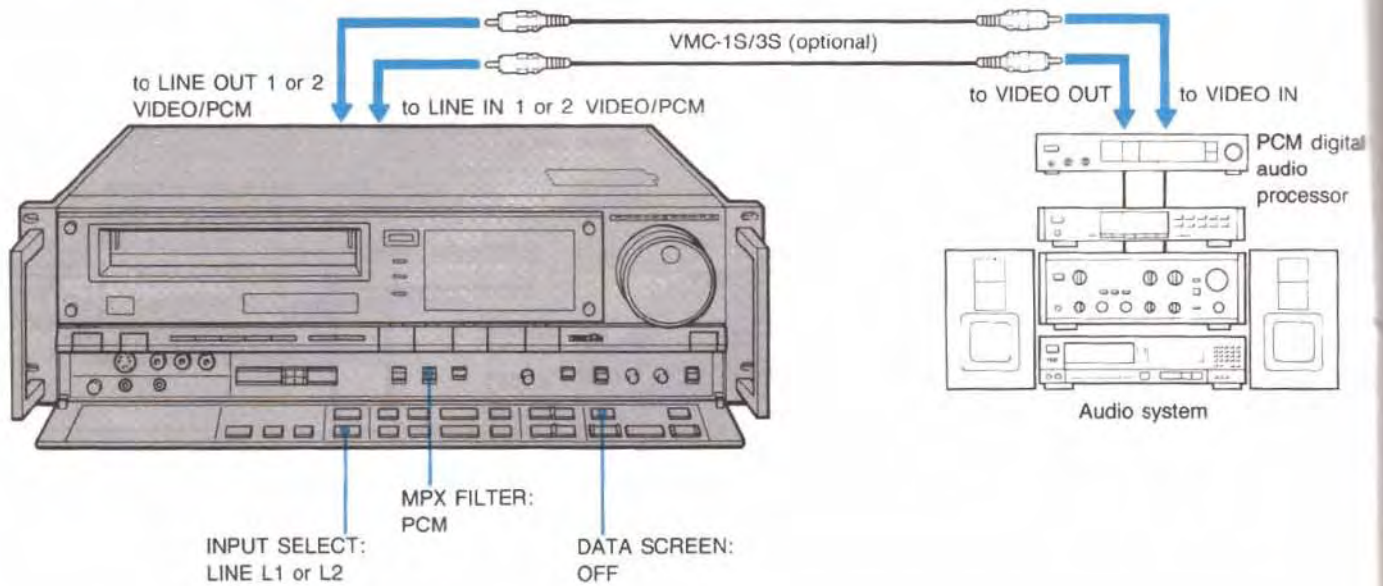

For optimum results, use a video cassette with a model number of L-500 or below (EL-500, EL-250, L-500, L-250, L-125, etc.) and select the tape speed **II**.

For details, refer to the instruction manual furnished with the digital audio processor.

Notes

- If you intend to play back on other non-SuperBeta VCRs, or on a VCR with SUPER BETA set to "OFF", set SUPER BETA to "OFF" when making your PCM recordings. Otherwise, the sound may be muted.
- When MPX FILTER is set to PCM and playback starts, the data screen display will disappear automatically. It will be recalled when MPX FILTER is set to ON or OFF after the playback.

Tape Editing

To edit a home movie tape, you need two video cassette recorders.

If your other VCR is a Sony VCR equipped with control terminals, see page 55 for further systematic operations.

CAUTION

Television programs, films, video tapes and other materials may be copyrighted. Unauthorized duplication of such material may be contrary to the provisions of the copyright laws.

Note

Avoid repetition of editing tapes, as the picture and tone quality will be impaired noticeably for newly edited tapes.

To Edit a Home Movie Tape from Another VCR to This VCR

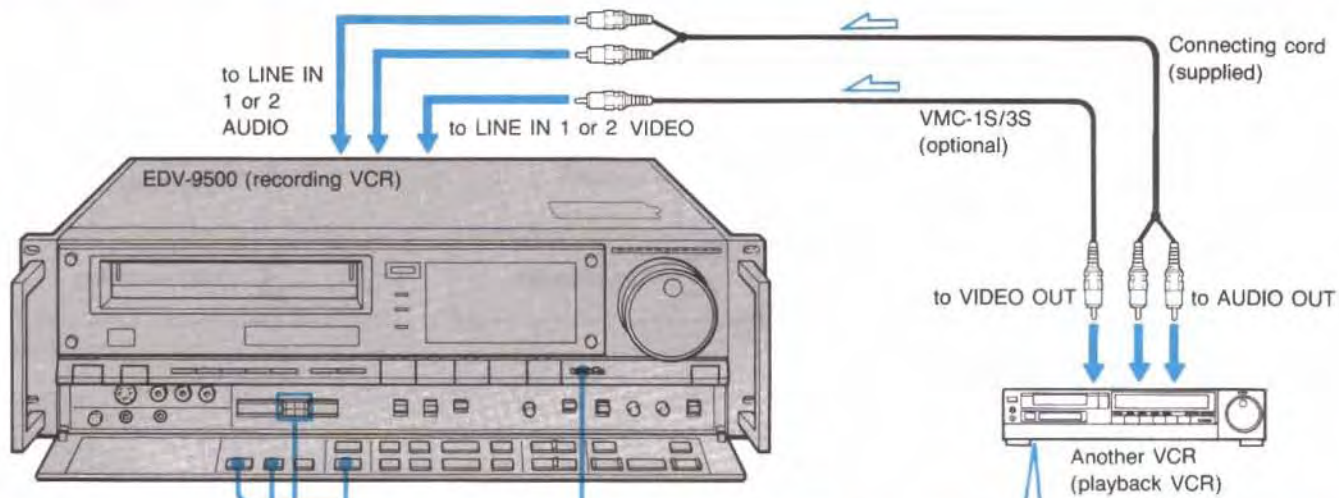

1

Check the following:

- REC LEVEL: [5]
- SUPER BETA: ON (for **IB** tape only)
- EDIT: ON*
- INPUT SELECT: LINE L1 or L2 (according to the line inputs connected to the other VCR)

*After editing, set to OFF.

3

Start recording.

2

Insert a recorded cassette and start playback.

← Signal flow

This unit's flying erase head allows continuous recordings without disturbance. When editing with another Betamax VCR, use this unit for editing and the other VCR for playback.

When your VCR is equipped with an S VIDEO OUT connector

Connect the LINE IN 1 or 2 S VIDEO connector of this VCR to the S VIDEO OUT connector of the other VCR in place of the connection to the phono-type VIDEO/PCM jack. If LINE IN 1 S VIDEO is used, set the V INPUT SELECT switch to S VIDEO. With this connection, better picture quality is obtained.

Note

Do not connect another VCR to both the LINE IN and LINE OUT jacks of this VCR. This may cause hum noise.

To edit a Home Movie Tape from This VCR to Another VCR

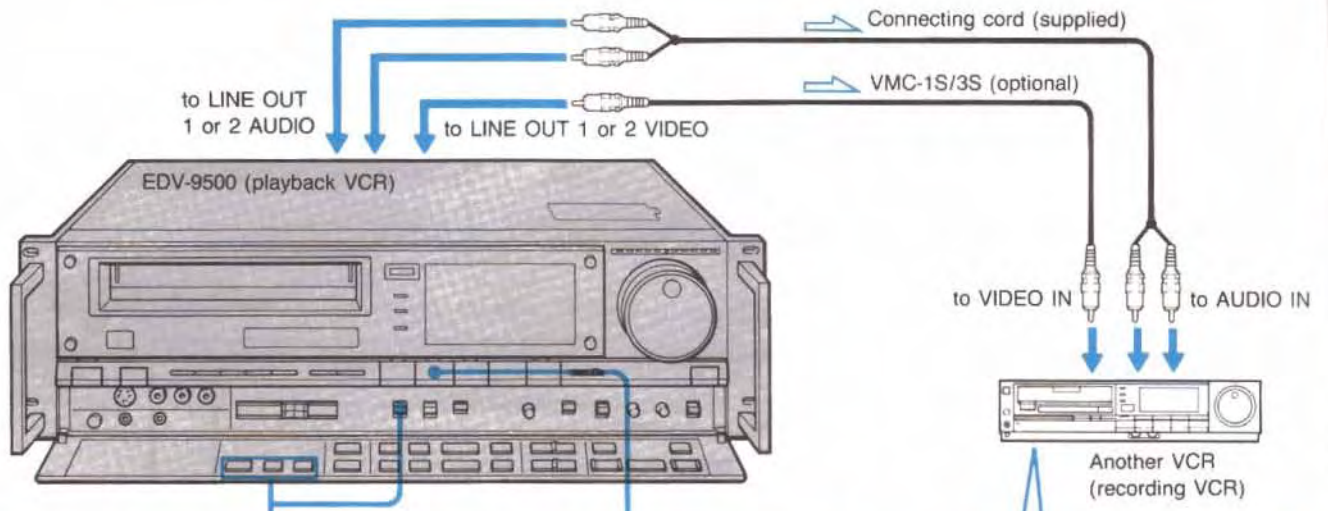

- 1** Check the following.
- SUPER BETA: ON (for **B** tape only)
 - EDIT: ON*
 - STEREO L/R: STEREO
 - AUDIO MONITOR: BETA HI-FI (To record the SAP sound, set to NORM.)

*After editing, set to OFF.

2 Start playback.

3 Start recording.

➡ Signal flow

Various Tape Editing Modes

This VCR is equipped with various functions for easy and highly-accurate tape editing. If another Sony VCR with intercomponent control terminals is used with this VCR, further editing facilities are available.

Equipment to be used with	Available editing method	When to use	Page
Another EDV-9500 or Sony SL-HF1000 (equipped with a control T jack)	Automatic Assemble Editing with Pre-roll	<ul style="list-style-type: none">• To record up to 8 scenes successively	59
	Automatic Insert Editing with Pre-roll	<ul style="list-style-type: none">• To replace part of a pre-recorded tape with a new scene and sound	63
Sony VCR equipped with a control terminal	Automatic Assemble Editing (without Pre-roll)	<ul style="list-style-type: none">• To record up to 8 scenes successively	59
Video camera, another VCR, tape recorder, microphone or any other insert source player	Manual Insert Editing	<ul style="list-style-type: none">• To replace part of a pre-recorded tape with a new scene and sound• To add music or narration onto a pre-recorded tape	68

Editing with Another EDV-9500 or SL-HF1000

What is a Pre-roll?

"Pre-roll" is to run the original tape and a tape to be edited for several seconds before the preset editing starting point. During this period of pre-roll, two VCRs are fully controlled for synchronized operations, thus making possible highly accurate editing with a maximum error of 3 frames per scene.

Pre-roll operation is carried out in automatic insert editing and automatic assemble editing, only when another EDV-9500 or Sony SL-HF1000 is connected to this VCR through the control T jacks.

Operation chart of pre-roll editing

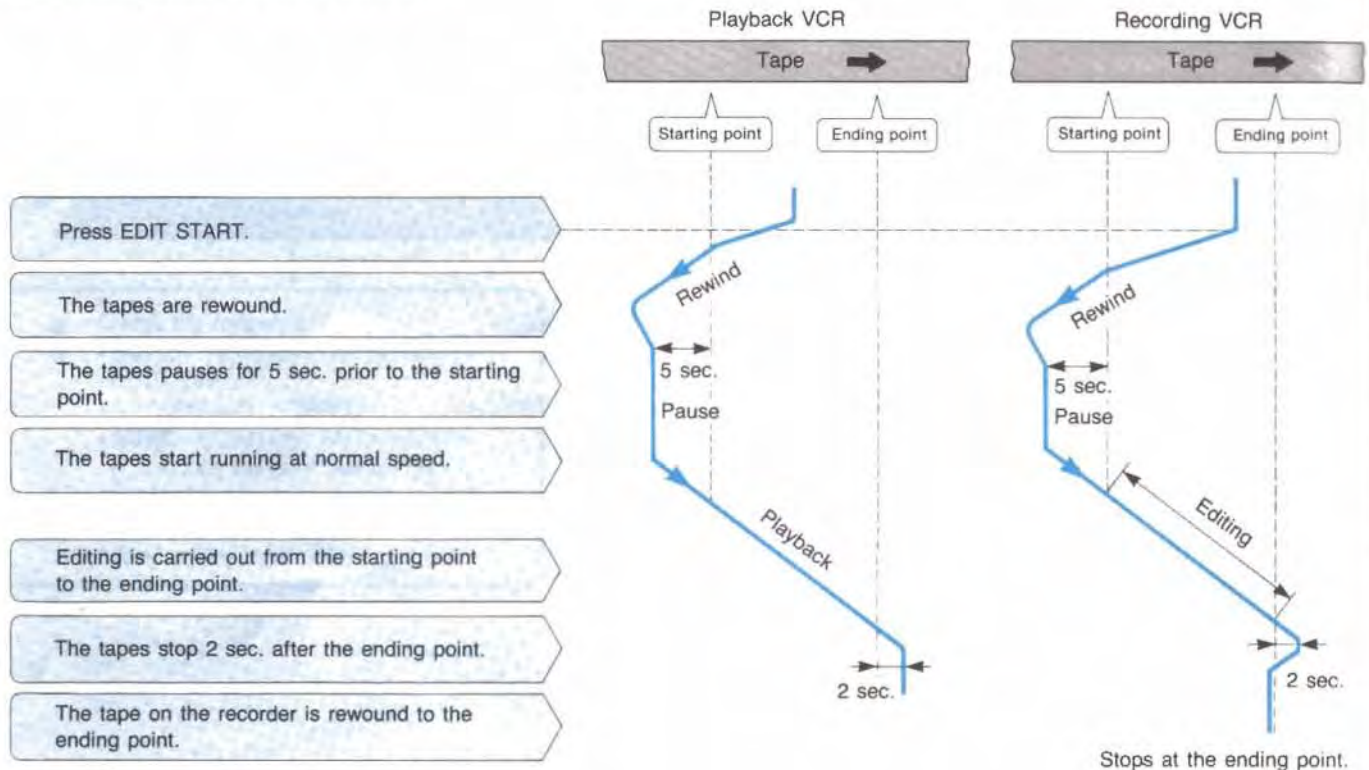

Notes

- For pre-roll operation, control signals should have been recorded for at least 15 seconds before the editing starting points on both tapes. When using an unrecorded tape for editing, record the control signal before editing, simply by setting the VCR to recording mode without connecting video/audio signals.
- Pre-roll editing will be carried out in the tape speed mode in which the control signal has been recorded on the tape, regardless of the current REC MODE setting. Therefore, tapes recorded in the **PAUSE** or **PAUSE** mode cannot be used for pre-roll editing.
- After the 5-second pause in pre-roll operation, the picture of the recording VCR will momentarily flicker. This is due to the framing servo, and does not affect the edited picture.

Note on tape transport after the ending point

In automatic assemble editing, recording continues for two seconds after the editing ending point. Then, the tape will be rewound to the ending point and will pause. On the other hand, in automatic insert editing, recording stops at the editing ending point. Then the tape will be played back for two seconds, rewound to the ending point, and will pause. For this reason, if the automatic assemble editing is carried out on part of a pre-recorded tape, the part of the tape immediately after the newly inserted scene will be erased and the picture will be distorted. Use insert editing to insert a scene between recordings.

Connecting two EDV-9500 VCRs

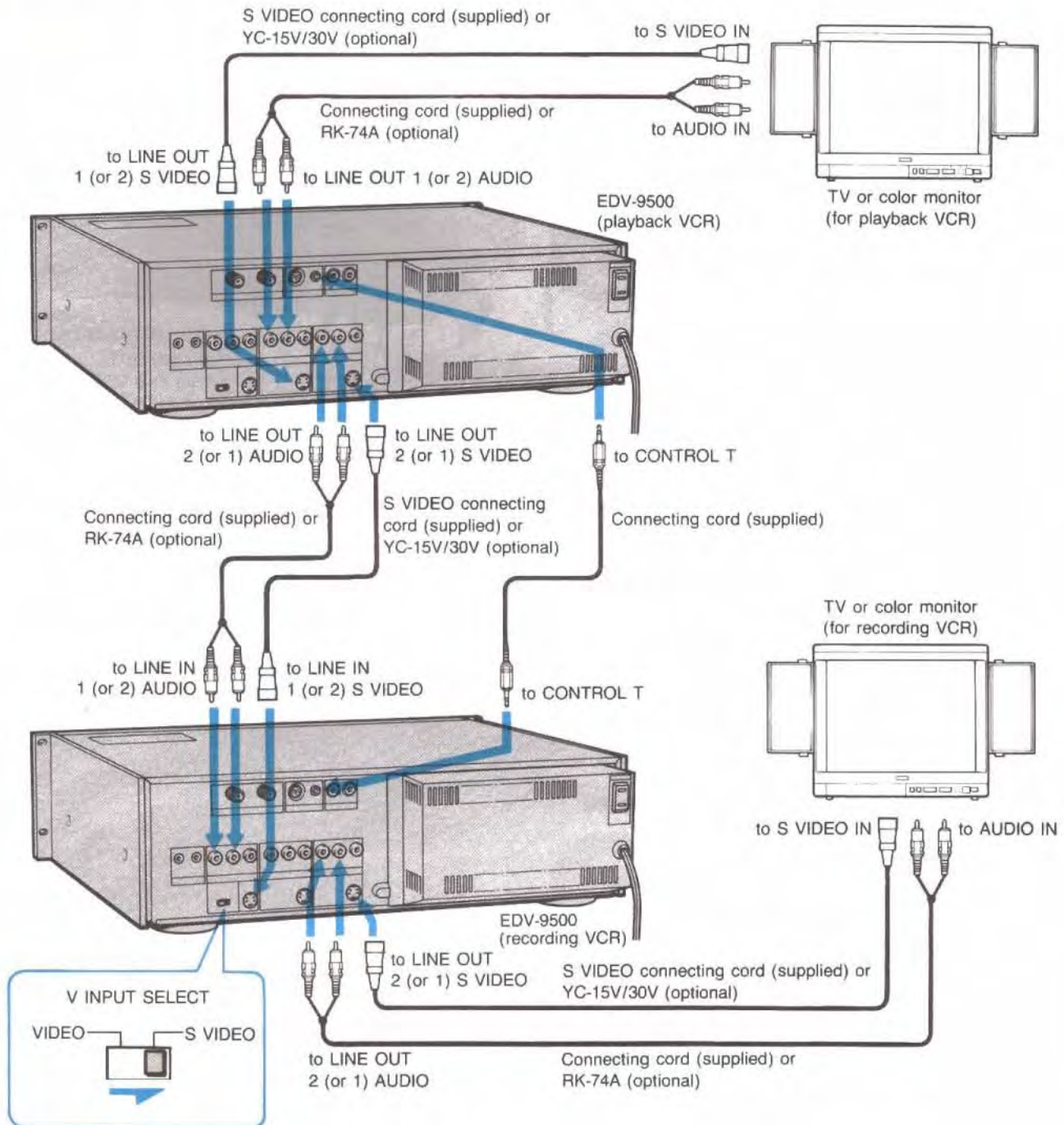

To connect a Sony SL-HF1000 to this VCR

The SL-HF1000 is not equipped with the S VIDEO IN/OUT connectors.

Connect the two VCRs through the phono-type LINE IN/OUT VIDEO jacks.

Notes on S VIDEO connection

- When using the LINE IN 1 S VIDEO connector, set the V INPUT SELECT switch to S VIDEO.
- When the LINE IN 2 S VIDEO connector is used, the phono-type LINE IN 2 VIDEO jack is disconnected automatically.

Connection Using one Monitor TV for Two VCRs

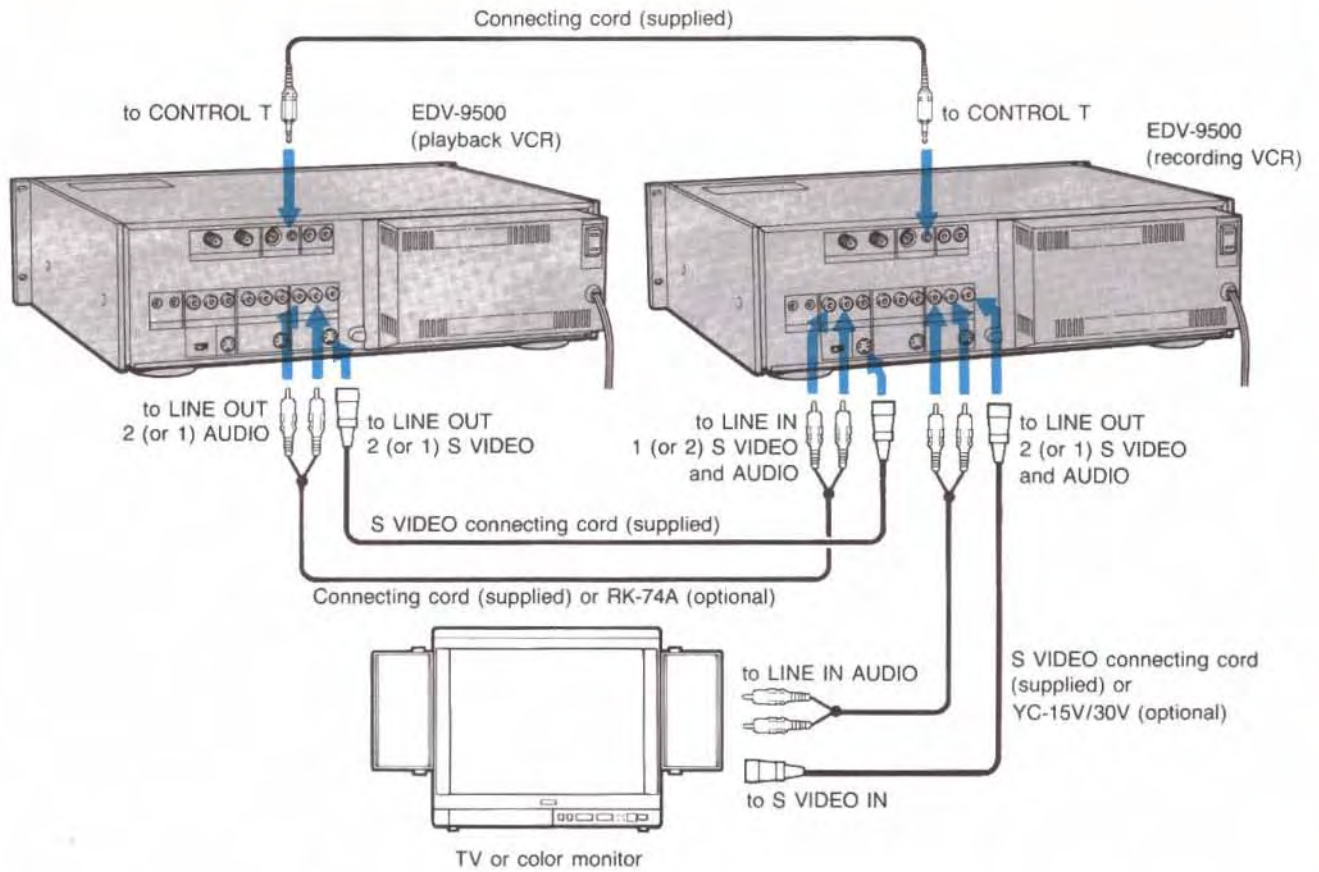

To view the picture of the playback VCR while the recording VCR is in the playback mode, press EE on the recording VCR.

Automatic Assemble Editing

Up to 8 desired scenes of the original tape can be "assembled" (recorded) onto another tape successively. The video, audio and control signals are edited together. Simply press one button to start the assemble editing. Recording start/stop is activated automatically, synchronized with playback start/stop.

Original tape (in the playback VCR)

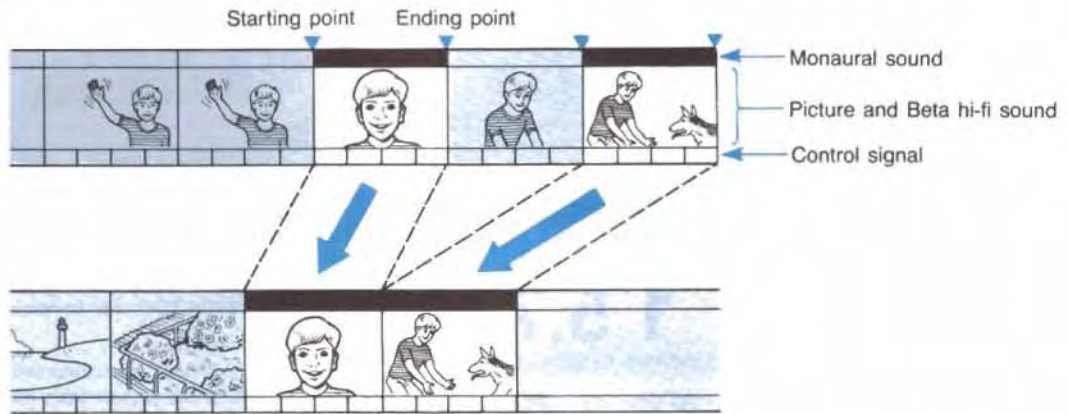

Notes

- Automatic assemble editing cannot be made from an original tape recorded in **BI** or **BIS** mode, when this VCR is used as the recording VCR.
- If editing is made from an original tape with **BI** and **BII** recordings mixed, the picture and sound may be distorted at the starting and ending points of editing.

For pre-roll operation, control signals should have been recorded for at least 15 seconds before the starting points of the automatic assemble editing on both tapes. If required, record the control signal before operating the automatic assemble editing.

Operation

For assemble editing, assign the editing points on the playback VCR.

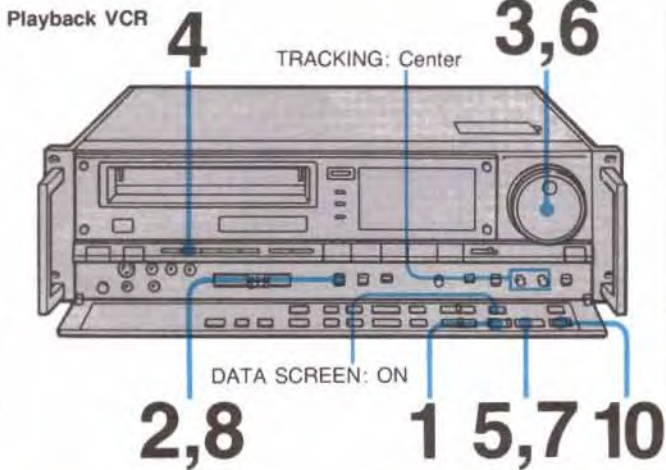

The item to be set will blink in the display window and on the data screen.

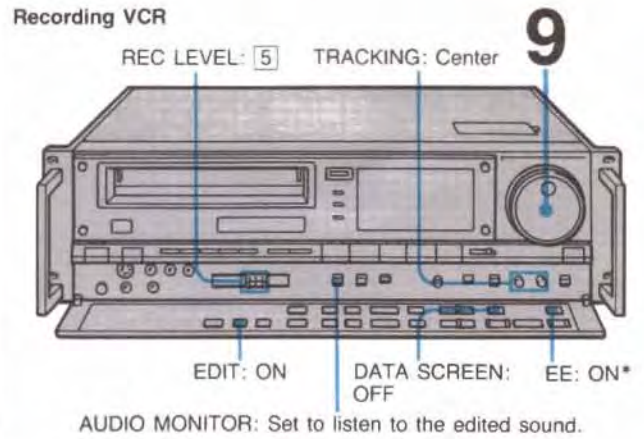

*When a monitor TV is not connected to the playback VCR only, press EE to view the picture from the playback VCR.

- 1** Insert the original cassette (edit source cassette) into the playback VCR and press ASSEMBLE. The EDIT switch is automatically set to ON and the EDIT indicator lights.

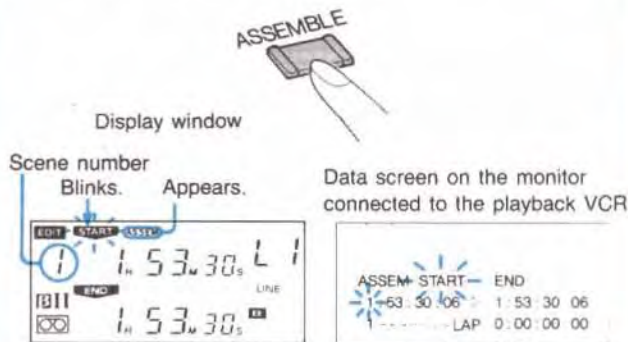

- 2** To listen to the sound while editing, set AUDIO MONITOR to NORM. The sound recorded on the conventional audio track will be heard while JOG/SHUTTLE is being turned.

- 3** On the playback VCR, locate the starting point of scene 1 observing the playback picture, and set the VCR to playback pause mode. For accurate searching, use JOG/SHUTTLE.

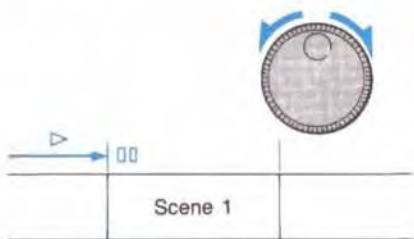

- 4** Press COUNTER RESET. The starting point of scene 1 is registered as counter zero.

- 5** Press MARK.

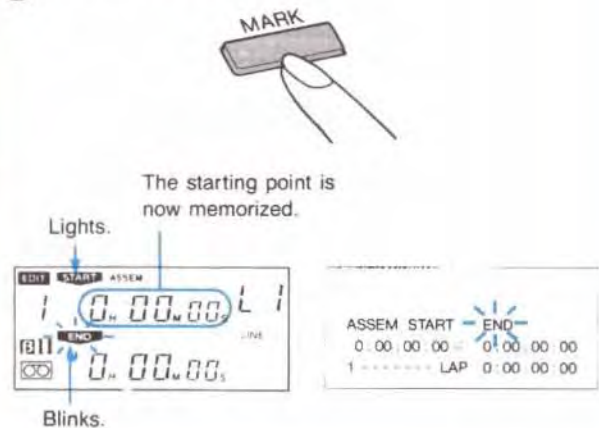

- 6** Locate the ending point of scene 1 and set the playback VCR to playback pause mode.

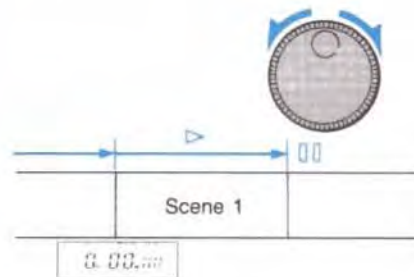

7 Press MARK.



Lights.



The ending point is now memorized.

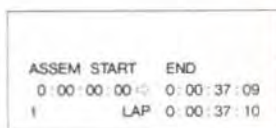

after a second

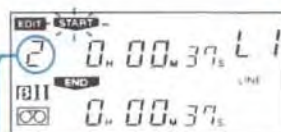

Scene 2

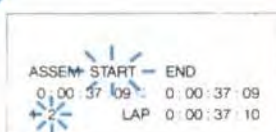

8 For other scenes, repeat steps 3, 5, 6 and 7 to set the starting and ending points in the memory. Up to 8 scenes can be preset.

e.g. When 6 scenes have been preset

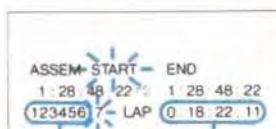
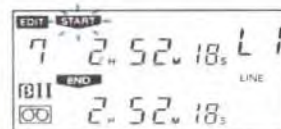

Scenes preset

Shows the total duration of all the preset scenes.

9 On the recording VCR, locate the point on the tape where you want to start editing and set the VCR to **playback pause mode** (or recording pause mode when the recording VCR is not connected through the CONTROL T jacks).

- When editing from the beginning of the tape, set the starting point where the tape has advanced for 15 seconds or more from the beginning.

10 Press START on the playback VCR. Automatic assemble editing will start. The scenes will be edited automatically in the preset order.



When all the scenes have been edited, both VCRs will be set to playback pause mode.

To stop the automatic assemble editing momentarily, press **II/PAUSE/STILL**. To resume the editing, press **START**.

To change the previously set editing points during **presetting**, press **BACK** until the desired item blinks, and then locate the correct point and press **MARK**.

To cancel the automatic assemble editing mode, press **ASSEMBLE**. The memory of the preset scenes will be erased.

Notes

- Automatic assemble editing is not possible for the two scenes between which searching time takes more than 8 minutes.
- Automatic assemble editing will not be carried out if the recording VCR is set to assemble editing mode.

For Accurate Presetting of Editing Points

- If you stop the tape with **STOP** when presetting an editing point, the editing point will be shifted. To correct the shift, locate the starting point of scene 1 again and press **COUNTER RESET**.
- The preset starting and ending points may shift slightly after the tape has been advanced rapidly, stopped and rewound repeatedly for locating those points.

To minimize the shift, proceed as follows:

- 1 After locating the starting point of scene 1, press **COUNTER RESET** to register that point as counter zero.
- 2 Preset all the required scenes.
- 3 Locate the starting point of scene 1 again, accurately to the extent of a frame, by observing the playback picture.
- 4 Press **COUNTER RESET**.
- 5 Press **START** to start the automatic assemble editing.

After Presetting the Editing Points

—before pressing START

To check the preset editing points

Press CHECK.

Every time CHECK is pressed, the starting and ending points of each scene will be displayed and the scene number will blink.

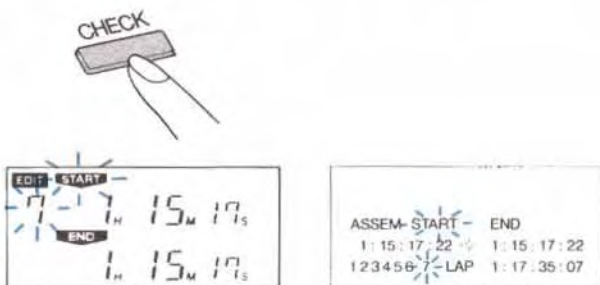

To change the editing points

- 1 Press CHECK repeatedly until the desired scene number blinks.
- 2 Press ASSEMBLE.
The START indicator will blink.
- 3 Locate the new starting point using JOG/SHUTTLE, while observing the playback picture, and set the unit to playback pause mode.
(If the starting point is not to be changed, skip this step.)
- 4 Press MARK.
The END indicator will blink.
- 5 Locate the new ending point using JOG/SHUTTLE and set the unit to playback pause mode.
(If the ending point is not to be changed, skip this step.)
- 6 Press MARK.

Automatic Insert Editing

You can easily insert (re-record) new sound and/or picture onto a pre-recorded tape. Assign the editing points on the recording VCR and press one button to start automatic insert editing. Playback start/stop is activated automatically, synchronized with recording start/stop.

"Audio insert", "video insert", or "audio and video insert" can be made with this operation.

Insert source tape (in the playback VCR)



Tape after insertion (in the recording VCR)

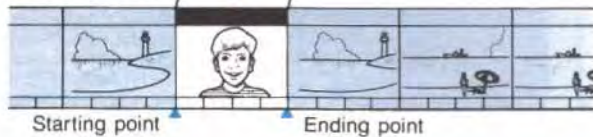

Audio/Video Insert Modes

	Insert onto a Beta hi-fi recorded tape	Insert onto a non Beta hi-fi recorded tape
Audio insert	<p>Newly inserted monaural sound</p> <p>Original picture and Beta hi-fi sound</p>	<p>Newly inserted monaural sound</p> <p>Original picture</p>
Video insert	<p>Original sound</p> <p>Newly inserted picture and Beta hi-fi sound</p>	<p>Original sound</p> <p>Newly inserted picture and Beta hi-fi sound</p>
Audio/video insert	<p>Newly inserted monaural sound</p> <p>Newly inserted picture and Beta hi-fi sound</p>	<p>Newly inserted monaural sound</p> <p>Newly inserted picture and Beta hi-fi sound</p>

Notes on the recording at the editing points

- At the starting and ending points, recording on the conventional audio track will be muted for a few seconds.
- A noise may be heard at the starting and ending points of the editing made when an edited tape is being played back.

For pre-roll operation, control signals should have been recorded for at least 15 seconds before the insertion starting points on both tapes. If required, record the control signal before insert operation.

Notes

- Automatic insert editing cannot be made from an insert source tape recorded in **BI** mode.
- When the video insert is made onto a Beta hi-fi recorded tape, the previously recorded Beta hi-fi sound will be erased.

Tracking adjustment

Play back the tape on which insertion will be made and adjust the tracking at the portions on the tape near the starting and ending points of insertion precisely on the recording VCR.

Operation

For automatic insert editing, assign the editing points on the recording VCR.

Playback VCR

AUDIO MONITOR: Select the sound to be edited. **7**

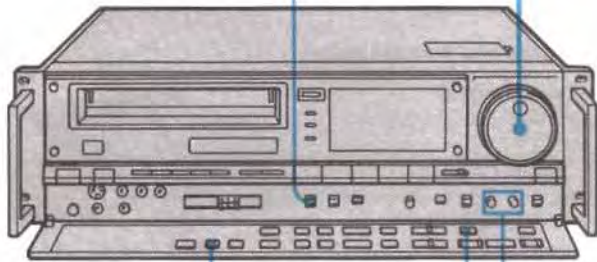

EDIT: ON
(i.e. EDIT lights)

DATA SCREEN: OFF

TRACKING: Adjust for the best possible picture.

Recording VCR

The item to be set will blink in the display window and on the data screen.

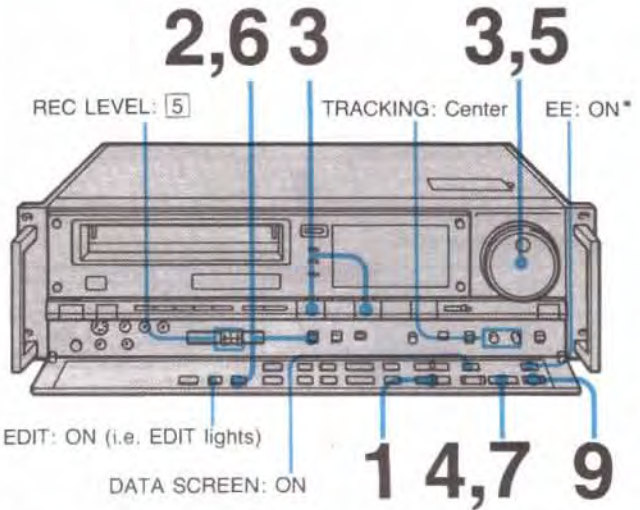

REC LEVEL: 5

TRACKING: Center

EE: ON*

EDIT: ON (i.e. EDIT lights)

DATA SCREEN: ON

*When a monitor TV is not connected to the playback VCR, press EE to view the picture from the playback VCR.

- 1 Press INSERT when the VCR is in stop mode. For "audio insert", press AUDIO. For "video insert", press VIDEO. For "audio and video insert", press both AUDIO and VIDEO INSERT.



Appears when AUDIO is pressed.

Appears when VIDEO is pressed.

Data screen on the monitor for the recording VCR

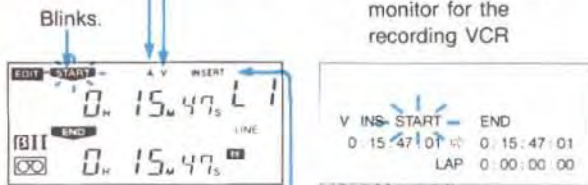

Indicates insert editing.

- 2 To listen to the sound while editing, set AUDIO MONITOR to NORM. The sound recorded on the conventional audio track will be heard while JOG/SHUTTLE is being turned.

- 3 On the recording VCR, locate the point on the tape where you want to start the insertion, and set the VCR to playback pause mode. For accurate searching, use JOG/SHUTTLE.

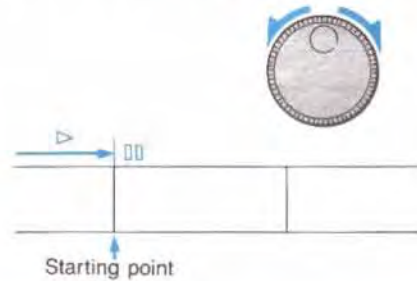

- 4 Press MARK.



The starting point is now memorized.

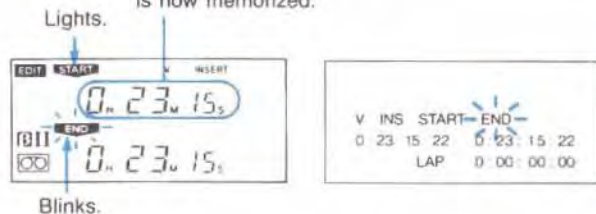

Blinks.

- 5** Locate the point on the tape where you want to stop the insertion, and set the recording VCR to playback pause mode.

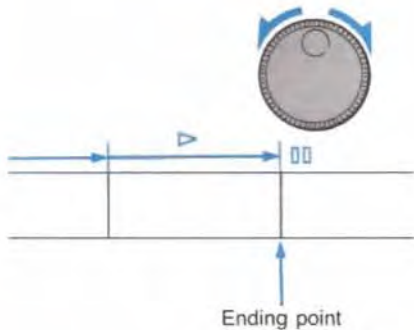

- 6** Select the sound to be edited with AUDIO MONITOR and STEREO L/R.

- 7** Press MARK.



The ending point is now memorized.

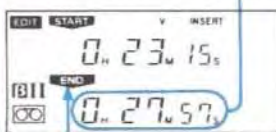

Lights.

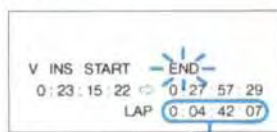

Shows the duration of the insertion to be made.

- 8** On the playback VCR, locate the starting point to be inserted, and set the VCR to **playback pause mode**.

- 9** Press START on the recording VCR. Insertion will start.



At the preset ending point, the insertion will stop automatically. Both VCRs will be set to playback pause mode.

To release the insert mode

To release video insert mode, press VIDEO INSERT again. To release audio insert mode, press AUDIO INSERT again. To release audio/video insert mode, first press VIDEO, and then AUDIO.

To stop the on-going insertion, press ■ STOP on the recording VCR.

Notes

- When insertion is made onto an unrecorded portion of a tape, the slow motion playback picture may be noisy at the ending point of the insertion. When an edited tape is played back in slow motion or stop-action advance playback mode, the picture may be noisy at the ending point of the editing.
- If there is an unrecorded portion of the control signal between the starting and ending points, the video/audio signals are recorded but the control signal is not recorded. When playing back this portion at normal speed, there is no picture and sound.

If there is a [BI] recording on the tape

- Insert editing will stop automatically when a [BI]-recorded portion is played back.
- The insert mode will be released automatically when a [BI]-recorded portion is detected while locating the starting or ending point of automatic insert editing.

Simple Editing

You can simply start and stop editing without marking the editing points. Use two EDV-9500, or one EDV-9500 and SL-HF1000, and connect the CONTROL T jacks. For the connection, see page 57.

Simple Assemble Editing

- 1 Press ASSEMBLE on the playback VCR.
- 2 Locate the starting point of the scene on the playback VCR and set the VCR to playback pause mode.
- 3 Locate the point at which editing is to start on the editing VCR and set the VCR to playback pause mode.
- 4 Press START on the playback VCR. Assemble editing will start.
- 5 On the playback VCR, decide the ending point by observing the picture on the monitor screen and press **II/▶ PAUSE/STILL**.

The playback VCR will be set to playback pause mode in 2 seconds.

The editing VCR rewinds the tape to the ending point and then is set to playback pause mode.

To edit another scene, press ASSEMBLE to release assemble editing mode and press it again.

Simple Insert Editing

- 1 Press VIDEO and/or AUDIO INSERT button on the editing VCR.
- 2 Locate the point at which editing is to start on the editing VCR and set the VCR to playback pause mode.
- 3 Locate the starting point of the scene to be inserted on the playback VCR and set the VCR to playback pause mode.
- 4 Press START on the editing VCR. Insert editing will start.
- 5 On the editing VCR, decide the ending point by observing the picture on the monitor screen and press **II/▶ PAUSE/STILL**.

The editing VCR plays the tape back for 2 seconds, rewinds the tape to the ending point, and is set to playback pause mode.

The playback VCR will be set to playback pause mode in 2 seconds.

Continuous Editing (Butt Edit)

When editing of one scene is finished, the tape on the editing VCR is set at the ending point of the previous editing. Therefore, you should only mark the starting point (and the editing point) of the next scene to be edited on the playback VCR and press START. This method of editing is called "Butt Edit".

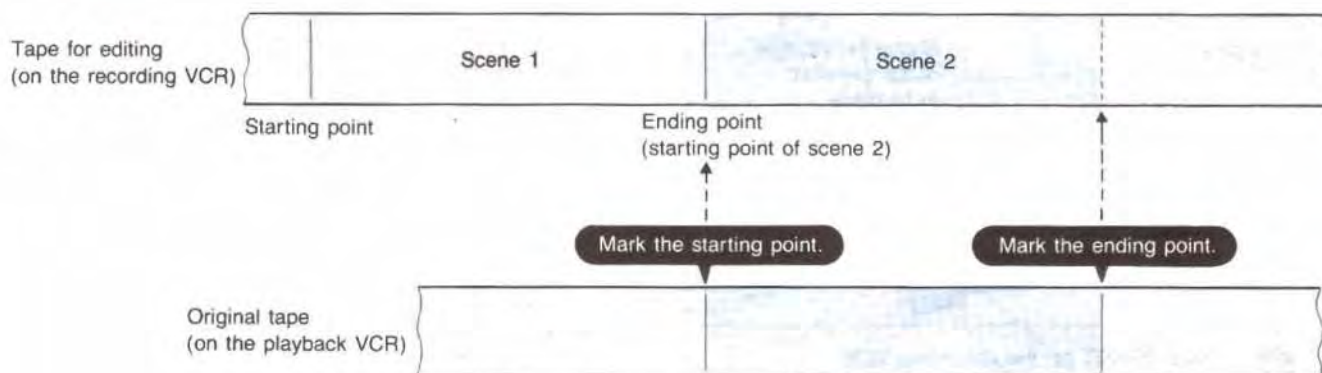

Editing with a Sony VCR Equipped with a Control Terminal

If you have another Sony VCR equipped with intercomponent control terminals, such as a control S jack or CAMERA REMOTE jack, connect the control terminals of the other VCR and this VCR in addition to the video and audio connections. With this connection, automatic assemble editing (page 59) and manual insert editing (page 68) can be made. However, pre-roll will not be carried out while editing. The editing procedures are the same as those described on page 60 and page 69.

Note

When the VCRs are connected through the CONTROL S or CAMERA REMOTE terminals, some errors may result between two continuous editings.

Connecting a VCR Equipped with a Control S IN Jack

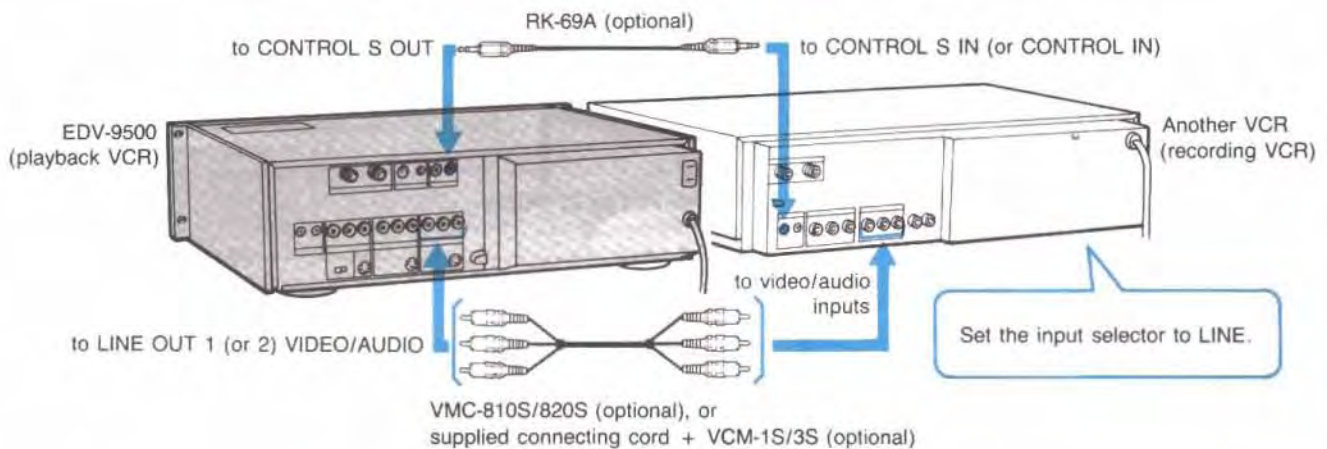

Notes

- When the VCRs are connected as above, the remote sensor of the other VCR may not function. This is not a failure.
- When the Sony SL-HF900 is connected as above, the power switch of the SL-HF900 may not function. In this case, turn the power on and off using the power switch on the Remote Commander.
- If the other VCR has S VIDEO connectors, connect the LINE OUT S VIDEO connector of this VCR to the S VIDEO IN connector of the other VCR, in place of the connections between the phono-type VIDEO IN and OUT jacks.

Connecting a VCR Equipped with a CAMERA REMOTE jack

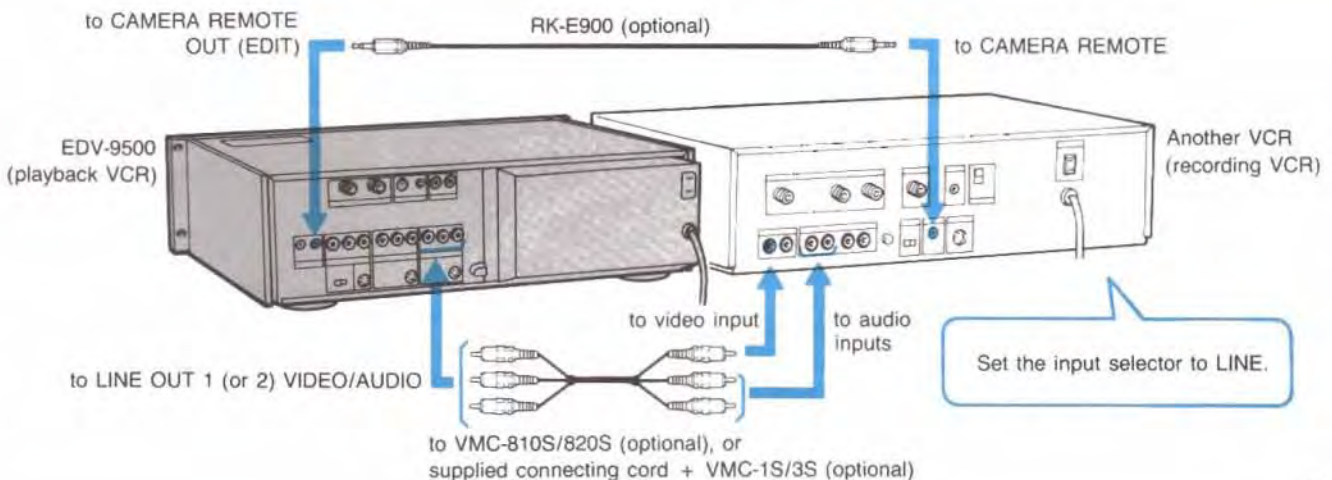

Manual Insert Editing

Connection

You can insert new sound and/or picture onto a pre-recorded tape from various insert source equipment even if they are not equipped with a control terminal.

"Audio insert", "video insert" or "audio and video insert" can be made. (See page 63 for insert modes.)

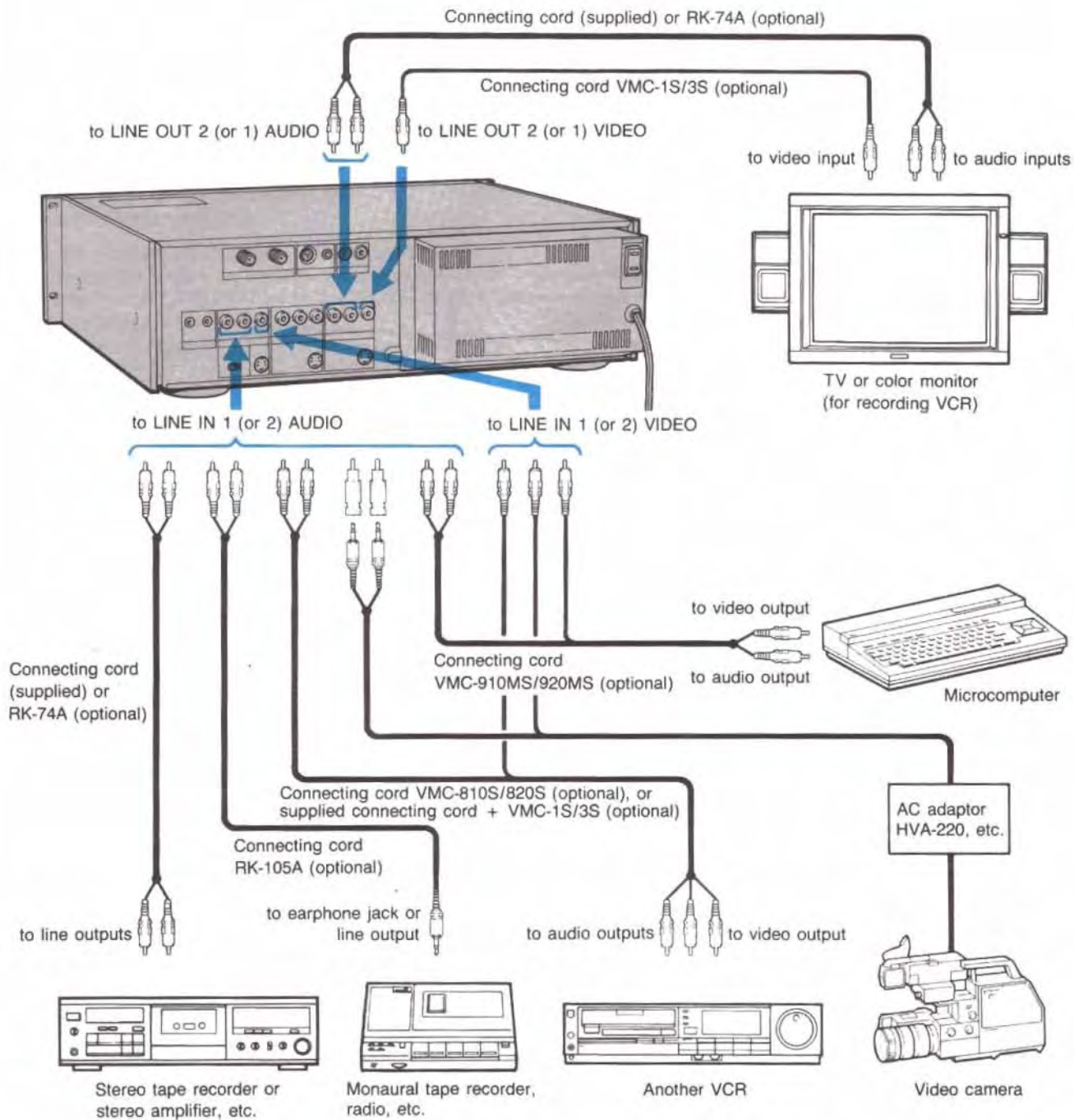

To insert the sound from a microphone

Connect a microphone to the MIC jack on the front and set INPUT SELECT to any position. When a microphone is connected to the MIC jack, the sound from it will always be recorded on the conventional audio track.

Operation

For manual insert editing, assign the editing points on the recording VCR.

Insert source player

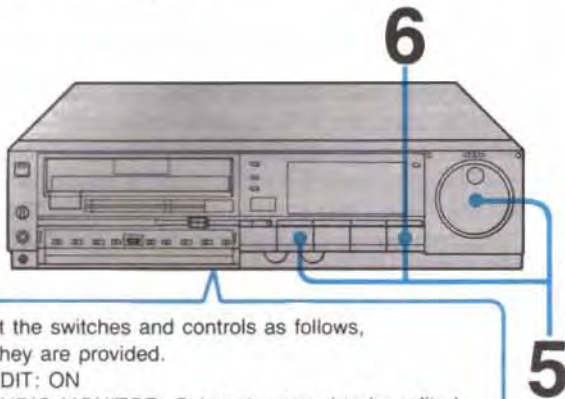

Set the switches and controls as follows, if they are provided.

- EDIT: ON
- AUDIO MONITOR: Select the sound to be edited.
- TRACKING: Adjust for the best possible picture
- DATA SCREEN: OFF

Recording VCR

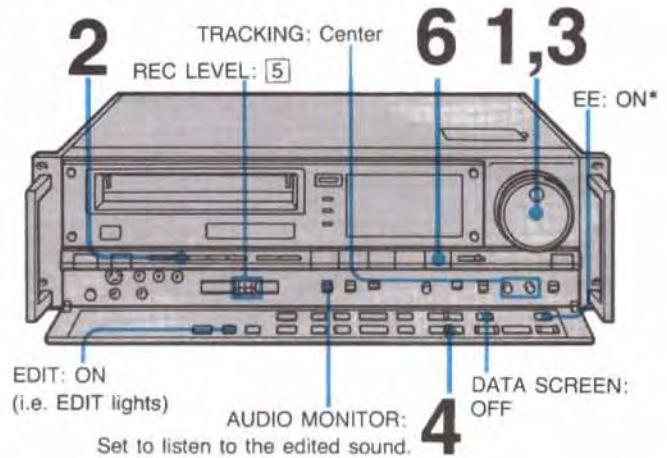

EDIT: ON
(i.e. EDIT lights)

AUDIO MONITOR:
Set to listen to the edited sound.

DATA SCREEN:
OFF

*When a monitor TV is not connected to the playback VCR, press EE to view the picture from the insert source player.

- 1 Locate the point where you want to stop the insertion, and set the unit to playback pause mode. For accurate searching, use JOG/SHUTTLE.

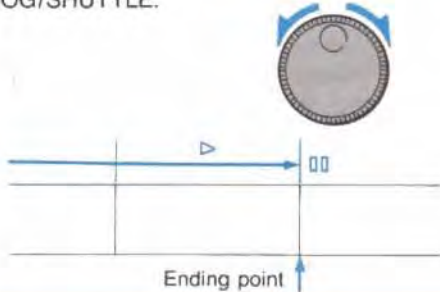

- 4 Press INSERT.
For "audio insert", press AUDIO INSERT.
For "video insert", press VIDEO INSERT.
For "audio and video insert", press both AUDIO and VIDEO INSERT.

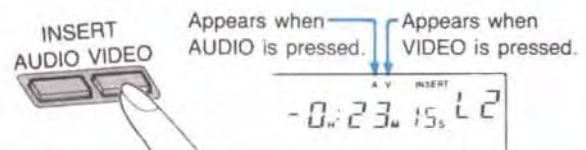

When VIDEO INSERT is pressed, the unit will be set to EE mode and the picture of the insert source will appear on the monitor screen.

- 2 Press COUNTER RESET.
The ending point is registered as counter zero.

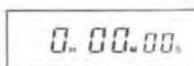

- 5 On the insert source player, locate the starting point to be inserted, and set it to playback pause mode.

- 3 Locate the point where you want to start the insertion, and set the unit to playback pause mode.

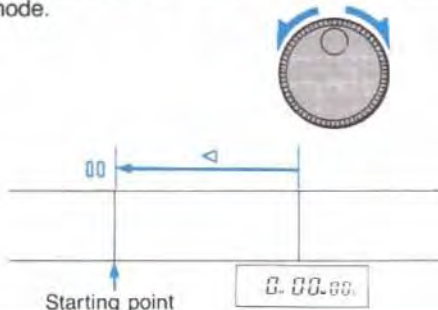

- 6 Press **||/▶** PAUSE/STILL on both units.
The insertion will start.

At the counter zero point, the insertion will stop. The recording VCR will be set to stop mode.

To stop insertion momentarily, press **||/▶** PAUSE/STILL. To resume it, press the same button again.

To stop the on-going insertion, press **■** STOP.

Note

Manual insert editing can be carried out without assigning the ending point. In this case, press COUNTER RESET before starting insertion in step 7. Otherwise, insertion will stop automatically when the counter reaches zero.

Tape Editing Techniques

Tape editing is a simple process that can add much enjoyment to viewing of recorded tapes. Through editing, you can transfer just the sections of previously recorded tapes you want to keep to another tape, add scenes, change the order of playback, and otherwise create a final video tape with just the contents you want. While the arrangement of VCRs and connections for editing is previously shown, this section contains hints and tips for editing that can make it more interesting and enjoyable—not to mention more successful.

Minimizing Loss of Picture and Sound Quality

Some loss of picture and sound quality is an unavoidable by-product of editing. However, by making sure that the equipment is properly set up and adjusted, and by selecting proper tape types, the edited tape will be barely distinguishable from the originals.

First press the VCR's EDIT button to turn on the EDIT indicator.

The EDIT button is located inside the front panel. For normal operation, the EDIT indicator should be off, but when another VCR is connected for tape editing, press EDIT to turn on the indicator.



Generally, for accurate playback of a tape's recorded signals on a TV or monitor, the VCR electrically rectifies the signal. When the EDIT button is set to off, this function is engaged. However, the playback rectification from the original VCR is not needed when the signal is being recorded onto a tape in another VCR; in fact, over-rectification can result. Therefore, when you press the EDIT button to turn on the EDIT indicator, you're cancelling the VCR's rectification circuit. This allows direct recording of the original signal onto the tape in the second VCR. What's more, when the video playback signal from another VCR is edited on this VCR with the EDIT button engaged, editing faults such as color shift can be reduced.

If the input and output terminals or the recording head become dirty, the signal is reduced significantly.

Terminals are the entrance and exit points for signals. If these terminals become dirty, it is impossible to achieve high-quality pictures or sound. Therefore, the terminals should be checked occasionally for dirt or corrosion. If any is present, wipe the terminal with a dry cloth or cloth slightly dipped in alcohol until it is clean.

Also, if the video head becomes soiled with dust or magnetic particles, the S/N (signal-to-noise) ratio will drop and picture and sound quality will be reduced. Since the head can be dirty even if it looks clean, it should be cleaned once every two or three months if the VCR is used frequently, using a Sony Video Head Cleaning Cassette L-25CL or similar product.

When the head has been used for about 1,000 hours, it should be checked by a qualified technician. For details, consult a Sony dealer or contact your nearest authorized service facility.

Use short connection cords

The longer the connection cords, the greater the signal loss will be. To minimize signal loss, use the shortest cords possible.



Don't forget tracking adjustment.

When playing back tapes recorded on other VCRs, adjust the picture for the best quality using the TRACKING NORM control. Use the TRACKING SLOW control for adjustment when playback is slower than normal (1/5 or slower), such as when the JOG dial, SHUTTLE ring, or Wireless Commander are used. If tracking is not adjusted properly, noise will be excessive, and if edited onto another tape, it will be even more severe on the latter. When editing, the position of the tracking control on the recording VCR should be set to the mark or to the spot in the middle where it stops naturally when turned.

Use high-quality tapes.

The higher the quality of the tape, the better the quality of both the original recording and edited versions will be. If high-quality tape is used, color loss will be reduced along with editing marks in the edited tape.

Use the S VIDEO IN/OUT connectors.

If another VCR is equipped with the S VIDEO connectors, connect the two VCRs through the S VIDEO connectors. Picture quality loss will be further reduced.

Camera Recording

Connections

- The camera must conform to American TV (EIA) standards.
- The use of a Sony HVA-220 AC adaptor is required.

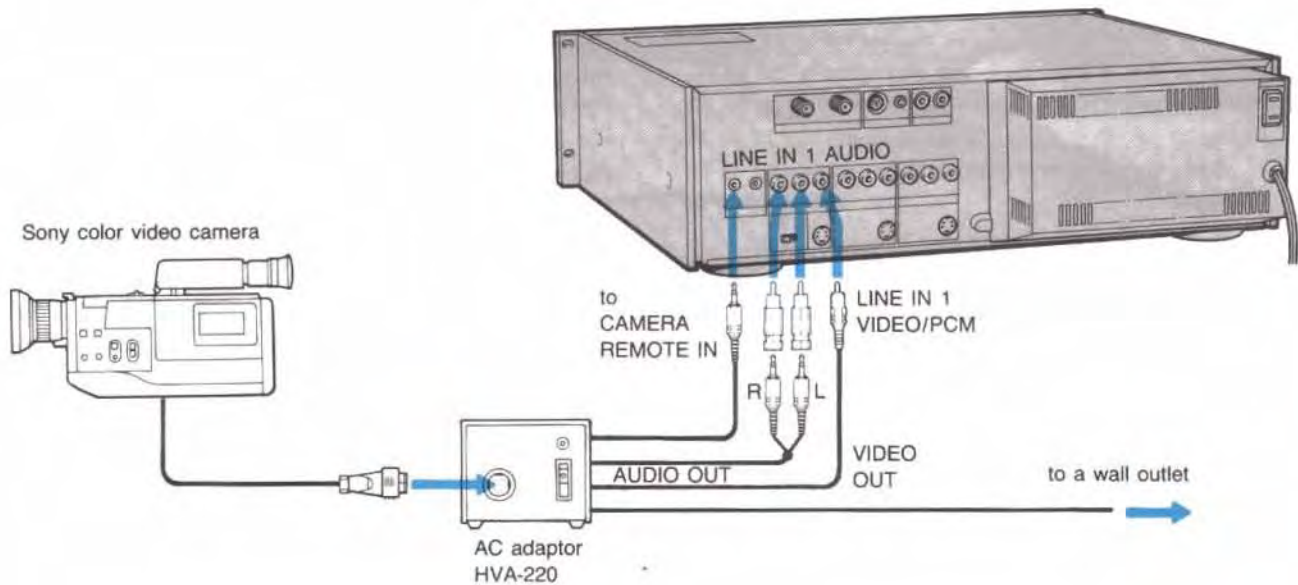

Operation

- 1 Set INPUT SELECT to LINE L1.
- 2 Turn on the AC adaptor and prepare the video camera for recording.
- 3 While pressing **II/▶◀** PAUSE/STILL, slide ● REC to the right on the VCR.
- 4 Press the tape run/stop button on the camera. Camera recording will begin.

To stop the recording momentarily, press the tape run/stop button on the camera.
To stop the recording completely, press **■** STOP on the VCR or the Commander.

Frame-by-frame Shooting

To tape an animated program of your own, follow the steps below.

- 1 Shoot an object, a doll for example, with your camera for approximately 15 seconds, then set the VCR in the recording pause mode with **II/▶◀** PAUSE/STILL.
- 2 Move the object a little and slide ● REC of the VCR to the right or press ● REC of the Remote Commander. A very short recording of approximately seven frames will be made and then the VCR will automatically go into the pause mode again.

Repeat Step 2 as many times as you like.

When such recordings are played back continuously, the object will seem as if it is moving.

Notes

- This function can also be used when recording from the TV.
- The picture may be a little distorted and a noise may be heard when the frame-by-frame recordings are played back continuously.
- If the VCR is kept in the pause mode for more than about 8 minutes, the pause mode will be automatically released and the tape will stop.

Using the Sony Control System

Besides the automatic insert and assemble editing operations, Sony control system allows other intercomponent controls of Sony equipment possible.

Operating by Remote Control through a TV Set or Component TV Tuner

If your Sony TV set or component TV tuner is equipped with a CONTROL S OUT jack, you can operate this VCR by remote control through the TV or TV tuner. This is

especially handy for operating the VCR by remote control while watching TV when the two are located apart from each other.

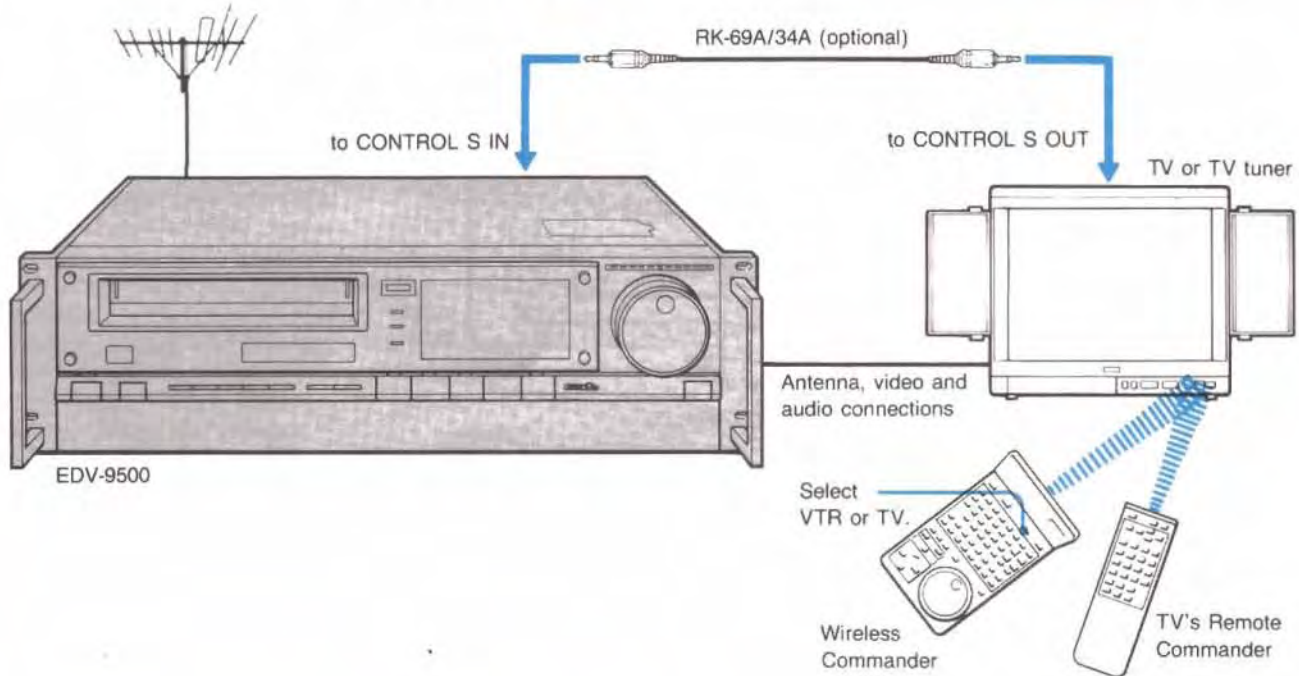

Editing the Recording on 8 mm Format Tapes onto β Tapes with the Video Editing Controller

If you own an 8 mm video camera recorder equipped with a 5-pin REMOTE connector, you can connect the RM-E100/E100V video editing controller between the video camera recorder and this VCR for easier and much faster tape editing of 8 mm tapes onto β Format tapes.

With this controller, you will be able to preset the locations of the scenes you want to record (up to 8) in the controller and with a press of a button, these scenes will be recorded by this VCR automatically in the order preset. For details, refer to the instruction manual of the RM-E100/E100V.

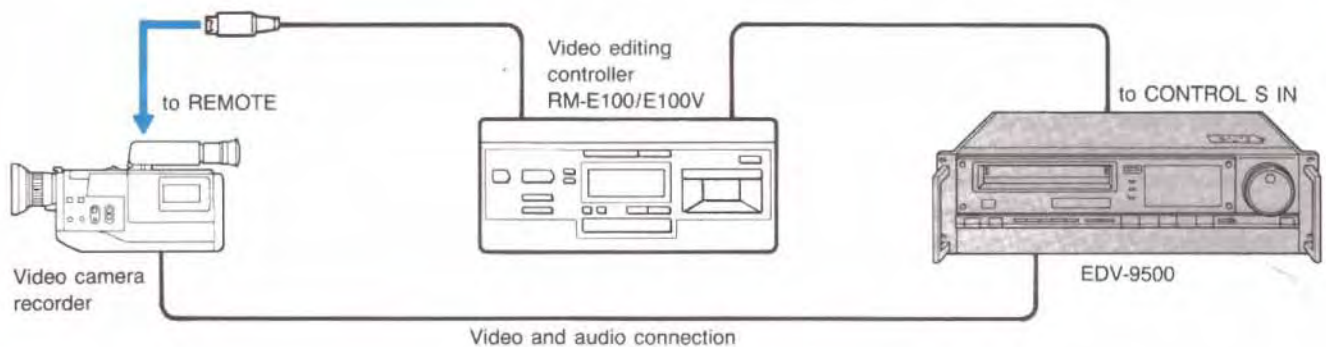

ED Beta Format

The Beta format VCR employs a large-diameter head drum and a high tape-to-head speed. This means the VCR is capable of recording a large amount of information, and it enhances the possibility of high quality picture reproduction. Taking advantage of the Beta format, Sony

has developed the 6.0 MHz SHB (Super Hi-Band) recording format to improve the picture quality in **BI**S mode. The newly developed ED Beta format is designed to improve the picture quality in **BI**I and **BI**II modes. The main characteristics of the ED Beta format are as follows:

Super High Quality Picture

The information capacity is a key element for picture improvement. It can be increased by shifting up the FM carrier frequency range. In the ED Beta format, the FM carrier frequency range of the luminance signal is

shifted up to 6.8–9.3 MHz. This is higher than the 4.4–5.6 MHz range of the Super Beta format. Thanks to this, the horizontal resolution is improved to more than 500 lines.

Frequency allocation of the Super Beta format

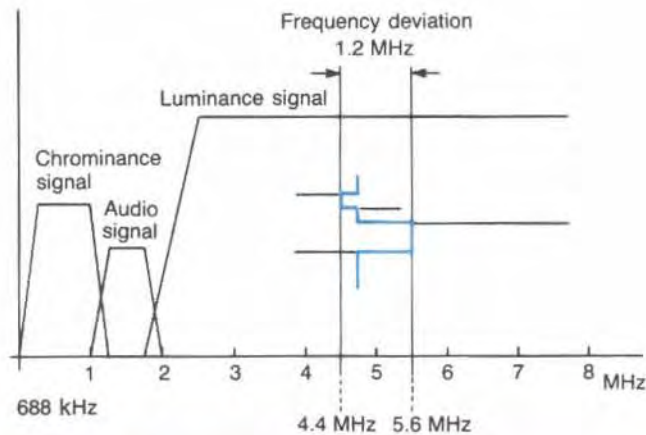

Frequency allocation of the ED Beta format

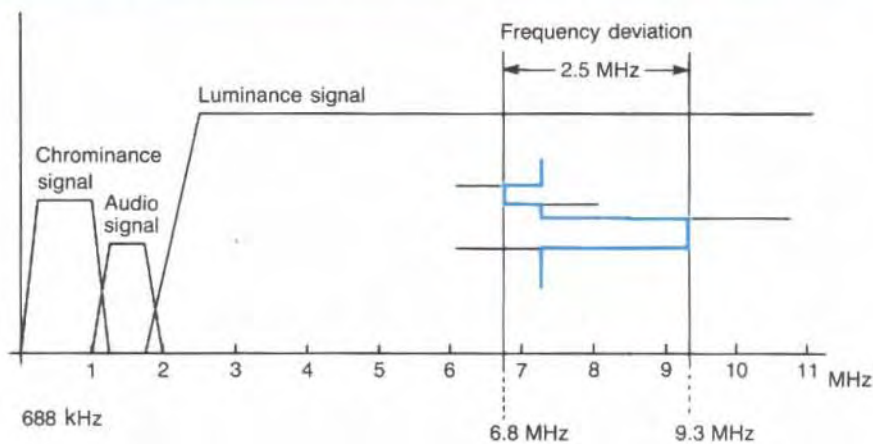

Use of Metal Tape

Tape using metal magnetic material is ideal for a video system because it has a high coercive force to allow high density recording. The ED Beta format VCR uses metal tape covering a sufficient frequency range to achieve high-quality video signal recording/playback. Metal tape also has an excellent frequency response and high signal-to-noise

ratio in audio recording and playback (including audio recording/playback on the conventional audio track). To make the most of the potential of the metal tape, the ED Beta format VCR employs the TSS (Tilted Sendust-sputtered) heads.

S VIDEO (Separated Luminance/Chrominance Signal) Input/Output Connectors

Conventionally, video equipments exchange the composite video signal containing the luminance (Y) signal and the chrominance (C) signal mixed. The composite video signal is liable to produce interference resulting in picture quality loss. On the contrary, an S VIDEO connector transmits or receives the video signal separated into the luminance

signal and the chrominance signal. Flickers and color blur in the picture are minimized with the separated video signal, and sharpness is enhanced to such an extent that hair and fine stripes are clearly visible. The S VIDEO connector also assures an excellent editing quality with minimum picture quality loss.

Compatibility with Conventional VCRs

- An **ED Beta** cassette cannot be recorded and played back with a conventional VCR.
- An ED Beta format VCR is capable of recording and playback of **B** cassettes in SuperBeta format (**B II** and **B III** modes).
- Any cassette recorded in the conventional **B** format can be played back with an ED Beta format VCR.
- The recording tape speeds in the ED Beta format are **B II** and **B III**, compatible with the conventional **B** format. Recording/playback time is 2 hours or 3 hours using an L-500 tape or equivalent.

Cassette Detection Hole

The **ED Beta** cassette is equipped with the cassette detection hole to distinguish it from a **B** cassette. When an **ED Beta** cassette is inserted into this VCR, the VCR is set to the ED Beta format automatically through detection of this detection hole, and the **ED Beta** indicator lights.

ED Beta cassette



Cassette detection hole

B cassette

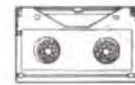

Rack Mounting

The EDV-9500 is designed to be mounted in a 19-inch standard rack. It's also possible to mount the EDV-9500 in other racks which can answer a variety of needs.

Remove the handles before mounting in the rack. Please contact your authorized Sony dealer when you want to mount the EDV-9500 in the rack.

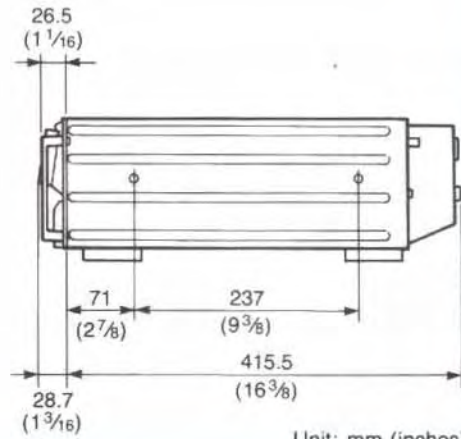
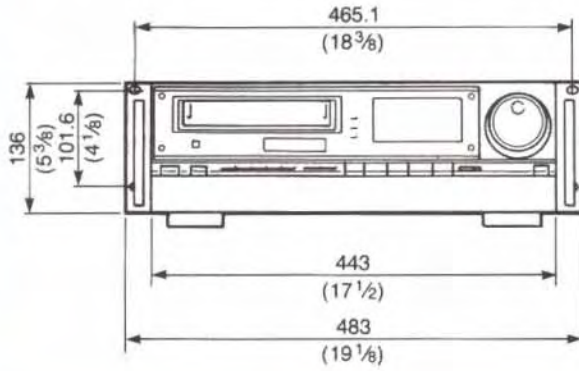

Unit: mm (inches)

Specifications

System

Video recording system	Rotary two-head helical scanning
Audio recording system	Beta hi-fi system (2 channels) (Recording on the conventional audio track is monaural.)
Video signal	EIA standard, NTSC color
Usable cassettes	Cassettes having the mark ED Beta or B B I / B IS : 4.0 cm/sec. (only for playback) B II : 2.0 cm/sec. B III : 1.33 cm/sec.
Maximum recording time	ED Beta format B II : 2 hours B III : 3 hours (with Sony EL-500 cassette) B format B I : 3 hours 20 min. B III : 5 hours (with Sony L-830 cassette)
Fast-forward and rewind time	Approx. 3 1/2 min. (L-500)
Audio frequency response	Beta hi-fi, MPX FILTER OFF: 20–20,000 Hz
Wow and flutter	Beta hi-fi Below measurable limit
Dynamic range	Beta hi-fi More than 90 dB

Tuner section

Channel coverage	VHF channels 2 to 13 UHF channels 14 to 69 CATV channels 1 to 125
VHF output signal	Channel 3 or 4 (selected) 75 ohms, unbalanced
Antenna	75 ohm antenna terminal for VHF/UHF

Inputs and outputs

LINE IN 1 and 2	VIDEO/PCM (phono jack) (1 each) Input signal: 1 Vp-p, 75 ohms, unbalanced, sync negative S VIDEO (4-pin mini-DIN) (1 each) LINE IN 2 S VIDEO: automatically selected LINE IN 1 S VIDEO: selectable with V INPUT SELECT switch Luminance signal: 1 Vp-p, 75 ohms, unbalanced, sync negative Chrominance signal: 0.286 Vp-p, 75 ohms, unbalanced AUDIO (gold plated phono jack) (2 each) Input level: –10 dBs (0 dBs = 0.775 Vrms) Input impedance: more than 47 kilohms
-----------------	---

LINE OUT 1 and 2	VIDEO/PCM (phono jack) (1 each) Output signal: 1 Vp-p, 75 ohms, unbalanced, sync negative S VIDEO (4-pin mini-DIN) (1 each) Luminance signal: 1 Vp-p, 75 ohms, unbalanced, sync negative Chrominance signal: 0.286 Vp-p, 75 ohms, unbalanced AUDIO (gold plated phono jack) (2 each) Standard output: –10 dBs at load impedance 47 kilohms Output impedance: less than 10 kilohms
CONTROL L	5-pin DIN (1)
CONTROL T	Stereo minijack (1)
CONTROL S IN	Minijack (1)
CONTROL S OUT	Minijack (1)
CAMERA REMOTE IN	Special minijack (1)
CAMERA REMOTE OUT (EDIT)	Special minijack (1)
Microphone input	Minijack (1) –60 dBs, for low-impedance microphone
HEADPHONES jack	Stereo minijack (1) –26 dBs, 8 ohms

Timer section

Clock	Synchronized with the power frequency
Time indication	12-hour cycle
Timer setting	Only for recording 8 programs 21 days at max.
Power back up	Self-charging battery incorporated Back-up duration: Up to 10 minutes at one time

General

Power requirements	120 V AC ±10%, 60 Hz ±0.5%
Power consumption	65 W
AC outlet	Max. 200 W (switched/unswitched)
Operating temperature	5°C to 40°C (41°F to 104°F)
Dimensions	Approx. 483 × 151.5 × 444 mm (w/h/d) (17 × 5 × 17 1/2 inches) incl. projecting parts and controls Approx. 17.4 kg (38 lb 6 oz) net
Weight	

Wireless Commander RMT-164

Remote control system	Infrared control
Power requirements	4.5 V DC, 3 size AA batteries (IEC designation R6)
Dimensions	Approx. 105 × 40 × 160 mm (w/h/d) (4 1/10 × 1 1/2 × 6 1/4 inches) incl. projecting parts and controls Approx. 220 g (8 oz) not incl. batteries
Weight	

Accessories supplied

75-ohm coaxial cable with F-type connectors	(1)
Antenna connector	(1)
Connecting cord (2 phono to 2 phono)	(1)
Connecting cord (4-pin mini-DIN to 4-pin mini-DIN)	(1)
Connecting cord VK-1000T (stereo mini to stereo mini)	(1)
Remote Commander RMT-164 with three size AA batteries	(1)

Design and specifications subject to change without notice.

Trouble Checks

If any difficulty should arise during operation, first check the power cord connection, then go through the following list. Should the difficulty persist, unplug the unit and contact your Sony dealer or local authorized Sony service facility.

	Symptom	Possible causes
POWER	The POWER switch does not function.	The recorder is in the timer standby mode. Press TIMER REC.
	The power is turned on, but the unit does not operate.	The safety device on the unit has activated. Turn the power off, disconnect the power cord from the wall outlet and leave the unit for more than one minute.
CLOCK AND TIMER	The clock has stopped and "Su AM 12:00" is blinking.	There has been a power interruption. Reset the date, clock time and timer settings.
	Timer setting cannot be made.	<ul style="list-style-type: none"> • The date and clock are not set. • The timer cannot be set during recording.
TV RECEPTION	TV program is not clearly displayed on the TV screen.	<ul style="list-style-type: none"> • The channel for video recorder is not correctly tuned on the TV receiver. • The TV signal is weak. Adjust the direction of the antenna. • The AC power cord of the recorder is disconnected.
	Stereo programs are heard in monaural.	<ul style="list-style-type: none"> • AUTO STEREO is set to OFF. • AUDIO MONITOR (STEREO/L/R) is set to L or R.
RECORDING AND PLAYBACK	No picture on the TV screen during recording or playback	The TV's channel is not set to that preset for the video recorder.
	Picture being recorded cannot be monitored on the TV screen.	Press TV/VTR so that the VTR indicator appears in the window.
	Noisy picture	The video heads may be contaminated. Clean the heads using the Sony L-25CL video head cleaning cassette. For details on cleaning, refer to the instructions furnished with the cleaning cassette. If the L-25CL cleaning cassette is not available in your area, have the heads cleaned at the nearest Sony service facility.
	The playback picture is not clear.	<ul style="list-style-type: none"> • Check the SUPER BETA button setting. • MPX FILTER is set to PCM. — • Adjust TRACKING NORM or SLOW. • Adjust SHARPNESS.
	The picture moves vertically in Betascan or Beta SkipScan mode.	Adjust the vertical hold control on the TV or color monitor. The tape speed could not be detected.
	The picture is distorted in 1/5 or 1/10 speed playback mode.	• Set to normal playback mode, press  and x 1/5 or x 1/10 again.
	Noise band in the slow motion picture, stop-action advance picture, or freeze picture.	Adjust SLOW TRACKING to move it.
	Distorted or noisy sound	Recording level was not properly adjusted.
	Sound drop-outs of a Beta hi-fi recorded tape	The tape is defective. Use a new video cassette tape.
	Stereo recording cannot be made.	AUTO STEREO is set to OFF (MONO).
	SAP sound cannot be recorded.	Set NORMAL AUDIO to SAP. To listen to the SAP, set AUDIO MONITOR (BETA HI-FI/MIX/NORM) to NORM.
	No sound was recorded in the conventional audio track.	NORMAL AUDIO was set to SAP and there was no SAP broadcast.
	SAP sound cannot be played back.	Set AUDIO MONITOR (BETA HI-FI/MIX/NORM) to NORM.
	No sound is heard during playback.	A tape on which no sound is recorded on the conventional audio track is being played back with AUDIO MONITOR set to NORM. Set it to BETA HI-FI.
Timer recording cannot be made correctly.	<ul style="list-style-type: none"> • The date and clock are not set correctly. • There has been a power interruption. • The cassette inserted is in record prevention mode (page 26) or no cassette has been inserted. • The tape is at its end. • Two or more timer settings overlap. 	

	Symptom	Possible causes
OTHERS	The recorder cannot be remotely controlled.	<ul style="list-style-type: none"> • The remote control TV/VTR selector on the Commander is set to TV. • The command mode selector on the Remote Commander is not set at the same position as that on the VCR. • The batteries are exhausted. • When using JOG/SHUTTLE, press JOG SHUTTLE function button or CHANNEL/TIMER function button. • The COMMAND MODE switch on the VCR is set to OFF.
	The tape counter does not operate even if the tape moves.	<ul style="list-style-type: none"> • The tape is brand-new. • It will not operate with the unrecorded portion of a tape.
	Cassette cannot be inserted.	The cassette being inserted is reversed.
	The cassette cannot be ejected.	Recording is being done.
	Data screen display does not appear.	<ul style="list-style-type: none"> • MPX FILTER is set to PCM. Set to ON or OFF. • DATA SCREEN is set to OFF mode. Press it again.

MEMO

A large rectangular area with a blue border and horizontal blue lines, intended for writing a memo. The area is empty and occupies most of the page below the header.

