

Kawasaki™

AVM678

7" LCD Monitor

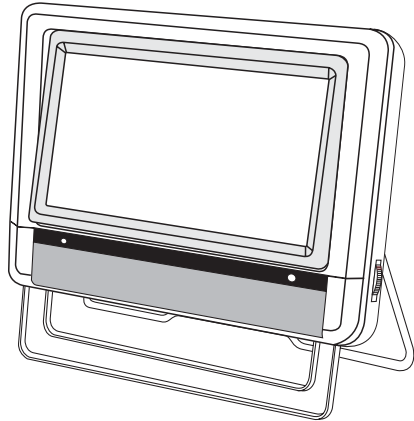

Instruction manual

Kawasaki

Kawasaki Motors Corp., U.S.A.
OFFICIAL • LICENSED • PRODUCT
KS-3891

NEED MORE HELP?

PLEASE VISIT ONLINE HELP AT

<http://www.1800customersupport.com>

⚠ WARNING

TO PREVENT FIRE OR SHOCK HAZARD, DO NOT USE THIS PLUG WITH AN EXTENSION CORD, RECEPTACLE OR OTHER OUTLET UNLESS THE BLADES CAN BE FULLY INSERTED TO PREVENT BLADE EXPOSURE. TO PREVENT FIRE OR SHOCK HAZARD, DO NOT EXPOSE THIS APPLIANCE TO RAIN OR MOISTURE.



THE LIGHTNING FLASH WITH ARROWHEAD SYMBOL, WITHIN AN EQUILATERAL TRIANGLE, IS INTENDED TO ALERT THE USER TO THE PRESENCE OF UNINSULATED "DANGEROUS VOLTAGE" WITHIN THE PRODUCT'S ENCLOSURE THAT MAY BE OF SUFFICIENT MAGNITUDE TO CONSTITUTE A RISK OF ELECTRIC SHOCK TO PERSONS.

CAUTION RISK OF ELECTRIC SHOCK DO NOT OPEN

WARNING: TO REDUCE THE RISK OF ELECTRIC SHOCK, DO NOT REMOVE COVER (OR BACK) NO USER-SERVICEABLE PARTS INSIDE. REFER SERVICING TO QUALIFIED SERVICE PERSONNEL.



THE EXCLAMATION POINT WITHIN AN EQUILATERAL TRIANGLE IS INTENDED TO ALERT THE USER TO THE PRESENCE OF IMPORTANT OPERATING AND MAINTENANCE (SERVICING) INSTRUCTIONS IN THE LITERATURE ACCOMPANYING THE APPLIANCE.

IMPORTANT SAFETY INSTRUCTIONS

- 1) Read these instructions.
- 2) Keep these instructions.
- 3) Heed all warnings.
- 4) Follow all instructions.
- 5) Do not use this apparatus near water.
- 6) Clean only with dry cloth.
- 7) Do not block any ventilation openings. Install in accordance with the manufacturer's instructions.
- 8) Do not install near any heat sources such as radiators, heat registers, stoves, or other apparatus (including amplifiers) that produce heat.
- 9) Do not defeat the safety purpose of the polarized or grounding-type plug. A polarized plug has two blades with one wider than the other. A grounding type plug has two blades and a third grounding prong. The wide blade or the third prong are provided for your safety. If the provided plug does not fit into your outlet, consult an electrician for replacement of the obsolete outlet.
- 10) Protect the power cord from being walked on or pinched particularly at plugs, convenience receptacles, and the point where they exit from the apparatus.
- 11) Only use attachments/accessories specified by the manufacturer.
- 12) Unplug this apparatus during lightning storms or when unused for long periods of time.
- 13) Refer all servicing to qualified service personnel. Servicing is required when the apparatus has been damaged in any way, such as power-supply cord or plug is damaged, liquid has been spilled or objects have fallen into the apparatus, the apparatus has been exposed to rain or moisture, does not operate normally, or has been dropped.
- 14) This appliance shall not be exposed to dripping or splashing water and that no object filled with liquid such as vases shall be placed on the apparatus.

ACCESSORIES

PLEASE CHECK AND IDENTIFY THE SUPPLIED ACCESSORIES.

- AC Adapter x 1
- Car Power Adapter x 1
- EZ View Cable x 1
- Standard A/V Cable x 1
- Single Plug A/V Converter x 1
- Dual Plug A/V Converter x 1
- Mounting Strap for Monitor x 1
- Carrying Bag x 1

CONTROL REFERENCE GUIDE

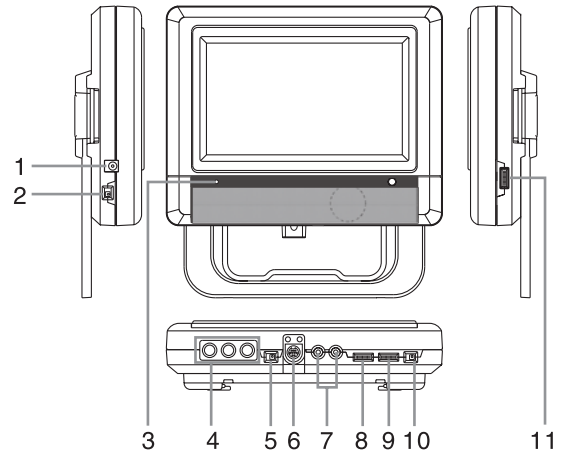

- 1) **12V DC POWER input**
- 2) **POWER ON/OFF switch**
- 3) **POWER indicator**
The LED will illuminate when the monitor is power on.
- 4) **AV1 (VIDEO IN / AUDIO IN [L/R]) jacks**
- 5) **AV1/AV2 switch**
- 6) **AV2 (EZ View Cable) socket**
- 7) **HEADPHONE jacks**
- 8) **BRIGHTNESS control**
Adjusts the lightness or darkness of the screen color.
- 9) **COLOR control**
Adjusts the intensity of the screen color.
- 10) **SCREEN shape switch**
Wide-screen
Normal-screen
- 11) **VOLUME control**
Adjusts the volume up or down.

INSTALLING THE MONITOR IN A VEHICLE

? Use supplied mounting straps when installing the monitor onto the headrest in a vehicle.

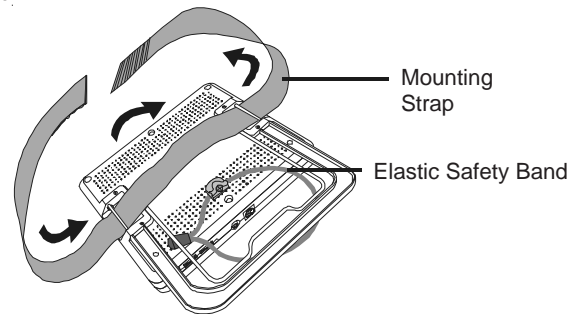

- 1) Loop the elastic safety band around the headrest.
- 2) Tightly wrap the mounting strap around the headrest.

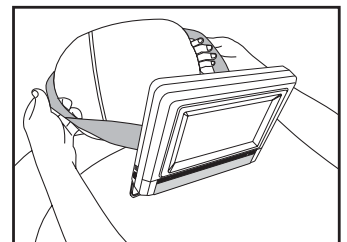
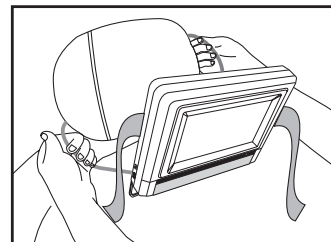

⚠ SAFETY WARNING!

- This monitor should never be used by the driver, or be left unsecured in the vehicle while driving.
- If this monitor is being used in your vehicle, be sure that it is secured or held safely, and does not obstruct any safety device, including airbags or seatbelts.
- All passengers should wear seatbelts when using this monitor in a moving vehicle.
- If in doubt, please contact your vehicle manufacturer for further advice.

POWER SUPPLY

A. USING THE AC ADAPTER

This AC adapter operates on AC power between 100V and 240V.

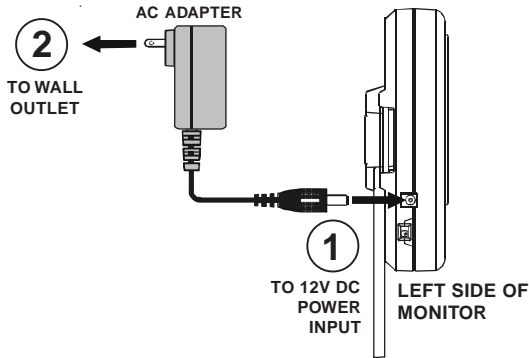

- ⚠ Cautions:**
- The included AC adapter is for use with this monitor only. Do not use it with other equipment.
 - When the monitor is not going to be used for an extended period of time, disconnect the AC adapter from the wall outlet.

B. USING THE CAR POWER ADAPTER

The included car power adapter is designed for use with vehicles that have a 12V, negative ground electrical system.

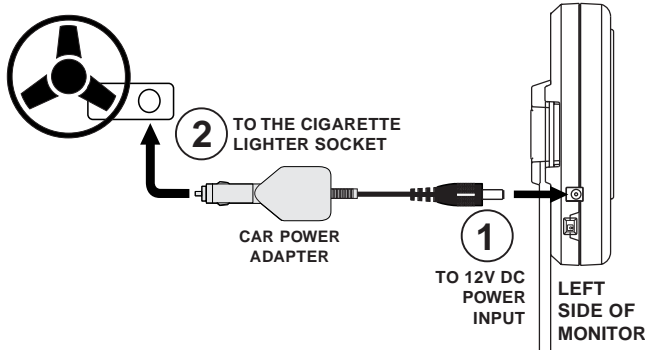

- ⚠ Cautions:**
- Use this monitor only with the included car power adapter. Use with other car power adapters could damage the monitor or your vehicle.
 - The included car power adapter is for use with this monitor only. Do not use it with other equipment.
 - Do not operate the monitor or watch it while driving a vehicle.
 - Make sure the monitor is secured correctly. Incorrect setup could cause the monitor to fly through the passenger compartment in the event of an accident and cause damage to the vehicle, serious injury, or even death.
 - When the inside of the cigarette lighter socket is dirty with ashes or dust, the plug section may become hot due to poor contact. Be sure to clean the cigarette lighter socket before use.
 - After use, disconnect the car power adapter from both the monitor and cigarette lighter socket.

SCREEN VIEWING ANGLE ADJUSTMENT

The monitor is designed to allow you to adjust the angle of the screen +/-12°.

- Push the frame around the screen gently to adjust the angle.

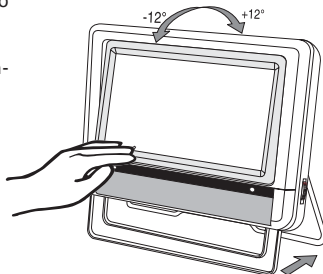

- ⚠ CAUTION:** Do not force the screen frame over its maximum viewing angle settings as stated above. Attempting this will result in damage to the monitor.

USING HEADPHONES / EARPHONES

- Turn down the volume before connecting your headphones or earphones, and then adjust the volume level.
- When headphones or earphones are connected to the monitor, the built-in speakers will be disabled.

- ⚠ Caution:**
- Avoid listening to sound at excessive levels which could be harmful to your ears.

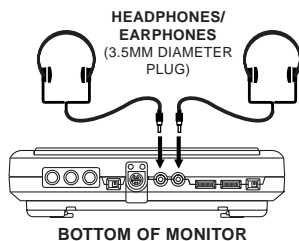

CONNECTIONS

This extra screen connects to almost any audio/video device (including portable DVD players, DVD players, VCRs, mobile video systems, and video game systems).

A. CONNECTING THIS MONITOR USING INCLUDED A/V CABLE

STANDARD AUDIO / VIDEO CABLE

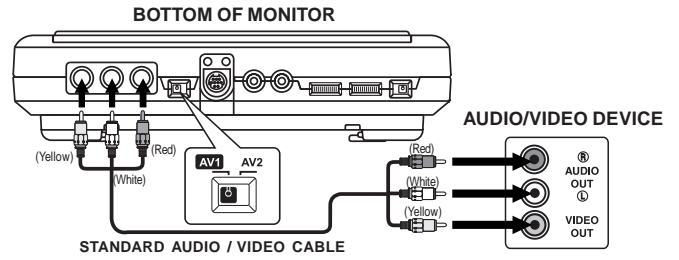

DUAL PLUG A/V CONVERTER

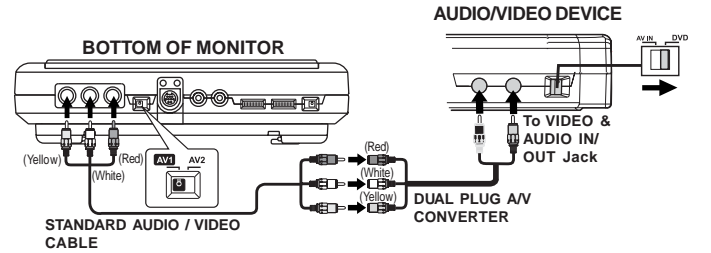

SINGLE PLUG A/V CONVERTER

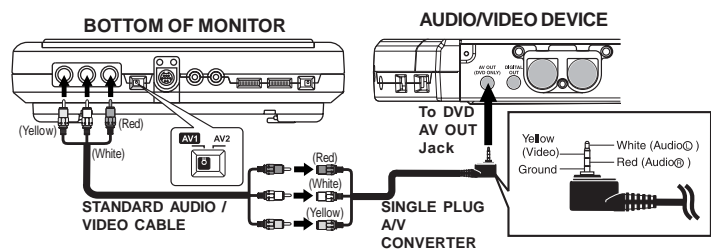

Watching Your Audio/Video Device

- Turn on the monitor, slide the AV1 / AV2 switch to the AV1 position.
- Turn on the other product and follow the instructions provided with it to begin playback.

B. CONNECTING THIS MONITOR USING INCLUDED EZ VIEW CABLE

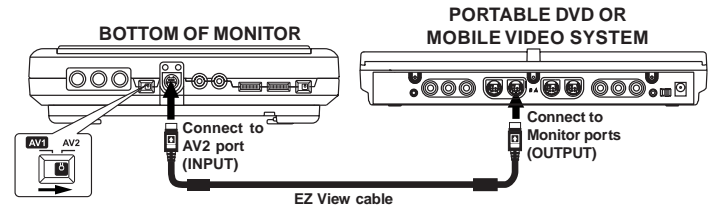

Watching the Portable DVD or Mobile Video System

- Turn on the monitor, slide the AV1 / AV2 switch to the AV2 position.
- Turn on the other product and follow the instructions provided with it to begin playback.

MAINTENANCE

CLEANING THE MONITOR

- Be sure to turn the monitor off and disconnect the power before cleaning the monitor.
- Wipe the monitor with a dry, soft cloth. If the surfaces are extremely dirty, wipe clean with a cloth which has been dipped in a weak soap-and-water solution and wrung out thoroughly, then dry with a soft cloth.
- Never use alcohol, benzine, paint-thinner, cleaning fluid or other chemicals. Do NOT use compressed air to remove dust.

NOTICE: Kawasaki is a trademark licensed by Kawasaki Motors Corp., U.S.A. However, this product is neither manufactured nor distributed by Kawasaki Motors Corp., U.S.A. Consumer inquiries should be directed to Alco Electronics at 1-877-252-6873, or online at <http://www.1800customersupport.com>.