

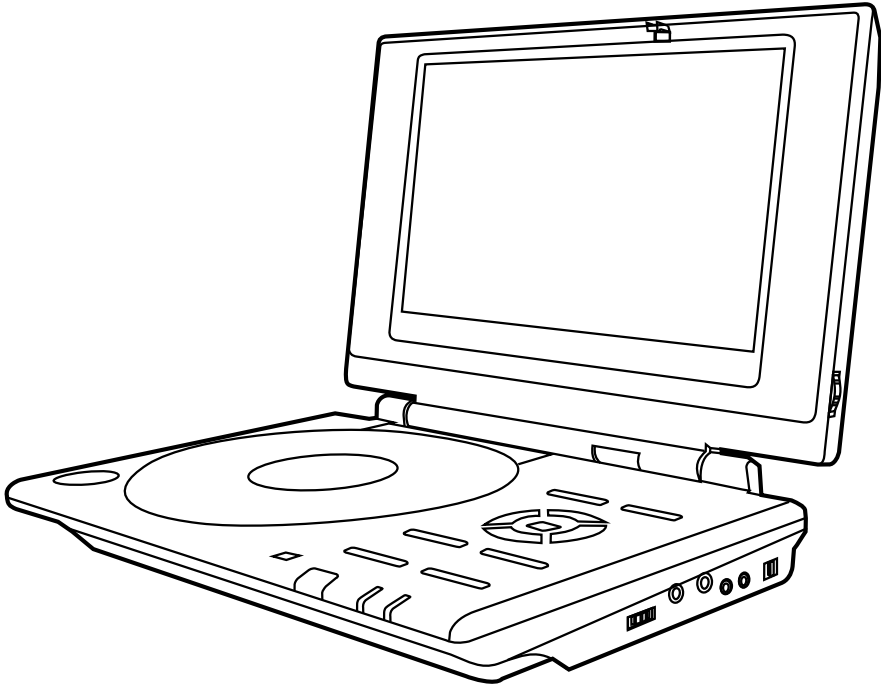

Portable DVD Player with LCD Display



OWNER'S MANUAL

Model: PVS1080
English
811-108091-010
Printed in China

SAFETY PRECAUTIONS



WARNING: TO REDUCE THE RISK OF ELECTRIC SHOCK, DO NOT REMOVE COVER (OR BACK). NO USER-SERVICEABLE PARTS INSIDE. REFER SERVICING TO QUALIFIED SERVICE PERSONNEL.

WARNING: TO PREVENT FIRE OR SHOCK HAZARD, DO NOT EXPOSE THIS APPLIANCE TO RAIN OR MOISTURE.

CAUTION: TO PREVENT ELECTRIC SHOCK, MATCH WIDE BLADE OF PLUG TO WIDE SLOT, FULLY INSERT.

DANGER OF EXPLOSION IF BATTERY IS INCORRECTLY REPLACED. REPLACE ONLY WITH THE SAME OR EQUIVALENT TYPE.



The lightning flash with an arrowhead symbol, within the equilateral triangle, is intended to alert the user to the presence of uninsulated "dangerous voltage" within the product's enclosure that may be of sufficient magnitude to cause an electric shock.



The exclamation point within the equilateral triangle is intended to alert the user to the presence of important operating and maintenance (servicing) instructions in this owner manual.



This product contains a low power laser device.



The symbol for Class II (Double Insulation)

On Placement

- Do not use the unit in places which are extremely hot, cold, dusty, or humid.
- Place the unit on a flat and even surface.
- Do not restrict the air flow of the unit by placing it in a place with poor air flow, by covering it with a cloth, or by placing it on carpeting.

FCC Information

This device complies with Part 15 of FCC Rules.

Operation is subject to the following two conditions:

- (1) This device may not cause harmful interference, and
- (2) This device must accept any interference received, including interference that may cause undesirable operation.

On Safety

- When connecting or disconnecting the AC cord, grip the plug and not the cord itself. Pulling the cord may damage it and create a hazard.
- When you are not going to use the unit for a long period of time, disconnect the AC power cord.

On Condensation

- When left in a heated room where it is warm and damp, water droplets or condensation may form inside the unit. When there is condensation inside the unit, the unit may not function normally. Let the unit stand for 1 to 2 hours before turning the power on, or gradually heat the room up and dry the unit before use.

Rating Plate Location

- The rating plate location is on the bottom of product.

WARNING:

- Should any trouble occur, disconnect the AC power cord and refer servicing to a qualified technician.

Notes on Copyright

It is forbidden by law to copy, broadcast, show, broadcast on cable, play in public, rent copyrighted material without permission.

Apparatus Claims of U.S. Patent Nos. 4,631,603; 4,577,216; 4,819,098 and 4,907,093 licensed for limited viewing uses only.

DVD video discs are copy protected, and any recordings made from these discs will be distorted. This product incorporates copyright protection technology that is protected by method claims of certain U.S. patents and other intellectual property rights owned by Macrovision Corporation and other rights owners. Use of this copyright protection technology must be authorized by Macrovision Corporation, and is intended for home and other limited viewing uses only, unless otherwise authorized by Macrovision Corporation. Reverse engineering or disassembly is prohibited.

IMPORTANT SAFETY INSTRUCTIONS

1. **Read Instructions** - All the safety and operating instructions should be read before the appliance is operated.
2. **Retain Instructions** - The safety and operating instructions should be retained for future reference.
3. **Heed Warnings** - All warnings on the appliance and in the operating instructions should be adhered to.
4. **Follow Instructions** - All operating and use instructions should be followed.
5. **Water and Moisture** - The appliance should not be used near water - for example, near a bathtub, washbowl, kitchen sink, laundry tub, in a wet basement, or near a swimming pool, and the like.
6. **Carts and Stands** - The appliance should be used only with a cart or stand that is recommended by the manufacturer.
- 6A. An appliance and cart combination should be moved with care. Quick stops, excessive force, and uneven surfaces may cause the appliance and cart combination to overturn.
7. **Wall or Ceiling Mounting** - The appliance should be mounted to a wall or ceiling only as recommended by the manufacturer.
8. **Ventilation** - The appliance should be situated so that its location or position does not interfere with its proper ventilation. For example, the appliance should not be situated on a bed, sofa, rug, or similar surface that may block the ventilation openings; or, placed in a built-in installation, such as a book case or cabinet, that may impede the flow of air through the ventilation openings.
9. **Heat** - The appliance should be situated away from heat sources such as radiators, heat registers, stoves, or other appliances (including amplifiers) that produce heat.
10. **Power Sources** - The appliance should be connected to a power supply only of the type described in the operating instructions or as marked on the appliance.
11. **Grounding or Polarization** - Precautions should be taken so that the grounding or polarization means of an appliance are not defeated.
12. **Power-Cord Protection** - Power-supply cords should be routed so that they are not likely to be walked on or pinched by items placed upon or against them, paying particular attention to cords at plugs, convenience receptacles, and the point where they exit from the appliance.
13. **Cleaning** - The appliance should be cleaned only as recommended by the manufacturer.
14. **Power Lines** - An outdoor antenna should be located away from power lines.
15. **Outdoor Antenna Grounding** - If an outside antenna is connected to the receiver, be sure the antenna system is grounded so as to provide some protection against voltage surges and built up static charges. Section 810 of the National Electrical Code, ANSI/NFPA No. 70, provides information with respect to proper grounding of the mast and supporting structure, grounding of the lead-in wire to an antenna discharge unit, size of grounding conductors, location of antenna-discharge unit, connection to grounding electrodes, and requirements for the grounding electrode. See Figure 1.
16. **Nonuse Periods** - The power cord of the appliance should be unplugged from the outlet when left unused for a long period of time.
17. **Object and Liquid Entry** - Care should be taken so that objects do not fall, and liquids are not spilled, into the enclosure through openings.
17. **Damage Requiring Service** - The appliance should be serviced by qualified service personnel when:
 - A. The power-supply cord or the plug has been damaged; or
 - B. Objects have fallen, or liquid has been spilled, into the appliance; or
 - C. The appliance has been exposed to rain; or
 - D. The appliance does not appear to operate normally or exhibits a marked change in performance; or
 - E. The appliance has been dropped, or the enclosure damaged.
18. **Servicing** - The user should not attempt to service the appliance beyond that described in the operating instructions. All other servicing should be referred to qualified service personnel.

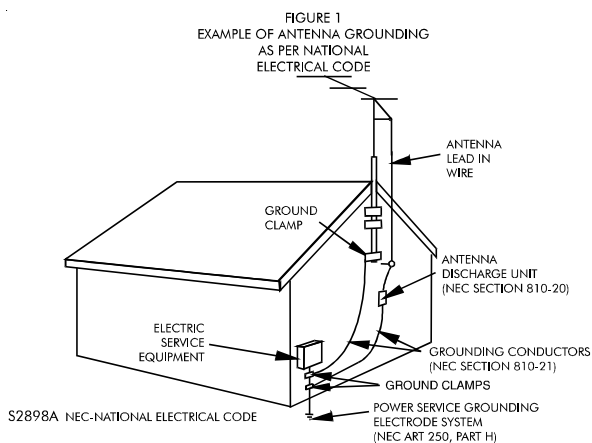

TABLE OF CONTENTS

Safety Precautions	1
Important Safety Instruction	2
Table Of Contents	3
Disc Formats	4
Accessories	5
Remote Control	5
Control Reference Guide	6-7
Power Supply	8-10
Using the AC adaptor	8
Using the car adaptor	8
Using the rechargeable battery pack	9-10
Turning on the unit	10
Connecting other Equipment	11-13
Connecting Game Consoles or other Video Equipment	11
Connecting your TV	11
Connecting to a stereo receiver	12
Using headphone/earphones	13
Adjusting the Sound	13
Playing a Disc	14-16
Playing Disc	14
Pausing playback (still mode)	14
Stopping playback	14
To skip to a different track	14
Fast Foward/Fast Reverse	15
Skip (Forward/Reverse)	15
Zooming into an image	15
Angle selection	16
Audio selection	16
Subtitle selection	16
Special Functions	17-19
Display function	17
Locating a specific title	18
Locating a specific title/chapter/track	18
Locating a specific time	19
Angle setting	19
Audio setting	19
Subtitle setting	19
CD / DVD programmable memory	20
DVD programmable memory	20
CD programmable memory	20
Repeat Playback	21-22
Repeating a title/chapter (DVD)	21
Repeating a single track/whole disc (CD)	21
Repeating a specific section (DVD/CD)	22
Playing MP3/Digital Picture Files	23-24
Playing MP3 files	23
Playing Digital Picture files	24
Playing a MP3/Digital Picture files	24
Customizing the Function Settings	25-28
LANGUAGE setting	25
VIDEO setting	25-26
AUDIO setting	26-27
RATING setting	27-28
Language Code List for Disc Language	29
Maintenance	30
Cleaning Disc	30
Cleaning the Unit	30
Important Note	30
Trouble Shooting Guide	31

DISC FORMATS

The unit can playback.



DVDs
[8cm/12cm disc]



CD-R CD-RW
Compatible



Audio CDs
[8cm/12cm disc]



Region Management Information

Region Management Information: This unit is designed and manufactured to respond to the Region Management Information that is encoded on DVD discs. If the Region number printed on the DVD disc does not correspond to the Region number of this unit, this unit cannot play that disc.







The region number of this unit is 1.

Disc Function or Operation that is Not Available

When the  symbol appears on the screen, it indicates that the function or operation attempted is not available at that time. This occurs because the DVD disc manufacturer determines the specific functions. Certain functions may not be available on some discs. Be sure to read the documentation provided with the DVD.

Icons Used on DVDs

Sample Icons

	1. English 2. French	Language selections for audio
	1. English 2. French	Language selections for subtitles
	16:9	Screen aspect ratio
	2	Multiple camera angles
		Region code indicator

Notes:

- This Unit supports 2-channel (L/R) audio and 5.1ch (Multi-channel) MPEG Audio 1/2 (only when the DIGITAL AUDIO OUT coaxial jack is used for connection). It does not support 7.1 channel MPEG Audio Version 2.0.
- When playing back a CD-G (Graphics) or CD EXTRA disc, the audio portion will be played, but the graphic images will not be shown.

Title, Chapter and Tracks

- DVDs are divided into “titles” and “chapters”. If the disc has more than one movie on it, each movie would be a separate “title”. “Chapters” are sections of titles.

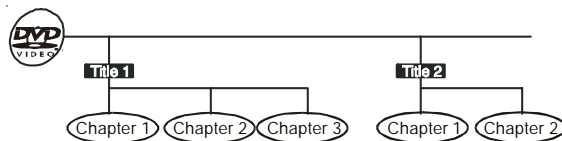

- Audio CDs are divided into “tracks”. A “track” is usually one song on an Audio CD.

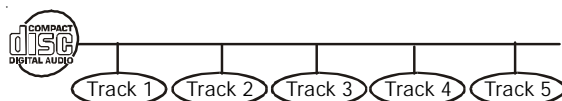

Note :

- Numbers identify each title, chapter, and track on a disc. Most discs have these numbers recorded on them, but some do not.

Notes on Unauthorized Discs

You may not be able to play back some DVD discs on this unit if they were purchased from outside your geographic area or made for business purposes.

ACCESSORIES

Please check and identify the following supplied accessories:

- Remote control (with battery) x 1
- AC adaptor x 1
- AC power cord x 1
- Car power adaptor x 1
- Audio/V ideo cable x 1
- Rechargeable battery pack x 1
- Battery charger x 1

REMOTE CONTROL

Using the Remote Control

- Point the Remote Control at the REMOTE SENSOR located on the unit.
- When there is a strong ambient light source, the performance of the infrared REMOTE SENSOR may be degraded, causing unreliable operation.
- The recommended effective distance for remote operation is about 16 feet (5 meters).

Gently remove the plastic sheet before operating the Remote Control.

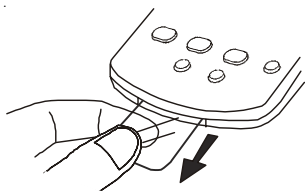

TO CHANGE REMOTE BATTERY

1. Open the battery door.
2. Insert one CR2025 (3V) size battery.

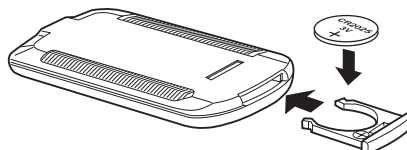
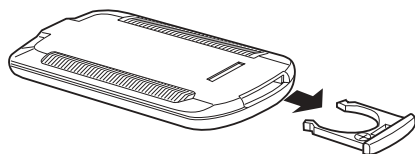

BATTERY REPLACEMENT

When the battery becomes weak, the operating distance of the Remote Control will be greatly reduced and you will need to replace the battery.



NOTE:

- If the Remote Control is not going to be used for a long time, remove the battery to avoid damage caused by battery leakage or corrosion.
- **WARNING:** Do not dispose of battery in a fire, or it may explode.

CONTROL REFERENCE GUIDE

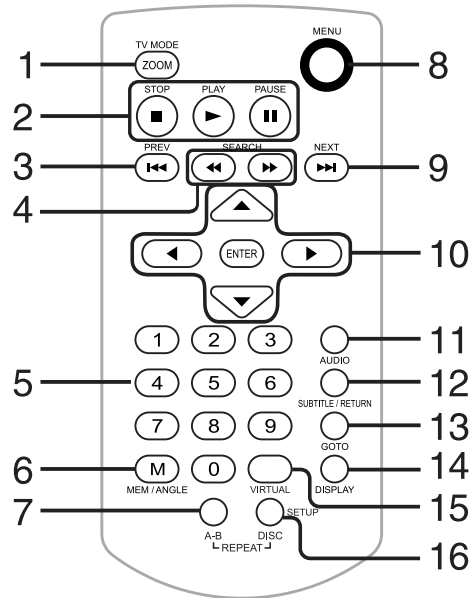
Remote Control



- 1) ZOOM button**
Zoom into an image.
TV MODE button
When a DVD is stopped, this button indicates whether the video signal is in PAL or NTSC format. If "AUTO" is displayed, the output signal will depend on the format of the DVD. (NOTE: North American TVs use the NTSC format)
- 2) ■ STOP button**
Stop playing a disc.
▶ PLAY button
Press to start or resume playback of a disc.
|| PAUSE button
Press once to pause playback, Press repeatedly to advance one frame at a time.
- 3) ◀◀ PREV button**
Move back through titles, chapters or tracks.
- 4) ◀◀ / ▶▶ SEARCH buttons**
◀◀ SEARCH: Fast reverse playback.
▶▶ SEARCH: Fast forward playback.
- 5) Number (0 - 9) buttons**
Use to create programs, enter a parental level password, or select a CD/MP3 track.
- 6) MEM / ANGLE button** 
In stop mode, enter the number of a selected chapter or track.
If a DVD has been recorded using multiple camera angles, this button allows you to switch between different angles.
- 7) REPEAT A - B button**
Perform point-to-point repeat playback on a DVD or CD.
- 8) MENU button**
Enter or return to the main menu of the DVD.
- 9) ▶▶ NEXT button**
Move forward through titles, chapters or tracks on a disc.
- 10) Cursor (▼, ▲, ◀, ▶) buttons**
Use to highlight selections on a menu screen and adjust certain settings.
ENTER button
Confirm selections.
- 11) AUDIO button**
Selects one of the audio sound tracks programmed on a DVD or selects the audio output mode on a AUDIO CD.
- 12) SUBTITLE/RETURN button** 
Selects one of the subtitle languages programmed on a DVD.
Return to the normal operation after using the SETUP menu of a DVD.
- 13) GOTO button**
Skip directly to a specific location on a DVD disc.
- 14) DISPLAY button**
Changes disc status information displayed on the screen.
- 15) VIRTUAL button**
Press for virtual surround sound from just two speakers.
- 16) SET-UP/REPEAT-DISC button**
When the DVD is stopped, enter and exit the SET-UP menu of the unit.
Repeat chapter or title of a DVD.
Repeat single track or entire CD.

CONTROL REFERENCE GUIDE

Unit

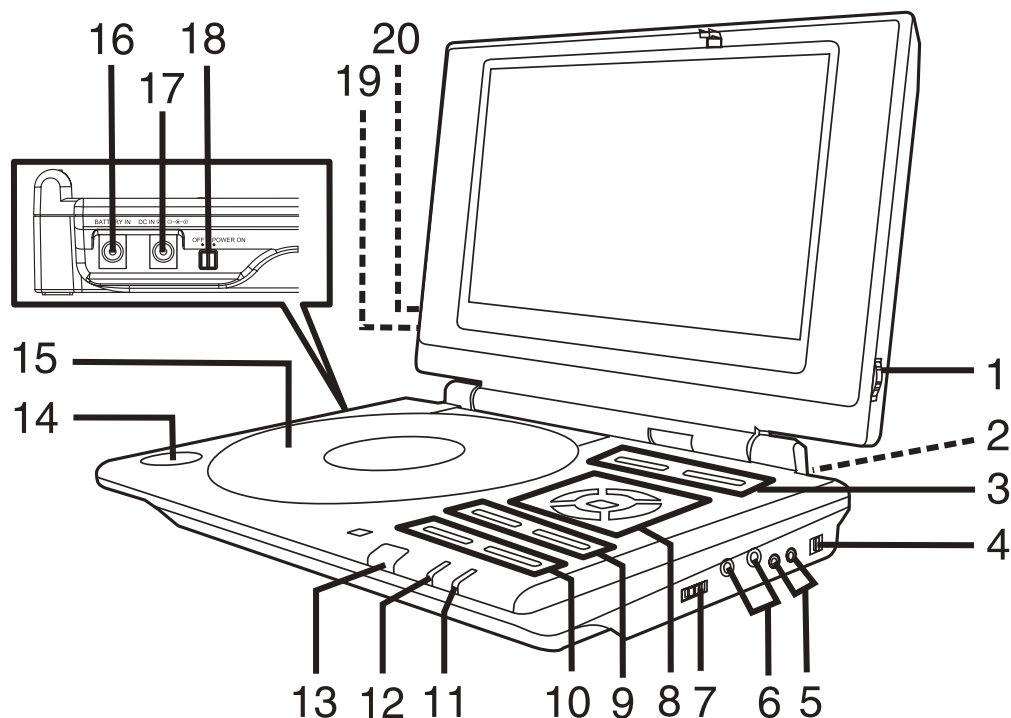

1) BRIGHTNESS button

Adjust the lightness or darkness of the screen.

2) DIGITAL OUT jack

3) ZOOM button

Zoom into an image.

AUDIO button

Select one of the audio soundtracks programmed on a DVD or select the audio output mode on a AUDIO CD.

MENU button

Enter or return to the DVD's menu.

PAUSE /SETUP button

Press to pause playback of disc. Each time you press the PAUSE button the picture advances one frame. Press the PLAY button to resume playback

When DVD is stopped, enter or exit the SETUP menu of the unit.

4) AV IN / DVD switch

Select between the DVD player or an external video source.

5) AUDIO & VIDEO IN /OUT jacks

6) Headphone jacks

Connect one or two headphones

7) VOLUME control

Adjust the volume.

8) Cursor (, , ,) button

Use to highlight selections on a menu screen and adjust certain settings.

ENTER button

Confirm selections on a menu.

9) PREV button

Press PREV button to go back to previous chapters /tracks. Press and hold PREV button for fast reverse. Four speeds are available.

NEXT button

Press NEXT button to advance to chapters / tracks. Press and hold NEXT button to begin fast forward. Four speeds are available.

10) STOP button

Stop playing a disc.

PLAY button

Press to start or resume playing a disc.

11) BATTERY LOW indicator

12) Power ON indicator

When the POWER ON/OFF button is switched to ON position, the light will illuminate.

13) Remote Control sensor

Receives the remote control signal.

14) Open button

Push the button to open the disc door.

15) Disc Door

Close door by gently pushing down.

16) BATTERY IN jack

17) DC IN 9V jack

18) POWER ON/OFF switch

19) SCREEN switch

16:9 Wide-screen

4:3 Pan screen

20) COLOR control

Adjust the color intensity.

POWER SUPPLY

A. Using the AC adaptor

This AC adaptor operates on AC power between 110V and 240V, but

- In the USA and Canada, the AC power supply cord must be connected to a 120V AC power supply only.
- When connecting to an AC supply outside of the USA and Canada, use a plug adaptor to suit the AC outlet configuration.

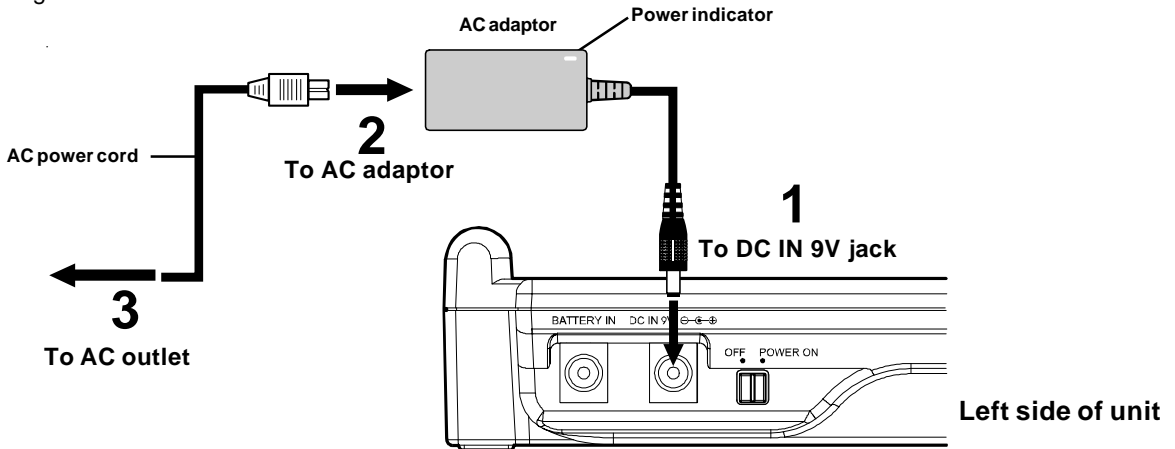

Cautions:

- The included AC power supply cord and AC adaptor are for use with this unit only. Do not use them with other equipment.
- **To prevent electrical shock, match wide blade of plug to wide slot of electrical outlet and fully insert.**
- When the unit is not going to be used for long time, disconnect the power cord from the outlet.

B. Using the Car power adaptor

The included car power adaptor is designed for use with vehicles that have a 12V, negative ground electrical system.

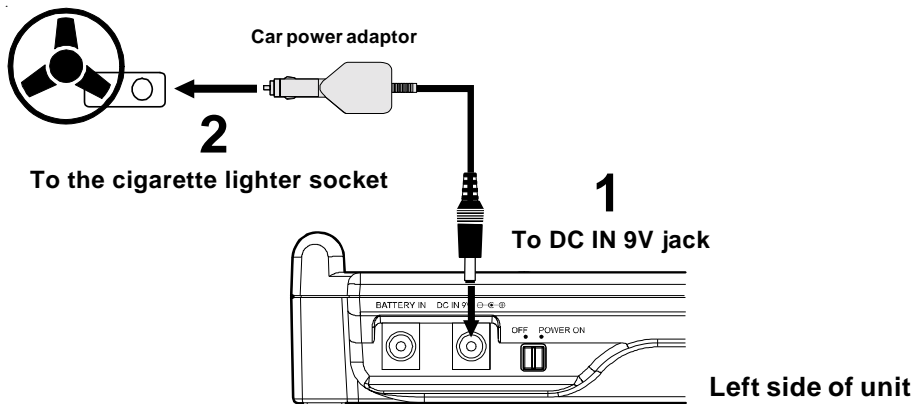

CAUTION:

- Use only the included 12V car power adaptor. Use of any other 12V car power adaptors could damage the unit.
- The 12V car power adaptor included is for use with this unit only. Do not use it with any other equipment.
- In the interest of traffic safety, drivers should not operate the unit or view videos while driving.
- When the inside of the cigarette lighter socket is dirty with ashes or dust, the plug section may become hot due to poor contact. Be sure to clean the cigarette lighter socket before use.
- After use, disconnect the car power adaptor from both the unit and cigarette lighter socket.
- If the unit is not properly attached to a vehicle, it may become airborne in the event of an accident and cause damage, injury, or death.
- Check your local traffic laws for rules governing the use of video devices in vehicles before using this unit in your vehicle.

POWER SUPPLY

C. Using the rechargeable battery pack

- Charge the battery pack before using it for the first time.
- When recharging the battery, disconnect it from the unit.

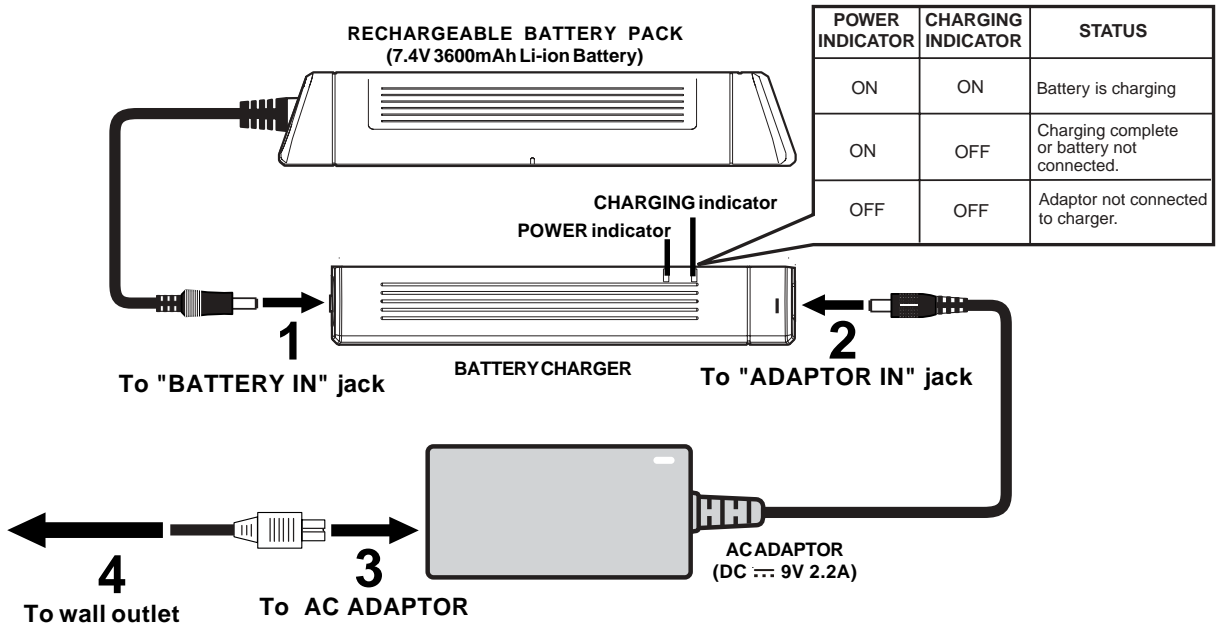

Caution:

- The included AC power supply cord and AC adaptor are for use with this unit only. Do not use them with other equipment.
- **To prevent electrical shock, match wide blade of plug to wide slot on electrical outlet and fully insert.**
- When the unit is not going to be used for a long time, disconnect the AC power supply cord from the AC outlet.
- Recharging is complete when charging indicator goes out. Unplug the AC power supply cord from the AC adaptor, then unplug the battery pack from the battery charger.
- To attach rechargeable battery pack, slide it in to the corresponding positions on the back of the unit.

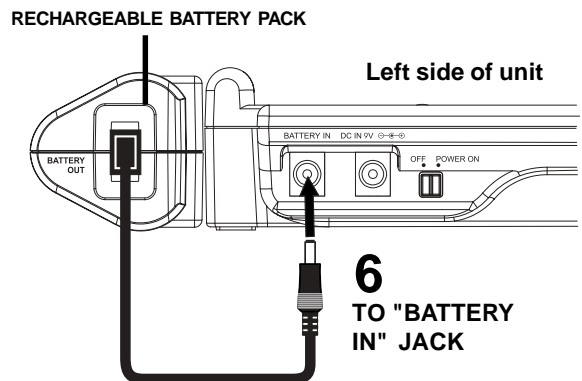
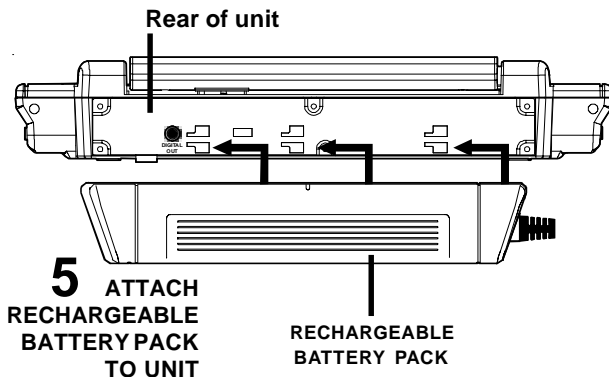

POWER SUPPLY

- Disconnecting the Battery Pack from the unit.

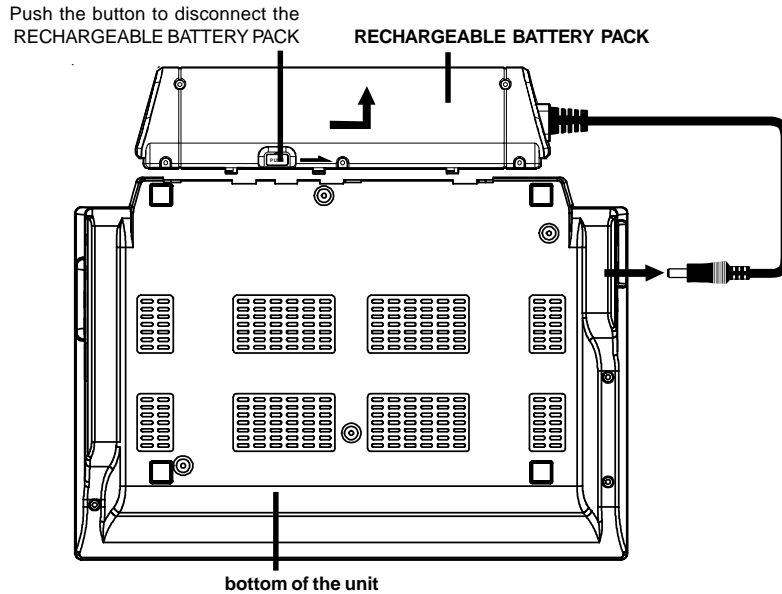

Condition and attention:

- When battery is low, unit will stop operating.
- During playback, if the battery is low, the BATTERY LOW indicator on the front will turn red and blink. When this occurs, you should recharge the battery.
- Do not short-circuit the terminals.
- Use only the supplied AC ADAPTOR and BATTERY CHARGER to recharge the battery pack.
- Detach the battery pack when not in use. (Even if the unit is off, it still uses some power. This can completely discharge the battery and cause it to malfunction.)
- Recharge the battery pack when you are ready to use it again.
- If the rechargeable battery pack is not to be used for a long period of time, discharge it and store it in a place that is cool, dry and dark.
- While using the rechargeable battery pack, the environmental temperature should be 41°F (5°C) to 95°F (35°C).
- To maximize the life of the rechargeable battery pack, recharge it at or below room-temperature.
- Never dispose of the battery in fire or water.
- Do not open the rechargeable battery pack, refer servicing to qualified service personnel.

Turning on the unit

1. Slide the **POWER ON/OFF** switch to the POWER ON position on the left side of unit.
2. Slide the **AV IN / DVD** switch to DVD or AV IN mode on right side of unit.
 - If you select DVD the DVD logo (start-up picture) will appear on the screen.



CONNECTING OTHER EQUIPMENT

Using this Unit with Other Equipment

A. Connecting Game System or other Video Equipment

- You can connect a Game System or other Video Equipment to the system.

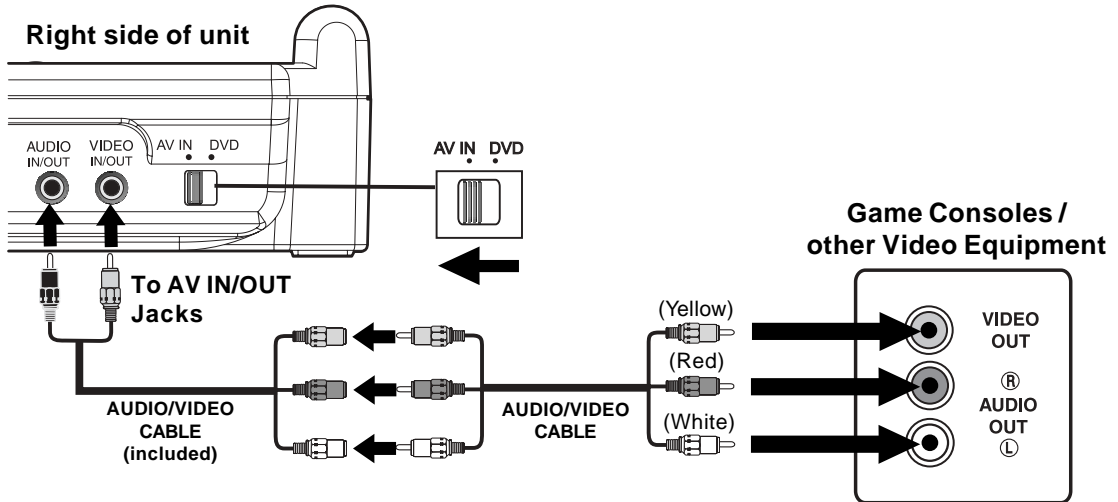

Using a Game System or other Video Equipment

1. Turn on the unit, slide the **AV IN / DVD** switch to "AV IN".
2. Turn on the video equipment and follow the instructions provided with it.

Note: If you are using a mono VCR, the volume level from the speakers will be low.

B. Connecting the unit a TV

- If your TV has Audio/Video inputs, you can connect the unit to your TV using the Audio/Video cable.

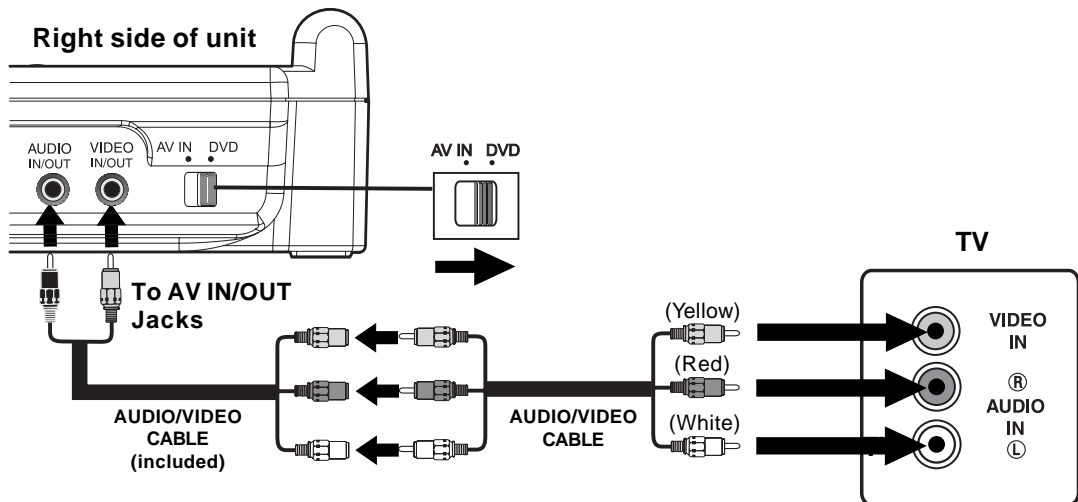

Watching a DVD on your TV

1. Turn on the unit, slide the **AV IN / DVD** switch to "DVD".
2. Turn on the TV and follow the instructions provided with it to play the DVD.

Notes:

- Use the included Audio/Video cable.
- If your TV does not have Audio/Video inputs, you will need to purchase an RF modulator (sold separately) and follow the instructions included with it to connect the unit to your TV.

CONNECTING OTHER EQUIPMENT

C. Connecting to an amplifier or stereo receiver

This unit can play Dolby Digital, but only in two channels.

Analog connection

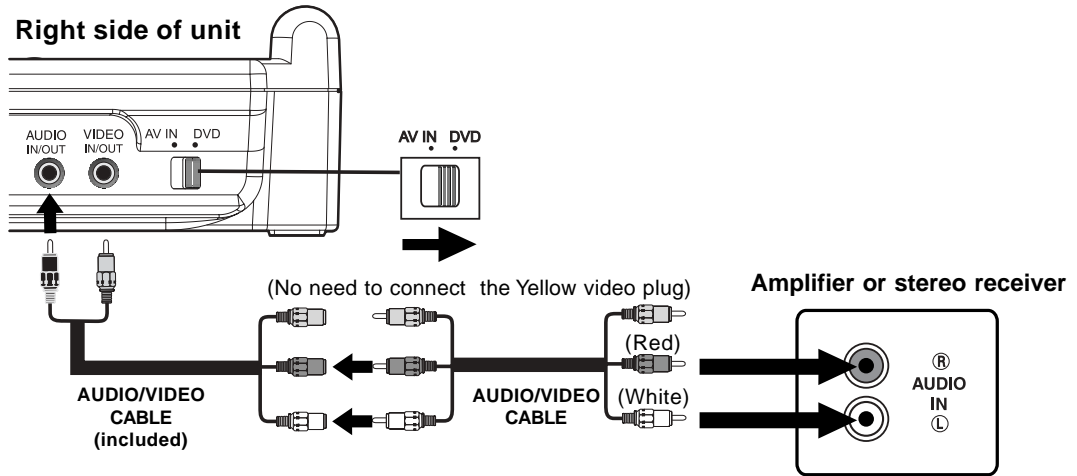

Connecting to a surround sound system

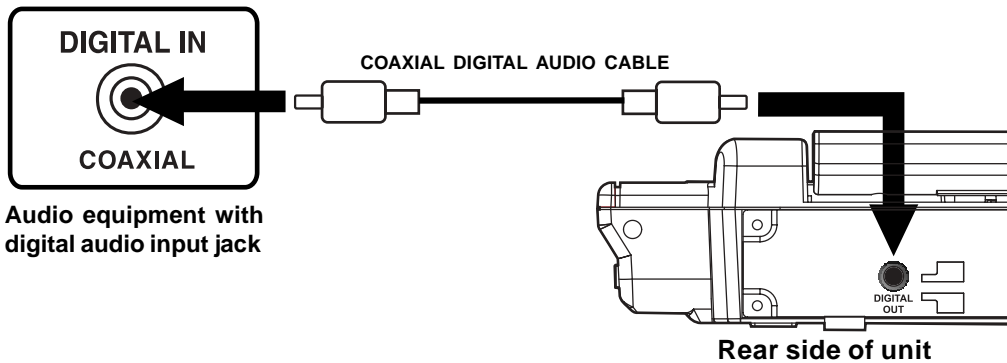

Listening to another audio equipment

1. Turn on the Unit.
2. Turn on your audio equipment and follow the instructions included with it to select the AUDIO IN or DIGITAL IN function.

Notes:

- You may experience interference if the radio tuner function is selected while the television is working.
- Make sure to use the correct Audio/Video cable, connecting the plugs incorrectly may cause a weak signal.
- If you have a stereo VCR, make sure you set it to stereo mode.
- Due to copyright protection, DVD movies cannot be copied. If you copy a DVD movie onto a videotape, the resulting copy will be unclear, with poor sound quality. This is NOT caused by a defective DVD system.

CONNECTING OTHER EQUIPMENT

Using Headphones/Earphones

- Turn down the volume before connection, and then adjust the level.
- When headphones/earphones are connected, no sound will be emitted from the unit's speakers.

Caution:

- Avoid listening to sound at levels which may be harmful to your ears.

Note:

- When headphones are connected to the unit, the speakers are automatically disabled.

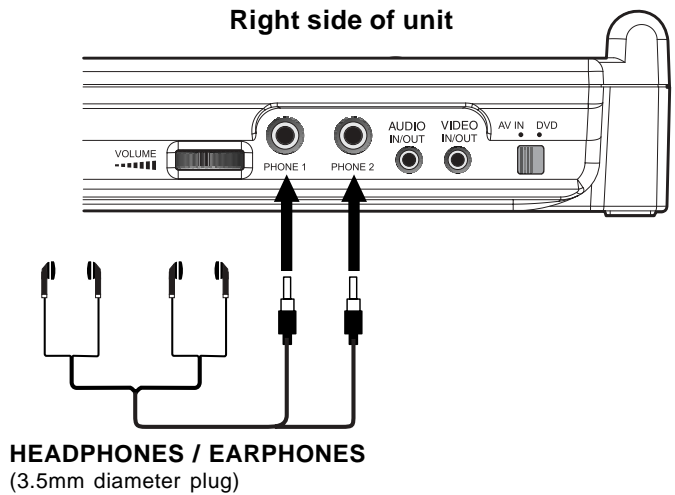

ADJUSTING THE SOUND

Dolby Digital (for DVD)

Dolby Digital is a sound system developed by Dolby Laboratories Inc. that gives movie theater ambiance to audio output when the unit is connected to a Dolby Digital 5.1 channel processor or amplifier.

This unit automatically recognizes DVDs that have been recorded with Dolby Digital.

Not all Dolby Digital sources are recorded with 6 channels.

Some sources marked Dolby Digital may be recorded in Dolby Surround, a 2 channel system. Look for this logo on your unit.



Manufactured under license from Dolby Laboratories.

'Dolby' and the double-D symbol are trademarks of Dolby Laboratories.

This owner's manual explains the basic instructions of this unit. Some DVD discs are produced in a manner that allows specific or limited operation during playback. As such, the unit may not respond to all operating commands. This is not a defect in the unit. Refer to the instructions accompanying the DVD disc.

“” may appear on the screen during operation. A “” means that the desired operation is not permitted by the unit or disc.

Playing a Disc

1. Slide the **POWER ON/OFF** switch on the left side of unit to ON.
2. Slide the **AV IN / DVD** switch on the right side of unit to select DVD mode.

See **CUSTOMIZING THE FUNCTION SETTINGS** (page 25 to 28) before proceeding to step 3.

3. Push the **OPEN** switch to open the disc door.
4. Hold the disc by its sides and carefully place it onto the central spindle in the disc compartment, with the label side facing up; press the disc down until you hear a “click”.
5. Push the door to close.
It takes a short while for your unit to load the disc. After loading, the unit will automatically start playing most DVDs.
6. If the DVD does not start automatically, press the **▶ PLAY** button.

Pausing playback (still mode)

Press the **⏸ PAUSE** button. To resume normal playback, press the **▶ PLAY** button.

Stopping playback

Press the **■ STOP** button to interrupt playback. To resume playback, press the **▶ PLAY** button.

If you press the **■ STOP** button twice, the unit's memory will be cleared and pressing the **▶ PLAY** button will reset the disc to the beginning.

Skipping to a different track

- Press the **⏮ PREV** button repeatedly to skip to the start of the current or previous track.
- Press the **⏭ NEXT** button to skip to the next track.
- For audio CD disc, use the number buttons (remote control only) to jump to a particular track number.

PLAYING A DISC

Fast Forward/Fast Reverse

1. Press the **SEARCH ►►** or **◄◄ SEARCH** button of the remote unit when a disc is playing.

- The disc begins fast scan at x2 speed.
- Four speeds are available. Each time **SEARCH ►►** or **◄◄ SEARCH** button is pressed, the speed of fast scan changes in the following sequence: ►► x 2 → ►► x 4 → ►► x 8 → ►► x 20

The speed of fast scan

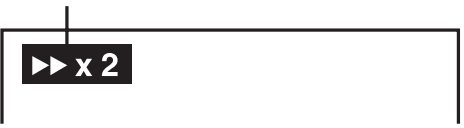

Note :

You also can press and hold **◄◄ / ►►** (PREV/NEXT) buttons on unit repeatedly to select different fast scan speeds.

2. Press the **► PLAY** button to resume playback at normal speed.

SKIP (Forward / Reverse)

While you are playing a disc, press the **►► NEXT** button to move to the beginning of the next chapter or track. Press the **◄◄ PREV** button to move to the previous chapter or track and automatically start playing it.

Zooming into an image

While a disc is playing, press the **ZOOM** button of unit.

- While an image is zoomed, you can use **▲**, **▼**, **◄** and **►** button to shift the view and display the part you want.
- To return to the normal view, press the **ZOOM** button until the “**Qoff**” symbol shows.

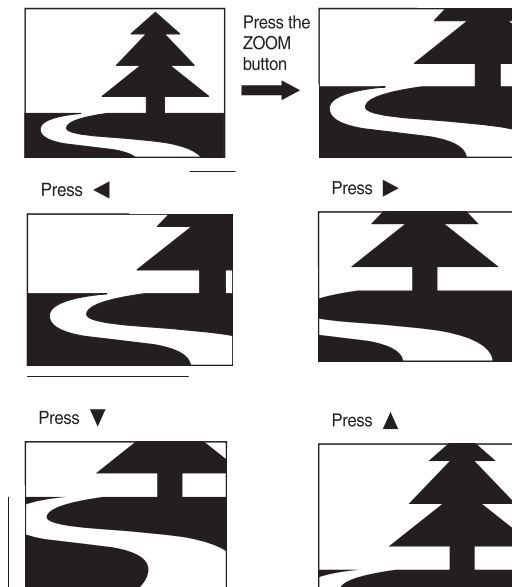

- When you reach the edge of the image, the display will not move anymore in that direction.

Angle selection

Some DVDs contain scenes which have been shot from a number of different angles. For these discs, the same scene can be viewed from each of these different angles.

1. While you are playing a DVD with different angles recorded, press the **ANGLE** button to view the number of the current angle.

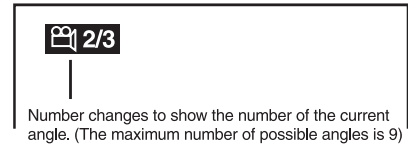

2. Press the **ANGLE** button repeatedly to change the scene to the next angle from those recorded.
 - About two seconds later, playback continues from the new angle you selected.
 - If no button is pressed within 10 seconds, playback continues without changing the current angle.

Sequence of angle shots (Example)

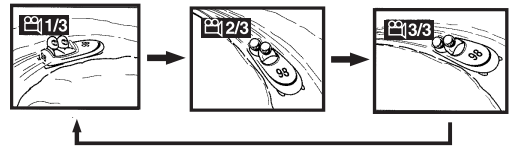

Notes:

- This function can only be used for discs on which scenes shot from multiple angles have been recorded.
- If only one angle is recorded, “ 1/1 ” is displayed, when the Angle button is pressed.

Audio selection

On some discs, the sound is recorded in two or more formats. Follow the directions below to select the type of playback.

1. While a disc is playing, press the **AUDIO** button to show the current audio format number.
2. Press the **AUDIO** button repeatedly to select the desired audio format.
 - About two seconds later, playback continues in the new audio format.

Notes :

- If only one audio format is recorded, the number does not change.

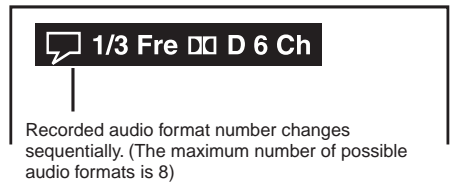

Subtitle selection

1. While a DVD is playing, press the **SUBTITLE** button to display the current language setting, as shown in the example below.

1/3 Eng → 2/3 Spa → 3/3 Fre → Off

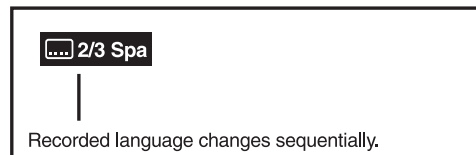

2. Press the **SUBTITLE** button repeatedly to select the desired subtitle language.

Notes :

- If only one language is recorded, the language does not change.
- About two seconds later, playback continues with the new subtitle you selected.
- The number of languages recorded differs depending on the disc.
- If no button is pressed within a few seconds, playback continues without changing the current subtitle.
- This function can only be used for discs on which subtitles have been recorded in multiple languages.
- On some DVDs, subtitles are activated from the main menu of the DVD. Press the **MENU** button to activate the main menu.

DISPLAY function

Using DISPLAY, you can check and change the current settings of the following : ANGLE, AUDIO and SUBTITLE.

- While the disc is playing, press the **DISPLAY** button of the remote unit to display the screen shown below.

Elapsed time: Elapsed time from the beginning of the chapter which is currently playing.

Remaining time: Remaining time of the title which is currently playing.



- Press the **DISPLAY** button twice on the remote unit to display the screen shown below.
- Press the **ANGLE**, **AUDIO** or **SUBTITLE** button to change the selected item.

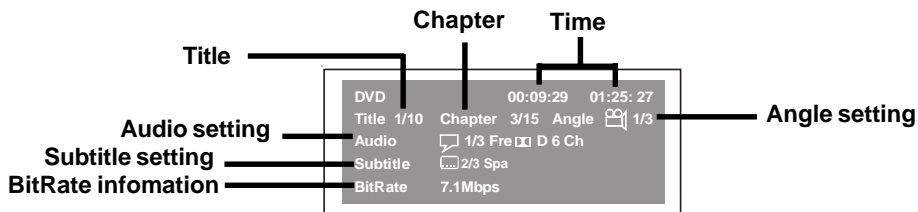

Title skip

- The number of the title currently playing and total titles of disc.
- Press the **GOTO** button to set your desired title, then press the **ENTER** button to confirm.

Chapter skip

- The number of the chapter currently playing and total chapters of the currently played title.
- Press the **GOTO** button to set your desired chapter, then press the **ENTER** button to confirm.

Time skip

- Elapsed time from the beginning of the currently playing chapter and the remaining time from the beginning of the currently playing title.
- Press the **GOTO** button to set your desired point to start playback, then press the **ENTER** button to confirm.

Angle setting

- The current angle is displayed. When a disc with only one angle is played back, "Angle 1/1" is displayed.
- Press the **ANGLE** button to select the desired angle.

Audio setting

- The type of audio currently selected is displayed.
- Press the **AUDIO** button to select your desired type of audio.

Subtitle setting

- The subtitle number and language currently selected is displayed. When a disc with only one subtitle is played back, "1/1 Eng" is displayed.
- Press the **SUBTITLE** button to select your desired language.

GOTO function

This function allows you to skip directly to any part of the disc while a disc is playing.

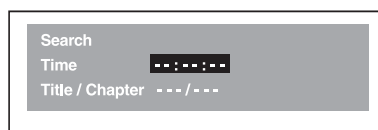

Note :

- After setting, press the **DISPLAY** button again on the remote unit to return to the normal screen.

Locating a specific title

If a DVD disc contains title numbers, you can locate a specific title by directly selecting a title number.

1. Press the **GOTO** button.
2. Press **▼**, **◀** or **▶** button to highlight a specific field and press the corresponding number button(s) for the title you want.
3. Press the **ENTER** button to confirm. The unit will start playback about 3 seconds later.

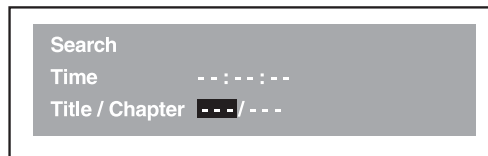

Locating a specific title / chapter / track

If you know the title / chapter / track number you want to play, you can locate a specific title / chapter / track by directly selecting a title / chapter / track number.

1. Press the **GOTO** button to search your desired title / chapter / track.
2. Press **▼**, **◀** or **▶** button to highlight a title / chapter / track and press the corresponding number button(s) for the chapter you want.
3. Press the **ENTER** button to confirm. The unit will start playback about 3 seconds later.

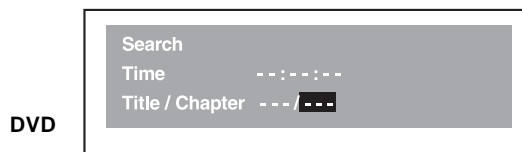

Locating a specific time

You can move to a specific location by entering its corresponding time (hours, minutes, seconds)

1. Press the **GOTO** button.
2. Press **▲** or **▼** button to highlight time.



3. Press the corresponding number buttons for the setting point you want.
 - The first two numbers you entered represent hours.
 - The second two numbers you entered represent minutes.
 - The third two numbers you entered represent seconds.
4. Press the **ENTER** button to confirm. The unit will start playback about 3 seconds later.

Notes :

- Some discs may not respond to this process.
- Some scenes may not be located as precisely as you specified.
- This method for accessing specific locations is available only within the current title of the DVD disc.
- You can move through the menu by pressing the **▲** and **▼** buttons.

Angle setting

1. Press the **DISPLAY** button twice of the remote unit. The **FUNCTION** menu is displayed on the screen and you can see how many angles are recorded on the disc.
2. Press the **ANGLE** button repeatedly to select your desired angle.
3. The unit change to your desired angle at once.

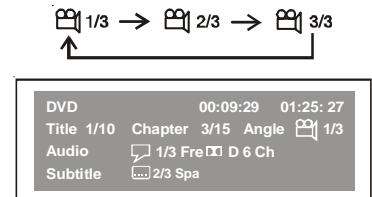

Audio setting

1. Press the **DISPLAY** button twice of the remote unit. The **FUNCTION** menu is displayed on the screen and you can see how many audio formats are recorded on the disc.
2. Press the **AUDIO** button repeatedly to select your desired type of audio.
3. The unit change to your desired type audio at once.

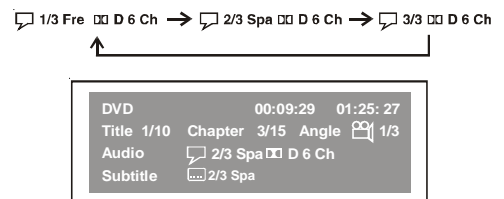

Subtitle setting

1. Press the **DISPLAY** button twice of the remote unit. The **FUNCTION** menu is displayed on the screen and you can see how many subtitle formats are recorded on the disc.
2. Press the **SUBTITLE** button repeatedly to select your desired language.
3. The unit change to your desired language about 3 seconds later.



Programmable memory

The two types of programmed playback provided by this unit are title programmed playback and chapter programmed playback.

Title / Chapter programmed playback

1. Press the **MEM** (Memory) button while the disc is stopped.
2. Enter the title numbers in **--**. Use **◀** or **▶** button to move the highlight to chapter and enter the chapter numbers in **--**.

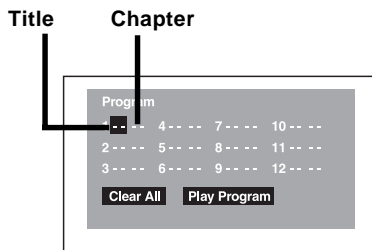

3. Use **◀**, **▶**, **▲** or **▼** button to move to the other field.
4. Repeat steps 2 to 3.
5. Press the **▶ PLAY** button to start the programmed playback.

Notes :

- If you press the **■ STOP** button twice at programmed playback mode, the programmed playback function will be cancelled.

Programmable memory

Track programmed playback

1. Press the **MEM** (Memory) button while the disc is stopped.
2. Enter the track numbers in **---**.

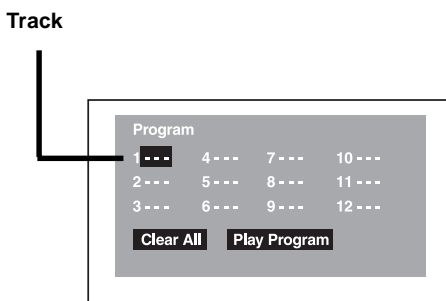

3. Use **◀**, **▶**, **▲** or **▼** button to select other field.
4. Repeat steps 2 to 3.
5. Press the **▶ PLAY** button to start the programmed playback.

You can play a specific title or chapter repeatedly.

(Title repeat, chapter repeat, A-B repeat)

Repeating a title

You can play the same title repeatedly.

1. While the disc is playing, press the **REPEAT DISC** button until the “**Repeat Title**” indicator displays on the screen. The current title is played repeatedly.

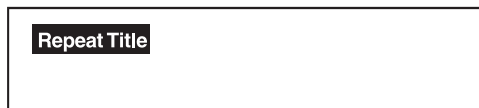

Repeating a chapter

You can play the same chapter repeatedly.

2. While the disc is playing, press the **REPEAT DISC** button until the “**Repeat Chapter**” indicator displays on the screen. The current chapter is played repeatedly.



To resume normal playback

3. While the disc is playing, press the **REPEAT DISC** button until the “**Off**” indicator displays on the screen.

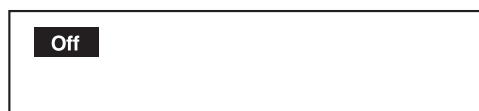

You can play a single track or entire disc repeatedly.

Repeating a single track

You can play the same track repeatedly.

1. While the disc is playing, press the **REPEAT DISC** button until the “**Repeat Single**” indicator displays on the screen. The current track is played repeatedly.



Repeating a whole disc

2. While the disc is playing, press the **REPEAT DISC** button until the “**Repeat All**” indicator displays on the screen. The whole disc is played repeatedly.

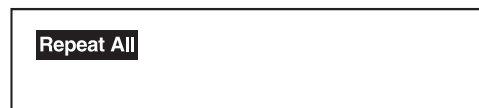

To resume normal playback

3. Press the **REPEAT DISC** button until the “**Off**” indicator displays on the screen.



Repeating a specific section

You can play a specific section repeatedly.

1. While the disc is playing, press the **REPEAT A-B** button at the beginning of the section ((**Rep A-**) is displayed) you want to play repeatedly.
2. Press the **REPEAT A-B** button again at the end of the section ((**Rep A-B**) is displayed).
3. The Unit will immediately begin replaying your selection.

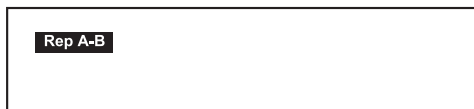
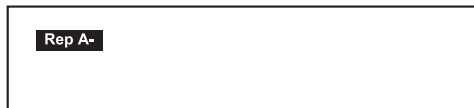

To resume normal playback

4. While the disc is playing, press the **REPEAT A-B** button until the "**Off**" indicator displays on the screen.

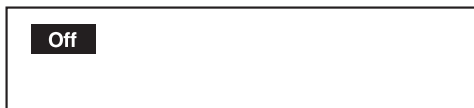

Notes :

- A-B repeat can only be used within the same title. If the start and end of the section to be repeated are in different titles, A-B repeat is cancelled.
- The A-B repeat function does not operate in scenes where different camera angles are recorded.

PLAYING MP3 AND DIGITAL PICTURE FILES

This unit can play MP3 and Picture files recorded on CD-R and CD-RW discs.

Playing MP3 files

1. Push the **OPEN** switch to open the disc door.
2. Hold a MP3 file disc by its sides and carefully fit it onto the central spindle in the disc compartment with the label side facing up. Press down until you hear a “click”.
3. Push the door to close.
4. The unit will take a short while to load the disc, automatically begin playback and display the MP3 files.
5. Press the **▲**, **▼**, **◀** or **▶** CURSOR button to view and select the file, you want to listen to then press **ENTER** to confirm. The selected file will be played.

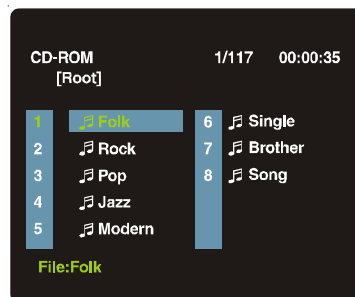

To pause playback

- Press the **⏸PAUSE** button. To resume playback, press the **▶PLAY** button.

To stop playback

- Press the **■STOP** button.

To skip to the next or previous file

- Press the **▶▶NEXT** button on the remote control or on the top of unit briefly while playing, to skip ahead to the beginning of the next file. Each time you press the button, the beginning of the next file is located and played back.
- Press the **◀◀PREV** (Previous) button on the remote control or on the top of unit briefly while playing, to skip back to the beginning of the previous file. Each time you press the button, the beginning of the previous file is located and played back.
- You also can press the **GOTO** button, set the track number you want and then press the **ENTER** button.

1. You can not play in Fast reverse or Fast forward during MP3 playback.
2. During MP3 playback, if you press the **■STOP** button twice and then press **▶PLAY** button again, it will start to play from the beginning of the file. If you press the **■STOP** button once and then press **▶PLAY** button again. It will resume playback from the location where you stopped playback.

Notes:

The ability of this unit to read MP3 discs is dependent on the following:

- The Bit Rate must be within 64 - 256 kbps.
- The total number of files on the disc should not exceed 254.
- The maximum number of directories should not exceed 32.
- The maximum depth level of directories should not exceed 4.
- File names should be named using 7 or fewer letters and/or numbers, and must incorporate the “MP3” file extension. EXAMPLE: *****.MP3 where each * is a letter or number.
- Use only letters and / or numbers in file names. If you use special characters, the file and/or folder names may not be displayed correctly on the screen.
- When recording on CD-R discs, use 74-minute (650MB) discs.
- The CD-R or CD-RW discs should be “finalized” using “single session format”.
- See your CD/MP3 creation software for details.

PLAYING MP3 AND DIGITAL PICTURE FILES

Playing Digital Picture files

1. Push the **OPEN** switch to open the disc door.
2. Hold the Picture disc by its sides and carefully fit it onto the central spindle in the disc compartment with the label side facing up. Press down until you hear a “click”.
3. Push the door to close.
4. The unit will take a short while to load the disc.
5. Press the **▶PLAY** button. The first picture will automatically display after 6 seconds.

Full-Screen Review

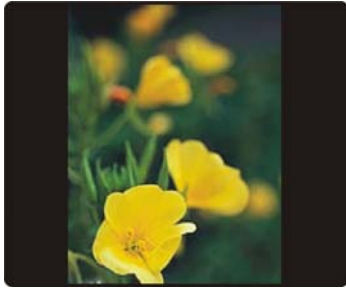

Thumbnail Review

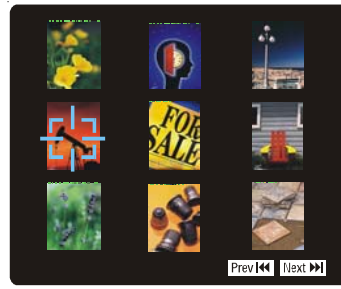

Notes:

- If you press the **MENU** button on the remote in full-screen review, the Unit will display a menu of 9 thumbnail images.
- Use the **cursor** to highlight **▶▶NEXT** or **◀◀PREV** in thumbnail screen and then press the **ENTER** button to review other images. If you want to review one image in full-screen, you can use the **CURSOR** **◀, ▶, ▲** or **▼** buttons to highlight the image and then press the **ENTER** button to confirm. The image you selected will show on TV in Full-Screen and automatically display one by one again in about 6 seconds intervals.
- You can press the **PAUSE** button to interrupt playback, and press the **▶PLAY** button to resume playback.
- You also can use **GOTO** function or use the numbered buttons to enter the number to quickly select any image.
- You can press the **ZOOM** button to enlarge the picture in 3 levels.
- Press the **ANGLE** button on the remote control to rotate the picture orientation by 90°.

Playing MP3/Digital Picture files

1. Slide the **OPEN** switch to open the disc door.
2. Hold a MP3 files/Picture disc by its sides and carefully fit it onto the central spindle in the disc compartment with the label side facing up. Press down until you hear a “click”.
3. Push the door to close.
4. The unit will take a short while to load the disc.
5. Press the **▶PLAY** button, the MP3 titles or JPG files will be played one by one.

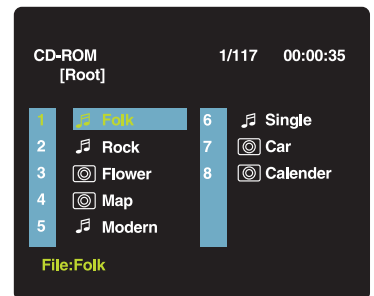

CUSTOMIZING THE FUNCTION SETTINGS

LANGUAGE setting

1. Press the **SETUP** button in stop mode.
2. Use **▲** or **▼** button to highlight your desired language, then press the **ENTER** button. The screen will change to your selected language.
3. To exit the **SETUP MENU** and return to the normal screen, press the **RETURN** button.

STEP 2

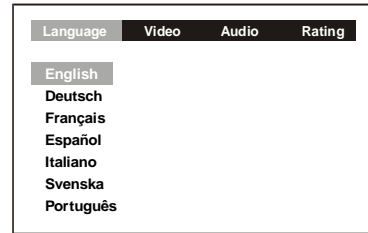

VIDEO setting

TV Shape

1. Press the **SETUP** button in stop mode.
2. Use **◀** or **▶** button to select **Video**, then press the **ENTER** button.
3. Use **▲** or **▼** button to select TV Shape, then press the **ENTER** button.
4. Use **▲** or **▼** button to shift and select the TV type, then press the **ENTER** button.
5. To exit the **FUNCTION SETUP MENU** and return to the normal screen, press the **RETURN** button.

STEP 2

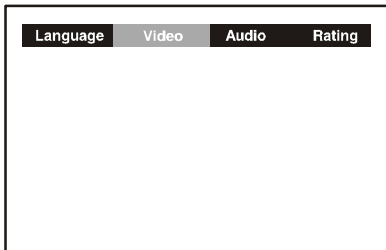

STEP 3

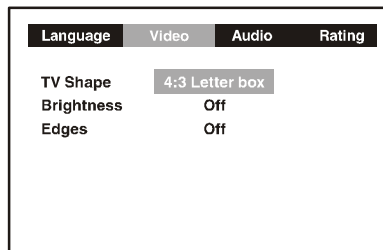

STEP 4

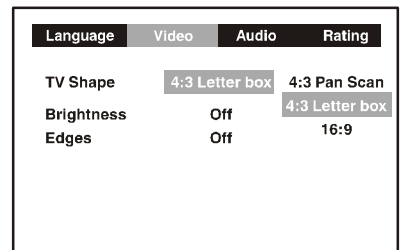

Cut off when a wide-screen video image is played.

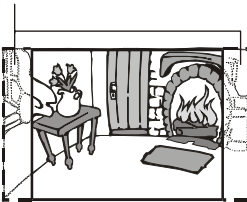

4:3 Pan Scan

- When wide-screen video material is played, this mode clips the right and left sides of the image so that it can be viewed on a conventional screen.
- Some wide-screen DVDs do not permit Pan Scan playback. These movies are automatically played in letterbox mode (black bands top and bottom).

4:3 Letter Box

- When wide-screen video material is played in this mode on a conventional screen, black bands appear at the top and bottom of the screen.

16:9 Wide-screen

- This is the correct mode for playing wide-screen videos on a wide-screen.

Notes :

- The picture size is preset on the DVD disc. Therefore the playback picture of some DVD discs may not conform to the picture size you selected.
- When you play DVD discs recorded in the 16:9 picture size only, the playback picture always appears in the 16:9 picture size regardless of the TV shape setting.

CUSTOMIZING THE FUNCTION SETTINGS

Brightness

1. Press the **SETUP** button in stop mode.
2. Use ◀ or ▶ button to select **Video**, then press the **ENTER** button.
3. Use ▲ or ▼ button to select **Brightness**, and then press the **ENTER** button.
4. Use ▲ or ▼ button to shift and select the **Off/On**, then press the **ENTER** button.
5. If you want to exit the **SETUP MENU** and return to the normal screen, press the **RETURN** button.

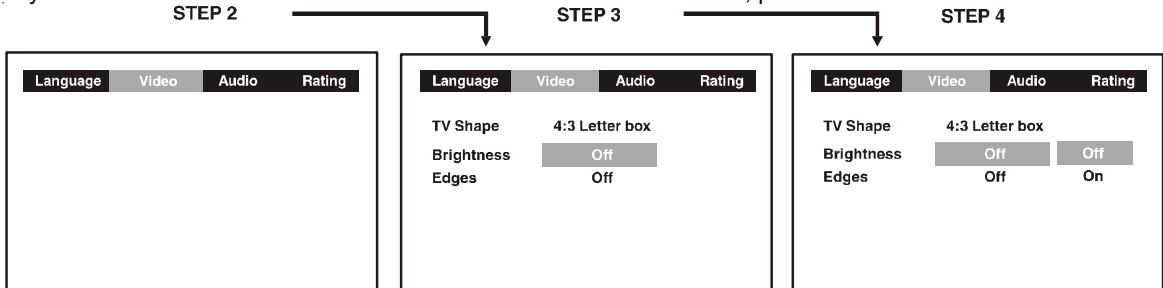

On : Picture will be brighter to clarify details.

Off : Picture will have deepened colors.

Edges

1. Press the **SETUP** button in stop mode.
2. Use ◀ or ▶ button to select **Video**, then press the **ENTER** button.
3. Use ▲ or ▼ button to select **Edges**, and then press the **ENTER** button.
4. Use ▲ or ▼ button to shift and select the **Sharpen / Soften / Off**, then press the **ENTER** button.
5. If you want to exit the **SETUP MENU** and return to the normal screen, press the **RETURN** button.

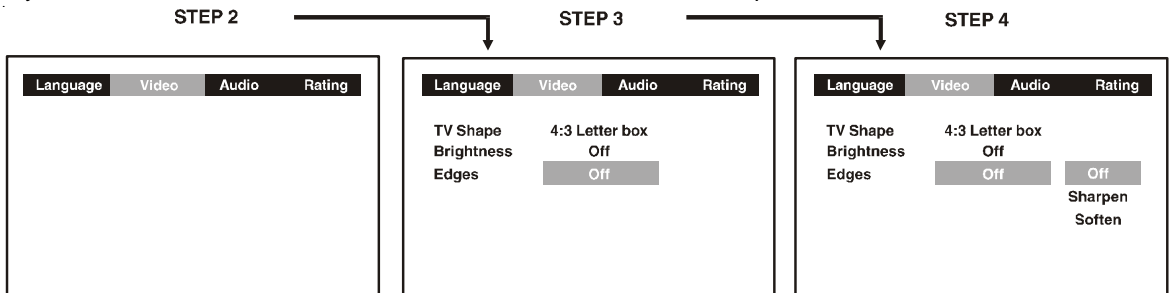

Sharpen : Fine detail will be easier to see.

Soften : Soft-focus effect.

Off : Picture will be returned to normal.

AUDIO setting

Digital Out

1. Press the **SETUP** button in stop mode.
2. Use ◀ or ▶ button to select **Audio**, press the **ENTER** button.
3. Press the **ENTER** button repeatedly to select Digital Out type.
4. To exit the **FUNCTION SETUP MENU** and return to the normal screen, press the **RETURN** button.

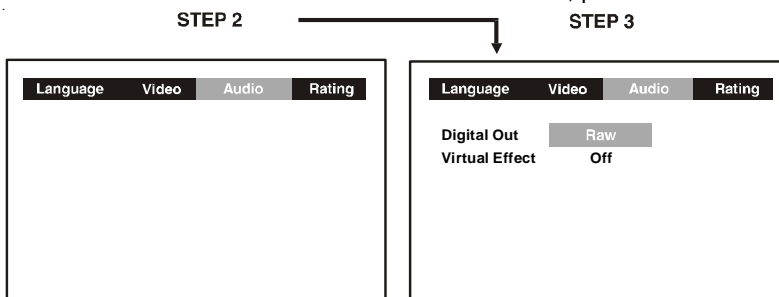

Raw : Dolby Digital decoded.

PCM : Dolby Digital decoded.

CUSTOMIZING THE FUNCTION SETTINGS

Virtual Effect (for CD and DVD only)

This function provides virtual surround sound effects from just two speakers.

1. Press the **SETUP** button in stop mode.
2. Press ◀ or ▶ button to select **Audio**, press the **ENTER** button.
3. Press ▲ or ▼ button to select **Virtual Effect**, then press the **ENTER** button.
4. Press ▲ or ▼ button to select ON or OFF, then press the **ENTER** button.
5. Press **RETURN** button to exit SETUP MENU

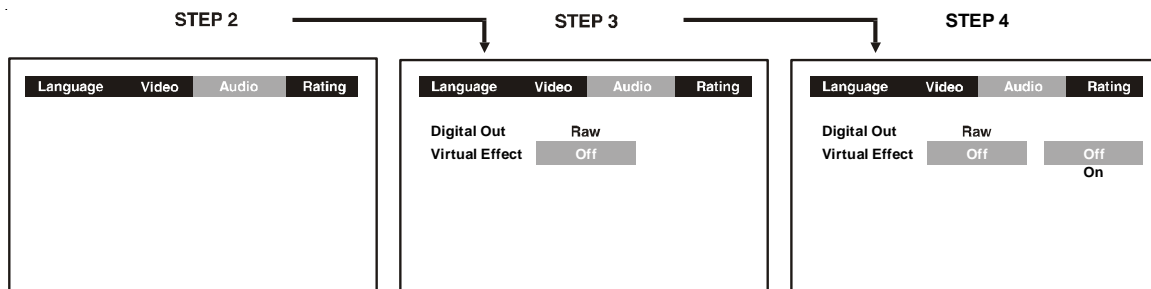

RATING setting

Factory Reset

If you want to reset all the settings to the factory default, do the following:

1. Press the **SETUP** button in stop mode.
2. Use ◀ or ▶ button to select the Rating, then press the **ENTER** button.
3. Use ▲ or ▼ button to shift and select the Factory Set, then press the **ENTER** button.
4. Use ▲ or ▼ button to shift and select Yes, then press the **ENTER** button.
5. To exit the SETUP MENU and return to the normal screen, press the **RETURN** button.

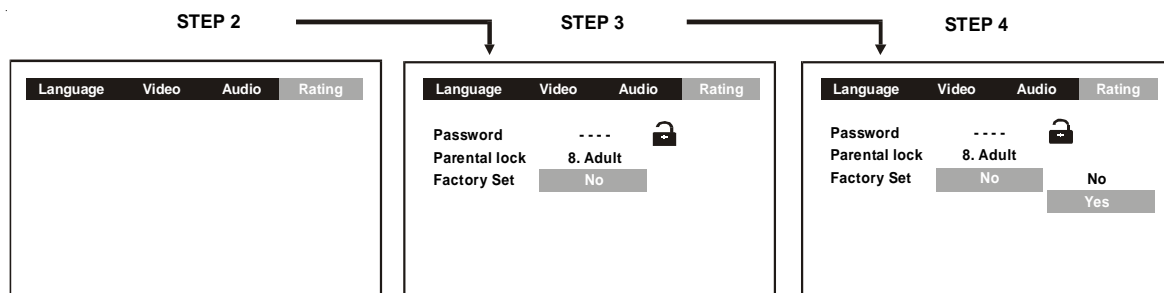

Note:

When you reset the Unit to the factory default, the Unit will take 3-5 seconds to reset.

CUSTOMIZING THE FUNCTION SETTINGS

Password/Parental lock

DVD discs equipped with the password function are rated according to their content. This function may vary from DVD to DVD. It's ability to block content is dependent on the rating assigned by the movie manufacturer.

For example, if the disc allowed, you could edit out violent scenes unsuitable for children and replace them with more suitable scenes, or you could lock out playback of the disc altogether.

1. Press the **SETUP** button in stop mode.
2. Use ◀ or ▶ button to select Rating, press the **ENTER** button.
3. Use ▲ or ▼ button to select parental lock and then press the **ENTER** button repeatedly to set the parental lock level.
4. Use ▲ or ▼ button to shift and select Password, enter your 4-digit security code and then press the **ENTER** button.

You cannot play DVD discs rated higher than the level you selected unless you cancel the parental lock function.

The parental lock level is equivalent to the following ratings.

Level 1 : Kid Safe	Level 5 : PG/R
Level 2 : G	Level 6 : R
Level 3 : PG	Level 7 : NC_17
Level 4 : PG_13	Level 8 : Adult

5. To exit the SETUP MENU and return to the normal screen, press the **RETURN** button.



Indicates Parental lock is NOT active.



The Parental lock is active.

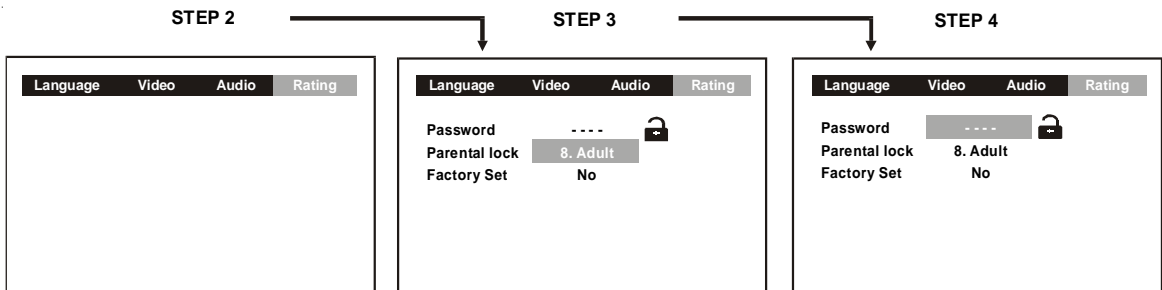

If you forget the password, you can erase your current password by pressing number button 8 on the remote four times, then press the ENTER button to confirm the setting.

PASSWORD : 8 8 8 8

LANGUAGE CODE LIST FOR DISC LANGUAGE

Code	Language Name	Code	Language Name	Code	Language Name	Code	Language Name
AA	Afar	FY	Frisian	MG	Malagasy	SL	Slovenian
AB	Abkhazian	GA	Irish	MI	Maori	SM	Samoan
AF	Afrikaans	GB	Scots Gaelic	MK	Macedonian	SN	Shona
AM	Ameharic	GL	Galician	ML	Malayalam	SO	Somali
AR	Arabic	GN	Guarani	MN	Mongolian	SQ	Albanian
AS	Assamese	GU	Gujarati	MO	Moldavian	SR	Serbian
AY	Aymara	HA	Hausa	MR	Marathi	SS	Siswat
AZ	Azerbaijani	HI	Hindi	MS	Malay	ST	Sesotho
BA	Bashkir	HR	Croatian	MT	Maltese	SU	Sundanese
BE	Byerlorussian	HU	Hungarian	MY	Burmese	SV	Swedish
BG	Bulgarian	HY	Armenian	NA	Nauru	SW	Swahili
BH	Bihari	IA	Interlingua	NE	Nepali	TA	Tamil
BI	Bislama	IE	Interlingue	NL	Dutch	TE	Telugu
BN	Bengali	IK	Inupiak	NO	Norwegian	TG	Tajik
	Bangla	IN	Indonesian	OC	Occitan	TH	Thai
BO	Tibetan	IS	Icelandic	OM	(Afan) Oromo	TI	Tigrinya
BR	Breton	IT	Italian	OR	Oriya	TK	Turkmen
CA	Catalan	IW	Hebrew	PA	Panjabi	TL	Tagalog
CO	Corsican	JA	Japanese	PL	Polish	TN	Setswana
CS	Czech	JI	Yiddish	PS	Pashto, Pushto	TO	Tonga
CY	Welsh	JW	Javanese	PT	Portuguese	TR	Turish
DA	Danish	KA	Georgian	QU	Quechua	TS	Tsonga
DE	German	KK	Kazakh	RM	Rhaeto- Romance	TT	Tatar
DZ	Bhutani	KL	Greenlandic	RN	Kirundi	TW	Twi
EL	Greek	KM	Cambodian	RO	Romanian	UK	Ukrainian
EN	English	KN	Kannada	RU	Russian	UR	Urdu
EO	Esperanto	KO	Korean	RW	Kinyarwanda	UZ	Uzbek
ES	Spanish	KS	Kashmiri	SA	Sanskrit	VI	Vietnamese
ET	Estonian	KU	Kurdish	SD	Sindhi	VO	Volapük
EU	Basque	KY	Kirghiz	SG	Sangho	WO	Wolof
FA	Persian	LA	Latin	SH	Serbo- Croatian	XH	Xhosa
FI	Finnish	LN	Lingala	SI	Singhalese	YO	Yoruba
FJ	Fiji	LO	Laothian	SK	Slovak	ZH	Chinese
FO	Faroese	LT	Lithuanian			ZU	Zulu
FR	French	LV	Latvian, Lettish				

MAINTENANCE

Cleaning Disc

A defective or soiled disc inserted into the unit can cause sound to drop out during playback.

Handle the disc by holding its inner and outer edges.

- Do NOT touch the surface of the unlabeled side of the disc.
- Do NOT stick paper or tape on the surface.
- Do NOT expose the disc to direct sunlight or excessive heat.
- Clean the disc before playback. Wipe the disc from the center outward with a cleaning cloth.
- NEVER use solvents such as benzine or alcohol to clean the disc.
- Do NOT use irregular shaped discs (example : heart shaped, octagonal, etc.). They may cause malfunctions.

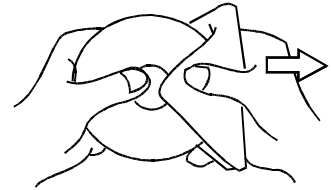

Cleaning the unit

- Be sure to turn the unit off and disconnect the AC power cord before maintaining the unit.
- Wipe the unit with a dry soft cloth.
If the surfaces are extremely dirty, wipe clean with a cloth which has been dipped in a weak soap-and-water solution and wrung out thoroughly, then wipe with a dry cloth.
- Never use alcohol, benzine, thinner, cleaning fluid or other chemicals. Do NOT use compressed air to remove dust.

Important Note

Before transporting the unit, remove disc from the disc compartment.

TROUBLE SHOOTING GUIDE

SYMPTOM

CAUSE (AND REMEDY)

No power.

- Check that the Car plug adapter or AC adapter and AC power cord are connected.
- Turn on the unit.

The remote does not function.

- Remove any obstacles between the remote and the unit.
- Use the remote near the unit.
- Point the remote at the remote sensor on the unit.
- Replace the battery in the remote.

DVD

No sound or only a very low-level sound is heard.

- Make sure that you've select DVD mode.
- The system is in pause mode or in Slow-motion Play mode. Press the ► **PLAY** button to return to normal play mode.
- Fast forward or fast reverse is performed. Press the ► **PLAY** button to return to normal play mode.
- Make sure that AUDIO output and AV IN input connections are correct.
- DTS encoded DVDs are not decoded by this unit. Use the "AUDIO" button to select a different audio playback mode.
- This unit is too hot, shut off the unit for 30 minutes to cool down.

No picture.

- The region number of the disc does not match the region number of the unit.



- DVD mode is not selected, select DVD on AV IN/DVD switch.

The picture is not clear.

- Clean the disc.
- The disc is scratched.

Severe hum or noise is heard.

- The plugs and jacks are dirty. Wipe them with a cloth slightly moistened with alcohol.
- Clean the disc.

The disc does not play.

- There is no disc inside ("No Disc" appears on the Monitor screen).
- Insert the disc correctly with the playback side facing down on the disc tray.
- Clean the disc.
- A non-NTSC or PAL disc has been inserted. The Unit and disc region numbers are incompatible. Press the **TV MODE** button on the remote to output the video signal.
- Condensation may have formed inside the Unit due to a sudden change in temperature. Wait about an hour for it to clear and try again

**Need More
Help?**

DO NOT RETURN THIS TO THE STORE
Please call Customer Service at 1-800-252-6123 (ET)
or visit online help at <http://www.18002526123.com>