

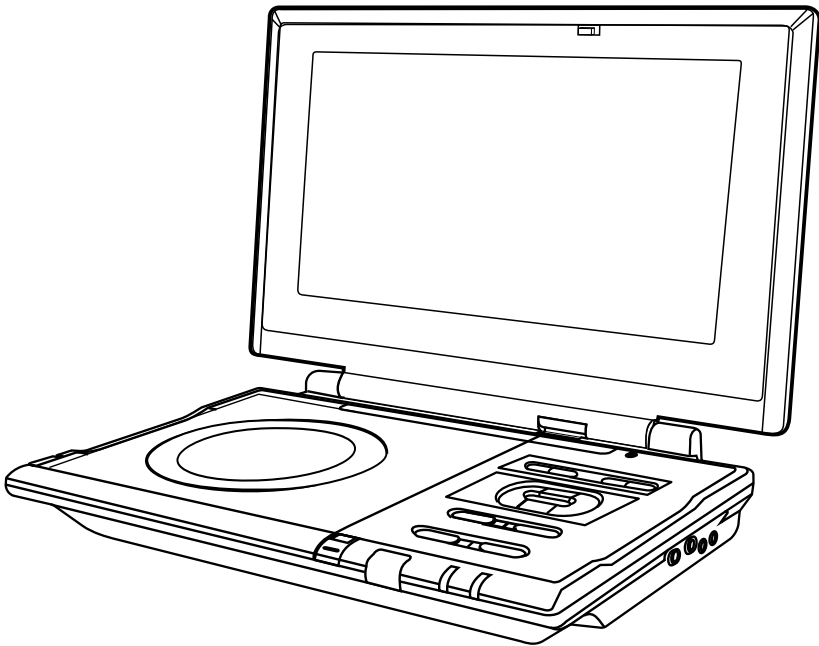

**Kawasaki™**

PVS10921 Q

## Portable DVD Player with LCD Display



KC-3281

---

**OWNER'S MANUAL**

# SAFETY PRECAUTIONS

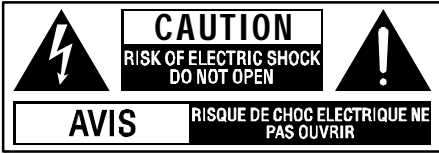

**WARNING: TO REDUCE THE RISK OF ELECTRIC SHOCK, DO NOT REMOVE COVER (OR BACK). NO USER-SERVICEABLE PARTS INSIDE. REFER SERVICING TO QUALIFIED SERVICE PERSONNEL.**

**WARNING: TO PREVENT FIRE OR SHOCK HAZARD, DO NOT EXPOSE THIS APPLIANCE TO RAIN OR MOISTURE.**

**CAUTION: TO PREVENT ELECTRIC SHOCK, MATCHWIDE BLADE OF PLUG TO WIDE SLOT, FULLY INSERT.**

**DANGER OF EXPLOSION IF BATTERY IS INCORRECTLY REPLACED. REPLACE ONLY WITH THE SAME OR EQUIVALENT TYPE.**



The lightning flash with an arrowhead symbol, within the equilateral triangle, is intended to alert the user to the presence of uninsulated "dangerous voltage" within the product's enclosure that may be of sufficient magnitude to cause an electric shock.



The exclamation point within the equilateral triangle intended to alert the user to the presence of important operating and maintenance (servicing) instructions in this owner manual.

**\* SEE BOTTOM OF UNIT FOR GRAPHIC SYMBOLS \***



This product contains a low power laser device.



The symbol for Class II (Double Insulation)

## On Placement

- Do not use the unit in places which are extremely hot, cold, dusty, or humid.
- Place the unit on a flat and even surface.
- Do not restrict the air flow of this unit by placing it somewhere poor air flow, by covering it with a cloth, or by placing it on bedding or carpeting.

## FCC Information

This device complies with Part 15 of FCC Rules. Operation is subject to the following two conditions:

- (1) This device may not cause harmful interference, and
- (2) This device must accept any interference received, including interference that may cause undesirable operation.

"Warnings: Changes or modifications to this unit not expressly approved by the party responsible for compliance could void the user authority to operate the equipment."

## On Safety

- When connecting or disconnecting the AC cord, grip the plug and not the cord itself. Pulling the cord may damage it and create a hazard.
- When you are not going to use the unit for a long period of time, disconnect the AC power cord.

## On Condensation

- When left in a heated room where it is warm and damp, water droplets or condensation may form inside the unit. When there is condensation inside the unit, the unit may not function normally. Let the unit stand for 1 to 2 hours before turning the power on, or gradually heat the room and let the unit dry before use.

## Rating Plate Location

- The rating plate is located on the bottom of unit.

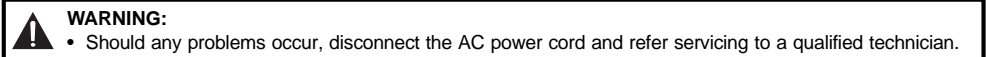

## Notes on Copyright

It is forbidden by law to copy, broadcast, show, broadcast on cable, play in public, rent copyrighted material without permission.

Apparatus Claims of U.S. Patent Nos. 4,631,603; 4,577,216; 4,819,098 and 4,907,093 licensed for limited viewing uses only.

DVD video discs are copy protected, and any recordings made from these discs will be distorted. This product incorporates copyright protection technology that is protected by method claims of certain U.S. patents and other intellectual property rights owned by Macrovision Corporation and other rights owners. Use of this copyright protection technology must be authorized by Macrovision Corporation, and is intended for home and other limited viewing uses only, unless otherwise authorized by Macrovision Corporation. Reverse engineering or disassembly is prohibited.

# IMPORTANT SAFETY INSTRUCTIONS

1. **Read Instructions** - All the safety and operating instructions should be read before you use the unit
2. **Keep the Instructions** - The safety and operating instructions should be kept for future reference.
3. **Pay Attention to Warnings** - All warnings on the unit and in this user's manual should be followed.
4. **Follow Instructions** - All operating and use instructions should be followed.
5. **Water and Moisture** - This unit should not be used near water or liquids- for example, near a bathtub, sink, wet basement, swimming pool, lake or ocean, beach, or similar places where there is a chance that the unit may come into contact with water or liquid.
6. **Carts and Stands** - This unit should only be used with a cart or stand that is recommended by the manufacturer.
- 6A. If this unit is placed on a cart, it should be moved with care. Quick stops, excessive force, and uneven surfaces may cause the cart to overturn.
7. **Wall or Ceiling Mounting** - This unit is not designed to be mounted to a wall or ceiling.
8. **Ventilation** - This unit should be situated so that its location or position does not interfere with its proper ventilation. For example, the unit should not be used on a bed, sofa, rug, or similar soft surface which may block the ventilation openings. The unit should also not be built-in to a book case or cabinet, as that may impede the flow of air through the ventilation openings.
9. **Heat** - This unit should be situated away from heat sources such as radiators, heat registers, stoves, or other items (including amplifiers) that produce heat.
10. **Power Sources** - The appliance should be connected to a power supply only of the type described in these instructions or as marked on the unit.
11. **Grounding or Polarization** - Do not try to defeat the grounding or polarization safeguards built into the unit.
12. **Power-Cord Protection** - Power-supply cords should be routed so that they are not likely to be walked on or pinched by items placed on or against them. Pay particular attention to cords at plugs, power outlets, and the point where the cord exits the unit.
13. **Cleaning** - This unit should be cleaned only as recommended by the manufacturer.
14. **Nonuse Periods** - The power cord should be unplugged from the wall outlet when the unit will not be used for a long period of time.
15. **Drops and Spills** - Care should be taken so that objects do not fall on this unit, and liquids are not spilled on or in the unit through openings in its enclosure.
16. **Damage Requiring Service** - This unit should be serviced by qualified personnel when:
  - A. The power-supply cord or the plug has been damaged; or
  - B. Objects have fallen on, or liquid has been spilled into the unit; or
  - C. The unit has been exposed to rain; or
  - D. The unit does not appear to operate normally or there is a noticeable change in its performance; or
  - E. The unit has been dropped, and / or the enclosure damaged.
17. **Servicing** - The user should not attempt to service this unit beyond what is described in these instructions. All other servicing should be referred to qualified personnel.



# TABLE OF CONTENTS

<b>Safety Precautions .....</b>	<b>1</b>	<b>Repeat Playback .....</b>	<b>18</b>
<b>Important Safety Instruction .....</b>	<b>2</b>	Repeating a title/chapter (DVD) .....	18
<b>Table Of Contents .....</b>	<b>3</b>	Repeating a single track/whole disc (CD) .....	18
<b>Disc Formats .....</b>	<b>4</b>	Repeating a specific section (DVD/CD) .....	18
<b>Accessories .....</b>	<b>5</b>	<b>Playing MP3/Digital Picture Files .....</b>	<b>19</b>
<b>Remote Control .....</b>	<b>5</b>	Playing a MP3 / Picture file disc .....	19
<b>Control Reference Guide .....</b>	<b>6-7</b>	<b>Customizing the Function</b>	
<b>Power Supply .....</b>	<b>8-10</b>	<b>Settings .....</b>	<b>20-21</b>
Using the AC adaptor .....	8	LANGUAGE setting .....	20
Using the car power adaptor .....	8	VIDEO setting .....	20
Using the rechargeable battery pack .....	9-10	AUDIO setting .....	21
Turning on the unit .....	10	RATING setting .....	21
<b>Connecting other Equipment .....</b>	<b>11-12</b>	<b>Language Code List for</b>	
Connecting your TV .....	11	<b>Disc Language .....</b>	<b>22</b>
Connecting to a stereo receiver .....	11	<b>Maintenance .....</b>	<b>23</b>
Using headphone/earphones .....	12	Cleaning Disc .....	23
<b>Adjusting the Sound .....</b>	<b>12</b>	Cleaning the Unit .....	23
<b>Playing a Disc .....</b>	<b>13-15</b>	Important Note .....	23
Playing Disc .....	13	<b>Trouble Shooting Guide .....</b>	<b>24</b>
Pausing playback (still mode) .....	13		
Stopping playback .....	13		
To skip to a different track .....	13		
Fast Forward/Fast Reverse .....	14		
Skip (Forward/Reverse) .....	14		
Audio selection .....	14		
Subtitle selection .....	15		
Angle selection .....	15		
<b>Special Functions .....</b>	<b>16</b>		
Display function .....	16		
GOTO function .....	16		
Locating a specific title .....	16		
Locating a specific chapter/track .....	16		
Locating a specific time .....	16		
<b>CD / DVD programmable memory .....</b>	<b>17</b>		
DVD programmable memory .....	17		
CD programmable memory .....	17		

# DISC FORMATS

The unit can playback.



DVDs  
[8cm/12cm disc]



Audio CDs  
[8cm/12cm disc]

CD-R CD-RW  
Compatible



## Region Management Information

Region Management Information: This unit is designed and manufactured to respond to the Region Management Information that is encoded on DVDs. If the Region number printed on the DVD does not correspond to the Region number of this unit, it cannot play that disc.







The region number of this unit is 1.

## Disc Function or Operation that is Not Available

When the  symbol appears on the screen, it indicates that the function or operation you have selected is not available at that time. This occurs because the DVD manufacturer sets the specific functions of DVDs. Certain functions may not be available on some DVDs. For more information, refer to the documentation provided with the DVD.

## Icons Used on DVDs

Sample Icons

	1. English 2. French	Language selections for audio
	1. English 2. French	Language selections for subtitles
		Screen aspect ratio
		Multiple camera angles
		Region code indicator

### Notes:

- This Unit supports 2-channel (L/R) audio and 5.1ch (Multi-channel) MPEG Audio 1/2. It does not support 7.1 channel MPEG Audio Version 2.0.
- When playing back a CD-G (Graphics) or CD EXTRA disc, the audio portion will be played, but the graphic images will not be shown.

## Title, Chapter and Tracks

- DVDs are divided into “titles” and “chapters”. If the DVD has more than one movie on it, each movie is a separate “title”. Titles are divided into smaller sections called chapters.

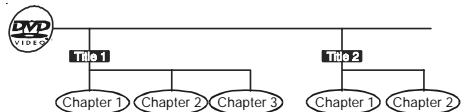

- Audio CDs are divided into “tracks”. Each song is usually one track.

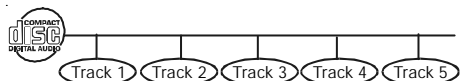

### Note :

- Numbers identify each title, chapter, and track on a disc. Most discs have these numbers recorded on them, but some do not.

### Notes on Unauthorized Discs

You may not be able to play some DVDs on this unit, particularly if they were purchased from outside your geographic area (refer to Region Management Information above), or made for business purposes.

# ACCESSORIES

**Please locate the included accessories:**

- Remote control (with battery) ..... x 1
- AC adaptor ..... x 1
- AC power cord ..... x 1
- Audio/Video cable ..... x 1
- Earphones ..... x 1
- Rechargeable battery pack ..... x 1
- Car power adaptor ..... x 1

## REMOTE CONTROL

### Using the Remote Control

- Point the Remote Control at the REMOTE SENSOR located on the unit.
- When using this unit in very bright light, the infrared REMOTE CONTROL SENSOR may not work properly.
- The recommended effective distance for using the remote control is about 16 feet (5 meters).

Remove the plastic sheet before using the Remote Control.

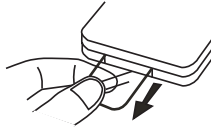

### TO CHANGE THE REMOTE CONTROL BATTERY

1. Open the battery door.

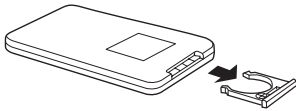

2. Insert one CR2025 (3V) size battery.

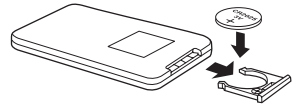

### BATTERY REPLACEMENT

When the battery becomes weak, the operating distance of the Remote Control will be greatly reduced and you will need to replace the battery.

#### Notes:

- If the Remote Control is not going to be used for a long time, remove the battery.



#### WARNING:

- Do not dispose of the battery in a fire or it may leak and/or explode.

# CONTROL REFERENCE GUIDE

## Remote Control

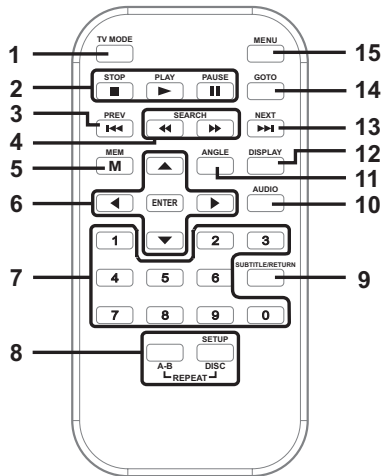

### 1) TV MODE button

In stop mode, select whether to output the video signal in PAL or NTSC. When the TV shows "AUTO" this means the output signal depends on the DVD. If the TV shows "PAL" or "NTSC" the signal is fixed to either "PAL" or "NTSC".

### 2) ■ STOP button

Stop playing a disc.

#### ► PLAY button

Press to start or resume playback a disc.

#### || PAUSE button

Press once to pause playback. Press subsequently to advance the DVD one frame at a time.

### 3) ◀◀ PREV button

Move back through titles, chapters or tracks on a disc.

### 4) ◀◀ / ▶▶ SEARCH buttons

◀◀ SEARCH: Fast reverse playback.

▶▶ SEARCH: Fast forward playback.

### 5) MEMORY button

When the STOP button has been pressed, this feature is used to enter the number of a chapter or track which you wish to save in memory.

### 6) Cursor (▼, ▲, ◀, ▶) buttons

Use to move between selections on a menu screen and adjust certain settings.

#### ENTER button

Confirm selections on a menu screen.

### 7) Number (0 - 9) buttons

Use when creating programmes, and entering a password. Also use to select a CD track directly.

### 8) SETUP button

When a DVD is stopped, brings up the unit's SETUP menu.

### REPEAT A-B / DISC buttons

Perform point-to-point repeat playback on a DVD or CD.

Repeat a DVD chapter or title.

Repeat a CD track or the entire disc.

### 9) SUBTITLE / RETURN button

Select one of the subtitle languages programmed on a DVD (if available).

Return to the normal operation after using the SETUP menu of a DVD.

### 10) AUDIO button

Select one of the audio sound tracks on a DVD (if more than one is available) or select the audio output mode on a CD.

### 11) ANGLE button

Switch between multiple camera angles when the DVD you are playing has been programmed with multiple camera angles.

### 12) DISPLAY button

Show status information on the screen.

### 13) ▶▶ NEXT button

Move forward through titles, chapters or tracks on a disc.

### 14) GOTO button

Skip directly to a location on a DVD.

### 15) MENU button

Enter and exit the main DVD menu.

# CONTROL REFERENCE GUIDE

## Unit

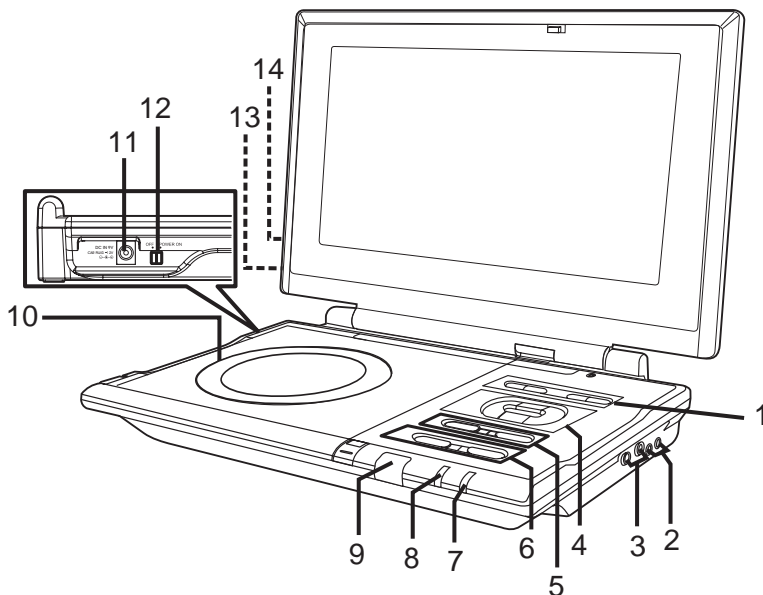

- 1) - **VOLUME + button**  
Adjusts the volume up (+) and down (-).  
**MENU button**  
Open and close DVD's menu.  
**II PAUSE button**  
Press to pause playback of disc. Each time you subsequently press the PAUSE button the picture advances one frame at a time. Press the PLAY ► button to resume playback at normal speed.
- 2) **AUDIO & VIDEO OUT jacks**
- 3) **Headphone jacks**
- 4) **Cursor (▼, ▲, ►, ◀) button**  
Use to move between selections on a menu screen and adjust certain settings.  
**ENTER button**  
Confirm selections on a menu screen.
- 5) **◀◀ PREV button**  
Press ◀◀ PREV button to go back to previous chapters /tracks. Press and hold ◀◀ PREV button to begin fast scan.  
**▶▶ NEXT button**  
Press ▶▶ NEXT button to advance chapters / tracks. Press and hold ▶▶ NEXT button to begin fast forward scan.
- 6) **■ STOP button**  
Stop playing a disc.  
**▶ PLAY button**  
Press to start or resume playback a disc.
- 7) **BATTERY LOW indicator**
- 8) **Power ON indicator**  
When the Power ON/OFF switch is in the ON position, the light will illuminate.
- 9) **Remote sensor**  
Receives the remote control unit signals
- 10) **Disc Door**  
Close door by gently pushing down.
- 11) **DC IN 9V jack**
- 12) **POWER ON/OFF switch**
- 13) **SCREEN switch**  
Wide screen  
Normal screen
- 14) **☼ button**  
Adjust the relative lightness or darkness of the colour.



# POWER SUPPLY

## A. Using the AC adaptor

This AC adaptor operates on AC power between 110V and 240V, but

- In the USA and Canada, the AC power supply cord must be connected to a 120V AC power supply only.
- When connecting to an AC supply outside of the USA and Canada, use a plug adaptor to suit the AC outlet configuration.

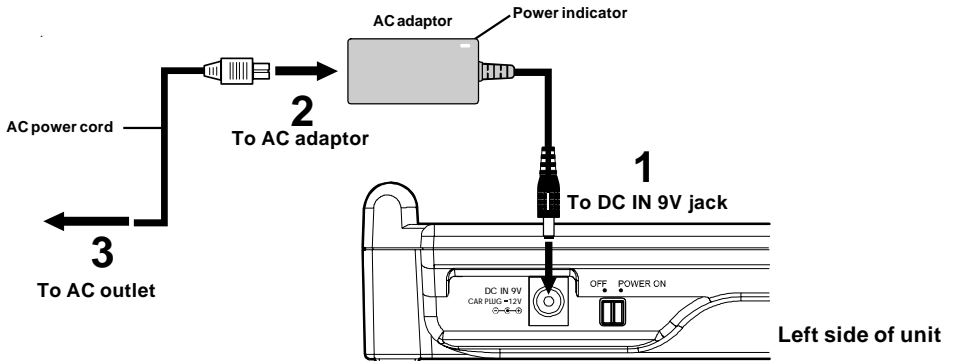

### ⚠ Caution:

- The included AC power supply cord and AC adaptor are for use with this unit only. Do not use them with other equipment.
- If you are not going to be use the unit for a long time, disconnect the power cord from the outlet.
- Whenever the AC power supply cord and AC adaptor are plugged in to a power outlet, electricity is running through the unit, even when the power switch is turned off.

## B. Using the Car power adaptor

The included 12V car power adaptor allows the unit to be used with vehicles that have a 12V, negative ground electrical system.

### ⚠ WARNING

- Unplug the car power adaptor from the cigarette lighter socket when not in use.
- Do not use in vehicles with 24V electrical systems.

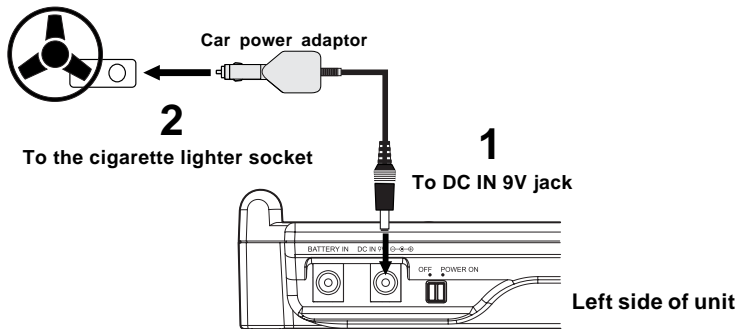

### ⚠ CAUTION:

- Only use the included car power adaptor with this unit. Using other car power adaptors could damage the unit or your vehicle.
- The included car power adaptor is only for use with this unit. Do not use it with other equipment.
- In the interest of traffic safety, the vehicle's driver should not operate or watch this unit.
- If the cigarette lighter socket is dirty with ashes or dust, the plug may become hot due to poor contact. Clean the cigarette lighter socket before use.
- After use, disconnect the car power adaptor from both the unit and the cigarette lighter socket.
- Do not leave this unit in your vehicle unattended for long periods of time. The interior temperature of parked vehicles can get very hot. Keep this unit out of prolonged direct sunlight.

# POWER SUPPLY

## C. Using the rechargeable battery pack

- Charge the battery for at least 4-5 hours before using it for the first time. The charging light will go out when the battery is fully charged.
- When recharging the battery, disconnect it from the unit.

POWER INDICATOR	CHARGING INDICATOR	STATUS
ON	ON	Battery is charging
OFF	OFF	Charging complete or battery not connected.
OFF	OFF	Adaptor not connected to charger.

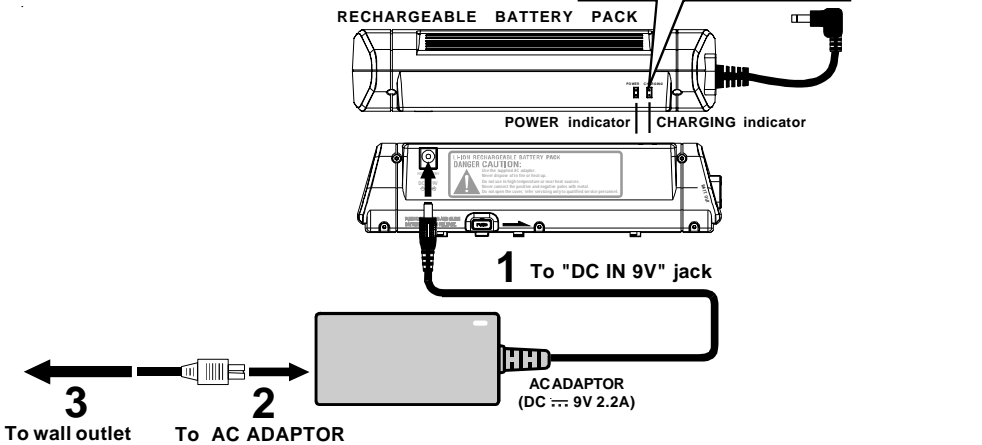

### ⚠ Caution:

- The included AC power supply cord and AC adaptor are for use with this unit only. Do not use them with other equipment.
- To prevent electrical shock, match wide blade of plug to wide slot on electrical outlet and fully insert.
- If you are not going to use the unit for a long time, disconnect the AC power supply cord from the AC outlet.
- Recharging is complete when charging indicator goes out. Unplug the AC power supply cord from the AC adaptor, then unplug the rechargeable battery pack.
- Do not short-circuit the terminals on the battery.
- To attach rechargeable battery pack, slide it in to the corresponding positions on the back of the unit.

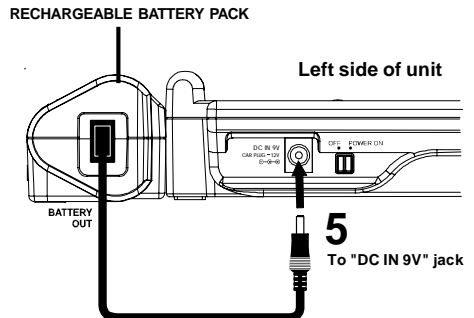
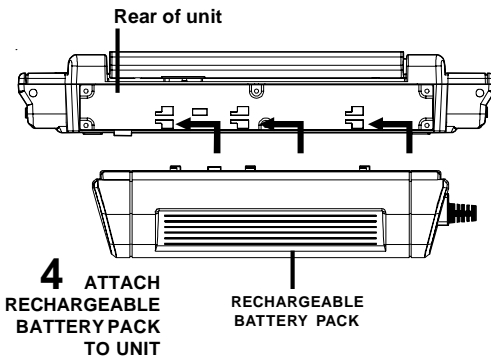

# POWER SUPPLY

- Disconnecting rechargeable Battery Pack from the unit.

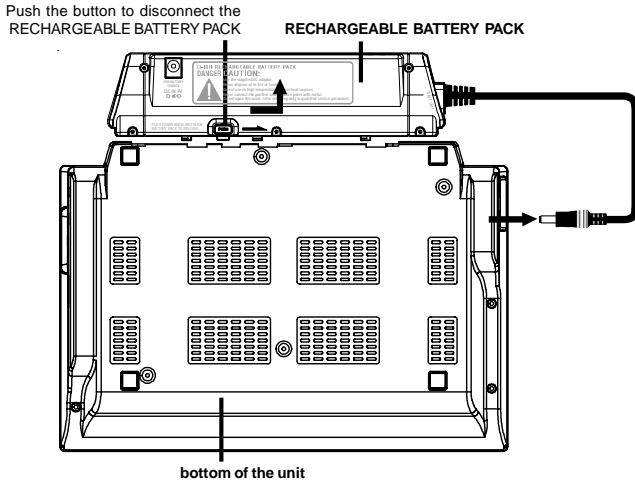

## ⚠ Important Notes:

- The battery can only be recharged when the unit is OFF.
- The battery can only be recharged using the AC adaptor. The battery cannot be recharged using the 12V car power adaptor.
- During playback, if the rechargeable battery is low, the BATTERY LOW indicator on the front will turn red and blink. When this occurs, you should recharge the battery.
- Use only the supplied AC ADAPTOR and BATTERY CHARGER to rechargeable battery pack.
- Detach rechargeable battery pack when not in use. (Even if the unit is off, it still uses some power. This can completely discharge the rechargeable battery and cause it to malfunction.)
- When the battery power is low, the unit will stop playing. Rechargeable battery pack when you are ready to use it again.
- If the rechargeable battery pack is not to be used for a long period of time, discharge it and store it in a place that is cool, dry and dark.
- While using the rechargeable battery pack, the air temperature should be between 41°F (5°C) to 95°F (35°C).
- To get the longest battery life, charge the battery at indoor temperatures.
- Never dispose of the rechargeable battery pack in fire or water.
- Never heat up the rechargeable battery pack.
- Do not open the rechargeable battery pack, refer servicing to qualified personnel.

## Turning on the unit

1. Slide the POWER ON/OFF switch to the "ON" position.
  - The DVD logo (start-up picture) will appear on the screen.



# CONNECTING OTHER EQUIPMENT

## A. Connecting the unit to a TV

- If your TV has Audio/Video inputs, you can connect the unit to your TV using the included Audio/Video cable.

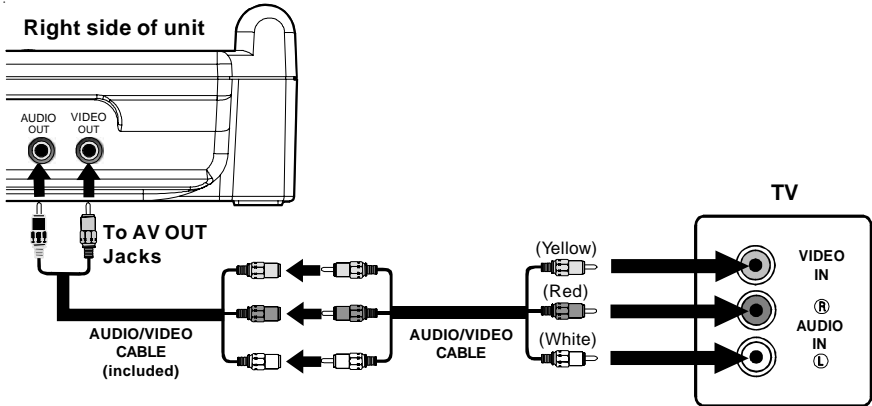

### Watching a DVD on your TV

1. Turn on the unit, slide the **AV IN / DVD** switch to select "DVD".
2. Turn on the TV and follow the instructions provided with it to play the DVD.

**Notes:** Please use the correct Audio/Video cable.

## B. Connecting to an amplifier or stereo receiver

This unit can play Dolby Digital, but only in two channels.

### Analog connection

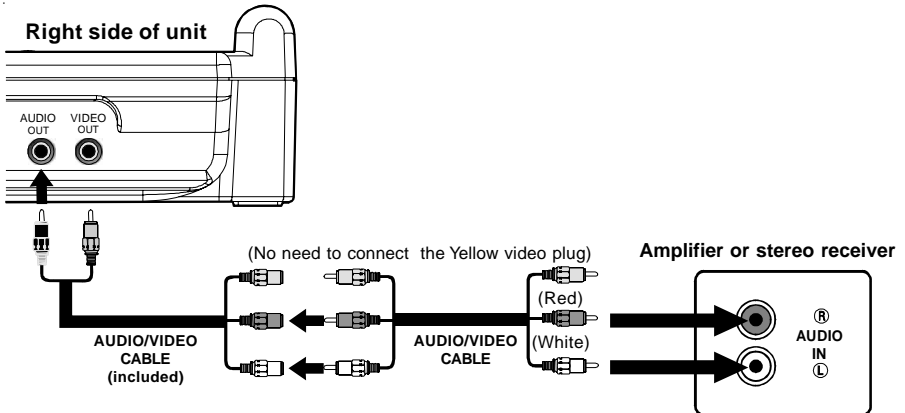

### Listening to another audio equipment

1. Turn on the Unit.
2. Turn on your audio equipment and follow the instructions included with it to select the AUDIO IN function.

### Notes:

- You may experience interference if the radio tuner function is selected while the television is working.
- Make sure to use the correct Audio/Video cable, connecting the plugs incorrectly may cause a weak signal.
- If you have a stereo VCR, make sure you set it to stereo mode.
- Due to copyright protection, DVD movies cannot be copied. If you copy a DVD movie onto a videotape, the resulting copy will be unclear, with poor sound quality. This is NOT caused by a defective DVD system.

# CONNECTING OTHER EQUIPMENT

## Using Headphones/Earphones

- Turn down the volume before connecting, and then adjust the volume level.
- When headphones/earphones are connected, no sound will be output from the unit's speakers.

### ⚠ Caution:

- Avoid listening to sound at levels which may be harmful to your ears.

### Note:

- When headphones are connected to the unit, the speakers are automatically disabled.

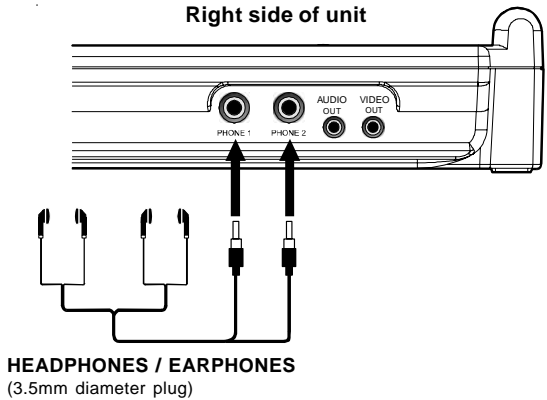

# ADJUSTING THE SOUND



## Dolby Digital (for DVD)

Dolby Digital is a technology developed by Dolby Laboratories. Soundtracks encoded in Dolby Digital can reproduce from one to 5.1 discrete channels of excellent quality audio. The unit automatically recognizes the Dolby Digital bitstream and provides a downmix suitable for two-channel listening. An additional Dolby Digital decoder is required for reproduction of the discrete multi-channel soundtracks available on many DVDs.



Manufactured under license from Dolby Laboratories.  
'Dolby' and the double-D symbol are trademarks of Dolby Laboratories.

This owner's manual explains the basic instructions for operating this unit. Some DVDs are produced in a manner that allows specific or limited operation during playback. Therefore, this unit may not respond to all operating commands. **THIS IS NOT A DEFECT.** Please refer to the instructions accompanying the specific DVD in question for more information about the options available on that DVD.

“” may appear on the screen during operation. The “” symbol means that the desired operation is not permitted by the unit or disc.

## ***Playing a Disc***

1. Slide the **POWER ON/OFF** switch on the left side of the unit to the ON position.
2. Push the **OPEN** switch to open the disc door.
3. Hold the disc by its sides and carefully place it onto the spindle with the label side facing up; press the disc down until you hear a “click”.
4. Push the door to close.  
It takes a short while for your unit to load the disc. After loading, the unit will automatically either bring you to the main menu of the DVD, or start playing the DVD.
5. If the unit does not automatically start playing the DVD, press the ► **PLAY** button from the main menu.

## ***Pausing playback (still mode)***

Press the **II PAUSE** button. To resume normal playback, press the ► **PLAY** button.

Each time you press the **II PAUSE** button, the picture advances one frame.

## ***Stopping playback***

Press the **■ STOP** button at the location where you want to interrupt playback. To resume playback at the position where the disc was stopped, press the ► **PLAY** button.

If you press the **■ STOP** button twice, the unit's memory will be cleared and pressing the ► **PLAY** button will reset the disc to the beginning.

## ***Skipping to a different track***

- Press the **◀◀ PREV** button to skip to the start of the current track.
- Press the **▶▶ NEXT** button to skip to the next track.
- For audio CDs, use the number buttons on the remote control to jump immediately to the desired track number.

## Fast Forward/Fast Reverse

1. Press the **SEARCH** ►► or ◀◀ **SEARCH** button of the remote unit when a disc is playing.

- The disc begins a fast scan at two times normal (x2) speed.
- Four speeds are available. Each time the **SEARCH** ►► or ◀◀ **SEARCH** button is pressed, the speed of the fast scan changes.

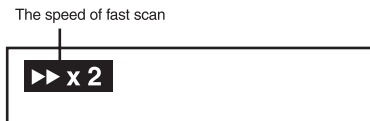
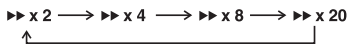

### Note :

You also can press and hold ◀◀ / ►► (PREV/NEXT) buttons on unit repeatedly to select different fast scan speeds.

2. Press the ► **PLAY** button when you reach the desired point to resume playback at normal speed.

## SKIP (Forward / Reverse)

While you are playing a disc, press the ►► **NEXT** button to move to the beginning of the next chapter or track. Press the ◀◀ **PREV** button to move to the previous chapter or track and playback will automatically begin.

## Audio selection

On some discs, the sound is recorded in two or more formats. Follow the directions below to select the type of playback.

1. While a disc is playing, press the **AUDIO** button to show the current audio format number.
2. Press the **AUDIO** button repeatedly to select the desired audio format.



### Notes :

- If only one audio format is recorded, the number does not change.
- About two seconds after a selection is made, playback continues in the new audio format.

## Subtitle selection

1. While a DVD is playing, press the **SUBTITLE / RETURN** button to display the current language setting, as shown in the diagram.
2. Press the **SUBTITLE / RETURN** button repeatedly to select the desired subtitle language.



### Notes :

- If only one language is recorded, the language does not change.
- About two seconds after selecting the subtitle language, playback continues with the new subtitle you selected.
- The number of languages recorded differs depending on the disc.
- If no button is pressed within a few seconds, playback continues without changing the current subtitle.
- This function can only be used for discs on which subtitles have been recorded in multiple languages.
- On some DVDs, subtitles are activated from the main menu of the DVD. Press the **MENU** button to activate the main menu.

## Angle selection

Some DVDs contain scenes which have been shot from a number of different angles. For these discs, the same scene can be viewed from each of these different angles.

1. While you are playing a DVD with different angles recorded, press the **ANGLE** button to view the number of current angles available.
2. Press the **ANGLE** button repeatedly to change the scene to the next recorded angle.
  - After approx. two seconds, playback will continue from the new angle you selected.
  - If no button is pressed within 10 seconds, playback continues without changing the current angle.



### Sequence of angle shots (Example)

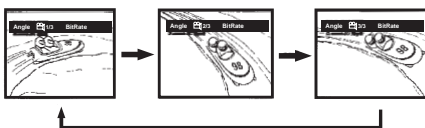

### Notes:

- This function can only be used for discs on which scenes shot from multiple angles have been recorded.
- If only one angle is recorded, " 1/1 " is displayed.



## DISPLAY function

Using DISPLAY, you can check and change the current settings of the following items: ANGLE, AUDIO and SUBTITLE.

- While the disc is playing, press the **DISPLAY** button of the remote unit to display the screen as shown in diagram.

**Elapsed time:** Elapsed time from the beginning of the chapter which is currently playing.

**Remaining time:** Remaining time of the title which is currently playing.

Elapsed time	Remaining time
00:07:18	01:12:18

## GOTO function

This function allows you to skip directly to any part of the disc while a disc is playing. Press ◀ or ▶ button to highlight time.

### Note

After adjusting the settings, press the DISPLAY button again to return to the normal screen.



## Locating a specific title

If a DVD contains title numbers, you can locate a specific title by directly selecting its title number.

- In stop mode, press the **GOTO** button.
- Press ◀ or ▶ button to highlight a specific field and press the corresponding number button(s) for the title you want. 
- Press the **ENTER** button to confirm. The unit will start playback about 3 seconds later.



## Locating a specific title /chapter / track

If you know the title / chapter / track number for the title / chapter / track that you want to play, you can locate it by directly selecting that number.

- Press the **GOTO** button to search for your desired title / chapter / track.
- Press ◀ or ▶ button to highlight a title / chapter / track and press the corresponding number button(s) for the chapter you want. 
- Press the **ENTER** button to confirm. The unit will start playback about 3 seconds later. 

## Locating a specific time

You can move to a specific location by entering its corresponding time (hours, minutes, seconds)

- Press the **GOTO** button.
- Press ◀ or ▶ button to highlight time. 
- Press the corresponding number buttons for the setting point you want.
- Press the **ENTER** button to confirm. The unit will start playback about 3 seconds later. 

### Notes :

- Some discs may not respond to this process.
- Some scenes may not be located as precisely as you specified.
- This method for accessing specific locations is available only within the current title of the DVD disc.

## Programmable memory

The two types of programmed playback provided by this unit are title programmed playback and chapter programmed playback.

### Title / Chapter programmed playback

1. Press the **MEMORY** button while the disc is stopped.
2. Enter the title numbers in **---**. Use **◀** or **▶** button to highlight your desired chapter and enter the chapter numbers in **---**.
3. Use **◀**, **▶**, **▲** or **▼** button to move to another field.
4. Repeat steps 2 to 3.
5. Press the **▶ PLAY** button to start the programmed playback.

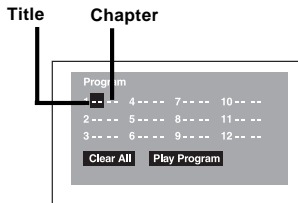

#### Notes :

- If you press the **■ STOP** button twice, the programmed selections will be cleared.

## Programmable memory

### Track programmed playback

1. Press the **MEMORY** button while the disc is stopped.
2. Enter the track numbers in **---**.

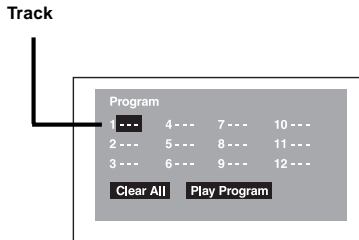

3. Use **◀**, **▶**, **▲** or **▼** button to select other field.
4. Repeat steps 2 to 3.
5. Press the **▶ PLAY** button to start the programmed playback.



# REPEAT PLAYBACK

You can play a specific title or chapter repeatedly.

(Title repeat, chapter repeat, A-B repeat)

## REPEATING A DVD CHAPTER

While the disc is playing, press the REPEAT DISC button until the “Repeat Chapter” indicator displays on the screen. The current chapter is played repeatedly.

## REPEATING A DVD TITLE

While the disc is playing, press the REPEAT DISC button until the “Repeat Title” indicator displays on the screen. The current title is played repeatedly.

## RESUMING NORMAL DVD PLAYBACK

While the disc is playing, press the REPEAT DISC button until the “Off” indicator displays on the screen.

You can play a single track or the whole DVD repeatedly.

## REPEATING A SINGLE CD TRACK

While the disc is playing, press the REPEAT DISC button until the “Repeat Single” indicator displays on the screen. The current track is played repeatedly.

## REPEATING A WHOLE CD

While the CD is playing, press the REPEAT DISC button until the “Repeat All” indicator displays on the screen. The whole disc is played repeatedly.

## RESUMING NORMAL CD PLAYBACK

Press the REPEAT DISC button until the “Off” indicator displays on the screen.

## Repeating a specific section

You can play a specific section repeatedly.

1. While the disc is playing, press the REPEAT A-B button at the beginning of the section ((Rep A-) is displayed) you want to play repeatedly.
2. Press the REPEAT A-B button again at the end of the section ((Rep A-B) is displayed).
3. The unit will immediately begin replaying your selection.

To resume normal playback

4. While the disc is playing, press the REPEAT A-B button until the “Off” indicator displays on the screen.

### Notes :

- A-B repeat can only be used within the same title. If the start and end of the section to be repeated are in different titles, A-B repeat is cancelled.
- The A-B repeat function does not operate in scenes where different camera angles are recorded.

# PLAYING MP3 AND PICTURE FILES

This unit can play MP3 and Picture files recorded on CD-R and CD-RW discs.

## ***Playing a MP3 /Picture file disc***

1. Insert the MP3/Picture file disc.
2. Close the disc door.
3. The unit will load the disc and automatically display the contents of the disc on the screen, while also beginning to play the first MP3 file or Picture files. Each file will be played one after another.
4. Press the ▲, ▼, ◀ or ▶ CURSOR button to view and select the file(s) that you want to play, then press the ENTER button to confirm the selected file

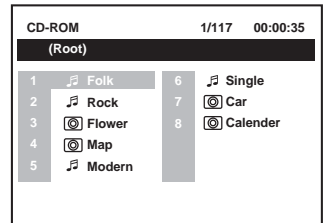

### **Notes:**

- You can press the **PAUSE** button to interrupt playback, and press the **PLAY** button to resume playback.
- You also can use **GOTO** function or use the numbered buttons to enter a photo number and quickly select any image.
- Press the **ANGLE** button on the remote control to rotate the picture orientation by 90°.

### **Playable files**

The ability of this unit to read MP3 discs is dependent on the following:

- The Bit Rate must be within 64 - 256 kbps.
- The total number of files on the disc should not exceed 254.
- The maximum number of directories should not exceed 32.
- The maximum depth level of directories should not exceed 4.
- File names should be named using 7 or fewer letters and/or numbers, and must incorporate the "MP3" file extension. EXAMPLE: \*\*\*\*\*.MP3 where each \* is a letter or number.
- Use only letters and / or numbers in file names. If you use special characters, the file and/or folder names may not be displayed correctly on the on-screen display.
- When recording on CD-R discs, use 74-minute (650MB) discs.
- The CD-R or CD-RW discs should be "finalized" on the computer using "single session format" with recording speed less than "8x".
- See your CD/MP3 creation software for more information.

# CUSTOMIZING THE FUNCTION SETTINGS

## LANGUAGE setting

1. Press the **SETUP** button in stop mode.
2. Use **▲** or **▼** button to select a language, then press the **ENTER** button. The screen will change to your selected language immediately.
3. To exit the **SETUP MENU** and return to the normal screen, press the **RETURN** or **SETUP** button.

Language Video

English  
Deutsch  
Français  
Español  
Italiano  
Svenska  
Português

## VIDEO setting

1. Press the **SETUP** button in stop mode.
2. Use **◀** or **▶** button to select **Video**, then press the **ENTER** button.
3. Use **▲** or **▼** button to select the options (**TV Shape**, **Brightness** or **Edges**) to be adjusted by press **▲** or **▼** button, then press the **ENTER** button. (The screen will change to your desired setting).
4. Repeats step 2 and 3 above to adjust other options.
5. To exit the **FUNCTION SETUP MENU** and return to the normal screen, press the **RETURN** or **SETUP** button.

Language Video

TV Shape Letter Box  
Brightness Off  
Edges Off

Cut off when a wide-screen video image is played.



Pan Scan

### Pan Scan

- When wide-screen video is played, this mode clips the right and left sides of the image so that it can be viewed on a conventional screen.
- Some wide-screen DVDs that do not permit Pan Scan playback are automatically played in letterbox mode (black bands at top and bottom of screen).



Letter Box

### Letter Box

- When wide-screen video is played in this mode on a conventional screen, black bands appear at the top and bottom of the screen.



Wide-screen

### Wide-screen

- This is the correct mode for playing wide-screen videos on a wide-screen.

### Notes :

- The displayable picture size is preset on the DVD disc. Therefore the playback picture of some DVDs may not conform to the picture size you select.
- When you play DVDs recorded in the 4:3 aspect ratio, the playback picture will always appear in the 4:3 aspect ratio regardless of the TV shape setting.

# CUSTOMIZING THE FUNCTION SETTINGS

## RATING

Some DVDs are equipped with a password function and are rated according to their content. The contents allowed by parental lock levels and the way a DVD is controlled may vary from disc to disc. For example, if the disc allows, you could lock-out violent scenes unsuitable for children or you could lock out playback of the disc altogether.

1. Press the **SETUP** button in stop mode.
2. Use ◀ or ▶ button to select the **Rating**, press the **ENTER** button.
3. Use ▲ or ▼ button to select parental lock and then press the **ENTER** button repeatedly to set the parental lock level.
4. Use ▲ or ▼ button to shift and select Password, enter your 4-digit security code and then press the **ENTER** button.

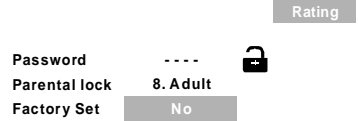

**You cannot play DVDs rated higher than the level you selected unless you cancel the parental lock function.**

The parental lock levels are equivalent to the following ratings.

Level 1 : Kid Safe  
Level 2 : G  
Level 3 : PG  
Level 4 : PG\_13

Level 5 : PG\_R  
Level 6 : R  
Level 7 : NC\_17  
Level 8 : Adult



Indicates Parental lock is NOT active.



The Parental lock is active.

**If you forget the password, you can erase your current password by pressing number button 8 on the remote four times, then press the ENTER button to confirm the setting.**

**PASSWORD : 8 8 8 8**

### Note:

It takes 3-5 seconds to reset the unit to the factory default.

# LANGUAGE CODE LIST FOR DISC LANGUAGE

Code	Language Name	Code	Language Name	Code	Language Name	Code	Language Name
AA	Afar	FY	Frisian	MG	Malagasy	SL	Slovenian
AB	Abkhazian	GA	Irish	MI	Maori	SM	Samoan
AF	Afrikaans	GB	Scots Gaelic	MK	Macedonian	SN	Shona
AM	Ameharic	GL	Galician	ML	Malayalam	SO	Somali
AR	Arabic	GN	Guarani	MN	Mongolian	SQ	Albanian
AS	Assamese	GU	Gujarati	MO	Moldavian	SR	Serbian
AY	Aymara	HA	Hausa	MR	Marathi	SS	Siswat
AZ	Azerbaijani	HI	Hindi	MS	Malay	ST	Sesotho
BA	Bashkir	HR	Croatian	MT	Maltese	SU	Sundanese
BE	Byelorussian	HU	Hungarian	MY	Burmese	SV	Swedish
BG	Bulgarian	HY	Armenian	NA	Nauru	SW	Swahili
BH	Bihari	IA	Interlingua	NE	Nepali	TA	Tamil
BI	Bislama	IE	Interlingue	NL	Dutch	TE	Telugu
BN	Bengali	IK	Inupiak	NO	Norwegian	TG	Tajik
	Bangla	IN	Indonesian	OC	Occitan	TH	Thai
BO	Tibetan	IS	Icelandic	OM	(Afan) Oromo	TI	Tigrinya
BR	Breton	IT	Italian	OR	Oriya	TK	Turkmen
CA	Catalan	IW	Hebrew	PA	Panjabi	TL	Tagalog
CO	Corsican	JA	Japanese	PL	Polish	TN	Setswana
CS	Czech	JI	Yiddish	PS	Pashto, Pushto	TO	Tonga
CY	Welsh	JW	Javanese	PT	Portuguese	TR	Turish
DA	Danish	KA	Georgian	QU	Quechua	TS	Tsonga
DE	German	KK	Kazakh	RM	Rhaeto- Romance	TT	Tatar
DZ	Bhutani	KL	Greenlandic			TW	Twi
EL	Greek	KM	Cambodian	RN	Kirundi	UK	Ukrainian
EN	English	KN	Kannada	RO	Romanian	UR	Urdu
EO	Esperanto	KO	Korean	RU	Russian	UZ	Uzbek
ES	Spanish	KS	Kashmiri	RW	Kinyarwanda	VI	Vietnamese
ET	Estonian	KU	Kurdish	SA	Sanskrit	VO	Volapük
EU	Basque	KY	Kirghiz	SD	Sindhi	WO	Wolof
FA	Persian	LA	Latin	SG	Sangho	XH	Xhosa
FI	Finnish	LN	Lingala	SH	Serbo- Croatian	YO	Yoruba
FJ	Fiji	LO	Laothian			ZH	Chinese
FO	Faroese	LT	Lithuanian	SI	Singhalese	ZU	Zulu
FR	French	LV	Latvian, Lettish	SK	Slovak		

# MAINTENANCE

## ***Cleaning Disc***

A defective or dirty disc inserted into the unit can cause sound to drop out during playback.

Handle the disc by holding its inner and outer edges.

- Do NOT touch the surface of the unlabeled side of the disc.
- Do NOT stick paper or tape on the surface of the disc.
- Do NOT expose the disc to direct sunlight or excessive heat.
- Clean the disc before playback. Wipe the disc from the center outward with a cleaning cloth.
- NEVER use solvents such as benzine or alcohol to clean the disc.
- Do NOT use irregular shaped discs (example : heart shaped, octagonal, etc.). They may cause malfunctions.



## ***Cleaning the unit***

- Be sure to turn the unit off and disconnect the AC power cord before cleaning the unit.
- Wipe the unit with a dry soft cloth.  
If the surfaces are extremely dirty, wipe clean with a cloth which has been dipped in a weak soap-and-water solution and wrung out thoroughly, then wipe it with a dry cloth.
- Never use alcohol, benzine, paint-thinner, cleaning fluid or other chemicals. Do NOT use compressed air to remove dust.

## ***Important Note***

Before shipping the unit, remove any disc from the disc compartment.



# TROUBLE SHOOTING GUIDE

## SYMPTOM

## CAUSE (AND REMEDY)

No power.

- Make sure that the AC adapter is connected.
- Make sure that the unit is turned on.

The remote control does not function.

- Make sure the infrared remote sensor is not blocked.
- Make sure the plastic sheet has been removed from the remote.
- Point the remote directly at the infrared remote sensor on the unit.
- Replace the battery in the remote with a new one.

## DVD

Very little or no sound is coming from a DVD

- Make sure the unit is in DVD mode.
- Make sure the unit is not paused. Press the ► **PLAY** button.
- Make sure the unit is not in fast-forward or fast-reverse mode. Press the ► **PLAY** button.
- Make sure that AUDIO/VIDEO output and AV IN input connections are correct.
- Make sure you have not selected the "DTS" audio track on the DVD. This unit does not decode "DTS" audio.
- The unit have overheated, shut it off for 30 minutes to allow it to cool down.

No picture

- The region number of the disc does not match the region number of the unit.



- DVD mode is not selected, select DVD on AV IN/DVD switch.

The picture is not clear

- The DVD is dirty. Gently clean the disc.
- The DVD is scratched.

Loud hum or noise is heard.

- The plugs and jacks are dirty. Wipe them with a cloth slightly moistened with alcohol.
- Clean the disc.

The disc does not play.

- There is no disc inside the unit ("No Disc" appears on the screen).
- Insert the disc correctly with the graphics facing up.
- Clean the disc.
- A non-NTSC disc has been inserted, or the disc region number does not match the region number of the unit.
- Condensation may have formed inside the unit due to a sudden change in temperature. Wait about an hour for it to clear and try again.

**NOTICE: Kawasaki is trademark licensed by Kawasaki Motors Corp., U.S.A. However, this product is neither manufactured nor distributed by Kawasaki Motors Corp., USA. Consumer inquiries should be directed to Alco Electronics at 1-800-252-6123.**