



DVD + VCR HOME THEATER SYSTEM



CD-R CD-RW



VHS HQ HIGH QUALITY

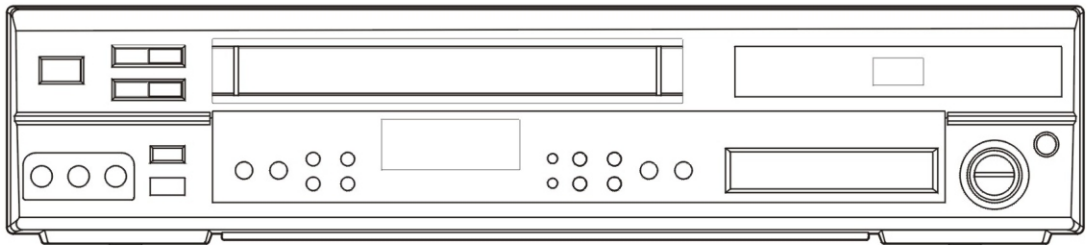

OWNER'S MANUAL

IMPORTANT

This Unit does NOT allow copying
from DVD to VCR Tape

Important Safety Instructions



WARNING: TO REDUCE THE RISK OF ELECTRIC SHOCK, DO NOT REMOVE COVER (OR BACK). NO USER-SERVICEABLE PARTS INSIDE. REFER SERVICING TO QUALIFIED SERVICE PERSONNEL.

WARNING:

TO PREVENT FIRE OR SHOCK HAZARD, DO NOT EXPOSE THIS APPLIANCE TO RAIN OR MOISTURE.

CAUTION:

TO PREVENT ELECTRIC SHOCK, MATCH WIDE BLADE OF PLUG TO WIDE SLOT, FULLY INSERT.

On Placement

- Do not use the Unit in places which are extremely hot, cold, dusty, or humid.
- Place the Unit on a flat and even surface.
- Do not restrict the air flow of the Unit by placing it in a place with poor air flow, by covering it with a cloth, or by placing it on carpeting.

FCC Information

This device complies with Part 15 of FCC Rules.

Operation is subject to the following two conditions:

- (1) This device may not cause harmful interference, and
- (2) This device must accept any interference received, including interference that may cause undesirable operation.

On Safety

- When connecting or disconnecting the AC cord, grip the plug and not the cord itself. Pulling the cord may damage it and create a hazard.
- When you are not going to use the Unit for a long period of time, disconnect the AC power cord.

On Condensation

- When left in a heated room where it is warm and damp, water droplets or condensation may form inside the Unit. When there is condensation inside the Unit, the Unit may not function normally. Let the Unit stand for 1 to 2 hours before turning the power on, or gradually heat the room up and dry the Unit before use.

WARNING:

- Should any trouble occur, disconnect the AC power cord and refer servicing to a qualified technician.
- Do not place anything directly on the top of the Unit. Damage to the Unit can result.

Notes on Copyright

It is forbidden by law to copy, broadcast, show, broadcast on cable, play in public, rent copyrighted material without permission.

Apparatus Claims of U.S. Patent Nos. 4,631,603; 4,577,216; 4,819,098 and 4,907,093 licensed for limited viewing uses only.

DVD video discs are copy protected, and any recordings made from these discs will be distorted. This product incorporates copyright protection technology that is protected by method claims of certain U.S. patents and other intellectual property rights owned by Macrovision Corporation and other rights owners. Use of this copyright protection technology must be authorized by Macrovision Corporation, and is intended for home and other limited viewing uses only, unless otherwise authorized by Macrovision Corporation. Reverse engineering or disassembly is prohibited.

This video cassette recorder (VCR) uses "ONLY" **VHS** cassette tapes, NTSC video signals (standard in US).



The lightning flash with an arrowhead symbol, within the equilateral triangle, is intended to alert the user to the presence of uninsulated "dangerous voltage" within the product's enclosure that may be of sufficient magnitude to cause an electric shock.



The exclamation point within the equilateral triangle is intended to alert the user to the presence of important operating and maintenance (servicing) instructions in this owner manual.



This product contains a low power laser device.

Important Safety Instructions

1. **Read Instructions** - All the safety and operating instructions should be read before the appliance is operated.
2. **Retain Instructions** - The safety and operating instructions should be retained for future reference.
3. **Heed Warnings** - All warnings on the appliance and in the operating instructions should be adhered to.
4. **Follow Instructions** - All operating and use instructions should be followed.
5. **Water and Moisture** - The appliance should not be used near water - for example, near a bathtub, washbowl, kitchen sink, laundry tub, in a wet basement, or near a swimming pool, and the like.
6. **Carts and Stands** - The appliance should be used only with a cart or stand that is recommended by the manufacturer.
- 6A. An appliance and cart combination should be moved with care. Quick stops, excessive force, and uneven surfaces may cause the appliance and cart combination to overturn.
7. **Wall or Ceiling Mounting** - The appliance should be mounted to a wall or ceiling only as recommended by the manufacturer.
8. **Ventilation** - The appliance should be situated so that its location or position does not interfere with its proper ventilation. For example, the appliance should not be situated on a bed, sofa, rug, or similar surface that may block the ventilation openings; or, placed in a built-in installation, such as a book case or cabinet, that may impede the flow of air through the ventilation openings.
9. **Heat** - The appliance should be situated away from heat sources such as radiators, heat registers, stoves, or other appliances (including amplifiers) that produce heat.
10. **Power Sources** - The appliance should be connected to a power supply only of the type described in the operating instructions or as marked on the appliance.
11. **Grounding or Polarization** - Precautions should be taken so that the grounding or polarization means of an appliance are not defeated.
12. **Power-Cord Protection** - Power-supply cords should be routed so that they are not likely to be walked on or pinched by items placed upon or against them, paying particular attention to cords at plugs, convenience receptacles, and the point where they exit from the appliance.
13. **Cleaning** - The appliance should be cleaned only as recommended by the manufacturer.
14. **Power Lines** - An outdoor antenna should be located away from power lines.
15. **Outdoor Antenna Grounding** - If an outside antenna is connected to the receiver, be sure the antenna system is grounded so as to provide some protection against voltage surges and built up static charges. Section 810 of the National Electrical Code, ANSI/NFPA No. 70, provides information with respect to proper grounding of the mast and supporting structure, grounding of the lead-in wire to an antenna discharge unit, size of grounding conductors, location of antenna-discharge unit, connection to grounding electrodes, and requirements for the grounding electrode. See Figure 1.
16. **Nonuse Periods** - The power cord of the appliance should be unplugged from the outlet when left unused for a long period of time.
17. **Object and Liquid Entry** - Care should be taken so that objects do not fall, and liquids are not spilled, into the enclosure through openings.
18. **Damage Requiring Service** - The appliance should be serviced by qualified service personnel when:
 - A. The power-supply cord or the plug has been damaged; or
 - B. Objects have fallen, or liquid has been spilled, into the appliance; or
 - C. The appliance has been exposed to rain; or
 - D. The appliance does not appear to operate normally or exhibits a marked change in performance; or
 - E. The appliance has been dropped, or the enclosure damaged.
19. **Servicing** - The user should not attempt to service the appliance beyond that described in the operating instructions. All other servicing should be referred to qualified service personnel.
20. **Attachments** - Do not use attachments not recommended by the product manufacturer as they may cause hazards.
21. **Accessories** - Do not place this product on an unstable cart, stand, tripod, bracket or table. The product may fall, causing serious injury to a child or adult and serious damage to the product. Use only with a cart, stand, tripod, bracket or table recommended by the manufacturer or sold with the product. Any mounting of the product should follow the manufacturer's instructions and should use a mounting accessory recommended by the manufacturer.
22. **Lightning** - For added protection for this product during a lightning storm or when it is left unattended and unused for long periods of time, unplug it from the wall outlet and disconnect the antenna or cable system. This will prevent damage to the product due to lightning and power-line surges.
23. **Overloading** - Do not overload wall outlets, extension cords or integral convenience receptacles as this can result in a risk of fire or electric shock.
24. **Replacement Parts** - When replacement parts are required, be sure the service technician has used replacement parts specified by the manufacturer or have the same characteristics as the original part. Unauthorized substitutions may result in fire, electric shock or other hazards.
25. **Safety Check** - Upon completion of any service or repairs to this product, ask the service technician to perform safety checks to determine that the product is in proper operating condition.

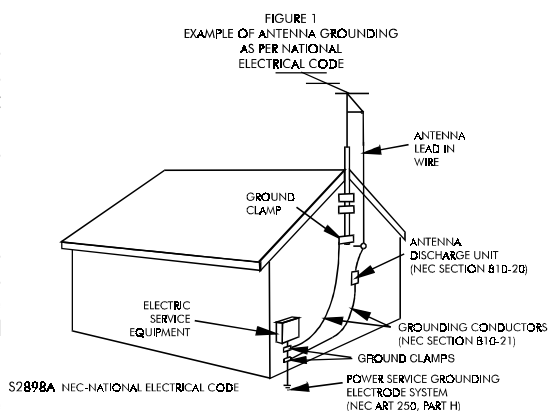

Table of Contents

IMPORTANT

This Unit does NOT allow copying from DVD to VCR tape

Important Safety Instruction	1-2
Disc Formats	5
Parts and Functions	6-9
Front Panel	6
Rear Panel	7
Using the Remote Control	7
Remote Control	8-9
Display	10
Front Panel Display	10
Display Information	10
Connections	11-18
Connecting your TV	11
Cable TV Connections	12-15
For better reception of Radio	15
Connecting the speakers & subwoofer	16
Positioning the speakers and subwoofer	16
Connecting other equipment	17
Mounting rear surround speakers	18
Turning on the Unit and TV	18
Power cord connection	18
Adjusting the Sound	19-20
Playing a Disc	21-24
Pausing playback (still mode)	21
Stopping playback	21
To skip to a different track	21
Fast Forward/Fast Reverse	22
Slow-motion play	22
Skip (Forward)	22
Zooming into an image	22
Angle selection	23
Audio selection	23
Subtitle selection	24

Special Functions	25-27
Display function (DVD)	25
GOTO function (DVD)	25
Locating a specific title	26
Locating a specific title/chapter/track	26
Locating a specific time	27
Angle setting	27
Audio setting	27
Subtitle setting	27
CD/DVD programmable memory	28
DVD programmable memory	28
Title/Chapter programmed playback	28
CD programmable memory	28
Track programmed playback	28
Repeat Playback	29-30
Repeating a title/chapter (DVD)	29
Repeating a single track/whole disc (CD)	29
Repeating a specific section (DVD)	30
Playing MP3 and Picture File Disc	31-32
Playing a MP3 file disc	31
Playing a Picture file disc	32
Playing a MP3/Picture file disc	32
Customizing the Function Settings	33-41
LANGUAGE setting	33
VIDEO setting	34
TV Shape	34
Video Output	35
Brightness	35
Edges	36
AUDIO setting	37
Digital Out	37
L/R speaker	37
Subwoofer	38
Surround Delay	38
Center Delay	39
Pink noise	39
RATING setting	40
Password/Parental lock	40
Factory Set	41
VCR Setup	42-50
MENU screen	42
OSD (On Screen Display)	42
How to display indicators	42
Setup (with Auto Clock Setting)	43
Setting the 3 \longleftrightarrow 4 Output Channel	44
Mode Selection	45
Channel Preset	46

Table of Contents

Adding Channel Memory/Erasing Channel Memory	47
Clock	48-50
Auto Clock Setting	48
Manual Clock Setting	49
Automatic Daylight Saving-Time (D.S.T.) adjustment	50
Language	50
VCR Playback	51-53
Inserting a video cassette	51
Playback	51
Fast forward and rewind	51
Video search	51
Slow motion playback	52
Still picture and frame advance	52
Automatic tracking control system	52
Manual tracking control	52
Blue screen noise elimination	52
Quick start with full loading mechanism	53
Full automatic playback	53
Audio output mode	53
VCR Recording	54-60
Recording a TV programme	54
Without a cable box or digital satellite receiver	54
With a cable box or digital satellite receiver	54
To watch another TV programme while recording	54
Cassette erase protection	54
Recording speeds	55
Recording Hi-Fi stereo sound	55
Recording MTS broadcasts	55
MTS/SAP recording	55
Monitor output when receiving a SAP broadcast	56
Tape dubbing connection instructions	56
Simple recording timer	57
Changing the contents of the simple recording timer	57
Cancelling the simple recording timer	57
Recording with the timer	58-59
Confirming timer programmes	60
Cancelling timer programmes	60
Special Functions	61
Recorded section Auto Repeat	61
Skip Search	61
Instant Replay	61
Radio Operation	62
Tuning into a station manually	62
FM Stereo	62
Weak FM stations	62
To search for a station automatically	62
Presetting stations	62
Tuning into a preset station	62
Language Code List for Disc Language	63
Maintenance	64
Cleaning Disc	64
Cleaning the Unit	64
Important Note	64
Trouble Shooting Guide	64-66

Disc Formats

The Unit can playback.



DVDs
[8cm(3")/12cm(5") disc]



CD-R CD-RW
Compatible



Audio CDs
[8cm(3")/12cm(5") disc]



Region Management Information

Region Management Information: This Unit is designed and manufactured to respond to the Region Management Information that is encoded on DVD discs. If the Region number printed on the DVD disc does not correspond to the Region number of this Unit, this Unit cannot play that disc.







The region number of this Unit is 1.

Disc Function or Operation that is Not Available

When the  symbol appears on the TV screen, it indicates that the function or operation attempted is not available at that time. This occurs because the DVD disc manufacturer determines the specific functions. Certain functions may not be available on some discs. Be sure to read the documentation provided with the DVD.

Icons Used on DVDs

Sample Icons

	1. English 2. French	Language selections for audio
	1. English 2. French	Language selections for subtitles
	16:9	Screen aspect ratio
	2	Multiple camera angles
	1	Region code indicator

Notes:

- This Unit supports 2-channel (L/R) audio and 5.1ch (Multi-channel) MPEG Audio 1/2 (only when the DIGITAL AUDIO OUT coaxial jack is used for connection). It does not support 7.1 channel MPEG Audio Version 2.0.
- When playing back a CD-G (Graphics) or CD EXTRA disc, the audio portion will be played, but the graphic images will not be shown.

Title, Chapter and Tracks

- DVDs are divided into “titles” and “chapters”. If the disc has more than one movie on it, each movie would be a separate “title”. “Chapters” are sections of titles.

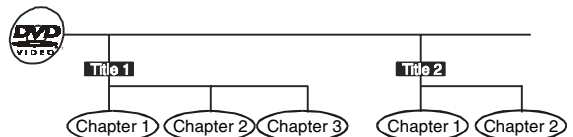

- Audio CDs are divided into “tracks”. A “track” is usually one song on an Audio CD.

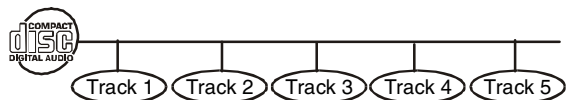

Note :

- Numbers identify each title, chapter, and track on a disc. Most discs have these numbers recorded on them, but some do not.

Notes on Unauthorized Discs

You may not be able to play back some DVD discs on this Unit if they were purchased from outside your geographic area or made for business purposes.

Parts and Functions

Front Panel

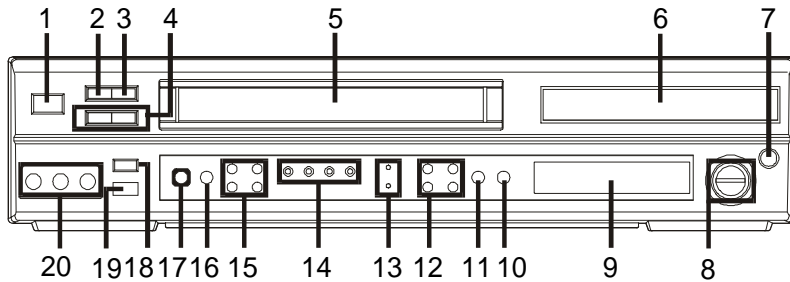

- 1) **MAIN POWER/ \odot STANDBY button**
Turn the power on or off.
- 2) **■ STOP button (for VCR)**
Stop playing a tape.
- 3) **▶ PLAY button (for VCR)**
Press to start or resume playback
- 4) **CHANNEL button UP/ DOWN (for VCR)**
Use to highlight selections on a menu screen and adjust certain setting.
- 5) **Video cassette compartment**
Open tray by pushing TAPE EJECT button.
- 6) **Disc tray**
Open or close tray by pushing DVD OPEN/CLOSE button. Place a disc on the disc tray, label side up.
- 7) **DVD OPEN/CLOSE button**
Use to open and close the disc tray.
- 8) **VOLUME control**
Change the loudness of the sound from the speakers connected to the unit.
- 9) **Display window**
Display system information.
- 10) **FUNCTION button (DVD/RADIO/VCR)**
Select the source.
- 11) **▶ PLAY button (for DVD)**
Press to start or resume playback
- 12) **|| PAUSE/■ STOP/REW/F.FWD button (for DVD)**
Press to pause playback. Each time you press the PAUSE button the picture advances one frame. Press the PLAY button to resume playback.
Stop playing a disc.
Fast reverse and forward playback.
- 13) **MAIN POWER/ STANDBY indicator**
When the Unit is turned on by pressing the MAIN POWER/STANDBY button, the light will illuminate a few seconds. If you press the POWER button on the remote control, the Unit will turn off and go into standby mode. The light will continue to illuminate.
- 14) **VCR POWER/TIMER/VCR/REC indicator**
VCR POWER : This indicator lights up whenever the VCR is turned on.
TIMER : This indicator lights up when the VCR is set for timer recording. Simple Recording Timer and Recording with the Timer.
VCR : This indicator lights up when selecting "VCR" by using TV/VCR.
REC : This indicator lights up during recording and flashes during REC-Pause.
- 15) **SET/MENU/REW/F.FWD button (for VCR)**
SET : Confirm selections on a VCR menu screen.
MENU : Use to select various screen functions.
REW : Fast reverse playback.
F.FWD : Fast forward playback.
- 16) **REC button (for VCR)**
Record a programme from TV or other sources (except DVD).
- 17) **VCR ON/OFF button**
Turn the VCR on or off.
- 18) **TAPE EJECT button (for VCR)**
Use to eject the tape.
- 19) **Remote sensor**
Accept the remote control unit signals.
- 20) **VIDEO IN/AUDIO IN (L/R) jacks (AV 2 IN)**
VIDEO IN : Connect a cable coming from the video out jack of a camcorder, another VCR, or an audio visual source here.
AUDIO IN (L/R) : Connect audio cables coming from the audio out jacks of a camcorder, another VCR, or an audio source here.

Note:

Screen saver - If no button is pressed within 2 minutes, the screen save function will activate for DVD only, If you want to return to the normal screen, press any button.

Parts and Functions

Rear Panel

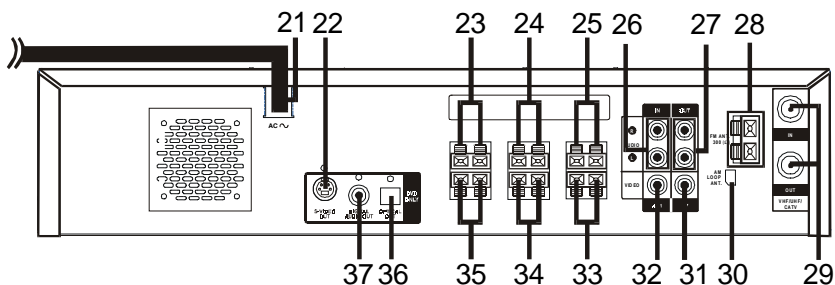

- 21) Power cord
- 22) S-VIDEO (DVD) output jack
- 23) Right Front speaker terminals
- 24) Centre speaker terminals
- 25) Left Front speaker terminals
- 26) AV1 IN (AUDIO) jacks
- 27) Left/Right AUDIO OUT jacks
- 28) FM ANTENNA jacks
- 29) VHF/UHF/CATV IN/OUT jacks
- 30) AM LOOP ANTENNA terminal
- 31) TV OUT (VIDEO) jack
- 32) VIDEO IN (VCR) jack
- 33) Left Rear speaker terminals
- 34) Subwoofer speaker terminals
- 35) Right Rear speaker terminals
- 36) OPTICAL OUT jack (DVD)
- 37) DIGITAL AUDIO OUT jack (DVD)

Notes:

- S-video out, Digital audio out and Optical out are only for the DVD section.

Using the Remote Control

- Point the Remote Control at the REMOTE SENSOR located on the Unit.
- When there is a strong ambient light source, the performance of the infrared REMOTE SENSOR may be degraded, causing unreliable operation.
- The recommended effective distance for remote operation is about 16 feet (5 meters).

To install Batteries

1. Open the battery door.

2. Insert two "AA" or UM-3 size batteries.

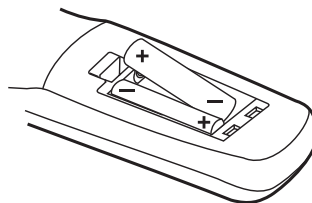
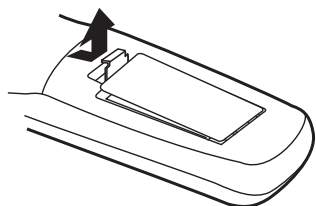

Battery Replacement

When batteries become weak, the operating distance of the Remote Control is greatly reduced and you will need to replace the batteries.





Notes:

- If the Remote Control is not going to be used for a long time, remove the batteries to avoid damage caused by battery leakage corrosion.
- Do not mix old and new batteries. Do not mix ALKALINE, standard (CARBON-ZINC) or rechargeable (NICKEL-CADMIUM) batteries.

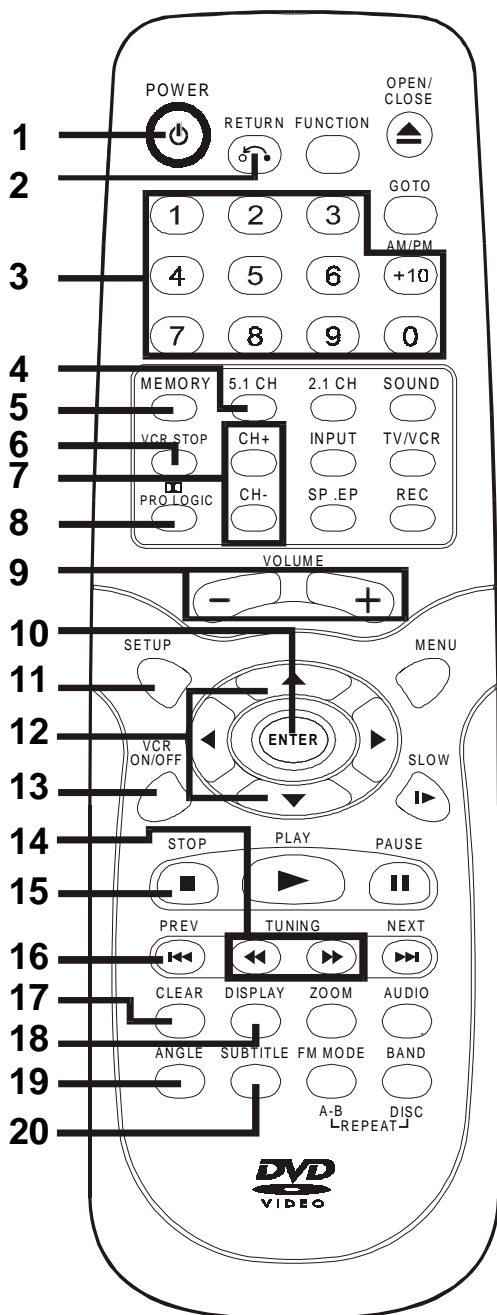
Parts and Functions

Remote Control



- 1) **POWER /  button**
Turns the Unit on and puts it in standby mode.
- 2) **RETURN button**
Return to the normal operation after using the SETUP menu.
- 3) **Number (0 - 9) and AM/PM (+10) buttons**
Use when creating programs, and entering a parental level password. To select numbers over 9, press +10 button and then the second no. for example, to enter 18, press +10 and then 8.
AM/PM : Select AM or PM during time setting.
- 4) **5.1 Ch button**
Switch speaker output to 5.1 channel mode. (All speakers + subwoofer)
- 5) **MEMORY button**
Enter the number of a selected chapter or track.
Enter the number of a selected station.
Enter the number of a selected channel.
- 6) **VCR STOP  button**
Stop playback.
- 7) **CHANNEL +/- buttons**
Select the desired channel.
- 8) ** PRO LOGIC button**
In AV_IN mode, switches to Dolby Pro Logic mode for VHS tapes encoded with Dolby Pro Logic.
- 9) **VOLUME (+/-) buttons**
Adjust the volume.
- 10) **ENTER button**
Confirm selections on a menu screen.
- 11) **SETUP button**
Selects the SET UP menu screen.
- 12) **▲/▼ CURSOR buttons**
Use to highlight selections on a menu screen and adjust certain settings.
- 13) **VCR ON/OFF button**
Turns the VCR on and off.
- 14) **◀◀ TUNING ▶▶ buttons**
◀◀: Fast reverse playback of DVDs/VCRs.
▶▶: Fast forward playback of DVDs/VCRs.
◀◀ TUNING ▶▶ : Scan all available radio stations.
- 15) **■ STOP button (for DVD/VCR)**
Stop playback.
- 16) **◀◀ PREV button (for DVD/VCR)**
Move reverse through titles, chapters or tracks on a disc.
Tune to the presetted stations.
Set a reverse video search time.
- 17) **CLEAR button**
Clear input selections and cancel certain playback functions.
- 18) **DISPLAY button**
Change disc status information displayed on the TV.
Change the screen as your desired.
- 19) **ANGLE button **
Switch the camera angle of the video presentation when scenes with multiple camera angles are recorded on a DVD.
- 20) **SUBTITLE button **
Select one of the subtitle languages programmed on a DVD.

Parts and Functions

Remote Control

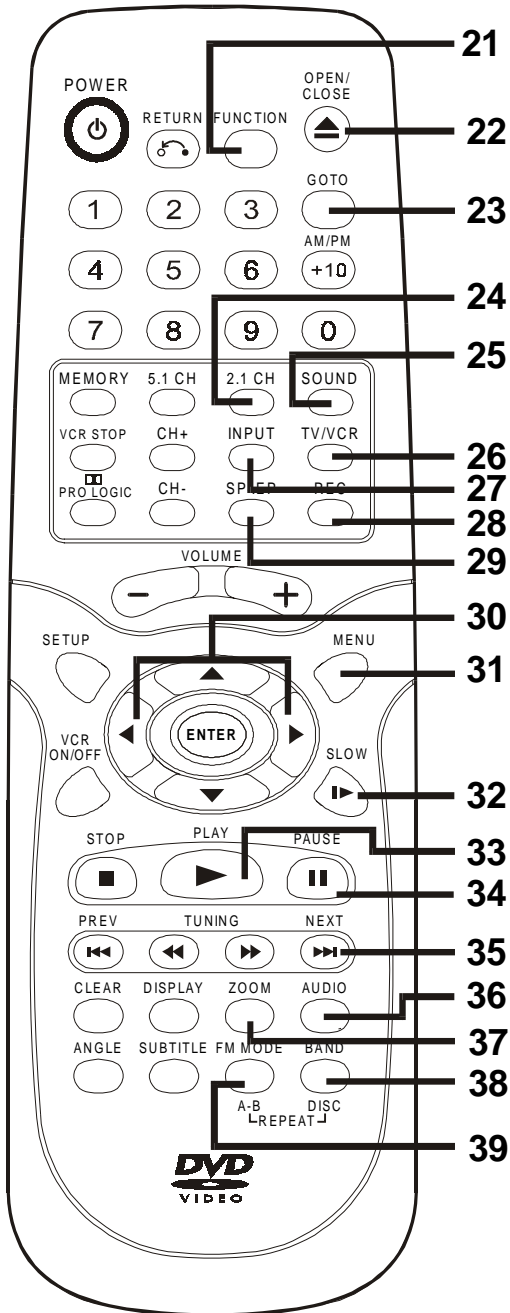

- 21) **FUNCTION button**
Display the FUNCTION screen where you can check or change various setting.
- 22) **OPEN / CLOSE button (for DVD)**
Use to open or close the disc tray.
- 23) **GOTO button**
Skip directly to a specific location on a DVD disc.
- 24) **2.1 CH button**
Switch speaker outputs to 2.1 channel. (Front left/right speakers + subwoofer)
- 25) **SOUND button**
Selects sound balance and tone controls for adjustment with the cursor buttons.
- 26) **TV/VCR button**
Use to select TV or VCR position.
- 27) **INPUT button**
Dub video material from another video device.
- 28) **REC button (for VCR)**
Record a programme from TV or other sources (except DVD).
- 29) **SP • EP button**
Select a recording speed (SP=standard play, EP=extended play).
- 30) **◀/▶ CURSOR buttons**
Use to highlight selections on a menu screen and make adjust certain settings.
- 31) **MENU button**
Open and close DVD's menu.
- 32) **SLOW ▶ button (for DVD/VCR)**
Perform slow forward playback.
- 33) **▶ PLAY button (for DVD/VCR)**
Start playback.
- 34) **|| PAUSE button (for DVD/VCR)**
Pause playback, frame advance.
- 35) **NEXT ▶▶ button (for DVD/VCR)**
Move forward through titles, chapters or tracks on a disc.
Tune to the presetted stations.
Set a forward video search time.
- 36) **AUDIO button**
Select one of the audio soundtracks programmed on a DVD or selects the audio output mode on a AUDIO CD.
- 37) **ZOOM button**
Zoom into an image.
- 38) **BAND/REPEAT-DISC button**
Switch between AM or FM.
Repeat chapter or title of a DVD.
Repeat single track or whole CD.
- 39) **FM MODE / REPEAT A - B button**
Set FM MODE to FM STEREO for FM stereo sound or to FM MONO for mono sound.
Perform point-to-point repeat playback on a DVD or CD.

Display

Front Panel Display

CHAPTER / TRACK indicator

When a DVD is loaded in the Unit, this indicator appears along with the chapter number. When a Audio CD is loaded in the Unit, this indicator appears along with the track number.

STEREO indicator

Tune into a station. "((ST))" will appear when an FM broadcast is in stereo.

TITLE indicator

When a DVD is loaded in the Unit, this indicator appears along with the title number.

REPEAT A-B playback indicator

Displayed during repeat playback.

REPEAT 1 playback indicator

Displayed during repeat playback.

MEMORY indicator

Displayed during programmed playback.

ANGLE indicator

Appears when multiple camera angles are recorded in the section of the DVD that is currently playing.

R. TOTAL(REMAIN.TOTAL) indicator

Indicates the elapsed playback time of the disc. With some discs, this area also shows the total play time of the disc when playback is stopped.



OPERATION indicator

Indicates the operation status of the disc and Unit.

DOLBY DIGITAL indicator

Displays while Dolby Digital sound processing is being performed or when the loaded disc contains Dolby Digital sound

Display Information

The DVD displays the information shown below on the TV screen and on the Unit's DVD display depending on the operation status.

Display Examples

	TV Screen	Unit Display	Remarks
If no disc is loaded when the Main Unit is switched on.	No Disc	NO DISC	"NO DISC" appears when the tray is closed and: 1) There is no disc in the tray. 2) The disc type is not playable in this Unit. 3) The disc is not loaded correctly (upside-down, etc.)
Tray open	▲ Open	OPEN	
Tray closed	▲ Close	CLOSE	
Loading	⌚ Loading...	LOAD	
Stopped	■ Stop		The display changes to show other indicators (total time, etc.)
Playing	▶ Play		
Paused	⏸ Pause		Freezes the image on the screen or pauses audio playback.
Fast forward	⏩ x 2		The display changes to show other indicators (total time, etc.)
Fast reverse	⏪ x 2		
Slow	⏴/⏵ x 1/2		Does not function for Audio CDs.
Repeat A - B	⏮ A- B	A-B	Repeat a specific section.
	⊘		The operation is not permitted by the DVD Unit or the disc.
Turn on VCR		VCR	In VCR mode.

Region (Local) Number Error Indicator

If the region (local) number of the disc that you attempt to play differs from the region number of the Unit, "Invalid Region" appears on the TV screen. (The disc cannot be played).

Connections

1. Connecting to your TV

The Unit can be connected to your TV in several different ways, depending on the design of your TV.

1. Connect the TV antenna (coaxial cable) to the input jack on the unit.
2. Attach one end of the supplied coaxial cable to the output jack on the unit, and the other end of the cable to the input jack on your TV.

Alternate Connections:

1. If your TV has Audio/Video inputs, you can also connect the unit to your TV using the supplied Audio/Video cord.
2. If your TV is equipped with an S-Video input, you can utilize the S-Video jack to connect the unit to your TV with an S-Video cord (not supplied) instead of the yellow video cable. Please note that the S-Video and coaxial cable connection will only carry the video signal from DVD playback. VCR playback will still require you to use the coaxial cable connection.

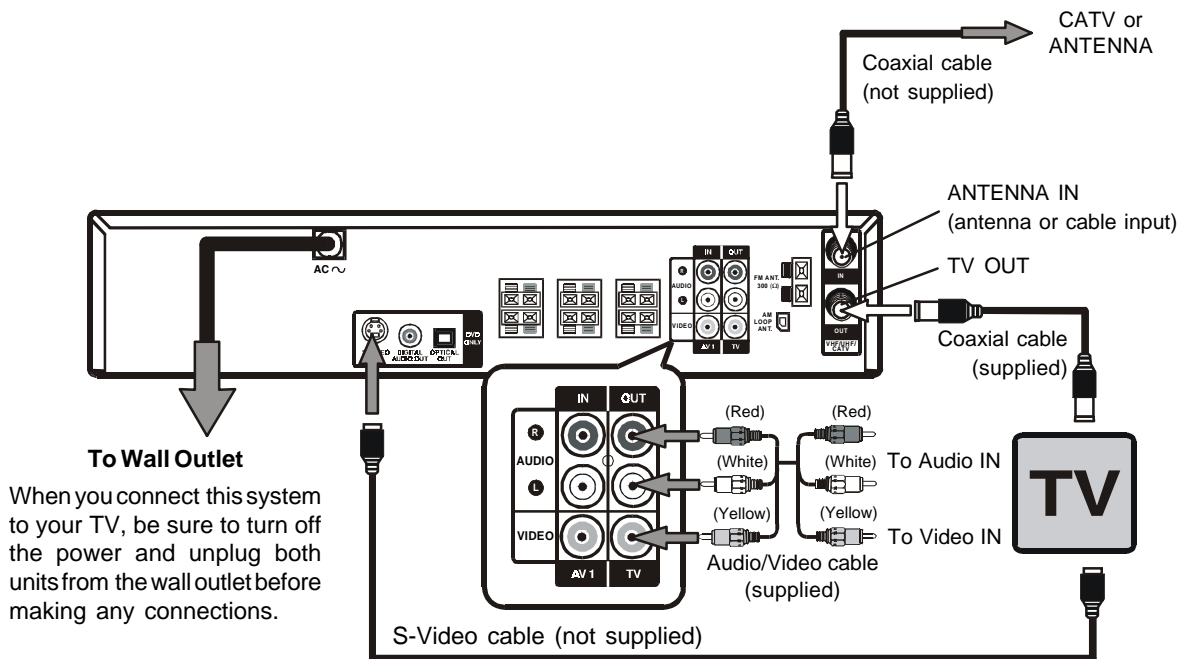

Note:

- When playback DVD via coaxial cable to TV alone, there will be no audio output from the TV. i.e. Sound comes from 5 speakers plus the subwoofer only.

Connections

Cable TV Connections

Your VCR is capable of receiving the following non-scrambled channels.

- Scrambled channels can be received with the cable box supplied by your cable TV company.

Preparation

Set the 3 ↔ 4 Output Channel of the VCR to 3 or 4.

See **Setting the 3 ↔ 4 Output Channel**.

First check your TV/CATV system

Step 1: Is your TV cable compatible with the VCR?

- YES → Go to **Step 2**
- NO → Go to **Step 3**

Step 2: Does your CATV system have some or all channels scrambled?

- YES → Go to **D**
- NO → Go to **A**

Step 3: Does your CATV system have some or all channels scrambled?

- YES → Go to **D**
- NO → Go to **Step 4**

Step 4: Choose the type below.

- Basic connection (only for descrambled CATV signals.) → Go to **B** - **1** or **2**
- To watch a CATV programme while recording a TV programme by using the A/B switch. → Go to **C**

A. Connection without a cable box

Connect as shown. Then plug in the power cords of the TV and cable box.

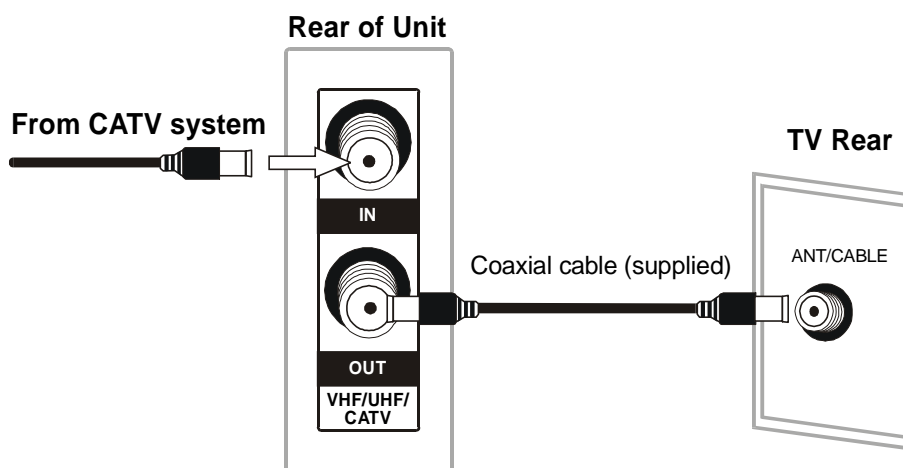

Connections

B. Connection with cable box

1. Connect as shown. With this connection, it is possible to record descrambled CATV signals. Then plug in the power cords of the TV and cable box.

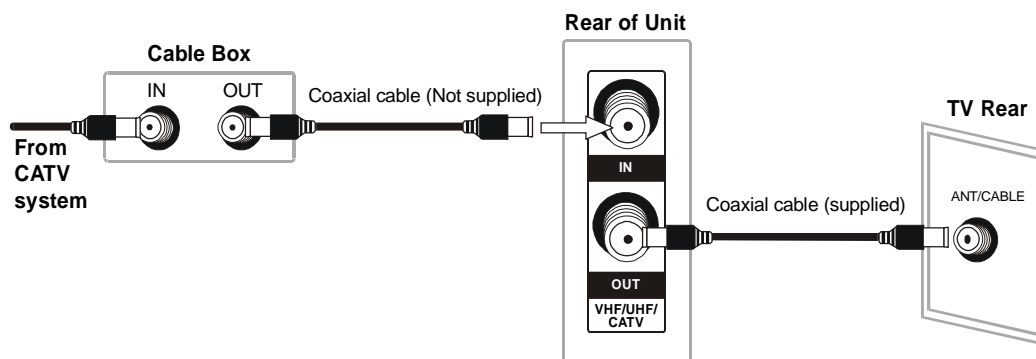

Notes:

- If the cable box is turned off, it will not output any signals, thus making it impossible to record or view a programme from the CATV system.
- In the case of the above connections, it is not possible to change channels using the remote control. Only the cable box can be used to change channels.
- Only one channel at a time can be programmed for recording programmes with the timer. It is not possible to watch a TV programme different from the one being recorded.
- Depending on which terminals the TV has, a separate combiner (mixer) or separator (splitter) may be necessary.

2. Connect as shown. With this connection, it is not possible to record CATV programmes which have been scrambled, but is possible to record one channel and watch the other one. Then plug in the power cords of the TV and cable box.

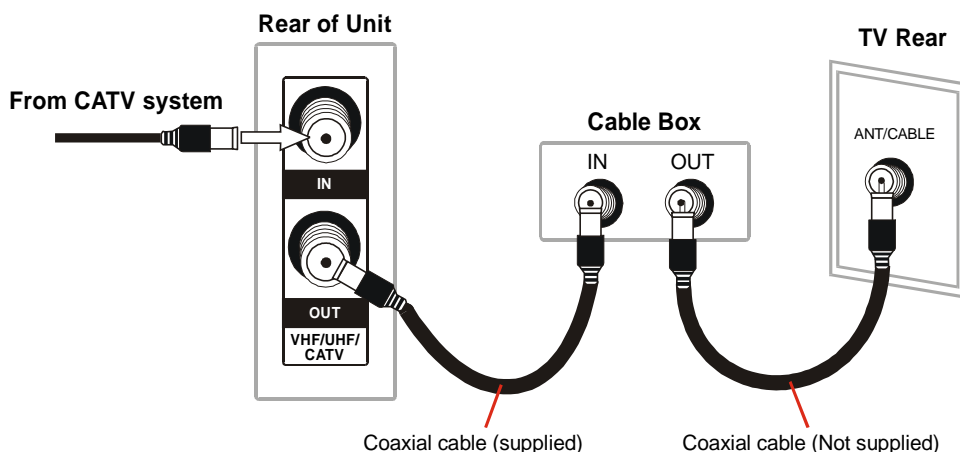

Notes:

- With the above connection, CURSOR ▲ or ▼ button of the VCR or the numbered buttons on the remote control can be used to select channels.
- Depending on which terminals the TV has, a combiner (mixer) or separator (splitter) may be necessary.
- To record one channel and watch another, the VCR must be set to the TV mode.

Connections

C. Connection with cable box, A/B switch and splitter

By using an A/B switch or splitter, it is possible to switch between the cable box and the VCR output.

For example, while recording a TV programme with the VCR, it is possible to watch a CATV programme (including descrambled programmes) using the A/B switch.

- Connect as shown. Then plug in the power cords of the TV and cable box.

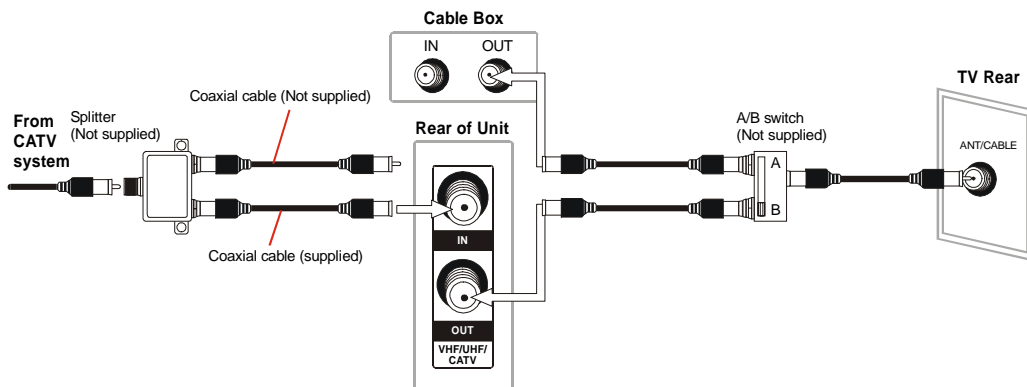

Using the A/B Switch

1. Set the A/B switch to the "A" position in the following situations.

- To watch a cable TV programme while recording another programme.
- To watch a scrambled cable TV programme.
- To watch a cable TV programme when the VCR is turned off.

Notes:

- Use the cable box to change channels.
 - If you turn off the cable box, you cannot watch a CATV programme.
2. Set the A/B switch to the "B" position in the following situations.
- To playback a cassette on the VCR.
 - To watch a programme which is being recorded with the VCR tuner.
 - To watch a programme using the VCR tuner.

Connections

D. Connection with two cable boxes, A/B switch and splitter

The following connection is necessary to record a cable TV programme (even those scrambled by a cable company) while watching another cable TV programme. The following connection requires two cable boxes, a 2-way splitter and an A/B switch.

- Connect as shown. Then plug in the power cords of the TV and cable box.

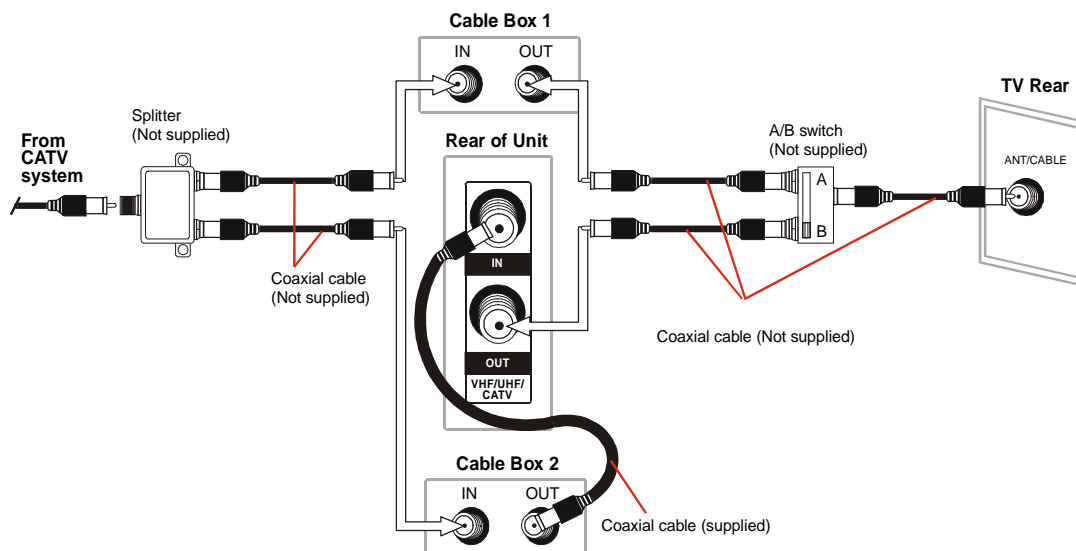

Using the A/B Switch

1. Set the A/B switch to the "A" position in the following situations.
 - To watch a cable TV programme while recording another programme.
 - To watch a cable TV programme when the VCR is turned off.
2. Set the A/B switch to the "B" position in the following situations.
 - To playback a cassette on the VCR.
 - To watch a programme being recorded, or to change (or watch) channels with the cable box 2. The output channel of the cable box 2 and the VCR must be the same.

Notes:

- If you turn off the cable box, you cannot record or view a CATV programme.
- If you have questions regarding any connection procedure, please contact your cable company.

2. For better reception of Radio

FM

Connect FM antenna (supplied) to the FM ANTENNA jacks.

AM

Connect the AM loop antenna (supplied) to the AM LOOP ANTENNA terminals. Rotate the AM loop antenna to obtain the best reception.

NOTE: Position this AM loop antenna as far away as possible from this system and from the TV.

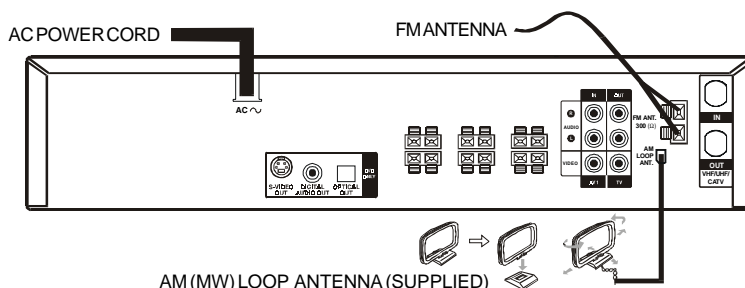

Connections

3. Connecting the speakers & subwoofer

1. The speaker cords have been color-coded to simplify connection. Just plug the **POSITIVE (+)** and **NEGATIVE (-)** ends of each speaker wire into the corresponding jacks on the rear of the Unit, matching the color tube on the end of the speaker wire to the color-coded connector.
2. Connect each of the speaker wires to the satellite speakers. The front left/right and rear left/right speakers are all the same. However, make sure you connect to the center speaker (color) to the one speaker which is slightly longer than the rest.

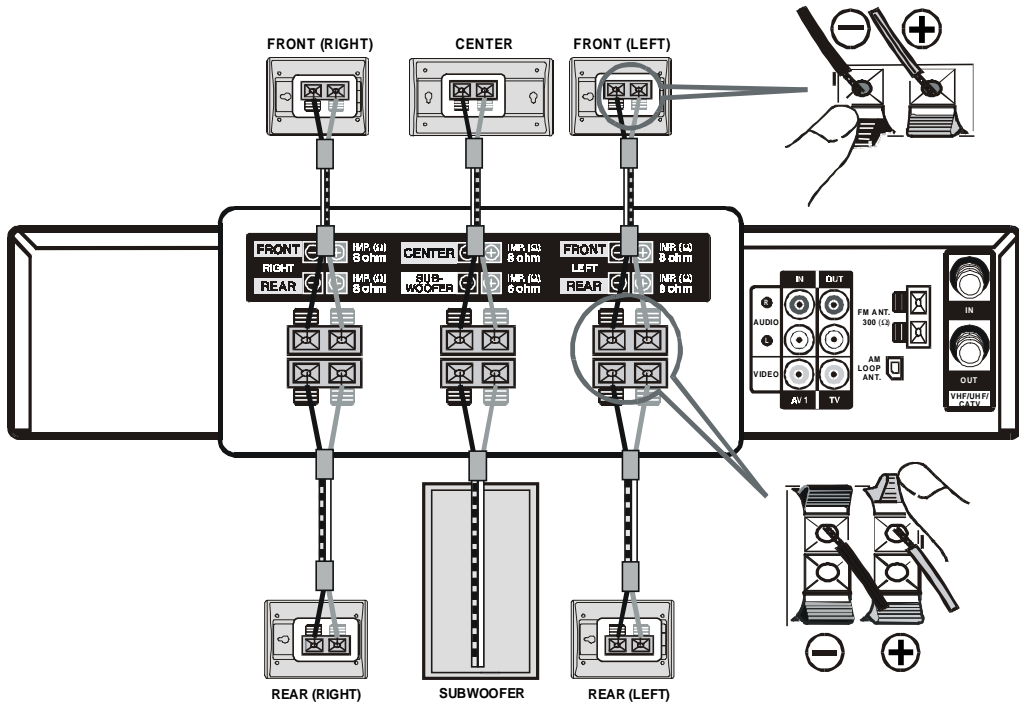

4. Positioning the speakers and subwoofer

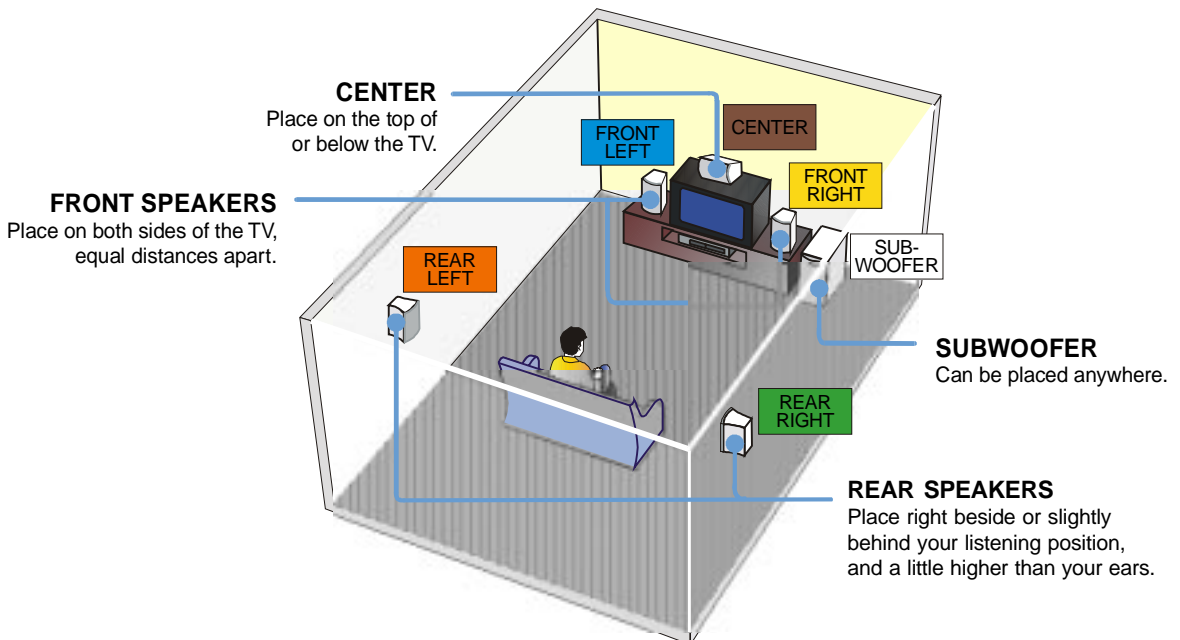

Connections

5. Connecting Other Equipment

You can connect other audio and/or video equipment to your unit in different ways. The following illustrations give a few examples of the connection possibilities.

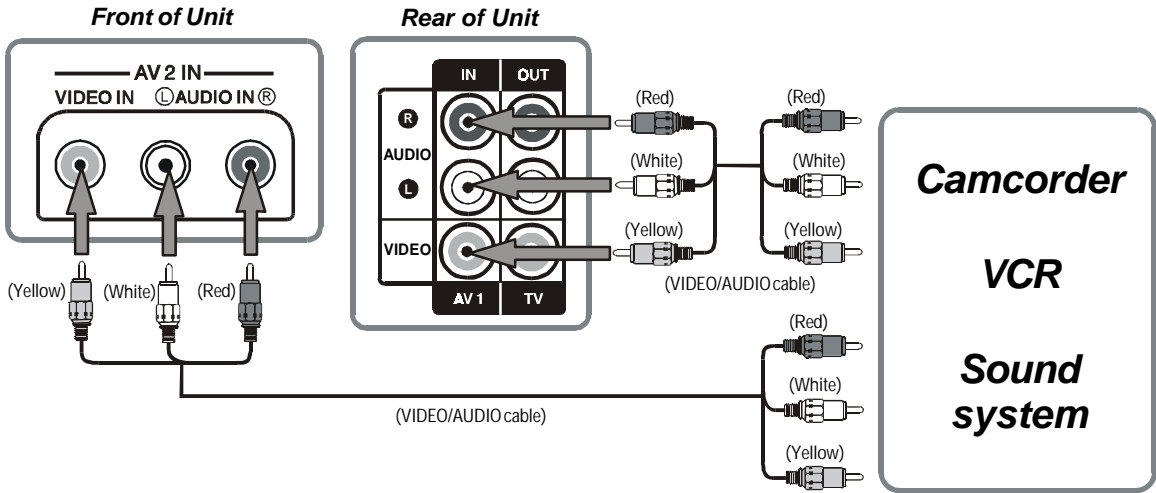

Analogue connection

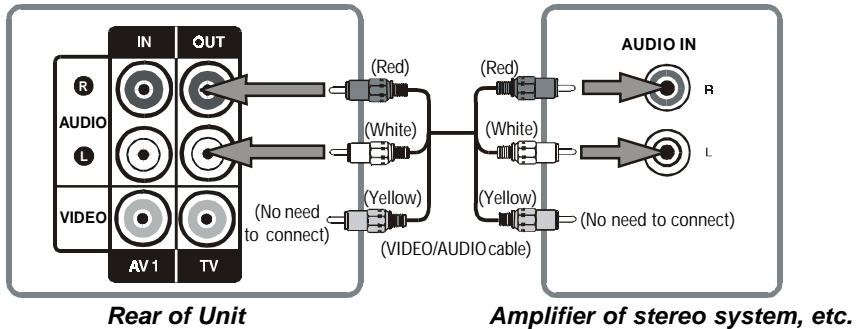

Digital connection

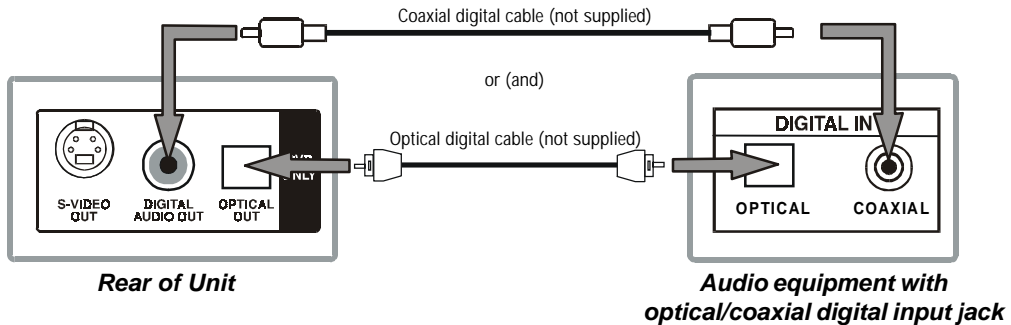

Notes:

- If the external equipment is a television and this audio system is closed to it, you may experience interference if the tuner function is selected while the television is working.
- When you have selected TUNER function, sound will ONLY come from the front left, right speakers and subwoofer.
- If you have a stereo VCR, make sure you set it in stereo mode.
- Due to copyright protection, DVD movies cannot be copied. If you copy a DVD movie onto a videotape, the resulting copy will be unclear, with poor sound quality. This is NOT caused by a defective DVD system.

Connections

Mounting rear surround speakers

- 1) Mark the correct mounting position on the wall.
- 2) Insert a fixing screw(s) at the marked position on the wall.
- 3) Align the slot hole(s) of the speaker over the screw and pull the speaker downward until it is firmly hooked.

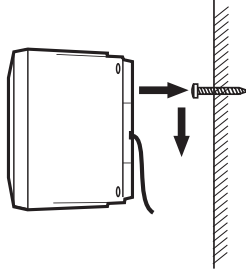

Turning on the Unit and TV

- 1) Press the **MAIN POWER** button to turn the Unit ON, or
- 2) Press the **POWER** button on the remote control while the Unit is in standby mode.
- 3) Turn on the TV by pressing its **POWER** button.
- 4) Select the channel on your TV corresponding to the VIDEO IN jack that the Unit is connected to. See TV User guide for more information.
 - If you have connected the Unit successfully, the DVD logo (start-up picture) will appear on your TV screen.



Power cord connection

- Make sure that all the components and speakers are connected correctly.
- **To prevent electrical shock, match wide blade of plug to wide slot, fully insert.**
- Be sure the AC power cord is disconnected and all functions are off before making connections.
- When you are not going to use the Unit for a long period of time, disconnect the power cord.

Adjusting the Sound

To adjust the surround sound balance while Pro Logic decoding is in effect

Use the remote control to make the following changes to speaker balance:

Front speaker (left)

- Press the **SOUND** button repeatedly to display LEFT, then press the **▼** or **▲** **CURSOR** button to adjust the sound level. It will show on the display of the Unit.

Front speaker (right)

- Press the **SOUND** button repeatedly to display RIGHT, then press the **▼** or **▲** **CURSOR** button to adjust the sound level. It will show on the display of the Unit.

Center speaker

- Press the **SOUND** button repeatedly to display CENTRE, then press the **▼** or **▲** **CURSOR** button to adjust the sound level. It will show on the display of the Unit.

Rear speaker (left)

- Press the **SOUND** button repeatedly to display REAR L, then press the **▼** or **▲** **CURSOR** button to adjust the sound level. It will show on the display of the Unit.

Rear speaker (right)

- Press the **SOUND** button repeatedly to display REAR R, then press the **▼** or **▲** **CURSOR** button to adjust the sound level. It will show on the display of the Unit.

Subwoofer

- Press the **SOUND** button repeatedly to display WOOFER, then press the **▼** or **▲** **CURSOR** button to adjust the sound level. It will show on the display of the Unit.

Note :

- If you do not press any button within a few seconds, the display will return to normal.

To adjust the sound quality

Press the **SOUND** button repeatedly to select an equalization mode (**BASS, MIDDLE, TREBLE**). Press the **▼** or **▲** **CURSOR** button to adjust the sound level.

BASS : the low range of sounds

MIDDLE : the mid range of sounds

TREBLE : the high range of sounds

Bass, middle and treble control the sound from the front left and right speakers.

Dolby Pro Logic is a sound system that was developed to get a better sense of presence from sources encoded with Dolby Surround. The feeling of position has been improved by the addition of a separate center speaker channel. Look for this logo on your DVD Unit.



Dolby Digital

Dolby Digital is a sound system developed by Dolby Laboratories Inc. that gives movie theatre ambience to audio output when the Unit is connected to a Dolby Digital 5.1 channel processor or amplifier.

This Unit automatically recognizes DVDs that have been recorded with Dolby Digital.

Not all Dolby Digital sources are recorded with 6 channels.

Some sources marked Dolby Digital may be recorded in Dolby Surround, a 2 channel system. Look for this logo on your DVD Unit.



Manufactured under license from Dolby Laboratories.

'Dolby', 'Pro Logic' and the double-D symbol  are trademarks of Dolby Laboratories.

Adjusting the Sound

To select the listening channel

1. When the disc is stopped, you can press 5.1 CH and 2.1 CH buttons on the remote control to select different speakers output status shown as below table.
2. You can active or off subwoofer output by setup menu.

Note:

The wording "2.1 CH" will be corresponded to the audio/sound output from Front Left and Front Right speaker plus the Subwoofer.

The following tables show which speakers are working in the various modes.



DISC	Audio Settings			Speakers Output Status					
	5.1 CH / 2.1 CH	Subwoofer	L/R Speaker	Front Left Speaker	Front Right Speaker	Center Speaker	Subwoofer	Rear Left Speaker	Rear Right Speaker
DVD CD	5.1 CH	ON	Small	✓	✓	✓	✓	✓	✓
			Large	✓	✓	✓	X	✓	✓
	5.1 CH	OFF	Small / Large	✓	✓	✓	X	✓	✓
	2.1 CH	ON	Small / Large	✓	✓	X	✓	X	X
	2.1 CH	OFF	Small / Large	✓	✓	X	X	X	X
MP3	N/A	ON	Small / Large	✓	✓	X	✓	X	X
	N/A	OFF	Small / Large	✓	✓	X	X	X	X

Sources	Audio Settings				Speakers Output Status					
	Output Channel	3 Stereo / Pro Logic	Subwoofer	L/R Speaker	Front Left Speaker	Front Right Speaker	Center Speaker	Subwoofer	Rear Left Speaker	Rear Right Speaker
TUNER	N/A	N/A	N/A	N/A	✓	✓	X	✓	X	X
VCR / AV_IN	4 CH	Pro Logic	ON	Small	✓	✓	✓	✓	✓	✓
			ON	Large	✓	✓	✓	X	✓	✓
			OFF	Small / Large	✓	✓	✓	X	✓	✓
	3 CH	3 Stereo	ON	Small	✓	✓	✓	✓	X	X
			ON	Large	✓	✓	✓	X	X	X
			OFF	Small / Large	✓	✓	✓	X	X	X
	2 CH	OFF	ON	Small / Large	✓	✓	X	✓	X	X
			OFF	Small / Large	✓	✓	X	X	X	X

REMARKS:

- 1) Generally, only Front Left, Right speakers and Subwoofer are active at TUNER mode.
- 2) "✓" The speakers is activated.
- 3) "X" The speakers is not activated.
- 4) Always keep your VCR in stereo mode otherwise the speakers output status may be different to above listed table.
- 5) You can only set 5.1 CH, 2.1 CH when the disc is stopped.
- 6) In Subwoofer On mode, if speaker is set to "Large", then the output of subwoofer is low.



This owner's manual explains the basic instructions of this Unit. Some DVD discs are produced in a manner that allows specific or limited operation during playback. As such, the Unit may not respond to all operating commands. This is not a defect in the Unit. Refer to the instruction notes of discs.

“” may appear on the TV screen during operation. A “” means that the desired operation is not permitted by the Unit or the disc.



Playing a Disc

1. Press the **POWER/STANDBY** button on the front panel or press the  **POWER** button on the remote control to turn on the Unit while the Unit is in standby mode.
2. Press the **FUNCTION** button to select DVD mode.



See **CUSTOMIZING THE FUNCTION SETTINGS** (page 33 to 41) before proceeding to step 3.

3. Press the  **OPEN / CLOSE** button. The disc tray opens.
4. Place the disc on the disc tray with the label side up.
5. Press the  **OPEN / CLOSE** button. The disc tray closes.
It takes a short while for your Unit to load the disc. After loading, for some discs, the Unit will automatically start playback of the disc.
5. Press the  **PLAY** button.



Notes:



- Use the  **OPEN / CLOSE** button on the front panel to open or close the disc tray. Do not push the disc tray or you may damage the Unit.
- Let the disc tray open completely before removing the disc. Press the  **OPEN / CLOSE** button to close the disc tray after you remove the disc.

Pausing playback (still mode)



Press the  **PAUSE** button. To resume normal playback, press the  **PLAY** button.

Stopping playback

Press the  **STOP** button at the location where you want to interrupt playback. To resume playback at the position where the disc was stopped, press the  **PLAY** button.

If you press the  **STOP** button twice, the Unit's memory will be cleared and pressing the  **PLAY** button will reset the disc to the beginning.





To skip to a different track

- Press the  **PREV** button once to skip to the start of the previous track.
- Press the  **NEXT** button to skip to the next track.
- For audio CD disc, use the number buttons (remote control only) to jump straight to that track number.

Playing a Disc

Fast Forward/Fast Reverse

1. Press the **TUNING**  or **◀TUNING** button when a disc is playing.

- The disc begins fast scan at x2 speed.
- Four speeds are available. Each time **TUNING**  or **◀TUNING** button is pressed, the speed of fast scan changes in the following sequence:  x 2  x 4  x 8  x 20

The speed of fast scan

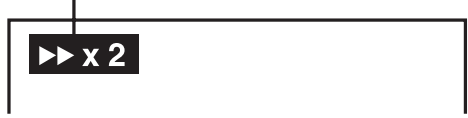



Note :

You also can press and hold **◀◀REW** and **▶▶F.FWD** buttons on front panel repeatedly to select different fast scan speed.

2. Press the **▶ PLAY** button when you reach the desired point to resume playback at normal speed.

Slow-motion play

1. Press the **SLOW**  button in the play mode.

- Two speeds are available. Each time **SLOW**  button is pressed, the speed of slow-motion playback changes in the following sequence:

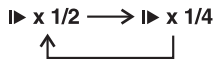

2. Press the **▶ PLAY** button to return to the normal playback speed.

SKIP (Forward)

While you are playing a disc, press the **▶▶NEXT** button of the remote or **▶▶F.FWD** button of front panel to move to the beginning of the next chapter or track. Press the **◀◀PREV** button of the remote or **◀◀REW** button of the front panel to move to the previous chapter or track and automatically start playing it.

Zooming into an image

While a disc is playing, press the **ZOOM** button.

- While an image is zoomed, you can use **▲**, **▼**, **◀** and **▶** button to shift the view and display the part you want.
- To return to the normal view, press the **ZOOM** button until the "Qoff" symbol shows. The screen will return to normal.

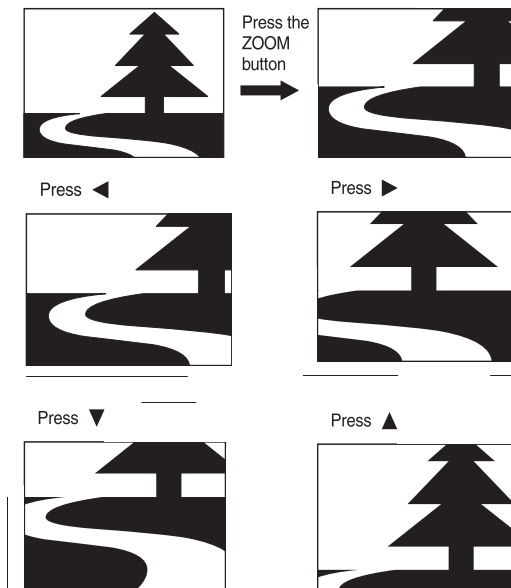

- When you reach the edge of the image, the display will not shift anymore in that direction.

Angle selection

Some DVDs contain scenes which have been shot from a number of different angles. For these discs, the same scene can be viewed from each of these different angles.

1. While you are playing a DVD with different angles recorded, press the **ANGLE** button to view the number of the current angle.

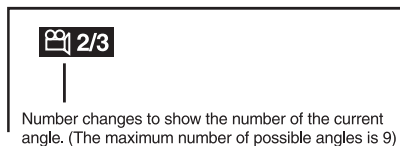

2. Press the **ANGLE** button repeatedly to change the scene to the next angle in those recorded.

- About two seconds later, playback continues from the new angle you selected.
- If no button is pressed within 10 seconds, playback continues without changing the current angle.

Sequence of angle shots

EX.:

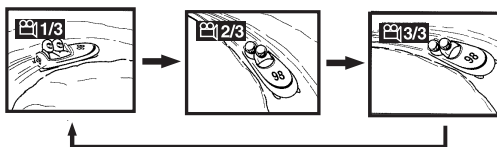

Notes:

- This function can only be used for discs on which scenes shot from multiple angles have been recorded.
- If only one angle is recorded, “ 1/1 ” is displayed.

Audio selection

On some discs, the sound is recorded in two or more formats. Follow the directions below to select the type of playback.

1. While a disc is playing, press the **AUDIO** button to show the current audio format number.

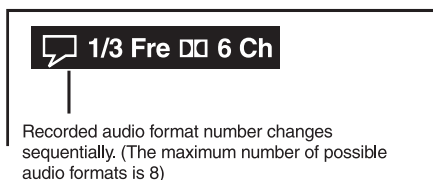



2. Press the **AUDIO** button repeatedly to select the desired audio format.

Notes :

- If only one audio format is recorded, the number does not change.
- About two seconds later, playback continues in the new audio format.

Subtitle selection

1. While a DVD is playing, press the **SUBTITLE** button to display the current language setting, as shown in the example below.

 1/3 Eng →  2/3 Spa →  3/3 Fre →  Off

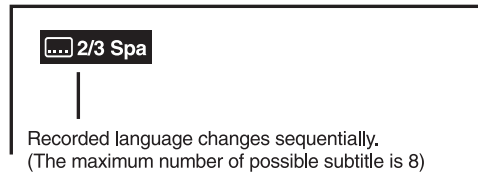

2. Press the **SUBTITLE** button repeatedly to select the desired subtitle language.

Notes :

- If only one language is recorded, the language does not change.
- About two seconds later, playback continues with the new subtitle you selected.
- The number of languages recorded differs depending on the disc.
- If no button is pressed within a few seconds, playback continues without changing the current subtitle.
- This function can only be used for discs on which subtitles have been recorded in multiple languages.
- On some DVDs, subtitles are activated from the main menu of the DVD. Press the **MENU** button to activate the main menu.

DISPLAY function

Using DISPLAY, you can check and change the current settings of the following items: ANGLE, AUDIO and SUBTITLE.

- While the disc is playing, press the **DISPLAY** button to display the screen shown below.
Elapsed time: Elapsed time from the beginning of the chapter which is currently playing.
Remaining time: Remaining time of the title which is currently playing.

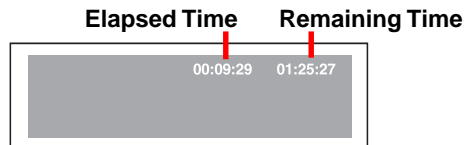

- Press the **DISPLAY** button twice to display the screen shown as below.
- Press the **ANGLE**, **AUDIO** and **SUBTITLE** button to change the selected item.

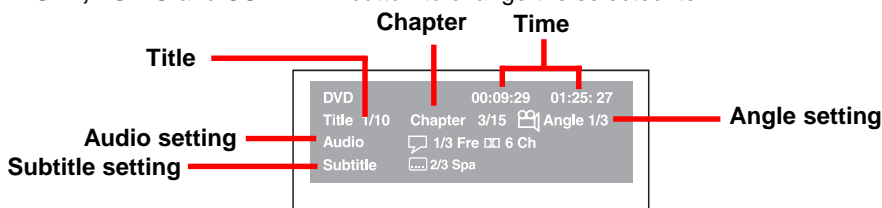

Title skip

- The number of the title currently playing and total titles of disc.
- Press the **GOTO** button to set your desired title, then press the **ENTER** button to confirm.

Chapter skip

- The number of the chapter currently playing and total chapters of the currently played title.
- Press the **GOTO** button to set your desired chapter, then press the **ENTER** button to confirm.

Time skip

- Elapsed time from the beginning of the currently playing chapter and the remaining time from the beginning of the currently playing title.
- Press the **GOTO** button to set your desired point to start playback, then press the **ENTER** button to confirm.

Angle setting

- The current angle is displayed. When a disc with only one angle is played back, "Angle 1/1" is displayed.
- Press the **ANGLE** button to select the desired angle.

Audio setting

- The type of audio currently selected is displayed.
- Press the **AUDIO** button to select your desired type of audio.

Subtitle setting

- The subtitle number and language currently selected is displayed. When a disc with only one subtitle is played back, "1/1 Eng" is displayed.
- Press the **SUBTITLE** button to select your desired language.

GOTO function

This function allows you to skip directly to any part of the disc while a disc is playing.

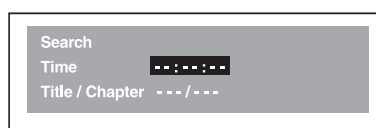

Note :

- After settings, press the **DISPLAY** button again to return to the normal screen.

Special Functions

Locating a specific title

If a DVD disc contains title numbers, you can locate a specific title by directly selecting a title number.

1. In stop mode, press the **GOTO** button.
2. Press **▼**, **◀** or **▶** button to highlight a specific field and press the corresponding number button(s) for the title you want.
3. Press the **ENTER** button to confirm. The Unit will start playback about 3 seconds later.

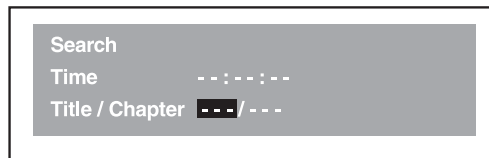

Note :

- Pressing the **CLEAR** button resets the title number.

Locating a specific title / chapter / track

If you know the title / chapter / track number you want to play, you can locate a specific title / chapter / track by directly selecting a title / chapter / track number.

1. Press the **GOTO** button to search your desired title / chapter / track.
2. Press **▼**, **◀** or **▶** button to highlight a title / chapter / track and press the corresponding number button(s) for the chapter you want.
3. Press the **ENTER** button to confirm. The Unit will start playback about 3 seconds later.

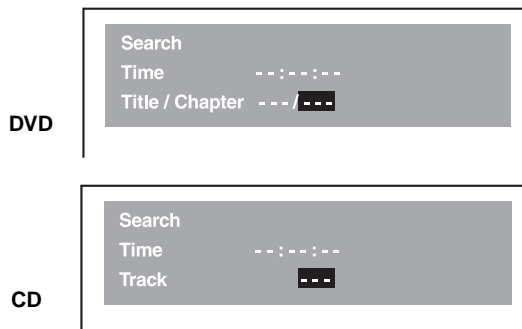

Note :

- Pressing the **CLEAR** button resets the title / chapter / track number.

Locating a specific time

You can move to a specific location by entering its corresponding time (hours, minutes, seconds)

1. Press the **GOTO** button.
2. Press **▲** or **▼** button to highlight time.

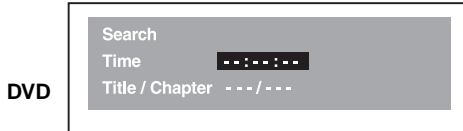

3. Press the corresponding number buttons for the setting point you want.
 - The first two numbers you entered represent hours.
 - The second two numbers you entered represent minutes.
 - The third two numbers you entered represent seconds.
4. Press the **ENTER** button to confirm. The Unit will start playback about 3 seconds later.

Notes :

- Some discs may not respond to this process.
- Some scenes may not be located as precisely as you specified.
- This method for accessing specific locations is available only within the current title of the DVD disc.
- You can move through the menu by pressing the **▲** and **▼** buttons.
- Pressing the **CLEAR** button resets the time.

Angle setting

1. Press the **DISPLAY** button twice. The FUNCTION menu is displayed on the screen and you can see how many angles are recorded on the disc.
2. Press the **ANGLE** button repeatedly to select your desired angle.
3. The Unit will change to your desired angle about 3 seconds later.
4. Press the **DISPLAY** button to resume the normal screen.

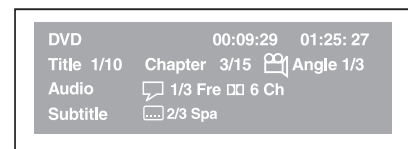

Audio setting

1. Press the **DISPLAY** button twice. The FUNCTION menu is displayed on the screen and you can see how many audio formats are recorded on the disc.
2. Press the **AUDIO** button repeatedly to select your desired type of audio.
3. The Unit will change to your desired type audio about 3 seconds later.
4. Press the **DISPLAY** button to resume the normal screen.

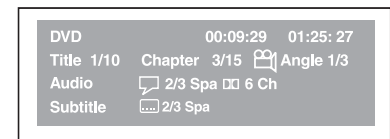
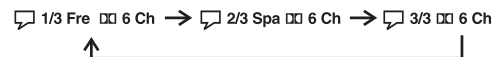

Subtitle setting

1. Press the **DISPLAY** button twice. The FUNCTION menu is displayed on the screen and you can see how many subtitle formats are recorded on the disc.
2. Press the **SUBTITLE** button repeatedly to select your desired language.
3. The Unit will change to your desired language about 3 seconds later.
4. Press the **DISPLAY** button to resume the normal screen.

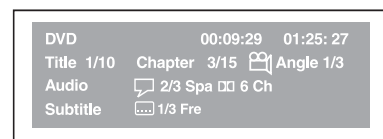
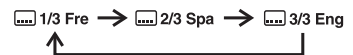

Programmable memory

The two types of programmed playback provided by this Unit are title programmed playback and chapter programmed playback.

Title / Chapter programmed playback

1. Press the **MEMORY** button while the disc is stopped.
2. Enter the title numbers in **--**. Use **◀** or **▶** button to move the highlight to chapter and enter the chapter numbers in **--**.

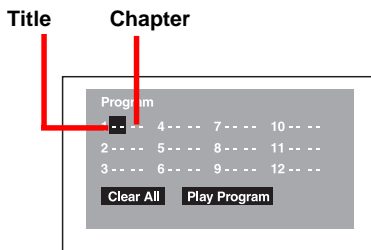

3. Use **◀**, **▶**, **▲** or **▼** button to move to the other field.
4. Repeat steps 2 to 3.
5. Press the **▶ PLAY** button to start the programmed playback.

Notes :

- If you press the **■ STOP** button, the programmed selections will be cleared.
- If you press the **CLEAR** button while you are entering a title or chapter, the currently entered numbers will be erased and you can reset the numbers again.

Programmable memory

Track programmed playback

1. Press the **MEMORY** button while the disc is stopped.
2. Enter the track numbers in **---**.

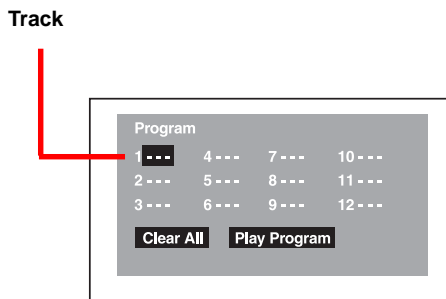

3. Use **◀**, **▶**, **▲** or **▼** button to other field.
4. Repeat steps 2 to 3.
5. Press the **▶ PLAY** button to start the programmed playback.

Note :

- If you press the **CLEAR** button while you are entering a track, the currently entered numbers are erased and you can reset the numbers again.

You can play a specific title or chapter repeatedly.

(Title repeat, chapter repeat, A-B repeat)

Repeating a title

You can play the same title repeatedly.

1. While the disc is playing, press the **REPEAT DISC** button until the “**Repeat Title**” indicator displays on the screen. The current title is played repeatedly.

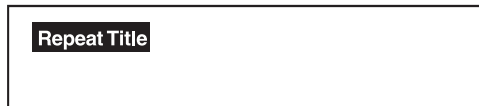

Repeating a chapter

You can play the same chapter repeatedly.

2. While the disc is playing, press the **REPEAT DISC** button until the “**Repeat Chapter**” indicator displays on the screen. The current chapter is played repeatedly.

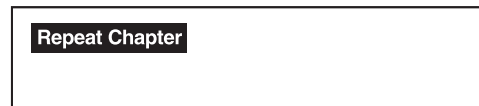

To resume normal playback

3. While the disc is playing, press the **REPEAT DISC** button until the “**Repeat Off**” indicator displays on the screen.

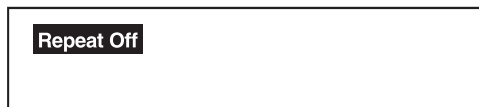

You can play a single track and whole disc repeatedly.

Repeating a single track

You can play the same track repeatedly.

1. While the disc is playing, press the **REPEAT DISC** button until the “**Repeat Single**” indicator displays on the screen. The current track is played repeatedly.

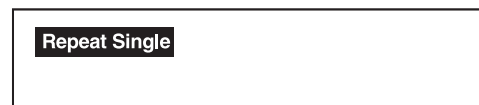

Repeating a whole disc

2. While the disc is playing, press the **REPEAT DISC** button until the “**Repeat All**” indicator displays on the screen. The whole disc is played repeatedly.

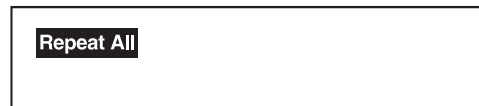

To resume normal playback

3. Press the **REPEAT DISC** button until the “**Repeat Off**” indicator displays on the screen.



Repeating a specific section

You can play a specific section repeatedly.

1. While the disc is playing, press the **REPEAT A-B** button at the beginning of the section () is displayed you want to play repeatedly.

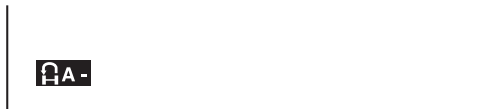

2. Press the **REPEAT A-B** button again at the end of the section () is displayed.



3. The Unit will immediately begin replaying your selection.

To resume normal playback

4. While the disc is playing, press the **REPEAT A-B** button until the "Off" indicator displays on the screen.



Notes :

- A-B repeat can only be used within the same title. If the start and end of the section to be repeated are in different titles, A-B repeat is cancelled.
- The A-B repeat function does not operate in scenes where different camera angles are recorded.

Playing MP3 and Picture File Disc

This Unit will play MP3 and Picture files recorded on CD-R and CD-RW discs.

Playing a MP3 file disc

1. Press the **▶OPEN /CLOSE** button, the disc tray opens.
2. Insert a MP3 file disc on the disc tray with the label side up.
3. Press the **▶OPEN/CLOSE** button, the disc tray closes.
4. The Unit will take a short while to load the disc and automatically begin playback.

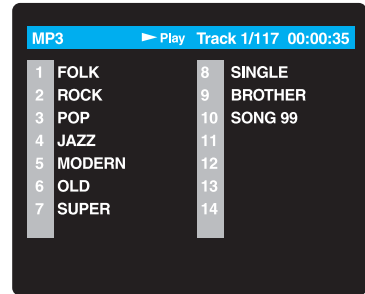

To pause playback

- Press the **⏸PAUSE** button. To resume playback again, press the **▶PLAY** button.

To stop playback

- Press the **■STOP** button.

To skip to the next or previous file

- Press the **▶▶NEXT** button on the remote control or the **▶▶ F.FWD** button on the front panel briefly while playing, to skip ahead to the beginning of the next file. Each time you press the button consecutively, the beginning of the next file is located and played back.
- Press the **◀◀PREV** (Previous) button on the remote control or the **◀◀ REW** button on the front panel briefly while playing, to skip back to the beginning of the previous file. Each time you press the button consecutively, the beginning of the previous files is located and played back.
- You also can press the **GOTO** button, set the track number you want and then press the **ENTER** button.

Notes:

1. You can not play in Fast reverse or Fast forward during MP3 playback.
2. During MP3 playback, if you press the **■STOP** button and then press the **▶PLAY** button again, it will start to play from the beginning of the file which you stopped.

On-screen display

Turn on your TV to view the on-screen display of MP3 files.

1. Press the **MENU** button on the remote control to view the DIR (directory) folder.
2. Press the cursor **▲**, **▼**, **◀** or **▶** button on the remote control to select the folder, then press the **ENTER** button to confirm.
3. Press the cursor **▲**, **▼**, **◀** or **▶** button on the remote control to select the file you want to listen to, then press the **ENTER** button and this selected file is located and played back.

Notes:

The ability of this Unit to read MP3 discs is dependent on the following:

- The Bit Rate must be within 64 - 256 kbps.
- The total number of files on the disc should not exceed 254.
- The maximum number of directories should not exceed 32.
- The maximum depth level of directories should not exceed 4.
- File names should be named using 7 or fewer letters and/or numbers, and must incorporate the "MP3" file extension. EXAMPLE: *****.MP3 where each * is a letter or number.
- Use only letters and / or numbers in file names. If you use special characters, the file and/or folder names may not be displayed correctly on the on-screen display.
- When recording on CD-R discs, use 74-minute (650Mb) discs.
- The CD-R or CD-RW discs should be "finalized" in computer by "single session format".
- See your CD/MP3 creation software for details.

Playing MP3 and Picture File Disc

Playing a Picture file disc

1. Press the **▲OPEN /CLOSE** button, the disc tray opens.
2. Insert a Picture CD on the disc tray with the label side up.
3. Press the **▲OPEN/CLOSE** button, the disc tray closes.
4. The unit will take a short while to load the disc.
5. Press the **▶PLAY** button. The next picture will automatically display after 6 seconds.

Full-Screen
Review



Thumbnail
Review

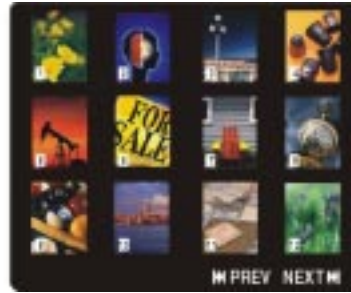

Notes:

- If you press the **MENU** button on the remote control, or press the **■ STOP** button in full-screen review, the Unit will display a menu of 12 thumbnail images.
- Press the **▶▶ NEXT** or **◀◀ PREV** button to review all the images. If you want to review one image in full-screen, you can use the cursor **◀, ▶, ▲** or **▼** buttons to highlight the image and then press the **ENTER** button to confirm. The image you selected will show on TV in Full-Screen. Press the **▶▶ NEXT** or **◀◀ PREV** button to review other images.
- Press the **▶PLAY** button, the images will automatically display one by one again in about 6 seconds intervals.
- You can press the **PAUSE** button to interrupt playback, and press the **▶PLAY** button to resume playback.
- You also can use GOTO function or use the numbered buttons to enter the number to quickly select any image.
- You can press the **ZOOM** button to enlarge the picture in 3 levels.
- Press the **ANGLE** button on the remote control to rotate the picture orientation by 90°.
- Press the **AUDIO** button on the remote control to change the picture presentation direction.

Playing a MP3/Picture file disc

1. Press the **▲OPEN /CLOSE** button, the disc tray opens.
2. Insert a MP3 files/Picture CD on the disc tray with the label side up.
3. Press the **▲OPEN/CLOSE** button, the disc tray closes.
4. The unit will take a short while to load the disc.
5. Use the cursor **◀** or **▶** button to select MP3 or Picture CD, then press the **ENTER** button.

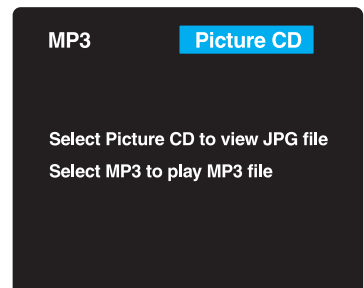

Notes:

- If you want to return to the menu of MP3 and Picture CD, press the **SUBTITLE** button on the remote control.
- When playing MP3 and Picture files, press the **SUBTITLE** button to select MP3 or Picture CD, the **MENU** button does not work in that moment.
- The **SETUP** button does not work during MP3 or Picture Disc playback or stop.

Customizing the Function Settings

LANGUAGE setting

1. Press the **FUNCTION** button until DVD appears on the display.
2. Press the **STOP** button so that no disc is playing.
3. Press the **SETUP** button.
4. Use the cursor ◀ or ▶ button to select the Language, then press the **ENTER** button.
5. Use the cursor ▲ or ▼ button to English, then press the **ENTER** button. The screen will change to English Wordings immediately.
6. To exit the FUNCTION SETUP MENU and return to the normal screen, press the **RETURN** button.

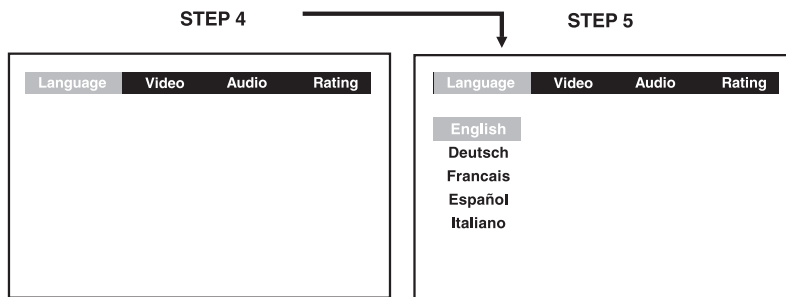

Customizing the Function Settings

VIDEO setting

TV Shape

1. Press the **SETUP** button.
2. Use the cursor ◀ or ▶ button to select Video, then press the **ENTER** button.
3. Use the cursor ▲ or ▼ button to select TV Shape, then press the **ENTER** button.
4. Use the cursor ▲ or ▼ button to shift and select the TV type, then press the **ENTER** button.
5. To exit the FUNCTION SETUP MENU and return to the normal screen, press the **RETURN** button.

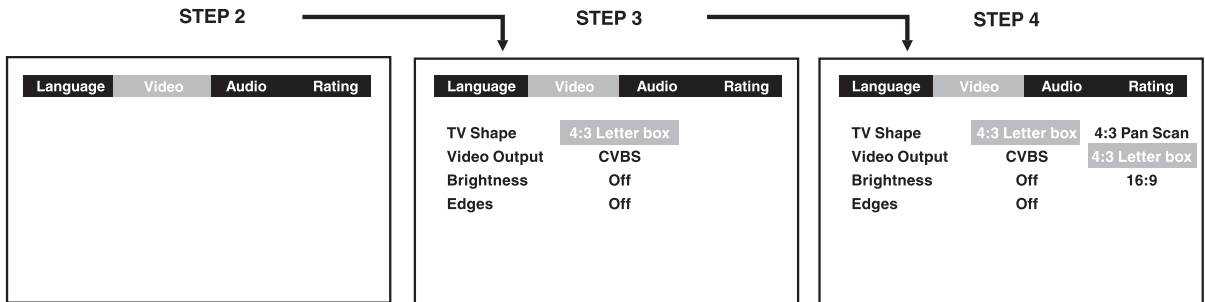

Cut off when a wide-screen video image is played.

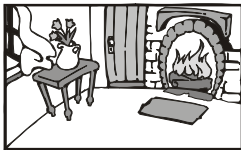
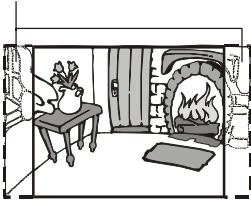

The actual appearance of the image depends on the screen mode setting of your wide-screen TV.

4:3 Pan Scan

- When wide-screen video material is played, this mode clips the right and left sides of the image so that it can be viewed on a conventional TV screen.
- Some wide-screen DVDs that do not permit Pan Scan mode playback are automatically played in letterbox mode (black bands top and bottom).

4:3 Letter Box

- When wide-screen video material is played in this mode on a conventional TV screen, black bands appear at the top and bottom of the screen.

16:9 Wide-screen

- This is the correct mode for playing wide-screen videos on a wide-screen TV.
- You must also set the screen mode on your wide-screen TV to "FULL".

Notes :

- The displayable picture size is preset on the DVD disc. Therefore the playback picture of some DVD discs may not conform to the picture size you select.
- When you play DVD discs recorded in the 4:3 picture size only, the playback picture always appears in the 4:3 picture size regardless of the TV shape setting.
- If you select 16:9 wide-screen mode and you own a 4:3 TV set, the DVD playback picture will be horizontally distorted during playback. Images will appear to be horizontally compressed. Always be sure that your TV shape conforms to the actual TV in use.

Customizing the Function Settings

Video Output

1. Press the **SETUP** button.
2. Use the cursor ◀ or ▶ button to select Video, then press the **ENTER** button.
3. Use the cursor ▲ or ▼ button to select Video Output, then press the **ENTER** button.
4. Use the cursor ▲ or ▼ button to shift and select the signal, then press the **ENTER** button.
5. To exit the FUNCTION SETUP MENU and return to the normal screen, press the **RETURN** button.

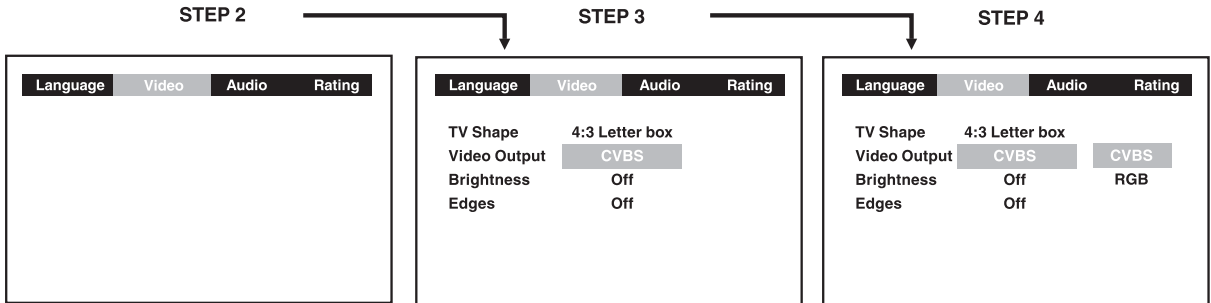

Note:

The RGB option is ONLY useful for use in Europe, and should not be selected.

Attention :

Always set Video Output in CVBS, otherwise, the picture on the TV may be distorted. If this occurs, and you cannot see the screen, follow these instructions:

1. Change FUNCTION to DVD mode.
2. Open the DVD door.
3. Press the **SETUP**, ▶, **ENTER**, ▼, **ENTER**, ▲, **ENTER** & **RETURN** buttons.

Brightness

1. Press the **SETUP** button.
2. Use the cursor ◀ or ▶ button to select Video, then press the **ENTER** button.
3. Use the cursor ▲ or ▼ button to select Brightness, and then press the **ENTER** button.
4. Use the cursor ▲ or ▼ button to shift and select the Off/On, then press the **ENTER** button.
5. If you want to exit the SETUP MENU and return to the normal screen, press the **RETURN** button.

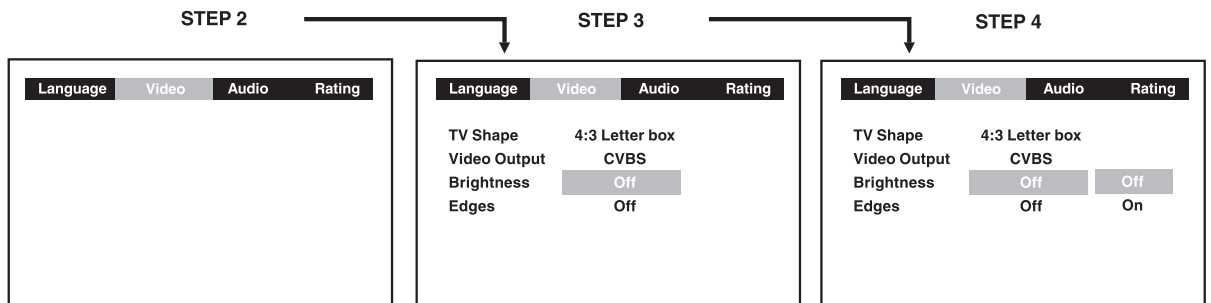

On : Picture will be brighter to clarify details.

Off : Picture will have deepened colors.

Note:

- Actual effect on pictures will vary depending on the TV.

Customizing the Function Settings

Edges

1. Press the **SETUP** button.
2. Use the cursor ◀ or ▶ button to select Video, then press the **ENTER** button.
3. Use the cursor ▲ or ▼ button to select Edges, and then press the **ENTER** button.
4. Use the cursor ▲ or ▼ button to shift and select the Sharpen / Soften / Off, then press the **ENTER** button.
5. If you want to exit the SETUP MENU and return to the normal screen, press the **RETURN** button.

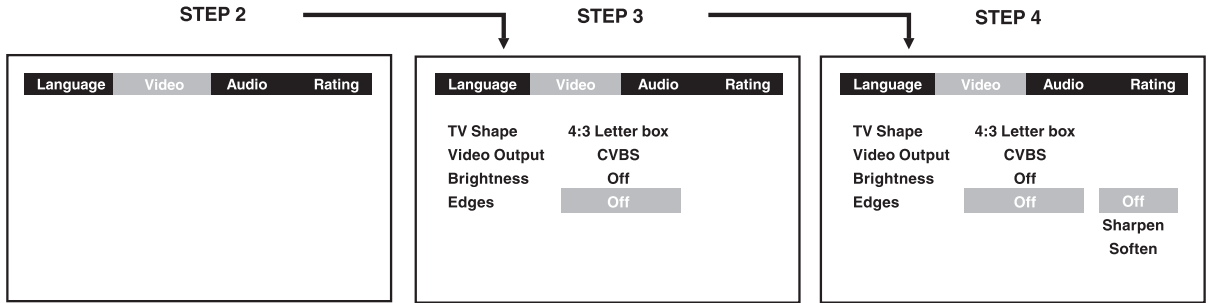

Sharpen : Fine detail will be easier to see.

Soften : Soft-focus effect.

Off : Picture will be returned to normal.

Customizing the Function Settings

AUDIO setting

Digital Out

1. Press the **SETUP** button.
2. Use the cursor ◀ or ▶ button to select Audio, press the **ENTER** button.
3. Use the cursor ▲ or ▼ button to select Digital Out, and then press the **ENTER** button repeatedly to select Digital Out type.
4. To exit the FUNCTION SETUP MENU and return to the normal screen, press the **RETURN** button.

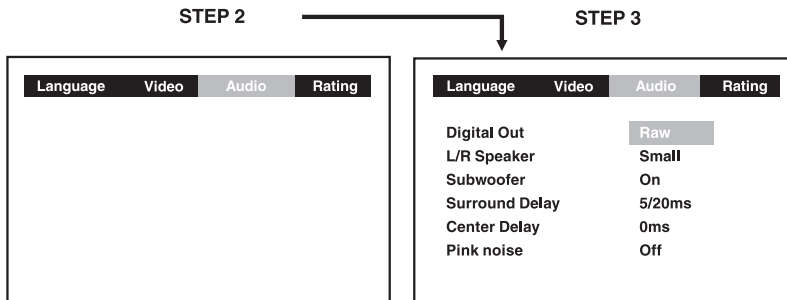

Raw : Does not have a Dolby Digital Decode.

PCM : Do have a Dolby Digital Decode.

L/R Speaker

1. Press the **SETUP** button.
2. Use the cursor ◀ or ▶ button to select the Audio, press the **ENTER** button.
3. Use the cursor ▲ or ▼ button to L/R Speaker, and then press the **ENTER** button.
4. Use the cursor ▲ or ▼ button to select the desired setting, and then press the **ENTER** button.
5. To exit the FUNCTION SETUP MENU and return to the normal screen, press the **RETURN** button.

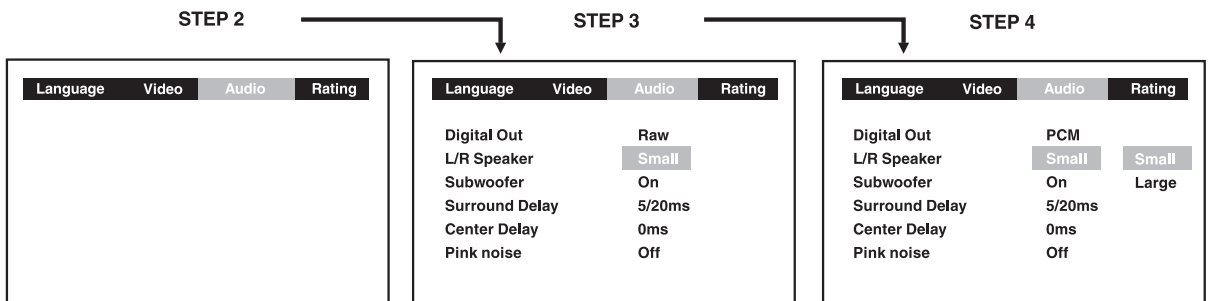

L/R Speaker

Small : Small size of Speaker.

Large : Large size of Speaker.

Note :

- You can adjust the channel balance on your Unit. Please see "ADJUSTING THE SOUND" on page 19.

Customizing the Function Settings

Subwoofer

1. Press the **SETUP** button.
2. Use the cursor ◀ or ▶ button to select the Audio, press the **ENTER** button.
3. Use the cursor ▲ or ▼ button to Subwoofer, and then press the **ENTER** button.
4. Use the cursor ▲ or ▼ button to select the desired setting, and then press the **ENTER** button.
5. To exit the FUNCTION SETUP MENU and return to the normal screen, press the **RETURN** button.

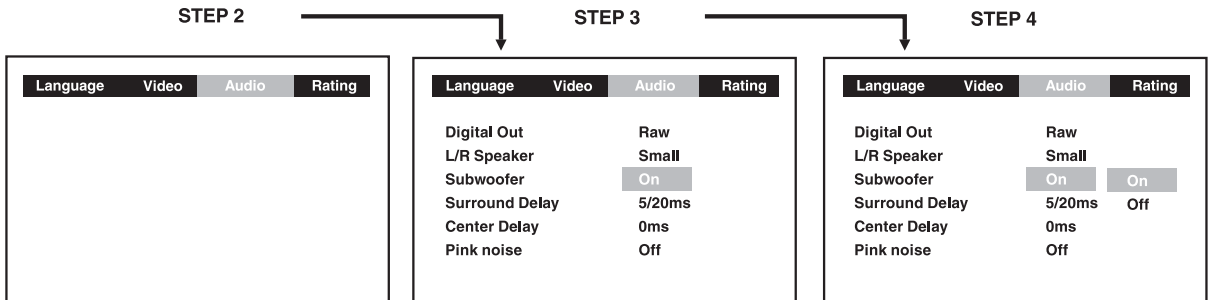

Subwoofer

"On" should be selected if your subwoofer is connected.

If "Off" is selected, no sound will be emitted by subwoofer.

Note :

- You can adjust the channel balance on your Unit. Please see "ADJUSTING THE SOUND" on page 19.

Surround Delay

1. Press the **SETUP** button.
2. Use the cursor ◀ or ▶ button to select the Audio, press the **ENTER** button.
3. Use the cursor ▲ or ▼ button to Surround Delay, then repeatedly press the **ENTER** button to select the desired Surround Delay type. 0/15ms, 5/20ms, 10/25ms or 15/30ms appears.
4. To exit the FUNCTION SETUP MENU and return to the normal screen, press the **RETURN** button.

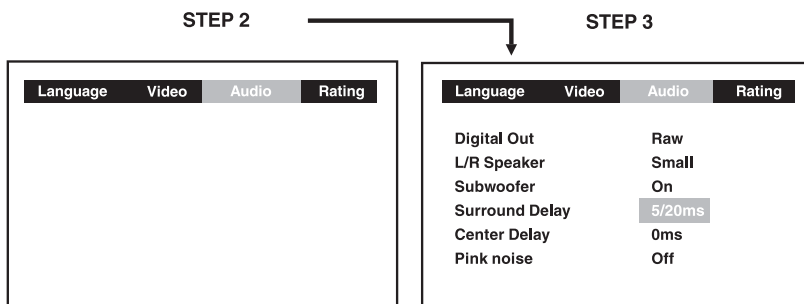

Notes:

- The first number represents the Dolby Digital and the second number represents the Pro Logic.
- The delay adjustment depends on the location of your surround speakers and the front speakers. If the location of the surround speakers is closer than the front speakers, the delay adjustment can compensate the distance difference.

Customizing the Function Settings

Center Delay

1. Press the **SETUP** button.
2. Use the cursor ◀ or ▶ button to select the Audio, press the **ENTER** button.
3. Use the cursor ▲ or ▼ button to Center delay, then repeatedly press the **ENTER** button to select the desired Center Delay type. 0ms, 1ms, 2ms, 3ms, 4ms or 5ms appears.
4. To exit the FUNCTION SETUP MENU and return to the normal screen, press the **RETURN** button.

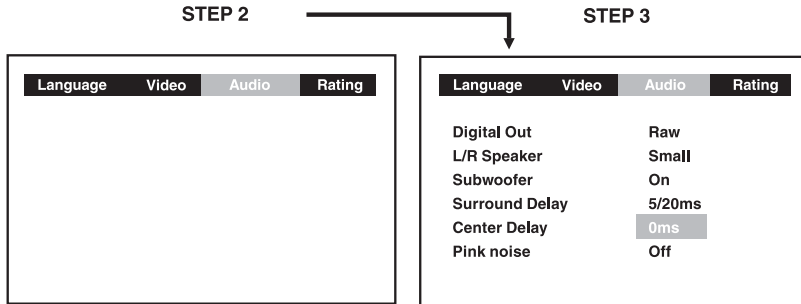

Note:

- This delay adjustment depends on the location of your center speaker. If the distance between the center speaker and the listener is less than the distance between the front right and left speaker and the listener, this delay adjustment is balanced.

Pink noise

1. Press the **SETUP** button.
2. Use the cursor ◀ or ▶ button to select the Audio, press the **ENTER** button.
3. Use the cursor ▲ or ▼ button to Pink noise, and then press the **ENTER** button.
4. Use the cursor ▲ or ▼ button to select the desired setting, and then press the **ENTER** button.
5. To exit the FUNCTION SETUP MENU and return to the normal screen, press the **RETURN** button.

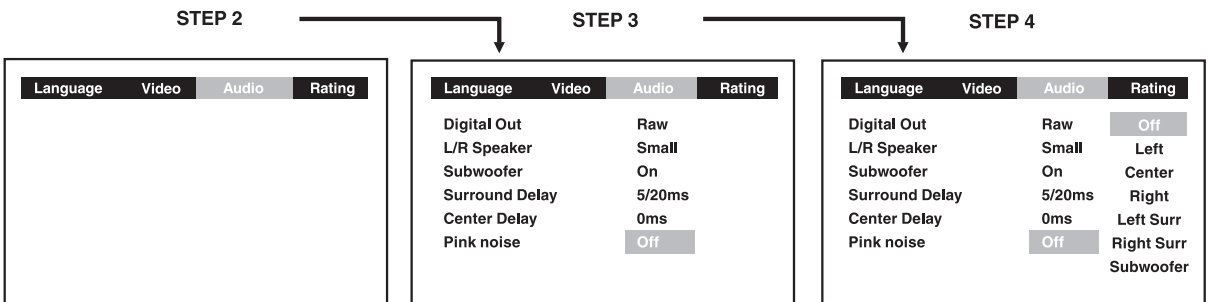

Pink noise

Off : Pink noise test mode should always be switched off, unless you are testing your speakers.

Left : Pink noise comes out from front left speaker for testing.

Center : Pink noise comes out from center speaker for testing.

Right : Pink noise comes out from front right speaker for testing.

Left sur : Pink noise comes out from rear surround left speaker for testing.

Right sur : Pink noise comes out from rear surround right speaker for testing.

Subwoofer : Pink noise comes out from subwoofer for testing.

Note :

- When using the pink noise generator to test your speakers, you can press the **SOUND** button on the remote control to adjust the channel balance. Please "Adjusting the Sound" on page 19.

Customizing the Function Settings

RATING setting

Password/Parental lock

DVD discs equipped with the password function are rated according to their content. The contents allowed by a parental lock level and the way a DVD disc can be controlled may vary from disc to disc.

For example, if the disc allowed, you could edit out violent scenes unsuitable for children and replace them with more suitable scenes, or you could lock out playback of the disc altogether.

1. Press the **SETUP** button.
2. Use the cursor ◀ or ▶ button to select Rating, press the **ENTER** button.
3. Use the cursor ▲ or ▼ button to select parental lock and then press the **ENTER** button repeatedly to set the parental lock level.
4. Use the cursor ▲ or ▼ button to shift and select Password, enter your 4-digit security code and then press the **ENTER** button.

If you make a mistake before pressing the ENTER button, press the CLEAR button and enter your 4-digit security code again.

You cannot play DVD discs rated higher than the level you selected unless you cancel the parental lock function.

The parental lock level is equivalent to the following ratings.

Level 1 : Kid Safe	Level 5 : PG_R
Level 2 : G	Level 6 : R
Level 3 : PG	Level 7 : NC_17
Level 4 : PG_13	Level 8 : Adult

5. To exit the FUNCTION SETUP MENU and return to the normal screen, press the **RETURN** button.



Indicates Parental lock is NOT active.



The Parental lock is active.

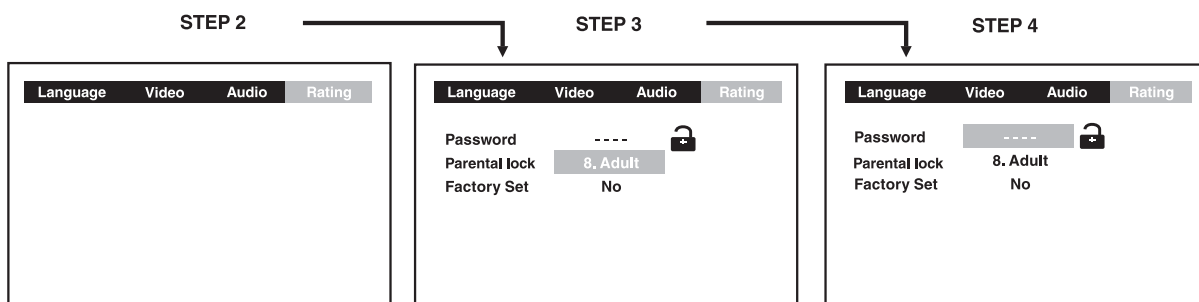

If you forget the password, you can erase your current password by pressing number button 8 on the remote four times, then press the ENTER button to confirm the setting.

PASSWORD : 8 8 8 8

Customizing the Function Settings

Factory Set

If you want to return the initial language setting to the factory default, do the following:

1. Press the **SETUP** button.
2. Use the cursor ◀ or ▶ button to select the Rating, then press the **ENTER** button.
3. Use the cursor ▲ or ▼ button to shift and select the Factory Set, then press the **ENTER** button.
4. Use the cursor ▲ or ▼ button to shift and select Yes, then press the **ENTER** button.
5. To exit the FUNCTION SETUP MENU and return to the normal screen, press the **RETURN** button.

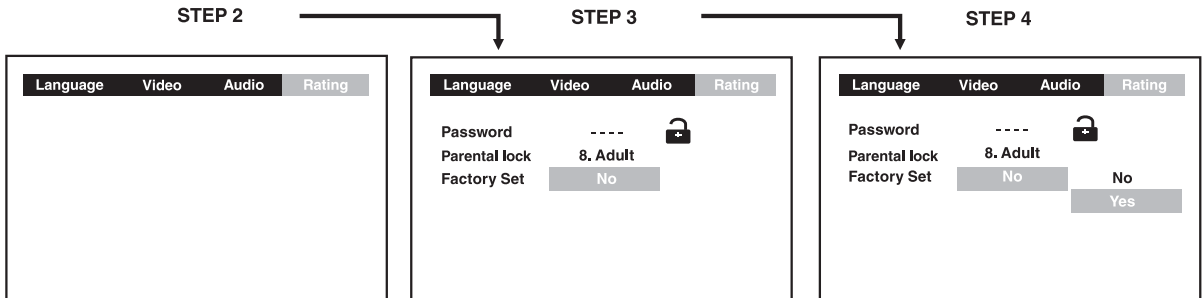

Note:

When you reset the Unit to the factory default, the Unit will take 3-5 seconds to reset.

VCR Setup

MENU Screen

MENU screen is a home screen used to select various screen functions. A submenu will appear once you select an item for the menu.

1. Turn on the TV and select the video channel. (See **Setting the 3 ↔ 4 Output Channel**)
2. Press the **MAIN POWER** button (MAIN POWER indicator will light up) and then press **VCR ON/OFF** button to select "VCR" (VCR indicator will light up).
3. Press the **MENU** button to display the MENU screen.

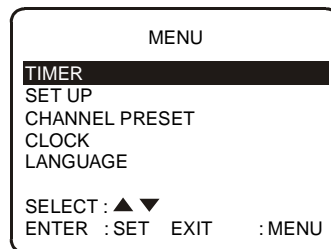

The following 5 items can be set by using the MENU screen.

TIMER.....Setting a timer recording (and checking it).
 SET UP.....VCR operating conditions are set according to the broadcast reception and tape playback conditions.
 CHANNEL PRESET..... Setting the channels.
 CLOCK..... Setting the present time
 LANGUAGE..... Selection of language to be used for the MENU screen.

4. Press the cursor ▲ or ▼ button and then the **ENTER** button. The screen changes to the one which you have selected.
5. To cancel the MENU screen, press the **MENU** button.

OSD (On Screen Display)

To facilitate the operation and check the current VCR mode information, the following OSD (On Screen Display) will appear on the TV screen when using this VCR.

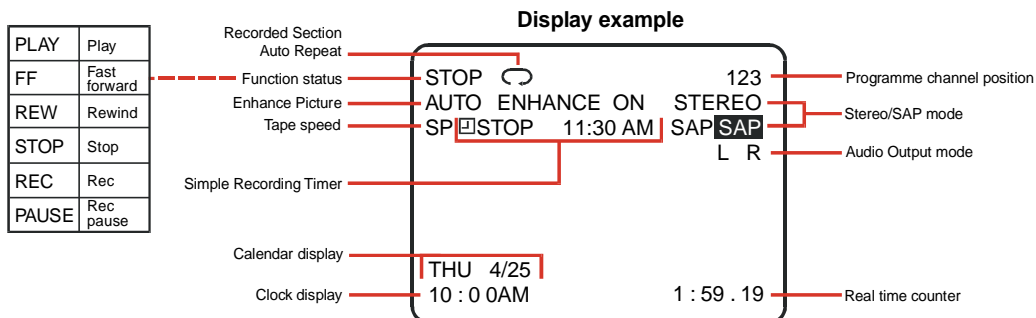

How to Display Indicators

Each time the **DISPLAY** button is pressed, the screen changes as follows:



AUTO Display

When an operation button, numbered button, **CH+** or **CH-** button is pressed, the current function status or the number of the channel will be displayed in the upper section of the TV screen for about 3 seconds.



Notes:

- When the VCR power is turned off, the display mode is retained in memory.
- When you record a video signal output from this VCR on another VCR, press the **DISPLAY** button to select Display Off. (If the function status is displayed on the screen, it is also recorded on the tape.)

VCR Setup

Set Up (with Auto Clock Setting)

IMPORTANT (Caution during Set Up):

- Do not press the VCR ON/OFF button on the VCR or remote control.
- Do not insert a video cassette into the VCR.

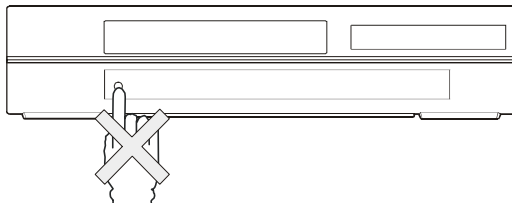

The Set Up function automatically sets the tuner channels and clock when the antenna cable is connected to the rear of the VCR and the power plug is then connected to an AC outlet.

Important:

When using a cable box:

- See **Cable TV Connections**.
- Leave POWER on the cable box turned on and select a channel that carries EDS signals.

Procedures

1. Make sure that the antenna cable is connected. For connection configuration, refer to **Connections**.
 2. Connect the VCR power plug to an AC outlet.
 3. The tuner channels and clock will automatically be set. The VCR POWER indicator will flash quickly to indicate the setting.
- This VCR can monitor and use time-signals (EDS signals), which are provided by some TV stations, to automatically adjust the VCR clock. This VCR automatically searches EDS signals, but if you are in a hurry to use timer recording or know the channel of the EDS signal carrier in your area, follow the procedure in **Auto Clock Setting or Manual Clock Setting**.

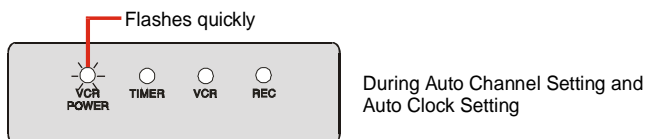

4. When the setting is completed, VCR POWER indicator will flash slowly.

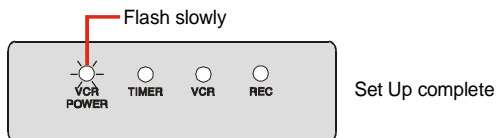

Notes:

- If power is supplied to the VCR before the cable is connected, Set Up will not be able to preset the channels into memory. If this occurs unplug the VCR from the power source and wait a few minutes. Check the cable/antenna connection and supply power to the VCR. Set Up will automatically begin again.
- If the power is turned on during Set Up, the Auto Channel setting will be interrupted and the tuner channels will not be able to be preset.
- Auto Clock Setting may take several minutes.
- If the Auto Clock Setting is not completed within 30 minutes, there may be no channels with EDS signals. In this case, set the clock manually. (See **Manual Clock Setting**.)
- If the antenna signal is weak, the Auto Clock Setting function may not operate.
- During initial channel setting, the channels are set into the AIR channel setting. To watch a cable TV channel, select "CATV" on the CHANNEL PRESET screen. (See **Setting the Channels**.)

VCR Setup

Setting the 3 ↔ 4 Output Channel

The 3 ↔ 4 Output Channel lets you change the VCR OUTPUT to standard TV broadcasting signals. Both your TV and VCR must be set to the same channel (i.e TV on channel 3 and VCR OUTPUT channel on 3 too).

1. Press the **MAIN POWER** button to turn the power off.
2. Press the **TV/VCR** button and if

VCR POWER, TIMER and VCR indicators light up flashing.
The VCR Output Channel is 3.

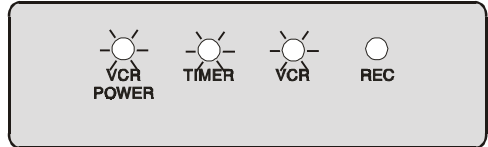

VCR POWER, TIMER, VCR and REC indicators light up flashing. The VCR Output Channel is 4.

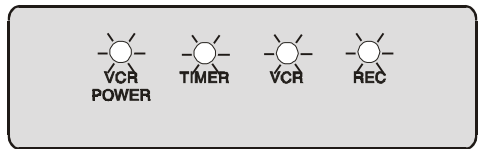

3. To change Output Channel from 3 to 4 (or 4 to 3). Press the **TV/VCR** button for 2 seconds until VCR POWER, TIMER, VCR and REC indicators (or VCR POWER, TIMER and VCR indicators) light up flashing. (As above)
4. Release the **TV/VCR** button, the Output Channel is set.

Notes:

- VCR Output Channel is automatically set during Set Up.
 1. If Channel 3 (or 4) is an active broadcast channel in your area, the Channel 4 (or 3) will be set.
 2. If both channels are active or none are active, the VCR Output Channel will be set to Channel 3.
- Cancelled the Set Up by pressing the **VCR ON/OFF** button during Set Up before setting the Output Channel.

VCR Setup

Mode Selection

You can use the SET UP selection screen to select the mode for basic features.

Preparation

- Turn on the TV and select the video channel. Press the **VCR ON/OFF** button (VCR POWER indicator will light up) and then press the **TV/VCR** button to select “VCR” (VCR indicator will light up).

1. Press the **MENU** button.
2. Select “SET UP” with cursor **▲** or **▼** button and press the **ENTER** button.

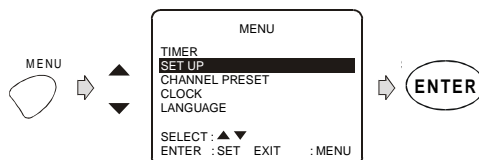

3. Set AUTO REPEAT mode to ON or OFF with cursor **◀** or **▶** button. Then press the **▼** button.

(See **Recorded Section Auto Repeat.**)

- SAP and AUDIO OUTPUT are displayed. See the shaded area below.

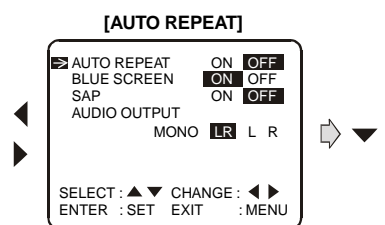

4. Set BLUE SCREEN mode to ON or OFF with cursor **◀** or **▶** button. Then press the **▼** button.

(See **Blue Screen Noise Elimination.**)

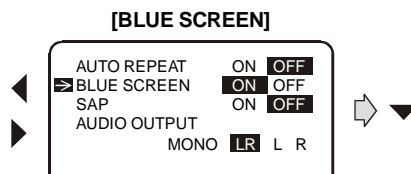

5. Set SAP (Separate Audio Programme) mode to ON or OFF with cursor **◀** or **▶** button. Then press the **▼** button.

(See **Recording MTS [Multi-channel TV sound] Broadcasts.**)

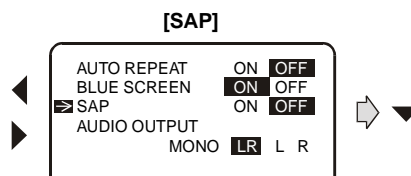

6. Set AUDIO OUTPUT mode to MONO, LR L or R with cursor **◀** or **▶** button.

(See **Audio Output Mode.**)

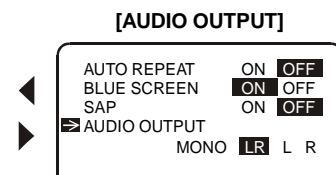

7. Press the **ENTER** button to enter. The screen returns to normal.



Notes:

- If you press the **MENU** button to exit the mode selection screen in **Step 7**, the data will not be stored. Be sure to press the **ENTER** button to store the data.
- SAP is used for bilingual broadcasting. Check your local broadcast station or cable company.

VCR Setup

Channel Preset

Your VCR can receive a maximum of 181 channels as shown below by presetting the channels into memory. (VHF: 2 to 13, UHF: 14 to 69, CATV: 1 to 125)

Preparation

- Make sure that the cable (antenna or CATV) is connected to the IN terminal on the rear of the VCR.

1. Press the **MENU** button.

Select "CHANNEL PRESET" with ▲ or ▼ button and then press the **ENTER** button.

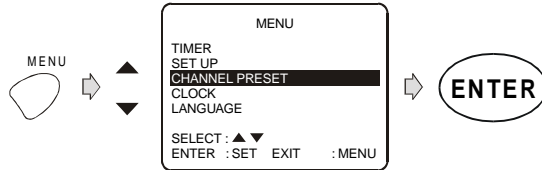

2. Select "AIR" or "CATV" with ◀ or ▶ button and then press the ▼ button.

EX: AIR

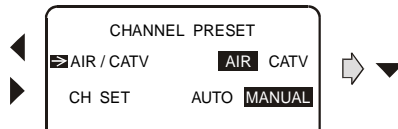

3. Set "CH SET" to "AUTO" with ◀ or ▶ button and then press the **ENTER** button.

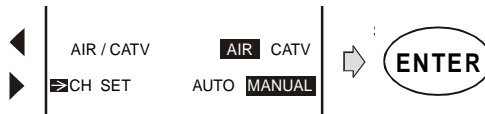

4. The auto tuning will start.

The channel display will count up and when finished, the screen returns to normal.

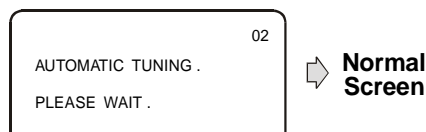

Notes:

- Automatic tuning will not start unless the arrow is at "CH SET-AUTO" position.
- If a button is not pressed within 3 minutes during the setting procedure, the screen will return to normal.
- If the power is interrupted for more than 5 seconds, AIR/CATV selection must be set again.
- Automatic tuning will be interrupted if the **VCR ON/OFF** or **MENU** button is pressed before the screen returns to normal.

VCR Setup

Adding Channel Memory/Erasing Channel Memory

Use this function to manually add or erase channels to/from the memory.

1. Select the channel to be added with the numbered buttons and the channel to be erased with the **CH+**, **CH-** or numbered buttons.
2. Press the **MENU** button. Select "CHANNEL PRESET" with cursor **▲** or **▼** button and press the **ENTER** button.

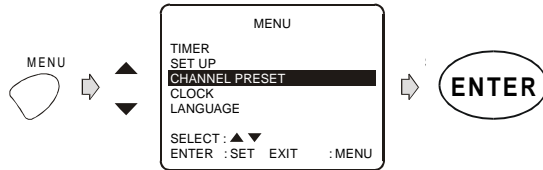

3. Select "CH SET" with cursor **▲** or **▼** button and then select "MANUAL" with cursor **◀** or **▶** button. Then press the **ENTER** button.

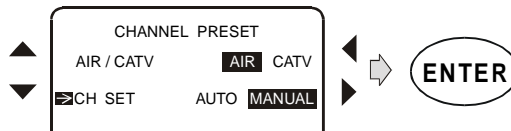

4. Select "ADD" if you want to add the channel memory or "ERASE" if you want to erase the channel memory with cursor **◀** or **▶** button.

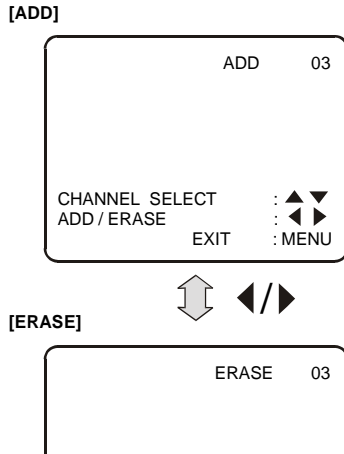

5. Press the **MENU** button to return to the normal screen.

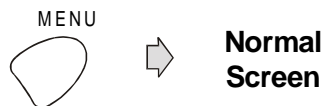

Notes:

- If the power is interrupted for more than 5 seconds, the channel memory may be erased. If this happens, reset the channels again and reset AIR/CATV selection.
- If a button is not pressed within 3 minutes during the setting procedure, the screen will return to normal.

VCR Setup

Clock

Auto Clock Setting (If you DO know a channel that carries EDS signals)

Preparation

- Make sure that the antenna cable is connected and connect the power cord.
- Turn on your TV and select the video channel. (See **Setting the 3 ↔ 4 Output Channel.**)
- Press the **VCR ON/OFF** button (VCR POWER indicator will light up) and then press the **TV/VCR** button to select "VCR". (VCR indicator will light up.)

Important:

When using a cable box:

- **See Cable TV connections.**
- Leave POWER on the cable box turned on and select a channel that carries EDS signals.

1. Press the **MEUN** button.

Select "CLOCK" with the cursor ▲ or ▼ button and then press the **ENTER** button.

2. Select "AUTO" with the cursor ▲ or ▼ button and then press the **ENTER** button.

3. Set EDS CH SET mode to "MANUAL" with the cursor ◀ or ▶ button and then press the cursor ▼ button.

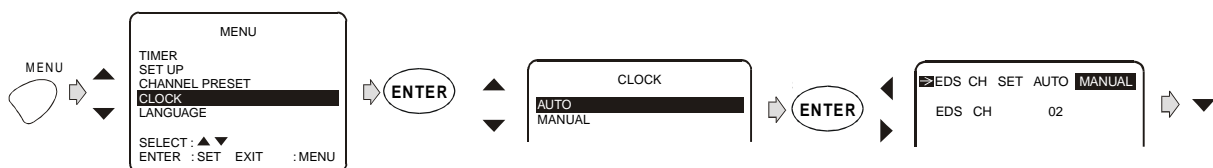

4. Select a channel that carries EDS signals with the cursor ◀ or ▶ button.

EX: 07

- The number of channels that can be selected depends on the mode setting on the CHANNEL PRESET screen. See **Notes.**

When using a cable box: Input the output channel (02, 03 or 04) of the cable box.

5. Press the **ENTER** button to enter. The screen returns to normal.

Press the **VCR ON/OFF** button to turn off the VCR (VCR indicator will turn off and VCR POWER indicator will turn off).

The Auto Clock Setting function will automatically set the clock.



Notes:

- If the EDS CH SET mode is set MANUAL mode in **Step 3** and a channel that does not carry EDS signal is selected in **Step 4**, the Auto Clock Setting function will not operate.
- In **Step 4**, the number of channels that can be selected depends on the mode setting on the CHANNEL PRESET screen. See the table below.

AIR/CATV	Channels to be selected
AIR	02 ↔ 03 ↔ 04.....68 ↔ 69 ↔ 02
CATV	01 ↔ 02 ↔ 03124 ↔ 125 ↔ 01

- In **Step 1**, if you press the **MENU** button when operating the screen setting for the first time or after a power failure of more than 5 seconds, the LANGUAGE screen will appear.
- If you entered incorrect data during the setting procedure, re-enter the correct data in the following manner:
 1. Use the cursor ◀ or ▶ button to select the data to be corrected.
 2. Set the correct data with the cursor ▲ or ▼ button.
 3. After correcting the data in **Step 2**, press the **ENTER** button to enter.
- If you press the **MENU** button in **Step 5**, the data will not be stored.
- If a button is not pressed within 3 minutes during the setting procedure, the screen will return to the normal screen.

VCR Setup

Manual Clock Setting

Preparation

- Turn on your TV and select the video channel. (See **setting the 3 ↔ 4 Output Channel**.)
- Press the **VCR ON/OFF** button (VCR POWER indicator will light up) and then press the **TV/VCR** button to select "VCR".
(VCR indicator will light up.)

1. Press the **MENU** button. Select "CLOCK" with the cursor ▲ or ▼ button and then press the **ENTER** button.

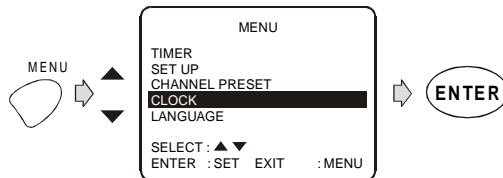

2. Select "MANUAL" with the cursor ▲ or ▼ button and then press the **ENTER** button.

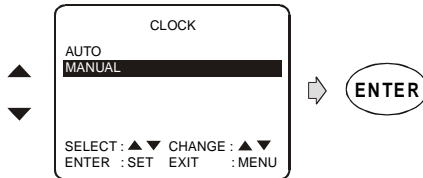

3. Select "TIME" with the cursor ◀ or ▶ button and set time by holding the cursor ▲ or ▼ button.

EX.: 10:28 AM

Numbered buttons can be used instead of cursor ▲ or ▼ button to set time and date. Press the **AM/PM (+10)** to select AM or PM during time setting.

4. Select and set "DATE", "YEAR" and " DST" in turn, in the same manner as in **Step 3**.

(See **Automatic Daylight Saving-Time (D.S.T.) Adjustment**)

EX.: Jul.4, 2002, DST: ON

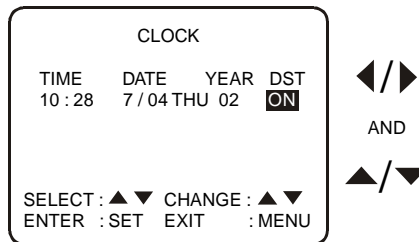

5. If the data is correct, press the **ENTER** button to enter.

The screen returns to normal.



Notes:

- In **Step 1**, if you press the **MENU** button when operating the screen setting for the first time or after the power is interrupted for more than 5 seconds, the LANGUAGE screen will appear.
- If you entered incorrect data during the setting procedure, re-enter the correct data in the following manner:
 1. Use the cursor ◀ or ▶ button to select the data to be corrected.
 2. Set the correct data with the cursor ▲ or ▼ button.
 3. After correcting the data in **Step 2**, press the **ENTER** button to enter.
- If you press the **MENU** button to exit the CLOCK screen in **Step 5**, the data will not be stored.
- If a button is not pressed within 3 minutes during the setting procedure, the screen will return to the normal screen.

VCR Setup

Automatic Daylight Saving-Time (D.S.T.) Adjustment

This VCR is equipped with an internal Automatic Daylight Saving-Time Adjustment function. In spring (first Sunday in April) and autumn (last Sunday in October), the time is adjusted as shown below. This function has been preset to ON at the factory. Set the D.S.T. mode in the clock setting screen.

Note:

- If the timer recording programme is affected by the D.S.T. time change, check your TV listing and find out when it reflects the time change. Some TV listings will indicate the time change in the same manner as is programmed in this VCR, but others do not show the time change until the next morning. In that case, when programming a timer, use the CLOCK screen to set the D.S.T. mode to OFF so the time change will not be carried out.

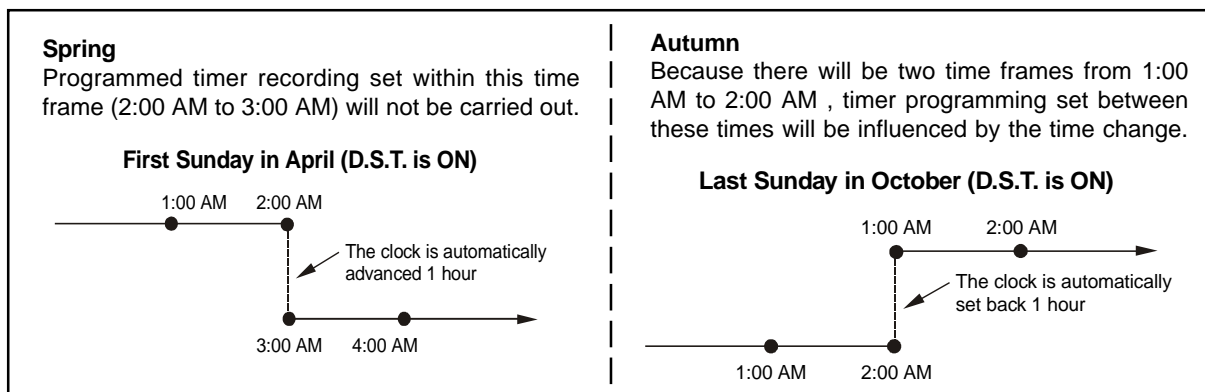

Language

When you use the VCR for the first time or the power is interrupted for more than 5 seconds (power failure, etc.), you should set the language to be used for the MENU screen.

Preparation

- Turn on your TV and select the video channel.
(See **Setting the 3 ↔ 4 Output Channel.**)
- Press the **VCR ON/OFF** button (VCR POWER indicator will light up) and then **TV/VCR** to select "VCR". (VCR indicator will light up.)

1. Press the **MENU** button.
LANGUAGE screen will appear.
2. Select the language with the cursor **▲** or **▼** button.
EX.: ENGLISH
3. Press the **ENTER** button to enter. To return to the normal screen, press the **MENU** button.

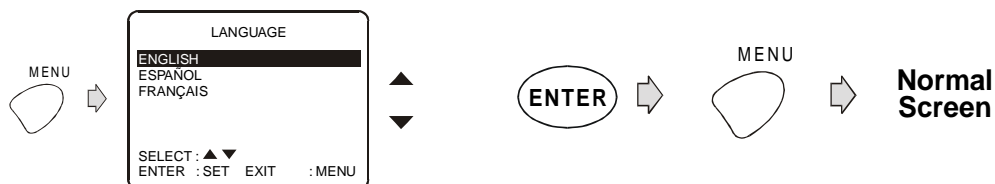

Note:

- If you press the **MENU** button to exit the LANGUAGE screen in **Step 3**. The data will not be stored.

VCR Playback

Inserting a Video Cassette

Gently insert the video cassette into the cassette compartment. The VCR turns on automatically and VCR POWER indicator light up. If the cassette is inserted incorrectly, the loading system will not function. Do not force the cassette into the VCR.

To remove the cassette, press the **TAPE EJECT** button during stop mode.

Playback

Preparation

Turn on the TV and select the video channel. (See **Setting the 3 ↔ 4 Output Channel.**)

1. When the unit is powered ON and set to VCR mode by pressing the **FUNCTION** button.
2. Press the **VCR ON/OFF** button to turn on the VCR. The VCR POWER indicator lights up.
3. Insert a cassette.
4. Press the **PLAY ►** button. (The automatic tracking control system engages and "PLAY" flashes on the TV screen for a few seconds. See **Automatic Tracking control System.**) VCR indicator will light up.
5. To stop playback, press the **STOP ■** button on the unit or the **VCR STOP** button on the remote. (If the tape reaches its end, the VCR will automatically rewinds the tape to the beginning, turn its power off and ejects the tape.)

Notes:

- If noise should remain on the TV screen after tracking adjustment has been completed by the Automatic Tracking Control System, use the manual tracking mode.
- Press the **CH +/-** buttons during playback mode to change to manual tracking mode. Adjust the tracking using the **CH +/-** buttons until the noise is minimized or eliminated.
- For tapes recorded in EP on another VCR that still have vertical jitter even after manual adjustment, hold down the **PLAY ►** button for about 2 seconds. (On screen display may be blurred.) Ejecting the tape or turning off the power will return playback to its normal mode.

Fast Forward and Rewind

1. When the VCR is in stop mode, press the **►► TUNING** or **TUNING ◄◄** button to fast forward or rewind the cassette. (The picture cannot be viewed in this mode.)
2. Press the **STOP ■** button on the unit or the **VCR STOP** button on the remote to halt fast forward or rewind.

Notes:

- The **►► TUNING** and **TUNING ◄◄** buttons speeds may be slower for cassette tapes other than T-60, T-90 or T-120.
- After rewinding the T-120 cassette tape for about 2 minutes, you can fast forward the cassette tape.





Video Search

Use the following procedure to quickly find the section you want, while viewing the picture.





1. During playback, press the **TUNING ►►** button for forward video search or the **TUNING ◄◄** button for reverse video search.
There are 2 search speeds in each direction. The VCR switches between them each time the button is pressed.
2. Press the **PLAY ►** button to resume normal playback.

VCR Playback

Slow Motion Playback

1. Press the **SLOW**  button during playback.
2. Press the **SLOW**  button to vary the slow motion playback speed between 1/5 and 1/30 of the normal playback speed.
If noise bars appear on the screen, use the **CH +/-** buttons.
If the picture experiences vertical jitter during the slow mode, set your VCR to the STILL mode and press the **CH +/-** buttons to stabilize the picture. Then press the **SLOW**  button again.
3. Press the **PLAY**  button to resume normal playback.

Still Picture and Frame Advance

1. Press the **PAUSE**  button during playback. This will freeze the picture on your TV.
2. If the picture vibrates vertically during still mode, use the **CH +/-** buttons to adjust for minimum distortion. If noise bars appear on the screen during still mode, set your VCR to the slow mode and press the **CH +/-** buttons to make the noise disappear. Then press the **PAUSE**  button again.
3. Press the **PAUSE**  button during still mode for frame advance.
4. Press the **PLAY**  button again to resume normal playback.

Note:

- Sound is muted during still picture, video search, frame advance and variable slow motion.

Automatic Tracking Control System

This function automatically adjusts the tracking to match the recorded tape. Auto tracking engages in the following cases:

- When you insert the cassette and begin playback.
 - When you press the **CH +/-** buttons at the same time.
 - When the VCR has been playing back an unrecorded section of tape, and then reaches a recorded tape segment.
- When auto tracking engages, "PLAY" on the TV screen flashes for a few seconds.

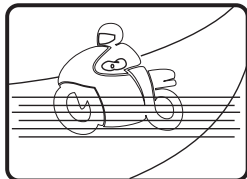

Poor Tracking

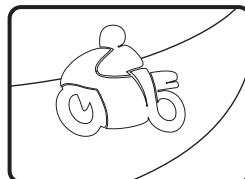

Normal Picture

Manual Tracking Control

When a poorly recorded tape is playback or the VCR is near an electrical or magnetic field, auto tracking may not operate normally. In this event, manually adjust the tracking with the **CH +/-** buttons to make any noise disappear.

Blue Screen Noise Elimination

Set the BLUE SCREEN mode to ON on the **SETUP** button selection screen. (See **Mode Selection**.) This function eliminates monitor noise and mutes sound during playback of unrecorded portions of a tape and when receiving a non-broadcasting channel. Blue Screen will also appear if the VCR is set to the Auxiliary mode but no video signal is fed to the VCR. (The BLUE SCREEN mode is set to ON at the factory.)

Notes:

- Blue Screen does not function during still picture, variable slow motion and video search.
- Blue Screen may not function properly if the broadcast signal is too strong or too weak.
- Blue Screen does not function during playback of a tape with noise recorded.
- If the antenna signal is weak while recording a TV programme or if the input signal is weak while tape dubbing, the monitor screen may turn blue since the unit may not recognize whether or not a proper signal is being received. In this event, set the BLUE SCREEN mode to OFF.

VCR Playback

Quick Start with Full Loading Mechanism

Your VCR has a standby function (Full Loading Mechanism) to allow immediate recording and playback.

After pressing the **REC** or **PLAY** ► button, it takes about 2 seconds until recording or playback is engaged when in the standby mode.

Full Automatic Playback

The Full Automatic Playback lets you enjoy playback with ease. When you insert a cassette with the erasure protection tab removed, your VCR automatically turns on the power and playback the tape. When the tape reaches its end, the VCR automatically rewinds the tape, turns its power off and ejects the tape.

Note:

- If the erasure protection hole is covered, press the **PLAY** ► button after the power turns on automatically.

Audio Output Mode

Your VCR has 3 channels for audio recording (2 on the Hi-Fi track and 1 on the linear track). You can select the audio output channels in playback mode on the SET UP selection screen. The following shows which audio channels will be heard when a stereo Hi-Fi video cassette is playback while a stereo system is properly connected to the VCR. (See **Mode Selection**.)

Hi-Fi L + R mode: LR

Normally, select Hi-Fi L + R mode on the SET UP selection screen: both the left (L) and right (R) audio channels will be taken from the Hi-Fi audio track.

Normally you will not have to change to another mode.

(See **Recording MTS (Multi-channel TV Sound) Broadcasts**.)

Hi-Fi L mode: L

The left channel of the Hi-Fi audio track will be playback through both speakers.

Hi-Fi R mode: R

The right channel of the Hi-Fi audio track will be playback through both speakers.

Linear mode: MONO

The audio signal recorded on the linear audio track will be playback through both speakers.

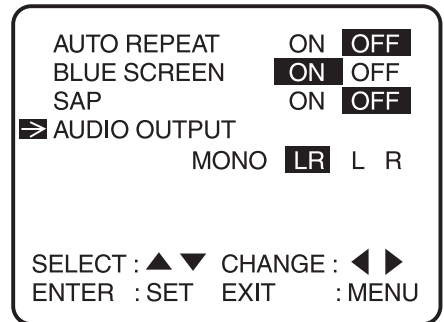

Note:

- When video cassettes recorded on a non-Hi-Fi VCR are playback or the Hi-Fi audio output level is poor, the audio signal recorded on the linear audio track will automatically be playback regardless of the audio output mode.

VCR Recording

IMPORTANT

This Unit does NOT allow copying from DVD to VCR tape

Recording a TV Programme

Preparation

- Turn on the TV and select the video channel. (See **Setting the 3 ↔ 4 Output Channel.**)
- Press the **VCR ON/OFF** button (VCR POWER indicator will light up) and then **TV/VCR** to select “VCR” (VCR indicator will light up).
- If necessary, set “SAP” on the SETUP selection screen. (See **Mode Selection.**)

Without a Cable Box or Digital Satellite Receiver

1. Insert the cassette, with the erasure protection tab covered. (See **Cassette Erase Protection** below)
2. Press the **SP•EP** button on the remote control to set the recording speed (SP or EP). (See **Recording Speeds.**)
3. Select the desired channel with the **CH +/-** buttons or the numbered buttons on the remote control.
4. Press the **REC** button. The REC indicator lights up (If the erasure protection tab has been removed, the cassette will be ejected.)
5. To stop recording, press the **STOP ■** button. The REC indicator will turn off.
- To pause recording during the REC mode, press the **PAUSE II** button on the remote control (The REC indicator will flash). To resume recording, press the **PAUSE II** or **REC** button and at the same time REC indicator will turn on. (Pause disengages automatically after about 5 minutes to avoid damage to the tape and the VCR and stop mode is engaged.)

With a Cable Box or Digital Satellite Receiver

1. Insert the cassette, with the erasure protection tab covered. (See **Cassette Erase Protection** below.)
2. Press the **SP•EP** button on the remote control to set the recording speed (SP or EP). (See **Recording Speeds.**)
3. Set the TV and VCR channels to output CH of cable box or digital satellite receiver.
4. Set the cable box or digital satellite receiver to the desired channel to record.
5. Press the **REC** button. The REC indicator lights up (If the erasure protection tab has been removed, the cassette will be ejected).
6. To stop recording, press the **VCR STOP ■** button. The REC indicator will turn off.

Notes:

- You will be unable to watch a scrambled channel while recording.
- It is not necessary to set the clock to use this recording operation.
- “PAUSE” will flash on the TV screen if the **PAUSE II** button is pressed in stop mode. Press the **VCR STOP ■** button to disengage the pause mode or press the **REC** button to enter the record standby mode at the same time REC indicator will flash, then press the **REC** or **PAUSE II** button again to enter record. (The REC indicator will light up.)
- The VCR can record a TV programme even with the TV turned off.

To Watch Another TV Programme While Recording

While recording, press the **TV/VCR** button to select “TV” (the VCR indicator will turn off to indicate TV mode), then select the programme you wish to view using the TV tuner.

At the end of the tape, your VCR will automatically stop recording, rewinds the tape, turns its power off and ejects the tape.

Cassette Erase Protection

A **VHS** cassette has a removable tab to prevent accidental erasure of recorded material. Removing the tab prevents recording. To record on a video cassette with the tab removed, place adhesive tape over the tab opening.

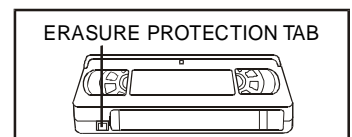

To Record TV or AV-in While DVD Playback

If user wants to record TV or AV-in signal and enjoy DVD at the same time, user must set to the required TV or AV-in and activate the record the function. After recording starts, it is ok to switch to DVD mode to enjoy the DVD.

VCR Recording

Recording Speeds

This VCR lets you select a recording speed (SP or EP), SP provides a better picture, although the recording time is shorter. Select the tape speed that best suits your needs.

MODE \ CASSETTE	SP (Standard Play)	EP (Extended Play)
T-60	1 hr.	3 hrs.
T-120	2 hrs.	6 hrs.
T-160	2 hrs. & 40 min.	8 hrs.

Note:

- This VCR can playback tapes recorded in LP (Long Play) mode.

Recording Hi-Fi Stereo Sound

Your VCR records AUDIO signals on two types of audio tracks.

Hi-Fi:

Using specialized rotary heads, audio signals are recorded on the video track in FM format. Multi-sound broadcasts (Stereo or SAP [Separate Audio Programme]) are recorded on two channels.

Linear:

All audio signals are recorded in mono on the linear audio track.

Notes:

- Video cassettes recorded on a non Hi-Fi VCR can also be playback. However, if the audio signals are recorded on two linear channels, stereo programmes will be playback in monaural and SAP (Separate Audio Programme) will be playback with both the MAIN and SAP audio mixed together.
- Video cassettes recorded on this VCR can be playback on a non-Hi-Fi VCR. However, only the linear track will be playback.

Recording MTS (Multi-channel TV Sound) Broadcasts

Your VCR can record stereo or SAP (Separate Audio Programme) broadcasts, where available.

If the broadcast is in stereo, the VCR automatically records the stereo sound in dynamic Hi-Fi. If the broadcast is in SAP, you can record both the MAIN and the SAP sound by using the **ENTER** button selection screen to set the SAP mode to ON. If the broadcast is in stereo/SAP, you can record either the SAP sound by using the **ENTER** button selection screen to set the SAP mode to ON, or stereo sound by setting the SAP mode to OFF. (See **Mode Selection**.)

On the TV screen

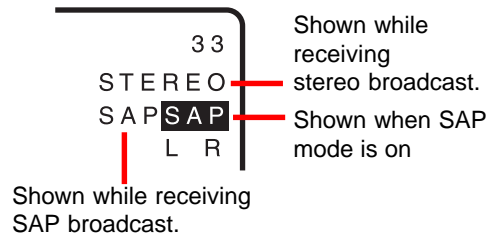

MTS/SAP Recording

The monitor output listed in the table shows that the audio output mode is in the Hi-Fi **L + R** mode.

Broadcast Received	SAP Mode Position	*Monitor Output		Recording		
		L. Speaker	R. Speaker	Hi-Fi L. CH	Hi-Fi R. CH	Linear Track
Stereo	OFF	L	R	L	R	L + R
	ON	L	R	L	R	L + R
SAP	OFF	MAIN	MAIN	MAIN	MAIN	MAIN
	ON	MAIN	SAP	MAIN	SAP	SAP
Stereo/SAP	OFF	L	R	L	R	L + R
	ON	L + R	SAP	L + R	SAP	SAP

VCR Recording

Monitor Output When Receiving a SAP Broadcast

When receiving a SAP broadcast, if the SAP position is set to ON, change the audio output mode to select Monitor Output (MAIN or SAP) with the **ENTER** button selection screen.
(See **Mode Selection**.)

When enjoying a TV programme with MAIN sound

Select L on the **ENTER** button selection screen.
(See **Audio Output Mode**.)

When enjoying a TV programme with SAP sound

Select R or MONO on the **ENTER** button selection screen.
(See **Audio Output Mode**.)

Tape Dubbing Connection Instructions

Your VCR can dub (copy) video material from another video device. It can also output video and audio signals for recording on other video or audio equipment. Audio/Video dubbing cannot be done separately.

1. Switch your VCR to the auxiliary input by pressing the **INPUT** button on the remote control. (You can also use the **CHANNEL ▲/▼** buttons on the unit or the **CH +/-** buttons on the remote control.)
2. Begin recording on the dubbing VCR and playback on the source VCR simultaneously.

Notes:

- When using special playback functions (still picture, video search, frame advance and variable slow motion) during dubbing, a blue screen may appear.
Set BLUE SCREEN mode on the dubbing VCR (for recording) to OFF. (See **Mode Selection**.)
- To use the TV as a monitor while dubbing, press the **TV/VCR** button to “VCR” on the dubbing VCR.
- Use an RCA pin-type connection cable (not supplied with VCR, but supplied with VIEWCAM) to connect source VCR to dubbing VCR.
- Refer to the manual of the VCR connected to this unit when dubbing a tape.
- If source VCR is a monaural mode, connect the audio cable to “AUDIO-L” of the dubbing VCR.

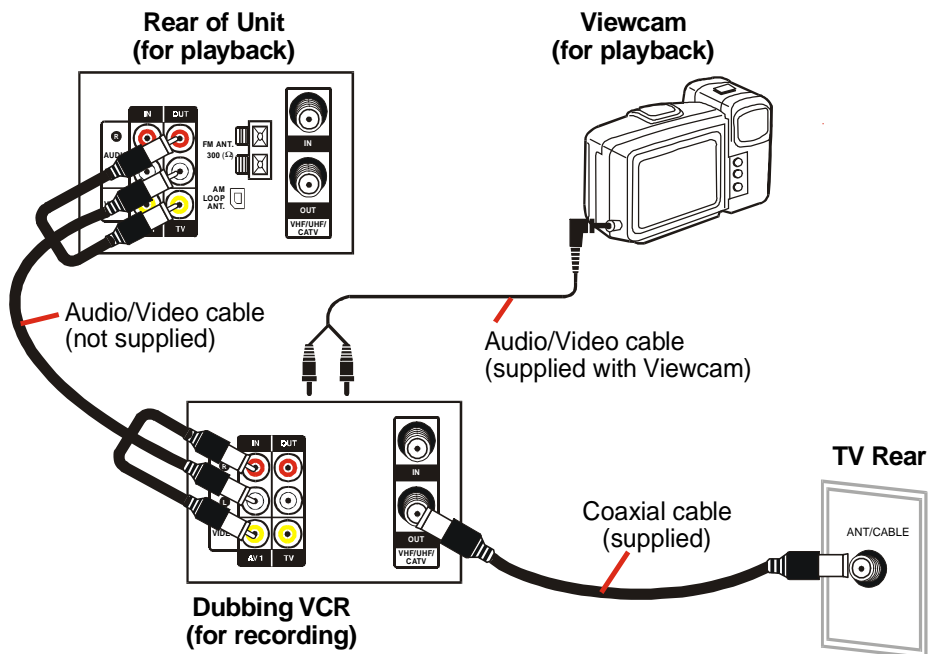

VCR Recording

Simple Recording Timer

The Simple Recording Timer (SRT) enables you to set the recording stop time. The SRT can be set on the TV screen by using the remote control.

The SRT cannot be set if the clock has not been set. Make sure the clock is set before setting the SRT.

Preparation

- Turn on the TV and select the video channel. (See **Setting the 3 ↔ 4 Output Channel.**)
- Insert a cassette with the erasure protection tab opening covered. Power will turn on automatically (VCR POWER indicator will light up).
- Press the **TV/VCR** button to select "VCR" (VCR indicator will light up).
- If necessary, set "SAP" on the **ENTER** button selection. (See **Mode Selection.**)

Procedures

Example:

Recording a TV programme in the SP mode. The programme is on Channel 2, ending at 9:50 AM. The present time is 8:43 AM.

1. Select the desired channel with the numbered buttons or **CH +/-** buttons. *EX.: Channel → 02*
2. Set the recording speed (SP or EP) with the **SP•EP** button on the remote control. *EX.: SP*
3. Press the **REC** button to enter the recording mode (REC indicator will light up).
Then, press the **REC** button again to enter the simple recording timer mode (TIMER indicator will light up). The recording stop time is displayed. *EX.: 8:50 AM*
4. Each press of **REC** button increases the stop time by 10 minutes.

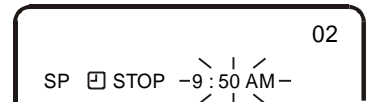
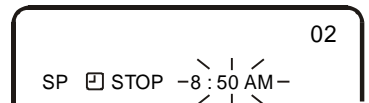

Note:

- The recording stop time will flash for a few seconds before the stop time is fixed.
- 5. When the stop time comes, recording is finished and the power turns off.

Changing the Contents of the Simple Recording Timer

1. Press the **REC** button. The stop time flashes on the TV screen.
2. Change the stop time as desired using the **REC** button.

Cancelling the Simple Recording Timer

1. Press the **VCR STOP** button.

Notes:

- **The Simple Recording Timer has priority over other recordings.**
- Ordinary timer programmes will not be recorded when portions of the time setting of the simple recording timer and of the time setting of the ordinary timer recording overlap.

Example:

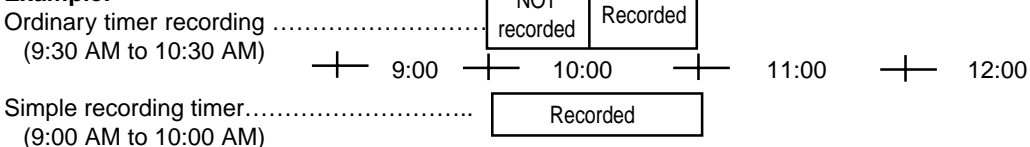

VCR Recording

Recording with the Timer

Preparation

- Turn on the TV and select the video channel.
- Insert a cassette with the erasure protection tab opening covered. Power will turn on automatically (POWER indicator will light up).
- Press the **TV/VCR** button to select "VCR" (VCR indicator will light up).
- Check that the clock is displaying the correct time.
- If necessary, set "SAP" on the **ENTER** button selection screen. (See **Mode Selection**.)

Procedures

Example:

Recording a TV programme in the SP mode: the TV programme is on channel 7 starting at 9:05 PM and stopping at 10:35 PM on August 10th. The present time is 6:35 PM on February 18th.

1. Press the **MEMORY** button. The Timer screen will appear and then press the **ENTER** button.

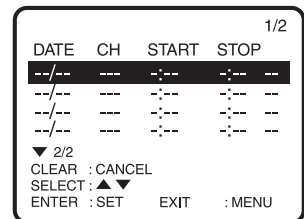

2. Select the desired month/day (DATE) with the cursor ▲ or ▼ button and then press the ► button. The cursor will move to the next column.

EX: February 18th

- If you want to record every day or week at the same time, hold the cursor ▼ button when you select the date.

When pressing: The recording date changes in this sequence:

- ▼ 8/10 → MO-FR → MO-SA → DAILY → SAT...SUN → 8/9 → 8/8...
(next year)
- ▲ 8/10 → 8/11 → 8/12.....8/8 → 8/9 → SUN.....SAT.....
(present)(tomorrow) (next year)

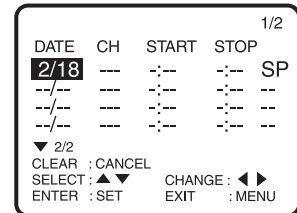

3. Select the desired channel with the cursor ▲ or ▼ button and then press the ► button.

EX: Channel 07

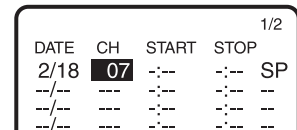

4. Set the recording start time (hour digits and minute digits) with the cursor ▲ or ▼ button and then press the cursor ► button.

EX.: 9:05 PM

Press the **AM/PM** button to select AM or PM.



5. Set the recording stop time with the cursor ▲ or ▼ button and then press the cursor ► button.

EX.: 10:35 PM



6. Select the tape speed with the cursor ▲ or ▼ button.

EX.: SP

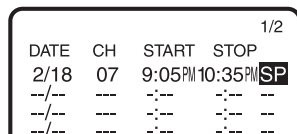

VCR Recording

7. Press the **ENTER** button.

- To programme the additional timer settings, press the **ENTER** button and repeat steps 2-7.

				1/2
DATE	CH	START	STOP	
2/18	07	9:05PM	10:35PM	SP
--/--	---	-:-	-:-	--
--/--	---	-:-	-:-	--
--/--	---	-:-	-:-	--

8. Press the **MENU** button to finish settings.

The display shown to the left appears on the screen for 5 seconds, after which the normal screen returns.

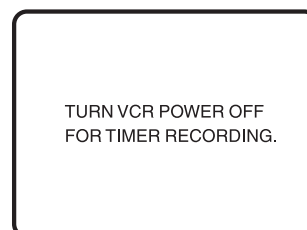

9. Press the **VCR ON/OFF** button to enter the timer standby mode. Be sure that the **TIMER** indicator lights up.

If users re-power the Unit and watching DVD:

- If connection from DVD to TV is through video-signal (yellow cable), they should press the **VCR ON/OFF** button again to turn off VCR. Be sure that the **TIMER** indicator lights up; otherwise, the timer recording is not possible.
- If connection from DVD to TV is through coaxial cable, they cannot turn off VCR, so the timer recording is not possible.

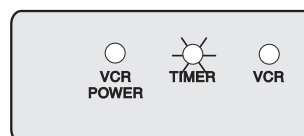

Notes:

- If the power is interrupted for more than 5 seconds (power failure, etc.) during timer recording, the Auto Clock Setting will reset the time after the power is returned (the **VCR POWER** indicator will flash) but the timer settings will be cancelled.
- Numbered buttons can be used instead of the cursor **▲** or **▼** button to set the data.
- If the cassette ends before recording all the programmes, the VCR will stop, turns its power off and ejects the tape automatically.
- In **Step 9**, if the **VCR ON/OFF** button is pressed with no cassette inserted, the **TIMER** indicator flashes for 5 seconds indication that timer recording is not possible.
- In **Step 9**, if the inserted cassette is without the erasure protection tab, **TIMER** indicator flashes and the cassette is ejected.
- To stop timer recording, press the **VCR STOP** **■** button.
- If a button is not pressed within 3 minutes during the setting procedure, the screen will return to the normal screen.
- There are two timer setting screens (1/2, 2/2).

VCR Recording

Confirming Timer Programmes

You can see on the Timer setting screen a list of all timer programmes that are already set.

Preparation

- Turn on the TV and select the video channel.
- Press the **VCR ON/OFF** button (VCR POWER indicator will light up) and then press the **TV/VCR** button to select "VCR" (VCR indicator will light up).

1. Press the **MEMORY** button. TIMER screen will appear.
 - Check the information displayed.
2. If you want to correct the data, select the data to be changed with the cursor ▲ or ▼ button and then press the **ENTER** button. Correct the data as desired using the cursor ▲, ▼, ◀ or ▶ button. Then Press the **ENTER** button. See 2/2 screen also.

DATE	CH	START	STOP	1/2
2/25	25	10:05 PM	10:35 PM	EP
2/18	07	9:05 PM	10:35 PM	SP
DAILY	88	10:05 PM	10:30 PM	EP
--/--	---	-:--	-:--	--
▼ 2/2				
CLEAR : CANCEL				
SELECT : ▲▼				
ENTER : SET EXIT : MENU				

3. Pressing the **MENU** button will clear the screen. The display shown to the left appears for 5 seconds, after which the normal screen returns.
 - After checking or correcting the programme contents, press the **VCR ON/OFF** button to enter, the Timer Standby mode. (At the same time, TIMER indicator will light up.)

TURN VCR POWER OFF
FOR TIMER RECORDING.

Cancelling Timer Programmes

Perform the following procedure to cancel timer programmes that have already been set.

Preparation

- Turn on the TV and select the video channel.
- Press the **VCR ON/OFF** button (VCR POWER indicator will light up) and then press the **TV/VCR** button to select "VCR" (VCR indicator will light up).

1. Press the **MEMORY** button. TIMER screen will appear.
 - Select the programme you wish to cancel with the cursor ▲ or ▼ button.
2. Double-check that it is the programme you wish to cancel and press the **CLEAR** button. It will be cleared on the screen.
3. Pressing the **MENU** button will clear the screen. The display shown to the left appears for 5 seconds, after which the normal screen returns.
 - If there are still some programmes set, press the **VCR ON/OFF** button to enter the Timer Standby mode. (At the same time, TIMER indicator will light up.)
 - If you press the **MENU** button when all of the timer programmes are cancelled, the screen will return to normal.

DATE	CH	START	STOP	1/2
2/25	25	10:05 PM	10:35 PM	EP
2/18	07	9:05 PM	10:35 PM	SP
DAILY	88	10:05 PM	10:30 PM	EP
--/--	---	-:--	-:--	--
▼ 2/2				
CLEAR : CANCEL				
SELECT : ▲▼				
ENTER : SET EXIT : MENU				

DATE	CH	START	STOP	1/2
--/--	---	-:--	-:--	--
2/18	07	9:05 PM	10:35 PM	SP
DAILY	88	10:05 PM	10:30 PM	EP
--/--	---	-:--	-:--	--
▼ 2/2				
CLEAR : CANCEL				
SELECT : ▲▼				
ENTER : SET EXIT : MENU				

TURN VCR POWER OFF
FOR TIMER RECORDING.

Special Functions

Auto Enhance

1. Press the **DISPLAY** button twice. "AUTO ENHANCE ON (or OFF)" will appear on the TV screen for a few second.
2. Press the **SET** button on the unit. Each time the button is pressed, the mode switches between ON and OFF. (The AUTO ENHANCE is preset to ON at the factory.)

ON:
Normally leave the mode set to ON. This high picture quality function will create a clearer image during playback.

OFF:
Set to OFF when playing back a tape on the VCR while editing or when strong noise appears on the screen.

Recorded Section Auto Repeat

Set the AUTO REPEAT mode to ON on the SET UP selection screen. (See **Mode Selection**.) If the recorded portion has finished and a non-recorded portion has continued for 15 seconds, the tape will automatically stop, rewind to the beginning and repeat playback. (The AUTO REPEAT mode is preset to OFF at the factory).

Notes:

- The ON/OFF status of the Recorded Section Auto Repeat can be checked when the **DISPLAY** button is pressed to display OSD. (The "↻" mark lights when the Recorded Section Auto Repeat is on.)
- If the Recorded Section Auto Repeat is on and the tape is rewinded to the beginning with rewind or reverse video search, the tape will automatically start playback.

Skip Search

With this feature, you can set a forward video search time to approx. 30, 50, 90 or 120 seconds of recorded material. After searching, normal playback will resume automatically.

- Press the **NEXT ►►** button on the remote control during playback (ex. during commercials).

Number of Times Pressed	1 Time	2 Times	3 Times	4 Times
Video Search Time	Approx. 30 sec.	Approx. 60 sec.	Approx. 90 sec.	Approx. 120 sec.

Instant Replay

With this feature, you can set a reverse video search time to approx. 20, 40, 60 or 80 seconds of recorded material. After searching, normal playback will resume automatically.

- Press the **PREV ◄◄** button on the remote control during playback (ex. during commercials).

Number of Times Pressed	1 Time	2 Times	3 Times	4 Times
Video Search Time	Approx. 20 sec.	Approx. 40 sec.	Approx. 60 sec.	Approx. 80 sec.

Radio Operation

Tuning into a station manually

1. Press the **FUNCTION** button until the frequency band appears on the display.
2. Press the **BAND** button on the remote or **STOP** button on the front panel to select the desired band.
3. Press the **◀◀TUNING▶▶** button to tune in the desired station.

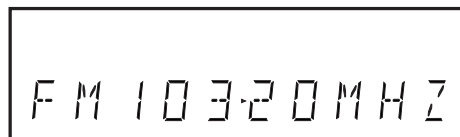

FM Stereo

- Press the **FM MODE** button on the remote until "STEREO" appears on the display.



Weak FM stations

- Press the **FM MODE** button on the remote until the "MONO" word appears on the display. Background noise will be reduced but the signal reproduced will be mono. To restore stereo reception, press the **FM MODE** button on the remote to select STEREO.



Note:

- The left / right front speakers and subwoofer are activated only.

To search for a station automatically

- Hold down the **◀◀TUNING▶▶** buttons on the remote or **◀◀REW** and **F.FWD▶▶** buttons on the front panel for 1 to 2 seconds, and a station is searched for automatically. After tuning in a station, the search stops.
- The search may not stop at a station with a very weak signal.

Presetting stations

You can tune into a stored station directly by entering the preset number.

20 stations on FM band can be preset.

20 stations on AM band can be preset.

1. Press the **FUNCTION** button until the frequency band appears on the display.
2. Press the **BAND** button on the remote to select the desired band.
3. Use the **◀◀TUNING▶▶** button to find your desired station.
4. Press the **MEMORY** button on the remote.
5. Press the **▶▶I NEXT** or **PREV I◀◀** button to select the preset number and press the **MEMORY** button on the remote to store the station.
6. Repeat steps 2-5 to store other stations.

Tuning into a preset station

1. Press the **FUNCTION** button on the front panel until the frequency band appears on the display.
2. Press the **BAND** button on the remote to select the desired band.
- Press the **▶ PLAY** button and **▶▶I NEXT** or **PREV I◀◀** button to select the presetted station or use the numbered buttons to enter the number to select the presetted station.

Example: To select preset number 15, press the +10 and 5 buttons.

To select preset number 10, press the +10 and 0 buttons.

Language Code List for Disc Language

Code	Language Name	Code	Language Name	Code	Language Name	Code	Language Name
AA	Afar	FY	Frisian	MG	Malagasy	SL	Slovenian
AB	Abkhazian	GA	Irish	MI	Maori	SM	Samoan
AF	Afrikaans	GB	Scots Gaelic	MK	Macedonian	SN	Shona
AM	Ameharic	GL	Galician	ML	Malayalam	SO	Somali
AR	Arabic	GN	Guarani	MN	Mongolian	SQ	Albanian
AS	Assamese	GU	Gujarati	MO	Moldavian	SR	Serbian
AY	Aymara	HA	Hausa	MR	Marathi	SS	Siswat
AZ	Azerbaijani	HI	Hindi	MS	Malay	ST	Sesotho
BA	Bashkir	HR	Croatian	MT	Maltese	SU	Sundanese
BE	Byelorussian	HU	Hungarian	MY	Burmese	SV	Swedish
BG	Bulgarian	HY	Armenian	NA	Nauru	SW	Swahili
BH	Bihari	IA	Interlingua	NE	Nepali	TA	Tamil
BI	Bislama	IE	Interlingue	NL	Dutch	TE	Telugu
BN	Bengali	IK	Inupiak	NO	Norwegian	TG	Tajik
	Bangla	IN	Indonesian	OC	Occitan	TH	Thai
BO	Tibetan	IS	Icelandic	OM	(Afan) Oromo	TI	Tigrinya
BR	Breton	IT	Italian	OR	Oriya	TK	Turkmen
CA	Catalan	IW	Hebrew	PA	Panjabi	TL	Tagalog
CO	Corsican	JA	Japanese	PL	Polish	TN	Setswana
CS	Czech	JI	Yiddish	PS	Pashto, Pushto	TO	Tonga
CY	Welsh	JW	Javanese	PT	Portuguese	TR	Turish
DA	Danish	KA	Georgian	QU	Quechua	TS	Tsonga
DE	German	KK	Kazakh	RM	Rhaeto- Romance	TT	Tatar
DZ	Bhutani	KL	Greenlandic			TW	Twi
EL	Greek	KM	Cambodian	RN	Kirundi	UK	Ukrainian
EN	English	KN	Kannada	RO	Romanian	UR	Urdu
EO	Esperanto	KO	Korean	RU	Russian	UZ	Uzbek
ES	Spanish	KS	Kashmiri	RW	Kinyarwanda	VI	Vietnamese
ET	Estonian	KU	Kurdish	SA	Sanskrit	VO	Volapük
EU	Basque	KY	Kirghiz	SD	Sindhi	WO	Wolof
FA	Persian	LA	Latin	SG	Sangho	XH	Xhosa
FI	Finnish	LN	Lingala	SH	Serbo- Croatian	YO	Yoruba
FJ	Fiji	LO	Laothian			ZH	Chinese
FO	Faroese	LT	Lithuanian	SI	Singhalese	ZU	Zulu
FR	French	LV	Latvian, Lettish	SK	Slovak		

Maintenance

Cleaning Disc

A defective or soiled disc inserted into the Unit can cause sound to drop out during playback.

Handle the disc by holding its inner and outer edges.

- Do NOT touch the surface of the unlabeled side of the disc.
- Do NOT stick paper or tape on the surface.
- Do NOT expose the disc to direct sunlight or excessive heat.
- Clean the disc before playback. Wipe the disc from the center outward with a cleaning cloth.
- NEVER use solvents such as benzine or alcohol to clean the disc.
- Do NOT use irregular shape discs (example : heart shaped, octagonal, etc.). They may cause malfunctions.

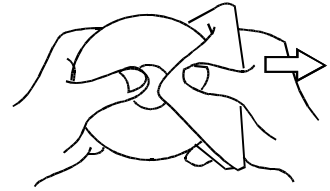

Cleaning the Unit

- Be sure to turn the Unit off and disconnect the AC power cord before maintaining the Unit.
- Wipe the Unit with a dry soft cloth.
If the surfaces are extremely dirty, wipe clean with a cloth which has been dipped in a weak soap-and-water solution and wrung out thoroughly, then wipe with a dry cloth.
- Never use alcohol, benzine, thinner, cleaning fluid or other chemicals. Do NOT use compressed air to remove dust.

Important Note

Before transporting the Unit, remove disc from the CD tray.

Trouble Shooting Guide

SYMPTOM

CAUSE (AND REMEDY)

DVD

- | | |
|---------------------------|--|
| No power. | <ul style="list-style-type: none">• Check that the AC power cord is connected. |
| No picture. | <ul style="list-style-type: none">• The region number of the disc doesn't match the region number of this Unit.
• The TV is not set to receive DVD signal output.• The video cable is not connected.• The TV is not turned on. |
| The picture is not clear. | <ul style="list-style-type: none">• Clean the disc.• If video from your system has to go through your VCR to get to your TV, the copy-protection applied to some DVD programs could affect picture quality. If you still experience problems after checking your connections, please try connecting your Unit directly to your TV.• The disc is scratched. |

Trouble Shooting Guide

SYMPTOM

CAUSE (AND REMEDY)

No sound or only a very low-level sound is heard.	<ul style="list-style-type: none">• The location and orientation of the antenna are incorrect. If you use an indoor antenna, change to an outdoor antenna.• The TV antenna wire is too close to the Unit. Separate the antenna wire of the TV set from the Unit.• Check that the speakers and equipment are connected securely.• Make sure that you've selected the correct equipment on the system.• The system is in pause mode or in Slow-motion Play mode. Press the ► PLAY button to return to normal play mode.• Fast forward or fast reverse is performed. Press the ► PLAY button to return to normal play mode.• Check the speaker settings.• Make sure that AUDIO output and AV IN input connections are correct.• Adjust the speakers volume.• The DTS DVD disc cannot be decoded to have speaker output.• This Unit is too hot, shut off the Unit for 30 minutes to cool down.• You can use Pink Noise setting to test the speaker come out (Please see Customizing the Function Settings)
Severe hum or noise is heard.	<ul style="list-style-type: none">• Check that the speakers and equipment are connected securely.• Check that the connecting cords are away from a transformer or motor, and at least 10 feet (3 meters) away from a TV set or fluorescent light.• Move your TV away from the audio equipment.• The plugs and jacks are dirty. Wipe them with a cloth slightly moistened with alcohol.• Clean the disc.• Vibrations from the speakers are affecting the Unit.
The remote does not function.	<ul style="list-style-type: none">• Remove any obstacles between the remote and the Unit.• Use the remote near the Unit.• Point the remote at the remote sensor on the Unit.• Replace all the batteries in the remote with new ones.
The disc does not play.	<ul style="list-style-type: none">• There is no disc inside ("No Disc" appears on the TV screen).• Insert the disc correctly with the playback side facing down on the disc tray.• Clean the disc.• A non-NTSC disc has been inserted. The Unit and disc region number are incompatible.• Condensation may have formed inside the Unit due to a sudden change in temperature. Wait about an hour for it to clear and try again.
The DVD door cannot open.	<ul style="list-style-type: none">• Reset the Unit, press the POWER button to turn off the Unit, wait for a few seconds, then restart the Unit.

Trouble Shooting Guide

SYMPTOM

CAUSE (AND REMEDY)

VCR

- | | |
|--|---|
| No power. | <ul style="list-style-type: none">• Make sure the power cord is plugged in. |
| VCR does not receive CATV channels. | <ul style="list-style-type: none">• Use the CHANNEL PRESET screen to change from AIR mode to CATV. (See Setting the Channels.) |
| VCR does not operate. | <ul style="list-style-type: none">• Turn on the power.• Press the TAPE EJECT button several times.• Safety device in VCR is functioning. Unplug VCR and plug it in again after a few minutes. |
| VCR does not record. | <ul style="list-style-type: none">• Cassette erasure protection tab is removed. Use a different cassette or place adhesive tape over the tab opening.• Check for a cassette loaded in the unit. |
| No color or poor TV during normal viewing | <ul style="list-style-type: none">• Make sure the TV has been selected by pressing TV/VCR button.• Make sure all cables are connected properly. |
| No tape movemnt. | <ul style="list-style-type: none">• Make sure the VCR is not in PAUSE mode.• Make sure the tape has not reached the end or beginning. |
| No picture appears during playback. | <ul style="list-style-type: none">• Make sure the TV is set to the same channel as the VCR's 3 ↔ 4 Output Channel.• Check all connecting cables. |
| Timer recording does not work. | <ul style="list-style-type: none">• Power failure may have occurred. |
| Noise appears on the screen when the automatic tracking control system is operating. | <ul style="list-style-type: none">• Adjust the tracking manually by pressing CH +/- buttons.• In some cases, with a worn or damaged tape, noise cannot be eliminated completely. |
| Cannot record a signal through the front/rear external input jack. | <ul style="list-style-type: none">• The VCR may not be set to external input mode.
Press the INPUT button to set the VCR to external input mode. (See Tape Dubbinhg.) |
| Picture or sound is not stable during playback. | <ul style="list-style-type: none">• Keep your VCR away from electrical and magnetic appliances. Be sure to position your VCR at least 8" away from your TV or video monitor. |
| Stereo TV puts out monaural sound only, even when cassettes recorded in Hi-Fi stereo are playback. | <ul style="list-style-type: none">• Use RCA pin type connection cables (not the supplied coaxial cable) to connect the TV to the VCR, and set the TV to external video input mode.• Adjust the tracking or try another Hi-Fi stereo. (Any stereo signals recorded on the linear track will not be playback in stereo.) |
| Cassettes recorded in stero mode are not playback in stereo. | <ul style="list-style-type: none">• Make sure the sound was recorded in Hi-Fi stereo. (Any stereo signals recorded on the linear track will not be playback in stereo.) |

