



Panasonic®

DVD VIDEO RECORDER

Operating Instructions

Model No. **DMR-E100H**



Dear customer

Thank you for purchasing this product. For optimum performance and safety, please read these instructions carefully.

Before connecting, operating or adjusting this product, please read these instructions completely. Please keep this manual for future reference.



Region number supported by this unit

Region numbers are allocated to DVD players and software according to where they are sold.

- The region number of this unit is "1".
- The unit will play DVDs marked with labels containing "1" or "ALL".

Example:



[For U.S.A.]only]

The warranty can be found on page 68.

[For Canada]only]

The warranty can be found on page 69.

En las páginas 70 y 71 hay una guía de referencia rápida en español.

CAUTION!

THIS PRODUCT UTILIZES A LASER.
USE OF CONTROLS OR ADJUSTMENTS OR PERFORMANCE OF PROCEDURES OTHER THAN THOSE SPECIFIED HEREIN MAY RESULT IN HAZARDOUS RADIATION EXPOSURE.
DO NOT OPEN COVERS AND DO NOT REPAIR YOURSELF. REFER SERVICING TO QUALIFIED PERSONNEL.

WARNING:

TO REDUCE THE RISK OF FIRE, ELECTRIC SHOCK OR PRODUCT DAMAGE, DO NOT EXPOSE THIS APPARATUS TO RAIN, MOISTURE, DRIPPING OR SPLASHING AND THAT NO OBJECTS FILLED WITH LIQUIDS, SUCH AS VASES, SHALL BE PLACED ON THE APPARATUS.



CAUTION
RISK OF ELECTRIC SHOCK
DO NOT OPEN



CAUTION: TO REDUCE THE RISK OF ELECTRIC SHOCK, DO NOT REMOVE SCREWS. NO USER-SERVICEABLE PARTS INSIDE. REFER SERVICING TO QUALIFIED SERVICE PERSONNEL.



The lightning flash with arrowhead symbol, within an equilateral triangle, is intended to alert the user to the presence of uninsulated "dangerous voltage" within the product's enclosure that may be of sufficient magnitude to constitute a risk of electric shock to persons.



The exclamation point within an equilateral triangle is intended to alert the user to the presence of important operating and maintenance (servicing) instructions in the literature accompanying the appliance.

CAUTION:

TO PREVENT ELECTRIC SHOCK MATCH WIDE BLADE OF PLUG TO WIDE SLOT, FULLY INSERT.

CAUTION!

DO NOT INSTALL OR PLACE THIS UNIT IN A BOOKCASE, BUILT-IN CABINET OR IN ANOTHER CONFINED SPACE. ENSURE THE UNIT IS WELL VENTILATED. TO PREVENT RISK OF ELECTRIC SHOCK OR FIRE HAZARD DUE TO OVERHEATING, ENSURE THAT CURTAINS AND ANY OTHER MATERIALS DO NOT OBSTRUCT THE VENTILATION VENTS.

Keep the SD Memory Card out of reach of children. If swallowed, seek medical advice immediately.

THE FOLLOWING APPLIES ONLY IN THE U.S.A.

FCC Note:

This equipment has been tested and found to comply with the limits for a Class B digital device, pursuant to Part 15 of the FCC Rules. These limits are designed to provide reasonable protection against harmful interference in a residential installation. This equipment generates, uses, and can radiate radio frequency energy and, if not installed and used in accordance with the instructions, may cause harmful interference to radio communications. However, there is no guarantee that interference will not occur in a particular installation. If this equipment does cause harmful interference to radio or television reception, which can be determined by turning the equipment off and on, the user is encouraged to try to correct the interference by one or more of the following measures:

- Reorient or relocate the receiving antenna.
- Increase the separation between the equipment and receiver.
- Connect the equipment into an outlet on a circuit different from that to which the receiver is connected.
- Consult the dealer or an experienced radio/TV technician for help.

FCC Caution: To assure continued compliance, follow the attached installation instructions and use only shielded interface cables when connecting to peripheral devices.

Any changes or modifications not expressly approved by the party responsible for compliance could void the user's authority to operate this equipment.

This device complies with Part 15 of the FCC Rules. Operation is subject to the following two conditions: (1) This device may not cause harmful interference, and (2) this device must accept any interference received, including interference that may cause undesired operation.

THE FOLLOWING APPLIES ONLY IN THE U.S.A.

Note to CATV system installer:

This reminder is provided to call the CATV system installer's attention to Article 820-40 of the NEC that provides guidelines for proper grounding and, in particular, specifies that the cable ground shall be connected to the grounding system of the building, as close to the point of cable entry as practical.

DANGER	- VISIBLE AND INVISIBLE LASER RADIATION WHEN OPEN. AVOID DIRECT EXPOSURE TO BEAM. (FDA 21 CFR)
CAUTION	- VISIBLE AND INVISIBLE LASER RADIATION WHEN OPEN. AVOID EXPOSURE TO BEAM. (IEC60825-1)
ATTENTION	- RAYONNEMENT LASER VISIBLE ET INVISIBLE EN CAS D'OUVERTURE. EXPOSITION DANGEREUSE AU FAISCEAU.
ADVARSEL	- SYNLIG OG USYNLIG LASERSTRÅLING VED ÅBNING. UNDGÅ UDSÆTTELSE FOR STRÅLING.
VARO!	- AVATTAESSA OLET ALLTINA NÄKYVÄÄ JA NÄKYMÄTÖN LASERSÄTEILYLLÄ. ÄLÄ KATSO SÄTEESEEN.
VARNING	- SYNLIG OCH OSYNLIG LASERSTRÅLING NÄR DENNA DEL ÄR ÖPPNAD. BETRÄKTA EJ STRÅLEN.
ADVARSEL	- SYNLIG OG USYNLIG LASERSTRÅLING NÄR DEKSEL ÅPNE. UNNGÅ EKSPONERING FOR STRÅLEN.
VORSICHT	- SICHTBARE UND UNSICHTBARE LASERSTRÄHLUNG, WENN ABDECKUNG GEÖFFNET. NICHT DEM STRAHL AUSSETZEN.
注意	- 打开时有可见及不可见激光辐射。避免激光束照射。
注意	- ここを開くと可視及び不可視のレーザー光が出ます。ビームを直接見たり、照れたりしないでください。 RQLS0233

(Inside of product)

Before moving the unit, ensure the disc tray is empty. Failure to do so will risk severely damaging the disc and the unit.

Do not place the unit on amplifiers or equipment that may become hot.

The heat can damage the unit.

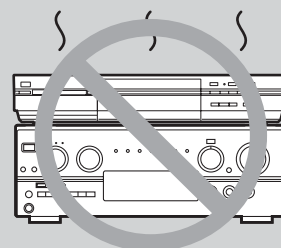

IMPORTANT SAFETY INSTRUCTIONS

Read these operating instructions carefully before using the unit. Follow the safety instructions on the unit and the applicable safety instructions listed below. Keep these operating instructions handy for future reference.

- 1) Read these instructions.
- 2) Keep these instructions.
- 3) Heed all warnings.
- 4) Follow all instructions.
- 5) Do not use this apparatus near water.
- 6) Clean only with dry cloth.
- 7) Do not block any ventilation openings. Install in accordance with the manufacturer's instructions.
- 8) Do not install near any heat sources such as radiators, heat registers, stoves, or other apparatus (including amplifiers) that produce heat.
- 9) Do not defeat the safety purpose of the polarized or grounding-type plug. A polarized plug has two blades with one wider than the other. A grounding-type plug has two blades and a third grounding prong. The wide blade or the third prong are provided for your safety. If the provided plug does not fit into your outlet, consult an electrician for replacement of the obsolete outlet.
- 10) Protect the power cord from being walked on or pinched particularly at plugs, convenience receptacles, and the point where they exit from the apparatus.
- 11) Only use attachments/accessories specified by the manufacturer.
- 12) Use only with the cart, stand, tripod, bracket, or table specified by the manufacturer, or sold with the apparatus. When a cart is used, use caution when moving the cart/apparatus combination to avoid injury from tip-over.
- 13) Unplug this apparatus during lightning storms or when unused for long periods of time.
- 14) Refer all servicing to qualified service personnel. Servicing is required when the apparatus has been damaged in any way, such as power-supply cord or plug is damaged, liquid has been spilled or objects have fallen into the apparatus, the apparatus has been exposed to rain or moisture, does not operate normally, or has been dropped.



Features

This unit allows recording of high quality video on HDD and DVD-RAM, the compact and durable digital media with fast random access. This media also out performs past tape formats in ease of operation.

■ Maximum 160 hours on HDD (Hard Disk Drive) (→page 15)

This model is installed with a high capacity 120 GB hard disk capable of recording a maximum of 160 hours (6 hours continuously). The same functions are available with HDD as with DVD-RAM and editing/recording of visual data from hard disk to DVD-RAM/R is easy-to-perform.

■ Maximum 12 hours on DVD-RAM

- Using a double sided, 9.4 GB DVD-RAM allows you to record a maximum of 12 hours (6 hours continuously).
- You can also use the FR (Flexible Recording) mode to fit recordings efficiently onto the available space on the disc.

■ Maximum 24× DVD-R recording speed

You can high speed record from the HDD to a DVD-R using 24× recording speed on DVD-R discs that are compatible with high speed recording (When EP mode and Dolby Digital is selected). Programs stored on the HDD can be quickly dubbed and stored on a DVD-R.

■ Auto Renewal Recording (→page 28)

If you record a program onto HDD repeatedly everyday or every week using timer recording, the unit will record the new program over the old one.

■ Relief Recording (→page 27)

When timer recording to DVD-RAM or DVD-R, the unit will compare the remaining space on the disc and the time necessary for recording. If space is insufficient the unit will record the program to HDD instead (there is no relief recording function the other way, i.e. from HDD to DVD-RAM or DVD-R).

■ Editing your recording [HDD] [RAM]

- You can divide programs (→page 36).
- Use play lists (→page 32) to select your favorite scenes and rearrange them to play in any order you like.

■ Dubbing/editing/playing SD VIDEO (MPEG4) programs (→pages 22, 30, 42)

- You can simultaneously record programs as SD VIDEO (MPEG4) programs to the HDD (→page 14). By dubbing to a SD card, you can view the programs on a Panasonic video camera [SD VIDEO (MPEG4) compatible].
- You can also dub SD VIDEO (MPEG2) recorded on future releases of Panasonic SD video cameras to this unit.

■ Saving/editing/playing still pictures (JPEG, TIFF) taken on a digital camera (→pages 22, 38–41)

- You can save to a high capacity HDD or DVD-RAM.
- You can play on a television screen.
- You can set the DPOF (Digital Print Order Format) for automatic printing on your home printer or at a photo developing store.

■ DV Automatic Recording (→page 16)

A play list is automatically created, which is convenient for editing.

■ Exceptional sound and picture quality when recording

- Audio is recorded using Dolby Digital stereo, enabling high quality sound recordings. When recording in XP mode it is possible to use LPCM (2 channel) to achieve sound recordings of even higher quality.
- The encoder system used for recording is called "Hybrid VBR" and allows high quality recordings.

■ Fast access to the program you want to watch (→page 19) [HDD] [RAM] [DVD-R]

Use the Direct Navigator to find a program you have recorded and start play.

■ Make your own DVD-Video

- Finalizing a DVD-R that has been recorded on produces an original DVD-Video in accordance with DVD-Video standards.
- In addition to DVD-Video movie software, this unit can also play other types of discs including audio CDs and Video CDs. This means that this unit has the potential to play a central role in your home entertainment, from high-end home theater through to CD playback.

■ MP3 disc play (→page 24)

You can also play MP3 files recorded on CD-R and CD-RW, as well as DVD-RAM, DVD-R, DVD-Audio, DVD-Video, Video CDs and CDs.

■ Progressive Scan

By connecting the component video terminal of this unit to a progressive scan television, it is possible to enjoy the high quality picture rendered by the progressive scan function.

■ Quick View (→page 21)

You can speed up play to make checking the contents faster. Both video and sound are played faster.

■ The FUNCTIONS window shows you most of the features you can use (→page 50)

The FUNCTIONS window has most of the features and functions you are likely to use regularly. Just select the icon for the operation you want to perform.

■ Watch a program while you are recording it (→page 17) [HDD] [RAM]

Chasing play

You can watch a program from the start while you are still recording it.

Simultaneous rec and play

You can record a program while watching one you recorded previously.

Time Slip

You can jump back to review a piece of action you missed while recording by pressing the time slip button.

- During playback, you can specify a length of time to jump to the scene you wish to view.

Getting started

IMPORTANT SAFETY INSTRUCTIONS	3
Features	3
Accessories	4

Setting up

STEP 1 Antenna and television connections	5
STEP 2 The remote control	6
STEP 3 Plug-in Auto Tuning	6
STEP 4 VCR Plus+ guide channel settings	8
STEP 5 Set up to match your television	9
Disc information	10
HDD (Hard disk drive)	11
Control reference guide	12

Recording

Recording television programs	14
Inserting discs	14
Watching the television while recording	15
Recording the best quality pictures within the set amount of time —Flexible Recording	15
Recording from a video cassette recorder	16
DV Automatic Recording (DV AUTO REC)	16
Playing while you are recording	17
Playing from the beginning of the program while you are recording—Chasing Play	17
Simultaneous rec and play	17
Reviewing the recorded images while recording—Time Slip ..	17

Playing back

Playing discs	18
When a menu screen appears on the television	19
Position Memory	19
Using the Direct Navigator	19
To erase a program that is being played back	19
Other methods of play	20
Skipping	20
Slow-motion play	20
Frame-by-frame viewing	20
Fast forward and rewind—SEARCH	20
Starting play from a selected item	20
Skipping a minute forward—CM Skip	21
Selecting an amount of time to skip—Time Slip	21
Quick View	21
Marking places to play again—MARKER	21
Playing still pictures and SD VIDEO (MPEG4) programs	22
Using menus to play MP3 discs	24
Changing audio	25

Timer recording

Timer recording	26
Specify a time to stop recording	26
Using VCR Plus+ codes to make timer recordings	26
Manually programming timer recordings	27
Auto Renewal Recording	28
Check programs	28
Change or cancel the program	29

Dubbing

Dubbing programs or play list	30
One Touch Dubbing	31

Editing

Creating play lists	32
Playing play lists	33
Playing play list scenes	33
To erase a play list or a play list scene during playback	33
Editing play lists	34
Editing programs	36
Editing still pictures	38
Editing SD VIDEO (MPEG4) programs	42
HDD, Disc setting	44
Entering text	46

Advanced operation

On-screen displays	47
Using on-screen menus	48
Common procedures	48
Disc menu	48
Play menu	49
Audio menu	49
Video menu	49
Using the FUNCTIONS window	50
Changing the unit's settings	51
Summary of settings	51
Common procedures	54
Changing the remote control code	54
Audio channel for DV input	54
Clock settings	55
Other channel settings	56
Home Theater	57
Connecting a cable TV box/satellite receiver	58
Connecting an amplifier or system component	59
Connecting other video equipment	60
Other antenna connections	61
Other antenna connection to the unit	61
Other antenna connection from the unit to the television	61

Reference

Glossary	62
Disc handling	62
Error messages	63
Troubleshooting guide	64
Maintenance	66
Specifications	67
Limited Warranty (ONLY FOR U.S.A.)	68
Limited Warranty (ONLY FOR CANADA)	69
Product Service	69
Guía de referencia rápida en español (Spanish Quick Reference)	70
Index	Back cover

Accessories

 Please check and identify the supplied accessories. Use numbers indicated in parentheses when asking for replacement parts.
Only for U.S.A.: To order accessories contact 1-800-332-5368 or the website (<http://www.panasonic.com>).
Only for Canada: To order accessories, call the dealer from whom you have made your purchase.

1 Remote control
(EUR7624KB0)



1 AC power supply cord
(RJA0065-A)



1 75 Ω coaxial cable
(VJA1091)



2 Batteries
for remote control



1 Audio/Video cable
(VJA0788)



1 DVD-RAM disc



[Note]
The included AC power supply cord is for use with this unit only. Do not use it with other equipment.

(U.S.A. only)
Product Registration Card
 Please complete and return the included product registration card, or register via the Internet at: <http://www.prodreg.com/panasonic/>

STEP 1 Antenna and television connections

Preparation

- Refer to the television's operating instructions.
- Turn the television off and disconnect its AC power supply cord.

To enjoy sound through other audio equipment (→page 59)

To enjoy progressive video

Connect to the component video (480P) input terminals on a television compatible with this unit's copy guard system. (Video will not be displayed correctly if connected to an incompatible television.)

- All Panasonic televisions that have 480P input terminals are compatible. Consult the manufacturer if you have another brand of television.

Setup precautions

- Do not place in an enclosed area so the rear cooling fan and the cooling vents on the side are covered up.
 - Place the unit on a surface that is flat and not subject to vibration or impact.
 - Place in an area where condensation does not occur. Condensation is a phenomenon where moisture forms on a cold surface when there is an extreme change in temperature. Condensation may cause internal damage to the unit.
- In the following situation, **with the power off**, let the unit adjust to the room temperature and wait 2-3 hours until condensation is gone.

Conditions where condensation may occur

- During the rainy season in tropical and sub tropical areas.
- When there is high humidity or a lot of steam in the room.
- When there is an extreme change in temperature (moving from a very hot location to a very cold location, or when an extreme change in air conditioning or cooled air directly impacts the unit.)

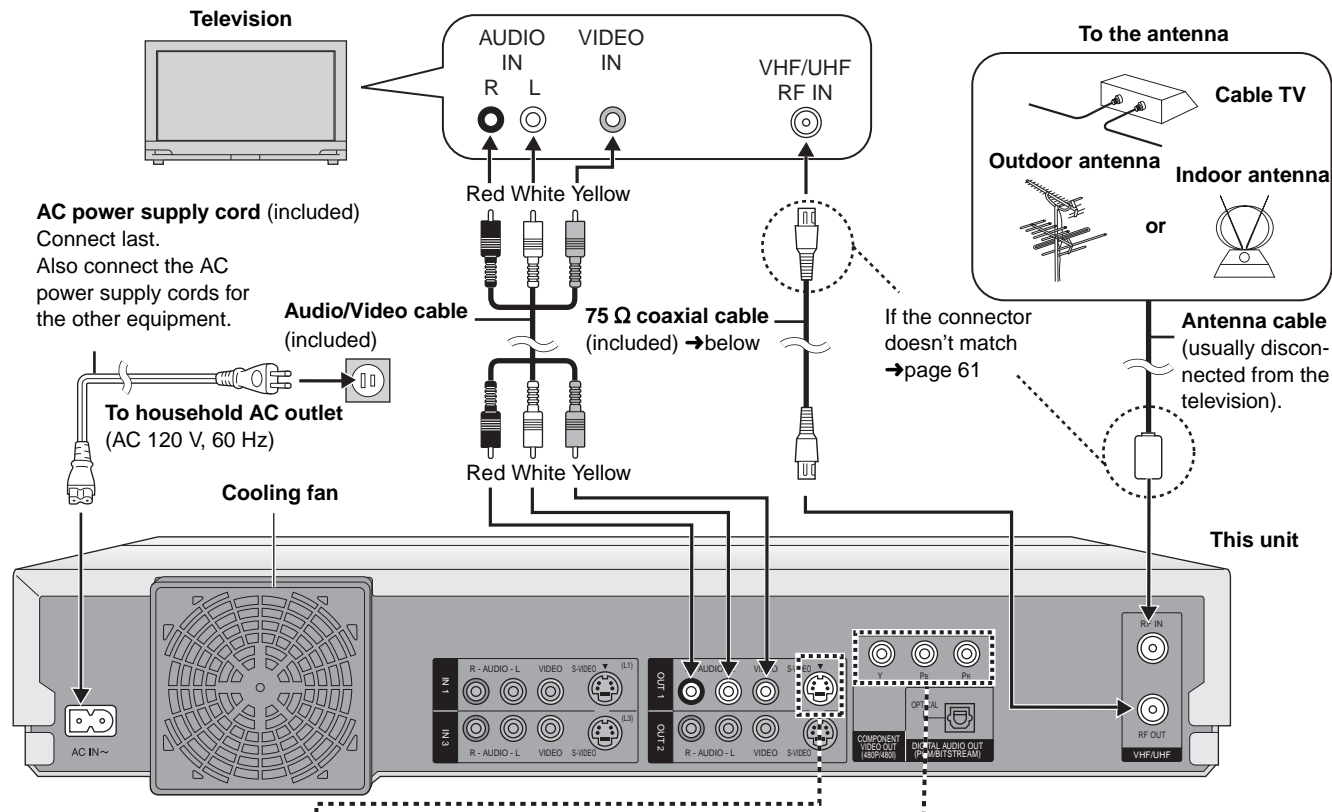

S-VIDEO OUT terminal

The S-VIDEO OUT terminal achieves a more vivid picture than the VIDEO OUT terminal by separating the chrominance (C) and luminance (Y) signals. (Actual results depend on the television.)

S video cable (not included)



Television

S VIDEO IN

COMPONENT VIDEO OUT terminal

These terminals can be used for either interlace or progressive output and provide a purer picture than the S-VIDEO OUT terminal.

Connection using these terminals outputs the color difference signals (P_B/P_R) and luminance signal (Y) separately in order to achieve high fidelity in reproducing colors.

- The description of the component video input terminals depends on the television or monitor (e.g. Y/P_B/P_R, Y/B-Y/R-Y, Y/C_B/C_R). Connect to terminals of the same color.
- After making this connection, change the black level for a better picture (→page 52, Video-Black Level Control).

Television

COMPONENT VIDEO IN

Y P_B P_R

Y P_B P_R

Y P_B P_R

Y P_B P_R

Y P_B P_R

Y P_B P_R

Y P_B P_R

Y P_B P_R

Y P_B P_R

Y P_B P_R

Video cable (not included)

When making either of the above connections, ensure you connect the audio cables to the corresponding audio input terminals on the television.

75 Ω coaxial cable

- The signal from the antenna passes through this unit and along the 75 Ω coaxial cable to the television even when this unit is turned off. You don't have to connect the antenna to the television.
- The picture and sound signal from this unit does not go through the 75 Ω coaxial cable to the television. Make sure you connect one of the following terminals on this unit to the television: the AUDIO/VIDEO terminal, the S-VIDEO OUT terminal or the COMPONENT VIDEO OUT terminal. If the television has none of these terminals, consult your local dealer.

Do not connect the unit through a video cassette recorder

Video signals fed through video cassette recorders will be affected by copyright protection systems and the picture will not be shown correctly on the television.

Conserving power

This unit consumes a small amount of power, even when it is turned off (approx. 3.5 W). To save power when the unit is not to be used for a long time, unplug it from the household AC outlet.

STEP 2 The remote control

Batteries

Opening the rear cover.

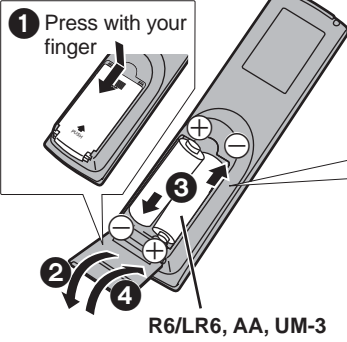

Closing the rear cover.



R6/LR6, AA, UM-3

- Insert so the poles (+ and -) match those in the remote control.
- Do not use rechargeable type batteries.

Do not:

- Mix old and new batteries.
- Use different types at the same time.
- Heat or expose to flame.
- Take apart or short circuit.
- Attempt to recharge alkaline or manganese batteries.
- Use batteries if the covering has been peeled off.

Mishandling of batteries can cause electrolyte leakage which can damage items the fluid contacts and may cause a fire.

Remove if the remote control is not going to be used for a long period of time. Store in a cool, dark place.

[Note]

If you cannot operate the unit or television using the remote control after changing the batteries, please re-enter the codes (television →page 9, main unit →page 54).

Use

Remote control signal sensor

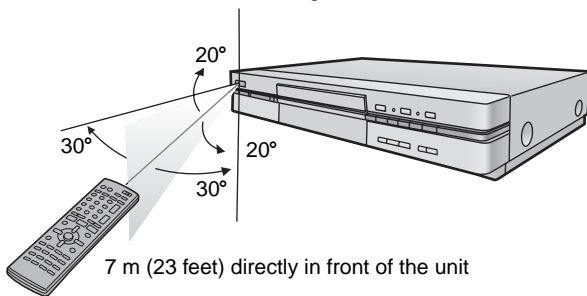

STEP 3 Plug-in Auto Tuning

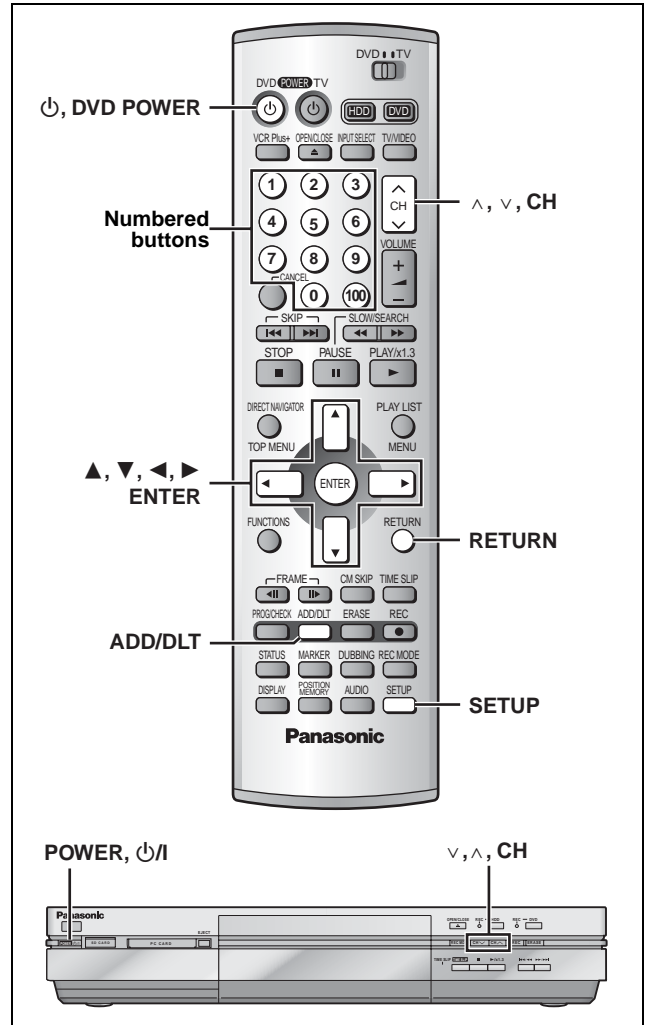

After plugging the unit into your household AC outlet and pressing [POWER, DVD POWER] to turn the unit on for the first time, the unit assists you to set the menu language, and automatically tunes in all the channels it can receive and sets the clock.

The unit automatically determines the type of transmission (airwaves or cable) and puts them into channels as follows.

	Band	Channel
TV Mode (Airwaves)	VHF	2-13
	UHF	14-69
CATV Mode (Cable)	VHF	2-13
	CATV LOW BAND	95-99
	CATV MID/SUPER BAND	14-36
	CATV HYPER BAND	37-65
	ULTRA BAND	66-94 100-125
	SPECIAL CATV CHANNEL	1

Preparation

- Confirm that the antenna is connected correctly.
- Turn on the television and select the appropriate video input to suit the connections to this unit.

1 Press [⏻, DVD POWER] to turn the unit on.

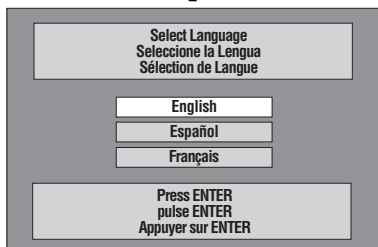

2 Press [▲, ▼] to select the menu language and press [ENTER].

e.g., when you select English

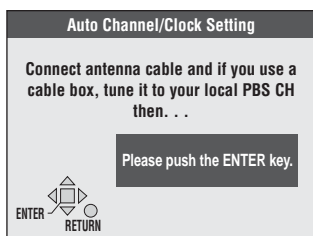

3 Press [ENTER] to start Plug-in Auto Tuning.

The unit then proceeds with Auto Clock Setting. The time is displayed when finished. If the clock is an hour slower or faster than the actual time, go to "Time Zone Adjust" to correct it (→page 55).

4 When the display shows the correct time Press [ENTER] to complete Plug-in Auto Tuning.

If the unit couldn't set the clock automatically

Press [ENTER] to show the "Manual Clock Setting" screen. Set the time manually (→page 55).

To start Plug-in Auto Tuning again (after relocation, for example)

Antenna system, channel caption, and VCR Plus+ guide channel settings all revert to the default values when you perform the procedure below. Timer recording settings are also cleared.

When the unit is on and stopped

- 1 Press and hold [v, CH] and [^, CH] on the main unit for about five seconds.**
The unit turns off.
- 2 Press [⏻, DVD POWER] to turn the unit on.**
Follow the above steps 2–4.

If Plug-in Auto Tuning fails

1 Press [SETUP] to show the menus.

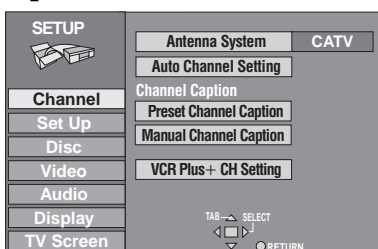

2 Press [▲, ▼] to select "Channel" and press [▶].

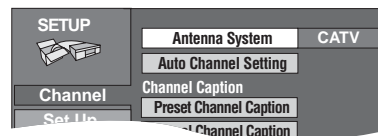

3 Press [▲, ▼] to select "Antenna System" and press [ENTER].

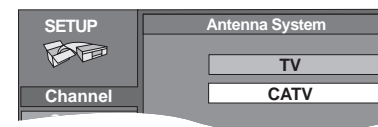

4 Press [▲, ▼] to select "TV" or "CATV" and press [ENTER].

The screen shown in step 2 reappears.

5 Press [▲, ▼] to select "Auto Channel Setting" and press [ENTER].

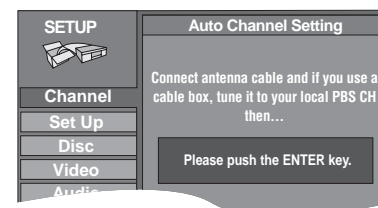

If you have not yet set clock, the "Auto Channel/Clock Setting" screen appears.

6 Press [ENTER].

Auto setting starts. This takes a few minutes. (To stop auto channel setting, press [RETURN].) When finished, the Complete screen or time display is shown. Press [ENTER].

To return to the previous screen

Press [RETURN].

To exit the SETUP screen

Press [SETUP].

Adding and deleting channels

Add or delete channels if necessary channels are not set or unnecessary channels are set.

While this unit is receiving the antenna signal (but not during recording):

1 Press the numbered buttons to select a channel.

e.g., "5": [0] → [5] Unit's display
 "15": [1] → [5]
 "115": [100] → [1] → [5]



- You can also use [^, v, CH] when you are going to delete a channel.

2 Press [ADD/HLT].

The channel is **deleted** if it was set or **added** if it was not set. e.g.,



Repeat steps 1 and 2 as necessary.

STEP 4 VCR Plus+ guide channel settings

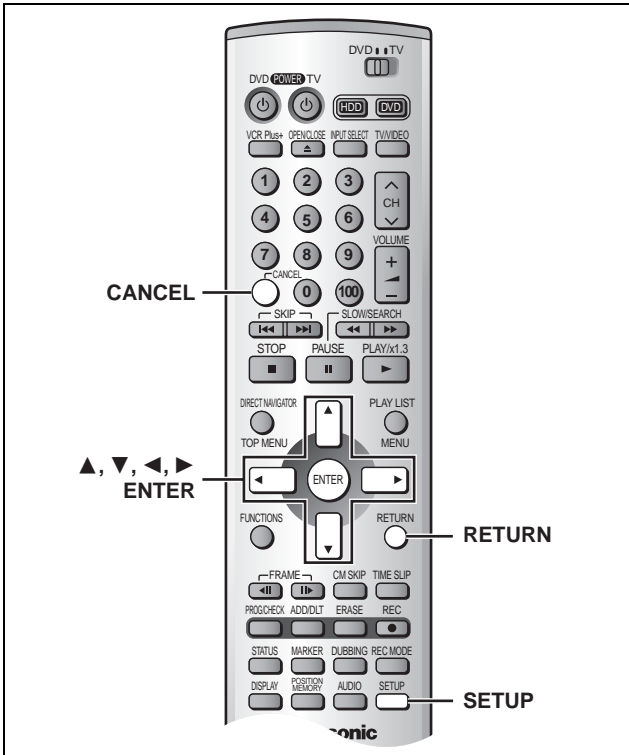

Set these guide channels so you can use VCR Plus+ codes for timer recording. Before starting the settings, prepare a chart showing the channels, station names, and guide channels.

e.g.,

Station name	Guide channel	Channel number	Channel setting (in step 5)
CBS	04	04	Unnecessary
HBO	33	15	Enter channel 15 next to Guide Channel 33.
Nickelodeon	38	20	Enter channel 20 next to Guide Channel 38.

Look up the guide channels for the stations in magazines.

Write down all the stations you can receive.

1 Press [SETUP] to show the menus.

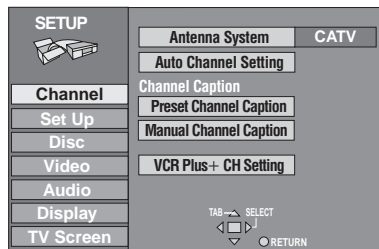

2 Press [▲, ▼] to select “Channel” and press [▶].

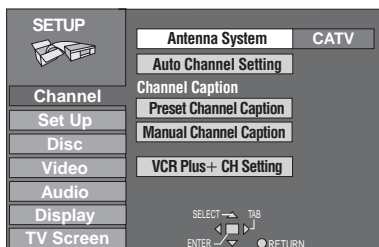

3 Press [▲, ▼] to select “VCR Plus+ CH Setting” and press [ENTER].

e.g., when the current antenna system is CATV.

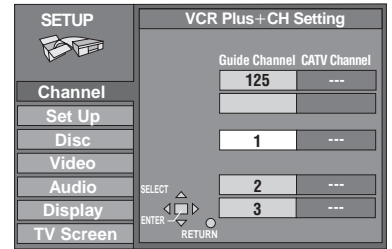

4 Press [▲, ▼] to select the guide channel you want to set and press [▶].

When selecting the guide channel, press and hold [▲, ▼] to scroll the screen up and down.

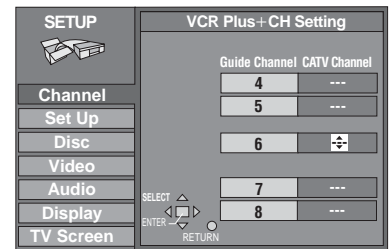

5 Press [▲, ▼] to select the channel corresponding to the guide channel and press [◀].

To delete a number, press [CANCEL]. Repeat steps 4 and 5 as necessary.

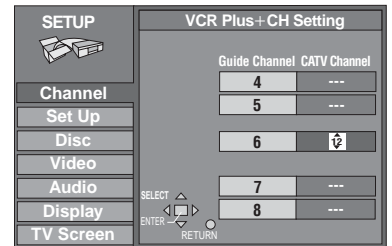

6 Press [ENTER].

The “Channel” screen reappears.

To return to the previous screen
Press [RETURN].

To exit the SETUP screen
Press [SETUP].

VCR Plus+ and PlusCode are registered trademarks of Gemstar Development Corporation. The VCR Plus+ system is manufactured under license from Gemstar Development Corporation.

Pats. 5,307,173; 5,335,079; 4,908,713; 4,751,578; and 4,706,121

STEP 5 Set up to match your television

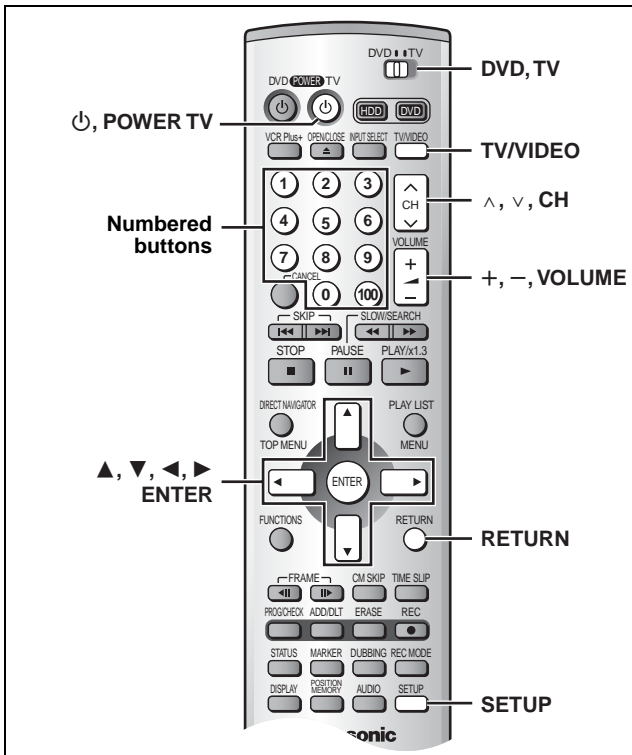

Change the settings if your television is:

- Progressive
 - Read your television's operating instructions for details.
- Widescreen (16:9 aspect ratio)

1 Press [SETUP] to show the menus.

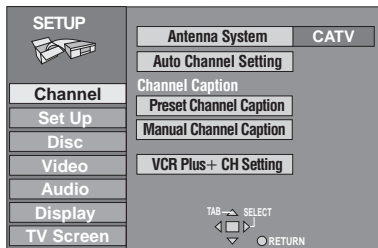

2 Press [▲, ▼] to select "TV Screen" and press [▶].

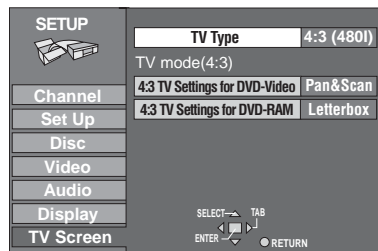

3 Press [▲, ▼] to select "TV Type" and press [ENTER].

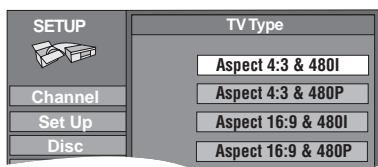

4 Press [▲, ▼] to select the item and press [ENTER].

- If you select a progressive output (480P) item, select Video in the on-screen menu and set "Transfer" to suit the material (→page 49).

To return to the previous screen

Press [RETURN].

To exit the SETUP screen

Press [SETUP].

■ Regarding Progressive Television Picture

Progressive image aspect (height to width ratio) is set at a standard 16:9. DVD-Video which has been set at 16:9 will be displayed correctly. However, 4:3 video material will be stretched to the right and left when displayed.

• To view the picture at the right aspect

- For televisions that allow the aspect of progressive images to be adjusted, use the function provided on the television and adjust as necessary.
- For televisions which do not allow the aspect of progressive images to be adjusted, please set "Progressive" to "OFF" (→page 49).

[Note]

- If the unit is connected to the TV through VIDEO OUT or S-VIDEO OUT, output will be interlace only (even if you select progressive output).
- When progressive output is on, closed captions cannot be displayed.

Television operation

You can control televisions by entering the remote control code.

Press and hold [⏻, POWER TV] and enter the two-digit code with the numbered buttons.

e.g., 01: press [0] → [1].

Code No. and Manufacturer

01	Panasonic/National QUASAR	11	JVC
02		12	HITACHI
03	MAGNAVOX SYLVANIA PHILIPS (RC-5)	13	mitsubishi
04	ZENITH	14	SAMSUNG
05	THOMSON RCA GE	15	GOLDSTAR/LG
06	SHARP	17	
08	SONY	18	SAMSUNG
09	TOSHIBA	19	
10	SANYO FISHER		–

- Test by turning on the television and changing channels. Repeat the procedure until you find the code that allows correct operation.

[Note]



If your television brand is not listed or if the code listed for your television does not allow control of your television, this remote control is not compatible with your television.

■ Operation

Point the remote control at the television.

Operation	Button
On and off	[⏻, POWER TV]
Video input mode	[TV/VIDEO]
Channels	(Switch [DVD, TV] to "TV".) [▲, ▼, CH] or Numbered buttons e.g., Channel "5": [0] → [5]
Volume	[+, −, VOLUME]

Discs you can use for recording and play

 DVD-RAM 4.7 GB/9.4 GB, 12 cm (5") 2.8 GB, 8 cm (3")	 DVD-R 4.7 GB, 12 cm (5"), 1.4 GB, 8 cm (3") for General Ver. 2.0 4.7 GB, 12 cm (5") for General Ver. 2.0/ 4x-SPEED DVD-R Revision 1.0
---	--

- We recommend using Panasonic discs as they have been confirmed to be compatible with this unit. Other discs may not perform correctly.
- Do not allow the disc to become dirty or scratched. Fingerprints, dirt, dust, scratches or deposits of cigarette smoke on the recording surface may make it impossible to use the disc for recording.
- Discs with programs recorded in PAL already cannot be recorded on using this unit.

DVD-RAM

- **DVD-RAM recorded on this unit may not be compatible with other DVD players, including some Panasonic players. Consult the manual for the player to determine compatibility with these DVD-RAM discs.**
- This unit is compatible with both non-cartridge and cartridge DVD-RAM, but the write-protect tabs on cartridge-type discs give better protection to your recordings.
- Picture aspect ratios, regular 4:3 or widescreen 16:9, are recorded as they are received.

DVD-R

- **In order to play a DVD-R recorded using this unit on another playback source, the disc must first be finalized** (→page 44).
- Once a DVD-R is finalized, it becomes DVD-Video.
- You can record onto the available space on the disc and perform editing functions, such as giving titles to discs and programs and erasing programs before finalizing.
- When programming is erased from a DVD-R, that space does not become available. Once an area on a DVD-R is recorded on, that area is no longer available for recording, whether the recording is erased or not.
- It takes about 30 seconds for the unit to complete recording management information after recording finishes.
- This unit optimizes the DVD-R for each recording. Optimizing is carried out when you start recording after inserting the disc or turning on the unit. Recording onto the disc may become impossible if optimizing is carried out too many times.
- Play may be impossible in some cases due to the condition of recording.
- The video is recorded in a 4:3 aspect irrespective of the video signal input.
- A DVD-R recorded on this unit may not be recordable on other Panasonic DVD recorders.
- This unit is compatible with 1x-4x recording speed discs.

Discs that cannot be played

- DVD-Video with a region number other than "1" or "ALL"
- 12-cm (5"), 2.6- and 5.2-GB DVD-RAM
- DVD-RAM not recorded following the Video Recording Standard
- 3.95- and 4.7-GB DVD-R for Authoring
- Unfinalized DVD-R recorded on other equipment
- PAL discs
- DVD-ROM
- DVD-RW
- +RW
- CD-ROM
- CDV
- CD-G
- Photo CD
- CVD
- SVCD
- SACD
- MV-Disc
- PD
- Divx Video Disc, etc.

The manufacturer accepts no responsibility and offers no compensation for loss of recorded or edited material due to a problem with the unit or recordable media, and accepts no responsibility and offers no compensation for any subsequent damage caused by such loss.

Examples of causes of such losses are

- A disc recorded and edited with this unit is played in a DVD recorder or computer disc drive manufactured by another company.
- A disc used as described above and then played again in this unit.
- A disc recorded and edited with a DVD recorder or computer disc drive manufactured by another company is played in this unit.

Play-only discs

 DVD-Audio ^{#1}	 DVD-Video	 Video CD	 Audio CD ^{#2}
---	--	--	--



^{#1} Play is in stereo only.

^{#2} Including discs recorded with MP3.

- The producer of the material can control how DVD-Video and Video CDs are played. This means that you may not be able to control play of a disc with some operations described in these operating instructions. Read the disc's instructions carefully.
- This unit can play CD-R/CD-RW (audio recording disc) recorded with CD-DA (digital audio), video CD (video CD format 2.0 or above) or MP3. Close the sessions or finalize the disc after recording. Play may be impossible on some CD-R or CD-RW discs due to the condition of recording.
- This unit cannot record onto CD-R or CD-RW.

DVD-Video

• Audio format

	Dolby Digital (→page 53) This unit can play Dolby Digital in stereo (2 channels). Connect an amplifier with a built-in Dolby Digital decoder to enjoy surround sound.
	DTS Digital Surround (→page 53) Connect this unit to equipment that has a DTS decoder to enjoy DVDs with this mark.

Discs you can use

The features you can use with the different types of discs are indicated as follows.

[HDD]	[RAM]	[DVD-R]	[DVD-A]	[DVD-V]
Hard Disk	DVD-RAM	DVD-R	DVD-Audio	DVD-Video
[SD]	[CARD]	[VCD]	[CD]	[MP3]
SD cards	PC cards	Video CD	Audio CD	MP3 discs

- [DVD-R] indicates DVD-R that have not yet been finalized (→page 44). DVD-R that have been finalized can use the same features as DVD-Video. (Refer to features indicated [DVD-V].)

Protection

You can protect the disc and card to avoid accidentally erasing recorded content.

- **Cartridge-protect [RAM]**
 (Type 1, 2, and 4 cartridge discs)
 Switch the write-protect tab to the protect position. Play will automatically start once inserted in the unit.
- **Card-protect [SD] [CARD]**
 Switch the write-protect switch to the "LOCK" position.

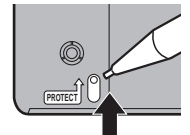

e.g. SD Memory Card



SD/PC card

SD card: indicates a card inserted in SD card slot

PC card: indicates a card inserted in PC card slot

Compatible cards

SD card slot	
● SD Memory Card ^{*1*2}	● Multi Media Card ^{*1*2}
PC card slot	
● SD Memory Card ^{*1*4}	● Multi Media Card ^{*1*4}
● Compact Flash ^{*1*4}	● Smart Media ^{*1*4}
● Memory Stick ^{*1*4}	● xD picture card ^{*1*4}
● Microdrive ^{*1*4}	● ATA Flash PC card ^{*1}
● Mobile hard disk ^{*3}	

^{*1} You can save/edit/play still pictures (JPEG, TIFF).

^{*2} You can dub/edit/play SD VIDEO programs. [SD VIDEO (MPEG2) programs are for dubbing only.]

^{*3} Content saved on SD media storage (SV-PT1). You can only play still pictures (JPEG, TIFF) and SD VIDEO (MPEG4) programs, and dub(save) to HDD or DVD-RAM. [SD VIDEO (MPEG2) programs are for dubbing only.]

^{*4} A PC card adapter conforming to PC card standards is necessary.

- **Compatible with:** FAT 12 or FAT 16
- We recommend using this unit to format a card when using for the first time (→page 40, 42).
- You may not be able to use if formatted on a computer.
- Files created on other equipment may not display properly on this unit. Additionally, files created on this unit may not display properly on other equipment. (Cannot play, image size or title may not be correct etc.)
- Only use the cards recommended above. We recommend using a Panasonic SD card.
- You cannot use SD cards that exceed 2 GB.
- Depending on the card, some may not be usable with this unit.

Still pictures

- Compatible formats: DCF^{*} compliant (Content recorded on a digital camera etc.)
- ^{*}Design rule for Camera File system: unified standard established by Japan Electronics and Information Technology Industries Association (JEITA).
- File format: JPEG, TIFF non-compressed RGB chunky format
- Number of pixels: 320 × 240 to 6144 × 4096 (Sub sampling is 4:2:2 or 4:2:0)
- The unit can handle a maximum of 3000 files and a maximum of 300 folders (including higher level folders).
- Operation may take time to complete when playing TIFF format still pictures, or when there are many files and/or folders, some files may not display or be playable.
- MOTION JPEG is not supported.

SD VIDEO (MPEG4) programs

- Compatible format: SD VIDEO specification compliant (ASF)
 - Video: MPEG4 compliant
 - Audio: G.726 compliant (monaural)
- Maximum bit rate: 64 kbps to 1050 kbps
- Average bit rate: 60 kbps to 768 kbps
- Number of pixels: 176 × 144 (QCIF format) to 320 × 240 (QVGA format)
 - Frame rate: 6 fps to 15 fps
- The unit can handle a maximum of 999 files.

Follow the precautions indicated below to prevent damage to the internal HDD. (Not following precautions may result in a loss of recording, stop of operation or recording of noise.)

While operating

- Do not remove the AC power plug from the AC outlet, or flip the power breaker switch.
- Do not move the unit or subject to vibration or impact.
 - When moving the unit:
 - ① Turn the power switch off (Wait until “BYE” disappears from the display)
 - ② Remove the AC power plug from the AC outlet
 - ③ Move after waiting more than 2 minutes.

While power is on, the HDD is rotating at high speed. Sound or movement due to rotation is normal.

In the event of a power failure

Program content during recording or play may be damaged (including SD VIDEO programs).

Safeguards against accidental loss

Data may be lost if the HDD suffers damage. Any contents you wish to keep permanently should be dubbed to DVD-RAM or DVD-R.

When “HDD SLEEP” appears in the display

The HDD has automatically gone into SLEEP mode in order to extend the life of the HDD. (The [HDD] button on the main unit flashes and then goes out.)

- Press [HDD] to activate.
- While in SLEEP mode play or recording may not begin right away because the HDD takes time to be re-activated.
- If there is no disc in the unit, the HDD will go into SLEEP mode after there has been no operation for 30 minutes or longer. When not using the unit, we recommend removing the disc.

HDD recording time remaining

This unit records using a VBR (Variable bit rate) data compression system to vary recorded data segments to match video data segments which may cause differences in the displayed amount of time and space remaining for recording.

If the remaining amount time is insufficient, erase any unwanted programs to create enough space before you start recording. (Erasing a play list will not increase the amount of time.)

Remote control

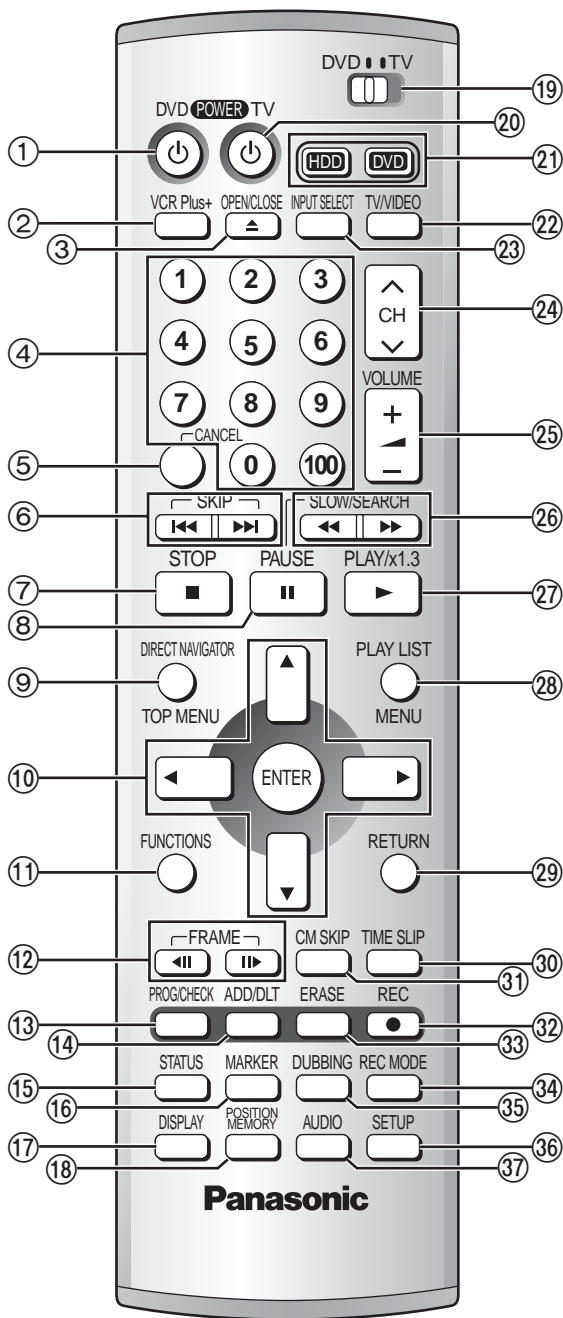

- ① **POWER button** (⏻, DVD (POWER)) 7, 14
Press to switch the unit from on to standby mode or vice versa.
In standby mode, the unit is still consuming a small amount of power.
- ② **VCR Plus+ button** (VCR Plus+) 26
- ③ **Disc tray open/close button** (▲ OPEN/CLOSE) 14
- ④ **Numbered buttons** (1–9, 0, 100) 8
- ⑤ **Cancel button** (CANCEL) 8
- ⑥ **Skip buttons** (⏮, ⏭) SKIP 20
- ⑦ **Stop button** (■ STOP) 14
- ⑧ **Pause button** (⏸ PAUSE) 14
- ⑨ **Top menu and Direct Navigator button**
(TOP MENU, DIRECT NAVIGATOR) 19, 24
- ⑩ **Cursor buttons** (▲, ▼, ◀, ▶)/Enter button (ENTER) 7
- ⑪ **Functions button** (FUNCTIONS) 50
- ⑫ **Frame advance and frame reverse buttons**
(◀◀, ▶▶) FRAME 20
- ⑬ **Manual programming and check button**
(PROG/CHECK) 27
- ⑭ **Manual channel adding and deleting button**
(ADD/DLT) 7
- ⑮ **On-screen display button** (STATUS) 47
- ⑯ **Marker button** (MARKER) 21
- ⑰ **On-screen menu button** (DISPLAY) 48
- ⑱ **Position memory button** (POSITION MEMORY) 19
- ⑲ **DVD/TV switch** (DVD, TV) 9
- ⑳ **TV power on/off button** (⏻, (POWER) TV) 9
- ㉑ **Drive select buttons** (HDD, DVD) 14
- ㉒ **Television input mode selector** (TV/VIDEO) 9
- ㉓ **Input select button** (INPUT SELECT) 16
- ㉔ **Channel buttons for recorder and TV** (▲, ▼, CH) 9, 14
- ㉕ **TV volume buttons** (+, −, VOLUME) 9
- ㉖ **Slow/search buttons** (◀◀, ▶▶) SLOW/SEARCH 20
- ㉗ **Play/quick view button** (▶ PLAY/×1.3) 18, 21
- ㉘ **Menu and Play list button** (MENU, PLAY LIST) 19, 32
- ㉙ **Return button** (RETURN) 7
- ㉚ **Time slip button** (TIME SLIP) 17, 21
- ㉛ **One-minute skip button** (CM SKIP) 21
- ㉜ **Recording button** (●, REC) 14
- ㉝ **Erase button** (ERASE) 19, 23, 33
- ㉞ **Recording mode button** (REC MODE) 14
- ㉟ **Dubbing button** (DUBBING) 31
- ㊱ **Setup button** (SETUP) 7
- ㊲ **Audio button** (AUDIO) 25

Main unit

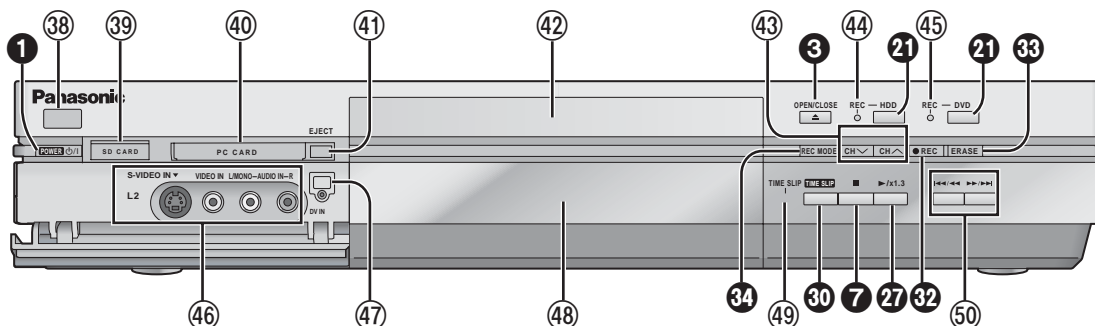

Controls such as ❶ function the same as the buttons on the remote control.

❶ Remote control signal sensor 6	❷ DVD record lamp 14
❸ SD card slot (SD CARD) 22	❸ L2 input terminals (L2) 60
❹ PC card slot (PC CARD) 22	❹ DV input terminal (DV IN) 60
❺ PC card eject button (EJECT) 22	❺ Display (→below)
❻ Disc tray 14	❻ Time slip indicator (TIME SLIP) 17
❼ Channel buttons for recorder (v, ^, CH) 14	❼ Skip/Slow/Search buttons (⏪/⏩, ⏮/⏭) 20
❽ HDD record lamp 14	

The unit's display

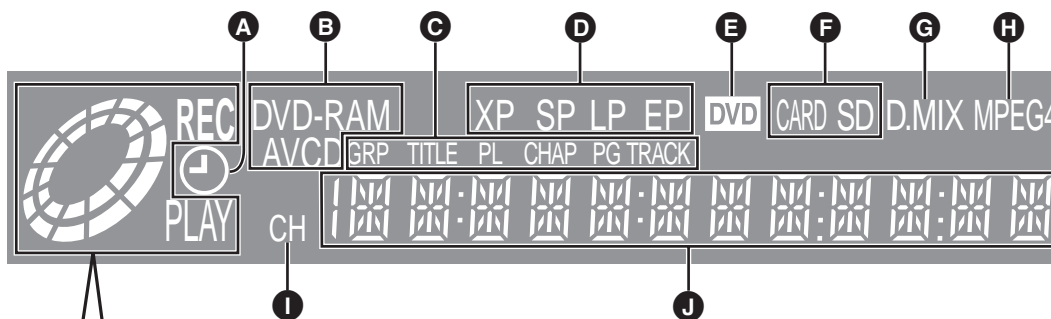

Center circle (e.g., DVD-RAM)

Rotating (REC): recording
Stopped (REC): recording paused



Rotating (REC, PLAY):

Chasing play or simultaneous rec and play is in progress



Rotating (PLAY):

playing
Stopped (PLAY): play paused
"PLAY" flashes:
 the resume play function (→page 18) is working



A Timer recording display

On: When timer recording is on standby (→page 26)
Flashes: When the unit couldn't go to timer recording standby

B Disc type

C The display mode of the main display section

GRP: Group number
TITLE: Title number
PL: Play list number
CHAP: Chapter number
PG: Program number
TRACK: Track number

D Recording mode (→page 15)

E DVD indicator

Flashes: When you press [⏻, DVD POWER] to turn the unit off until it actually turns off

F SD/PC Card indicator

On: When a SD card or PC card is set in the unit (→page 22)

G Down-mix indicator

On: When a SD card or PC card is being read/written to
On: When multi-channel recorded DVD-Audio can be downmixed to 2 channels and output.

H MPEG4 indicator

On: SD VIDEO (MPEG 4) format recordable (→page 14)

I Channel

J Main display section

Recording and play counter, and other miscellaneous messages

Recording television programs

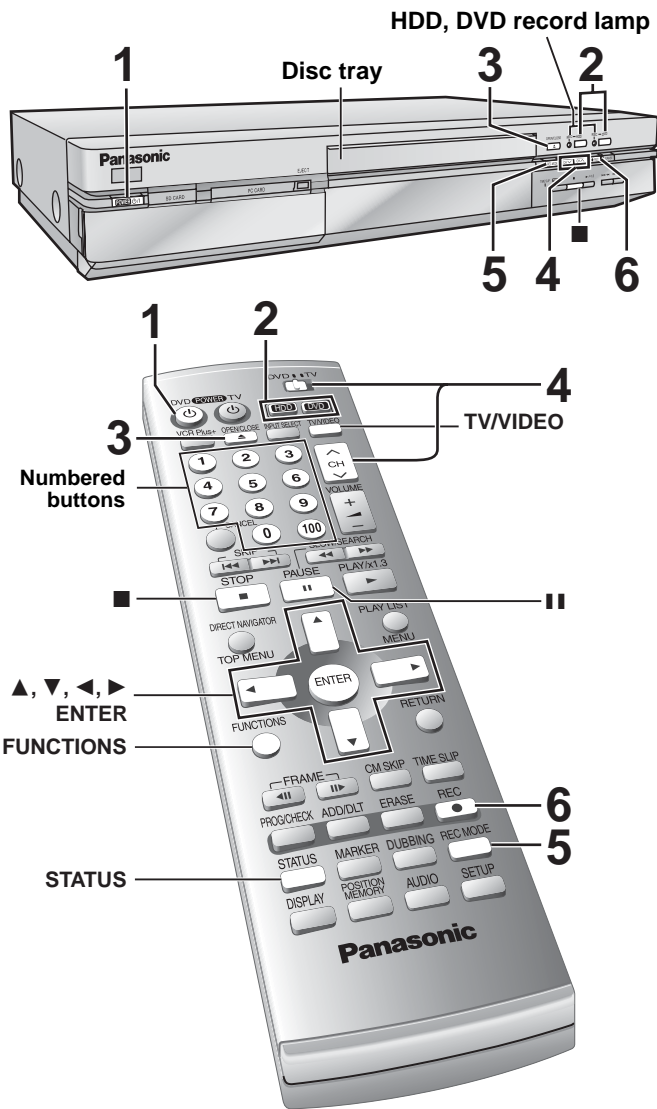

[HDD] [RAM] [DVD-R]

- 1 Press [⏻, DVD POWER] to turn the unit on.
- 2 Press [HDD] or [DVD] to select the recording drive.

The HDD or DVD button lights up on the unit.

- It is not possible to record to both HDD (Hard Disk Drive) and DVD drive simultaneously.

- 3 If you selected the DVD drive Press [▲ OPEN/CLOSE] to open the tray and insert a disc (→ left).

• Press the button again to close the tray.

- It is not possible to record continuously from one side of a double sided disc to the other. You will need to eject the disc and turn it over.

- If you put a disc in while the HDD is selected, the DVD button on the unit will flash while the unit reads the disc.

- 4 Ensure [DVD, TV] is switched to “DVD” and press [▲, ▼, CH] to select the channel.

e.g.,
when you select
channel 4



- 5 Press [REC MODE] to select the recording mode (→ next page).

e.g.,
when you
select “XP”

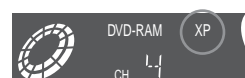

- When dubbing a program recorded with the high speed mode to a DVD-R, set “Rec in DVD-R high speed mode” to “On” before recording. (→page 52) [HDD]

- To record sound using LPCM (XP mode only):

From the SETUP menu, set the “Audio Mode for XP Recording” setting to “LPCM” (the picture quality may go down slightly). (→page 53)

- 6 Press [●, REC] to start recording.

The HDD or DVD record lamp on the main unit lights up.

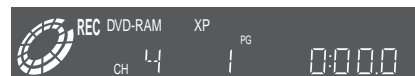

- Recording will be made over unrecorded space on the HDD or on the disc. Data will not be overwritten.

- Program information (e.g., time and date) is registered in the program list (→page 19, Using the Direct Navigator).

[DVD-R]

To play DVD-R on compatible equipment, finalize it (→page 44).

Inserting discs

You can insert a cartridge or non-cartridge disc.

Non-cartridge disc

Insert label-up. Insert completely.

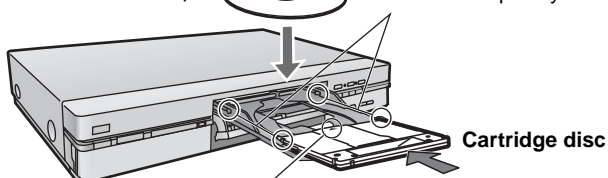

Insert label-up with the arrow facing in.

Cartridge disc

[Note]

- Load double-sided discs so the label for the side you want to record/play is facing up.
- When using 8 cm (3”) DVD-RAM, remove the disc from the cartridge and insert it, making sure you align it with the groove.

Should the AC power supply cord come loose by accident or for any other reason the power supply is cut off while recording or editing is taking place, the contents of the HDD or disc may be lost.

Auto power-off

The unit switches to standby after about 6 hours in the stop mode. You can turn this feature off or change the time to 2 hours (→page 51, Set Up—Off Timer).

To stop recording

Press [■].

To pause recording

Press [⏸]. Press again to continue recording. (Program is not split into a separate program.)

■ Enjoying SD VIDEO (MPEG4) programs [HDD]

When you set the “MPEG4 Rec mode” (→page 52) to either “SF”, “F”, “N”, or “E” before recording to the HDD, you can also simultaneously record programs as SD VIDEO (MPEG4) programs during recording. When dubbing the simultaneously recorded SD VIDEO (MPEG4) programs, you can dub to a SD card using high speed mode (→page 31).

- Set the “SD card capacity” (→page 52) to match the capacity of your SD card. Programs are divided according to the set capacity. Programs are also divided when you pause or stop during recording.
- You cannot directly record to a SD card.
- Audio of the SD VIDEO (MPEG4) programs becomes monaural. When recording SAP broadcasts, press [AUDIO] to select the audio for recording.
- The video is recorded in a 4:3 aspect irrespective of the video signal input.

[Note]

- You can record while the unit is on standby for timer recording, but once the time for the timer recording to begin is reached, any recording taking place will stop and the timer recording will begin.
- You cannot change the channel or recording mode during recording.
- Release protection (cartridge →page 10, disc →page 44) when you record. [RAM]
- When using a DVD-RAM for the first time with this unit, format it to ensure accurate recording (→page 44, "Format").
- There are limitations when recording to DVD-R (→page 10).
- Select "Main" or "SAP" from "Select MTS" in the Audio menu when recording SAP broadcasts based on the following conditions (→page 53, Select MTS).
 - Recording to a DVD-R.
 - Recording sound in LPCM.
 - When "Rec in DVD-R high speed mode" (→page 52) is set to "On".

For your reference

- You can record up to 250 programs on HDD, 99 programs on one disc.
- This unit is compatible with the **Content Protection for Recordable Media (CPRM →page 62)** system so you can record broadcasts that allow one copy, such as some CATV broadcasts, onto 4.7 GB/9.4 GB DVD-RAM (these are CPRM compatible). It is not possible to record onto DVD-R or 2.8 GB DVD-RAM.
- It is possible to watch playback from one drive while recording from another (editing is not possible).

Recording modes and approximate recording times in hours

Mode	Disc HDD (120GB)	DVD-RAM		DVD-R (4.7 GB)
		Single-sided (4.7 GB)	Double-sided (9.4 GB)	
XP (High quality)	26*	1	2	1
SP (Normal)	52*	2	4	2
LP (Long play)	104*	4	8	4
EP (Extra long play)	160*	6	12	6

Values for recordings immediately after purchase. Recording times may change depending on the recording content.

*Recording times will be shortened when you set the "MPEG4 Rec mode" (→page 52) to either "SF", "F", "N", or "E".

FR (Flexible Recording Mode) (→right)

The unit automatically selects a recording rate between XP and EP that will enable the recordings to fit in the available recording time on the disc with the best possible recording quality.

- You can set for dubbing (→page 30) or timer recording (→page 26).
- When dubbing content stored on the HDD, the contents are automatically adjusted to fit on 4.7 GB DVD-RAM/R discs.
- All the recording modes from XP to EP appear in the display.

Recording/Dubbing/Transferring of a program

This unit incorporates copyright protection technology for recording equipment known as CPRM (→page 62).

Refer to the table below for storage media and associated limits.

No recording limit		
Record →	HDD	Dub → RAM DVD-R ^{*3} SD ^{*4}
Record →	RAM	Dub → HDD SD ^{*4}
Record →	DVD-R	Dub → ❌ You cannot dub.
Recording limited to one time ^{*5}		
Record →	HDD	Transfer → ^{*6} RAM
Record →	RAM	Dub → ❌ You can dub to the HDD but cannot play due to copyright protection.
Record →	❌ DVD-R	You cannot record.
Recording not possible		
❌ You cannot record/dub on any media.		

*¹You can dub in high speed mode to DVD-R by turning "Rec in DVD-R high speed mode" (→page 52) to "On" at recording.

*²You can simultaneously record programs as SD VIDEO (MPEG4) programs by setting the "MPEG4 Rec mode" (→page 52) to either "SF", "F", "N", or "E". Approximately 10 seconds of the first part of a simultaneously recorded SD VIDEO (MPEG4) program may not be recorded when recording a program without recording limitations right after recording a program with limitations.

*³Excluding SD VIDEO (MPEG4) programs

*⁴Only SD VIDEO (MPEG4) programs

*⁵You cannot record or dub programs with limitations as SD VIDEO (MPEG4) programs.

*⁶**Transfer:** All recorded content transferred to DVD-RAM is deleted from the HDD.

Almost all videos and DVD software on sale have been treated to prevent illegal copying. Any software that has been so treated cannot be recorded using this unit.

Watching the television while recording

Pictures being recorded are unaffected.

Switch [DVD, TV] to "TV".

- ① Press [TV/VIDEO] to change the television's input mode to "TV".
- ② Press [∧, ∨, CH] to change channels.
 - You can also select the channel with the numbered buttons.

Recording the best quality pictures within the set amount of time—Flexible Recording

[HDD] [RAM] [DVD-R]

The unit calculates a recording rate that enables the recording to fit in the time you set (within the remaining time on the disc) and with the best possible picture quality.

- 1 Press [∧, ∨, CH] to select the channel.
- 2 While stopped Press [FUNCTIONS].
- 3 Press [▲, ▼, ◀, ▶] to select "FLEXIBLE REC" and then [ENTER].
- 4 Press [◀, ▶] to select "Hour" and "Min." and press [▲, ▼] to set the recording time.
 - You can also use the numbered buttons to set the recording time.
- 5 Press [▲, ▼, ◀, ▶] to select "Start" and press [ENTER]. Recording starts.

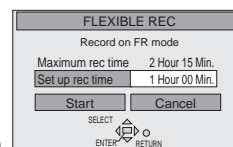
**To show the remaining time**

Press [STATUS].

[Note]

- This does not work with DV Automatic Recording (→page 16).
- You cannot record more than 6 hours.
- It may not be possible to record to the end of the program if the remaining time doesn't allow.

For your reference

- Recording time is reduced if you repeatedly pause recording.
- The recording mode automatically becomes FR mode.

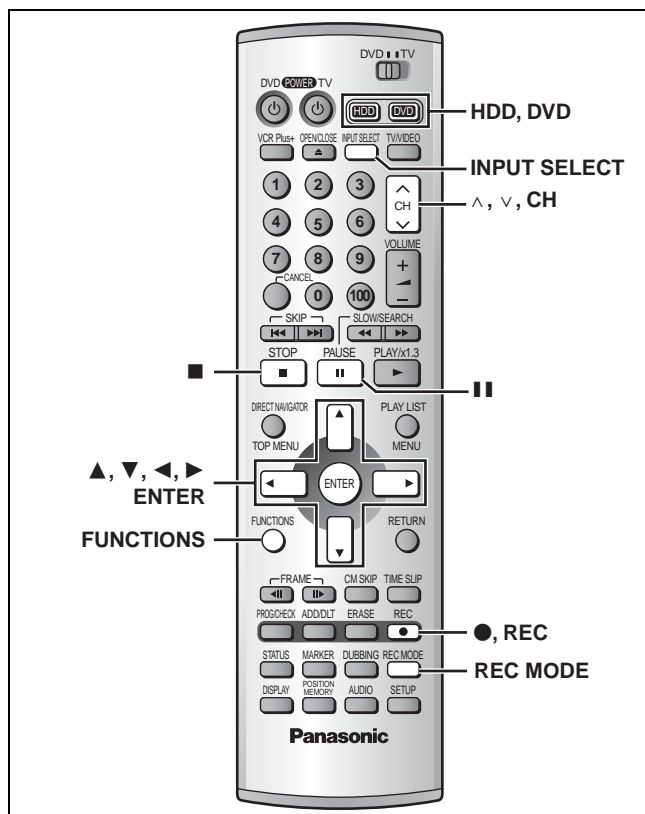

Recording from a video cassette recorder

[HDD] [RAM] [DVD-R]

Preparation

- Connect a video cassette recorder to this unit's input terminals (→page 60).
- Press [HDD] or [DVD] to select the recording drive.

- 1 **While stopped**
Press [INPUT SELECT] to select the input channel for the equipment you have connected.
Select L1, L2, L3 or DV.
• You can also select the input channel by pressing [^, v, CH].
- 2 Press [REC MODE] to select the recording mode (XP, SP, LP or EP).
- 3 Start play on the other equipment.
- 4 Press [●, REC] at the point you want to start recording.
Recording starts.

To skip unwanted parts

Press [■] to pause recording. (Press again to continue recording.)

To stop recording

Press [■].

[Note]

- When recording using L1, L2 or L3 terminals, only the sound received at the time of recording will be recorded.
- The audio recorded through the DV Input terminal is the audio selected in the "Select Audio CH for DV input" (→page 53).
- If flexible recording (→page 15) is used instead of steps 2 and 4, settings can be made so that recording continues to the end of the video.

DV Automatic Recording (DV AUTO REC)

[HDD] [RAM]

Automatic generation of programs and play lists is possible for using the "DV AUTO REC" function when connecting DV equipment (e.g., Digital Video Camcorders) to the DV input terminal on the front of the unit with the DV cable.

Preparation

1. Turn off the main unit and DV equipment, then connect the equipment with the unit's DV input terminal. (→page 60)
2. Turn on the main unit and DV equipment.
3. Pause play of the DV equipment at the point you want recording to start.
4. Press [HDD] or [DVD] to select the recording drive.

- 1 **While stopped**
Press [FUNCTIONS].
The FUNCTIONS window appears (→page 50).
- 2 Press [▲, ▼, ◀, ▶] to select "DV AUTO REC" and then [ENTER].
DV AUTO REC screen appears.
- 3 Press [REC MODE] to select the recording mode (XP, SP, LP or EP).
- 4 Press [◀, ▶] to select "Rec" and then [ENTER].
Recording starts.



When recording finishes

The confirmation screen appears. Press [ENTER] to finish DV auto recording.

To stop recording

Press [■].

[Note]

- Select the type of audio recording from the Audio menu's "Select Audio CH for DV input" settings (→page 53).
- You cannot record SD VIDEO (MPEG4) programs using "DV AUTO REC".
- When "Cannot detect DV connection" is displayed or there is a recording problem, confirm the connections, DV equipment settings and reset the power.
If that does not work follow the instructions for "Recording from a video cassette recorder" (→left).
- It is not possible to carry out Chasing play or Simultaneous rec and play of the program that is being recorded.
- The DV equipment name may not be shown correctly.
- You cannot start recording until the images from the DV equipment appear on the television.
- Do not operate the DV equipment during recording, as this will cause recording to stop.
- Recording may not be performed as desired if the time codes on the tape in the DV equipment are not successive.
- During copying, a marker is automatically assigned to points in the original recording where recording was stopped or paused.
- The date and time information on the tape of the DV equipment will not be recorded.
- Depending on the equipment, the DV Automatic Recording may not operate properly.

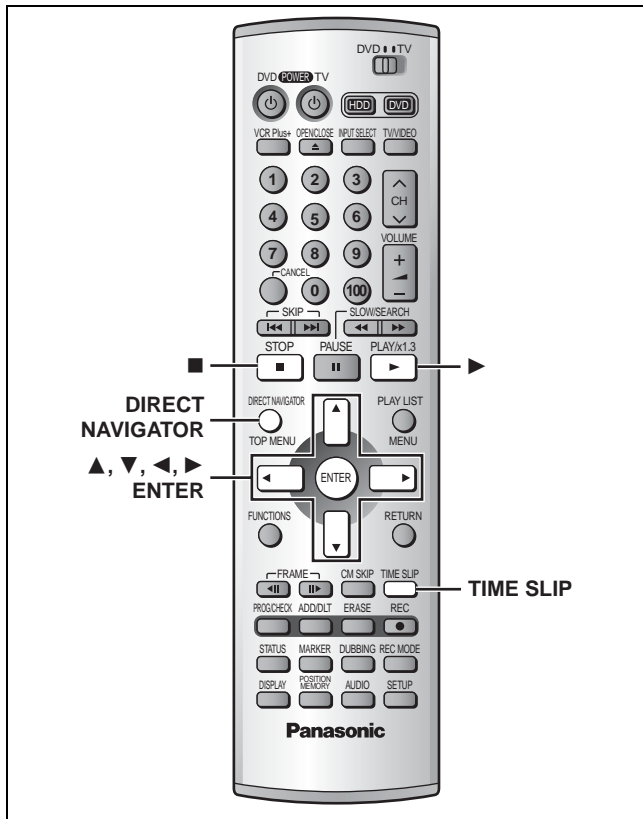

[HDD] [RAM]

Playing from the beginning of the program while you are recording—Chasing Play

During recording

Press **[▶] (PLAY)**.

Time slip indicator on the main unit lights.

Play starts from the beginning of the program being recorded.

e.g.,

You are recording a **sports program** and you want to watch it from the beginning.

The same **sports program** is played back from the beginning. (Recording continues.)

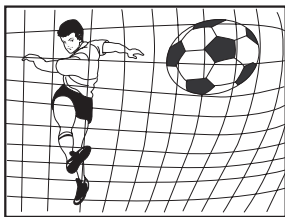

[Note]

Sound is not output while fast-forwarding.

The stop procedure in this box applies to all 3 scenarios on this page.

To stop play

Press **[■]**.

To stop recording

Wait 2 seconds after stopping play, then press **[■]**.

• To stop timer recording, press **[■]**, then **[ENTER]** within 5 seconds.

Simultaneous rec and play

While recording, you can play a program previously recorded.

1 During recording

Press **[DIRECT NAVIGATOR]**.

Time slip indicator on the main unit lights.

2 Press [▲, ▼] to select a program and press [ENTER].

e.g.,

You want to watch the movie you recorded yesterday while recording a sport program.

The movie is played back while the sport program is being recorded.

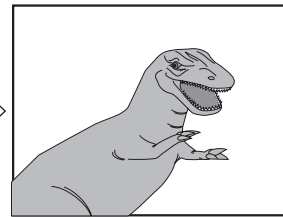
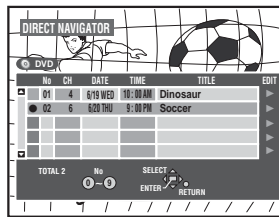

[Note]

- Sound is not output while fast-forwarding.
- You cannot edit programs (→page 36) during simultaneous rec and play.

Reviewing the recorded images while recording—Time Slip

You can play the program being recorded to check that it is being recorded correctly. You can also check parts that were recorded previously.

1 During recording

Press **[TIME SLIP]**.

Time slip indicator on the main unit lights.

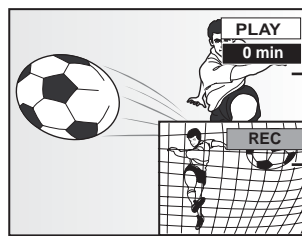

Play starts from 30 seconds previous.

The current recording images appear as a picture-in-picture.

- You will hear the playback audio.
- Press **[DIRECT NAVIGATOR]** to select another program.

2 Press [▲, ▼] to enter the time and press [ENTER].

- Press **[▲, ▼]** to alter in one-minute units. Press and hold **[▲, ▼]** to alter in 10-minute units.

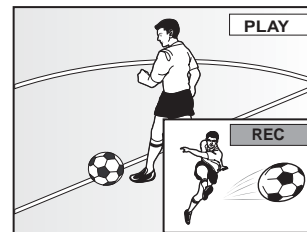

Press **[TIME SLIP]** to show the play images in full. Press again to show the play and recording images.

Note:

The recording and play images cannot be shown at the same time if you set "TV Type" to "480P" (...page 9)

Playing discs

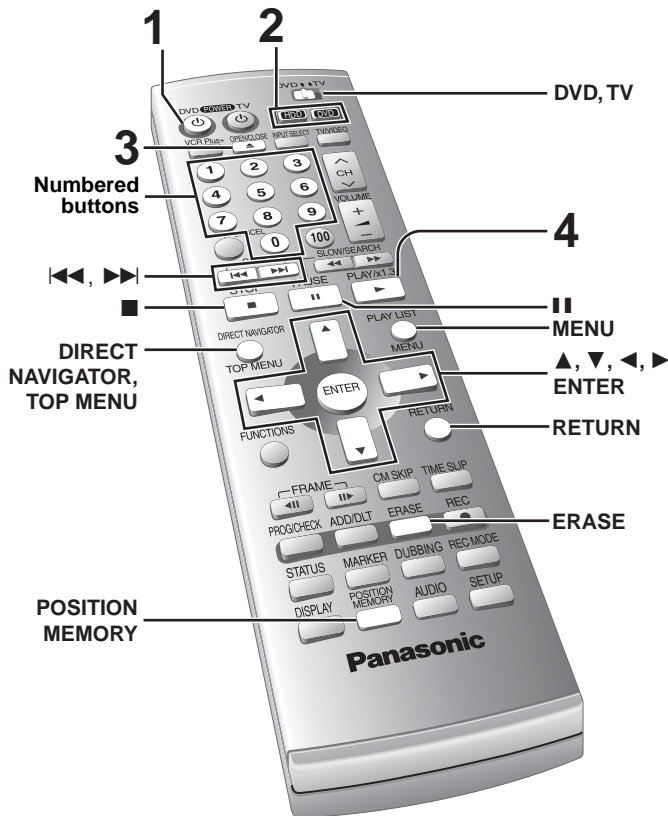
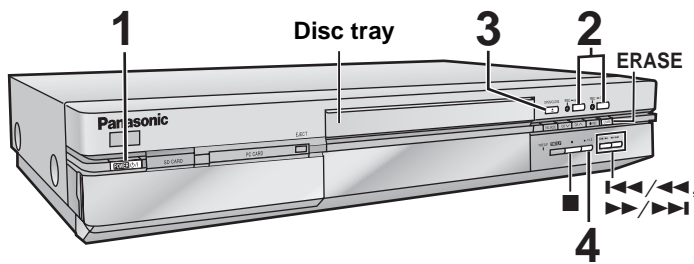

[HDD] [RAM] [DVD-R] [DVD-A] [DVD-V] [VCD] [CD] [MP3]

1 Press [⏻, DVD POWER] to turn the unit on.

2 Press [HDD] or [DVD] to select the playback drive.

The HDD or DVD button lights up on the unit.

- It is not possible to playback both HDD (Hard Disk Drive) and DVD drive simultaneously.

3 If you selected the DVD drive
Press [▲ OPEN/CLOSE] to open the tray and insert a disc (→page 14).

- Press the button again to close the tray.
- If cartridge protection is activated (→page 10), play begins automatically when you close the tray. [RAM]
- You cannot play continuously from one side of a double-sided disc to the other. Eject the disc and turn it over.
- If you put a disc in while the HDD is selected, the DVD button on the unit will flash while the unit reads the disc.

4 Press [▶] (PLAY).

The unit takes some time to read the disc before play starts. (When a menu screen appears on the television → next page)



- Play starts from the most recently recorded program. [HDD] [RAM] [DVD-R]
- Play starts from the beginning of the disc. [DVD-A] [DVD-V] [VCD] [CD] [MP3]

Playing back

To stop play

Press [■].

• Resume play function

When "PLAY" flashes on the display, resume function is active. Press [▶] (PLAY) to start play from where you stopped it.



To cancel, press [■] until "PLAY" goes out. (The position is also cleared when you turn the unit off or open the disc tray.)

- The screen saver may appear when you stop play. Press [■] again and you can use this unit's tuner to watch television.



To pause play

Press [⏸]. (Press again to restart play.)

Auto power-off

The unit switches to standby after about 6 hours in the stop mode. You can turn this feature off or change the time to 2 hours (→page 51, Set Up—Off Timer).

[Note]

- If you select another drive while playback is in progress, playback will be stopped. If using DVD-Video, the contents of the menu screen may be returned to their initial state.
- If a disc is loaded, the unit will come on and play will start when you press [▶] (PLAY).
- When you play a disc with an audio-only track, the video from the previous disc may continue to be shown on the television.
- Actual sound levels for DVD-Video are lower compared to television broadcast or playback of other discs. To avoid a sudden increase in volume level when switching from DVD-Video, reduce the volume setting before playing other sources or switching to television broadcast.
- When using this unit for the first time, the HDD has nothing recorded on it. You must record a program etc to the HDD before you can enjoy playback.

When a menu screen appears on the television

[VCD]

Switch [DVD, TV] to "DVD" and

Press the numbered buttons (0, 1–9) to select an item.

e.g., "5": [0] → [5]
"15": [1] → [5]

[DVD-A] [DVD-V]

Press [▲, ▼, ◀, ▶] to select an item and press [ENTER].

- You can also use the numbered buttons (0, 1–9) to select an item.

Other buttons used to operate menus

Read the disc's instructions for further details about operation.

[▶▶][▶▶/▶▶]: Shows the next menu.

[◀◀][◀◀/◀◀]: Shows the previous menu.

[RETURN]: Shows the menu screen. [VCD]

[TOP MENU]: Shows the first menu screen. [DVD-A] [DVD-V]

[MENU]: Shows the menu screen. [DVD-V]

[Note]

- Discs continue to rotate while menus are displayed. Press [■] when you have finished viewing to preserve the unit's motor and your television screen.
- If "⊘" appears on the television, the operation is prohibited by the unit or disc.
- Functions available vary from disc to disc.

Position Memory

[HDD] [RAM] [DVD-R] [DVD-A] [DVD-V] [VCD] [CD] [MP3]

(Effective only when the elapsed play time is displayed)

You can start play from a memorized position even after turning the unit off.

1 During play

Press [POSITION MEMORY].

The message "Position Memorized" appears on the television.

2 After switching the unit to standby and back on

Press [▶] (PLAY).

Play starts from the memorized position. (The position is cleared.)

[Note]

[DVD-R] [DVD-A] [DVD-V] [VCD] [CD] [MP3]

- The position is cleared when you open the disc tray. [RAM]
- Positions remain memorized even after the disc tray is opened.
- You cannot mark positions if the disc is write-protected. (cartridge →page 10, disc →page 44)

For your reference

If you press [■] before switching the unit to standby after pressing [POSITION MEMORY] to memorize a position, play will resume from the position you pressed [■] when you press [▶] (PLAY).

Using the Direct Navigator

[HDD] [RAM] [DVD-R]

A list of programs is created as you record them. You can use this list to find programs to watch.

1 Press [DIRECT NAVIGATOR]. e.g., DVD-RAM

The highlighted program plays in the background.

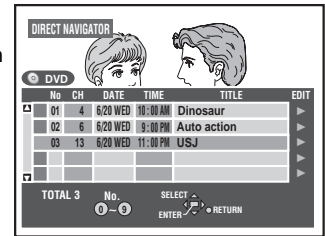

2 Press [▲, ▼] to select the program and press [ENTER].

- To select with the numbered buttons:

e.g., [HDD] [RAM] [DVD-R]
"5": [0] → [0] → [5] "5": [0] → [5]
"15": [0] → [1] → [5] "15": [1] → [5]

Play of the images that were playing in the background continues.

To stop play

Press [■].

To clear the program list

Press [DIRECT NAVIGATOR].

About the program list

Write-protected

Displayed when you have protected the program.

Copy-protected

Displayed when you have recorded a program that has copy protection, from CATV broadcasts, for example.

Unable to play

Displayed if you cannot play the program.

Currently recording

Displayed when the program is being recorded.

And more...

:Programs that have been rerouted to the HDD [HDD] (→page 27, Relief Recording)

:Programs that allow one copy [HDD]

No	CH	DA
01	4	6/20
02	6	6/20
03	13	6/20
04	2	6/21
05	8	6/22

TOTAL 5

To erase a program that is being played back

[HDD] [RAM] [DVD-R]

Since the program, any play lists (→page 32) created from it are erased irretrievably by this procedure, you should be certain you wish to erase before carrying it out.

1 Press [ERASE].

A confirmation screen will be displayed.

2 Press [◀, ▶] to select "Erase" and press [ENTER].

- On the main unit, press [◀◀/◀◀, ▶▶/▶▶] and [ENTER].

[Note]

- It is not possible to erase the program when you are carrying out chasing play, simultaneous rec and play or time slip play (→page 17). [HDD] [RAM]
- The amount of space remaining on the disc does not increase even if you erase programs. [DVD-R]
- If the confirmation screen disappears before you complete the operation, start from the beginning again.

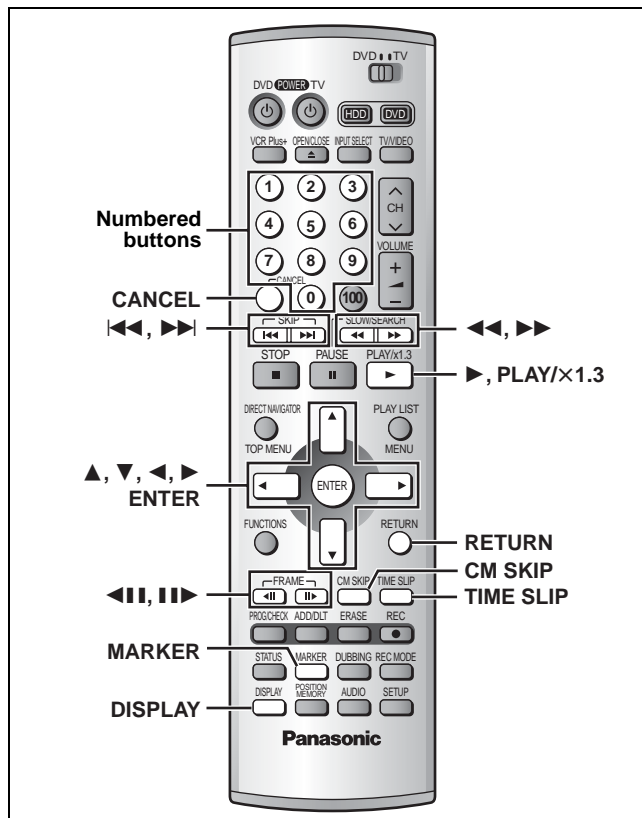

Skipping

[HDD] [RAM] [DVD-R] [DVD-A] [DVD-V] [VCD] [CD] [MP3]

During play or while paused

Press [**⏮**] or [**⏭**].

- Press [**⏮**] or [**⏭**] on the main unit.
- Each press increases the number of skips.

DVD-A **DVD-V** **VCD** **CD** **MP3**

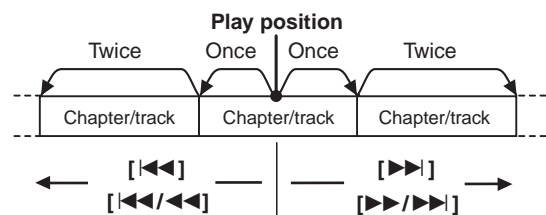

HDD **RAM** **DVD-R**

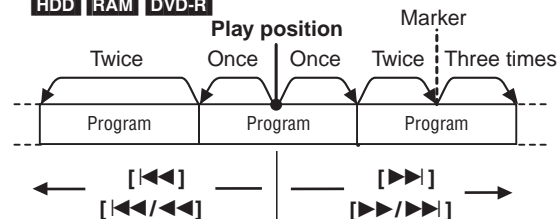

For your reference

Pressing [**⏮**] [**⏮**] or [**⏭**] [**⏭**] while the playback control feature on Video CDs (→page 62) is working may take you to a menu screen.

Slow-motion play

[HDD] [RAM] [DVD-R] [DVD-A] (Motion picture parts only) [DVD-V] [VCD]

While paused

Press [**⏮**] or [**⏭**].

Press and hold [**⏮**] or [**⏭**] on the main unit.

[Note]

- The speed increases up to 5 steps.
- Press [**▶**] (PLAY) to restart play.
- Backward ([**⏮**] [**⏮**]) does not work with Video CDs.
- The unit will pause if slow-motion play is continued for 5 minutes.

Frame-by-frame viewing

[HDD] [RAM] [DVD-R] [DVD-A] (Motion picture parts only) [DVD-V] [VCD]

While paused

Press [**⏮**] or [**⏭**].

[Note]

- Each press shows the next frame.
- Press [**▶**] (PLAY) to restart play.
- Cursor buttons [**⏪**, **▶**] are also effective while paused for frame-by-frame viewing.
- Backward ([**⏮**]) does not work with Video CDs.

Fast forward and rewind—SEARCH

[HDD] [RAM] [DVD-R] [DVD-A] [DVD-V] [VCD] [CD] [MP3]

During play

Press [**⏮**] or [**⏭**].

• Press and hold [**⏮**] or [**⏭**] on the main unit.

[Note]

- The speed increases up to 5 steps.
- Press [**▶**] (PLAY) to restart play.
- Audio is heard only while using first level fast forward [other than DVD-Audio (excluding moving picture parts), CD, MP3]. You can turn this audio off if you want to (→page 52, PLAY ×1.3 & Audio during Search).

Starting play from a selected item

[HDD] [RAM] [DVD-R] [DVD-A] [DVD-V] [VCD] [CD] [MP3]

During play

Press the numbered buttons to select the item.

e.g., "5": [0] → [5] [HDD] [MP3] "5": [0] → [0] → [5]
 "15": [1] → [5] "15": [0] → [1] → [5]

[Note]

- This may not work with some discs.
- This works only when stopped with some discs (the screen saver is on the television).
- A group ([DVD-A]) or title ([DVD-V]) number can be specified while the screen saver is displayed.

e.g., [DVD-A] "5": [5]
 [DVD-V] "5": [0] → [5]

– **Playing bonus groups** [DVD-A]

Some discs contain bonus groups. If a password screen appears after selecting a group, enter the password with the numbered buttons and press [ENTER]. Refer also to the disc's jacket.



Skiping a minute forward—CM Skip

[HDD] [RAM] [DVD-R]

Play restarts from approximately a minute later. Convenient when you want to skip commercials etc.

During play

Press [CM SKIP].

[Note]

If the start of the next program is within one minute of the point you skipped from, play restarts from the beginning of that program.

Selecting an amount of time to skip—Time Slip

[HDD] [RAM] [DVD-R]

- 1 During play
Press [TIME SLIP].

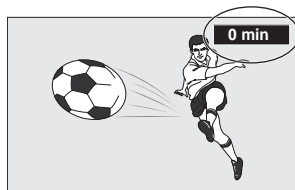

- 2 Within 5 seconds
Press [▲, ▼] to enter the time and then press [ENTER].

e.g., Go back to 5 minutes



Press to alter in one-minute units. Press and hold to alter in 10-minute units.

Quick View

[HDD] [RAM] (Only with Dolby Digital)

You can increase the speed of play without disrupting the soundtrack.

During play

Press and hold [▶] (PLAY/ ×1.3).

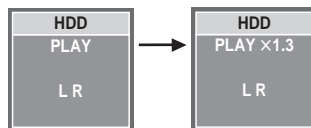

To return to normal speed

Press [▶] (PLAY/×1.3).

[Note]

- Output is in PCM when using a digital connection (→page 59, [A]).
- This is canceled when you perform skip, pause or when play reaches a point where a program recorded in sound other than Dolby Digital starts.
- This does not work if the setting is “Off” in “PLAY ×1.3 & Audio during Search” (→page 52).
- This does not work when recording in XP or FR mode. [RAM]

Marking places to play again—MARKER

You can mark positions by pressing [MARKER]. Also use on-screen menus to mark, recall, and clear positions.

[HDD] [RAM] [DVD-R]

Mark up to 999 positions. The unit records the markers directly onto the disc and they remain intact even if you remove the disc.

[DVD-A] [DVD-V] [VCD] [CD] [MP3]

Mark up to 5 positions. The markers clear when you open the disc tray.

Marking positions directly

During play

Press [MARKER].

One marker is added.



Using on-screen menus to mark positions

- 1 During play
Press [DISPLAY].
The on-screen menus appear.
- 2 Press [▲, ▼] to select “Play” and press [▶].

e.g., DVD-RAM



- 3 Press [▲, ▼] to select “Marker” and press [▶] to highlight the first asterisk (*).

[HDD] [RAM] [DVD-R]

[DVD-A] [DVD-V] [VCD] [CD] [MP3]



- 4 Press [◀, ▶] to select an asterisk (*) and press [ENTER].

One marker is added.

When marking positions 11 and above

[HDD] [RAM] [DVD-R]

- ① Press [◀, ▶] to highlight “1-10”. 
- ② Press [▲, ▼] to select “11-20”.
You can select the next group of 10 when the current group is full.
- ③ Press [▶].
The first asterisk is highlighted.
- ④ Press [ENTER] to mark a position.

To recall a marker

Press [◀, ▶] to select a marker number and press [ENTER].

- Play starts from the marked position.

To clear markers

Press [◀, ▶] to select a marker number and press [CANCEL].

- An asterisk replaces the number and the position is cleared.

To clear the on-screen menus

Press [RETURN].

[Note]

- You cannot use this feature if:
 - the disc’s elapsed play time is not shown in the display.
 - you are using a play list. [HDD] [RAM]
 - protection (cartridge →page 10, disc →page 44) is set (you can still recall the markers to play a position). [RAM]
- Subtitles around markers may fail to appear.
- Markers are cleared when you finalize DVD-R (→page 44).
- Markers on HDD, DVD-RAM and DVD-R are ordered by time, so marker numbers can change when you add and delete them.

[HDD] [RAM] [SD] [CARD]

Inserting/Removing the SD/PC card

Only insert or remove the SD/PC card after turning the unit off. When the card indicator ("SD" or "CARD") on the unit display is flashing, the card is being read from or written to. Do not turn off the power or remove the card. Such action may result in malfunction or loss of the card's contents.

SD card slot

Inserting the card

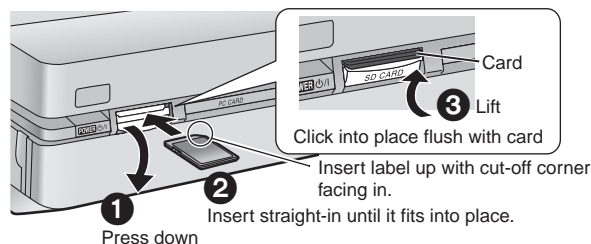

Removing the card

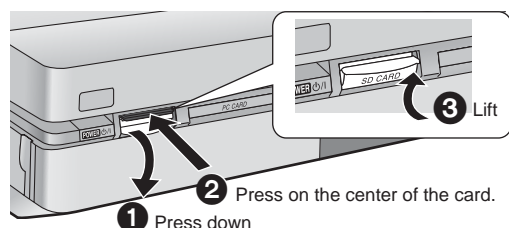

PC card slot

Inserting the card

There are cards requiring adapters (→page 11).

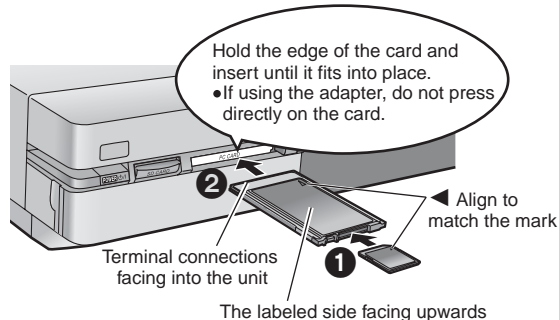

Removing the card

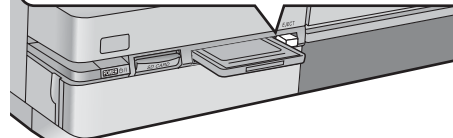
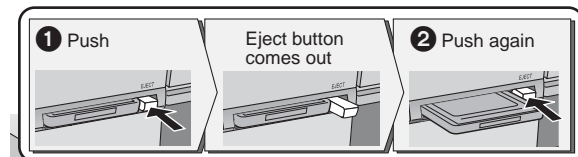

- If using the adapter, remove the adapter and card together.
- If the eject button does not come out
To remove the card, press the card in once more and then repeat steps 1-2.
- It is not possible to open the disc tray while the still pictures/SD VIDEO (MPEG4) programs screen is displayed.

- SD logo is a trademark.
- Portions of this product are protected under copyright law and are provided under license by ARIS/SOLANA/4C.

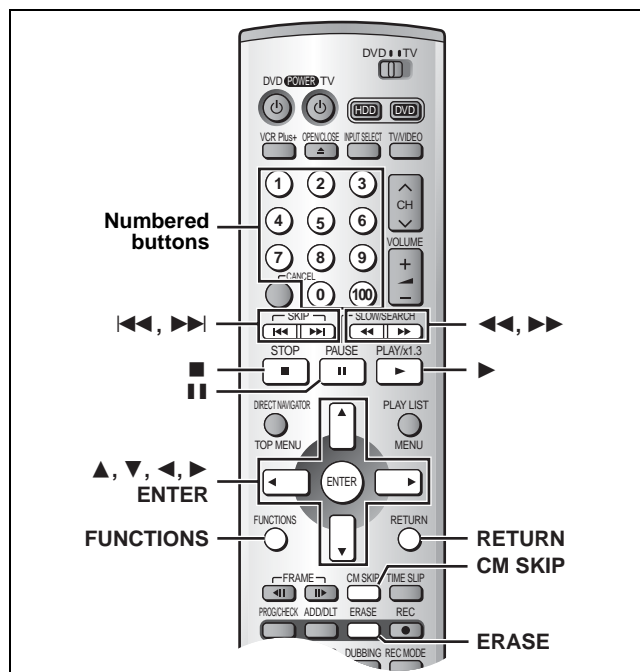

- 1 While stopped
Press [FUNCTIONS].
The FUNCTIONS window appears (→page 50).
- 2 Press [▲, ▼, ◀, ▶] to select "JPEG" to play still pictures or "SD VIDEO (MPEG4)" to play SD VIDEO (MPEG4) programs and press [ENTER].
- 3 Press [▲, ▼] to select "INPUT" and press [ENTER].
- 4 •JPEG
A list of the folders in the drive appears.
Press [▲, ▼] to select the folder and press [ENTER].
To select another drive, press [◀] and [▲, ▼] to select and press [▶].
•SD VIDEO (MPEG4)
Press [▲, ▼] to select the drive and press [ENTER].
When there are folders not displayed, use [◀◀], [▶▶] to switch between them.

To display still pictures (Album Display)

- 5 Press [▲, ▼] to select "Album" and press [ENTER].
A list of the still pictures in the folder appears.
- If there are more than 9 still pictures, press [▲, ▼, ◀, ▶] to select "Next" and press [ENTER]. Select "Prev." to move back.
 - To select a page of still pictures with the numbered buttons:
e.g., "5": [0] → [0] → [5]
"15": [0] → [1] → [5]

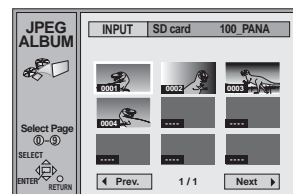

To display still pictures one by one

Press [▲, ▼, ◀, ▶] to select a still picture and then [ENTER].

To select the next or previous still picture

While in the still picture display, press [◀, ▶].

[◀]: previous still picture [▶]: next still picture

- The still picture changes every time the button is pressed.

To return to the previous screen

Press [RETURN].

To display still pictures one by one with constant interval (Slide Show)

5 Press [▲, ▼] to select “Slide Show” and press [ENTER].

The still pictures in the folder appear in numerical order.

To change the display timing

- ① After step 2 on the left page, press [▲, ▼] to select “Settings” and press [ENTER].
- ② Press [▲, ▼] to select “Slide Show”.
- ③ Press [◀, ▶] to select the desired timing between still pictures (0 – 30 seconds) (in base units of 1 second).
- ④ Press [ENTER].

To select the next or previous still picture

While in still picture display, press [◀, ▶].

[◀]: previous still picture [▶]: next still picture

- The still picture changes every time the button is pressed.

To return to the previous screen

Press [RETURN].

To play SD VIDEO (MPEG4) programs

5 Press [▲, ▼] to select “Play” and press [ENTER].

Displayed icons

- X** : Programs that cannot be played
- X** : Programs without audio

e.g., SD Card

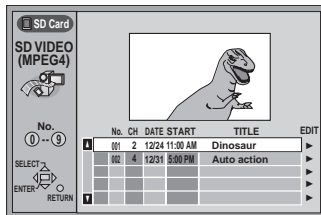

6 Press [▲, ▼] to select a program and press [ENTER].

- To select with the numbered buttons:

e.g., “5”: [0]→[0]→[5] “15”: [0]→[1]→[5]

To return to the previous screen

Press [RETURN].

To stop

Press [■].

To pause

Press [■].

To skip programs

Press [◀◀] or [▶▶].

To skip a minute forward

Press [CM SKIP].

To search the point to play

Press [◀◀] or [▶▶] during play (3 steps). (Play pauses and only the displayed time advances.)

Press [▶] (PLAY) to restart play.

To display the on-screen display

Press [STATUS].

[Note]

- Video on this unit’s display is expanded to fit an aspect ratio of (320 × 240) dots and may be different from the aspect ratio of the original video or may cause the edges of the video to be cut off.
- The recorded date and time display may be different.

To erase a still picture or a SD VIDEO (MPEG4) program

(Still pictures and programs are erased irretrievably by this procedure.)

During play or while in still picture display

- ① Press [ERASE].
- ② Press [◀, ▶] to select “Erase” and press [ENTER].

To rotate the still picture

While in still picture display

- ① Press [ENTER].
- ② Press [▲, ▼] to select “Rotate RIGHT” or “Rotate LEFT” and press [ENTER].

- The still picture as a whole is rotated.

- Rotation information will not be stored.

To display information about the still pictures

While in still picture display, press [ENTER].

(Date, “folder number” - “file number” and number of still pictures are displayed.)

To give a title to a still picture folder

After selecting the still picture’s folder in step 4 on the left page, press [▶] to select “Folder Title” and press [ENTER]. (→page 46, Entering text):

- Titles inputted using this unit will not be displayed on other equipment.

Folder structure

The following can be displayed on this unit. e.g.,

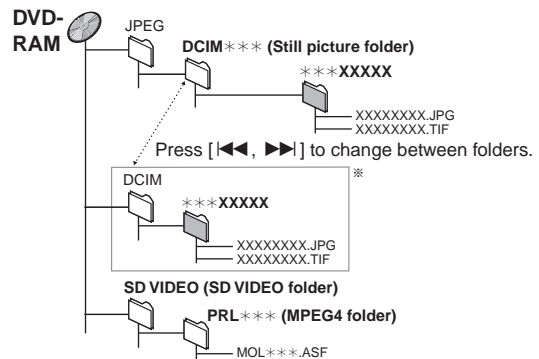
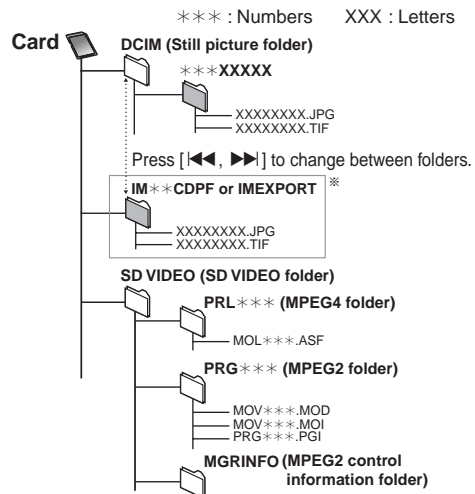

* Folders can be created on other equipment. However, these folders cannot be selected as a copy destination.

- The folder cannot be displayed if the numbers are all “0” (e.g., DCIM000 etc).

- Files and folders that were created on equipment other than this unit may not display properly or play.

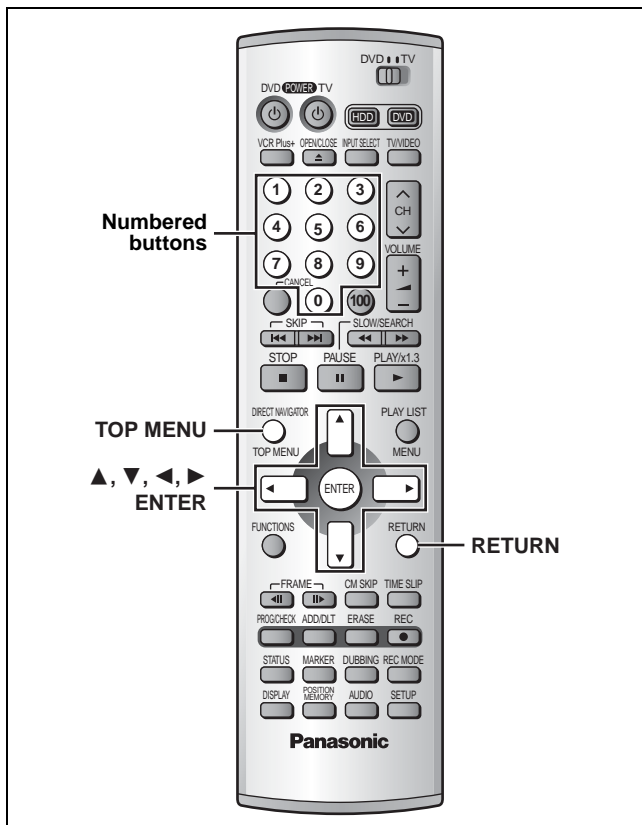

[MP3]

This unit can play MP3 files recorded on CD-R/RW with a computer. Files are treated as tracks and folders are treated as groups.

1 Press [TOP MENU].

Selected group number and name

G: Group no.

T: Track no. in the group

TOTAL: Selected track no./
Total track no. in all groups

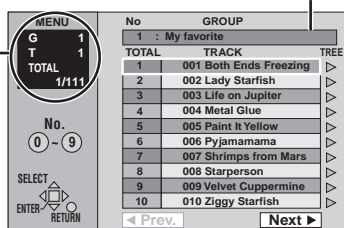

2 Press [▲, ▼] to select the track and press [ENTER].

Play continues to the last track in the last group.

• “▶” indicates the track currently playing.

• To select with the numbered buttons:

e.g., “5”: [0] → [0] → [5]

“15”: [0] → [1] → [5]

To show other pages

Press [▲, ▼, ◀, ▶] to select “Prev.” or “Next” and press [ENTER]. After listing all the tracks in one group, the list for the next group appears.

To exit the file list

Press [TOP MENU].

Using the tree screen to find a group

1 While the file list is displayed Press [▶] to display the tree screen.

Selected group no. /Total group no.

• If the group has no track, “- -” is displayed as group number.

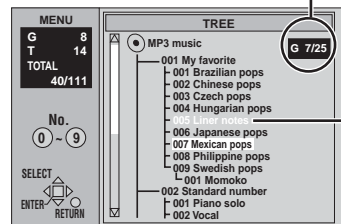

You cannot select groups that contain no compatible files.

2 Press [▲, ▼, ◀, ▶] to select a group and press [ENTER].

The file list for the group appears.

To return to the file list

Press [RETURN].

[Note]

- Discs must conform to ISO9660 level 1 or 2 (except for extended formats).
- This unit is compatible with multi-session but if there are a lot of sessions it takes more time for play to start. Keep the number of sessions to a minimum to avoid this.
- If you play a MP3 track that includes still picture data, it will take some time before the music itself starts playing and the elapsed time will not be displayed during this time. Even after the track starts, the correct play time will not be displayed.
- This unit is not compatible with ID3 tags or packet writing.
- Depending on recording some items may not be playable.
- Compatible sampling rate: 16, 22.05, 24, 32, 44.1 and 48 kHz

Compatible compression rate: between 32 kbps and 320 kbps
Maximum number of tracks and groups recognizable: 999 tracks and 99 groups

Naming folders and files

• MP3 files must have the extension e.g., “.MP3” or “.mp3”.

• At the time of recording, give folder and file names a 3-digit numeric prefix in the order you want them to play (this may not work at times).

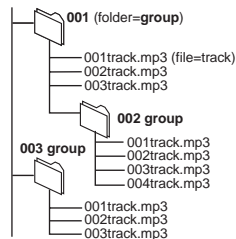

MPEG Layer-3 audio decoding technology licensed from Fraunhofer IIS and Thomson multimedia.

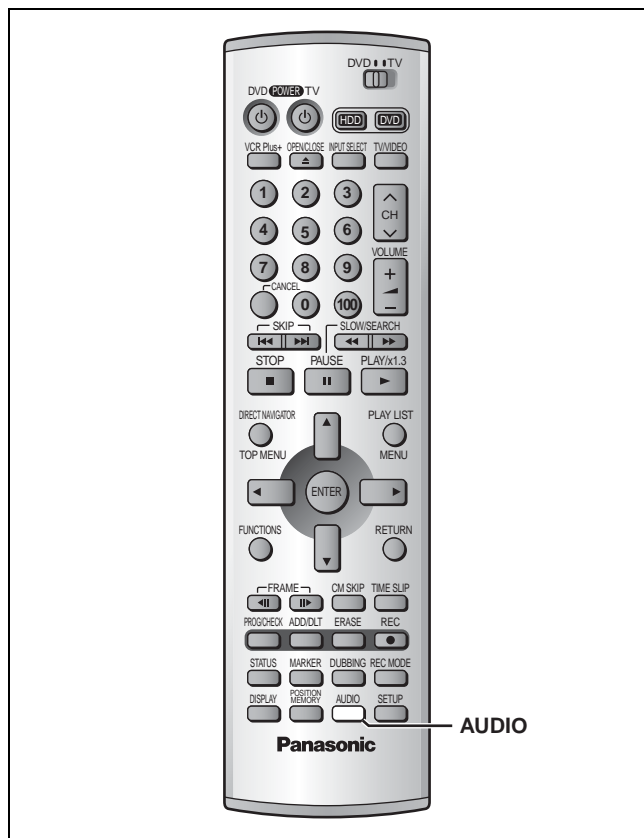

[HDD] [RAM] [DVD-A] [DVD-V] [VCD]
 You can change the audio being received or played.

Press [AUDIO].

How the type changes depends on when you press the button.

■ While receiving MTS audio (Multi-channel Television Sound Stereo)

- **Stereo:** Main audio (stereo)
- ↓
- **SAP:** Secondary audio program (SAP)
- ↓
- **Mono:** Main audio (monaural)

- If the broadcast is "Mono + SAP", audio will be monaural even if you select Stereo mode.
- Select "Mono" if reception is poor during a stereo broadcast.

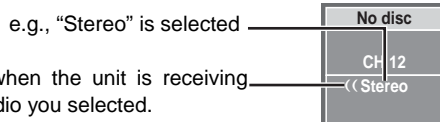

[Note]

- If you change the sound setting while recording, the recorded sound will also change. [HDD] [RAM]
 - It will not be possible to alter the sound by pressing [AUDIO] in the following cases:
 - When the DVD drive is selected and a DVD-R is in the disc tray.
 - When recording mode is XP and "LPCM" has been selected in the Audio menu, "Audio Mode for XP Recording" (→page 53).
 - When "Rec in DVD-R high speed mode" is set to "On" (→page 52).
- Select "Main" or "SAP" from "Select MTS" in the Audio menu when recording SAP broadcasts based on the above conditions (→page 53, Select MTS).
- If recorded in SAP mode, main audio is also recorded.

■ While playing HDD, DVD-RAM or Video CD

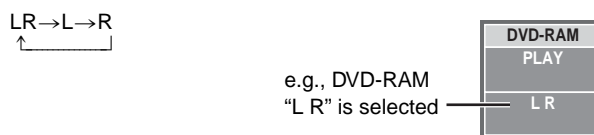

- If it is a recording of an SAP broadcast, each time you press [AUDIO]: [HDD] [RAM]
 MAIN↔SAP

For your reference

You can change the audio for the full images being played with simultaneous rec and play and Time Slip. [HDD] [RAM]

■ While playing DVD-Audio or DVD-Video

You can change the audio channel number each time you press the button. This allows you to change things like the soundtrack language.



e.g., [DVD-V] English is the selected language.

[Note]

[HDD] [RAM]

You may be unable to change the audio when you have connected the unit to an AV receiver through the DIGITAL AUDIO OUT terminal and "Dolby Digital" is set to "Bitstream". If this occurs:
 – Change "Dolby Digital" to "PCM" (→page 53), or
 – Connect also with an audio cable (→page 59, [B]) and change the input on the receiver.

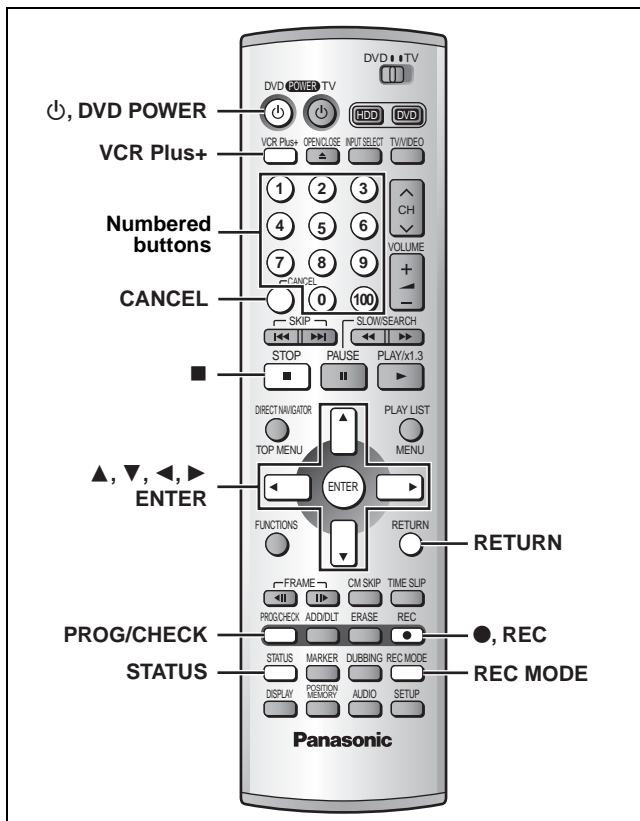

[HDD] [RAM] [DVD-R]

Specify a time to stop recording

This is a simple way of specifying a time to stop recording when you are in a hurry or before you go to bed.

During recording

Press **[●, REC]** to select the recording time.

Each time you press the button:

e.g.,
 0:30 → 1:00 → 1:30 → 2:00 → 3:00
 ← Counter (cancel) ← 4:00 ←



To show the remaining time

Press **[STATUS]**.

For your reference

- This does not work with timer recordings or Flexible Recording (→page 15).
- Recording stops and the set time is cleared if you press **[■]**.
- The set time is cleared if you change the recording mode or channel while recording is paused.

Preparation

- Set the clock and guide channels for VCR Plus+ recording (→page 8) correctly.
- Release protection (cartridge →page 10, disc →page 44) before proceeding. [RAM]

Using VCR Plus+ codes to make timer recordings

Entering VCR Plus+ codes is an easy way of programming the unit for recording. You can find these codes in newspapers and magazines. You can enter up to 32 programs up to a month in advance.

1 Press [VCR Plus+].

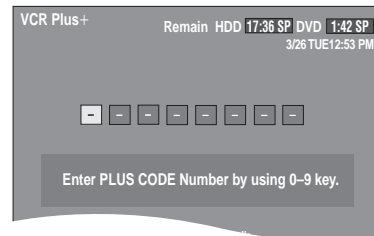

2 Press the numbered buttons to enter the VCR Plus+ code.

Press **[◀]** to move back to correct a digit.

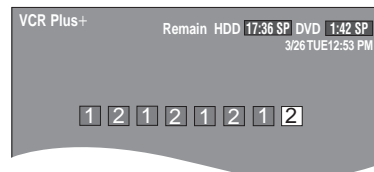

3 Press [ENTER].

Confirm the program and make corrections if necessary using **[▲, ▼, ◀, ▶]**.

- "Invalid Entry" is displayed when you enter the wrong code. Reenter the code.
- To change the recording mode Press **[REC MODE]**.
- To enter the title of the program Press **[◀, ▶]** to select "Enter Title" and press **[ENTER]** (→page 46).

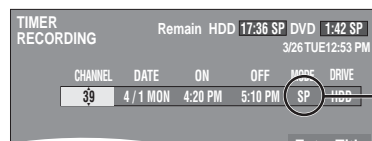

The current recording mode (shown on the unit's display) is automatically selected.

When you press **[ENTER]**

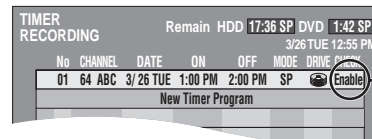

Displayed if the recording can fit in the remaining space on the HDD or disc.

Repeat steps 1–3 to program other recordings.

4 Press [RETURN].

The timer recording list disappears and the unit enters Timer Recording standby mode ("Ⓞ" appears on the unit display).

- The unit is not off. To save power, turn the unit off by pressing **[⏻, DVD POWER]**.

Manually programming timer recordings

You can enter up to 32 programs up to a month in advance. Each daily or weekly program is counted as one program.

1 Press [PROG/CHECK].

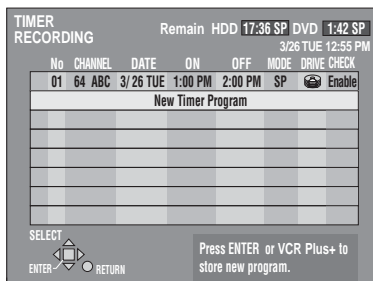

2 Press [▲, ▼] to select “New Timer Program” and press [ENTER].

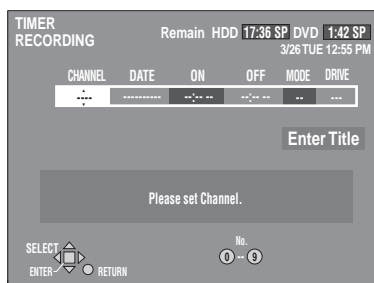

3 Press [▶] to move through the items and change the items with [▲, ▼].

- The current settings are shown each time you press [▶].
- You may use the numbered buttons to enter the CHANNEL, DATE, ON (start Time), and OFF (Finish Time).

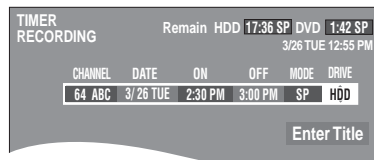

- **CHANNEL (Channel number and caption)**
- **DATE**

→Current date
 ↓ ↑
 Next day up to one month later minus one day
 ↓ ↑
 Weekly timer: SUN-SAT → MON-SAT → MON-FRI
 ↓ ↑
 →Daily timer: WEEKLY SUN → ---- → WEEKLY SAT

- **ON (Start time)/OFF (Finish time)**
 The time increases or decreases in 30-minute increments if you hold the button.
- **MODE (Recording mode →page 15)**
 SP → XP → FR → EP → LP (→Return to SP)
- **DRIVE**
 HDD ↔ DVD
- **RENEW (→page 28, Auto Renewal Recording)**
 Only when you set daily or weekly recording onto HDD
 –You cannot set if “MPEG4 Rec mode” (→page 52) is set to either “SF”, “F”, “N”, or “E”.
 ON ↔ OFF
- **Enter Title**
 Select “Enter Title” using [◀, ▶] and press [ENTER] (→page 46).

4 Press [ENTER] when you have finished programming the timer.

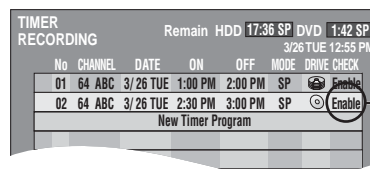

Displayed if the recording can fit in the remaining space on the disc.

- Press [▲, ▼] to select “New Timer Program” and repeat steps 2- 4 to program other recordings.

5 Press [PROG/CHECK] or [RETURN].

The timer recording list disappears and the unit enters Timer Recording standby mode (“Ⓢ” appears on the unit display).

- The unit is not off. To save power, turn the unit off by pressing [⏻, DVD POWER].

To release the unit from recording standby

Cancel all the timer recording programs using [CANCEL] (→page 29).

To cancel recording when recording has already begun

Press [■], then [ENTER] within 5 seconds on the remote. Recording stops.

[Note]

- When the program timer reaches the set time when in recording standby mode, timer recording will start even if the unit is playing or recording another program.
- The actual time recorded may be longer than the program itself when television programs are recorded using VCR Plus+.
- If you don't select a recording mode when using VCR Plus+ codes to make a timer recording, the unit sets the mode selected on the unit at that time (unless the mode is “XP”, in which case the unit sets “FR” as the mode).
- “All timer programs are occupied.” appears if there are already 32 programs.
- The remaining time displayed is based on the current recording mode.
- When you program successive timer recordings to start immediately one after the other, the unit cannot record the part at the beginning of the later programs (a few seconds when recording with HDD or DVD-RAM, and approximately 30 seconds when recording with DVD-R).
- If you set DST (Daylight Saving Time) to ON when manually setting the clock (→page 55), timer recording may not work when summer switches to winter and vice versa.
- “Ⓢ” flashes when the unit couldn't go to timer recording standby.
- When timer recording starts, the record lamp (→page 13, Main unit) lights, even if the unit is off.

Relief Recording

When the recording drive is set to “DVD” for timer recording, the unit will automatically evaluate if the program will fit onto the disc before beginning recording. If the program will not fit then the recording drive will be altered to “HDD” automatically.

- If the time remaining on the HDD is insufficient, as much of the program as possible will be recorded onto the HDD.
- If there is no disc in the tray or the disc cannot be recorded on, the recording drive will be altered to HDD.
- The recording mode will not be altered.
- The Direct Navigator shows which programs were relief-recorded (→page 19).

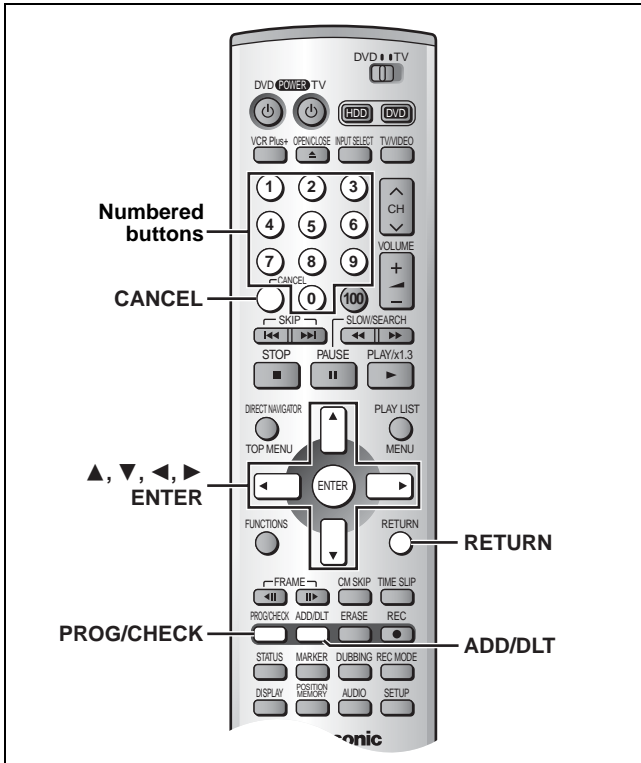

Auto Renewal Recording

[HDD]

If you record a program onto HDD repeatedly everyday or every week using timer recording, the unit will record the new program over the old one.

This function can be used only when weekly recording or daily recording is selected for "DATE".

- You cannot set if "MPEG4 Rec mode" (→page 52) is set to either "SF", "F", "N", or "E".

- 1 While the timer recording list (→page 27, step 4) is displayed Press **[▲, ▼]** to select the program and then **[ENTER]**.

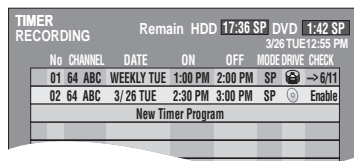

- 2 Press **[◀, ▶]** to select "RENEW".



- 3 Press **[▲, ▼]** to select "ON" and then **[ENTER]**.

The timer recording list reappears.

[Note]

- If a program set for Auto Renewal Recording is protected, the program will not be overwritten. Instead the program set for recording will be saved as a separate program, and this program will be the one to be overwritten when the next Auto Renewal Recording takes place.
- When play back is taking place from the HDD, auto renewal recording will not be carried out. The program supposed to be auto renewal recorded will be recorded as a separate program.
- Play list scenes made from programs that were set for Auto Renewal Recording are erased along with auto renewal.
- When there is not enough space on the HDD, the program may not be recorded completely (even if repeating a renewal recording).

Check programs

[HDD] [RAM] [DVD-R]

- 1 Press **[PROG/CHECK]**.

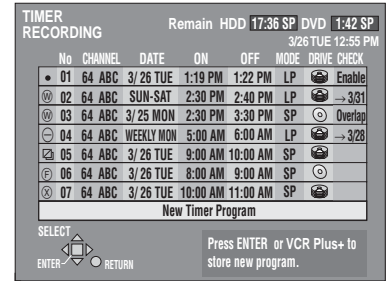

Icon explanations

- The times overlap those in another program. Note the following if times overlap:
 - The program with the earlier start time receives priority.
 - Recording of the program with the later start time starts when the earlier program finishes recording.
 - If you make two programs with the same start time, the one you programmed last receives priority.
- You stopped recording of a weekly or daily timer recording. The icon disappears the next time the timer starts recording.
- This program is currently recording.
- The disc was full or the maximum number of programs or scenes was reached so the program failed to record.
- The material was copy-prohibited so it was not recorded.
- The program did not complete recording because the disc is dirty or some other reason.
- Programs that failed to record are displayed gray. They are automatically deleted from the timer recording list at 4 a.m. two days later.

Auto Renewal Recording indicator [HDD]

The program will be automatically recorded over in succession.

Relief Recording indicator

Programs that have been rerouted to the HDD because of insufficient space.

Recording drive indicator

HDD DVD

Message displayed in the CHECK line

Some of the information shown in the CHECK line may not be correct while you are recording.

Enable: Displayed if the recording can fit in the remaining space on the disc.

→ **(Date):** For recordings made daily or weekly, the display will show as long as recordings can be made (up to a maximum of one month from the present time) based on the time remaining on the disc.

! : It may not be possible to record because of write protection, because there is no more space left or because the number of possible programs has reached its maximum. Please check the HDD and disc.

- 2 Press **[PROG/CHECK]** or **[RETURN]**.

The timer recording list disappears.

Change or cancel the program

[HDD] [RAM] [DVD-R]

- 1 Press [PROG/CHECK].**
The timer recording list appears.
- 2 Press [▲, ▼] to select the program.**
 - To select with the numbered buttons:
e.g., "5": [0] → [5]
"15": [1] → [5]
 - Press [◀, ▶] to skip down several programs on the list.
- 3 Press [CANCEL] or [ADD/DLT] to delete, or press [ENTER] to change.**
You cannot delete programs that are currently recording.
The timer recording setting screen appears.
- 4 If you pressed [ENTER] in step 3, Move through the items with [◀, ▶] and change the settings with [▲, ▼] and press [ENTER].**
- 5 Press [PROG/CHECK] or [RETURN].**
The timer recording list disappears.

[Note]

- During timer recording, you can change the end time as long as the recording mode is not "FR".
- Even when the power is off, you can display the timer recording list by pressing [PROG/CHECK].

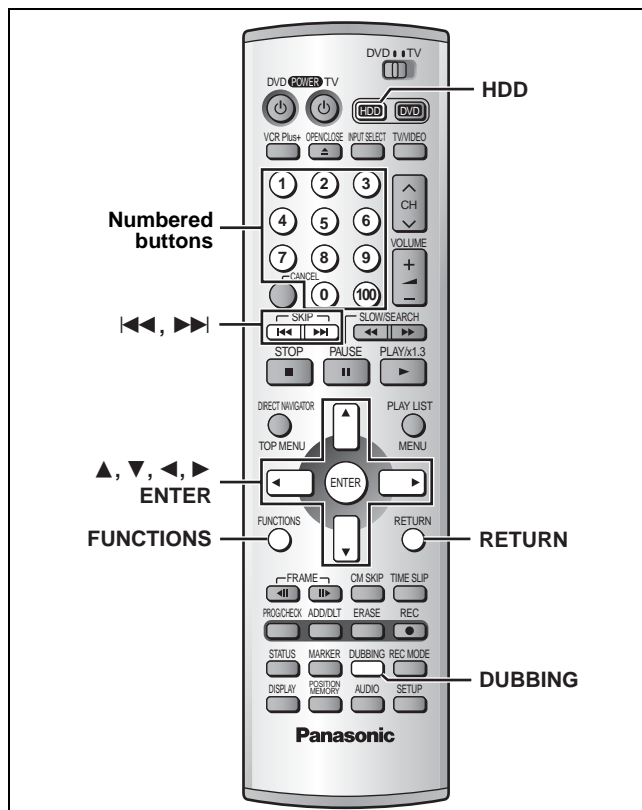

[HDD] [RAM] [DVD-R] [SD] [CARD] (Mobile hard disk only)

- It is possible to dub a program or play list to another drive.
- Dubbing a play list will create a program.
- You can dub a maximum of 250 programs to HDD and 99 programs to DVD-RAM or DVD-R.
- You can dub a maximum of 999 SD VIDEO (MPEG4) programs.
- You can high speed dub. Using a high speed compatible DVD-R allows you to dub in an even shorter amount of time.
- You can use the Direct Navigator to play SD VIDEO (MPEG2) recorded on future releases of Panasonic video cameras by using the "High Speed (MPEG2)" mode for dubbing.
- Refer to page 15 for details about storage media and associated limits.

Preparation

Press [HDD] to select HDD drive.

- 1 While stopped
Press [FUNCTIONS].
- 2 Press [▲, ▼, ◀, ▶] to select "DUBBING" and press [ENTER].
e.g., Dubbing from HDD to DVD-RAM

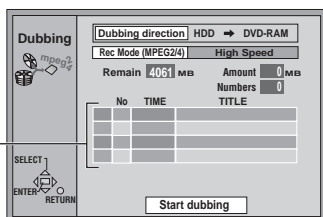
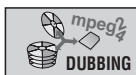

3 Select the dubbing direction.

- 1 While selecting "Dubbing direction" Press [ENTER].
- 2 Press [▲, ▼] to select the original drive and press [ENTER].
- 3 Press [▲, ▼] to select the destination drive and press [ENTER].
• Only valid dubbing directions are displayed.

4 Select the recording mode.

- (→next page, Dubbing direction and recording mode)
- 1 Press [▲, ▼] to select "Rec Mode (MPEG2/4)" and press [ENTER].
 - 2 Press [▲, ▼] to select the recording mode and press [ENTER].
• Only valid recording modes are displayed.

5 Select items for dubbing.

- 1 Press [▲, ▼] to select the dubbing list table and press [ENTER].

Display on the dubbing list

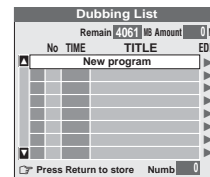

- ➡: "Transfer" because of recording limitation (→page 15)
- ⚠: Program or play list contains still picture(s)
– Still picture(s) cannot be dubbed.
– You cannot convert to a SD VIDEO (MPEG4) program.
- 🎥: Program recorded with the "Rec in DVD-R high speed mode" setting (→page 52) "On" and play lists created from that program.
"🎥" does not appear for the following programs and play lists.
– Play lists created from programs using a variety of recording modes
– Play lists created from multiple programs using "FR" recording mode
– Play lists mixed with a variety of audio types (Dolby Digital and LPCM, etc.)
– Programs that contain repeatedly erased segments
- 📁: Program with recording limitations
– Programs with recording limitations are transferred without dubbing. Note that programs will not be transferred if they are protected.
– Programs with recording limitations and play lists cannot be registered on the same dubbing list.
– You cannot select play lists when the play list was created from a program containing a recording limitation.

"Estimated destination storage":

Percentage of SD VIDEO (MPEG4) program space for dubbing proportionate to the amount of blank space on the destination drive.

- 2 Press [▲, ▼] to select "New program" and press [ENTER].

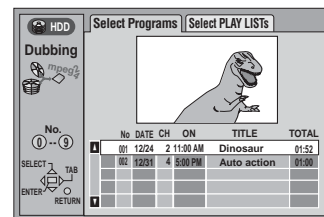

- 3 Press [◀, ▶] to select "Select Programs" or "Select PLAY LISTS".
- 4 Press [▲, ▼] to select the program or play list for dubbing and press [ENTER].
• Repeat steps 5-2 to 5-4 to register more than one. [Make sure "Remain" on the dubbing list is greater than "Amount". Dubbing will not begin if "Amount" is larger than "Remain". (Excluding when "MPEG2 to 4" mode is selected)]
• To select with the numbered buttons:
e.g., "5": [0] → [5], To select a program on HDD:
"15": [1] → [5] "5": [0] → [0] → [5]
- 5 Press [RETURN].
Return to step 2.

6 While the screen in step 2 is displayed Press [▲, ▼] to select "Start dubbing" and press [ENTER].

The confirmation screen will be displayed.
Press [◀, ▶] to select "Yes" and press [ENTER] to start dubbing.

To stop dubbing

Press and hold [RETURN] for 3 seconds.

- If stopped partway, dubbing will be up to that point. However, in high speed mode, only programs that have completed dubbing at the point stopped are dubbed. (Remaining disc space will be reduced once you have recorded/dubbed to DVD-R.)

To add or remove from the dubbing list

While the Dubbing List (→ step 5-①) is displayed

- ① Press [▲], [▼] to select the dubbing list and press [▶].
- ② Press [▲], [▼] to select an item and press [ENTER].
 - If you select “Add”, carry out steps 5-③ and 5-④. Addition will take place above the program selected in step ①.
 - If you select “Erase” or “Erase All”, a confirmation screen will be displayed. Press [◀], [▶] to select “Yes” or “No” and press [ENTER] (Return to Dubbing List).

[Note]

- Dubbing list's content will be erased in the following cases.
 - If the power is turned off or the original disc is ejected. (Nothing is erased if the power is turned off when dubbing from the HDD).
 - Erasing an original program or play list.
 - When the SD VIDEO (MPEG4) program is erased on the original drive or when recording or dubbing SD VIDEO (MPEG4) programs on the original drive.
- When dubbing using the “MPEG2 to 4” mode, the displayed “Remain” value is calculated using video segments that contain the most information. You may be able to dub even if “Amount” has exceeded “Remain” when video images do not change rapidly.
- Regarding the time until dubbing ends (High Speed mode)
 - You can high speed dub Dolby Digital audio programs. LPCM audio programs take about the same amount of dubbing time.
 - The current progress indicator is corrected each time the program being dubbed changes.
 - When there are programs mixed with LPCM audio and Dolby Digital audio, the dubbing time display may fluctuate significantly.
 - When dubbing SD VIDEO (MPEG4) programs, the time display may fluctuate.
- It is not possible to activate timer recording during dubbing.
- Title information etc. is dubbed as is. However, when using “MPEG2 to 4” mode, protect settings are not dubbed. Markers are only dubbed if you use “High Speed” dubbing mode.
- Select the audio format for recording SAP broadcast from “Select MTS” in the setup menu (→ page 53, Audio) when:
 - Dubbing to a DVD-R.
 - Dubbing sound in LPCM.
 - Dubbing programs in “MPEG2 to 4” mode.
- Use [◀▶], [▶▶] to switch between folders when there are other folders on the mobile hard disc which are not displayable on screen.

One Touch Dubbing

[HDD] → [RAM] [DVD-R]

You can dub programs and play lists being played from the HDD to a DVD-RAM, DVD-R.

[HDD] [RAM] → [SD]

You can dub SD VIDEO (MPEG4) programs being played from the HDD or DVD-RAM to a card.

- 1** During play or while paused
Press [DUBBING].

The confirmation screen appears.

- 2** Press [◀, ▶] to select “Yes” and press [ENTER].

To stop dubbing

Press and hold [RETURN] for 3 seconds.

- If stopped partway, dubbing will be up to that point. However, in high speed mode, only programs that have completed dubbing at the point stopped are dubbed. (Remaining disc space will be reduced once you have recorded/dubbed to DVD-R.)

[Note]

- This function works even while the program list or play list screen is being displayed.
- It is not possible to activate timer recording during dubbing.
- Programs with recording limitations (including play lists made from those programs) cannot be dubbed.

The recording mode is set as follows:

- High speed mode:
 - When dubbing to a DVD-RAM.
 - When the programs recorded with “Rec in DVD-R high speed mode” (→page 52) set to “On” and play lists created from that programs are being dubbed to a DVD-R.
 - When dubbing a SD VIDEO (MPEG4) program to a card.
- Original dubbing mode:
 - When the programs recorded with “Rec in DVD-R high speed mode” set to “Off” is being dubbed to a DVD-R.
- FR (Flexible Recording) (→page 15):
 - Based on the above conditions, the mode automatically changes to FR when there is not enough room left on the disc.
 - When dubbing play lists created from the programs recorded with “Rec in DVD-R high speed mode” set to “Off” to a DVD-R.

Dubbing direction and recording mode

Dubbing direction		Recording mode				
		High Speed* ¹	XP-EP, FR	High Speed (MPEG4)	High Speed (MPEG2)	MPEG2 to 4* ¹ * ²
HDD	→ RAM	○	○	○	×	×
	→ DVD-R	○* ³	○	×	×	×
	→ SD	×	×	○	×	○
RAM	→ HDD	○	×	○	×	×
	→ SD	×	×	○	×	○
SD CARD	→ HDD	×	×	○	○	×
	→ RAM	×	×	○	○	×

*¹Refer to the approximate recording times. (→below)

*²You cannot select this mode if “MPEG4 Rec mode” (→page 52) is set to “Off”.

*³You cannot select the high speed mode when dubbing programs or play lists from the HDD to a DVD-R that do not display the “▶▶▶”.

- You will not be able to obtain better picture quality of the original picture even if you select a higher quality picture mode than the original. (Only prevents picture degradation.)

Approximate recording times

(h: hours, m: minutes)

■ Approximate SD card capacity and dubbing capacity for SD VIDEO (MPEG4) programs

- Using a Panasonic SD Memory Card.
- You cannot dub a program utilizing the maximum capacity of the card due to the additional recording of copyright information etc.
- The first value indicates video with non-rapid movement, the second value indicates rapid movement.

Capacity	Recording mode			
	SF (Super fine)	F (Fine)	N (Normal)	E (Economy)
8 MB	1 m	2 m	4 m	9 m
	1 m	2 m	3 m	8 m
16 MB	2 m	5 m	9 m	20 m
	2 m	4 m	6 m	19 m
32 MB	5 m	10 m	18 m	43 m
	4 m	9 m	13 m	41 m
64 MB	10 m	21 m	38 m	1 h 28 m
	8 m	19 m	28 m	1 h 24 m
128 MB	21 m	43 m	1 h 18 m	2 h 58 m
	16 m	40 m	57 m	2 h 50 m
256 MB	42 m	1 h 26 m	2 h 36m	5 h 56 m
	32 m	1 h 19 m	1h 53 m	5 h 40 m
512 MB	1 h 24 m	2 h 55 m	5 h 16 m	11 h 57m
	1 h 5 m	2 h 40 m	3 h 49 m	11 h 26 m
1 GB	2 h 43 m	5 h 37 m	10 h 7 m	23 h 0 m
	2 h 6 m	5 h 9 m	7 h 21 m	21 h 59 m
2 GB	5 h 26 m	11 h 14 m	20 h 15 m	46 h 1m
	4 h 12 m	10 h 19 m	14 h 42 m	43 h 59 m

■ When dubbing programs using high speed mode to a high speed recording compatible DVD-R

- When dubbing a Dolby Digital audio recording to 1×–4× high speed recording compatible disc.

Recording mode and recording time	Required time	Speed
1 hour of recorded video using XP mode	15 minutes	4×
2 hours of recorded video using SP mode		8×
4 hours of recorded video using LP mode		16×
6 hours of recorded video using EP mode		24×

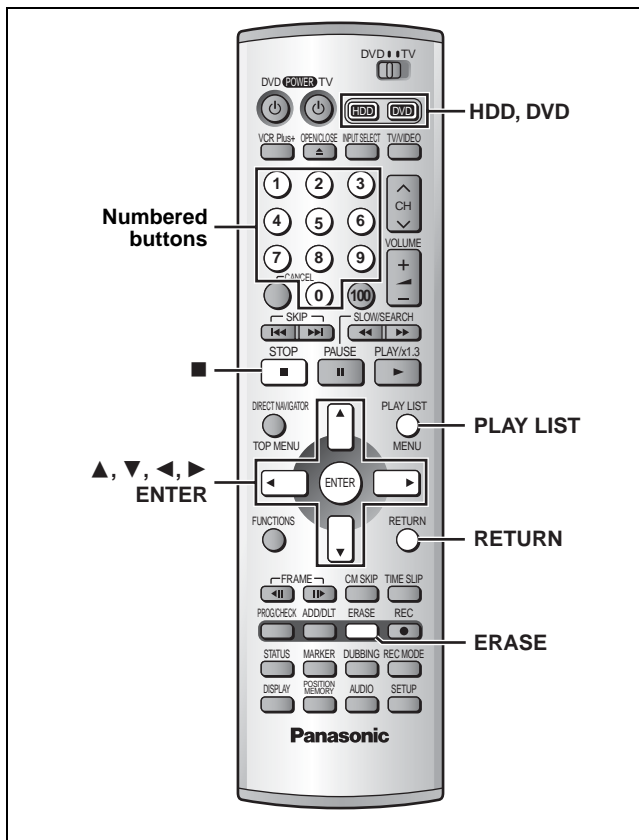

[HDD] [RAM]

Specify start and end points to create scenes, then specify the order in which they are to be played. These scenes are not recorded separately so this doesn't use much capacity.

You can create a maximum of 99 play lists and 999 scenes on a DVD-RAM and HDD.

Preparation

- Release protection (cartridge →page 10, disc →page 44) before proceeding.
- Press [HDD] or [DVD] to select the drive.

1 While stopped
Press [PLAY LIST].

2 Press [▲, ▼] to select “Create PLAY LIST” and press [ENTER].

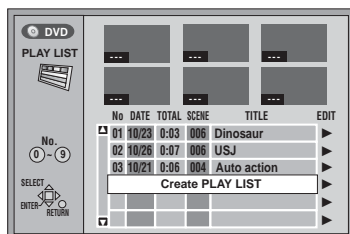

3 Press [ENTER] at the start point.

HDD: The location of the whole program's start point

DVD-RAM: The location of the whole disc's start point

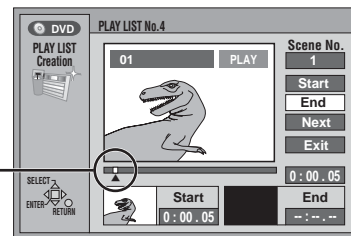

- You can use basic functions like fast forwarding/rewinding and slow-motion play (→page 20).
- You can use the skip function to jump to another program (→page 20).

4 Press [ENTER] at the end point.

HDD: The location of the whole program's end point

DVD-RAM: The location of the whole disc's end point

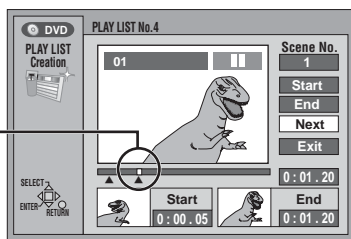

To specify another scene

Select “Next” and press [ENTER], then repeat steps 3 and 4.

5 Press [▲, ▼] to select “Exit” and press [ENTER].

The play list screen appears.

To clear the play list screen

Press [PLAY LIST].

To stop partway through

Press [RETURN].

[Note]

- You cannot specify an end point before a start point.
- You may not be able to specify points within 3 seconds of each other.
- Play pauses if the end of the last program on the disc is reached during this procedure.
- Depending on the state of recording, the actual number of play lists that can be recorded may be less than that specified in this manual.
- You can high speed dub play lists created from recorded programs to a DVD-R by switching “Rec in DVD-R high speed mode” to “On” excluding the following cases.
 - Play lists created from programs using a variety of recording modes.
 - Play lists created from multiple programs using “FR” recording mode.
 - Play lists mixed with a variety of audio types (Dolby Digital and LPCM, etc.)

Playing play lists

- 1 While stopped
Press [PLAY LIST].

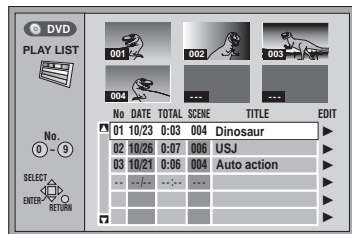

- 2 Press [▲, ▼] to select the play list and press [ENTER].

- To select with the numbered buttons:

e.g., "5": [0] → [5]

"15": [1] → [5]

All the scenes in the play list are played.

To stop play list play

Press [■]. (The play list appears.)

Playing play list scenes

- 1 While stopped
Press [PLAY LIST].
- 2 Press [▲, ▼] to select the play list that contains the scene you want to play and press [▶].

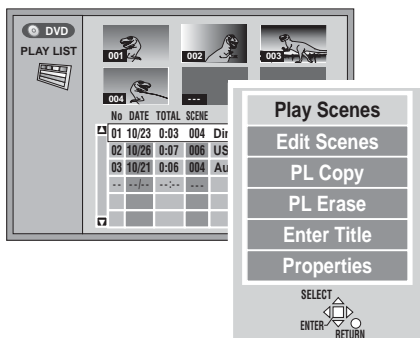

- 3 Press [▲, ▼] to select "Play Scenes" and press [ENTER].

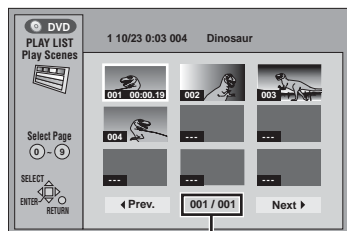

Page no./Total page no.

- 4 Press [▲, ▼, ◀, ▶] to select the scene and press [ENTER].

The scene you select is played.

To show scene 10 and later

Press [▲, ▼, ◀, ▶] to select "Next" and press [ENTER].

- To select a page of scenes with the numbered buttons:

e.g., "5": [0] → [0] → [5]

"15": [0] → [1] → [5]

To stop scene play

Press [■]. (The scene list appears.)

To clear the scene list

Press [RETURN].

To erase a play list or a play list scene during playback

- 1 Press [ERASE].

A confirmation screen will be displayed.

- 2 Press [◀, ▶] to select "Erase" or "Yes" and press [ENTER].

[Note]

Even if you erase play lists or scenes the original program is not erased.

Editing play lists

[HDD] [RAM]

Operation

Preparation

Press [HDD] or [DVD] to select the drive.

While stopped
Press [PLAY LIST].

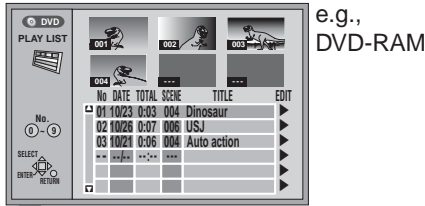

Press [▲, ▼] to select the play list.

- To create a new list, select "Create PLAY LIST" and press [ENTER] (→ page 32).

Press [▶] so the submenu appears.

Press [▲, ▼] to select the item and press [ENTER].

Play Scenes

→ page 33, Playing play list scenes

Edit Scenes

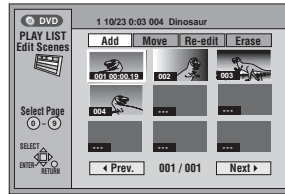

Press [◀, ▶] to select the item (Add, Move, Re-edit or Erase) and press [ENTER].

To show scene 10 and later

- Press [▲, ▼, ▶, ▶] to select "Next" and press [ENTER].
- You can also select a page of scenes by entering a 3-digit number with the numbered buttons.
e.g., "5": [0] → [0] → [5]
"15": [0] → [1] → [5]

PL Copy



Press [◀, ▶] to select "Copy" and press [ENTER].

The copied play list appears at the bottom of the list.

PL Erase



Once a play list has been erased, it is irretrievable. Check carefully before proceeding.

Press [◀, ▶] to select "Erase" and press [ENTER].

The play list is erased.

Enter Title

Entering text → page 46

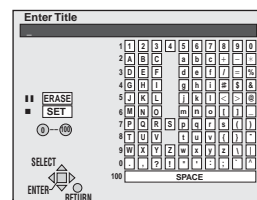

Properties

Play list information (e.g., time and date) is shown.

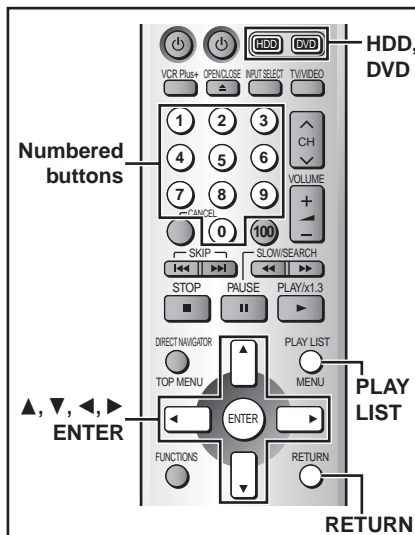
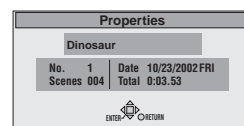

To clear the play list or scene list screen

Press [PLAY LIST].

To stop set up process

Press [RETURN].

For your reference

You can only perform operations for "Play Scenes" and "Properties" if the disc is write-protected. Release protection (cartridge → page 10, disc → page 44) to access other items.

■ Add (maximum of 999 scenes)

Press [▲, ▼, ◀, ▶] to select the place where you want to add the scene and press [ENTER].

Press [ENTER] at the start point of the scene.

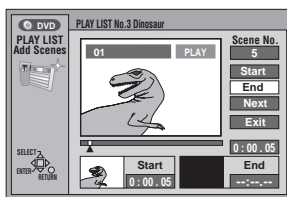

Press [ENTER] at the end point of the scene.

Press [▲, ▼] to select "Exit" and press [ENTER]. The new scene is inserted before the highlighted scene.

Press [▲, ▼] to select "Next" and press [ENTER]. (Repeat to add other scenes.)

■ Move

Press [▲, ▼, ◀, ▶] to select the scene and press [ENTER].

Press [▲, ▼, ◀, ▶] to select the place where you want to move the scene to and press [ENTER]. The scene is moved and inserted before the highlighted scene.

Repeat to move other scenes.

■ Re-edit

Press [▲, ▼, ◀, ▶] to select the scene and press [ENTER].

Press [ENTER] at the start point of the scene.

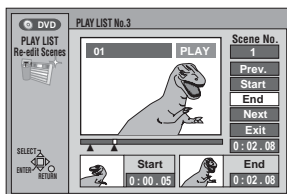

Press [ENTER] at the end point of the scene.

Press [▲, ▼] to select "Exit" and press [ENTER]. The re-edited scene replaces the old one.

Press [▲, ▼] to select "Prev." or "Next" and press [ENTER]. (Repeat to re-edit other scenes.)

■ Erase

Once a scene has been erased, it is irretrievable. Check carefully before proceeding.

Press [▲, ▼, ◀, ▶] to select the scene and press [ENTER].

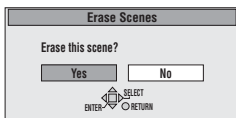

Press [◀, ▶] to select "Yes" and press [ENTER]. The selected scene is erased from the play list.

Note

The play list itself is erased if you erase all the scenes in it.

Repeat to erase other scenes.

Note

- You can use basic functions like fast forwarding/rewinding and slow-motion play (→ page 20).
- You can use the skip function to jump to another program (→ page 20).
- You cannot specify an end point before a start point.
- You may not be able to specify points within 3 seconds of each other.
- Play pauses if the end of the last program is reached during this procedure.
- **You cannot edit still picture images.**
- Depending on the state of recording, the actual number of play lists or scenes that can be recorded may be less than that specified in this manual.
- The picture illustration on the right may be shown in the HDD play list scene display. This picture illustration indicates pictures that are permitted to be recorded only once (→ page 62, CPRM).



Operation

Preparation

Press [HDD] or [DVD] to select the drive.

Press [DIRECT NAVIGATOR].

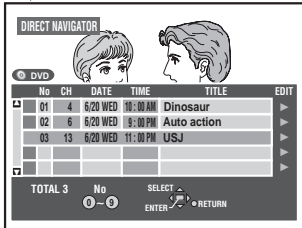

e.g., DVD-RAM

Press [▲, ▼] to select the program.

- To select with the numbered buttons:
e.g., "5": [0] → [5]
(HDD [0] → [0] → [5])

Press [▶] so the submenu appears.

Press [▲, ▼] to select the item and press [ENTER].

Erase Program

HDD RAM DVD-R

The program, and play lists created from it, are erased irretrievably when you use this procedure. Check carefully before proceeding.

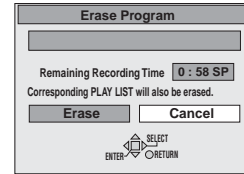

Enter Title

HDD RAM DVD-R

Entering text → page 46

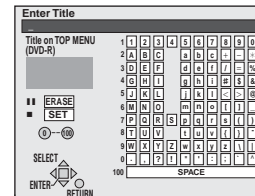

Properties

HDD RAM DVD-R

Program information (e.g., time and date) is shown.

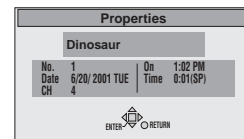

Protection

HDD RAM

If set, this will protect the program from accidental erasure.

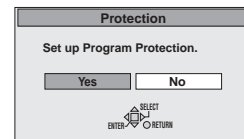

Shorten Segment

HDD RAM

The program segment, and play list scenes created from it, are erased irretrievably when you use this procedure. Check carefully before proceeding.

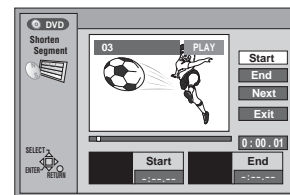

e.g., DVD-RAM

Divide Program

HDD RAM

Select a point at which to divide the program into two.

You must be sure you wish to divide a program because once a program has been divided, it cannot be returned to its original form.

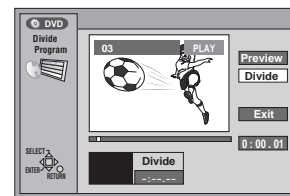

e.g., DVD-RAM

Change thumbnails

DVD-R

Select a thumbnail image of a title that is displayed in the top menu after finalizing.

Normally, the first scene of the program (after 1 second) is displayed.

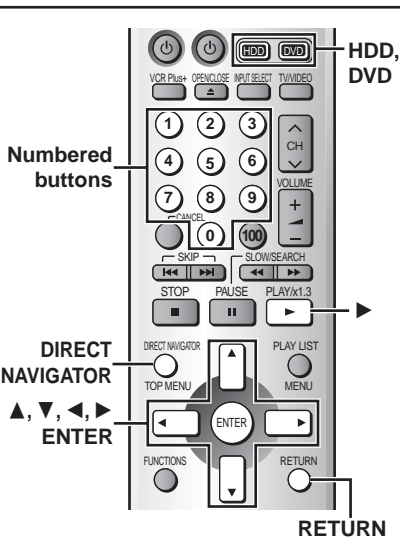
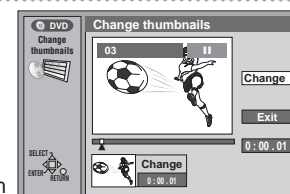

To clear the program list
Press [DIRECT NAVIGATOR].

To stop set up process
Press [RETURN].

For your reference

You can only perform operations for "Properties" if the disc is write-protected. Release protection (cartridge → page 10, disc → page 44) to access other items.

Press [◀, ▶] to select "Erase" and press [ENTER].
The program is erased.

Note

- The disc's available recording time may not increase after erasing short programs.
- Computer data cannot be erased.
- The available recording time on DVD-R does not increase when you erase programs.

Press [◀, ▶] to set protection and press [ENTER].

The lock symbol appears when the program is write-protected.

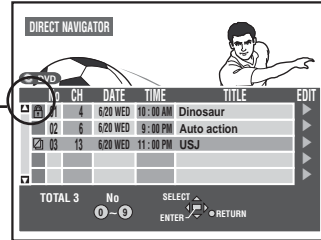

Press [ENTER] at the start point of the section you want to erase.

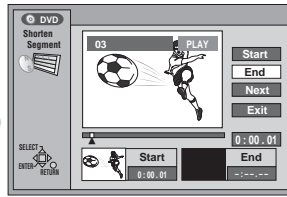

Press [ENTER] at the end point of the section you want to erase.

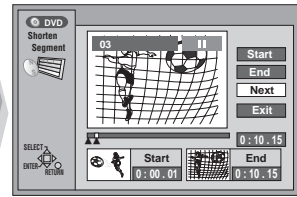

Press [▲, ▼] to select "Next" and press [ENTER], then press [◀, ▶] to select "Erase" and press [ENTER].

Press [▲, ▼] to select "Exit" and press [ENTER].

Note

- You can use basic functions like fast forwarding/rewinding and slow-motion play (→ page 20).
- You can use the skip function to jump to another program (→ page 20).
- Play pauses if the end of the program is reached during this procedure.
- You may not be able to specify points within 3 seconds of each other.
- You cannot specify an end point before a start point.
- You cannot specify points on still pictures in the program.
- The disc's available recording time may not increase after erasing short segments.

Repeat to enter other sections.

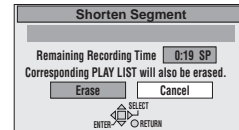

Press [◀, ▶] to select "Erase" and press [ENTER].

Press [ENTER] at the point you want to divide the program.

Press [▲, ▼] to select "Exit" and press [ENTER].

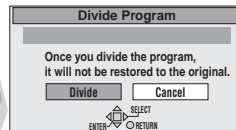

Press [◀, ▶] to select "Divide" and press [ENTER].
The program is divided.

To confirm the division point

Press [▲, ▼] to select "Preview" and press [ENTER]. (Play will begin from a point 10 seconds prior to and after the division point.)

To change the division point

Restart play and press [▲, ▼] to select "Divide", then press [ENTER] at the point you want to change.

Note

- You can use basic functions like fast forwarding/rewinding and slow-motion play (→ page 20).
- You can use the skip function to jump to another program (→ page 20).
- The divided programs retain the title and CPRM property (→ page 62) of the original program.
- Video and audio just before and after the dividing point may momentarily cut out.
- It is not possible to carry out Divide Program in the following cases:
 - when the program is extremely short.
 - when the total number of programs is more than 250 (HDD) or 99 (DVD-RAM).

Press [▶] (PLAY).

Press [ENTER] at the desired point to be the thumbnail.

Press [▲, ▼] to select "Exit" and press [ENTER].

Note

- You can use basic functions like fast forwarding/rewinding and slow-motion play (→ page 20).
- You can use the skip function to jump to another program (→ page 20).
- The beginning and ending scenes cannot be set.

To change the thumbnail

Press [▲, ▼] to select "Change" and repeat the operation above.

Operation

While stopped
Press [FUNCTIONS].

Press [▲, ▼, ◀, ▶] to
select "JPEG" and press
[ENTER].

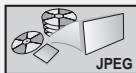

e.g., SD card: First page

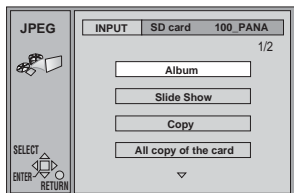

Press [▲, ▼] to select
the item and press
[ENTER].

To select a folder other than the
one currently being displayed
→ "INPUT", right

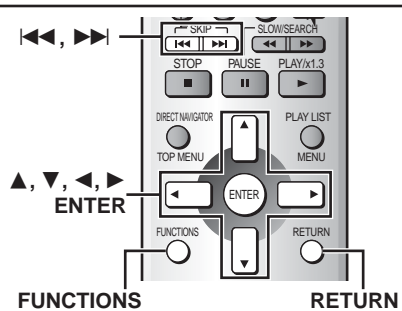

To insert/remove the SD/PC card
(→ page 22)

When the "SD" or "CARD" indicator in the unit display is flashing, the card is being read from or written to. Do not turn off the power or remove the card. Such action may result in malfunction or loss of the card's contents.

To stop set up process

Press [RETURN].

- You can also use [▲, ▼, ◀, ▶] to select "Cancel" or "No" and press [ENTER].

Note

You can only perform operations for "INPUT", "Album" and "Slide Show" if the disc or card is write-protected. Release the protection (cartridge or card → page 10, folder → page 40, disc → page 44) to access other items.

INPUT

HDD RAM SD CARD

You can select the folder for editing.

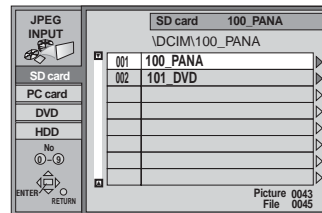

Album

To display still pictures (Album Display) → page 22

Slide Show

To display still pictures one by one with constant interval (Slide Show) → page 23

Copy

SD CARD ↔ **HDD RAM**

(maximum of 300 folders, 3000 files)

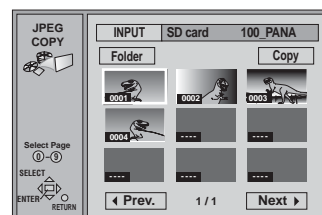

Note

- When there is no folder in the copying drive, a new folder will be created.
- When there is a folder in the copying drive, copying will continue from the last of the existing still pictures.
- When copying a folder, any files in the folder besides the still pictures are also copied.
- Folders lower than the folder to be copied will not be copied.
- If the space on the copying drive runs out or the number of files/folders to be copied exceeds the maximum, copying will stop partway through.
- If no title has been entered for the folder at the copying drive, the title from the copying source will be entered. It is recommended that the title is entered at the copying source.
- After copying, it may take some time to download the copying source information.
- Print (DPOF) number setting (→ page 40) is not transferred.

All copy of the card

SD CARD → **HDD RAM**

(maximum of 300 folders, 3000 files)

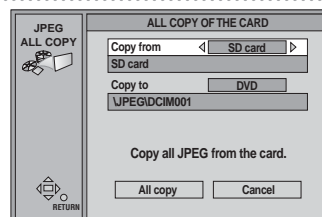

Note

- A new folder will be created in the copying drive.
- All compatible files in the folder are copied even if they are not still pictures, but non-compatible files and folders will not be copied (→ page 11).
- Folders lower than the folder to be copied will not be copied.
- If the space on the copying drive runs out or the number of files/folders to be copied exceeds the maximum, copying will stop partway through.
- After copying, it may take some time to download the copying source information.
- Print (DPOF) number setting (→ page 40) is not transferred.

Erase, Protect, Print (DPOF) → page 40

Settings → page 23, "To change the display timing"
→ page 40, "Format"

Press [◀] and [▲, ▼] to select the drive and press [▶].

Press [▲, ▼] to select still picture's folder and press [ENTER].

To enter the folder's title

After selecting the still picture's folder, press [▶] to select "Folder Title" and press [ENTER]. (→page 46, Entering text)

- If there is not enough space for the entry or if the limit for the number of files has been exceeded (→page 11, Still pictures), the title cannot be entered.

Note

- "Picture" and "File" refer to numbers inside the folder selected. Lower files are not included.
- When there are folders not displayed, use [◀◀], [▶▶] to switch between them. (→ page 23, Folder structure).

Press [▲, ▼, ◀, ▶] to select a still picture and press [ENTER].

A check mark appears on the still picture.



- Repeat this if you select more than one still picture.

Press [▲, ▼, ◀, ▶] to select "Copy" and press [ENTER].

A confirmation screen appears.

Select the copying drive. (→ below)

Press [▲, ▼, ◀, ▶] to select "Copy" and press [ENTER].

Copying of still pictures begins.

To select all the still pictures in the folder

Press [▲, ▼, ◀, ▶] to select "Folder" and press [ENTER]. (A check mark appears on the folder's name; check marks inputted separately will be erased.)

To erase check marks

Press [▲, ▼, ◀, ▶] to select the still picture or "Folder" with the check mark and press [ENTER].

To select the copying drive

While the confirmation screen is displayed

1. Press [▲, ▼] to select "Destination" and press [ENTER].
 2. Press [◀] and [▲, ▼] to select the drive.
 3. Press [▶] and [▲, ▼] to select the folder and press [ENTER].
- Some folders cannot be copied to (→ page 23, Folder structure (indicated by ※)).

Press [◀, ▶] to select "SD card" or "PC card".

Press [▲, ▼] to highlight "Copy to" and press [◀, ▶] to select "HDD" or "DVD".

Press [▲, ▼, ◀, ▶] to select "All copy" and press [ENTER].

All still pictures are copied, and ALL COPY screen reappears.

Operation

While stopped
Press [FUNCTIONS].

Press [▲, ▼, ◀, ▶] to
select "JPEG" and press
[ENTER].



e.g., SD card: Second page

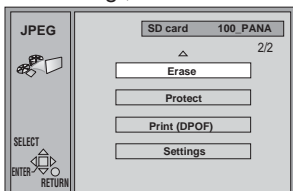

Press [▲, ▼] to select
the item and press
[ENTER].

To select a folder other than the
one currently being displayed
→ page 38, "INPUT"

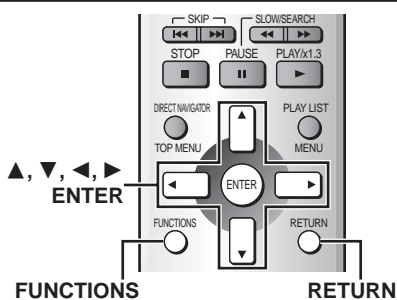

To insert/remove the SD/PC card (→ page 22)

When the "SD" or "CARD" indicator in the unit display is flashing, the card is being read from or written to. Do not turn off the power or remove the card. Such action may result in malfunction or loss of the card's contents.

To stop set up process

Press [RETURN].

- You can also use [▲, ▼, ◀, ▶] to select "Cancel" or "No" and press [ENTER].

Note

You can only perform operations for "Slide Show" in "Settings" if the disc or card is write-protected. Release the protection (cartridge or card → page 10, folder → right, disc → page 44) to access other items.

- "INPUT", "Copy" and "All copy of the card" → page 38
- "Album" → page 22, To display still pictures (Album Display)
- "Slide Show" → page 23, To display still pictures one by one with constant interval (Slide Show)

Erase

SD CARD HDD RAM

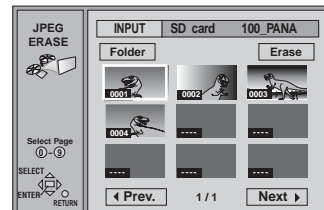

Note

When you erase folders, files other than still pictures in the folder are also erased. Folders lower than the folder to be erased will not be erased.

Protect

SD CARD HDD RAM

You can set protection for whole folders or for individual still pictures.

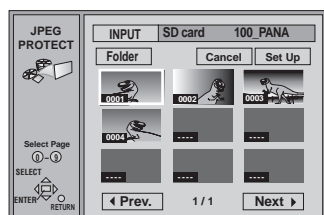

Print (DPOF)

SD CARD

You can select a whole folder or individual pictures for printing and specify the number of prints to be made (maximum 999 files).

Note

- Settings cannot be made for folders and files not in accordance with DCF standards.
- Print settings (DPOF) made using this unit may not be viewable on other equipment.
- Settings cannot be made if there is no remaining space on the card.
- All settings made on other equipment, except the number of prints, will be canceled.

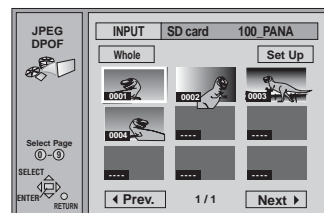

Settings

Slide Show

HDD RAM SD CARD

To change the display timing
→ page 23

Format

SD CARD

You can erase all still pictures in the card and format an unformatted card.

Once activated, material cannot be returned to its original form. Check carefully before proceeding.

Press [▲, ▼, ◀, ▶] to select a still picture and press [ENTER].

A check mark appears on the still picture.



- Repeat this if you erase more than one still picture.

Press [▲, ▼, ◀, ▶] to select “Erase” and press [ENTER].

A confirmation screen appears.

Press [◀, ▶] to select “Erase” and press [ENTER].

Selected still pictures are erased, and the still picture select screen reappears.

To select all the still pictures in the folder

Press [▲, ▼, ◀, ▶] to select “Folder” and press [ENTER]. (A check mark appears on the folder’s name; check marks inputted separately will be erased.)

To erase check marks

Press [▲, ▼, ◀, ▶] to select the still picture or “Folder” with the check mark and press [ENTER].

Press [▲, ▼, ◀, ▶] to select a still picture and press [ENTER].

A check mark appears on the still picture.



- Repeat this if you set protection of more than one still picture.

Press [▲, ▼, ◀, ▶] to select “Set Up” or “Cancel” and press [ENTER].

Press [◀, ▶] to select “Yes” and press [ENTER].

The lock symbol appears on the still picture when the still picture is protected.

To select all the still pictures in the folder

Press [▲, ▼, ◀, ▶] to select “Folder” and press [ENTER]. (A check mark appears on the folder’s name; check marks inputted separately will be erased.)

To erase check marks

Press [▲, ▼, ◀, ▶] to select the still picture or “Folder” with the check mark and press [ENTER].

Press [▲, ▼, ◀, ▶] to select a still picture and press [ENTER].

A check mark appears on the still picture.



- Repeat this if you print more than one still picture.

Press [▲, ▼, ◀, ▶] to select “Set Up” and press [ENTER].

Press [◀, ▶] to set number of print (0 to 9).

Press [▲, ▼, ◀, ▶] to select “Set” and press [ENTER].

The DPOF mark appears if you set one or more pictures to print.



To select all the still pictures in the folder

Press [▲, ▼, ◀, ▶] to select “Whole” and press [ENTER]. (A check mark appears on the folder’s name; check marks inputted separately will be erased.)

To change print (DPOF) settings

1. Press [▲, ▼, ◀, ▶] to select a still picture or “Whole” with the DPOF mark and press [ENTER].
2. Press [▲, ▼, ◀, ▶] to select “Set Up” and press [ENTER].
3. Press [◀, ▶] to change the print setting.
 - The print setting will be canceled if you set the number of print to “0”.
4. Press [▲, ▼, ◀, ▶] to select “Set” and press [ENTER].

Once activated, recorded contents (including protected still pictures and computer data) will be completely erased. Check carefully before proceeding.

Press [◀, ▶] to select “SD card” or “PC card” and press [ENTER].

Press [◀] to select “Yes” and press [ENTER].

Press [◀] to select “Start” and press [ENTER].
Formatting starts.

Press [ENTER] to complete the procedure.

Note

- The cards formatted on this unit may not be usable on other equipment.
- Make absolutely sure not to pull the AC power supply cord out until a message indicating completion appears. This may result in loss of card use.

Operation

While stopped
Press [FUNCTIONS].

Press [▲, ▼, ◀, ▶] to select "SD VIDEO (MPEG4)" and press [ENTER].

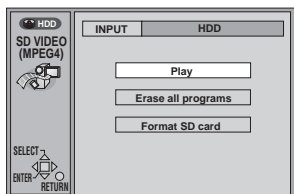



Press [▲, ▼] to select the item and press [ENTER].

INPUT

HDD RAM SD CARD

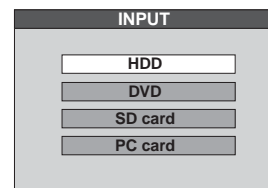
You can select the drive for editing.



Press [▲, ▼] to select the drive and press [ENTER].

Play

HDD RAM SD CARD

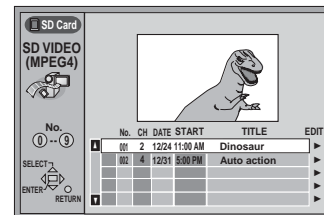

e.g., SD card

Press [▲, ▼] to select the program.

- To select with the numbered buttons:
e.g., "5": [0] → [0] → [5]

Press [▶] so the submenu appears.

Press [▲, ▼] to select the item and press [ENTER].

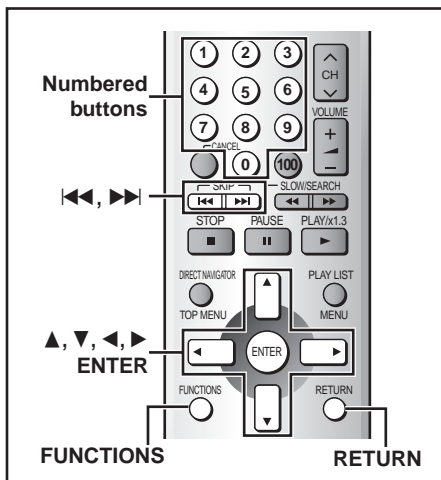

- : Programs set to protected
- : Programs that cannot be played
- : Programs without audio
- : Programs that do not allow input of titles

Note
Use [◀◀], [▶▶] to switch between folders when there are other folders on the mobile hard disc which are not displayable on screen. (→ page 23, Folder structure) **CARD**

Erase all programs

HDD RAM SD

All SD VIDEO (MPEG4) programs will be erased irretrievably when you use this procedure. Check carefully before proceeding.

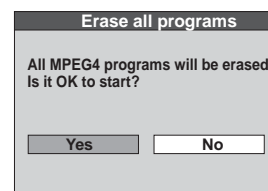

Format SD card

SD

You can erase all programs in the card.

Once activated, recorded contents (including protected programs and computer data) will be completely erased. Check carefully before proceeding.

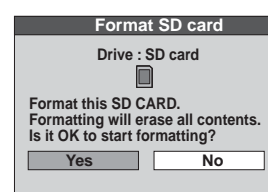

To insert/remove the SD/PC card
(→ page 22)
When the "SD" or "CARD" indicator in the unit display is flashing, the card is being read from or written to. Do not turn off the power or remove the card. Such action may result in malfunction or loss of the card's contents.

To stop set up process
Press [RETURN].
• You can also use [▲, ▼, ◀, ▶] to select "Cancel" or "No" and press [ENTER].

Note
You can only perform operations for "INPUT" and "Play" if the disc or card is write-protected. Repeat the protection (cartridge or card → page 10, disc → page 44) to access other items.

■ Erase

HDD RAM SD

Once a program has been erased, it is irretrievable. Check carefully before proceeding.

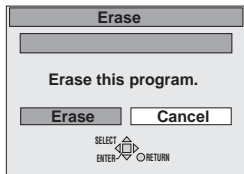

Press [**◀**, **▶**] to select “Erase” and press [**ENTER**].
The program is erased.

Note

All content may be erased including files not supported by this unit.

■ Enter Title

HDD RAM SD

Entering text → page 46

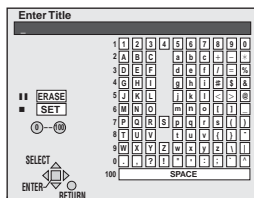

■ Properties

HDD RAM SD CARD

Program information (e.g., time and date) is shown.

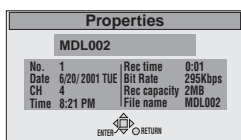

■ Protection

HDD RAM SD

If set, this will protect the program from accidental erasure.

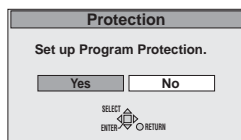

Press [**◀**, **▶**] to set protection and press [**ENTER**].

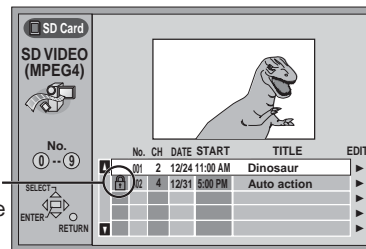

The lock symbol appears when the program is write-protected.

Press [**◀**, **▶**] to select “Yes” and press [**ENTER**].

Press [**◀**, **▶**] to select “Start” and press [**ENTER**].
All programs are erased.

Press [**ENTER**] to complete the procedure.

Note

- Make absolutely sure not to pull the AC power supply cord out until a message indicating completion appears. This may result in loss of card use.
- All content may be erased including files not supported by this unit.

To stop erasing

Press and hold [**RETURN**] for 3 seconds. (Erases everything up to the point stopped.)

Press [**◀**, **▶**] to select “Yes” and press [**ENTER**].

Press [**◀**, **▶**] to select “Start” and press [**ENTER**].
Formatting starts.

Press [**ENTER**] to complete the procedure.

Note

- The cards formatted on this unit may not be usable on other equipment.
- Make absolutely sure not to pull the AC power supply cord out until a message indicating completion appears. This may result in loss of card use.

Operation

Preparation

Press [HDD] or [DVD] to select the drive.

While stopped
Press [FUNCTIONS].

Press [**▲**, **▼**, **◀**, **▶**] to
select "DISC SETTING"
and press [ENTER].



e.g., DVD-RAM

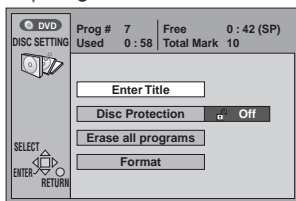

Press [**▲**, **▼**] to select
the item and press
[ENTER].

Editing

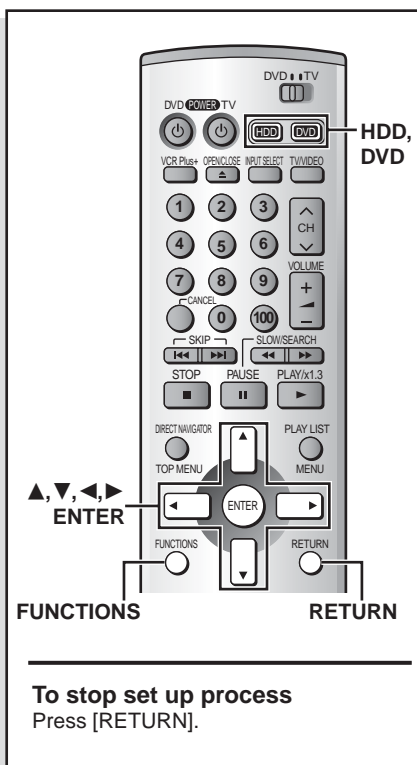

Enter Title

RAM DVD-R

Entering text → page 46

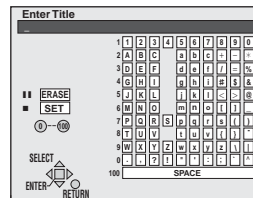

Disc Protection

RAM

If set, this will protect the disc from accidental erasure.

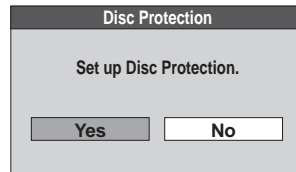

Erase all programs

HDD RAM

All programs and play lists created from them will be erased irretrievably when you use this procedure. Check carefully before proceeding.

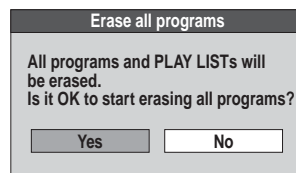

Preparation

Release protection (cartridge → page 10, program → page 36, disc → above) before proceeding.

Format

HDD

Erase the entire contents on the HDD.

RAM

Some DVD-RAM are unformatted. Format them before using them in this unit. Formatting also allows you to erase the entire contents of a disc.

Preparation

- Release protection (cartridge → page 10) before proceeding.
- If the disc is dirty, clean it with the recommended cleaner (→ page 62) before formatting.

Formatting erases all contents on the disc, including computer data. Check carefully before proceeding.

e.g., DVD-RAM

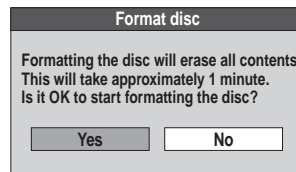

TOP MENU

DVD-R

Prior to finalizing, you can select the background (9 kinds) that will be displayed as the DVD Video top menu after finalizing.



Select First play

DVD-R

Prior to finalizing, you can select the screen that will appear first after finalizing.

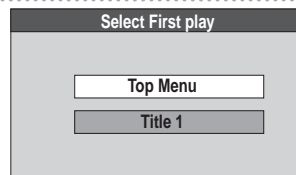

Finalize

DVD-R

You can play DVD-R on compatible DVD players by finalizing them on this unit, effectively making them into DVD-Video that complies with DVD-Video standards.

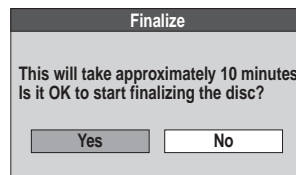

Press [◀, ▶] to set disc protection and press [ENTER].



The lock symbol appears closed when the disc is write-protected.

Press [◀, ▶] to select "Yes" and press [ENTER].

Press [◀, ▶] to select "Start" and press [ENTER].

All programs and play lists are erased.

Press [ENTER] to complete the procedure.

Note

- Computer data cannot be erased.
- Erase does not work if one or more programs are protected.

Press [◀, ▶] to select "Yes" and press [ENTER].

Press [◀, ▶] to select "Start" and press [ENTER].

Formatting starts.
• A message appears when formatting is finished.

Press [ENTER] to complete the procedure.

Note

- Do not disconnect the AC power supply cord while the message "Formatting the disc" is on the television. This can render the disc unusable.
- Formatting normally takes a few minutes, however it may take up to a maximum of 70 minutes.
- The contents on the disc are erased when you format it even if you have set program or disc protection. **RAM**
- It may not be possible to use a disc on this unit if you cannot format it.
- Formatting cannot be performed on DVD-R or CD-R/RW.

To stop formatting
Press [RETURN].

You can cancel formatting if it takes more than 2 minutes. The disc must be reformatted if you do this.

Press [▲, ▼, ◀, ▶] to select the background and press [ENTER].

Note

You can change the title thumbnail. (→ page 36, Change thumbnails)

Press [▲, ▼] to select "Top Menu" or "Title 1" and press [ENTER].

- Select "Title 1" to play from the beginning on the disc without displaying the top menu screen.

Press [◀, ▶] to select "Yes" and press [ENTER].

Press [◀, ▶] to select "Start" and press [ENTER].

Finalizing starts.
• A message appears when finalizing is finished.

Press [ENTER] to complete the procedure.

Note

- Do not disconnect the AC power supply cord while the message "Finalizing the disc" is on the television. This will render the disc unusable.
- Finalizing takes up to 15 minutes.
- You cannot finalize a DVD-R recorded on equipment that is not Panasonic.
- If you finalize a recorded DVD-R on Panasonic equipment other than this unit, the background selected as "TOP MENU" may not display.

After finalizing..

- You cannot record or perform editing such as giving titles and erasing programs.
- Programs directly recorded to a DVD-R and dubbed programs longer than 5 minutes using any mode other than the high speed mode are divided into approximate 5 minute segment chapters. When dubbing in high speed mode, marker and scene segments will become chapter segments.
- There is a pause of several seconds between program segments.
- These DVD-R can be played on other DVD players, but this is not guaranteed. Play may not be possible due to the player you are using, the DVD-R, or the condition of the recording. Play the disc using this unit if you experience problems with other equipment.

Visit Panasonic's homepage for more information about DVDs.

For U.S.A.: <http://www.panasonic.com/playDVD-R> For Canada: www.panasonic.ca

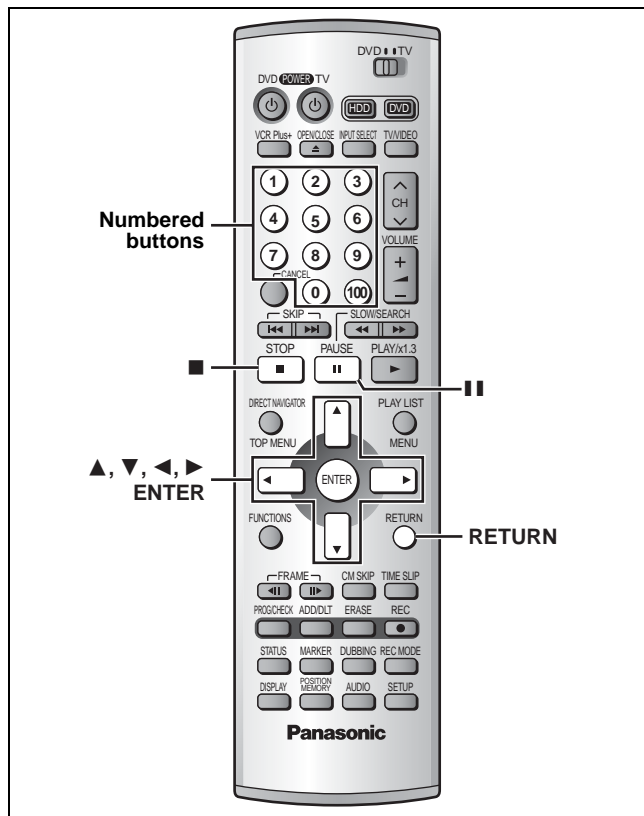

[HDD] [RAM] [DVD-R] [SD] [CARD]

This page shows how to enter text for:

- Program titles for timer recording (→pages 26 and 27)
Program titles (→page 36)
SD VIDEO (MPEG4) program titles (→page 43)
- Play list titles (→page 34)
- Disc titles (→page 44)
- Folder titles of still pictures (→page 39)

You can enter characters up to:

Item	Number of characters			
	[HDD]	[RAM]	[DVD-R]	[SD] [CARD]
Disc	–	64	40	–
Program	64*		44	
Play list	64		–	
Folder of still pictures	36		–	36
SD VIDEO (MPEG4) programs	44		–	44

* From the timer recording menu: 44

Preparation

Release protection before proceeding.

Cartridge or card →page 10, program →page 36, folder →page 39, disc →page 44

- 1 After the Enter Title screen appears
Press [**▲**, **▼**, **◀**, **▶**] to select the character and press [**ENTER**].

Title field: shows the text you have entered

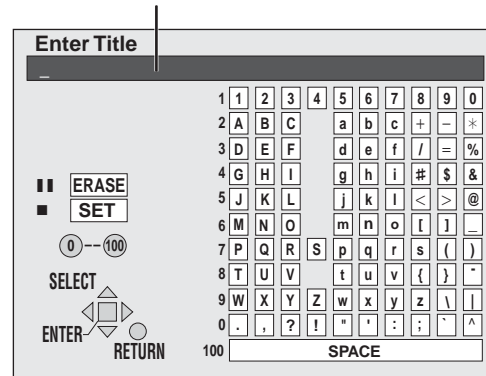

Repeat step 1 to enter other characters.

- 2 Press [**■**].

The title is entered and the screen disappears.

- You can also finish entering the title by selecting “SET” and pressing [ENTER].

To end input midway

Press [RETURN] (does not save any title information).

Using the numbered buttons to enter characters

e.g., entering the letter “R”

- ① Press [7] to move to the 7th row.
- ② Press [7] twice to highlight “R”.
- ③ Press [ENTER].

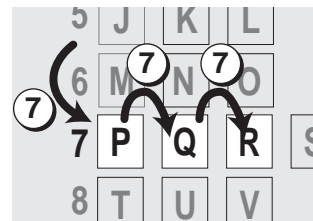

To erase a character

- ① Press [**▲**, **▼**, **◀**, **▶**] to select the character you want to erase in the title field.
- ② Press [**■**].
You can also erase characters by selecting “ERASE” and pressing [ENTER].

[Note]

- The full title is shown in the Properties screen (→page 34, 36 and 43), but if you enter a long title, only part of it is shown in the program list or play list screen.
- If you enter a long title, only part of it is shown in the TOP MENU (→page 44) after finalization ([DVD-R]). When entering a program title, the title that will appear in the TOP MENU can be previewed in “Title on TOP MENU (DVD-R)” field.
- Still picture folder titles
 - Titles are saved in the “TITLE.DVD” folder and can only be displayed on this unit.
 - Input is not possible if the destination lacks sufficient space or has exceeded the maximum number of allowable files.
 - The title may not appear correctly if input was done using other equipment.
- You cannot input titles on a mobile hard disk.

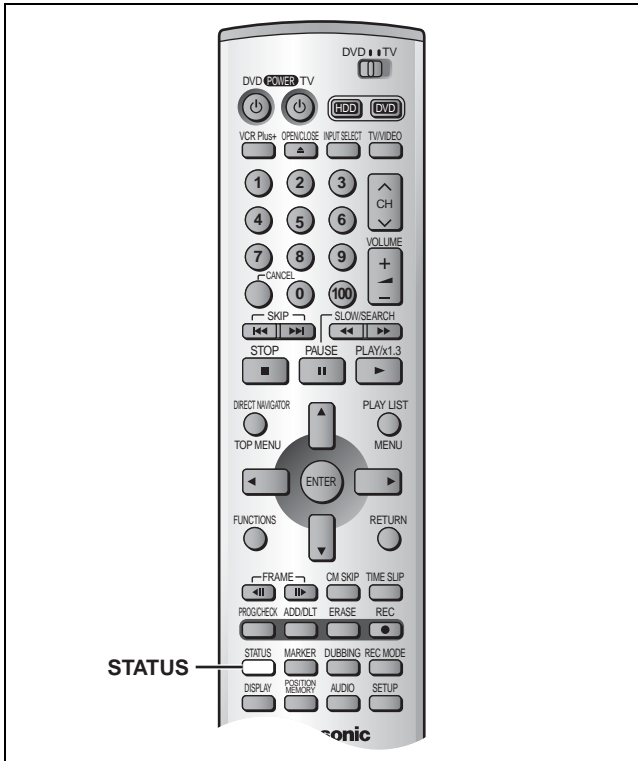

Displays appear on the television when you operate the unit to let you know what operation was performed and what condition the unit is in.

- You can change the setting in the SETUP menu so the first display does not appear automatically (→page 53, Status Messages).

Changing the information displayed

Press [STATUS].

The display changes each time you press the button.

e.g., HDD

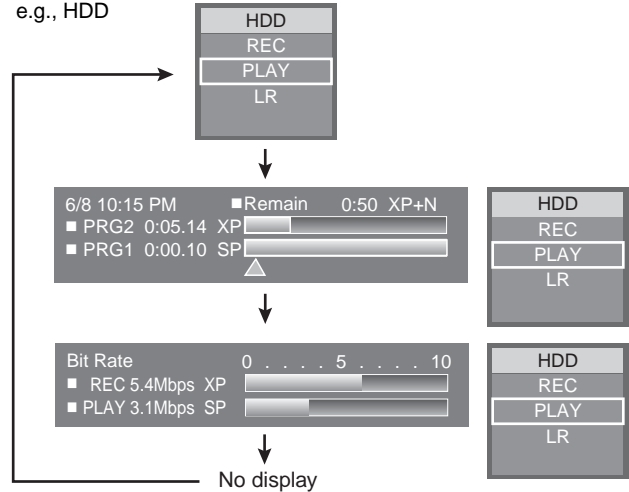

Display examples

e.g., HDD

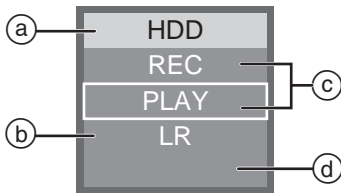

a HDD/Disc indication

b Audio type (→page 25)
Shows the selected audio type.

- During reception
 - Stereo:** Stereo is selected
 - Mono:** Monaural is selected
 - SAP:** Secondary audio program is selected

("(" appears when the type you have selected is actually being received.)

- During play
 - LR, R, L:** a stereo program is recorded
 - MAIN, SAP:** an SAP program is recorded

c Current recording or play status/input channel and caption (if entered)

- REC:** Recording
- PAUSE:** Recording paused
- PLAY:** Playing
- ◀◀:** Rewinding
- ▶▶:** Fast forwarding
- ◀:** Reverse slow-motion
- ▶:** Slow-motion

d HDD recording/DVD recording:

- the recording drive is indicated
- Tray open/closed:** indicates the status of the disc tray when the HDD drive is selected

e.g., HDD

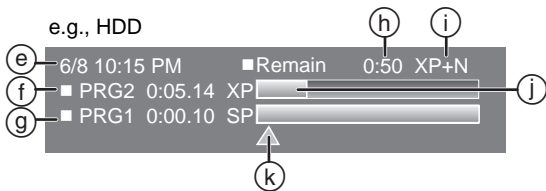

e The current date and time

f Elapsed recording time/recording mode

g Elapsed play time of a program playing/mode at the time of recording

h Available recording time

i Recording mode+MPEG4 recording mode

j Approximate volume of recording

k Play position in the volume of recording

l Selected group and track name

m Selected group and track number

n Selected track no./Total track no. in all groups

o Elapsed play time of a track playing

e.g., MP3

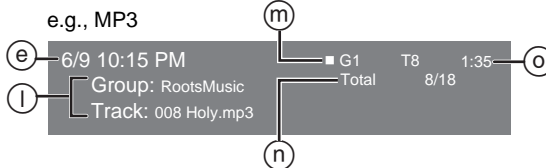

e.g., HDD

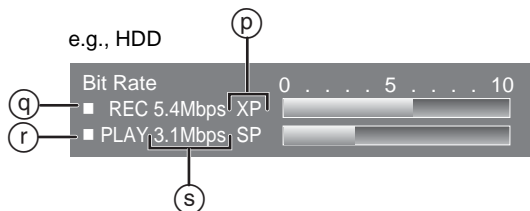

p Recording mode or I/P/B display when paused (→page 62)

q Video bit-rate when recording

r Video bit-rate when playing

- s Bit-rate display***
Show as Mbps (Megabits per seconds) during play and recording, or kbit (kilobits) while paused.

*The method of calculating bit-rate for recording and playing is different so there may be differences in the figures displayed. (Values are approximate.)

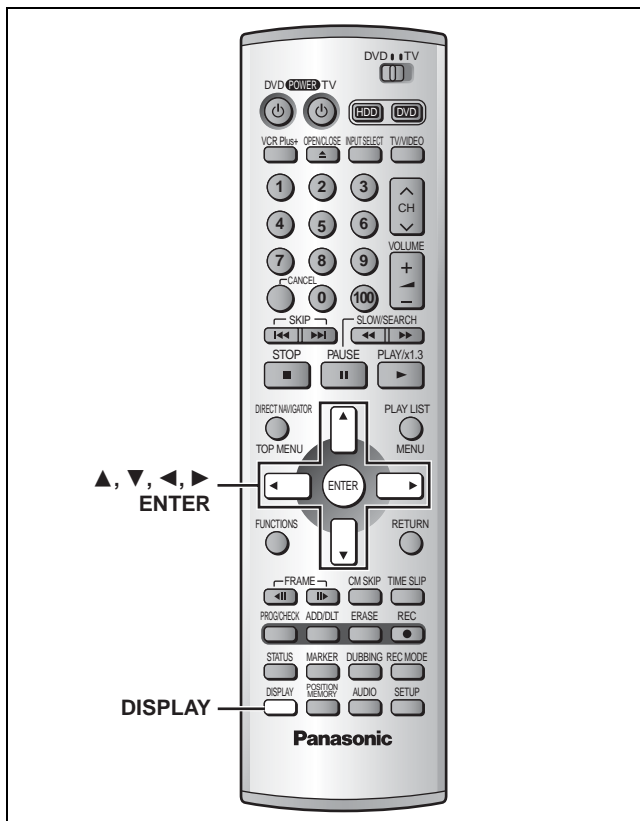

Disc menu

Not available when playing CDs and MP3 discs.

e.g., DVD-RAM

Disc	Sound track	1	DD Digital	2/0 ch
Play	Subtitle	OFF		
Video	Audio channel	L R		

Item	Content
Sound track	Soundtrack language [DVD-A] [DVD-V] See [A] below.
	Audio attribute [HDD] [RAM] [DVD-R] [DVD-A] [DVD-V] See [B] below.
	Karaoke vocals, on and off (Karaoke [DVD-V] only) Solo: ON ↔ OFF Duet: OFF ↔ V1+V2 ↔ V1 ↔ V2 ↑—————↑
Subtitle	Subtitle language [DVD-A] [DVD-V] See [A] below.
	Subtitle on/off [HDD] [RAM] [DVD-R] [DVD-A] [DVD-V]
Angle	Angle number [DVD-A] [DVD-V]
STILL-P	Page Still picture number [DVD-A] ● When "Return" is displayed Select "Return" and press [ENTER] to return to the default page. ● When "RANDOM" is displayed Select "RANDOM" and press [ENTER], the picture changes randomly each time you press [ENTER].
	Slide Show (Display only) [DVD-A]
Audio channel	[HDD] [RAM] [VCD] (→page 25)
PBC	Playback control on/off [VCD] Indicates whether menu play (playback control) is on or off.

Common procedures

1 Press [DISPLAY].

e.g., DVD-RAM

Disc	Sound track	1	DD Digital	2/0 ch
Play	Subtitle	OFF		
Video	Audio channel	L R		

Menu Item Setting

2 Press [▲, ▼] to select the menu and press [▶].

3 Press [▲, ▼] to select the item and press [▶].

4 Press [▲, ▼] to select the setting.

To clear the on-screen menus

Press [DISPLAY].

For your reference

- Some items can be changed by pressing [ENTER].
- The screens depend on the disc contents.
- Depending on the condition of the unit (playing, stopped, etc.) and disc contents, there are some items that you cannot select or change.

[A] Soundtrack/Subtitle language

ENG: English	SVE: Swedish	CHI: Chinese
FRA: French	NOR: Norwegian	KOR: Korean
DEU: German	DAN: Danish	MAL: Malay
ITA: Italian	POR: Portuguese	VIE: Vietnamese
ESP: Spanish	RUS: Russian	THA: Thai
NLD: Dutch	JPN: Japanese	*: Others

[B] Audio attributes

LPCM/PPCM/DDigital/DTS/MPEG: Signal type

k (kHz): Sampling frequency

b (bit): Number of bits

ch (channel): Number of channels

e.g., 3/2 .1ch

1:	Low frequency effect (not displayed if there is no signal)
0:	No surround
1:	Mono surround
2:	Stereo surround (left/right)
1:	Center
2:	Front left+Front right
3:	Front left+Front right+Center

For your reference

- When playing back recordings of SAP broadcasts, "1+1 ch" will be displayed.
- You may have to use the menus on the disc to make a change to selectable soundtracks, subtitles, and angles if they are recorded on the disc.
- If the subtitles overlap closed captions recorded on discs, turn the subtitles off.

Video menu

■ When “User” is selected

Select “Detail picture adjustment”.

(“User” → [◀] → [▼] → [ENTER])



Page 1/2 of “Detail picture adjustment”

Contrast	Increases the contrast between light and dark parts of the picture (-7 to +7).
Brightness	Brightens the picture (0 to +15).
Sharpness	Adjust the sharpness of the edges of the horizontal lines (-6 to +6).
Color	Adjusts the shade of the picture's color (-7 to +7).

Press [ENTER] to enter the setting.

Press [▲] or [▼] until page 2/2 appears.

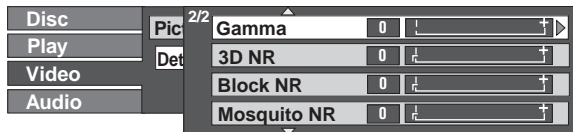

Page 2/2 of “Detail picture adjustment”

Gamma	Increases the brightness of the center ranges to improve detail and contrast in dark scenes (0 to +5).
3D NR	Reduces overall noise (0 to +4).
Block NR	Smooths block noise (0 to +3).
Mosquito NR	Reduces the smudging that appears around contrasting sections of the picture (0 to +3).

Press [ENTER] to enter the setting.

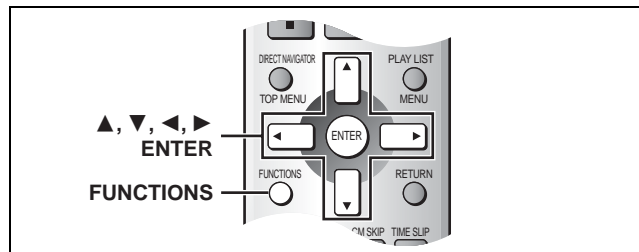

[HDD] [RAM] [DVD-R] [DVD-A] [DVD-V] [VCD] [CD] [MP3] [SD] [CARD]

By using the FUNCTIONS window you may access the main functions quickly and easily.

1 While stopped

Press
[FUNCTIONS].

e.g., DVD-RAM

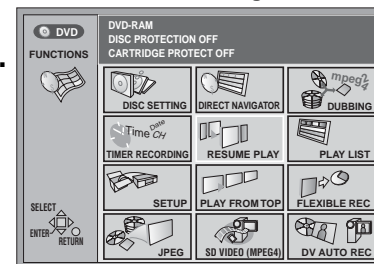

2 Press [▲, ▼, ◀, ▶] to select an item.

Refer to the relevant pages for details.

Icon	Refer to
DISC SETTING	→page 44, HDD, Disc setting
TIMER RECORDING	→page 26, Timer recording
SETUP	→page 51, Changing the unit's settings
JPEG	→page 22, Playing still pictures and SD VIDEO (MPEG4) programs →page 38, Editing still pictures
SD VIDEO (MPEG4)	→page 22, Playing still pictures and SD VIDEO (MPEG4) programs →page 42, Editing SD VIDEO (MPEG4) programs
DIRECT NAVIGATOR	→page 19, Using the Direct Navigator →page 36, Editing programs
RESUME PLAY	→page 18, Playing discs
PLAY FROM TOP	[HDD] [RAM] [DVD-R] Play will begin with the oldest program on the disc (Program 1). [DVD-A] [DVD-V] Play will avoid playing the introductory parts and begin playing the contents immediately. (The performance of this function varies from disc to disc.)
DV AUTO REC	→page 16, DV Automatic Recording (DV AUTO REC)
PLAY LIST	→page 33, Playing play lists →page 34, Editing play lists
FLEXIBLE REC	→page 15, Recording the best quality pictures within the set amount of time—Flexible Recording
TOP MENU	→page 19, When a menu screen appears on the television
DUBBING	→page 30, Dubbing programs or play list

Functions displayed depend on the type of disc.

- Some items will be grayed out and cannot be selected if:
 - the disc is write protected/the disc is not formatted/there is nothing recorded on the disc.

3 Press [ENTER].

Your selection is entered and the FUNCTIONS window disappears. If the operation requires further selections, another screen appears.

To clear the FUNCTIONS window

Press [FUNCTIONS].

Changing the unit's settings

Summary of settings

This chart shows the initial settings for this unit. See page 54 for details on menu operation.

• Underlined items are the factory presets.

Tabs	Menus	Options
Channel	Antenna System (→page 7) Select to suit the type of antenna you are using. Channels are set corresponding to the antenna system you select.	•TV • <u>CATV</u>
	Auto Channel Setting (→page 7) The unit sets the channels automatically.	
	Preset Channel Caption (→page 56) You can give preset captions to the channels.	
	Manual Channel Caption (→page 56) You can set channel captions manually.	
	VCR Plus+ CH Setting (→page 8) Set the guide channels for use with VCR Plus+ timer recording.	
Set Up	Off Timer Select how long the unit remains on when it is not being used.	•2 hr • <u>6 hr</u> •Off
	Remote Control Code (→page 54) To avoid operating equipment other than the one intended (when more than one remote controlled item is in the same area), change the remote control code.	• <u>Set Code 1</u> •Set Code 2 •Set Code 3
	Auto Clock Setting (→page 55) The unit adjusts the clock automatically.	
	Manual Clock Setting (→page 55) You can adjust the clock.	
	Time Zone Adjust (→page 55) Adjust the time zone if it was not set correctly after auto clock setting. This appears only after auto clock setting is complete.	•-1 • <u>0</u> •+1
	Re-initialize Setting This returns all values in the SETUP menus, except for the clock, channel settings, ratings level, and display language, to the default settings.	•Yes • <u>No</u>
Disc	Audio Choose the audio language.	Some discs start in a certain language despite any changes you make here.
	Subtitle Choose the subtitle language.	
	Menus Choose the language for disc menus.	
	Ratings Set a ratings level to limit DVD-Video play. The password screen is shown when you select levels 0 to 7. To enter a password 1. Input a 4-digit password with the numbered buttons. • If you enter a wrong number, press [◀] to erase it. • Do not forget your password. 2. Press [ENTER]. • The lock symbol appears closed to show the rating is locked. 3. Press [ENTER] to confirm the 4 digits.	<ul style="list-style-type: none"> •<u>English</u> •French •Spanish •Original: The original language of each disc will be selected. •Other * * * *: Input a code (→back cover). <hr/> <ul style="list-style-type: none"> •<u>Automatic</u>: If the language selected for "Audio" is not available, subtitles of that language will automatically appear if available on that disc. •English •French •Spanish •Other * * * * <hr/> <ul style="list-style-type: none"> •<u>English</u> •French •Spanish •Other * * * *
		<p>Setting ratings (When level 8 is selected) 8 No Limit: All DVD-Video can be played. 1 to 7: Prohibits play of DVD-Video with corresponding ratings recorded on them. 0 Lock All: Prohibits play of all DVD-Video.</p> <hr/> <p>Changing ratings (When level 0-7 is selected) •Unlock Recorder •Change Password •Change Level •Temporary Unlock</p>
	If you insert a DVD-Video that exceeds the ratings limit you set, a message appears on the television. Press [SETUP] to select "Ratings" again and change ratings.	
	DVD-Video Mode Select how to play pictures contained on some DVD-Audio. The setting returns to "Off" when you change the disc or turn the unit off.	<ul style="list-style-type: none"> •On: You can play DVD-Video content on DVD-Audio. •<u>Off</u>: DVD-Audio are played as DVD-Audio.

Continued on next page.

Summary of settings

Tabs	Menus	Options
Disc	Rec in DVD-R high speed mode You can dub to DVD-R discs using high speed mode if this setting is "On" when recording content to the HDD.	<ul style="list-style-type: none"> ●On: High speed mode compatibility ("⏮" appears in the dubbing list. →page 30) <ul style="list-style-type: none"> –Pictures are saved at 4:3. –For SAP broadcasts use "Select MTS". (→page 53) <ul style="list-style-type: none"> Select the type of audio in advance. –Hybrid VBR Resolution (→ below) setting is "Fixed". ●Off You cannot dub programs to a DVD-R disc using the high speed mode if you recorded the program on a DVD recorder that does not have the "Rec in DVD-R high speed mode" function, even when dubbing to the HDD with this setting "On".
	MPEG4 Rec MPEG4 Rec mode Select the recording mode of the program to be recorded as SD VIDEO (MPEG4).	<ul style="list-style-type: none"> ●SF(Super Fine) ●F(Fine) ●N(Normal) ●E(Economy) ●Off –Picture quality becomes better in the following sequence: E→N →F→SF –You cannot dub a program to a Multi Media Card if you select "SF". –You cannot select when Auto Renewal Recording is set. (→page 28)
	SD card capacity Set according to the capacity of the card you are using. You can dub to the card as programs are recorded and content is automatically divided according to the card's capacity settings.	<ul style="list-style-type: none"> <li style="margin-right: 10px;">●8 MB <li style="margin-right: 10px;">●16 MB <li style="margin-right: 10px;">●32 MB <li style="margin-right: 10px;">●64 MB <li style="margin-right: 10px;">●128 MB <li style="margin-right: 10px;">●256 MB <li style="margin-right: 10px;">●512 MB <li style="margin-right: 10px;">●1 GB <li style="margin-right: 10px;">●2 GB
Video	3-D Y/C Separation Turn 3-D Y/C separation on or off.	<ul style="list-style-type: none"> ●On: Reduces noise for recording by separating the luminance (Y) and color (C) signals received from the television station. ●Off: Reduces the ghosting that occurs when recording fast moving images.
	Hybrid VBR Resolution Switch between automatic and fixed hybrid VBR resolution when recording.	<ul style="list-style-type: none"> ●Automatic: Video compression is automated providing efficient recording. ●Fixed: Video compression is fixed when recording providing smooth video play.
	Still Mode Select the type of picture shown when you pause play. (→page 62, Frame still and field still)	<ul style="list-style-type: none"> ●Automatic ●Field: Less blurred field stills are shown. Select if jittering occurs when "Automatic" is selected. ●Frame: Sharper frame stills are shown. Select if small text or fine patterns cannot be seen clearly when "Automatic" is selected.
	Seamless Play Turn seamless play on or off on discs with play lists.	<ul style="list-style-type: none"> ●On: The scenes in play lists are played seamlessly. This does not work when there are several audio types included on the play list and when using Quick View. Additionally, the positioning of scene segments may change slightly. ●Off: The points where scenes in play lists change are played accurately, but the picture may freeze for a moment.
	Black Level Control Select normal, lighter or darker for adjusting the black level control to the desired setting for picture enhancement.	<ul style="list-style-type: none"> ●Input Level (Lighter/Darker): Adjusts the black level of the input signal (e.g., L1, L2, L3) ●Composite & S Video Output Level (Lighter/Darker): when connected to a TV through the VIDEO OUT or S-VIDEO OUT terminal ●Component Video Output Level (Lighter/Normal/Darker): when connected to a TV through the COMPONENT VIDEO OUT (Y/P_B/P_R) terminal
Audio	PLAY ×1.3 & Audio during Search [HDD] [RAM] [DVD-R] [DVD-A] [DVD-V] [VCD] Choose whether to have sound during the first level of fast-forward. Quick View (→page 21) does not work if you make the setting "Off".	<ul style="list-style-type: none"> ●On ●Off – You may hear sound regardless of this setting with some discs.
	D. Range Compression [DVD-V] (Dolby Digital only) Change the dynamic range for late night viewing.	<ul style="list-style-type: none"> ●On ●Off

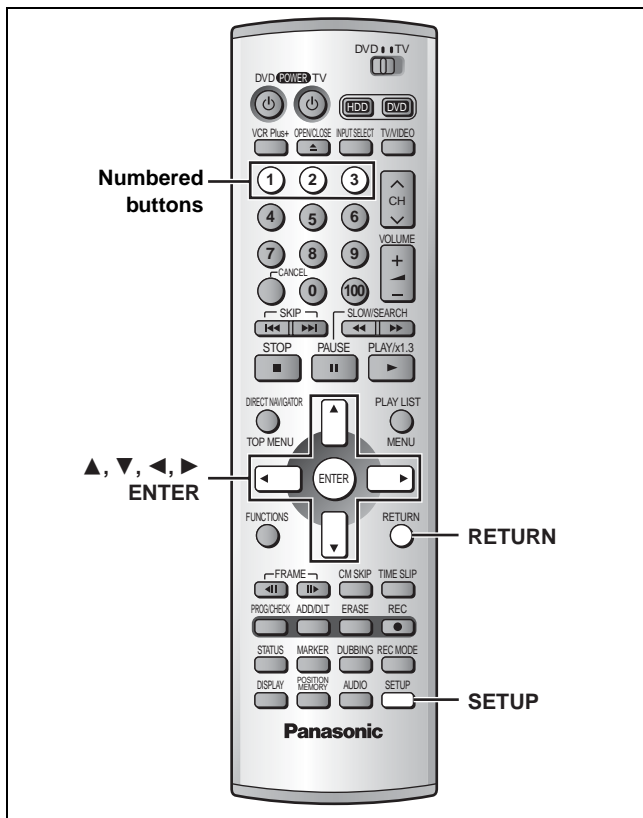

Changing the remote control code

Panasonic DVD players and recorders use the same remote control system so they may respond unintentionally to a command from this remote control. Change the code on this unit and its remote control (the two must match) if you place equipment close together.

- Use "1", the factory set code, under normal circumstances.

- 1 While stopped
Press [SETUP] to show the menus.

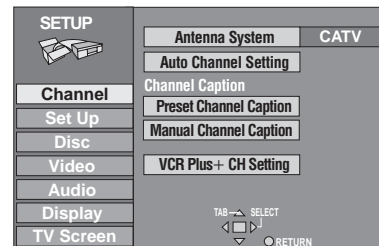

- 2 Press [▲, ▼] to select "Set Up" and press [▶].
- 3 Press [▲, ▼] to select "Remote Control Code" and press [ENTER].
- 4 Press [▲, ▼] to select the code (1, 2, or 3) and press [ENTER].

The remote control code on the unit has been set.

- 5 While pressing [ENTER] on the remote control, press and hold the numbered button ([1], [2] or [3]) corresponding to the code you selected in step 4.

The remote control code on the remote control has been set.

- 6 Press [SETUP].

The following display appears when you use a remote control with a different code.



The unit's remote control code

If you are trying to use this unit's remote control, change its code to match the unit's (→ step 5, above).

Common procedures

See pages 51—53 for menu and option details.

- 1 While stopped
Press [SETUP] to show the menus.

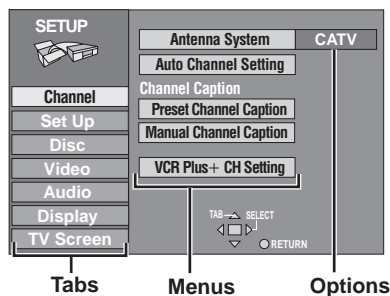

- 2 Press [▲, ▼] to select the menu's tab and press [▶].
- 3 Press [▲, ▼] to select the menu and press [ENTER].
- 4 Press [▲, ▼] to select the option and press [ENTER].

The screen now shows the menu again.

- Some items require different operations. Follow the on-screen instructions, or read the following explanations.

To return to the previous screen

Press [RETURN].

To exit the SETUP screen

Press [SETUP].

Advanced operation

Audio channel for DV input

Stereo 1 :Records sound (L1, R1) when DV recording is taking place.

Stereo 2 :Records added sound such as narration (L2, R2) subsequent to original recording.

Mix :Records both Stereo 1 and Stereo 2.

- L1+L2 are recorded in L and R1+R2 are recorded in R, except for SAP. When recording to a DVD-R or recording in LPCM audio, the audio selected in "Select MTS" (→page 53) is recorded as Stereo 1.

Clock settings

Preparation

If you connect the unit through a cable TV box or DSS receiver (→page 58), tune to your local PBS station before starting auto clock setting. Use manual clock setting if auto clock setting does not work or if there is no local PBS channel in your area.

- 1 Press [SETUP] to show the menus.
- 2 Press [▲, ▼] to select “Set Up” and press [▶].

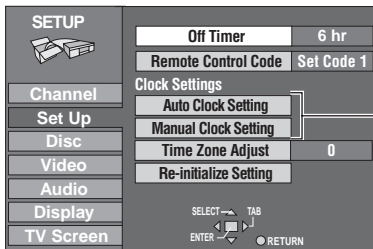

Proceed with the steps described below.

Auto Clock Setting

- 3 Press [▲, ▼] to select “Auto Clock Setting” and press [ENTER].

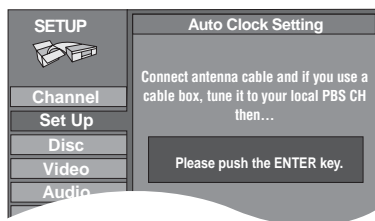

If you have not yet set channels, the “Auto Channel/Clock Setting” screen appears.

- 4 Press [ENTER].

Auto setting starts. This can take some time, up to a few hours in some cases. (To stop auto clock setting, press [RETURN].) The following screen appears when setting is complete. Press [ENTER].

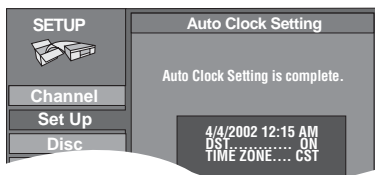

[Note]

- If the time was not set correctly, use manual clock setting or time zone adjust.
- DST, Daylight Saving Time, shows the summertime setting.
- TIME ZONE shows the time difference from Greenwich meantime (GMT).
 EST (Eastern Standard Time) = GMT - 5
 CST (Central Standard Time) = GMT - 6
 MST (Mountain Standard Time) = GMT - 7
 PST (Pacific Standard Time) = GMT - 8
 AST (Alaska Standard Time) = GMT - 9
 HST (Hawaii Standard Time) = GMT - 10
 For other areas: xx hr

Manual Clock Setting

- 3 Press [▲, ▼] to select “Manual Clock Setting” and press [ENTER].

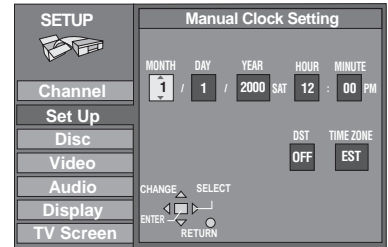

- 4 Press [◀, ▶] to select the item you want to change and press [▲, ▼] to change the setting.

MONTH ↔ DAY ↔ YEAR ↔ HOUR (12-hour display)
 ↑ TIME ZONE ↔ DST ↔ MINUTE ↓

DST (Daylight Saving Time): ON or OFF

If you select “ON”, the clock is advanced one hour starting at 2 a.m. on the first Sunday in April and ending at 2 a.m. on the last Sunday in October.

TIME ZONE (→ left):

EST ↔ CST ↔ MST ↔ PST ↔ AST ↔ HST
 (-5) (-6) (-7) (-8) (-9) (-10)

- 5 Press [ENTER].

The clock starts.

[Note]

When you change the time zone, the recording times for programs recorded before the time zone was changed also change to correspond to the new time zone.

Time Zone Adjust

Adjust the time zone (-1 or +1) if it was not set correctly with auto clock setting.

You cannot change this setting if you set the clock manually.

- 3 Press [▲, ▼] to select “Time Zone Adjust” and press [ENTER].

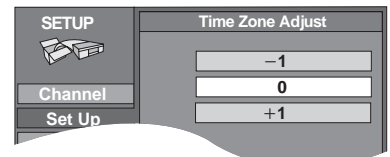

- 4 Press [▲, ▼] to select “-1”, “0”, or “+1” and press [ENTER].

The “Set Up” screen (→ step 2, left) reappears.

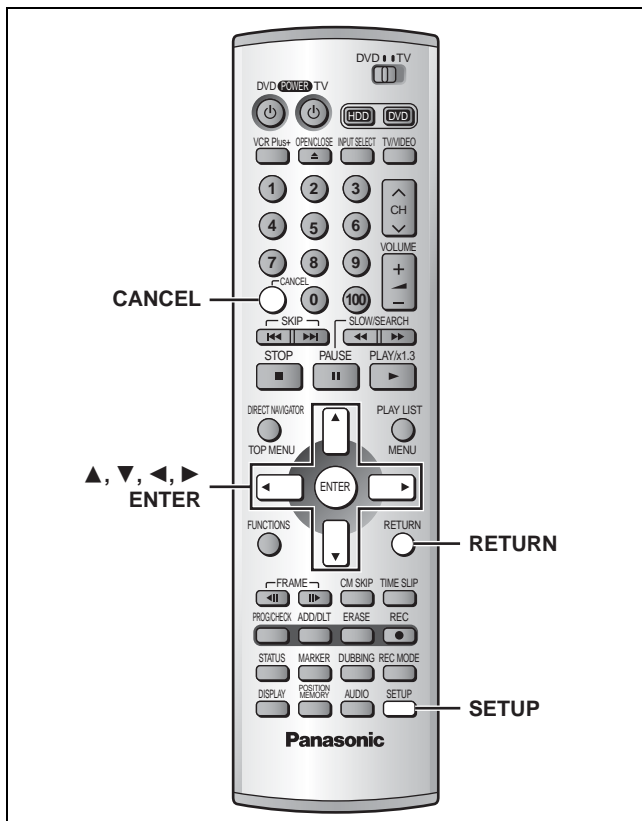

4 Press [**▲**, **▼**] to select the caption and then press [**▶**].

You can choose from the following captions.

ABC, PBS, CBS, CNN, FOX, ESPN, NBC, HBO, A&E, AMC, FAM, MAX, MTV, SHOW, TBS, USA, TNT, CBC, UPN, CTV, WB, TSN, DSC, GLOB

- The screen scrolls a page at a time if you press and hold [**▲**, **▼**].

5 Press [**▲**, **▼**] to select the channel corresponding to the caption and then press [**◀**].

- Channels are not displayed if they do not contain a station or if captions have been added manually.

- To delete the channel number, press [CANCEL].

- Repeat steps 4 and 5 as necessary.

6 Press [ENTER].

The "Channel" screen reappears.

Manual Channel Caption

3 Press [**▲**, **▼**] to select "Manual Channel Caption" and press [ENTER].

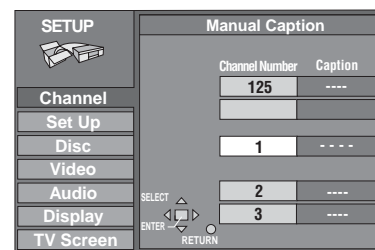

Other channel settings

You can give stations captions. You can use the preset captions, or manually enter new ones yourself.

The captions you enter are displayed when the channel is displayed and in the Direct Navigator screen.

1 Press [SETUP] to show the menus.

2 Press [**▲**, **▼**] to select "Channel" and press [**▶**].

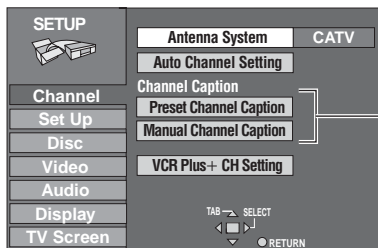

Proceed with the steps described below.

Preset Channel Caption

3 Press [**▲**, **▼**] to select "Preset Channel Caption" and press [ENTER].

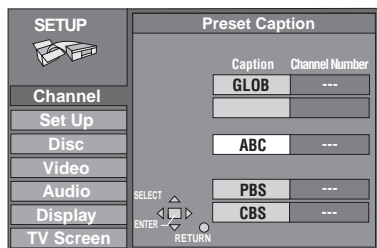

4 Press [**▲**, **▼**] to select the channel and then press [**▶**].

- Channels are only displayed if they contain a station and if preset captions have not been added.

5 Press [**▲**, **▼**] to select the first character and then press [**▶**].

- You can choose from the following characters:

- A–Z, 0–9, -, &, !, /, (space)

- To delete the caption, press [CANCEL].

- Repeat step 5 to enter the other characters.

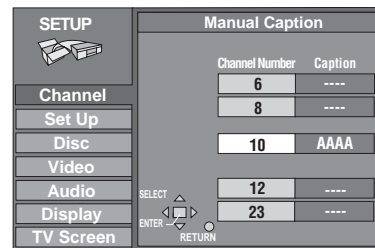

6 Press [**◀**, **▶**] to return to the Channel Number column when you are finished.

Repeat steps 4, 5, and 6 as necessary.

7 Press [ENTER].



The "Channel" screen reappears.

Refer to the relevant pages for details.

Enjoying CATV/Satellite broadcasts

What you want to do	How to do it	Reference pages	Settings	Reference pages
Enjoying CATV/Satellite broadcasts	Connect a cable TV box or satellite receiver.	58	Tune to channels correctly.	6, 7
			Change the necessary settings on the equipment you have connected.	—

Enjoying more powerful sound

Enjoying 5.1-channel surround sound with Dolby Digital and DTS 	Digital connection Connect to an amplifier with built-in decoders.	59 [A]	SETUP—Audio—Digital Audio Output ● Set PCM Down Conversion to suit the equipment. ● Set Dolby Digital and DTS to suit the equipment.	53
			Change speaker settings on the amplifier.	—
Enjoying stereo or Dolby Pro Logic 	Analog connection Connect to an analog amplifier or system component.	59 [B]	SETUP—Audio—Digital Audio Output ● Set PCM Down Conversion to Off.	53
			Digital connection Connect to a digital amplifier or system component.	59 [A]

Other uses

Record to digital recording equipment or cassette deck (→page 59)
 Record from a video cassette recorder (→pages 16 and 60)

Manufactured under license from Dolby Laboratories. "Dolby" and the double-D symbol are trademarks of Dolby Laboratories.

"DTS" and "DTS Digital Out" are trademarks of Digital Theater Systems, Inc.

- The equipment connections described are examples.
- Peripheral equipment and optional cables sold separately unless otherwise indicated.
- Before connection, turn off all equipment and read the appropriate operating instructions.
- The signal from the cable TV box or satellite receiver passes through this unit to the television even when this unit is turned off.

Connecting a cable TV box/satellite receiver

You need to subscribe to a cable TV or satellite TV service, to enjoy viewing their programming.

- Consult your service provider regarding appropriate cable TV box or satellite receiver.
- Select the applicable input on your television to view the output from your cable box/satellite receiver through this unit.

One cable TV box/satellite receiver

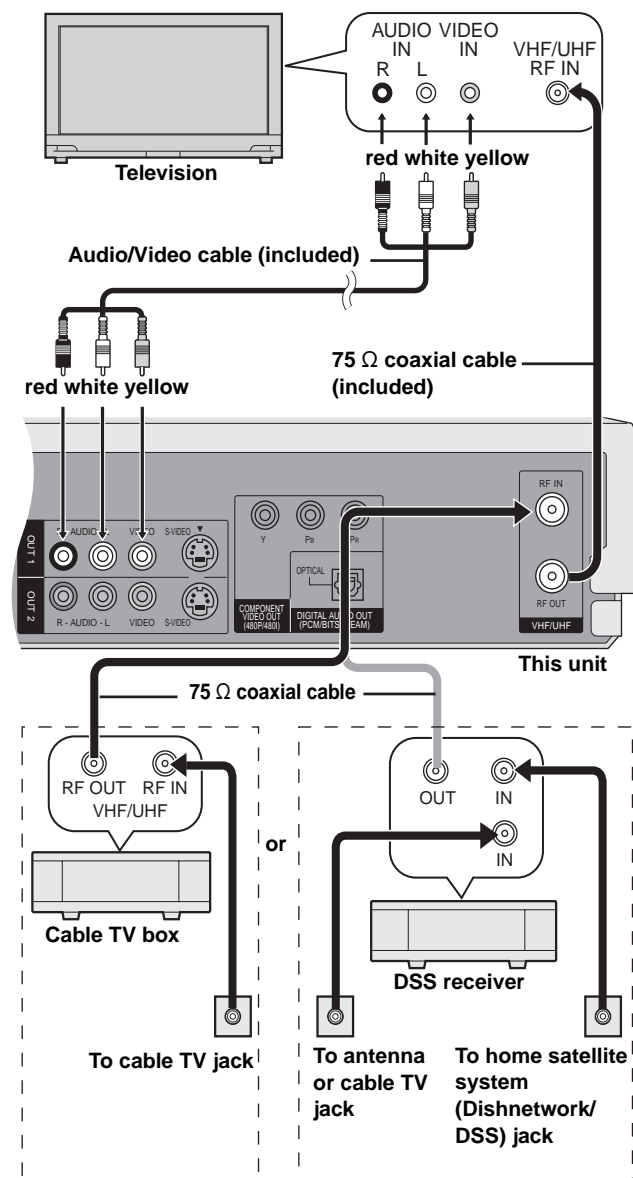

Two cable TV boxes

You can record and view both scrambled and unscrambled channels if connections are made as shown in the diagram below.

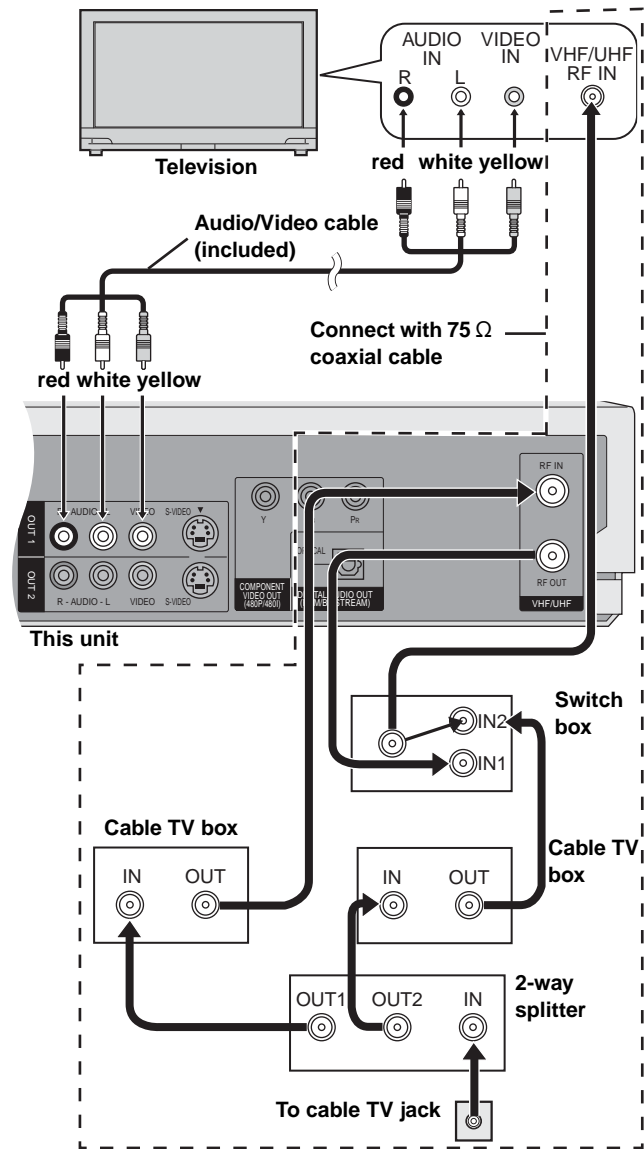

Advanced operation

[Note]

When a home satellite system (Dishnetwork/DSS) is connected, auto tuning and auto clock setting may not operate properly. Set the clock manually (→page 55).

- Change the video input on the television when you want to watch another program while recording.
- You cannot do a timer recording unless the channel is first selected on the cable TV box or DSS receiver.

- Change the video input on the television when you want to watch another program while recording.
- You cannot do a timer recording unless the channel is first selected on the cable TV box.

Connecting an amplifier or system component

This model can play Dolby Digital, but only in two channels. This model does not have a DTS decoder. You must connect a unit with a Dolby Digital or DTS decoder to enjoy surround sound.

A Digital connection

To enjoy multi-channel surround sound

Connect an amplifier with a built-in decoder or a decoder-amplifier combination.

- Change the settings in "Digital Audio Output" (→page 53).

[Note]

- You cannot use DTS Digital Surround decoders not suited to DVD.
- Even if using this connection, output will be only 2 channels. [DVD-A]

To enjoy stereo or Dolby Pro Logic

Connect a digital amplifier or system component.

- Change the settings in "Digital Audio Output" (→page 53).

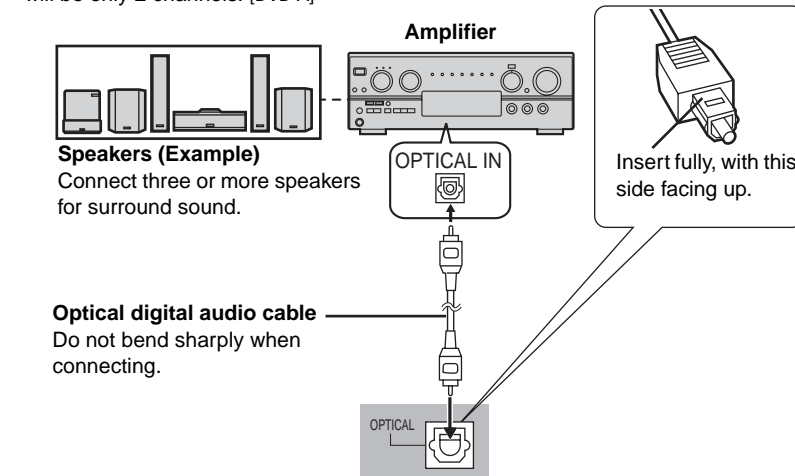

B Analog connection

To enjoy stereo or Dolby Pro Logic

Connect an analog amplifier or system component.

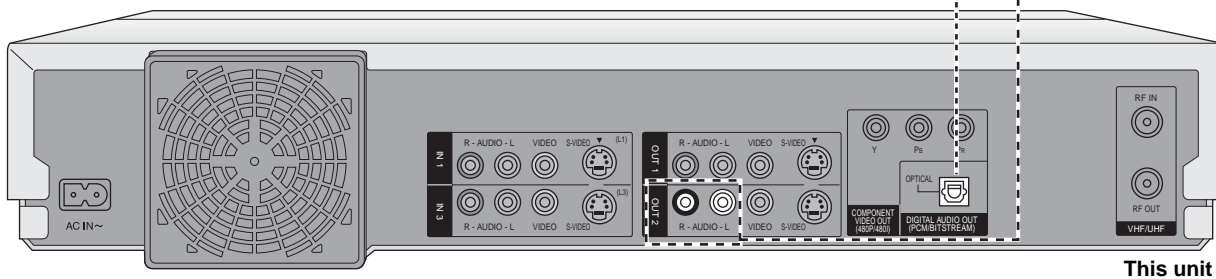
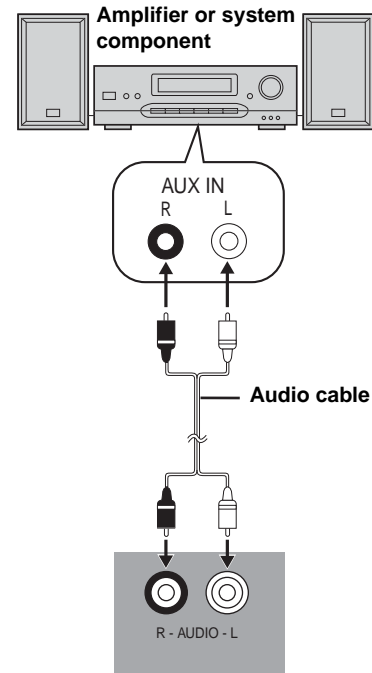

Recording to digital recording equipment or cassette tapes

Digital recording

You can record the digital signal directly to digital recording equipment (→ Connection [A] above).

[Note]

- With DVD, the following conditions must be met: (a) the disc doesn't have protection preventing digital recording, and (b) the recording equipment can handle signals with a sampling frequency of 48 kHz.
- You cannot record DTS signals.
- You cannot record MP3.

When recording DVDs, make the following settings.

V.S.S.: OFF (→page 49)

PCM Down Conversion: On (→page 53)

Dolby Digital: PCM (→page 53)

DTS: Off (→page 53)

Analog recording

You can record to a cassette deck or other recording equipment (→ Connection [B] above).

There are no limitations on recording analog signals as there are with digital signals.

Connecting other video equipment

Connecting to the L2 and DV input terminals on the front of the unit

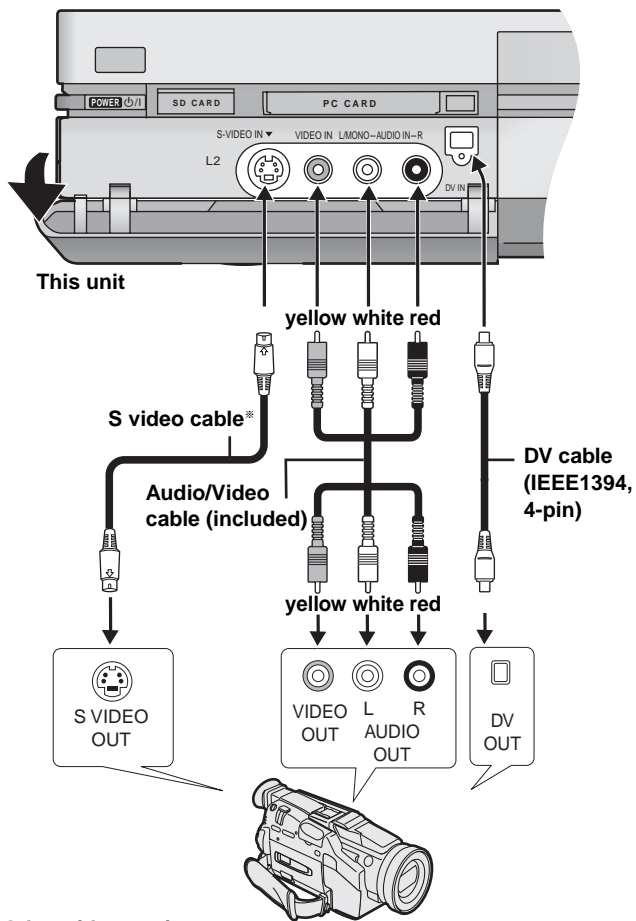

Other video equipment

Connect to the video and audio output terminals.

*By using the S video cable instead of the yellow video cable you may make recordings of higher picture quality.

- If the audio output of the other equipment is monaural, connect to L/MONO. (Both left and right channels are recorded when connected through L/MONO.)
- The DV input on this unit is for use with DV equipment only.
- When DV equipment is connected, it is not possible to operate the unit from the other equipment.
- Only one piece of DV equipment (e.g., Digital Video Camcorder) can be connected to the unit via the DV Input terminal.
- The picture compression system of the DV equipment you have connected may differ from that used in this unit. In such cases, dubbing from this equipment will not be possible.

Connecting to the input terminals on the rear of the unit, L1 and L3

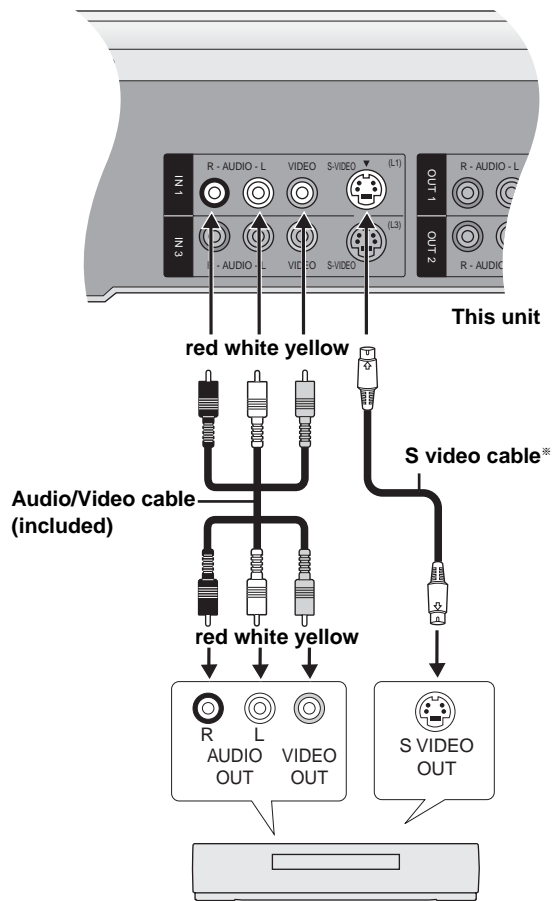

Other video equipment

Connect to the video and audio output terminals.

*By using the S video cable instead of the yellow video cable you may make recordings of higher picture quality.

[Note]

If audio output on the other equipment is monaural, use a stereo-monaural conversion cable (not included).

Other antenna connection to the unit

Use one of the following connections to suit the antenna lead.

■ A single twin lead

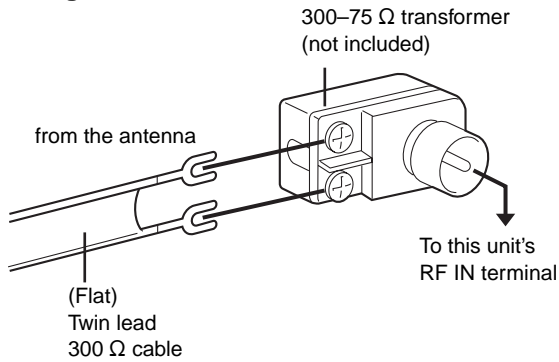

■ A twin lead and a coaxial cable

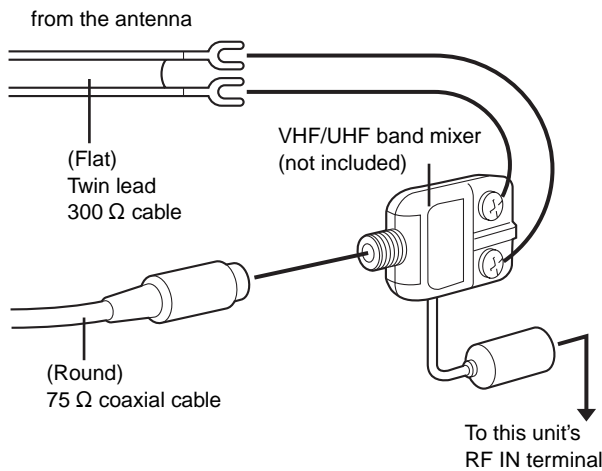

■ Two twin leads

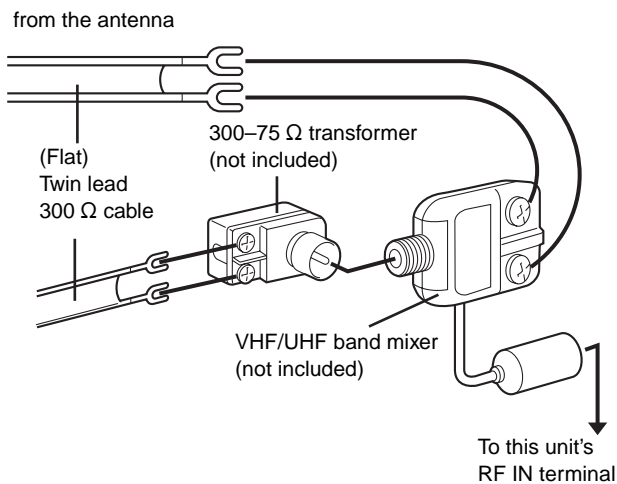

- If your television has both lead and coaxial VHF terminals, use the lead connection to minimize signal loss.

Other antenna connection from the unit to the television

Use one of the following connections to suit the antenna terminals on your television. Refer to the television's operating instructions.

■ A twin lead and coaxial plug terminal

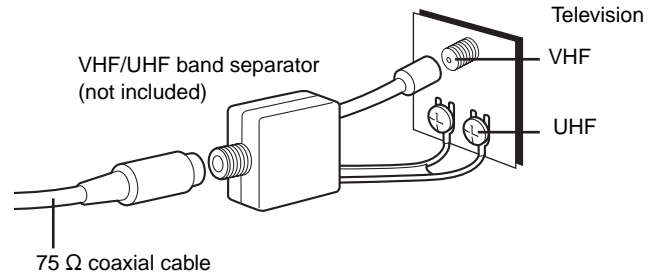

■ A twin lead terminal

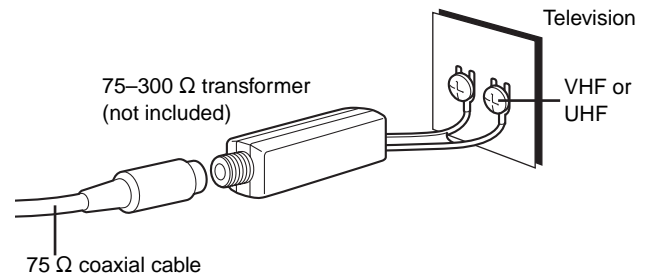

■ Two twin lead terminals

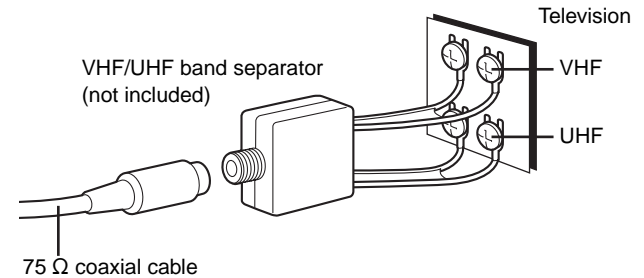

■ Multiple antenna terminals

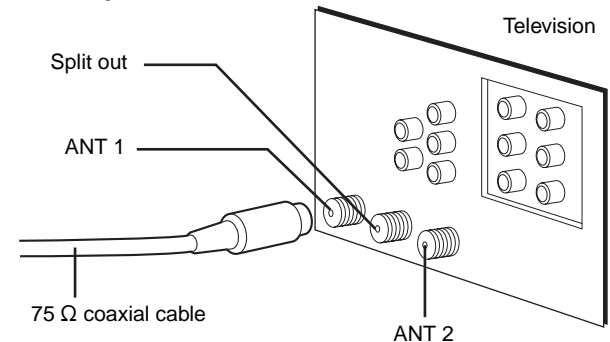

- Connect to one of the terminals, then change the television's setting as necessary.

Bitstream

This is the digital form of multi-channel audio data (e.g., 5.1 channel) before it is decoded into its various channels.

CPRM (Content Protection for Recordable Media)

CPRM is the copyright protection technology that is used to protect broadcasts that are allowed to be recorded only once (e.g. some CATV broadcasts).

Decoder

A decoder restores the coded audio signals on DVDs to normal.

Dolby Digital

This is a method of coding digital signals developed by Dolby Laboratories. Apart from stereo (2-channel) audio, these signals can also be multi-channel audio. A large amount of audio information can be recorded on one disc using this method.

This unit is set to record using Dolby Digital in all recording modes.

Dolby Pro Logic

A surround system where a 4-channel audio track is recorded as 2 channels and then is restored to 4 channels for play. The surround channel is monaural and can reproduce up to 7 kHz.

DPOF (Digital Print Order Format)

DPOF is the standard printing format for still picture data. It is used by photo developing stores to print out the still picture data taken from a digital camera and other equipment or when printing from your home printer.

Drive

In the instance of this unit, this refers to the hard disk (HDD) and DVD. These perform the reading and writing of data. Select them by pressing the drive select buttons ([HDD] or [DVD]).

DTS (Digital Theater Systems)

This surround system is used in many movie theaters around the world. There is good separation between the channels, so realistic sound effects are possible.

FAT (File Allocation Table)

The FAT12 (12-bit file allocation table) and FAT16 (16-bit file allocation table) systems this unit is compatible with are file systems used widely in computers around the world.

Film and video

DVD-Videos are recorded using either film or video. Usually, film is recorded at 24 frames per second, the rate movies are filmed at, while video is recorded at 30 frames per second.

Finalize

A process that makes play of recorded audio and video on a CD-R, CD-RW and DVD-R possible on play compatible equipment. You can finalize a DVD-R on this unit.

Frame still and field still

Frames are the still pictures that make moving pictures. About thirty are shown each second. A frame still may appear blurred but overall quality is high.

Two fields appear alternately to make up one frame. A field still is not blurred but picture quality is lower.

Hard disk drive (HDD)

This is a mass data storage device used in computers etc. A disk with a surface that has been treated with magnetic fluid is spun and a magnetic head is brought in close proximity to facilitate the reading and writing of large amounts of data at high speed.

Interlace and progressive output

NTSC, the video signal standard, has 480 interlaced (I) scan lines, whereas progressive scanning uses twice the number of scan lines. This is called 480P.

I/P/B

MPEG 2, the video compression standard adopted for use with DVD-Video, codes frames using these 3 picture types.

I: Intra coded picture

This picture has the best quality and is the best to use when adjusting the picture.

P: Predictive coded picture

This picture is calculated based on past I- or P-pictures.

B: Bidirectionally-predictive coded picture

This picture is calculated by comparing past and future I- and P-pictures so it has the lowest volume of information.

JPEG (Joint Photographic Experts Group)

This is a system used for compressing/decoding color still pictures. If you select JPEG as the storage system on digital cameras etc., the data will be compressed to 1/10–1/100 of its original size. The special quality of this standard is that there is little deterioration in picture quality in comparison to the degree of compression.

Linear PCM (pulse code modulation)

These are uncompressed digital signals, similar to those found on CDs. LPCM sound is available when recording in XP mode.

MPEG2/MPEG4 (Moving Picture Experts Group)

A standard for efficiently compressing and expanding color video. MPEG2 is a compression standard used for DVD and satellite based digital broadcasting and this unit records programs using MPEG2.

MPEG4 is a compression standard created for use with mobile equipment and use over networks, providing highly efficient recordings even with low bit rates.

Playback control (PBC)

If a Video CD has playback control, you can select scenes and information with menus.

Pan&Scan/Letterbox

In general, DVD-Video discs are produced for viewing on wide-screen televisions with an aspect ratio of 16:9. This means you can view most material with the intended aspect ratio on a widescreen television.

Material with this ratio will not fit onto a standard television with an aspect ratio of 4:3. Two styles of picture, "Pan&Scan" and "Letterbox", deal with this problem.

Pan&Scan: The sides are cut off so the picture fills the screen.



Letterbox: Black bands appear at the top and bottom of the picture so the picture itself appears in an aspect ratio of 16:9.



TIFF (Tag Image File Format)

A still picture data standard. A common format for storing high quality images on digital camera's and other devices.

Disc handling

How to hold a disc or card

Do not touch the play surface or the terminal surface.

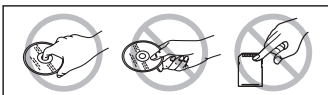

If there is dirt or condensation on the disc

Moisture may condense on discs after they are brought inside from the cold.

DVD-RAM and DVD-R

Clean with an optional DVD-RAM/PD disc cleaner (LF-K200DCA1, where available).

Do not use cleaners or cloths for CDs to clean DVD-RAM and DVD-R.

DVD-Audio, DVD-Video, Video CD, CD

Wipe with a damp cloth and then wipe dry.

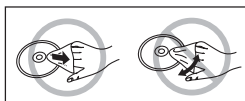

Handling precautions

- Do not attach labels or stickers to discs. (This may cause disc warping, rendering it unusable)
- Do not write on the label side with a ball-point pen or other writing instrument.
- Do not use record cleaning sprays, benzene, thinner, static electricity prevention liquids or any other solvent.
- Do not use scratch-proof protectors or covers.
- Do not expose the terminals of the card to water, garbage or other strange things.
- Do not use the following discs:
 - Discs with exposed adhesive from removed stickers or labels (rented discs etc).
 - Discs that are badly warped or cracked.
 - Irregularly shaped discs, such as heart shapes.

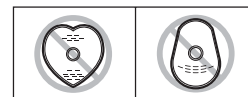

On the television

Page

Error has occurred. Please press ENTER.	<ul style="list-style-type: none"> ● A serious, but temporary error has occurred and one of the unit's safety devices has activated. Press [ENTER]. The unit switches to the standby mode. Press [⏻, DVD POWER] to turn the unit on again. 	—
No disc. No valid disc.	<ul style="list-style-type: none"> ● The disc is upside down. 	14
No PC card. No valid PC card. No SD card. No valid SD card.	<ul style="list-style-type: none"> ● The card is not inserted. If this message is displayed with a compatible card already inserted, turn off the power, remove and then re-insert the card. ● The card inserted is not compatible or the card format does not match. ● Format the card. 	22 11 40, 42
This is non-recordable disc.	<ul style="list-style-type: none"> ● The unit cannot record on the disc you inserted. Insert a DVD-RAM or unformatted DVD-R. ● You cannot format a microdrive or mobile hard disk on this unit. 	10 —
This disc is not formatted properly.		
Unable to format.		
No disc can be read. This disc cannot be read.	<ul style="list-style-type: none"> ● You inserted an incompatible disc. ● An unformatted DVD-RAM is in the tray. Format the DVD-RAM. 	10 44
No valid HDD card.	<ul style="list-style-type: none"> ● Insert a mobile hard disk that has been recorded using a Panasonic SD media storage device. 	—
Please check write protect tab on the disc cartridge.	<ul style="list-style-type: none"> ● Release protection from the DVD-RAM cartridge or the card. 	—
Cannot write.		
Protected programs are existed.	<ul style="list-style-type: none"> ● The program is write-protected. Cancel the protection. 	36
Contents of this disc are protected.	<ul style="list-style-type: none"> ● The disc is write-protected. Cancel Disc Protection. 	44
Cannot finish recording completely.	<ul style="list-style-type: none"> ● The program was copy-guarded. 	—
Cannot record. Disc is full.	<ul style="list-style-type: none"> ● No space left on the HDD, disc or card. → Create space by erasing any unwanted programs. [HDD] [RAM] → Use a new disc or card. 	36 —
Cannot record. Maximum amount of programs exceeded.		
Cannot record on the disc.	<ul style="list-style-type: none"> ● The disc is scratched. Use another disc. ● The disc is dirty. 	— 62
Please change the disc.	<ul style="list-style-type: none"> ● Press [▲] to remove the disc. (Power goes off.) 	—
This disc may not be played in your region.	<ul style="list-style-type: none"> ● You tried to play a disc with a region number different from this unit's region number. This unit can only play discs with the region numbers compatible with this unit (1, All, or including the number 1). 	Cover page
Your selection exceeds the recorder's rating limit.	<ul style="list-style-type: none"> ● A ratings level has been set for DVD-Video with this unit. Unlock the unit with "Ratings" in "Disc". 	51
Finalizing is necessary for compatible playback.	<ul style="list-style-type: none"> ● To enable playback of your DVD-R on compatible equipment, it is necessary to finalize it. 	44
⊘	<ul style="list-style-type: none"> ● Operation is restricted on this unit or disc. 	—
Cannot playback on this unit.	<ul style="list-style-type: none"> ● You tried to play a non-compatible image. ● Turn the power off on the main unit and re-insert the card. 	11 22
No folder	<ul style="list-style-type: none"> ● There is no compatible folder in this unit. 	23

On the unit's display

NO READ	<ul style="list-style-type: none"> ● The disc is dirty or badly scratched. → Clean the disc if it is dirty. → The disc cannot be played if it is scratched and this display doesn't disappear. ● The unit cannot read the disc. ● You have used a DVD-RAM/PD lens cleaner and it has finished. 	62 — — —
SELF CHECK	<ul style="list-style-type: none"> ● There was a power failure or the AC plug was disconnected while the power was on. The unit is carrying out its recovery process. Wait until the message disappears. 	—
UNSUPPORT	<ul style="list-style-type: none"> ● You have inserted a disc the unit cannot play or record on. 	10
HARD ERR	<ul style="list-style-type: none"> ● If the message does not go away after turning the power off and on, consult your dealer for service. 	—
HDD SLEEP	<ul style="list-style-type: none"> ● In order to extend HDD life, the HDD is in SLEEP mode. 	11
PROG FULL	<ul style="list-style-type: none"> ● There are already 32 timer recordings. Erase unnecessary timer recordings. 	29
<input type="checkbox"/> CHK REMOTE ("□" stands for a number.)	<ul style="list-style-type: none"> ● The remote control and main unit are using different codes. Change the code on the remote control. 	54
U14	<ul style="list-style-type: none"> ● The unit is hot. → The unit switches to standby automatically for safety reasons and you cannot operate it. Wait for about 30 minutes for the service number to disappear. → Select a position with good ventilation when installing the unit. → Do not block the cooling fan on the rear of the unit. 	— — —
U99	<ul style="list-style-type: none"> ● The unit fails to operate properly. Press [⏻, DVD POWER] to switch the unit to standby. Now press [⏻, DVD POWER] again to turn the unit on. 	—

Troubleshooting guide

Before requesting service, make the below checks. If you are in doubt about some of the check points, or if the remedies indicated in the chart do not solve the problem:

In the U.S.A., contact the Panasonic Customer Call Center at 1-800-211-7262, or e-mail consumerproducts@panasonic.com, or the website (<http://www.panasonic.com>).

In Canada, contact the Panasonic Canada Inc. Customer Care Centre at 1-800-561-5505, or visit the website (www.panasonic.ca), or an authorized Servicentre closest to you.

The following do not indicate a problem with the unit.		
<ul style="list-style-type: none"> • Sounds occurring periodically during disc rotation. • Video becomes distorted during searching. • A sound is heard when the HDD goes into the SLEEP mode, or operations are slow to respond in SLEEP mode. 	<ul style="list-style-type: none"> • Video reception is poor due to adverse weather conditions. • Reception problems due to a temporary stop of the broadcast signal. • "Press the RESET button" etc. message is displayed when playing a card on other equipment that was dubbed on this unit. 	

Power		Page
No power.	<ul style="list-style-type: none"> • Insert the AC power supply cord securely into a known active AC outlet. 	5
The unit switches to the standby mode.	<ul style="list-style-type: none"> • This is a power saving feature. You can turn it off if you would prefer (Set Up—Off Timer—Off). Press [⏻, DVD POWER] to turn the unit on. • One of the unit's safety devices may have activated. Press [⏻, DVD POWER] to turn the unit on. 	51 —

Operation		
The unit is on but cannot be operated.	<ul style="list-style-type: none"> • Some operations may be prohibited by the disc. • Recording drive or playback drive have not been selected properly. • The unit is hot ("U14" appears on the display). Wait for "U14" to disappear. • One of the unit's safety devices may have activated. <p>Reset the unit as follows:</p> <ol style="list-style-type: none"> 1. Press [⏻, DVD POWER] to switch the unit to standby. If the unit doesn't switch to standby, press and hold [⏻, DVD POWER] for about 10 seconds. The unit is forcibly switched to standby. Alternatively, disconnect the AC power supply cord, wait one minute, then reconnect it. 2. Press [⏻, DVD POWER] to turn the unit on. 	— 14, 18 63 —
HDD activation is slow.	<ul style="list-style-type: none"> • The HDD is in SLEEP mode. ("HDD SLEEP" appears in the unit's display.) 	11
Cannot eject disc or card.	<ul style="list-style-type: none"> • You cannot remove the disc while playing/editing still pictures or SD VIDEO (MPEG4) programs. Press [RETURN] several times to exit the play/edit screen. • The unit may have a problem. With the power off, press and hold [■] and [CH▲] at the same time on the main unit for about 5 seconds. Remove the disc and consult the dealer. 	— —

Picture		
<ul style="list-style-type: none"> • When progressive output is on, refer also to "Progressive video" below. 		

The images from this unit do not appear on the television.	<ul style="list-style-type: none"> • Make sure that the television is connected to the AUDIO/VIDEO terminal, S-VIDEO OUT terminal or COMPONENT VIDEO OUT terminals on this unit. • Make sure that the television's input setting (e.g., VIDEO 1) is correct. • When using this unit for the first time, the HDD has nothing recorded on it. You must record a program etc. to the HDD before you can enjoy playback. • You have set "TV Type" to "Aspect 4:3 & 480P" or "Aspect 16:9 & 480P" in the TV Screen menu, but the television isn't compatible with progressive signals. Press and hold [■] and [TIME SLIP] on the unit at the same time for about 5 seconds. The setting will change to interlace. 	5 — 14 —
Television reception worsens after connecting the unit.	<ul style="list-style-type: none"> • This can occur because the signals are being divided between the unit and the television. It can be solved by using a signal booster, available from audio-visual suppliers. Consult your dealer if reception does not improve. • Due to inherent characteristics of the HDD, the picture may occasionally be disturbed. This is normal. 	— —
Screen size is wrong.	<ul style="list-style-type: none"> • Check the settings on your television. • Check the settings for "TV Type", "4:3 TV Settings for DVD-Video" or "4:3 TV Settings for DVD-RAM" in the TV Screen menu. 	— 9, 53
On-screen messages do not appear.	<ul style="list-style-type: none"> • Go to the Display menu and select "Automatic" for "Status Messages". 	53
The blue background does not appear.	<ul style="list-style-type: none"> • Go to the Display menu and select "On" for "Blue Background". 	53
There is ghosting.	<ul style="list-style-type: none"> • Change the settings for "3D NR", "Block NR", and "Mosquito NR" to "0" or turn "MPEG-DNR" off if it is on. 	49, 50
Play stops for a moment during Quick View.	<ul style="list-style-type: none"> • Play may stop where two play lists join, but this is not a malfunction. 	—

Progressive video		
There is ghosting when progressive output is on.	<ul style="list-style-type: none"> • Set "Progressive" to "OFF". This problem is caused by the editing method or material used on DVD-Video, but should be corrected if you use interlace output. 	49
There is no apparent change in picture quality when adjusted with the Video menu in the on-screen menus.	<ul style="list-style-type: none"> • The effect is less perceivable with some types of video. 	—

Sound

		Page
No sound. Low volume. Distorted sound. Cannot hear the selected audio.	<ul style="list-style-type: none"> ● Check the connections. Check the input mode on the amplifier if you have connected one. 	5, 58–60
	<ul style="list-style-type: none"> ● Turn V.S.S. off if it causes distortion. 	49
	<ul style="list-style-type: none"> ● While playing SAP audio, you may hear audio coming from another sub-channel even if you have properly selected the audio. Turn the V.S.S. setting off. 	49
Cannot hear the desired audio type.	<ul style="list-style-type: none"> ● Press [AUDIO] to select the desired audio type. 	25
	<ul style="list-style-type: none"> ● If "D.MIX" does not appear in the display when playing multi-channel DVD-Audio, audio output will be the front two speakers only. 	13
	<ul style="list-style-type: none"> ● You cannot change the DVD-Audio audio type if the software producer has restricted play in stereo. 	—
Cannot switch audio during stereo or SAP broadcasts.	<ul style="list-style-type: none"> ● You have used digital connection. Set "Dolby Digital" to "PCM" or connect to other equipment using audio cables (analog connection). 	53, 59
	<ul style="list-style-type: none"> ● You cannot switch the audio in the following cases. <ul style="list-style-type: none"> – While the DVD drive is selected and when a DVD-R is in the disc tray – When recording mode is XP and "LPCM" has been selected in the Audio menu, "Audio Mode for XP Recording" – When "Rec in DVD-R high speed mode" is set to "On" – Dubbing in "MPEG2 to 4" mode. 	
	<ul style="list-style-type: none"> ● Select "Main" or "SAP" from "Select MTS" in the Audio menu before recording. 	53
	<ul style="list-style-type: none"> ● The audio recorded with SD VIDEO (MPEG4) is monaural and cannot be changed. 	—

Play

Play fails to start even when [▶] (PLAY) is pressed. Play starts but then stops immediately.	<ul style="list-style-type: none"> ● Insert the disc correctly with the label facing up. 	14
	<ul style="list-style-type: none"> ● This unit cannot play discs or cards other than the ones listed in these operating instructions. 	10
	<ul style="list-style-type: none"> ● The disc is dirty. Clean it. 	62
	<ul style="list-style-type: none"> ● The disc may be badly scratched. 	—
	<ul style="list-style-type: none"> ● You inserted a blank disc or card. ● You cannot play discs during DV Automatic Recording. 	—
A title or chapter doesn't play when it is selected.	<ul style="list-style-type: none"> ● Some titles and chapters on DVD-Video are not played when you have changed the ratings level. 	51
Alternative soundtrack and subtitles cannot be selected.	<ul style="list-style-type: none"> ● The languages are not recorded on the disc. ● You may have to use the disc's menus to select languages. 	— 19
No subtitles.	<ul style="list-style-type: none"> ● Subtitles are not recorded on the disc. ● Turn the subtitles on. 	— 48
Angle cannot be changed.	<ul style="list-style-type: none"> ● This function depends on software availability. Angles can only be changed during scenes where different angles are recorded. 	—
You have forgotten your ratings password.	<ul style="list-style-type: none"> ● Return the ratings setting to "8". While the disc tray is open, press and hold [◀◀/▶▶] and [▶▶/▶▶] on the main unit at the same time for 5 or more seconds. 	—

Displays

The display is dim.	<ul style="list-style-type: none"> ● Go to the Display menu and change the display's brightness with "FL Display". 	53
"12:00" is flashing on the unit's display.	<ul style="list-style-type: none"> ● The clock is not set. 	55
The displayed recording/dubbing time and actual recording/dubbing time differ.	<ul style="list-style-type: none"> ● Displayed recording time is based on the number of frames per second. This number is subject to minute variations. When recording over long periods, these variations may result in the difference between displayed recording time and actual recording time. This is normal. 	—
	<ul style="list-style-type: none"> ● The current progress indicator may not display properly while dubbing. 	—
	<ul style="list-style-type: none"> ● When dubbing video without rapid movement using the "MPEG2 to 4" mode dubbing may be possible at a capacity lower than indicated. 	—
	<ul style="list-style-type: none"> ● Recording or editing content on a DVD-R more than 200 times will reduce the remaining amount of space. 	—
The display doesn't show the correct time. [MP3]	<ul style="list-style-type: none"> ● Times may not appear correctly when searching through tracks recorded with a variable bit rate. 	—

Remote control

The remote control doesn't work.	<ul style="list-style-type: none"> ● [DVD, TV] is not switched to "DVD". Switch to "DVD" when operating this unit. 	12
	<ul style="list-style-type: none"> ● The remote control and main unit are using different codes. Change the code on the remote control. 	54
	<ul style="list-style-type: none"> ● The batteries are depleted. Replace them with new ones. 	6
	<ul style="list-style-type: none"> ● Point the remote control at the remote control sensor on the main unit. 	6
	<ul style="list-style-type: none"> ● Remove obstacles from between the remote control and main unit. 	—
Cannot operate the television.	<ul style="list-style-type: none"> ● Change manufacturer code. Some televisions cannot be operated even if you change the code. ● [DVD, TV] is not switched to "TV". Switch to "TV" when selecting the receiving channel for the television. 	9 —

Recording/Timer recording/Dubbing

		Page
Cannot record.	● You haven't inserted a disc or the disc you inserted cannot be recorded on. Insert a disc the unit can record onto.	10
	● The disc is unformatted. Format the disc so this unit can record on it.	44
	● The write-protect tab on the cartridge is set to PROTECT.	10
	● Some programs have limitations on the number of times they can be recorded (CPRM).	15
	● The disc is protected with DISC SETTING.	44
	● The HDD or the disc is full or nearly full. Erase unneeded programs or use another disc.	36
	● You cannot record on finalized DVD-R discs.	—
	● Recording to a DVD-R may no longer be possible if you perform the following types of operations 50 or more times. When repeatedly inserting or removing the DVD-R and when the power is switched on or off while the DVD-R is in the unit tray.	—
	● A DVD-R recorded on this unit may not be recordable on other Panasonic DVD recorders.	—
	●	—
VCR Plus+ programming does not work properly.	● The guide channels are incorrect. Go to the Channel menu and correct them with "VCR Plus+ CH Setting".	8
	● The clock is wrong. Go to the Set Up menu and correct it with "Clock Settings".	55
Timer recording does not work properly.	● The timer program is incorrect. Correct the program.	29
	● Different timer program times overlap.	—
	● The clock is wrong. Go to the Set Up menu and correct it with "Clock Settings".	55
The unit switches to standby while making a timer recording.	● The disc has run out of space. Use a disc that has enough space to record the program.	—
The timer program remains even after recording finishes.	● The timer program remains if set to daily or weekly.	27
Timer recording does not stop even when [■] is pressed.	● Press [■] and then [ENTER] within 5 seconds to turn "Ⓞ" off. Recording stops.	—
The available recording time doesn't increase even after erasing recordings on the disc.	● As this unit is unable to erase data written to DVD-RAM with a computer, the available recording time does not increase. The data will be erased if you reformat the disc.	44
	● If the disc is dirty, wipe with the DVD-RAM/PD disc cleaner (optional) before formatting.	62
	● Available recording space on the DVD-R does not increase even after erasing previously recorded programming.	—
	● The available recording time will become smaller after recording still pictures, and SD VIDEO (MPEG4) programs.	—
A part or whole of a recorded program has been lost.	● If there is a power failure or the plug is disconnected from the household AC outlet while recording or editing, the program may be lost or the HDD/disc may become unusable. → We cannot offer any guarantee regarding lost programs or discs. You will have to format the HDD/disc or use a new disc.	—
Cannot dub to a DVD-R disc using the high speed mode.	● When recording to the HDD, set "Rec in DVD-R high speed mode" to "On" from the Disc menu. Note that you cannot dub programs to a DVD-R disc using the high speed mode if you recorded the program on a DVD recorder that does not have the "Rec in DVD-R high speed mode" function, even when dubbing to the HDD with this setting "On".	52
When dubbing to a DVD-R, it takes a long time even when high speed mode is selected.	● It takes longer than normal when dubbing programs that contain LPCM audio.	—
	● Use a DVD-R that is compatible with high speed recording.	—
	● Dubbing will take longer than normal when there are many programs.	—
An unusually large sound is coming from the rotating DVD-R.	● When recording or high speed dubbing to a DVD-R, the sound of the disc rotating may be larger than normal, however, this is not a problem.	—

Still pictures/SD VIDEO (MPEG4) programs

The contents of the card cannot be read.	● The card format is not compatible with the unit. (The contents on the card may be damaged.) → Format using FAT 12 or FAT 16 with other equipment or format the card with this unit.	40, 42
	● The card contains a folder structure and or file extensions that are not compatible with this unit.	23
	● Turn off and then turn on the unit again.	—
Copying, erasing and setting protection takes a long time.	● When there are a lot of folders and files, it may sometimes take a few hours.	—
	● When repeating copying or erasing, it may sometimes take a long time. Format the disc or card.	40, 42, 44
The PC card cannot be removed.	● Make sure the PC card is slotted home firmly before attempting to remove.	22

Discs make sounds as they rotate. This does not indicate a malfunction.

Maintenance

The precision parts in this unit are readily affected by the environment, especially temperature, humidity, and dust. Cigarette smoke also can cause malfunction or breakdown.

To clean this unit, wipe with a soft, dry cloth.

- Never use alcohol, paint thinner or benzene to clean this unit.
- Before using chemically treated cloth, read the instructions that came with the cloth carefully.

Observe the following points to ensure continued listening and viewing pleasure.

Dust and dirt may adhere to the unit's lens over time, making it impossible to record or play discs.

Use the **DVD-RAM/PD lens cleaner (LF-K123LCA1)** about once every year, depending on frequency of use and the operating environment. Read the lens cleaner's instructions carefully before use.

Specifications

Recording system:	DVD video recording standards (DVD-RAM), DVD video standards (DVD-R)
Optical pick-up:	System with 1 lens, 2 integration units (662 nm wavelength for DVDs, 790 nm wavelength for CDs)
Recordable discs:	12 cm (5") 4.7 GB DVD-RAM discs 12 cm (5") 9.4 GB DVD-RAM discs 8 cm (3") 2.8 GB DVD-RAM discs 12 cm (5") 4.7 GB DVD-R discs 8 cm (3") 1.4 GB DVD-R discs (for General Ver. 2.0) 12 cm (5") 4.7 GB DVD-R discs (for General Ver. 2.0/4×-SPEED DVD-R Revision 1.0)
Recording time:	<ul style="list-style-type: none"> ●Max. 6 hours (using 4.7 GB disc) <ul style="list-style-type: none"> XP: 60 minutes SP: 120 minutes LP: 240 minutes EP: 360 minutes ●Max. 160 hours (using Built-in HDD: HDD capacity 120 GB) <ul style="list-style-type: none"> XP: 26 hours SP: 52 hours LP: 104 hours EP: 160 hours (Continuous Recording time is 6 hours max.)
Discs played:	12 cm (5") 4.7 GB DVD-RAM discs 12 cm (5") 9.4 GB DVD-RAM discs 8 cm (3") 2.8 GB DVD-RAM discs 12 cm (5") 4.7 GB DVD-R discs 8 cm (3") 1.4 GB DVD-R discs (for General Ver. 2.0) 12 cm (5") 4.7 GB DVD-R discs (for General Ver. 2.0/4×-SPEED DVD-R Revision 1.0) DVD-VIDEO discs CD-Audio discs (CD-DA) Video CD discs DVD-Audio discs CD-R/CD-RW discs (CD-DA, Video CD, MP3 formatted discs) High Speed Drive (DVD-R 4× recording speed compatible)
Drive unit:	High Speed Drive (DVD-R 4× recording speed compatible)
Card unit:	
① Still pictures (JPEG, TIFF)	
Card slot:	SD Memory Card/PC Card Type II
Compatible media:	SD Memory Card, Multi Media Card, A PC Card conforming to PC Card Standards, ATA Flash PC card, PC Card adaptor (SD Memory Card, Multi Media Card, Compact Flash, Smart Media, Memory Stick, xD picture card, Microdrive), Mobile hard disk
Format:	FAT12 or FAT16
Image format:	JPEG conforming to DCF (Design rule for Camera File system) (sub sampling; 4:2:2 or 4:2:0) TIFF (Uncompressed RGB chunky) DPOF Compatible
Number of pixels:	320 × 240 to 6144 × 4096
Thawing time:	Approx. 7 s (2 M pixels, JPEG)
② SD Video MPEG4	
Card slot:	SD Memory Card/PC Card Type II
Compatible media:	SD Memory Card, Multi Media Card (Super fine cannot be used), Mobile hard disk (read only)
Video recording system:	MPEG 4 conforming
Number of pixels:	Super fine/Fine 320 × 240 (QVGA)/Normal/Economy 176 × 144 (QCIF)
Recording rate (Max):	Super fine 1050 kbps/Fine 430 kbps/Normal 300 kbps/Economy 100 kbps (Including audio recording rate of 32 kbps)
Audio recording system:	G.726 conforming
File format:	SD VIDEO specification compliant (ASF)

③ SD Video MPEG2*	
Card slot:	SD Memory Card/PC Card Type II
Compatible media:	SD Memory Card, Multi Media Card, Mobile hard disk (read only)
File format:	SD VIDEO specification compliant
Video system	
TV system:	NTSC system, 525 lines, 60 fields
Recording system:	MPEG2 (Hybrid VBR)/MPEG4
Input:	LINE (pin jack) × 3, 1.0 Vp-p; 75 Ω S connector × 3 Y: 1.0 Vp-p; 75 Ω C: 0.286 Vp-p; 75 Ω
Output:	LINE (pin jack) × 2, 1.0 Vp-p; 75 Ω S connector × 2 Y: 1.0 Vp-p; 75 Ω C: 0.286 Vp-p; 75 Ω
Component video output (480P/480i):	Y: 1.0 Vp-p; 75 Ω Pb: 0.7 Vp-p; 75 Ω Pr: 0.7 Vp-p; 75 Ω
Antenna reception input:	TV Channel: 2ch-69ch, 75 Ω CATV Channel: 1ch-125ch, 75 Ω
Audio system	
Recording system:	Dolby Digital (XP/SP/LP/EP) LINEAR PCM (XP mode only)
Input:	LINE (pin jack) × 3 Reference input: 309 mVrms FS: 2 Vrms (1 kHz, 0 dB) Input impedance: 47 kΩ
Output:	LINE (pin jack) × 2 Reference output: 309 mVrms FS: 2 Vrms (1 kHz, 0 dB) Output impedance: 1 kΩ (Load impedance: 10 kΩ)
Number of channels:	Recording: 2 channels Playback: 2 channels
Other input/output connectors:	Digital audio optical output connector (PCM, Dolby Digital, DTS)
Operating temperature range:	5 °C-40 °C (41 °F-104 °F)
Operating humidity range:	10 %-80 % RH (no condensation)
Clock unit:	Quartz-controlled 12-hour digital display
LASER Specification	
Class I LASER Product	
Wave Length:	779-791 nm 653-662 nm
Laser Power:	No hazardous radiation is emitted with the safety protection
DV input:	IEEE 1394 Standard, 4 pin
Power supply:	AC 120 V, 60 Hz
Power consumption:	42 W
Dimensions:	Approx. 430 (W) × 79 (H) × 296 (D) mm [Approx. 16 ¹⁵ / ₁₆ "(W) × 3 ¹ / ₈ "(H) × 11 ¹¹ / ₁₆ "(D)] (excluding protrusions)
Mass:	Approx. 5.5 kg (12.13 lbs)
Power consumption in standby mode: approx. 3.5 W	

[Note]

Specifications are subject to change without notice. Mass and dimensions are approximate.

*Play is possible after converting the video recording standard and transferring to the HDD/DVD-RAM.

Limited Warranty (ONLY FOR U.S.A.)

Panasonic Consumer Electronics Company,
Division of Matsushita Electric Corporation of America
One Panasonic Way Secaucus, New Jersey 07094

Panasonic Sales Company, Division of Matsushita Electric
of Puerto Rico, Inc.,
Ave. 65 de Infantería, Km. 9.5
San Gabriel Industrial Park, Carolina, Puerto Rico 00985

Panasonic DVD Recorder Limited Warranty

Limited Warranty Coverage

If your product does not work properly because of a defect in materials or workmanship, Panasonic Consumer Electronics Company or Panasonic Sales Company (collectively referred to as "the warrantor") will, for the length of the period indicated on the chart below, which starts with the date of original purchase ("warranty period"), at its option either (a) repair your product with new or refurbished parts, or (b) replace it with a new or a refurbished product. The decision to repair or replace will be made by the warrantor.

Product or Part Name	Parts	Labor
DVD Recorder	One (1) Year	One (1) Year
Rechargeable Batteries, DVD-RAM Disc (in exchange for defective item)	Ten (10) Days	Not Applicable

During the "Labor" warranty period there will be no charge for labor. During the "Parts" warranty period, there will be no charge for parts. You must carry-in or mail-in your product during the warranty period. If non-rechargeable batteries are included, they are not warranted. This warranty only applies to products purchased and serviced in the United States or Puerto Rico. This warranty is extended only to the original purchaser of a new product which was not sold "as is". A purchase receipt or other proof of the original purchase date is required for warranty service.

Carry-In or Mail-In Service

For Carry-In or Mail-In Service in the United States call 1-800-211-PANA (7262) or visit Panasonic Web Site: <http://www.panasonic.com>
For assistance in Puerto Rico call Panasonic Sales Company (787)-750-4300 or fax (787)-768-2910.

Limited Warranty Limits And Exclusions

This warranty ONLY COVERS failures due to defects in materials or workmanship, and DOES NOT COVER normal wear and tear or cosmetic damage. The warranty ALSO DOES NOT COVER damages which occurred in shipment, or failures which are caused by products not supplied by the warrantor, or failures which result from accidents, misuse, abuse, neglect, mishandling, misapplication, alteration, faulty installation, set-up adjustments, misadjustment of consumer controls, improper maintenance, power line surge, lightning damage, modification, or commercial use (such as in a hotel, office, restaurant, or other business), rental use of the product, service by anyone other than a Factory Servicenter or other Authorized Servicer, or damage that is attributable to acts of God.

THERE ARE NO EXPRESS WARRANTIES EXCEPT AS LISTED UNDER "LIMITED WARRANTY COVERAGE". THE WARRANTOR IS NOT LIABLE FOR INCIDENTAL OR CONSEQUENTIAL DAMAGES RESULTING FROM THE USE OF THIS PRODUCT, OR ARISING OUT OF ANY BREACH OF THIS WARRANTY. (As examples, this excludes damages for lost time, travel to and from the servicer, loss of media or images, data or other recorded content. The items listed are not exclusive, but are for illustration only.) ALL EXPRESS AND IMPLIED WARRANTIES, INCLUDING THE WARRANTY OF MERCHANTABILITY, ARE LIMITED TO THE PERIOD OF THE LIMITED WARRANTY.

Some states do not allow the exclusion or limitation of incidental or consequential damages, or limitations on how long an implied warranty lasts, so the exclusions may not apply to you.

This warranty gives you specific legal rights and you may also have other rights which vary from state to state. If a problem with this product develops during or after the warranty period, you may contact your dealer or Servicenter. If the problem is not handled to your satisfaction, then write to the warrantor's Consumer Affairs Department at the addresses listed for the warrantor.

PARTS AND SERVICE WHICH ARE NOT COVERED BY THIS LIMITED WARRANTY ARE YOUR RESPONSIBILITY.

Reference

Customer Services Directory

For Product Information, Operating Assistance, Literature Request, Dealer Locations, and Customer Service inquiries please visit Web Site:

<http://www.panasonic.com>

You can purchase parts, accessories, locate your nearest servicenter and more by visiting our Web Site

or E-mail us via web:

http://www.panasonic.com/consumer_electronics/support/customerfeedback.asp

Contact:

1-800-211-PANA (7262),

Monday-Friday 9 am-9 pm; Saturday-Sunday 10 am-7 pm, EST.

For hearing or speech impaired TTY users,
TTY: 1-877-833-8855

Accessory Purchases

1-800-332-5368 (Customer Orders Only)

1-800-237-9080 (Fax Only)

(Monday-Friday 9 am to 8 pm, EST.) Panasonic Services Company

20421 84th Avenue South, Kent, WA 98032

(Accepts Visa, MasterCard, Discover Card, American Express, and Personal Check)

For hearing or speech impaired TTY users,
TTY: 1-866-605-1277

Service in Puerto Rico

Matsushita Electric of Puerto Rico, Inc. Panasonic Sales Company/Factory Servicenter:
Ave. 65 de Infantería, Km. 9.5, San Gabriel Industrial Park, Carolina, Puerto Rico 00985
Phone (787) 750-4300 Fax (787) 768-2910

F0602NY

The model number and serial number of this product can be found on either the back or the bottom of the unit. Please note them in the space provided below and keep for future reference.

MODEL NUMBER _____ DMR-E100H _____

SERIAL NUMBER _____

User memo:

DATE OF PURCHASE _____

DEALER NAME _____

DEALER ADDRESS _____

TELEPHONE NUMBER _____

Limited Warranty (ONLY FOR CANADA)

Panasonic Canada Inc.
5770 Ambler Drive, Mississauga, Ontario L4W 2T3

PANASONIC/TECHNICS PRODUCT—LIMITED WARRANTY

Panasonic Canada Inc. warrants this product to be free from defects in material and workmanship and agrees to remedy any such defect for a period as stated below from the date of original purchase.

Panasonic DVD Recorder One (1) year, parts and labour

LIMITATIONS AND EXCLUSIONS

This warranty does not apply to products purchased outside Canada or to any product which has been improperly installed, subjected to usage for which the product was not designed, misused or abused, damaged during shipping, or which has been altered or repaired in any way that affects the reliability or detracts from the performance, nor does it cover any product which is used commercially. Dry cell batteries are also excluded from coverage under this warranty.

This warranty is extended to the original end user purchaser only. A purchase receipt or other proof of date of original purchase is required before warranty service is performed.

THIS EXPRESS, LIMITED WARRANTY IS IN LIEU OF ALL OTHER WARRANTIES, EXPRESS OR IMPLIED, EXCLUDING ANY IMPLIED WARRANTIES OF MERCHANTABILITY OR FITNESS FOR A PARTICULAR PURPOSE.

IN NO EVENT WILL PANASONIC CANADA INC. BE LIABLE FOR ANY SPECIAL, INDIRECT OR CONSEQUENTIAL DAMAGES.

In certain instances, some jurisdictions do not allow the exclusion or limitation of incidental or consequential damages, or the exclusion of implied warranties, so the above limitations and exclusions may not be applicable.

WARRANTY SERVICE

For product operation and information assistance, please contact your Dealer or our Customer Care Centre at: Telephone #: (905) 624-5505 Fax #: (905) 238-2360 Web: www.panasonic.ca

For product repairs, please contact one of the following:

- Your Dealer who will inform you of an authorized Servicentre nearest you.
- Our Customer Care Centre at (905) 624-5505 or www.panasonic.ca
- A Panasonic Factory Servicentre listed below:

Richmond, British Columbia

Panasonic Canada Inc.
12111 Riverside Way
Richmond, BC
V6W 1K8
Tel: (604) 278-4211
Fax: (604) 278-5627

Calgary, Alberta

Panasonic Canada Inc.
6835-8th St. N. E.
Calgary, AB
T2E 7H7
Tel: (403) 295-3955
Fax: (403) 274-5493

Mississauga, Ontario

Panasonic Canada Inc.
5770 Ambler Dr.
Mississauga, ON
L4W 2T3
Tel: (905) 624-8447
Fax: (905) 238-2418

Lachine, Québec

Panasonic Canada Inc.
3075, rue Louis A. Amos
Lachine, QC
H8T 1C4
Tel: (514) 633-8684
Fax: (514) 633-8020

IF YOU SHIP THE PRODUCT TO A SERVICENTRE

Carefully pack and send prepaid, adequately insured and preferably in the original carton.
Include details of the defect claimed, and proof of date of original purchase.

Product Service

- 1. Damage requiring service**—The unit should be serviced by qualified service personnel if:
 - (a) The AC power supply cord or AC adaptor has been damaged; or
 - (b) Objects or liquids have gotten into the unit; or
 - (c) The unit has been exposed to rain; or
 - (d) The unit does not operate normally or exhibits a marked change in performance; or
 - (e) The unit has been dropped or the cabinet damaged.
- 2. Servicing**—Do not attempt to service the unit beyond that described in these operating instructions. Refer all other servicing to authorized servicing personnel.
- 3. Replacement parts**—When parts need replacing ensure the servicer uses parts specified by the manufacturer or parts that have the same characteristics as the original parts. Unauthorized substitutes may result in fire, electric shock, or other hazards.
- 4. Safety check**—After repairs or service, ask the servicer to perform safety checks to confirm that the unit is in proper working condition.

Product information

For product information or assistance with product operation:

In the U.S.A., contact the Panasonic Customer Call Center at 1-800-211-7262, or e-mail consumerproducts@panasonic.com, or the website (<http://www.panasonic.com>).

In Canada, contact the Panasonic Canada Inc. Customer Care Centre at 1-800-561-5505, or visit the website (www.panasonic.ca), or an authorized Servicentre closest to you.

Conexiones del televisor y de la antena

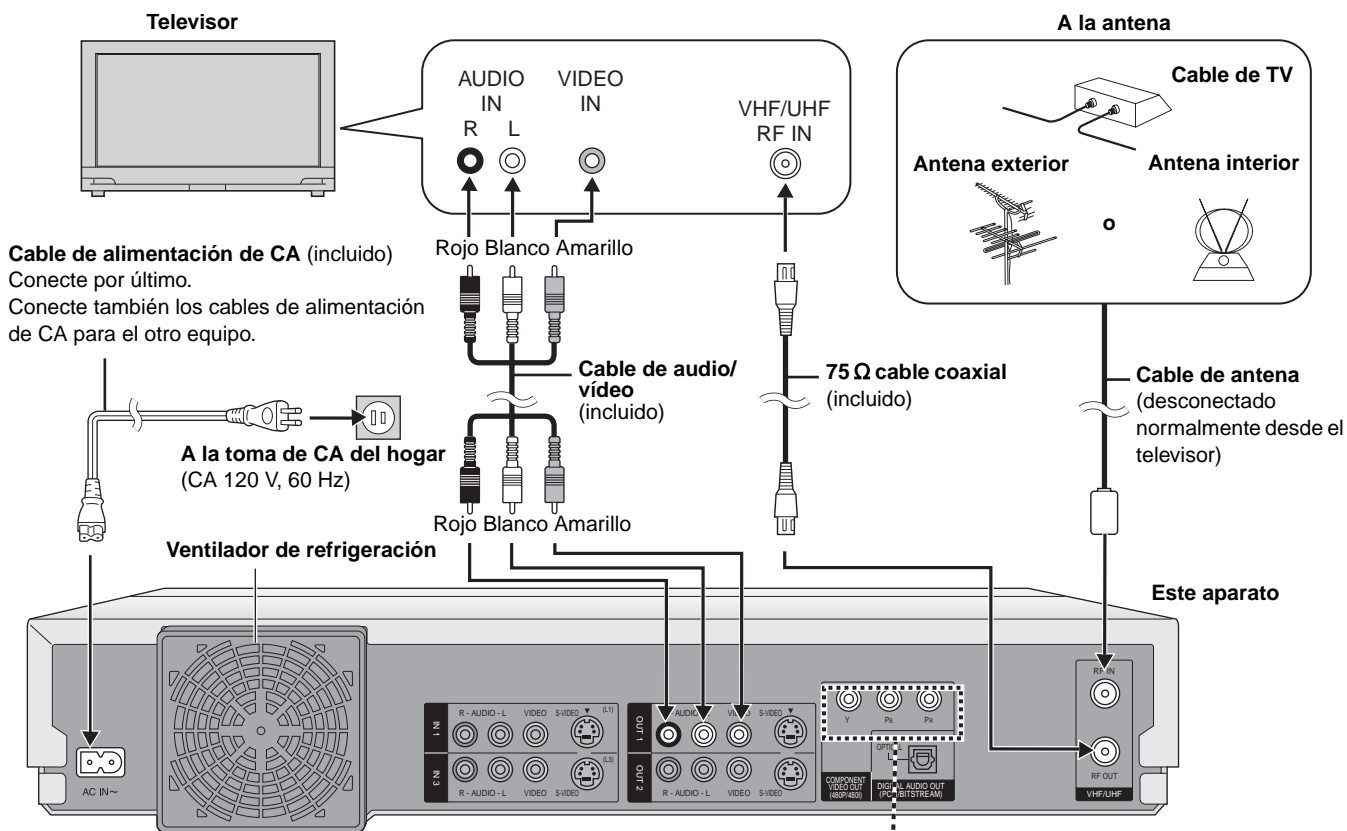

Para disfrutar del vídeo progresivo

- Conecte a los terminales de entrada de vídeo componente (480P) en un televisor compatible con el sistema de protección contra copia del aparato. (El vídeo no se visualizará correctamente si está conectado a un televisor incompatible).
- Ajuste "Tipo TV" a "4:3 y 480P" o "16:9 y 480P". (→abajo, "Configuración según su televisor")

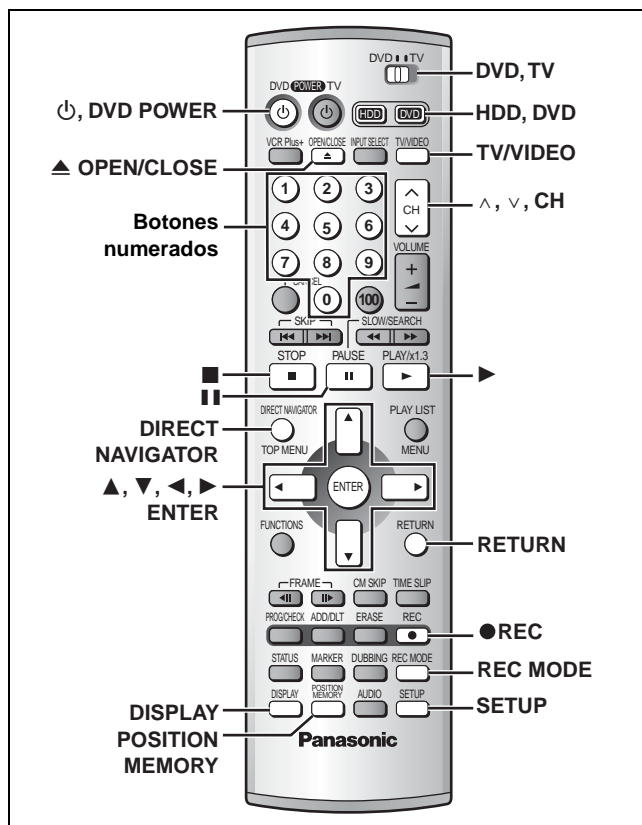

Preparación

- Confirme que la antena esté conectada correctamente.
- Encienda el televisor y seleccione la entrada de vídeo apropiada según las conexiones hechas al aparato.

Sintonización automática al enchufar

- 1 Pulse [⏻, DVD POWER] para encender el aparato.
- 2 Pulse [▲, ▼] para seleccionar "Español" y pulse [ENTER].
- 3 Pulse [ENTER].

La sintonización automática al enchufar empieza y el aparato transforma las emisoras que puede recibir en canales.

El aparato pasa luego a la configuración automática del reloj. Cuando termina se visualiza la hora.

Cuando la visualización muestra la hora correcta

- 4 Pulse [ENTER] para completar la sintonización automática al enchufar.

Configuración según su televisor

Cambie la configuración si su televisor es:

- Progresiva (Lea las instrucciones de funcionamiento de su televisor para conocer detalles.)
- Pantalla panorámica (relación de aspecto 16:9)

- 1 Pulse [SETUP] para mostrar los menús.
- 2 Pulse [▲, ▼] para seleccionar "Pantalla TV" y pulse [▶].
- 3 Pulse [▲, ▼] para seleccionar "Tipo TV" y pulse [ENTER].
- 4 Pulse [▲, ▼] para seleccionar el elemento y pulse [ENTER].

Para volver a la pantalla anterior

Pulse [RETURN].

Cuando termine

Pulse [SETUP].

■ Si selecciona el elemento para salida progresiva (480P)

Seleccione Vídeo en el menú en pantalla y ajuste "Transferencia" de acuerdo con el tipo de material en reproducción durante la reproducción.

Durante la reproducción

1. Pulse [DISPLAY].
2. Pulse [▲, ▼] para seleccionar "Vídeo" y pulse [▶].
3. Pulse [▲, ▼] para seleccionar "Progresiva" y pulse [▶] dos veces.
4. Pulse [▲, ▼] para seleccionar "Transferencia" de acuerdo con el tipo de material en reproducción.

Disco	Imagen	Normal
Repr.	DNR	ACT
Vídeo	Progresiva	ACT
Audio	Transferencia	Auto 1

Auto1 (normal): Para material cinematográfico

Auto2: Para material cinematográfico (igual que Auto1, capaz de convertir vídeo progresivo de 30 cuadros por segundo).

Vídeo: Para material de vídeo

Grabación de programas de televisión

[HDD] [RAM] [DVD-R]

1 Pulse [⏻, DVD POWER] para encender el aparato.

2 Pulse [HDD] o [DVD] para seleccionar la unidad de grabación.

El botón HDD o DVD se enciende en la unidad.

- No es posible grabar simultáneamente en la unidad HDD (unidad de disco duro) y en la unidad DVD.

3 Si seleccionó la unidad DVD

Pulse [▲ OPEN/CLOSE] para abrir la bandeja e introduzca un disco.

- Vuelva a pulsar el botón para cerrar la bandeja.
- En un disco de doble cara, no es posible grabar de manera continua desde una cara a la otra. Será necesario expulsar el disco y darle la vuelta.

4 Asegúrese de que [DVD, TV] se encuentre en la posición "DVD" y pulse [▲, ▼, CH] para seleccionar el canal.

5 Pulse [REC MODE] para seleccionar el modo de grabación.

- Seleccione "XP", "SP", "LP" o "EP".

6 Pulse [●, REC] para iniciar la grabación.

La luz de grabación de las unidades HDD y DVD se enciende en la unidad principal.

Para detener la grabación

Pulse [■].

Para hacer una pausa en la grabación

Pulse [⏸]. Pulse de nuevo para continuar grabando. (El programa no se divide en un programa separado.)

■ Visualización del televisor durante la grabación

Las imágenes siendo grabadas no se ven afectadas.

Interruptor [DVD, TV] a "TV".

1 Pulse [TV/VIDEO] para cambiar el modo de entrada del televisor a "TV".

2 Pulse [▲, ▼, CH] para cambiar canales.

■ Reproducción desde el inicio del programa que está grabando—Reproducción encadenada [HDD] [RAM]

Pulse [▶] (PLAY).

La reproducción se inicia desde el principio del programa que se está grabando. (Se enciende el indicador Time Slip).

■ Grabación y reproducción simultáneas [HDD] [RAM]

Puede reproducir un programa grabado previamente durante la grabación.

1 Pulse [DIRECT NAVIGATOR].

Se enciende el indicador Time Slip.

2 Pulse [▲, ▼] para seleccionar un programa y pulse [ENTER].

Para detener la reproducción y la grabación

① Pulse [■]. (La reproducción se detiene).

Espere 2 segundos.

② Pulse [■]. (La grabación se detiene).

- Para detener la grabación con temporizador, pulse [■], después [ENTER] en un transcurso de 5 segundos.

Reproducción de discos

[HDD] [RAM] [DVD-R] [DVD-A] [DVD-V] [VCD] [CD] [MP3]

1 Pulse [⏻, DVD POWER] para encender el aparato.

2 Pulse [HDD] o [DVD] para seleccionar la unidad de reproducción.

El botón HDD o DVD se enciende en la unidad.

- No es posible reproducir simultáneamente en la unidad HDD (unidad de disco duro) y en la unidad DVD.

3 Si seleccionó la unidad DVD

Pulse [▲ OPEN/CLOSE] para abrir la bandeja e introducir un disco.

- Vuelva a pulsar el botón para cerrar la bandeja.
- En un disco de doble cara, no es posible reproducir de manera continua desde una cara a la otra. Será necesario expulsar el disco y darle la vuelta.

4 Pulse [▶] (PLAY).

(Cuando aparece una pantalla de menús en el televisor → abajo)

Para detener la reproducción

Pulse [■].

- Cuando "PLAY" parpadea en la visualización, se está activando la función de reanudación. Pulse [▶] (PLAY) para iniciar la reproducción desde la posición en que la detuvo.

Para cancelar la función, pulse [■] hasta que se apague "PLAY" (también se cancela la posición al apagar el aparato o abrir la bandeja del disco).

Para hacer una pausa en la reproducción

Pulse [⏸]. (Vuelva a pulsar para reanudar la reproducción).

■ Cuando aparece una pantalla de menús en el televisor [VCD]

Interruptor [DVD, TV] a "DVD" y

Pulse los botones numerados (0, 1–9) para seleccionar un elemento.

por ejemplo., "5": [0] → [5] "15": [1] → [5]

[DVD-A] [DVD-V]

Pulse [▲, ▼, ◀, ▶] para seleccionar un elemento y pulse [ENTER].

- Puede que también sea posible utilizar los botones numerados (0, 1–9) para seleccionar un elemento.

■ Memoria de posición

[HDD] [RAM] [DVD-R] [DVD-A] [DVD-V] [VCD] [CD] [MP3]

Después de apagar el aparato, puede iniciar la reproducción desde una posición memorizada.

(Cuando se muestra el tiempo de reproducción transcurrido)

Durante la reproducción

1 Pulse [POSITION MEMORY].

El mensaje "Posición Memorizada" aparece en el televisor.

2 Después de pasar el aparato a la posición de modo en espera y de volver a ponerlo en funcionamiento

Pulse [▶] (PLAY).

La reproducción se inicia desde la posición memorizada. (La posición se cancela).

[Nota]

[DVD-R] [DVD-A] [DVD-V] [VCD] [CD] [MP3]

- La posición se cancela al abrir la bandeja del disco.

[RAM]

- Las posiciones siguen estando memorizadas incluso tras haber abierto la bandeja del disco.

- Si el disco está protegido contra escritura, no se pueden marcar posiciones.

All copy of the card	38	Finalize	44, 62	Repeat play	49
Angle	48	Flexible Recording (FR)	15	Resume function	18
Antenna system	7	Format		SD card	11, 22
Audio attribute	48	card	40, 42	SD VIDEO (MPEG4) programs	11
Channel caption	56	DVD-RAM	44	play	22, 23
Channel setting	7	HDD	44	edit	42
Chasing play	17	FUNCTIONS window	50	SETUP menu	51
Cleaning		JPEG	11, 62	Shorten Segment	36
disc	62	Language code list	Back cover	Simultaneous rec and play	17
lens	66	LPCM	53, 62	Sound track	48
main unit	66	Marker	21	Still pictures	11
Clock setting	55	MPEG-DNR	49	play	22, 23
CM Skip	21	MP3	24	edit	38-41
Connection		MPEG4	62	Subtitle	48
amplifier, system component	59	On-screen display	47	TIFF	11, 62
antenna	61	On-screen menu	48-50	Time Slip	17, 21
antenna, television	5	PC card	11, 22	Timer recording	26-29
cable TV box, satellite receiver	58	PCM Down Conversion	53	Transfer	49
video equipment	60	Picture	49	TV Type	9
CPRM system	62	PLAY FROM TOP	50	VCR Plus+	
Dialog Enhancer	49	Play list	32-35	guide channel	8
Direct Navigator	19	Position memory	19	timer recording	26
Divide Program	36	Progressive	5, 9, 49, 62	V.S.S.	49
DPOF	40	Properties			
DV Automatic Recording (DV AUTO REC)	16	play list	34		
Edit Scenes	34	program	36, 43		
Enter title	46	Protection			
disc	44	card	10		
folder	39	cartridge	10		
play list	34	disc	44		
program	36, 43	folder	40		
Erase		program	36		
all programs	42, 44	still picture	40		
folder	40	Quick View	21		
play list	33, 34	Ratings password	51		
play list scene	33, 35	Recording mode	15		
program	19, 36, 43	Re-initialize setting	51		
still picture	40				

Language code list Input the code with numbered buttons.



Abkhazian: 6566	Chinese: 9072	Hausa: 7265	Lithuanian: 7684	Romanian: 8279	Telugu: 8469
Afar: 6565	Corsican: 6779	Hebrew: 7387	Macedonian: 7775	Russian: 8285	Thai: 8472
Afrikaans: 6570	Croatian: 7282	Hindi: 7273	Malagasy: 7771	Samoan: 8377	Tibetan: 6679
Albanian: 8381	Czech: 6783	Hungarian: 7285	Malay: 7783	Sanskrit: 8365	Tigrinya: 8473
Ameharic: 6577	Danish: 6865	Icelandic: 7383	Malayalam: 7776	Scots Gaelic: 7168	Tonga: 8479
Arabic: 6582	Dutch: 7876	Indonesian: 7378	Maltese: 7784	Serbian: 8382	Turkish: 8482
Armenian: 7289	English: 6979	Interlingua: 7365	Maori: 7773	Serbo-Croatian: 8372	Turkmen: 8475
Assamese: 6583	Esperanto: 6979	Irish: 7165	Marathi: 7782	Shona: 8378	Twi: 8487
Aymara: 6588	Estonian: 6984	Italian: 7384	Moldavian: 7779	Sindhi: 8368	Ukrainian: 8575
Azerbaijani: 6590	Faroese: 7079	Japanese: 7465	Mongolian: 7778	Singhalese: 8373	Urdu: 8582
Bashkir: 6665	Fiji: 7074	Javanese: 7487	Nauru: 7865	Slovak: 8375	Uzbek: 8590
Basque: 6985	Finnish: 7073	Kannada: 7578	Nepali: 7869	Slovenian: 8376	Vietnamese: 8673
Bengali; Bangla: 6678	French: 7082	Kashmiri: 7583	Norwegian: 7879	Somali: 8379	Volapük: 8679
Bhutani: 6890	Frisian: 7089	Kazakh: 7575	Oriya: 7982	Spanish: 6983	Welsh: 6789
Bihari: 6672	Galician: 7176	Kirghiz: 7589	Pashto, Pushto: 8083	Sundanese: 8385	Wolof: 8779
Breton: 6682	Georgian: 7565	Korean: 7579	Persian: 7065	Swahili: 8387	Xhosa: 8872
Bulgarian: 6671	German: 6869	Kurdish: 7585	Polish: 8076	Swedish: 8386	Yiddish: 7473
Burmese: 7789	Greek: 6976	Laotian: 7679	Portuguese: 8084	Tagalog: 8476	Yoruba: 8979
Byelorussian: 6669	Greenlandic: 7576	Latin: 7665	Punjabi: 8065	Tajik: 8471	Zulu: 9085
Cambodian: 7577	Guarani: 7178	Latvian, Lettish: 7686	Quechua: 8185	Tamil: 8465	
Catalan: 6765	Gujarati: 7185	Lingala: 7678	Rhaeto-Romance: 8277	Tatar: 8484	

U.S. patent Nos. 4,631,603, 4,577,216, 4,819,098, and 4,907,093.

This product incorporates copyright protection technology that is protected by U.S. patents and other intellectual property rights. Use of this copyright protection technology must be authorized by Macrovision, and is intended for home and other limited consumer uses only unless otherwise authorized by Macrovision. Reverse engineering or disassembly is prohibited.

Panasonic Consumer Electronics Company, Division of Matsushita Electric Corporation of America
 One Panasonic Way Secaucus,
 New Jersey 07094
<http://www.panasonic.com>

Panasonic Sales Company, Division of Matsushita Electric of Puerto Rico, Inc. ("PSC")
 Ave. 65 de Infantería, Km. 9.5
 San Gabriel Industrial Park, Carolina,
 Puerto Rico 00985

Panasonic Canada Inc.  
 5770 Ambler Drive
 Mississauga, Ontario
 L4W 2T3
www.panasonic.ca