

Panasonic

DVD VIDEO RECORDER

Operating Instructions

Model No. **DMR-E20**



Before connecting, operating or adjusting this product, please read these instructions completely.
Please keep this manual for future reference.



This unit responds to the region number information on DVD-Video. The unit can only play DVD-Video if the region number of the disc matches the region number of this unit. See page 6 for details.

For U.S.A.

The servicenter list and warranty can be found on pages 103 and 105.

For Canada

The warranty can be found on page 104.

En las páginas 106 y 107 hay una guía de referencia rápida en español.

Dear customer

Thank you for purchasing this product. For optimum performance and safety, please read these instructions carefully.

Getting started

CAUTION!

THIS PRODUCT UTILIZES A LASER.
USE OF CONTROLS OR ADJUSTMENTS OR PERFORMANCE OF PROCEDURES OTHER THAN THOSE SPECIFIED HEREIN MAY RESULT IN HAZARDOUS RADIATION EXPOSURE.
DO NOT OPEN COVERS AND DO NOT REPAIR YOURSELF. REFER SERVICING TO QUALIFIED PERSONNEL.

WARNING:

TO REDUCE THE RISK OF FIRE, ELECTRIC SHOCK OR PRODUCT DAMAGE, DO NOT EXPOSE THIS APPARATUS TO RAIN, MOISTURE, DRIPPING OR SPLASHING AND THAT NO OBJECTS FILLED WITH LIQUIDS, SUCH AS VASES, SHALL BE PLACED ON THE APPARATUS.

CAUTION:

TO PREVENT ELECTRIC SHOCK MATCH WIDE BLADE OF PLUG TO WIDE SLOT, FULLY INSERT.



CAUTION
RISK OF ELECTRIC SHOCK
DO NOT OPEN



CAUTION: TO REDUCE THE RISK OF ELECTRIC SHOCK, DO NOT REMOVE SCREWS. NO USER-SERVICEABLE PARTS INSIDE.
REFER SERVICING TO QUALIFIED SERVICE PERSONNEL.



The lightning flash with arrowhead symbol, within an equilateral triangle, is intended to alert the user to the presence of uninsulated "dangerous voltage" within the product's enclosure that may be of sufficient magnitude to constitute a risk of electric shock to persons.



The exclamation point within an equilateral triangle is intended to alert the user to the presence of important operating and maintenance (servicing) instructions in the literature accompanying the appliance.

THE FOLLOWING APPLIES ONLY IN THE U.S.A.

FCC Note:

This equipment has been tested and found to comply with the limits for a Class B digital device, pursuant to Part 15 of the FCC Rules. These limits are designed to provide reasonable protection against harmful interference in a residential installation. This equipment generates, uses, and can radiate radio frequency energy and, if not installed and used in accordance with the instructions, may cause harmful interference to radio communications. However, there is no guarantee that interference will not occur in a particular installation. If this equipment does cause harmful interference to radio or television reception, which can be determined by turning the equipment off and on, the user is encouraged to try to correct the interference by one or more of the following measures:

- Reorient or relocate the receiving antenna.
- Increase the separation between the equipment and receiver.
- Connect the equipment into an outlet on a circuit different from that to which the receiver is connected.
- Consult the dealer or an experienced radio/TV technician for help.

FCC Caution: To assure continued compliance, follow the attached installation instructions and use only shielded interface cables when connecting to peripheral devices. Any changes or modifications not expressly approved by the party responsible for compliance could void the user's authority to operate this equipment.

This device complies with Part 15 of the FCC Rules. Operation is subject to the following two conditions: (1) This device may not cause harmful interference, and (2) this device must accept any interference received, including interference that may cause undesired operation.

Do not disassemble.
Do not service.
Ne Pas Démontez.
Réservé Au Personnel Autorisé.
Nicht auseinandernehmen.
Keine Reparatur oder
Wartung erlaubt.
分解しないでください。
保守はできません。

DANGER
ATTENTION
VORSICHT
VARNING

VISIBLE OR INVISIBLE LASER RADIATION WHEN OPEN. AVOID DIRECT EXPOSURE TO BEAM.
RAYONNEMENT LASER VISIBLE OU INVISIBLE EN CAS D'OUVERTURE. EXPOSITION DANGEREUSE AU FAISCEAU.
SICHTBARE ODER UNSICHTBARE LASERSTRAHLUNG, WENN ABDECKUNG GEÖFFNET. NICHT DEM STRAHL AUSSETZEN.
SYNLIG ELLER OSYNLIG LASERSTRÄLNING NÄR DENNA DEL ÄR ÖPPNAD. STRÅLEN ÄR FARLIG.

注意 ここを開くと可視または不可視レーザー光が出ます。ビームを直接見たり、触れたりしないでください。

(Inside of product)

Accessories



Please check and identify the supplied accessories. Use numbers indicated in parentheses when asking for replacement parts.
(Only for U.S.A.)
To order accessories contact 1-800-332-5368 or web site (<http://www.panasonic.com/store>).
(Only for Canada)
To order accessories, call the dealer from whom you have made your purchase.

Remote control 1
(N2QAKB000010)



Batteries 2
for remote control

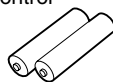

AC power supply cord 1
(RJA0065-A)

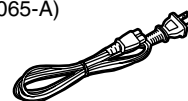

Audio/Video cable 1
(VJA0788-D)

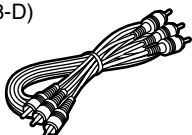

75 Ω coaxial cable 1
(VJA1013)

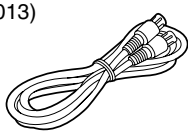

Note
The included AC power supply cord is for use with this unit only.
Do not use it with other equipment.

IMPORTANT SAFETY INSTRUCTIONS

Read these operating instructions carefully before using the unit. Follow the safety instructions on the unit and the applicable safety instructions listed below. Keep these operating instructions handy for future reference.

- 1) Read these instructions.
- 2) Keep these instructions.
- 3) Heed all warnings.
- 4) Follow all instructions.
- 5) Do not use this apparatus near water.
- 6) Clean only with dry cloth.
- 7) Do not block any ventilation openings. Install in accordance with the manufacturer's instructions.
- 8) Do not install near any heat sources such as radiators, heat registers, stoves, or other apparatus (including amplifiers) that produce heat.
- 9) Do not defeat the safety purpose of the polarized or grounding-type plug. A polarized plug has two blades with one wider than the other. A grounding-type plug has two blades and a third grounding prong. The wide blade or the third prong are provided for your safety. If the provided plug does not fit into your outlet, consult an electrician for replacement of the obsolete outlet.
- 10) Protect the power cord from being walked on or pinched particularly at plugs, convenience receptacles, and the point where they exit from the apparatus.
- 11) Only use attachments/accessories specified by the manufacturer.
- 12) Use only with the cart, stand, tripod, bracket, or table specified by the manufacturer, or sold with the apparatus. When a cart is used, use caution when moving the cart/apparatus combination to avoid injury from tip-over.
- 13) Unplug this apparatus during lightning storms or when unused for long periods of time.
- 14) Refer all servicing to qualified service personnel. Servicing is required when the apparatus has been damaged in any way, such as power-supply cord or plug is damaged, liquid has been spilled or objects have fallen into the apparatus, the apparatus has been exposed to rain or moisture, does not operate normally, or has been dropped.



Getting started

CAUTION!

DO NOT INSTALL, OR PLACE THIS UNIT, IN A BOOKCASE, BUILT-IN CABINET OR IN ANOTHER CONFINED SPACE. ENSURE THE UNIT IS WELL VENTILATED. TO PREVENT RISK OF ELECTRIC SHOCK OR FIRE HAZARD DUE TO OVERHEATING, ENSURE THAT CURTAINS AND ANY OTHER MATERIALS DO NOT OBSTRUCT THE VENTILATION VENTS.

THE FOLLOWING APPLIES ONLY IN THE U.S.A.

Note to CATV system installer:

This reminder is provided to call the CATV system installer's attention to Article 820-40 of the NEC that provides guidelines for proper grounding and, in particular, specifies that the cable ground shall be connected to the grounding system of the building, as close to the point of cable entry as practical.

DO NOT PLACE THIS APPARATUS INTO AN AUDIO RACK, BOOK SHELF OR SIMILAR LOCATION BECAUSE OF HEAT FROM THIS APPARATUS.

DO NOT BLOCK ANY OF THE VENTILATION OPENINGS. INSTALL IN ACCORDANCE WITH THE MANUFACTURER'S INSTRUCTIONS.

The model number and serial number of this product can be found on either the back or the bottom of the unit. Please note them in the space provided below and keep for future reference.

MODEL NUMBER _____ DMR-E20 _____

SERIAL NUMBER _____

User memo:

DATE OF PURCHASE _____

DEALER NAME _____

DEALER ADDRESS _____

TELEPHONE NUMBER _____

Do not place the unit on amplifiers or equipment that may become hot.

The heat can damage the unit.

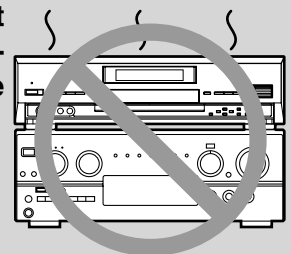

(U.S.A. only)

Product Registration Card

Please complete and return the included product registration card, or register via the Internet at:

<http://www.panasonic.com/host/consumer.html>

Table of contents

Getting started

Accessories	2
IMPORTANT SAFETY INSTRUCTIONS	3
Features	5
Discs	6
Control reference guide	8
Set up steps	10
The remote control	12
Antenna and television connections	14
Plug-in Auto Tuning	16
Channel settings	18
Using the remote control to add and delete channels	18
VCR Plus+ guide channel settings	19
Selecting TV screen type	21

Basic operations

Playing discs	22
Starting play from where you stopped it (Resume Function)	23
Fast forward and rewind—SEARCH	24
Slow-motion play	24
Frame-by-frame viewing	24
Skipping	25
Starting play from a selected program, title, chapter, or track	25
Recording television programs	26
One Touch Recording—Specify a time to stop recording	27

Advanced operations

Playing while you are recording	28
Playing from the beginning of the program you are recording—Chasing play	28
Simultaneous rec and play	28
Reviewing the recorded images while recording (Time Slip)	29
Using the top window	30
Convenient features	32
Skipping a minute forward—CM skip	32
Selecting an amount of time to skip—Time Slip	32
Repeat play	33
A-B repeat play	33
Changing audio	34
Marking places to play again—MARKER	36
Program play	38
Random play	39
Enjoying virtual surround sound effects (V.S.S.)	39
Using on-screen menu icons	40
Timer recording	43
Using VCR Plus+ codes to make timer recording	43
Manually programming the unit to make timer recording	46
To delete a timer recording program	47
To check programs	48
Releasing the unit from timer standby	48
Recording from a video cassette recorder	49
Disc setting	50
Enter Title	50
Entering characters for titles	51
Disc Protection	52
Releasing disc protection	53
Format	54
Finalize—Creating DVD-Video	55

Using the direct navigator	56
Selecting programs to play	56
Erasing programs	58
Entering and editing program titles	59
Protecting programs	60
Releasing program protection	61
Checking program contents	62
Erasing parts of a program—Shorten Segment	63
Using play lists to edit programs	65
Displaying play lists	65
Creating play lists	66
Playing play lists	67
Playing play list scenes	68
Editing play list scenes	68
Copying play lists	72
Erasing a play list	72
Titrating play lists	73
Checking play list contents	74

Home Theater

Expanding your home theater system	75
Connecting a cable TV box	76
Connecting a home satellite system (Dishnetwork/DSS)	77
Connecting to a digital amplifier or system component	78
Connecting an analog amplifier or system component	78
Connecting a video cassette recorder	79
When you can't directly connect the antenna you disconnected from your television to the unit	80
When you can't directly connect the included 75 Ω coaxial cable to the television	80
Operating other Panasonic DVD equipment with the remote control	81

Initial settings

Changing the unit's settings	82
Summary of settings	82
Common procedures	85
Entering a password	86
Digital output	86
Clock Settings	87
Channel Settings	90

Reference

On-screen displays	94
Specifications	95
Glossary	96
Maintenance	97
Disc handling	98
Self-diagnosis	98
Error messages	99
Troubleshooting guide	100
Product Service	102
Limited Warranty (For U.S.A.)	103
Limited Warranty (For CANADA)	104
Servicenter List (ONLY FOR U.S.A.)	105
Guía de referencia rápida en español	106
(Spanish Quick Reference)	
Index	Back cover

This unit allows recording of high quality video on DVD-RAM, the compact and durable digital media with fast random access. This media also outdoes past tape formats in ease of operation.

■ Watch a program while you are recording it

Chasing play

You can watch a program from the start while you are still recording it (⇒ page 28).

Simultaneous rec and play

You can record a program while watching one you recorded previously (⇒ page 28).

Time Slip

You can jump back 30 seconds to review a piece of action you missed while recording by pressing the Time Slip button (can be set between 1 minute and 360 minutes: ⇒ page 29).

■ Maximum 12 hours on DVD-RAM

- Using a double-sided, 9.4 GB DVD-RAM allows you to record a maximum of 12 hours.
- When using a 4.7 GB DVD-RAM or a DVD-R, you can get 1 hour recording using the XP high picture quality mode, 2 hours with the regular SP mode, 4 hours with the long LP mode, and 6 hours with the extra long EP mode.
- There is also the FR (flexible recording) mode you can use with timer recording to fit recordings efficiently onto the available space on the disc.

■ The Top Window shows you most of the features you can use (⇒ page 30)

The top window has most of the features and functions you are likely to use regularly. Just select the icon for the operation you want to perform.

■ Make your own DVD-Video

- This unit records to DVD-R following the DVD-Video specifications so you can make your own DVD-Video (⇒ page 7).
- The encoder system used for recording is called "Hybrid VBR" which allows high quality recordings.

■ Exceptional picture and sound quality when recording

- Audio is recorded using Dolby Digital stereo, enabling high quality sound recordings.
- As well as being able to play DVD-Video movie software, this unit can also play other types of discs including audio CDs and video CDs. This means your recorder will be the center of your home entertainment, from high-end home theater through to CD play.

Getting the most from the versatility of DVD-RAM and DVD-R

■ Fast access to the program you want to watch (⇒ page 56)

Use the direct navigator to find a program you have recorded and start play.

■ Edit scenes freely (⇒ page 65) RAM

Use play lists to select your favorite scenes and rearrange them to play in any order you like. Pick out scenes from a music or sports show and create a collection of your favorite scenes, or take the images you have shot with a video camera and edit them into a movie of your own creation.

Symbols used in these operating instructions

■ Top window



is used to indicate operations you can access from the top window, such as the direct navigator and play list screen.

■ Troubleshooting



is used to indicate ways to fix potential problems.

■ Discs you can use

The features you can use with the different types of discs are indicated as follows.

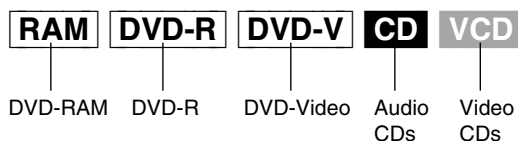

For your reference

- DVD-R indicates DVD-R that have not yet been finalized (⇒ pages 55 and 96) and can still be recorded on.
- DVD-R that have been finalized can use the same features as DVD-Video. (Refer to features indicated DVD-V.)

Operation

These operating instructions describe operations mainly using the remote control. If the name of the button is the same, the operation described can also be performed with the main unit.

Displays

The displays shown in these instructions are examples only. Actual displays depend on the disc and the operations you are performing.

VCR Plus+ and PlusCode are registered trademarks of Gemstar Development Corporation. The VCR Plus+ system is manufactured under license from Gemstar Development Corporation.

Pats. 5,307,173; 5,335,079; 4,908,713; 4,751,578; and 4,706,121



Manufactured under license from Dolby Laboratories. "Dolby", "Pro Logic" and the double-D symbol are trademarks of Dolby Laboratories.

"DTS", "DTS Digital Surround" and "DTS Digital Out" are registered trademarks of Digital Theater Systems, Inc.



Discs you can use for recording and play

Logos for discs you can record on and play

<p>DVD-RAM [4.7 GB/9.4 GB, 12 cm (5")] [2.8 GB, 8 cm (3")]</p> 	<p>DVD-R (➔ page 7) [4.7 GB for General Ver. 2.0]</p> 
--	---

The manufacturer accepts no responsibility and offers no compensation for loss of recorded or edited material due to a problem with the unit or disc, and accepts no responsibility and offers no compensation for any subsequent damage caused by such loss.

Examples of causes of such losses are

1. A disc recorded and edited with this unit is played in a DVD recorder or computer disc drive manufactured by another company.
2. A disc used as described in 1 and then played again in this unit.
3. A disc recorded and edited with a DVD recorder or computer disc drive manufactured by another company is played in this unit.

This unit cannot record onto CD-R, CD-RW or authoring DVD-R.

Note



- Do not allow the disc to become dirty or scratched. Fingerprints, dirt, dust, and scratches on the recording surface may make it impossible to use the disc for recording.
- If you use DVD-RAM with cartridges, you can protect your recordings with the write-protect tab (➔ page 99). With the tab in the protect position, you cannot record to the disc, delete programs with the direct navigator, edit with the play list screen, or format the disc.
- This unit is compatible with both non-cartridge and cartridge DVD-RAM, but cartridge-type discs give better protection to your valuable recordings.

For your reference

- **DVD-RAM recorded on this unit cannot be played on incompatible players (including players manufactured by Panasonic).**
- Using a Panasonic DVD-RAM, you can record broadcasts that allow you to make one copy, such as some CATV broadcasts.
- See page 7 for more details about DVD-R.

Play-only discs

Logos for discs you can play

<p>DVD-Video</p> 	<p>Video CD</p> 	<p>Audio CD</p> 
--	---	---

Playing CD-R and CD-RW

This unit can play CD-DA (digital audio) and Video CD format audio CD-R and CD-RW that have been finalized upon completion of recording. It may not be able to play some CD-R or CD-RW due to the condition of the recording.

Note

The producer of the material can control how DVD-Video and Video CDs are played. This means that you may not be able to control play of a disc with some operations described in these operating instructions. Read the disc's instructions carefully.

Region Management Information (DVD-Video only)

This unit responds to the Region Management Information recorded on DVD-Video. This unit's region number is "1". You cannot play the disc if the region number on the DVD-Video does not correspond to the region number on the unit. You can play discs with labels containing the region number "1" and "ALL". Read the disc's instructions carefully.



Discs that cannot be played

- | | | | | | |
|--|--|---|--|--|---|
| <ul style="list-style-type: none"> • DVD-Video with a region number other than "1" or "All" • Some DVD-R (➔ page 7) • DVD-RAM (2.6 GB/5.2 GB) • CD-ROM • SACD | <ul style="list-style-type: none"> • CDV • MV-Disc | <ul style="list-style-type: none"> • DVD-ROM • CD-G • PD | <ul style="list-style-type: none"> • PAL discs • DVD-RW • Photo CD • Divx Video Disc, etc. | <ul style="list-style-type: none"> • DVD-Audio • CVD | <ul style="list-style-type: none"> • +RW • SVCD |
|--|--|---|--|--|---|



DVD-R

You can play DVD-R by finalizing (⇒ pages 55 and 96) them on this unit, effectively making them into DVD-Video.

■ Before finalizing...

You can record onto the available space on the disc and perform editing functions, such as giving titles to discs and programs and erasing programs.

- You cannot record to or edit DVD-R with this unit if it was recorded with another unit, whether it is finalized or not.
- You cannot record over parts that have been recorded.
- Erasing programs will not increase the disc's available time.

■ After finalizing...

The video and audio is recorded according to the DVD-Video specifications, and your very own DVD-Video is created.

- The titles you entered with this unit appear as menus.
- Programs longer than 5 minutes are divided into about five-minute chapters.
- These DVD-R can no longer be recorded on or edited.
- These DVD-R can be played on other DVD players, but this is not guaranteed.

Play may not be possible due to the player you are using, the DVD-R, or the condition of the recording. Use this unit to play the disc if the player is unable.

Visit Panasonic's homepage for more information about DVDs.

<http://www.panasonic.com/playDVD-R>

■ Recording to DVD-R

- It takes about 30 seconds for the unit to complete recording management information after recording finishes.
- To record on DVD-R, this unit optimizes the disc for each recording. Optimizing is carried out when you start recording after inserting the disc or turning the unit on. Recording may become impossible after the disc is optimized more than 50 times.
- The first 30 seconds of a program may not be recorded if you make successive timer recordings.
- The video is recorded in a 4:3 aspect irrespective of the video signal input.
- You cannot change audio type if a DVD-R is in the unit. Select the audio type (Main or SAP) before recording by going to "MTS Selection for DVD-R Disc" in the Audio ACTION menu (⇒ page 83).
- Some broadcasts carry signals that allow you to make one copy, but you cannot record these broadcasts with DVD-R. Use DVD-RAM to record these kinds of broadcast.
- Play may be impossible in some cases due the condition of the recording.
- We recommend using DVD-R manufactured by Panasonic as they have been tested to be compatible with this unit (⇒ see below). Discs manufactured by other companies may not be used to full capacity.

Audio format logos



: **Dolby Digital** (⇒ pages 75 and 96)

This unit can play Dolby Digital in stereo (2 channels). Connect an amplifier with a built-in Dolby Digital decoder to enjoy surround sound.



: **DTS Digital Surround** (⇒ pages 75 and 96)

Connect this unit to equipment that has a DTS decoder to enjoy DVDs with this mark.

Recommended DVD-RAM and DVD-R

● DVD-RAM

- 9.4-GB, double-sided, type 4 cartridge: LM-AD240U
- 4.7-GB, single-sided, type 2 cartridge: LM-AB120U
- 4.7-GB, single-sided, non-cartridge: LM-AF120U
(set of 3,
LM-AF120U3)

● DVD-R

- 4.7-GB, single-sided, non-cartridge: LM-RF120U

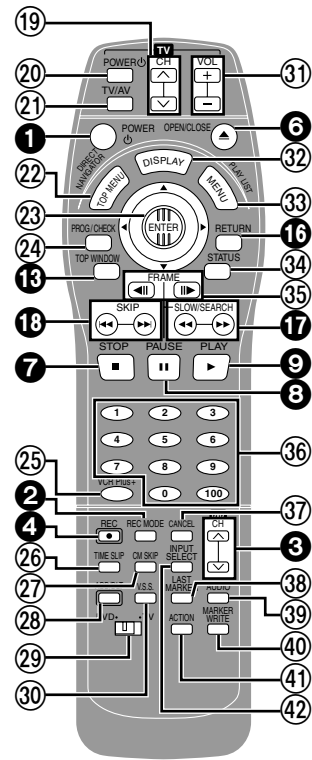
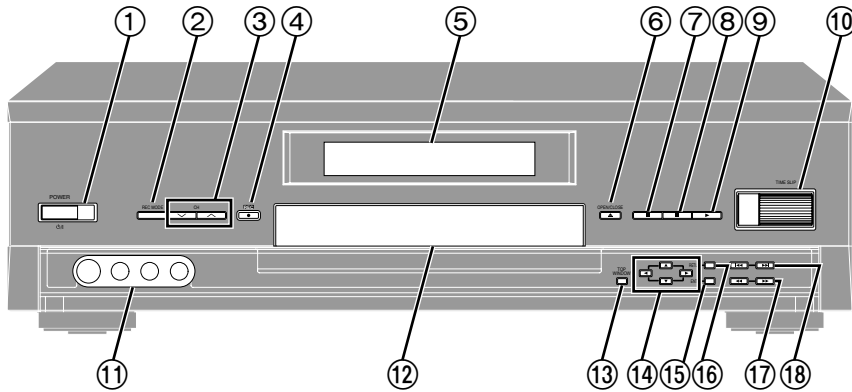

Buttons such as 1 function the same as the controls on the unit.

Main unit

	Page
1 POWER button (⏻/⏷, POWER)	16
Press to switch the unit from ON to STANDBY mode or vice versa. In standby mode, the unit is still consuming a small amount of power.	
2 Recording mode button (REC MODE)	26
3 Channel buttons (v, ^, CH)	26
4 Recording button (●, REC)	26
5 Display	9
6 Disc tray open/close button (▲, OPEN/CLOSE)	22
7 Stop button (■)	22
8 Pause button (⏸)	22
9 Play button (▶)	22
10 Time slip button and roller (TIME SLIP)	29
11 L2 input terminals (L2)	79
12 Disc tray	22
13 Top window button (TOP WINDOW)	30
14 Cursor buttons (▲, ▼, ◀, ▶)	19
15 Enter button (ENTER)	16
16 Return button (RETURN)	16
17 Slow/search buttons (◀◀, ▶▶)	24
18 Skip buttons (◀◀◀, ▶▶▶)	25

Opening the front panel

Open the front panel to access other controls and input terminals.

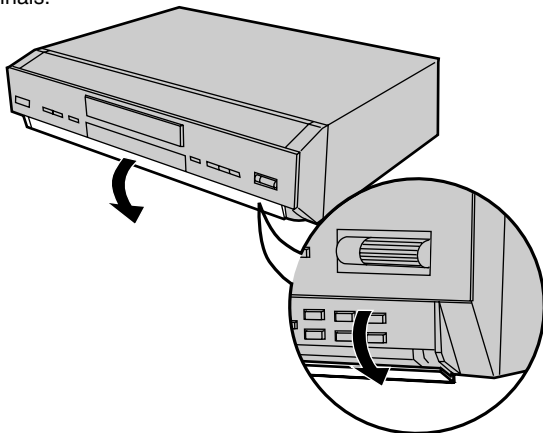

Remote control

	Page
19 TV channel buttons (TV, ^, v, CH)	13
20 TV power on/off button (TV, POWER ⏻)	13
21 Television input mode selector (TV, TV/AV)	13
22 Top menu and Direct Navigator button (TOP MENU, DIRECT NAVIGATOR)	23, 56
23 Joystick (▲, ▼, ◀, ▶)/Enter button (ENTER)	16
24 Manual programming and check button (PROG/CHECK)	46
25 VCR Plus+ button (VCR Plus+)	43
26 Time slip button (TIME SLIP)	29
27 One-minute skip button (CM SKIP)	32
28 Manual channel adding and deleting button (ADD/DLT)	18
29 DVD/TV switch (DVD, TV)	13
<ul style="list-style-type: none"> When selecting numbered items on this unit, be sure to switch [DVD, TV] to "DVD". When selecting channels on the television, be sure to switch [DVD, TV] to "TV". 	
30 Virtual Surround Sound button (V.S.S.)	39
31 TV volume buttons (TV, +, -, VOL)	13
32 Display button (DISPLAY)	40
33 Menu and Play List button (MENU, PLAY LIST)	23, 65
34 On-screen display button (STATUS)	94
35 Frame advance and frame reverse buttons (◀◀, ▶▶, FRAME)	24
36 Numbered buttons (1-0, 100)	23
<ul style="list-style-type: none"> When selecting a title, chapter, track, program, or play list Example: "5": [0] → [5] "15": [1] → [5] When selecting a page of play list scene Example: "5": [0] → [0] → [5] "15": [0] → [1] → [5] When selecting a television channel Example: "5": [0] → [5] "15": [1] → [5] "115": [100] → [1] → [5] 	
37 Cancel button (CANCEL)	37
38 Last marker button (LAST MARKER)	23
39 Audio button (AUDIO)	34
40 Marker write button (MARKER WRITE)	36
41 Action button (ACTION)	19, 85
42 Input select button (INPUT SELECT)	49

The unit's display

Center circle (e.g.: DVD-RAM)

Rotating (REC): recording

Stopped (REC): recording paused



Rotating (REC, PLAY):

Chasing play or simultaneous rec and play is in progress



Rotating (PLAY):

playing

Stopped (PLAY): play paused

"PLAY" flashes: the resume function is working

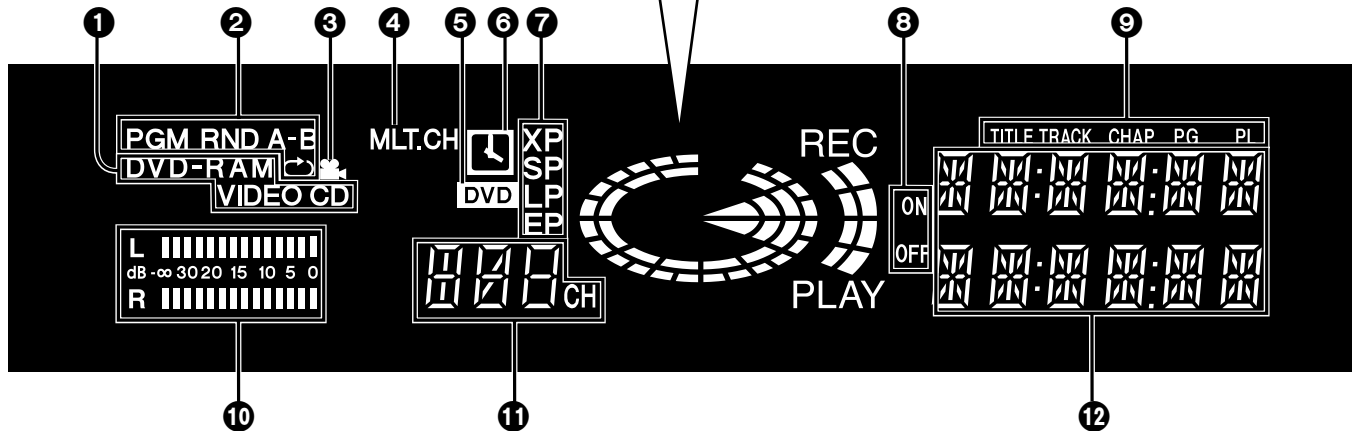

- 1 Disc type**
DVD-RAM: DVD-RAM
DVD-R: DVD-R
DVD VIDEO: DVD-Video
VIDEO CD: Video CD
CD: Audio CD
- 2 Play mode**
PGM: program play
RND: random play
A-B ↺: A-B repeat play
 ↻: repeat play
PGM ↻: program repeat play
- 3 Multi-angle** (⇒ page 41)
- 4 Audio signal type**
MLT.CH: a signal with 3 or more channels
- 5 DVD indicator**
Flashes: when you press [⏻/I, POWER] to turn the unit off until it actually turns off
- 6 Timer recording display**
On: when timer recording is on standby (⇒ page 44, 47)
Flashes: when the unit couldn't go to timer recording standby (e.g., a disc isn't loaded or a disc that can't be recorded to is loaded ⇒ page 48)
- 7 Recording mode** (⇒ pages 26, 44)
XP: High-quality mode
SP: Normal mode
LP: Long play mode
EP: Extra long play mode
XP SP LP EP (all on): FR (flexible recording) mode (only with timer recording)
- 8 Timer indicator**
ON: the timer recording start time
OFF: the timer recording end time or One Touch Recording end time
- 9 The display mode of the main display section**
TITLE: title number is displayed
TRACK: track number is displayed
CHAP: chapter number is displayed
PG: program number is displayed
PL: play list number is displayed
- 10 Volume level meter**
- 11 Channel**
- 12 Main display section**
 Recording and play counter
 Timer recording on and off times
 Remaining disc time
 Current time
 Title, track, chapter, program and play list numbers, and other miscellaneous messages

Follow these steps to connect and set-up this unit

1

Prepare the remote control

- Insert the batteries 12
- Change the remote control code for television operation 13

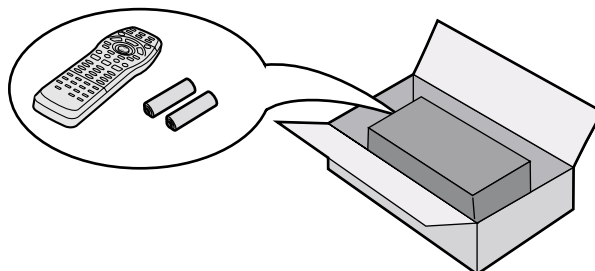

2

Antenna and television connections

- Basic connection 14
- When you need to rework your antenna cable 80

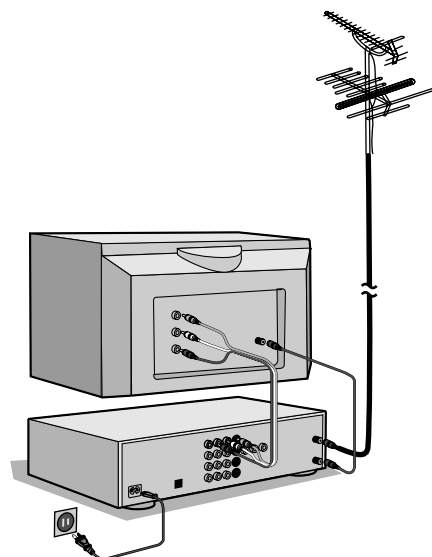

3

Tune into television stations

- Plug-in Auto Tuning 16
- VCR Plus+ guide channel settings 19
- Change the settings to suit your television 21

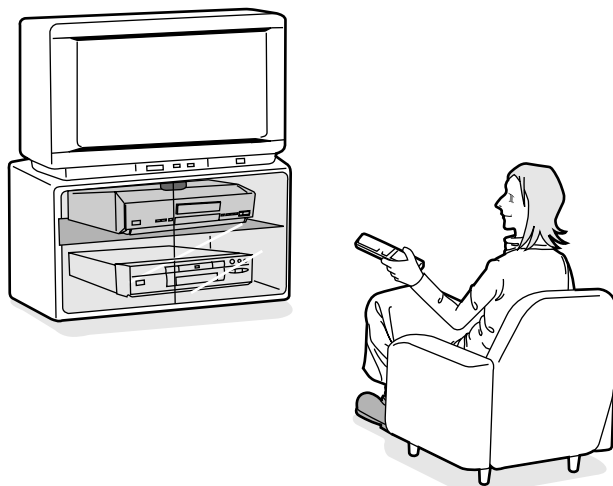

Playing discs

- Playing discs (⇒ page 22)
- Using the direct navigator (⇒ page 56)

Recording and Playing at the same time

- Chasing play (⇒ page 28)
- Simultaneous rec and play (⇒ page 28)
- Reviewing the recorded images while recording (Time Slip) (⇒ page 29)

Using DVD-R

- DVD-R (⇒ page 7)
- Recording television programs (⇒ page 26)
- Playing discs (⇒ page 22)
- Using the direct navigator (⇒ page 56)

Recording from a video cassette recorder

- Recording from a video cassette recorder (⇒ page 49)
- Connecting a video cassette recorder (⇒ page 79)

Changing the unit's settings

- Using on-screen menu icons (⇒ page 40)
- Changing the unit's settings (⇒ page 82)

Enjoying even better pictures

- Connecting to a TV with S-video or component video input terminals (⇒ page 15)
- Selecting TV screen type (⇒ page 21)

Recording programs

- Recording television programs (⇒ page 26)

Editing recordings

- Using play lists to edit programs (⇒ page 65)

Timer recording

- Using VCR Plus+ codes (⇒ page 43)
- Manual programming (⇒ page 46)

Watching CATV broadcasts

- Connecting a cable TV box (⇒ page 76)

Adjusting the picture

- Using on-screen menu icons (⇒ page 40)

Enjoying surround sound

- Enjoying virtual surround sound effects (V.S.S.) (⇒ page 39)
- Connecting an amplifier or system component with built-in decoder (⇒ page 78)
- Digital output (⇒ page 86)

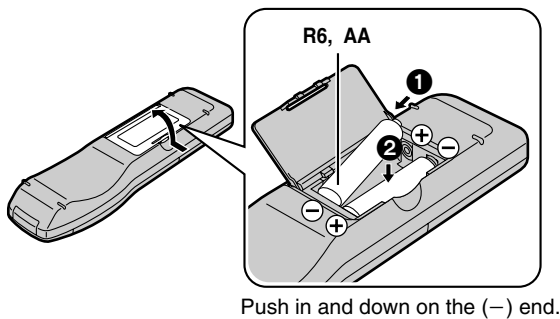
A

Push in and down on the (-) end.

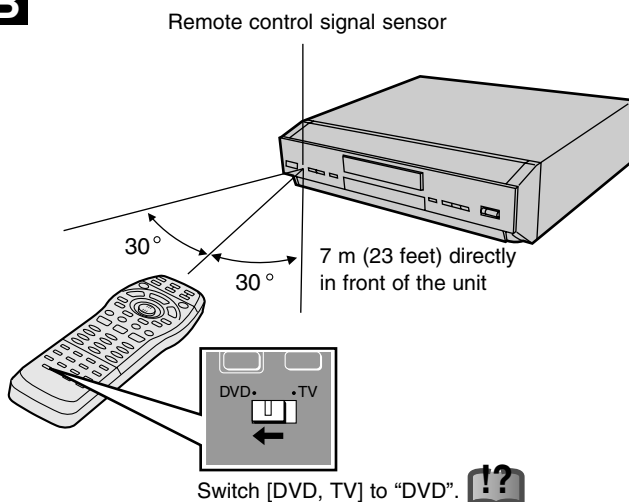
B

Switch [DVD, TV] to "DVD".

The remote control



A Batteries

- Insert so the poles (+ and -) match those in the remote control.
- Do not use rechargeable type batteries.

Do not:

- mix old and new batteries.
- use different types at the same time.
- heat or expose to flame.
- take apart or short circuit.
- attempt to recharge alkaline or manganese batteries.
- use batteries if the covering has been peeled off.

Mishandling of batteries can cause electrolyte leakage which can damage items the fluid contacts and may cause a fire.

If electrolyte leaks from the batteries, consult your dealer.

Wash thoroughly with water if electrolyte comes in contact with any part of your body.

Remove if the remote control is not going to be used for a long period of time. Store in a cool, dark place.

Replace if the unit does not respond to the remote control even when held close to the front panel.

Note

After changing the batteries, the codes you entered (television ➔ page 13 and remote control ➔ page 81) are cleared. Reenter the codes as necessary.



B Use

Aim at the sensor, avoiding obstacles, at a maximum range of 7 m (23 feet) directly in front of the unit.

- Keep the transmission window and the unit's sensor free from dust.
- Operation can be affected by strong light sources, such as direct sunlight, and the glass doors on cabinets.

Do not:

- put heavy objects on the remote control.
- take the remote control apart.
- spill liquids onto the remote control.



Television operation

You can control televisions by entering the remote control code.

Preparation

- Turn on the television.
- Switch [DVD, TV] to "TV".

1 Refer to the chart below for the code for your television.

2 Press and hold [TV, POWER ] and enter the two-digit code with the numbered buttons.

- For example: 01, press [0] → [1].
- Point the remote control at the television.
- After entering the code, test the remote control by turning on the television and changing channels.

Note

- If there is more than one code, repeat the procedure until you find the code that allows correct operation.
- If your television brand is not listed or if the code listed for your television does not allow control of your television, this remote control is not compatible with your television.
- This remote control works with most recently manufactured televisions, but may not be able to control all the functions on older models. Use the remote control supplied with your television if this is the case.

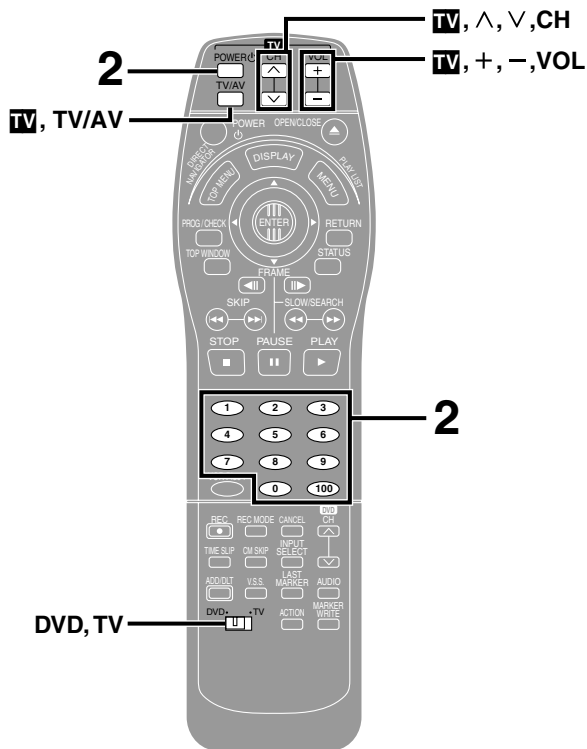

2

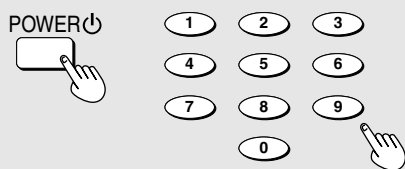

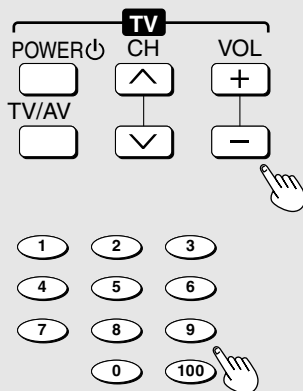

A



Code No.	Manufacturer
01	Panasonic/National QUASAR
02	Panasonic/National QUASAR
03	MAGNAVOX SYLVANIA PHILIPS (RC-5)
04	ZENITH
05	THOMSON RCA GE
06	SHARP
07	SHARP
08	SONY
09	TOSHIBA
10	SANYO FISHER
11	JVC
12	HITACHI
13	MITSUBISHI
14	SAMSUNG
15	GOLDSTAR/LG
16	GOLDSTAR/LG
17	GOLDSTAR/LG
18	SAMSUNG

■ Operation A

Operation	Button
On and off	[TV, POWER 
Video input mode	[TV, TV/AV]
Channels	[TV,  ,  , CH] Numbered buttons (→ page 8)
Volume	[TV, +, -, VOL]

Antenna and television connections

Preparation

- Refer to the television's operating instructions.
- Turn the television off and disconnect its AC power supply cord.

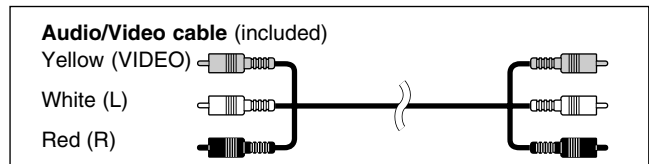

Basic connection

Getting started

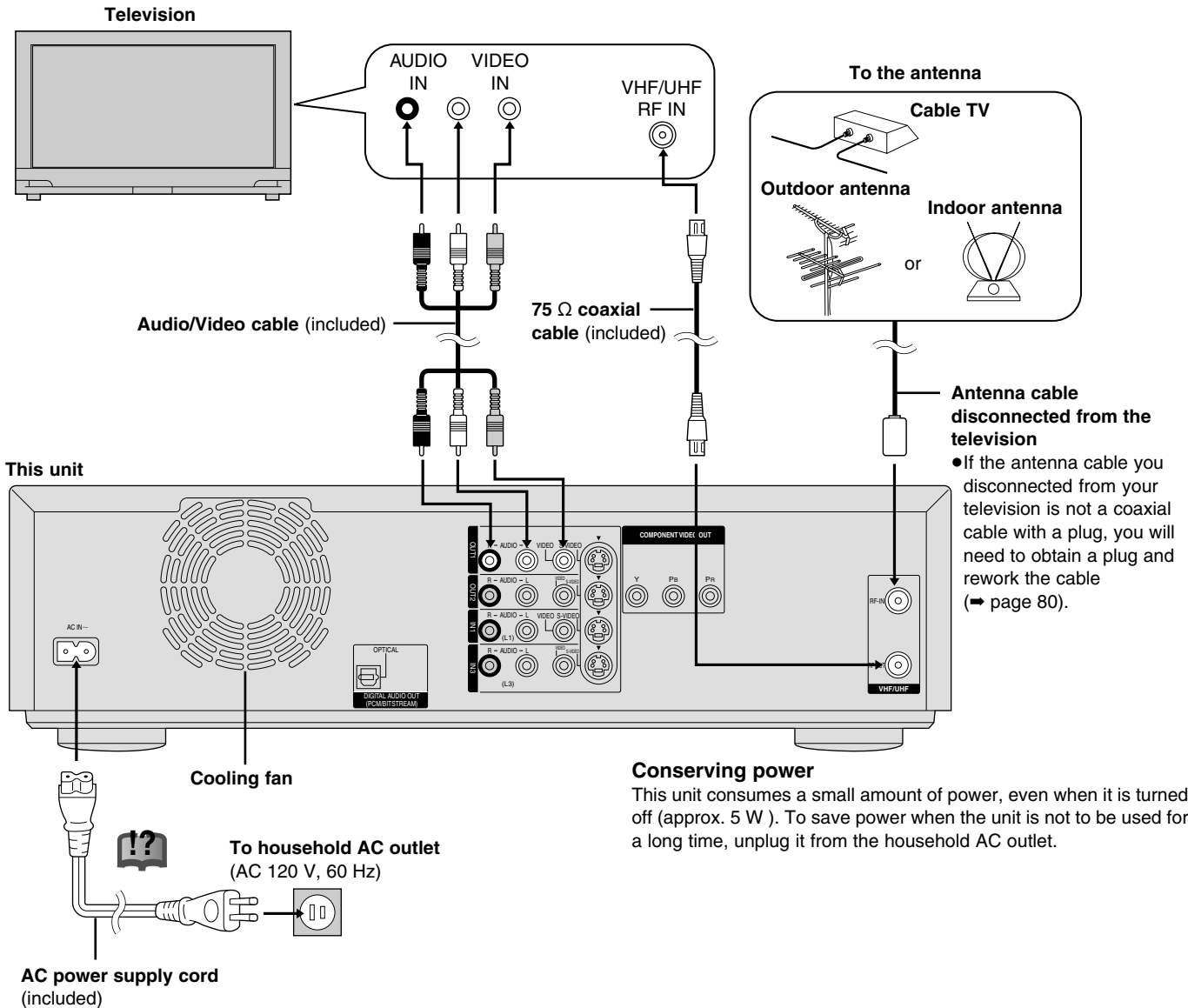

■ When you have finished connecting the unit

Change the unit's settings to suit your television's aspect ratio (➔ "Selecting TV screen type", page 21). You do not have to change this setting if you have a television with a regular 4:3 aspect.

Connect Your Unit Directly To Your Television.

Do not connect the unit through your video cassette recorder when setting up your home entertainment system, because the picture may not be played correctly due to the copy guard.

■ Upgrading your system

To enjoy CATV broadcasts

See "Expanding your home theater system" on page 75. (A contract with a cable TV company is required in most cases to view these broadcasts.)

To enjoy sound through other audio equipment

You can output digital signals from this unit's DIGITAL AUDIO OUT terminal, enabling you to enjoy the powerful surround effects found on discs recorded with Dolby Digital or DTS. Connect an amplifier with built-in decoders. See page 78 for connection examples.

Connecting to a TV with S-video or component video input terminals

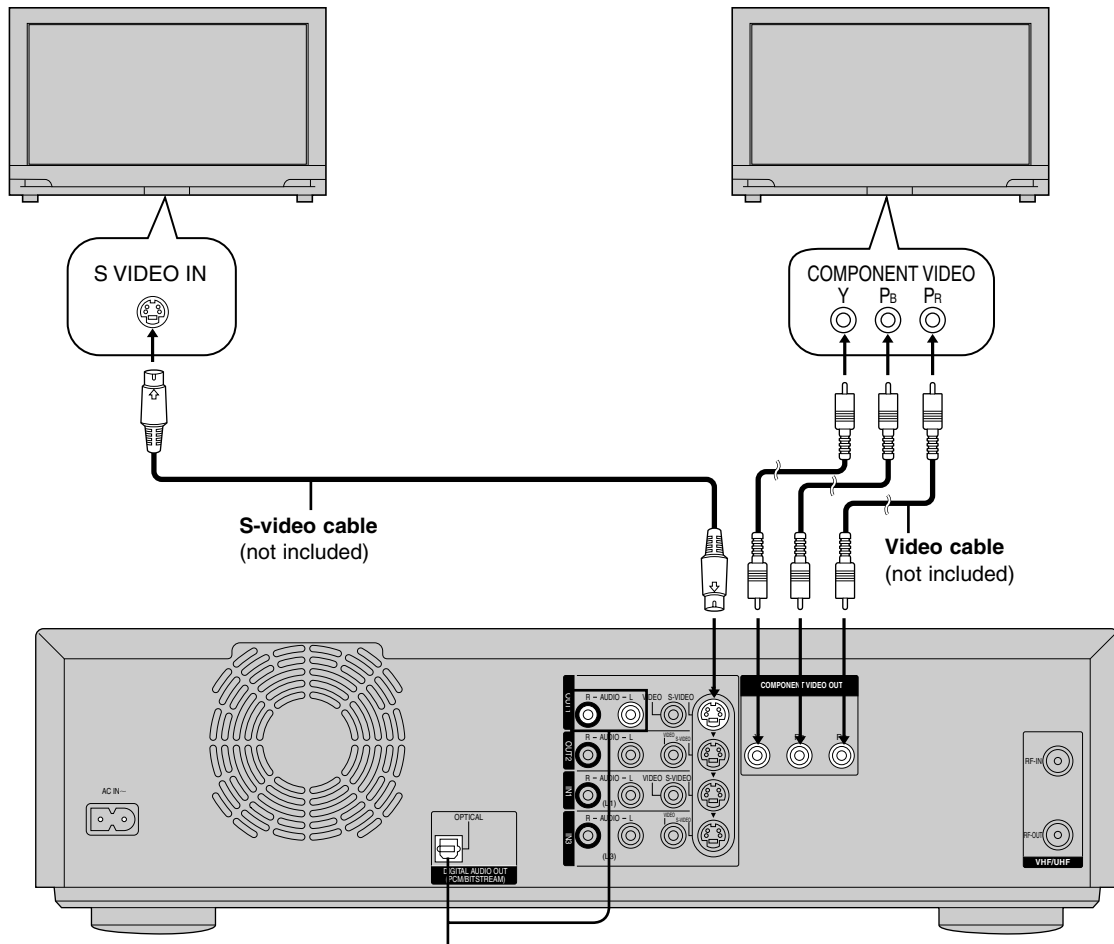

Connect the audio cables as well (⇒ pages 14 and 78).

S VIDEO OUT terminal

The S-video terminal achieves a more vivid picture than the VIDEO OUT terminal by separating the chrominance (C) and luminance (Y) signals. (Actual results depend on the television.)

For your reference

You do not have to connect anything to the VIDEO OUT terminal if you have connected the unit to your television with the COMPONENT VIDEO OUT or S VIDEO OUT terminals.

COMPONENT VIDEO OUT terminal

These terminals can provide a purer picture than the S-VIDEO OUT terminal.

Connection using these terminals outputs the color difference signals (P_B/P_R) and luminance signal (Y) separately in order to achieve high fidelity in reproducing colors.

- The description of the component video input terminals depends on the television or monitor (e.g. Y/P_B/P_R, Y/B-Y/R-Y, Y/C_B/C_R). Connect to terminals of the same color.
- After making this connection, change the black level for a better picture (⇒ page 82, ACTION—Video—Black Level Control).

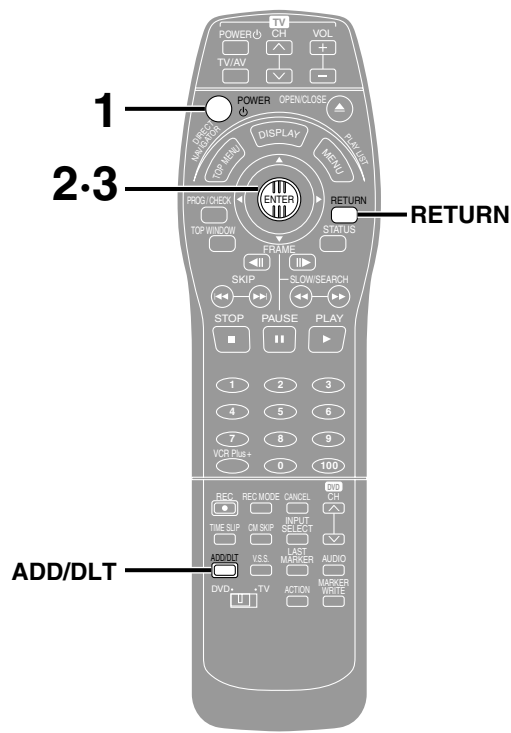

1

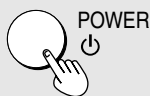

2-3



A

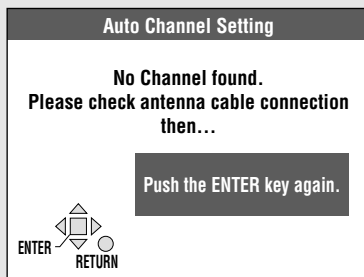

B

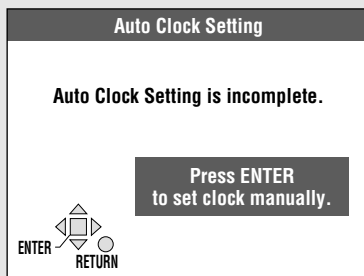

Plug-in Auto Tuning

After you purchase the unit, plug it into your household AC outlet, and turn it on for the first time, the unit automatically tunes in all the channels it can receive and sets the clock.

Preparation

- Confirm that the antenna is connected correctly.
- Turn on the television and select the appropriate video input to suit the connections to this unit.

1 Press [POWER] to turn the unit on.

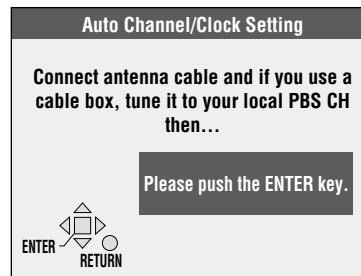

2 Press [ENTER].

Plug-in Auto Tuning starts and the unit puts the stations it can receive into channels.

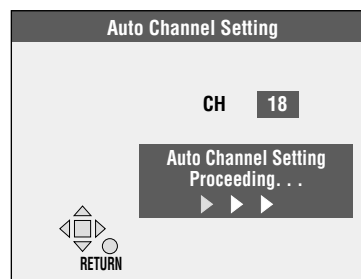

The unit then proceeds with Auto Clock Setting unless the clock has already been set.



The time is displayed when finished.

3 Press [ENTER].

■ If the channels couldn't be tuned **A**

The illustrated screen appears. Press [ENTER] to start Plug-in Auto Tuning again. Press [RETURN] to cancel.

If the channels still aren't tuned, use [ADD/HLT] on the remote control to tune channels (➔ page 18).

■ If the clock couldn't be set automatically **B**

The illustrated screen appears. Press [ENTER] to show the "Manual Clock Setting" screen. Set the time manually (➔ page 88).

■ To stop Plug-in Auto Tuning

Press [RETURN].

⏻/I, POWER ∇, ^, CH

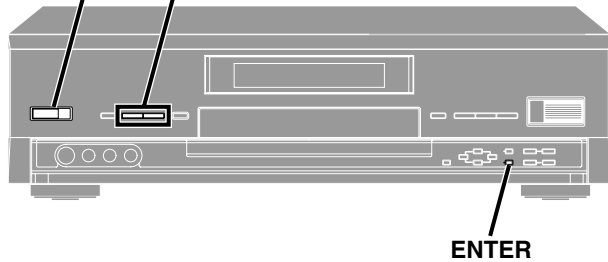

Note

- Plug-in Auto Tuning does not work if you turn the unit on by pressing [▲, OPEN/CLOSE] or [▶, PLAY].
- After the unit sets the clock automatically, it then adjusts the clock everyday.
- If the unit sets the time incorrectly, use “Time Zone Adjust” to correct it (⇒ page 89).
- You can give the stations captions (⇒ page 92).
- If you connect the unit through a cable TV box or DSS receiver (⇒ page 76), tune to your local PBS station before starting auto clock setting. Use manual clock setting (⇒ page 88) if this does not work.
- If there is no local PBS channel in your area then Auto Clock Setting may not work correctly. In this case the time must be set manually (⇒ page 88).

■ Channel plan

The unit automatically determines the type of transmission (airwave or cable) and puts them into channels as follows.

● TV Mode

Band	Stations received by airwaves
VHF	2–13
UHF	14–69

● CATV Mode

Band	Stations received by cable
VHF	2–13
CATV LOW BAND	95–99
CATV MID/SUPER BANDS	14–36
CATV HYPER BAND	37–65
ULTRA BAND	66–94 100–125
SPECIAL CATV CHANNEL	1

■ To start Plug-in Auto Tuning again (after moving house, for example)

Main unit only

While the unit is on and stopped

1. Press and hold [∇, CH] and [^, CH] for about five seconds.
 - The unit turns off.
2. Press [⏻/I, POWER] to turn the unit on.

The screen shown in step 1 on page 16 appears. Press [ENTER] to start Plug-in Auto Tuning.

- Antenna system, channel caption, and VCR Plus+ guide channel settings all revert to the default values when you perform the above procedure. Timer recording settings are also cleared.

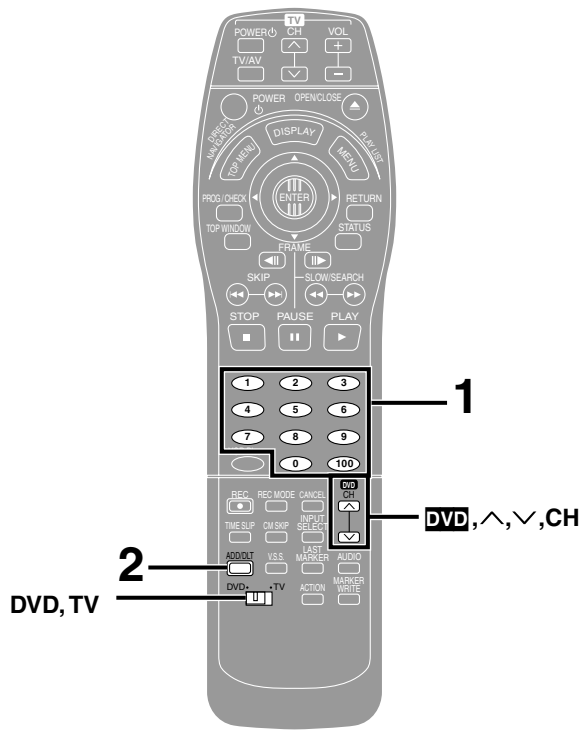

1

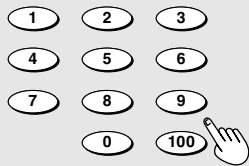

2



Channel settings

Using the remote control to add and delete channels

Remote control only

Use this function if:

- Channels were not set correctly using automatic tuning.
- A channel that should have been set wasn't.
- A channel's reception is poor and you want to delete it.

Preparation

Switch [DVD, TV] to "DVD".

1 Press the numbered buttons to select a channel.

Example: "5": [0] → [5]

"15": [1] → [5]

"115": [100] → [1] → [5]

- You can also use [DVD, ^, v CH] when you are going to delete a channel.

2 Press [ADD/HLT].

The channel is **deleted** if it was set or **added** if it was not set.

For example

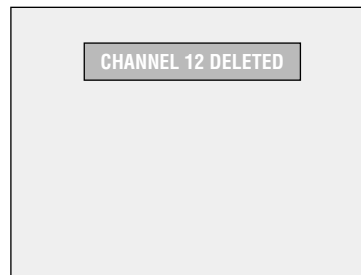

Repeat steps 1 and 2 as necessary.

Note

This function does not work if:

- A disc is playing.
- You are recording.
- Input is from an external unit.

VCR Plus+ guide channel settings



Set these guide channels so you can use VCR Plus+ codes for timer recording. Before starting the settings, prepare a chart showing the channels, the station's name, and the guide channel. For example:

Channel number	Station name	Guide channel
04	CBS	04
15	HBO	33
20	Nickelodeon	38

Write down all the stations you can receive Look up the guide channels for the stations in a television guide

1 Press [ACTION].

The ACTION screen appears.

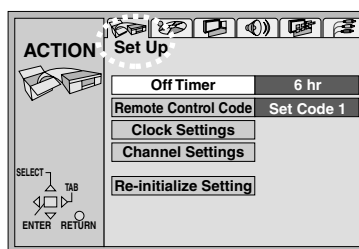

2 Use the joystick [◀, ▶] to select the Set Up tab.

3 Use the joystick [▲, ▼] to select "Channel Settings" and press [ENTER].

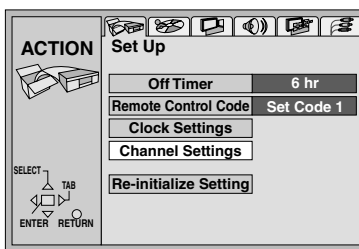

(Continued on next page)

2.3



1

1



2



3

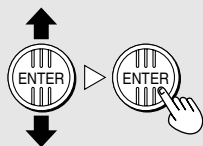

4.5.6



4 Use the joystick [▲, ▼] to select “VCR Plus+ CH Setting” and press [ENTER].

For example, when the current antenna system is CATV.

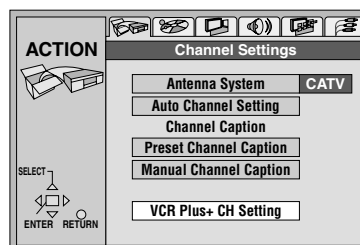

When you press [ENTER]

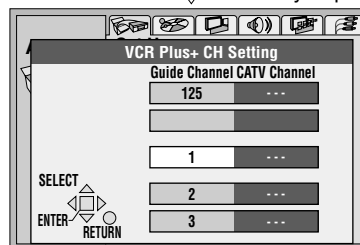

5 ① Use the joystick [▲, ▼] to select the guide channel you want to set and use the joystick [▶].

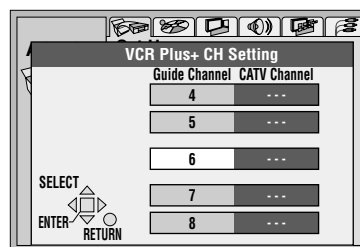

•The screen scrolls a page at a time if you hold the joystick up or down.

② Use the joystick [▲, ▼] to select the channel corresponding to the guide channel and use the joystick [◀].

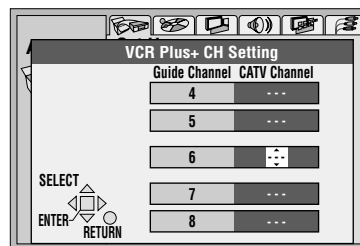

Repeat steps ① and ② as necessary.

6 Press [ENTER].

The screen shown in step 4 reappears.

Note

You do not need to change the settings if the channel and guide channel numbers are the same.

■ To end the setting

Press [ACTION].

■ If you make a mistake

While the TV channel or CATV channel is highlighted, press [CANCEL]. “---” is displayed. Repeat step 5-②.

4

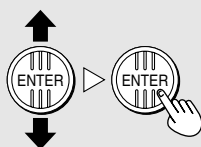

5

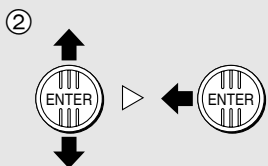
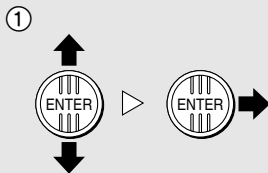

6



Selecting TV screen type

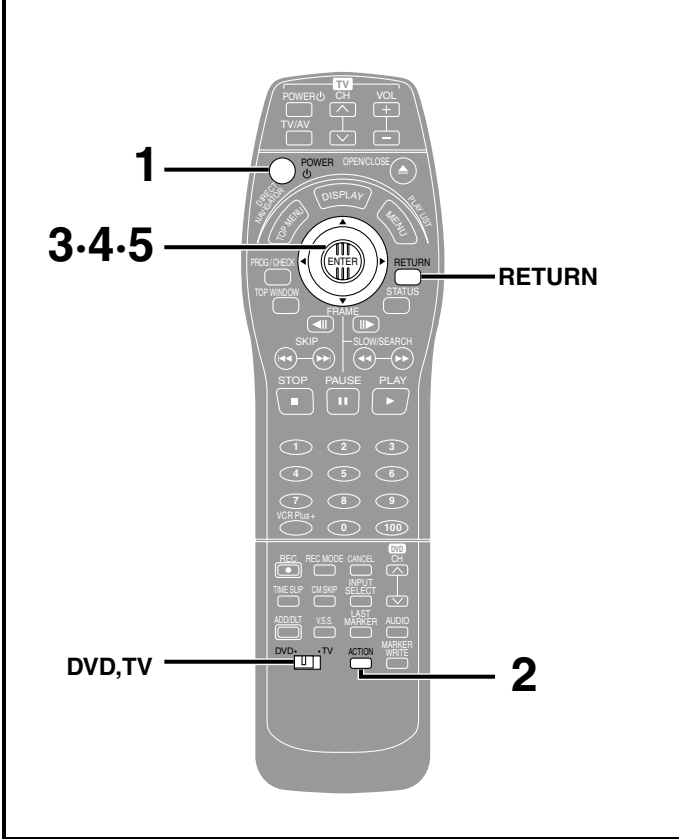

The aspect ratio is factory set to 4:3 for a regular television. You do not have to change this setting if you have a regular 4:3 aspect television.

Preparation

- Turn on the television and select the appropriate video input to suit the connections to this unit.
- Switch [DVD, TV] to "DVD".

1 Press [POWER] to turn this unit on.

2 Press [ACTION] to show the menus.

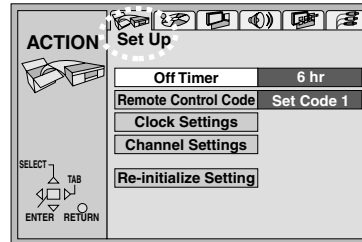

3 Use the joystick [◀, ▶] to select the TV Screen tab.

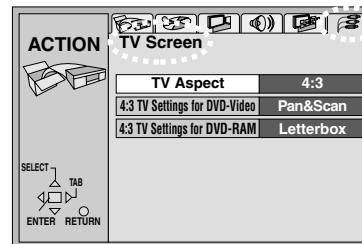

4 Use the joystick [▲, ▼] to select "TV Aspect" and press [ENTER].

5 Use the joystick [▲, ▼] to select the TV aspect and press [ENTER].

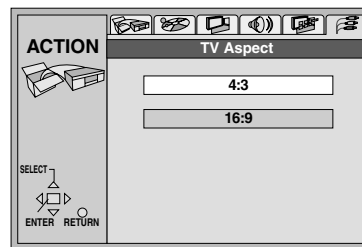

- 4:3 (factory setting)
- 16:9

■ To return to the previous screen

Press [RETURN].

■ To end the setting

Press [ACTION].

For your reference

Apart from "TV Aspect", other settings also affect how video appears on your television. Check the following if video doesn't appear correctly on your television.

- "ACTION—TV Screen—4:3 TV Settings for DVD-Video" or "4:3 TV Settings for DVD-RAM" (➡ page 83).
- The video setting on the disc. How video appears is often specified by the disc itself.
- The video settings on your television.

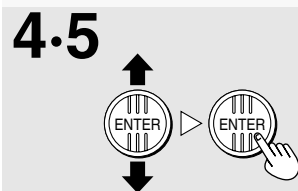
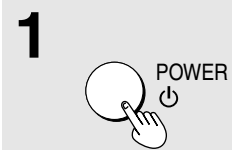

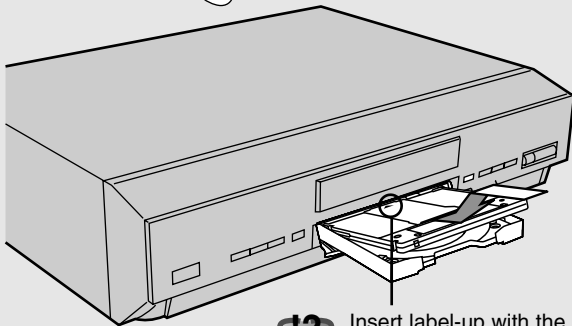
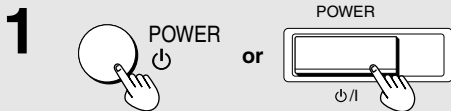
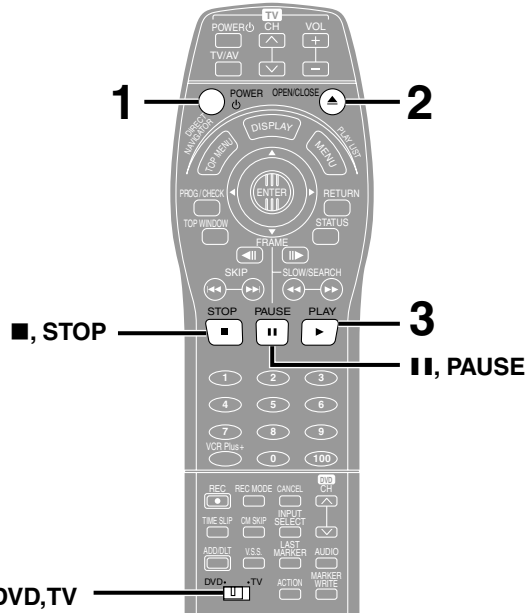
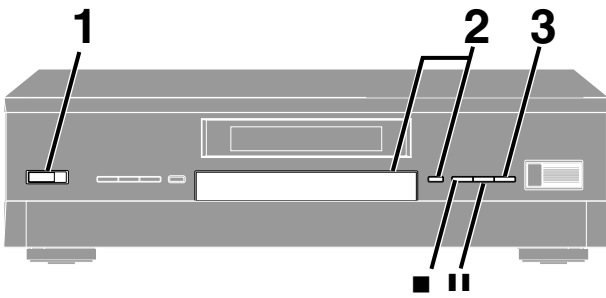

! Insert label-up with the arrow facing in.
(With double-sided discs, load so the label for the side you want to play is facing up.)

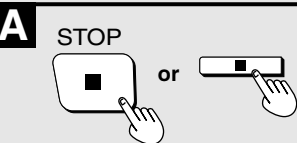

Playing discs



RAM DVD-R DVD-V **CD** VCD

Preparation

Switch [DVD, TV] to "DVD".

- 1** Press [⏻, POWER] to turn the unit on.
- 2** Press [▲, OPEN/CLOSE] to open the tray and insert a disc.
 - Insert inside the tray's guides.
 - Insert one disc only.
- 3** Press [▶, PLAY].
The disc tray closes and play begins.
(The unit takes some time to read the disc before play starts.)

■ To stop play **A**

Press [■, STOP] (When "PLAY" flashes → page 23, Starting play from where you stopped it).

• The screen saver at right may appear when you stop play. Press [■, STOP] again and you can use this unit's tuner to watch television.

This screen is also shown when you are playing CDs.



■ To pause play

Press [⏸, PAUSE].
Press again to restart play.

■ Auto power-off

The unit switches to standby after about 6 hours in the stop mode. You can turn this feature off or change the time to 2 hours (→ page 82, ACTION—Set Up—Off Timer).

■ With non-cartridge discs

!? Insert label-up. (With double-sided discs, load so the label for the side you want to play is facing up.)

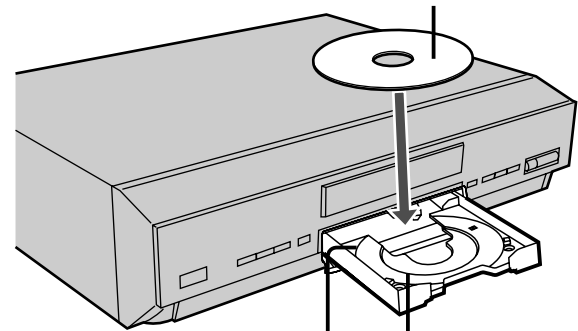

Guide for 12 cm (5") disc
Guide for 8 cm (3") disc

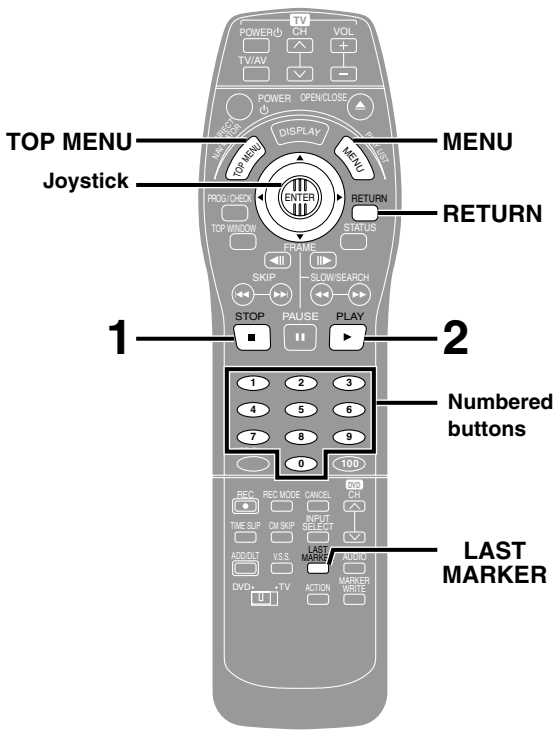

A When a menu screen appears on the television

DVD-V VCD
Operate menus with the following operations. Actual operations depend on the disc.

Press the numbered buttons to select an item (⇒ page 8), or move the joystick (▲, ▼, ◀, ▶) to select an item and press [ENTER].

- You can return to menus after you start play by pressing [TOP MENU] or [MENU] (DVD-Video), or [RETURN] (Video CD).



Note

- Discs continue to rotate while menus are displayed. Press [■, STOP] when you have finished viewing to preserve the unit's motor and your television screen.
- Volume may be lower when playing DVD-Video than when playing other discs or during television broadcasts. If you turn the volume up on the television or amplifier, ensure you reduce the volume again before playing other sources or returning to the television so that a sudden increase in output does not occur.

For your reference

- If "⊙" appears on the television
The operation is prohibited by the unit or disc.
- If a disc is loaded, the unit will come on and play will start when you press [▶, PLAY].
- If you play a disc with video and then replace it with an audio-only disc, the video from the previous disc may continue to be shown on the television.

B Starting play from where you stopped it (Resume Function)

RAM DVD-R DVD-V CD VCD

- 1** During play
Press [■, STOP].
The unit remembers the position.
- 2** Press [▶, PLAY] while "PLAY" is flashing on the display.
Play starts from where you stopped it.

■ To cancel the resume function

Press [■, STOP] until "PLAY" goes out.
(The position is also cleared when you turn the unit off.)

■ To start play from a memorized position after turning the unit off

Press [LAST MARKER] during play.
(The message "Position Memorized" appears on the television.)
Now when you press [▶, PLAY] after switching the unit to standby and back on, play starts from the memorized position.

For your reference

- If you press [■, STOP] before switching the unit to standby after pressing [LAST MARKER] to memorize a position, play will resume from the position you pressed [■, STOP] when you press [▶, PLAY].
- The position memorized when you press [■, STOP] is cleared when you switch the unit to standby or if the unit switches to standby automatically (⇒ page 82, ACTION—Set Up—Off Timer).

DVD-R DVD-V CD VCD

- The position is memorized when you press [■, STOP] or [LAST MARKER] and cleared when you open the disc tray.

RAM

- The last marker is written to the disc and remains intact until you mark a different position.
You cannot mark positions if the disc is write-protected with DISC SETTING (⇒ page 52) or with the write-protect tab (⇒ page 99). Release the protection before marking another position.

A

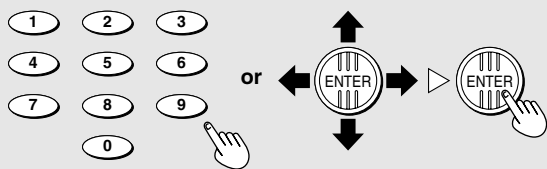

B

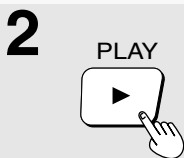

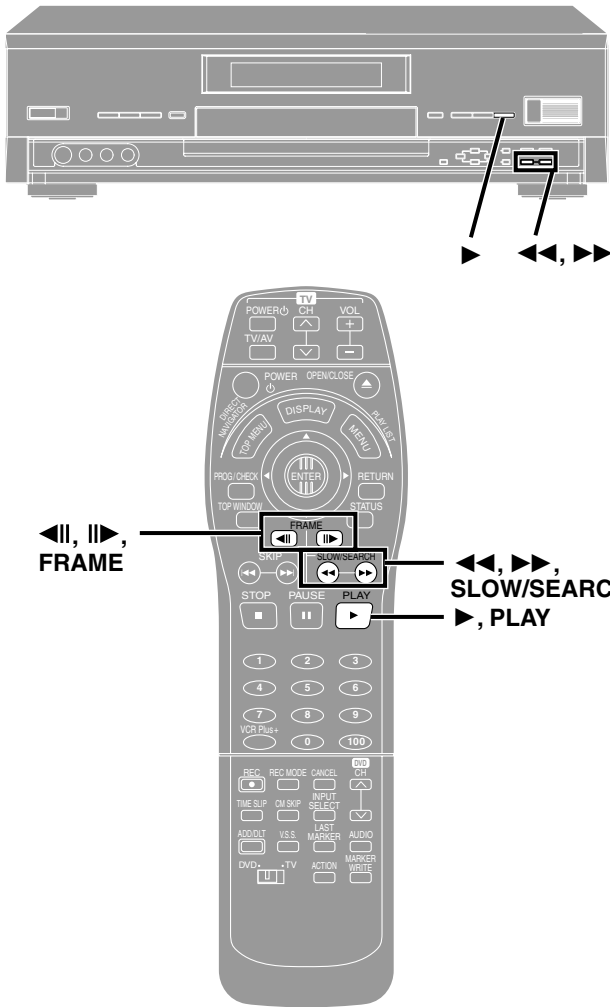

Playing discs

A Fast forward and rewind—SEARCH

RAM DVD-R DVD-V **CD** VCD

During play

Press [**◀◀**, SLOW/SEARCH] or [**▶▶**, SLOW/SEARCH].

[**◀◀**]: backward

[**▶▶**]: forward

- There are five search speeds. Each press increases the search speed.
- The search speed is maintained when you release the button.
- Press [**▶**, PLAY] to restart play.
- Audio is output during search with most discs, but only at forward speed one with DVD-RAM (except during chasing play and simultaneous rec and play), DVD-R, DVD-Video, and Video CDs. You can turn off the audio during search for DVD-RAM, DVD-R, DVD-Video, and Video CDs (➔ page 83, ACTION—Audio—Audio during Search).

B Slow-motion play

RAM DVD-R DVD-V VCD

While paused

Press [**◀◀**, SLOW/SEARCH] or [**▶▶**, SLOW/SEARCH].

[**◀◀**]: backward (does not work with Video CDs)

[**▶▶**]: forward

- There are five slow-motion speeds. Each press increases the slow-motion speed.
- The slow-motion speed is maintained when you release the button.
- Press [**▶**, PLAY] to restart play.

C Frame-by-frame viewing

RAM DVD-R DVD-V VCD

Remote control only

While paused

Press [**◀||**, FRAME] or [**||▶**, FRAME].

[**◀||**]: backward (does not work with Video CDs)

[**||▶**]: forward

- Each press shows the next frame.
- Press [**▶**, PLAY] to restart play.

A

SLOW/SEARCH

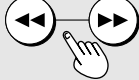

or

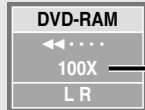
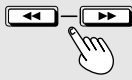

Search speed

B

SLOW/SEARCH



or

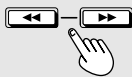

C

FRAME



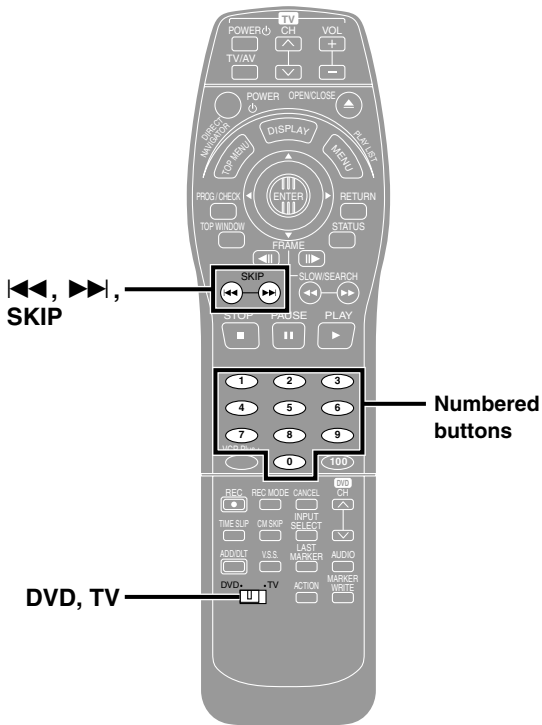
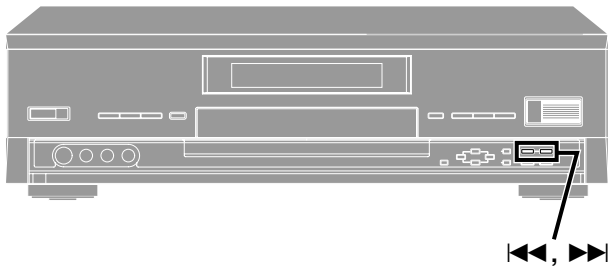

A Skipping

RAM DVD-R DVD-V **CD** VCD

You can skip to the beginning of tracks (CD and Video CD → page 97) and chapters (DVD-Video → page 97) and restart play from there.

On DVD-RAM and DVD-R, you can skip to the start of a program or to a marker and start play from there.

During play or while paused

Press [**◀◀**, SKIP] or [**▶▶**, SKIP].

[◀◀]: backward

[▶▶]: forward

Each press increases the number of skips.

For your reference

- After skipping, the unit returns to the previous state, play or pause.
- Pressing [**◀◀**] or [**▶▶**] while the playback control feature on Video CDs (→ page 97) is working may take you to a menu screen.
- You can also mark positions to skip to (→ page 36).

B Starting play from a selected program, title, chapter, or track

RAM DVD-R DVD-V **CD** VCD

Remote control only

Preparation

Switch [DVD, TV] to "DVD".

During play or while stopped*

Press the numbered buttons to select the item.

For example, to enter 5, press [0] and [5].

To enter 15, press [1] and [5].

*This works only when stopped with some discs (the screen saver is on the television).



A

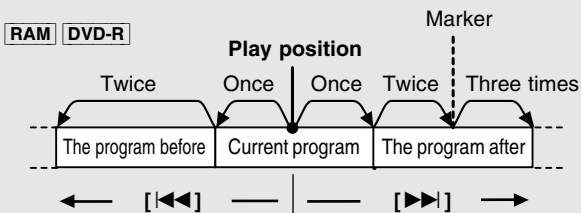
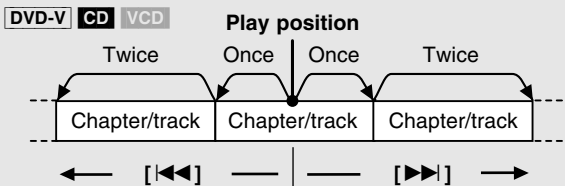
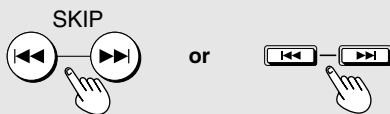

B

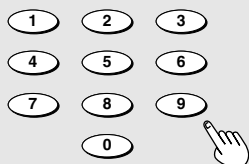

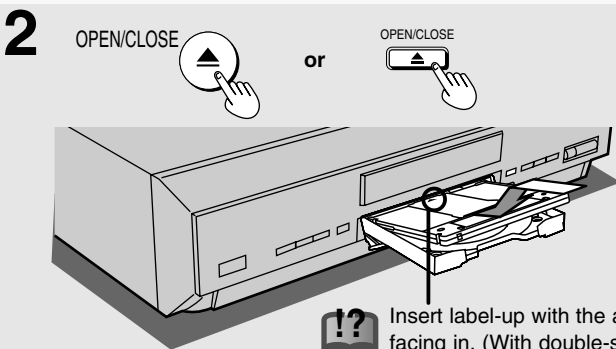
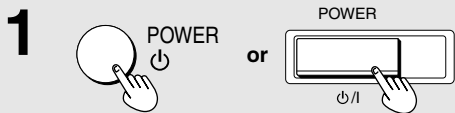
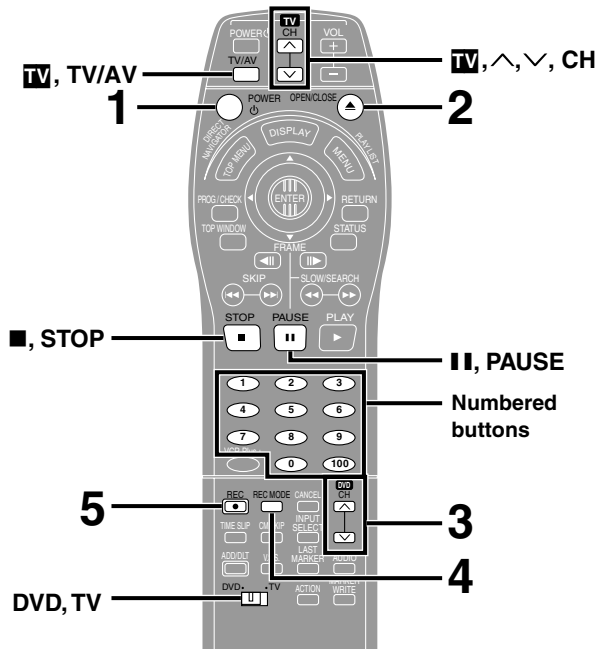
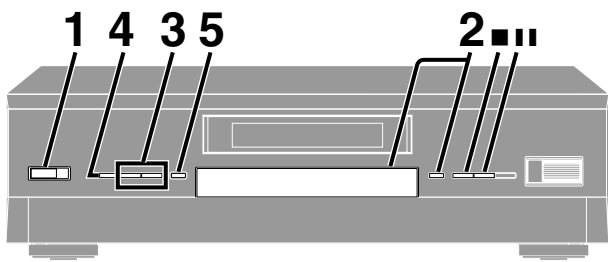

!? Insert label-up with the arrow facing in. (With double-sided discs, load so the label for the side you want to record is facing up.)

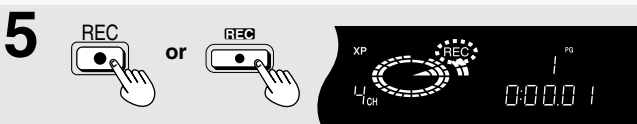
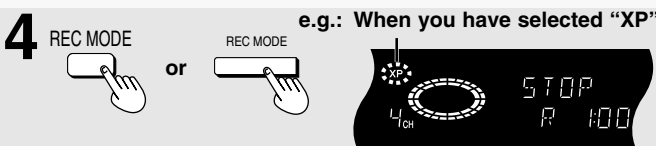
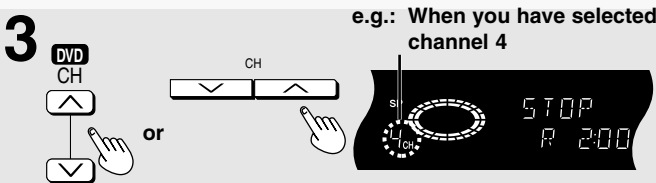

Recording television programs

RAM **DVD-R**

Preparation

- Switch [DVD, TV] to "DVD".
- Use a disc that the unit can record to (⇒ page 6) and that has enough space available.
- Ensure the disc is not write-protected with the write-protect tab (⇒ page 99).
- Ensure the disc is not write-protected with DISC SETTING (⇒ page 52).

1 Press [POWER] to turn the unit on.
2 Press [OPEN/CLOSE] to open the tray and insert a disc.

- Insert one disc only within the tray's guides.
- Press [OPEN/CLOSE] to close the tray.
- When using a DVD-RAM for the first time with this unit, format it to ensure accurate recording (⇒ page 54, "Format"). Check the disc carefully to ensure it doesn't contain programs you want to keep.

3 Press [DVD], ^, v, CH to select the channel.

4 Press [REC MODE] to select the recording mode.

Select "XP", "SP", "LP", or "EP" (⇒ see below).

5 Press [REC] to start recording.
 • The program is recorded into the available space on the disc.

■ To pause recording

Press [PAUSE].
 Press again to restart recording.

■ To stop recording

Press [STOP].

■ To select channels with the numbered buttons

When "TV" is the antenna system: between 2 and 69
 When "CATV" is the antenna system: between 1 and 125
 Press the numbered buttons.

For example: Channel 5, press 0 ⇒ 5
 Channel 15, press 1 ⇒ 5
 Channel 115, press 100 ⇒ 1 ⇒ 5

■ Convenient features

- Chasing play—playing from the beginning of the program you are recording (⇒ page 28)
- Simultaneous rec and play—watching a program you recorded while recording another (⇒ page 28)
- Time Slip—checking the images you are recording (⇒ page 29).

■ Recording modes

For example, approximate recording times with a 4.7-GB DVD-RAM

XP: 1 hour, high picture quality
 SP: 2 hours, standard picture quality
 LP: 4 hours, long play
 EP: 6 hours, extra long play

■ Watching the television while recording

- ① Switch [DVD, TV] to "TV".
- ② Press [TV, TV/AV] to change the input mode to "TV".
- ③ Press [TV, ^, v, CH] to change channels.
 You can also select the channel with the numbered buttons (⇒ page 8).

For your reference

- You can also do this during timer recording.
- The recording is unaffected.

Recording television programs

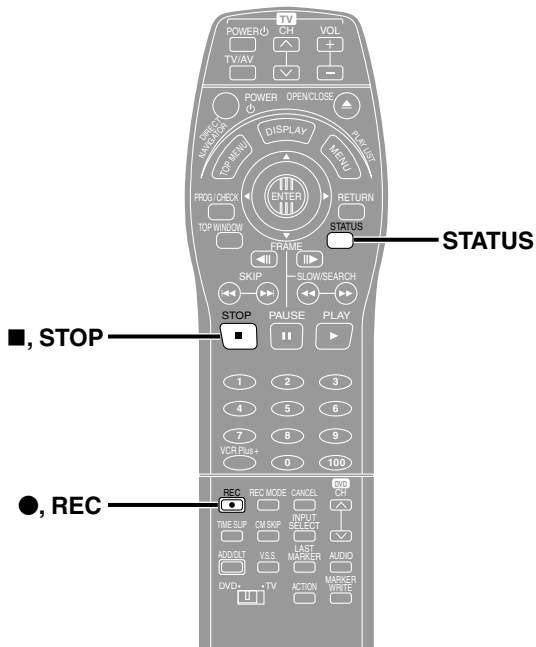
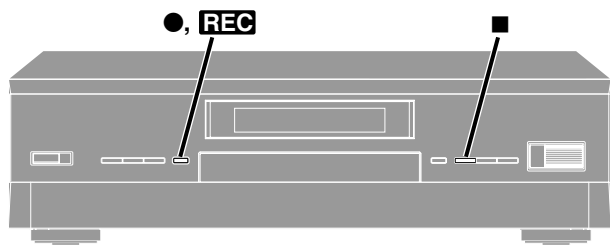

■ Re-inserting double-sided discs

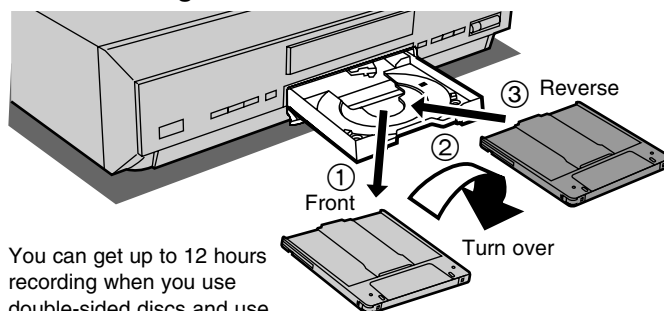

You can get up to 12 hours recording when you use double-sided discs and use the "EP" mode.

■ To check the remaining time and the current mode during recording **A**

Press [STATUS] several times.

For your reference

- You can record up to 99 programs on one disc.
- You cannot change the channel or recording mode during recording. You can change them while recording is paused, but the material is recorded as a separate program.
- An error message appears if you try to start recording when a disc is full; the remaining time will be shown as "0:00". To continue recording, erase unneeded programs (DVD-RAM only → page 58, Erasing programs) or use another disc.
- There are limitations when recording to DVD-R (→ page 7).
- The message "Could not write to disc." is displayed when recording was not completed correctly. Check the discs for dirt or scratches.

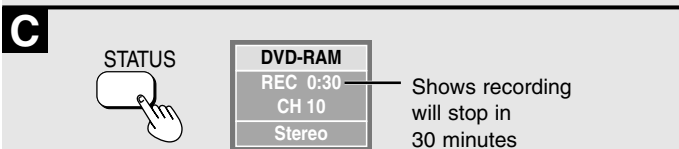
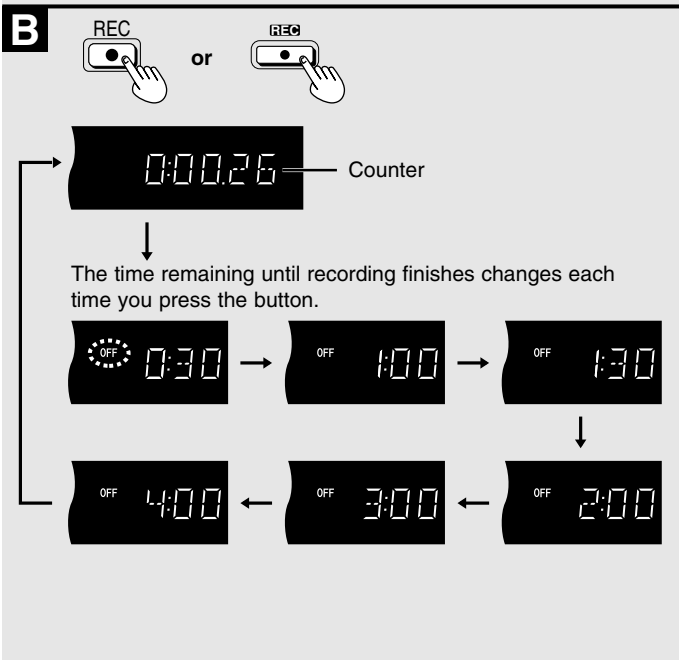
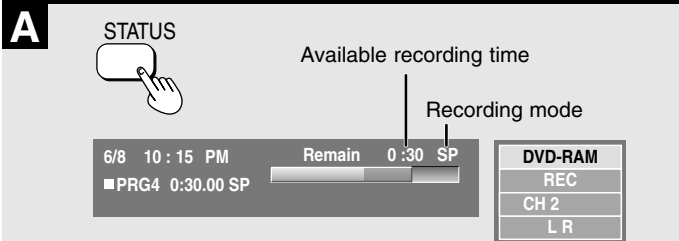

B One Touch Recording—Specify a time to stop recording

[RAM] [DVD-R]

This is a simple way of timer recording when you are in a hurry or before you go to bed. You can set the time up to 4 hours in advance.

While recording

Press [●, REC] to select the recording time.

The time increases as illustrated each time you press the button. After selecting the time the display updates indicating the time remaining until the unit stops recording. You can change the time again with the same operation. When the time you set is reached, recording stops and the unit switches to standby.

■ To cancel

During recording, press [●, REC] until the counter appears.
• Recording continues.

■ To show the time remaining until recording finishes **C**

Press [STATUS].

For your reference

- This does not work during timer recordings.
- Recording stops and the set time is cleared if you press [■, STOP].
- The set time is cleared if you pause recording and cause another program to be recorded (for example, change the recording mode or channel).

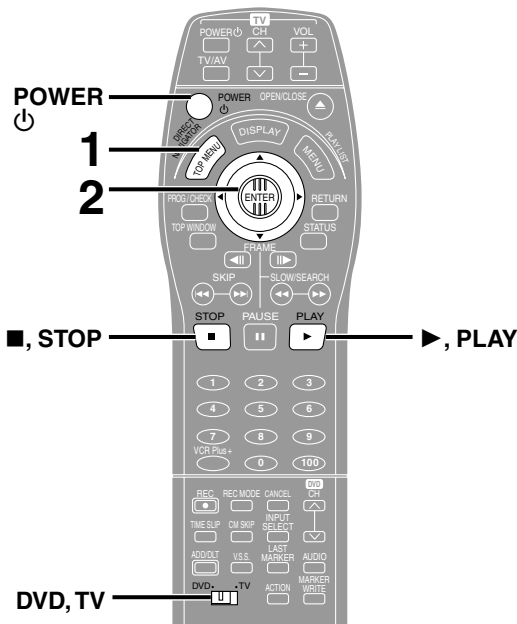

Playing while you are recording

A Playing from the beginning of the program you are recording—Chasing play

RAM

You can start play from the beginning of a program while continuing to record it.

Preparation

Switch [DVD, TV] to “DVD”.

During recording or timer recording

Press [▶, PLAY].

Play starts from the beginning of the program being recorded.

■ To stop play and recording

① Press [■, STOP]. Play stops.

Wait 2 seconds.

② Press [■, STOP]. Recording stops.

• You cannot stop recording with [■, STOP] during timer recording. To stop timer recording, press [⏻, POWER], then [■, STOP] within 5 seconds.

For your reference

- The playback images are displayed during chasing play.
- Sound is not output while fast-forwarding.
- Play cannot be started until at least 2 seconds after recording starts.
- If you fast-forward and get to within a few seconds of the part being recorded, the picture will change to show the images currently being played.

B Simultaneous rec and play

RAM

You can start play of the program you are recording or play a program previously recorded.

Preparation

Switch [DVD, TV] to “DVD”.

During recording or timer recording

1 Press [TOP MENU, DIRECT NAVIGATOR].

“●” is displayed in the direct navigator to indicate the program is being recorded (→ page 57).

2 Use the joystick [▲, ▼] to select a program and press [ENTER].

■ To stop play and recording

① Press [■, STOP]. Play stops.

Wait 2 seconds.

② Press [■, STOP]. Recording stops.

• You cannot stop recording with [■, STOP] during timer recording. To stop timer recording, press [⏻, POWER], then [■, STOP] within 5 seconds.

For your reference

- During simultaneous rec and play, you cannot edit with the direct navigator or use play lists.
- If you start play while the unit is on timer recording standby, recording starts when the time you set is reached.
- The unit returns to recording standby when you stop play while it is on timer recording standby.

A



For example:
while recording program 2 (sport)

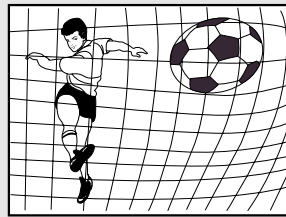

You are recording a **sports program** (2) and you want to watch it from the beginning.

Do the above operation and... ▼



The same **sports program** is recorded while you are watching it.

B



For example:
while recording program 2 (sport)

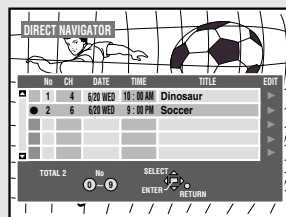

You want to watch the **movie** you recorded yesterday (program 1)

Do the above operation and... ▼

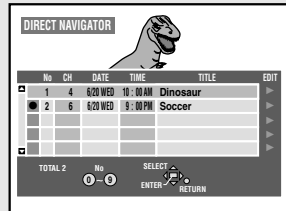

A **sports program** is recorded while you watch a **movie**.

⏻/I, POWER

■ TIME SLIP

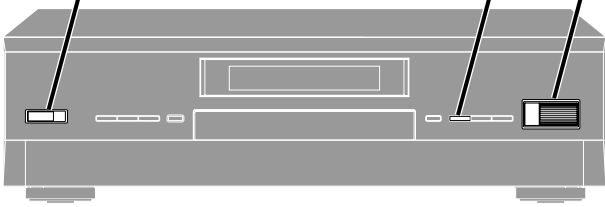

POWER ⏻

■, STOP

TIME SLIP

DVD, TV

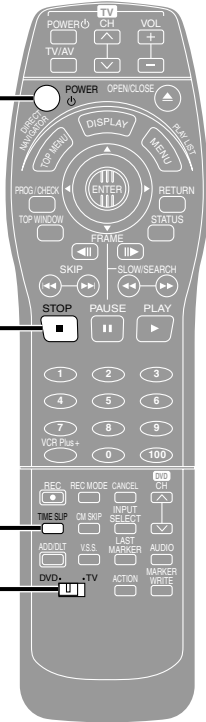

Playing while you are recording

Reviewing the recorded images while recording (Time Slip)

RAM

You can play the program being recorded to check that it is being recorded correctly. You can also check parts that were recorded previously.

Preparation

Switch [DVD, TV] to "DVD".

While recording or timer recording

Press [TIME SLIP].

Play starts from 30 seconds previous.

The play images are shown for 5 seconds as a picture-in-picture with the recording images, then they are shown in full.

■ To continue to show both the recording and play images

Press and hold [TIME SLIP] for about 3 seconds.

■ To change the part being played **A**

Main unit only

- Turn [TIME SLIP] on the main unit.
 - Turn down to increase in one-minute units.
 - Turn up to decrease in one-minute units.
- Press [TIME SLIP] on the main unit within 5 seconds to enter the time.
 - Play starts from the time you entered.

Note

You cannot change the position being played with the remote control.

■ To stop play and recording

- Press [■, STOP]. Play stops.
 - Wait 2 seconds.
- Press [■, STOP]. Recording stops.
 - You cannot stop recording with [■, STOP] during timer recording. To stop timer recording, press [⏻, POWER], then [■, STOP] within 5 seconds.

For your reference

- If you fast-forward, rewind, or skip during Time Slip, only the play images are shown.
- The sound for the images being played is heard during Time Slip.
- The length of the recording determines the amount of time you can select for time slip. As the recording progresses, the amount of time you can time slip also increases.

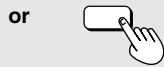
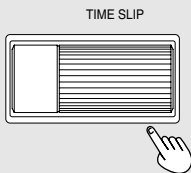

or

Current recording

Play images (30 seconds before)

A

①

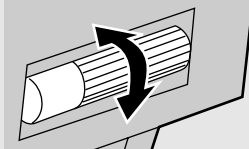

②

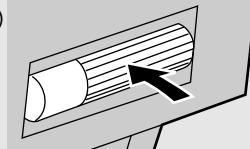

Using the top window

About the top window

Most of the features and functions of this unit can also be controlled with icons. The examples show the top window when a DVD-RAM is being used. Actual menus depend on the type of disc being used.

Cartridge protection

“ON” is displayed if the disc is protected with the write-protect tab (⇒ page 99).

Disc protection

“ON” is displayed if you have used Disc Protection in DISC SETTING to protect the disc (⇒ page 52).

Disc title

The disc’s title is displayed if one is recorded. You can enter titles with Enter Title in DISC SETTING (⇒ page 50).

Disc type

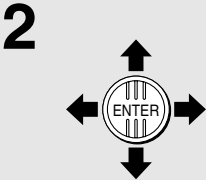
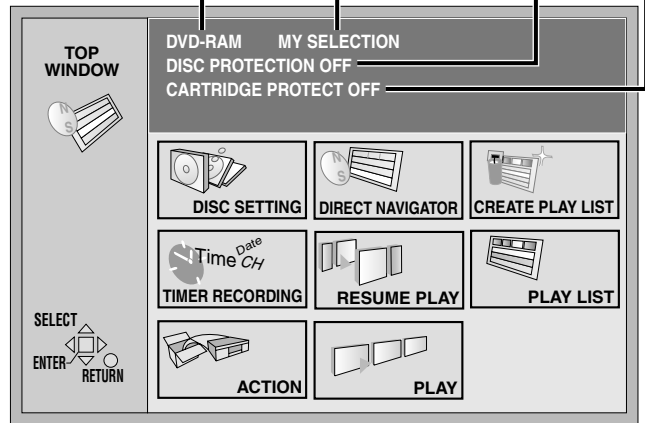
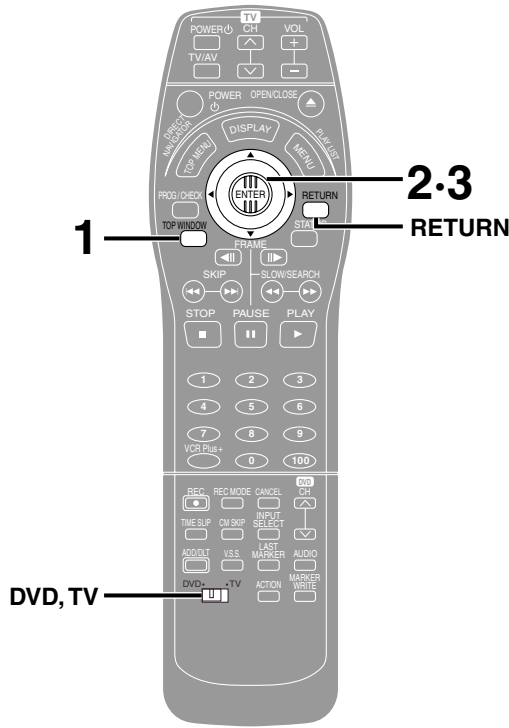

Using the top window

RAM DVD-R DVD-V CD VCD

Preparation

Switch [DVD, TV] to “DVD”.

- 1 While stopped**
Press [TOP WINDOW] to show the top window.

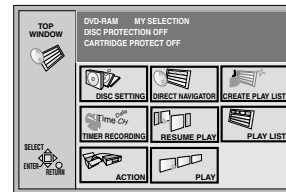









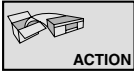

- 2 Use the joystick [▲, ▼, ◀, ▶] to select an item.**
Refer to the relevant pages for details.
- 3 Press [ENTER].**
Your selection is entered and the top window disappears. If the operation requires further selections, another screen appears.

■ To clear the top window

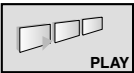
Press [TOP WINDOW] or [RETURN].

Top window icons

Features and functions described on other pages that can be controlled with the top window are indicated with .

Icon	Items	Discs	Pages
 DISC SETTING	Enter Title	RAM DVD-R	50
	Disc Protection	RAM	52, 53
	Format	RAM	54
	Finalize	DVD-R	55
 TIMER RECORDING	Registering programs and making corrections	RAM DVD-R	46
	Deleting a timer recording program	RAM DVD-R	47
	Checking the timer programming	RAM DVD-R	48
 ACTION	Settings for the unit and discs	RAM DVD-R DVD-V CD VCD Settings depend on the type of disc	85
 DIRECT NAVIGATOR	Play	RAM DVD-R	56
	Erase Program	RAM DVD-R	58
	Enter Title	RAM DVD-R	59
	Properties	RAM DVD-R	62
	Protection	RAM	60, 61
	Shorten Segment	RAM	63
 PLAY	Start play from the beginning of the disc	RAM DVD-R DVD-V CD VCD	22
 RESUME PLAY	Start play from the point you stopped play	RAM DVD-R DVD-V CD VCD	23
 CREATE PLAY LIST	Creating play lists	RAM	66
 PLAY LIST	Playing play lists	RAM	67
	Play Scenes	RAM	68
	Edit Scenes	RAM	68
	Copy Play List	RAM	72
	Erase Play List	RAM	72
	Enter Title	RAM	73
	Properties	RAM	74
 Example TOP MENU MENU	Display a disc's menus	DVD-V	23
 PROGRAM PLAY	Display the program play screen	CD VCD	38
 RANDOM PLAY	Display the random play screen	CD VCD	39

Some items will be greyed out and cannot be selected if the disc is write-protected. Release disc protection with DISC SETTING—Disc Protection (⇒ page 53) or release cartridge protection with the write-protect tab (⇒ page 99).

Convenient features

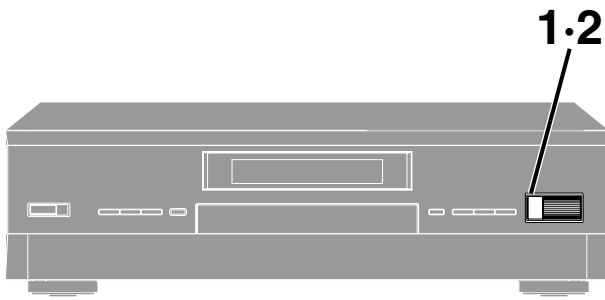

CM SKIP

DVD, TV

A Skipping a minute forward— CM skip

RAM DVD-R

Remote control only

Use this feature to skip past short parts of recordings, commercials, for example.

Preparation

Switch [DVD, TV] to “DVD”.

During play

Press [CM SKIP].

Play restarts from approximately a minute later.

Note

- If the start of the next program is within one minute of the point you skipped from, play restarts from that program.
- Since the length of each commercial will vary, this feature may not always skip each commercial accurately. It is designed as an easy way of skipping short periods of time.

B Selecting an amount of time to skip—Time Slip

RAM DVD-R

Main unit only

You can set an amount of time and then skip with one press of a button.

1 During play Turn [TIME SLIP] on the main unit.

- Turn down to increase in one-minute units.
- Turn up to decrease in one-minute units.

2 Within 5 seconds Press [TIME SLIP] on the main unit to enter the time.

Play skips the time you entered.

Note

You cannot use this feature while a direct navigator is being displayed (➔ page 56) or play list is played (➔ page 65).

A



B

1

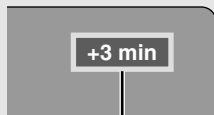
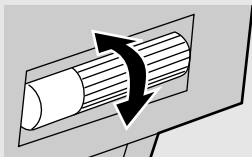

For example, when you want to skip forward 3 minutes

2

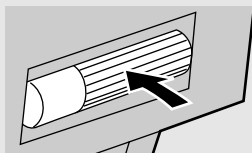

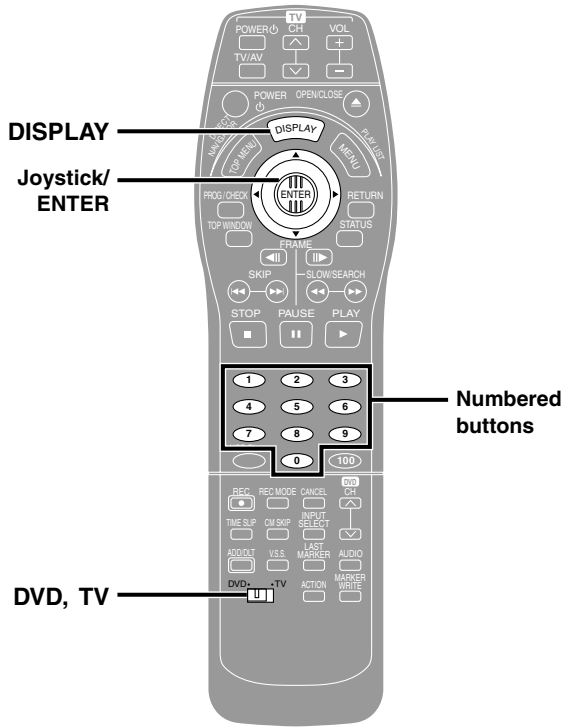

A Repeat play

RAM DVD-R DVD-V **CD** VCD

Preparation

- Switch [DVD, TV] to "DVD".
- Press [DISPLAY] ⇒ [DISPLAY] to display the on-screen menu icons and use the joystick [▶] to highlight the repeat play icon (⇒ pages 40 and 42).

During play

Use the joystick [▲, ▼].

Each time you use the joystick, the display changes as illustrated.

RAM DVD-R

Program (PRG) ↔ Entire disc (A) ↔ OFF

While playing a play list **RAM**

Play list (PL) ↔ OFF

DVD-V

Chapter (C) ↔ Title (T) ↔ OFF

CD VCD

Track (T) ↔ Entire disc (A) ↔ OFF

If the Video CD has playback control

- ① While stopped (the screen saver is on the television), press the numbered buttons to select a track (⇒ page 8).
- ② Do the above operation.



■ To repeat only your favorite tracks

CD VCD

- ① Program the tracks you want (⇒ page 38).
- ② Do the above operation.

Note

- Repeat play may not work as desired with some discs.
- Repeat play does not work if the disc's elapsed play time is not shown on the unit's display.
- You cannot use repeat play to repeat an entire DVD-Video.

B A-B repeat play

RAM DVD-R DVD-V

You can repeat a section between points A and B within a program, title or chapter.

Preparation

- Switch [DVD, TV] to "DVD".
- Press [DISPLAY] ⇒ [DISPLAY] to display the on-screen menu icons and use the joystick [▶] to highlight the A-B repeat icon (⇒ pages 40 and 42).

During play

Press [ENTER].

Each time you press the button, the display changes as illustrated. A-B repeat starts when you specify point B.

Note

- A-B repeat does not work if the DVD's elapsed play time is not shown on the unit's display.
- The unit automatically determines the end of a program/title as point B when the end of the program/title is reached.
- Some subtitles recorded around point A or B may fail to appear.
- This does not work while playing a play list.

A

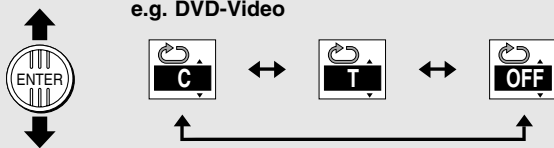

B

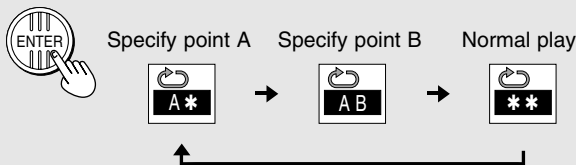



Changing audio

RAM DVD-V VCD

Remote control only

You can change the audio being received or played with the following procedure.

Preparation

Switch [DVD, TV] to "DVD".

During reception or play

Press [AUDIO] to select the audio type.

How the type changes depends on when you press the button.

■ While receiving Multi-channel Television Sound Stereo (MTS) **A**

Stereo → SAP → Mono

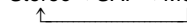

Stereo: To listen to the main audio (stereo)

- Select "Mono" if reception is poor during a stereo broadcast.

SAP: To listen to the secondary audio program.

Mono: To listen to a broadcast in monaural.

■ While playing a television program recorded on DVD-RAM **B**

If it is a recording of an MTS broadcast

MAIN ↔ SAP

If it is a recording of a stereo broadcast

LR → L → R

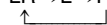

■ While playing a DVD-Video **C**

You can change the audio channel number each time you press the button. This allows you to change things like the soundtrack language.

■ While playing a Video CD **D**

LR → L → R

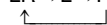

■ Audio during television reception

Television broadcast	Setting	Audio output		Audio recorded	
		L	R	L	R
Stereo +SAP	Stereo	L	R	L	R
	SAP	SAP	SAP	L+R	SAP
	Mono	L+R	L+R	L+R	L+R
Mono +SAP	Stereo	L+R	L+R	L+R	L+R
	Mono	L+R	L+R	L+R	L+R
Stereo	Stereo	L	R	L	R
	SAP	L	R	L	R
Mono	Mono	L+R	L+R	L+R	L+R
	Stereo	L+R	L+R	L+R	L+R
	SAP	L+R	L+R	L+R	L+R

L=Left audio channel

R=Right audio channel

L+R=Left+Right audio channel

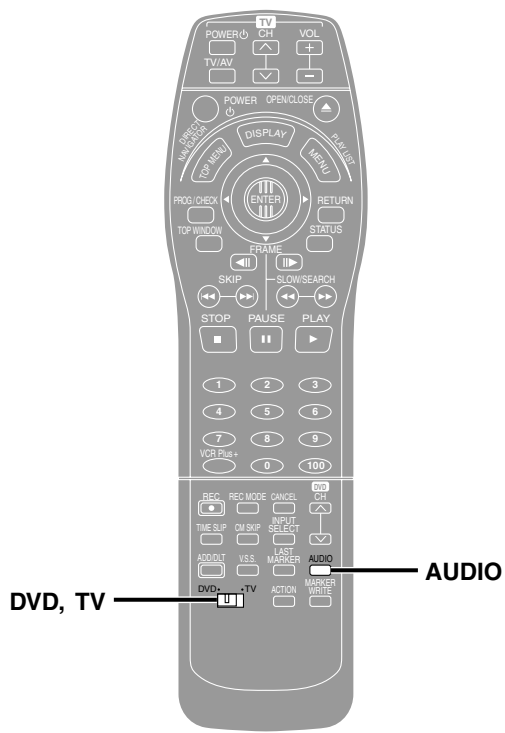

A

e.g.: "Stereo" is selected
 "((((" appears when the unit is receiving the type of audio you selected.

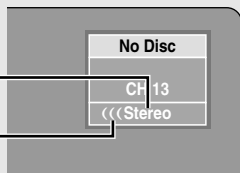

B

e.g.: "L R" is selected

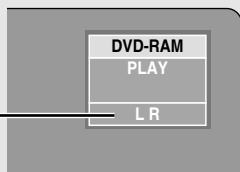

C

e.g.: English is the selected language

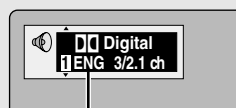

The language is switched to French

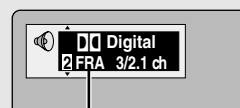

D

e.g.: "L R" is selected

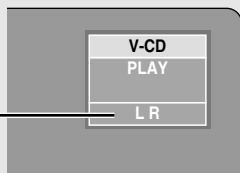

For your reference

- You can also use the on-screen menu icons to change the audio type.
- You can change the audio for the images being played with simultaneous rec and play and Time Slip.

■ When you have connected the unit to other equipment with an optical digital cable

You cannot change the audio type when you have used only an optical digital cable for connection in the following cases:

- While playing stereo broadcasts recorded on DVD-RAM.
- While playing MTS broadcasts recorded on DVD-RAM.
- While playing something recorded from other equipment.

To change the audio type

- Set “Dolby Digital” to “PCM” (➡ page 86).
- Or
- Connect to an amplifier with an audio/video cable and change the input on the amplifier to suit the connection.

When using DVD-R

You cannot use [AUDIO] or the on-screen menu icons to change audio type while playing or recording with DVD-R.

• While receiving SAP broadcasts

You can use the ACTION menus to select which audio type is recorded, either “Main” or “SAP”. “Main” is the default setting (➡ page 83, Audio—MTS Selection for DVD-R Disc).

• During play

The audio type selected for recording is played. This is displayed as “LR”.

■ Audio during television reception

Television broadcast	Setting	Audio output		Audio recorded	
		L	R	L	R
Stereo +SAP	Main	L	R	L	R
	SAP	SAP	SAP	SAP	SAP
Mono +SAP	Main	L+R	L+R	L+R	L+R
	SAP	SAP	SAP	SAP	SAP
Stereo	Main	L	R	L	R
	SAP	L	R	L	R
Mono	Main	L+R	L+R	L+R	L+R
	SAP	L+R	L+R	L+R	L+R

Marking places to play again— MARKER

RAM DVD-R DVD-V CD VCD

Remote control only

Preparation

Switch [DVD, TV] to "DVD".

A Marking places

RAM DVD-R

You can mark up to 999 points on a disc to return to later. These marks are recorded directly onto DVD-RAM and DVD-R and remain intact when the disc tray is opened. These marks are cleared when you finalized DVD-R.

DVD-V CD VCD

You can mark up to 5 points on a disc to return to later. All the markers are cleared when the disc tray is opened.

During play

Press [MARKER WRITE] at the point you want to mark.

B To play from a marked position

Preparation

Press [DISPLAY] ⇒ [DISPLAY] to display the on-screen menu icons and use the joystick [▶] to highlight the marker icon (⇒ pages 40 and 42).

1 Press [ENTER].

You are now ready to recall markers.

2 Use the joystick [◀, ▶] to select a marker number.

RAM DVD-R

C When selecting markers 11 and above

- ① Use the joystick [◀, ▶] to highlight the marker pin icon.
- ② Use the joystick [▲, ▼] to select "11-20".
You can select the next group of 10 when the current group is full.
- ③ Use the joystick [▶] and press [ENTER].
- ④ Use the joystick [◀, ▶] to select a marker number.

3 Press [ENTER].

Play starts from the marked position.

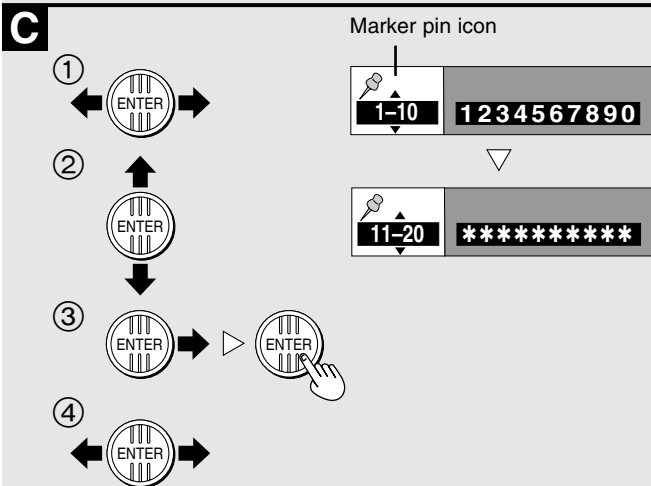
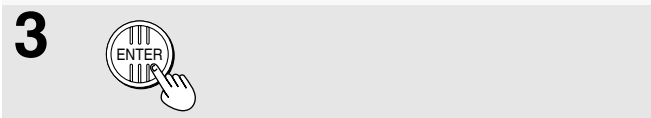
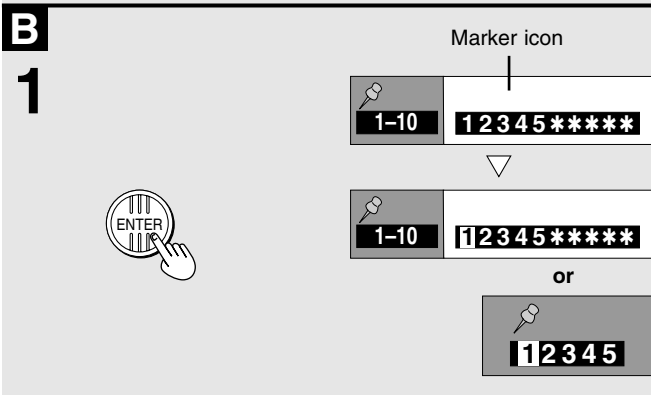
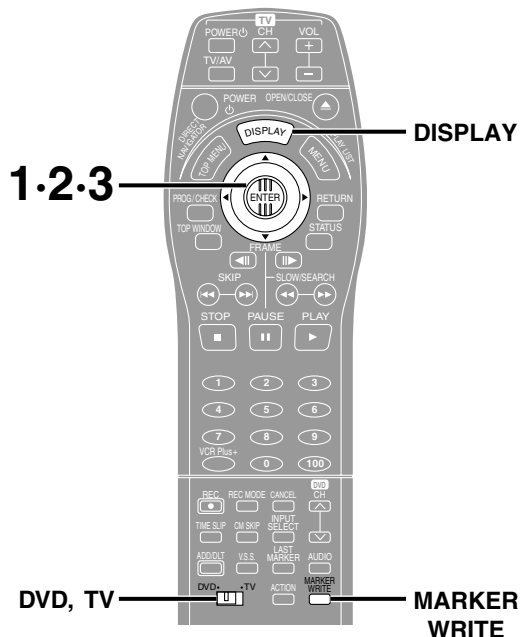

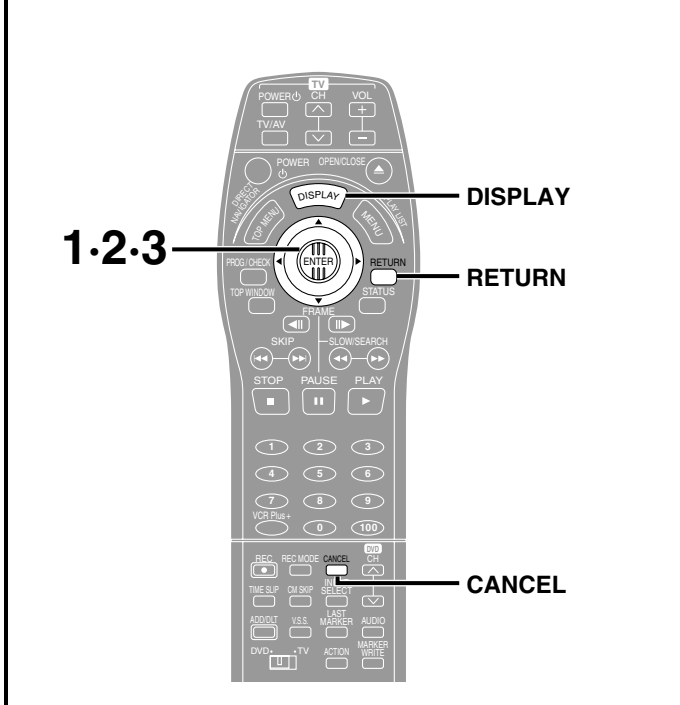

To mark points using the marker icon

Preparation

Press [DISPLAY] ⇒ [DISPLAY] to display the on-screen menu icons and use the joystick [▶] to highlight the marker icon (⇒ pages 40 and 42).

- 1 Press [ENTER].**
You are now ready to mark positions.
- 2 Use the joystick [◀, ▶] to select the next asterisk (*).**

RAM DVD-R

A When marking positions 11 and above

- ① Use the joystick [◀, ▶] to highlight the marker pin icon.
- ② Use the joystick [▲, ▼] to select "11-20".
You can select the next group of 10 when the current group is full.
- ③ Use the joystick [▶] and press [ENTER].
The first marker is selected.
- ④ Use the joystick [◀, ▶] to select an available asterisk (*).

- 3 Press [ENTER] at the point you want to mark.**

Repeat steps 2 and 3 to add other markers.

■ To clear a marker

Use the joystick [◀, ▶] to select a marker number and press [CANCEL].

■ To clear the on-screen icons

Press [RETURN] several times.

Note

- This feature only works if the elapsed playing time of the disc is shown on the unit's display.
- Some subtitles recorded around the marker may fail to appear.

RAM

- This feature doesn't work while using a play list.
- The markers are ordered by time. This means that the marker numbers can change when you add and erase markers.
- You cannot mark and clear points if you have write-protected the disc, either with DISC SETTING (⇒ page 52) or with the write-protect tab (⇒ page 99).

DVD-R

- The markers are ordered by time. This means that the marker numbers can change when you add and erase numbers.

1

Marker icon

1-10 1*****

or

1****

2

1-10 1*****

or

1****

3

A

Marker pin icon

- ①
- ②
- ③
- ④

1-10 1234567890

11-20 *****



Program play

CD VCD

You can select up to 100 tracks to play in the order you choose.

Preparation

Switch [DVD, TV] to "DVD".

- 1** While stopped
Press [TOP WINDOW].
- 2** Use the joystick [**▲**, **▼**, **◀**, **▶**] to select "PROGRAM PLAY" and press [ENTER].



- 3** Press the numbered buttons to select the track.

Example: "5": [0] → [5]
"15": [1] → [5]

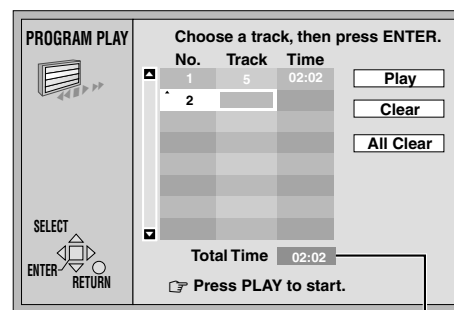

Total time of the program

Repeat step 3 to select other tracks.

• You can also use the joystick to select tracks.

- ① Press [ENTER], then use the joystick [**▲**, **▼**] to select the track.
- ② Press [ENTER].

- 4** Press [**▶**, PLAY].

Play starts in the programmed sequence.

■ To move to the page before or after the one shown

Press [**◀◀**, SLOW/SEARCH] or [**▶▶**, SLOW/SEARCH].

■ To clear the programmed tracks one by one

1. Use the joystick [**▲**, **▼**] to select the track you want to clear.
2. Press [CANCEL].

Alternatively, use the joystick [**▲**, **▼**, **◀**, **▶**] to select "Clear" and press [ENTER].

■ To clear the whole program

Use the joystick [**▲**, **▼**, **◀**, **▶**] to select "All Clear" and press [ENTER].

• The whole program is also cleared when you turn the unit off or open the disc tray.

■ To exit the program mode

1. Press [**■**, STOP] during play until the program play screen is displayed.
2. Press [TOP WINDOW] or [RETURN].

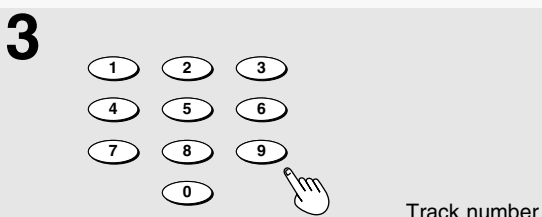
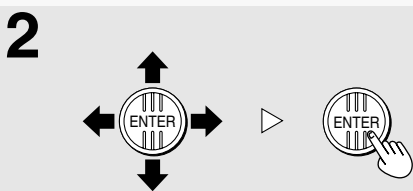
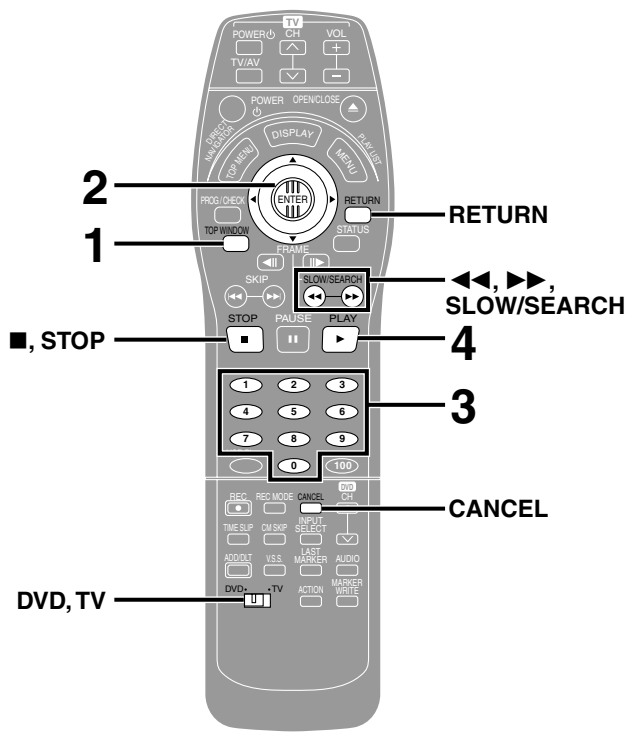

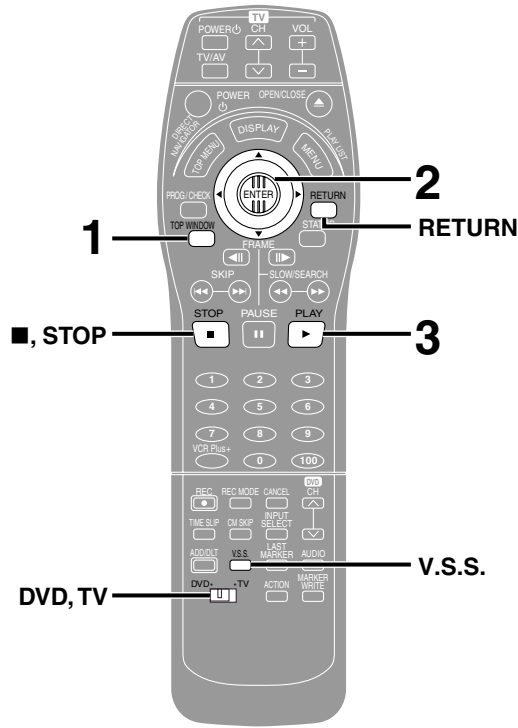

A Random play

CD VCD

The unit plays the tracks on a disc in random order.

Preparation
Switch [DVD, TV] to "DVD".

- 1** While stopped
Press [TOP WINDOW].
- 2** Use the joystick [▲, ▼, ◀, ▶] to select "RANDOM PLAY" and press [ENTER].



▽ When you press [ENTER]



- 3** Press [▶, PLAY].

■ To cancel random play

1. Press [■, STOP] until the random play screen appears.
2. Press [TOP WINDOW] or [RETURN].

B Enjoying virtual surround sound effects (V.S.S.)



RAM DVD-R DVD-V

(Only with Dolby Digital with 2 or more channels)

Remote control only

Enjoy a surround-like effect if you are using two front speakers only. The effect is broadened and sound seems to come from virtual speakers on either side if the disc has surround signals recorded on it.

Preparation

- Switch [DVD, TV] to "DVD".
- Turn off the surround effects on the other equipment.

During play

Press [V.S.S.].

The mode changes as illustrated each time you press the button.

Note

- V.S.S. will not work, or will have less effect, with some discs, even if you select "1" or "2".
- Turn V.S.S. off if it causes distortion.

A

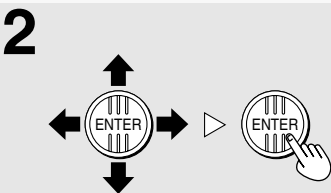

B

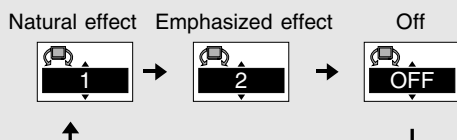

Using on-screen menu icons

RAM DVD-R DVD-V **CD** VCD

Remote control only

On-Screen Menu Icons are menus that contain information about the disc or unit. These menus allow you to perform operations by changing this information.

Common procedures

Preparation

Switch [DVD, TV] to "DVD".

1 Press [DISPLAY].

Each time you press the button:

- Icons for disc information (a)
- ↓
- Icons for unit information (b)
- ↓
- Original display (c)

2

Icons for unit information only

While the leftmost icon is highlighted

Use the joystick [▲, ▼] to select the menu.

Each time you move the joystick:

- Play menu (d)
- ↓ ↑
- Video menu (e)
- ↓ ↑
- Audio menu (f)

3

Use the joystick [◀, ▶] to select the item.

4

Use the joystick [▲, ▼] to select the setting.

- Press [ENTER] if the setting does not change after moving the joystick [▲, ▼].
- The numbered buttons can also be used (⇒ page 8) to change some items that use numbers (title and track numbers, for example).
- Some items require different operations. Read the explanations on the following pages.

■ To clear the icons

Press [RETURN] until the menus disappear.

■ To change the position of the icons

1. Use the joystick [◀, ▶] to select the rightmost icon. 
2. Use the joystick [▲, ▼] to move the icons. There are 5 positions to choose from.

For your reference

- The screens depend on the disc contents.
- Depending on the condition of the unit (playing, stopped, etc.) and disc contents, there are some items that you cannot select or change.

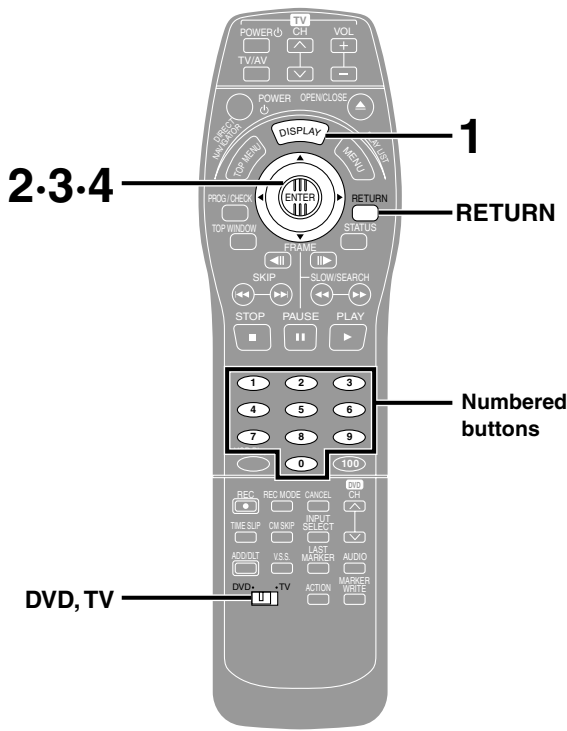

1

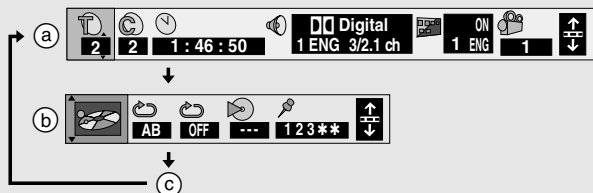

2

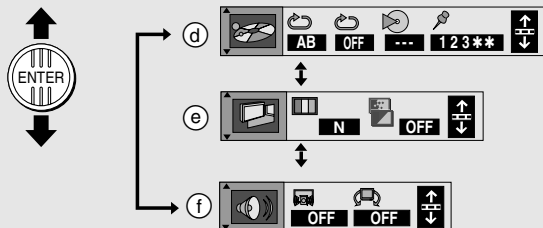

3



4



Icons for disc information

e.g. DVD-Video



Icon	Content
	Program number [RAM] [DVD-R] Select the number and press [ENTER].
	Play list number [RAM] Select the number and press [ENTER].
	Title number [DVD-V] Track number [CD] [VCD] Select the number and press [ENTER].
	Chapter number [DVD-V] Select the number and press [ENTER].
	Elapsed play time [RAM] [DVD-R] [DVD-V] Press the numbered buttons to select a time to play from. For example, to start play from 1 hour, 6 minutes and 37 seconds Press [1]-[0]-[6]-[3]-[7], then [ENTER].
	Time display [CD] [VCD] Use the joystick [▲, ▼] to change the information displayed. <div style="margin-left: 20px;"> → Track elapsed time ↓ ↑ Track remaining time ↓ ↑ → Disc remaining time </div>
	A Soundtrack language [DVD-V] (See A at right.) Change the number to select a soundtrack. B Audio attribute [RAM] [DVD-V] (See B at right.)
	Karaoke vocals, on and off (Karaoke [DVD-V] only) Solo: ON ↔ OFF Duet: OFF ↔ V1+V2 <div style="margin-left: 40px;"> ↓ ↑ V2 ↔ V1 </div>

Icon	Content
	Subtitle number [DVD-V] (See A below.) Change the number to select a subtitle language.
	Subtitles on/off [RAM] [DVD-V] Turn the subtitles on or off.
	Angle number [DVD-V] Change the number to select an angle.
	Audio channel [RAM] [VCD] Select the audio channel (→ page 34).
	Menu play [VCD] (with playback control only) Indicates whether menu play (playback control) is on or off. Cannot be changed here.

A Soundtrack/Subtitle language

ENG: English	SVE: Swedish	CHI: Chinese
FRA: French	NOR: Norwegian	KOR: Korean
DEU: German	DAN: Danish	MAL: Malay
ITA: Italian	POR: Portuguese	VIE: Vietnamese
ESP: Spanish	RUS: Russian	THA: Thai
NLD: Dutch	JPN: Japanese	*: Others

B Audio attributes

LPCM/[Digital]/DTS/MPEG: Signal type
 k (kHz): Sampling frequency
 b (bit): Number of bits
 ch (channel): Number of channels (→ page 96)

For your reference

- You can only select subtitles, soundtracks, and angles if they are recorded on the disc.
- Some discs allow changes to soundtracks, subtitles, and angles only by using the disc's menus.
- Soundtrack and subtitle languages can be set before play (→ page 82, ACTION—Disc—Audio and Subtitle).
- If the subtitles overlap closed captions recorded on discs, turn the subtitles off.

Icons for unit information

Play menu

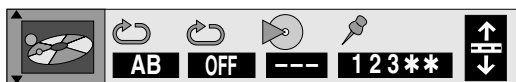

Icon	Content
	A-B repeat (⇒ page 33) RAM DVD-R DVD-V You can repeat a section between points A and B within a program, title or chapter.
	Repeat play (⇒ page 33) You can play a program, play list, chapter, title, or track repeatedly.
	Play mode CD VCD Cannot be changed here. ---: Normal play PGM: program play (⇒ page 38) RND: random play (⇒ page 39)
	Marker You can mark points on a disc to return to later (⇒ page 36).
	RAM DVD-R 1-10 11 DVD-V VCD CD 1 2 3 **

Audio menu



Icon	Content
	Dialog Enhancer DVD-V (Dolby Digital, 3-channel or over only, including a center channel) The volume of the center channel is raised to make dialog easier to hear. ON↔OFF
	V.S.S. (⇒ page 39) RAM DVD-R DVD-V Enjoy a surround-like effect if you are using two front speakers only. The effect is broadened and sound seems to come from virtual speakers on either side if the disc has surround signals recorded on it.

Video menu



Icon	Content
	Digital picture mode RAM DVD-R DVD-V VCD To select the picture mode during play: [▲, ▼] N: Normal mode C: Cinema mode (mellows movie, enhances detail in dark scenes.) U1/U2: User mode To change the user mode 1. Select User mode and move the joystick [▶]. 2. Use the joystick [▲, ▼] to select U1 or U2. 3. Use the joystick [◀, ▶] to select the item you want to change. 4. Use the joystick [▲, ▼] to change the setting.
	MPEG DNR RAM DVD-R DVD-V VCD (Displayed when the picture mode is N or C.) You can turn on and off the recommended settings for 3D NR, block NR, and mosquito NR. ON↔OFF

■ U1: Common picture adjustment

Icon	Content
	Contrast (-7 to +7) Increases the contrast between light and dark parts of the picture.
	Brightness (0 to +15) Brightens the picture.
	Color (-7 to +7) Adjusts the shade of the picture's color.
	Gamma (0 to +5) Increases the brightness of the center ranges to improve detail and contrast in dark scenes.

■ U2: Reducing picture noise

Icon	Content
	3D NR (0 to +4) Reduces overall noise.
	Block NR (0 to +3) Smooths block noise.
	Mosquito NR (0 to +3) Reduces the smudging that appears around contrasting sections of the picture.

Timer recording

Using VCR Plus+ codes to make timer recording

RAM DVD-R

Remote control only

Entering VCR Plus+ codes is an easy way of programming the timer for recording. You can find these codes in television sections of newspapers and in television guides. You can enter up to 16 programs up to a month in advance. Each daily or weekly program is counted as one program.

Preparation

- Switch [DVD, TV] to "DVD".
- Ensure that this unit's clock and guide channels (→ page 19) are set correctly.
- Insert a disc for recording (make sure there is enough room for the program you are going to record plus a little extra).

1 Press [VCR Plus+].

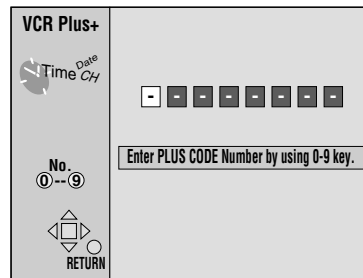

2 Press the numbered buttons to enter the VCR Plus+ code.

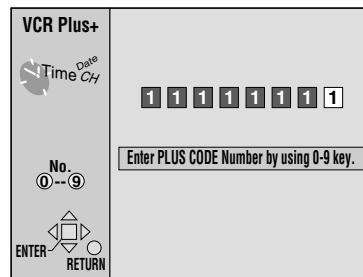

If you enter the wrong digit, use the joystick [◀] to move back and enter the correct digit.

(Continued on next page)

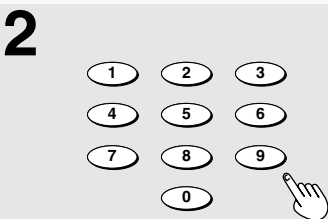
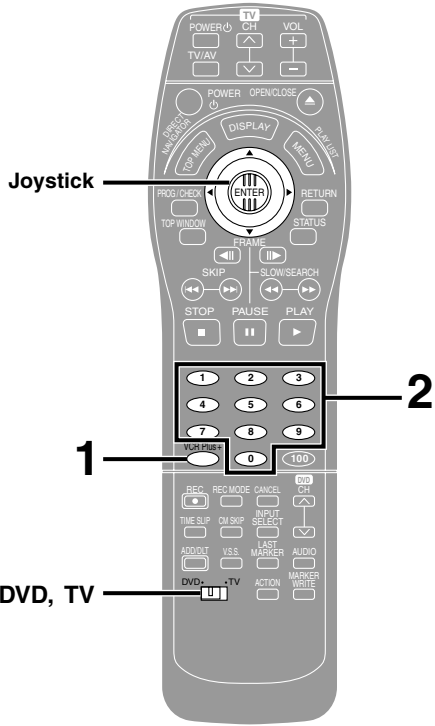

Advanced operations

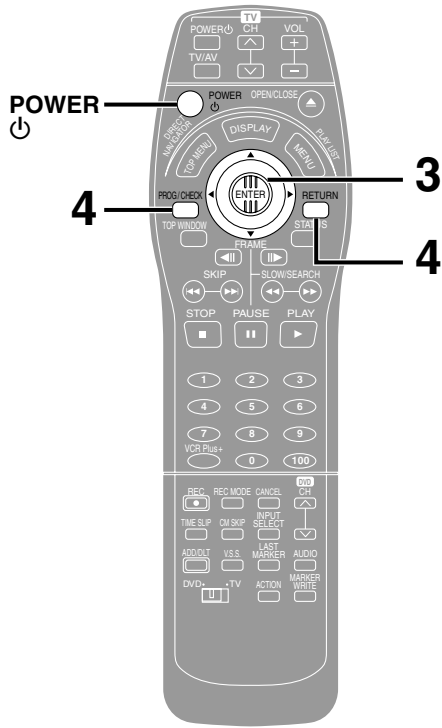

3



4

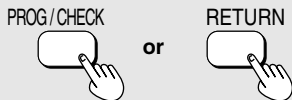

A

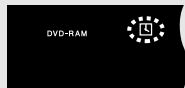

Timer recording

3 Press [ENTER].

The timer recording setting screen appears which allows you to confirm the program and make corrections if necessary.

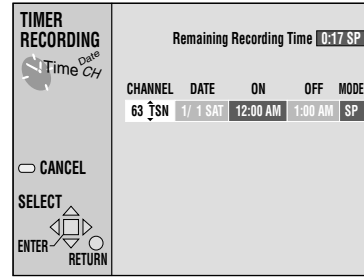

The current recording mode (shown on the unit's display) is automatically selected. To change the mode → page 45

▽ After 14 seconds or when you press [ENTER]

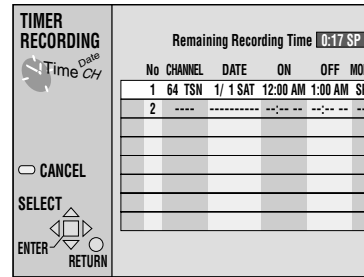

The timer recording list appears.

Repeat steps 1–3 to program other recordings.

4 Press [PROG/CHECK] or [RETURN].

The timer recording list disappears and the message "TURN RECORDER OFF FOR TIMER RECORDING" is shown on the television.

A To put the unit on timer recording standby



Press [POWER].

Ensure "TV" lights on the unit's display.

Note

If the disc is protected or full, the unit switches to standby but does not go for timer recording standby. Check the disc carefully.

Flexible recording mode (FR)

- The unit automatically selects a recording rate between "XP" and "EP" that will enable the recordings to fit in the available recording time on the disc with the best possible recording quality.
- You can use the mode only with timer recording.
- It may not be possible to record to the finish of the program if the remaining time doesn't allow.

Note

- The built-in clock employs 12-hour system.
- The actual time recorded may be longer than the program itself when television programs are recorded using VCR Plus+.
- "Invalid Entry" is displayed when you enter the wrong code. Reenter the code.
- "All timer programs are occupied." is displayed if there are already 16 items programmed. Clear unnecessary items (→ page 47).
- The remaining time displayed is calculated based on the current recording mode.
- Approximately 30 seconds at the beginning of subsequent programs is not recorded when you use timer recording to record multiple programs to a DVD-R.
- Recording is not possible unless you set "Disc Protection" in "DISC SETTING" to "Off" (→ page 53). **RAM**
- You can not record to a disc if the disc is protected with the write-protect tab. Release this before operation (→ page 99). **RAM**
- Timer recording may not work as set when summer time switches to winter time and vice versa (→ page 88).



To change the timer recording program

Timer recording setting screen (from step 3 on page 44)

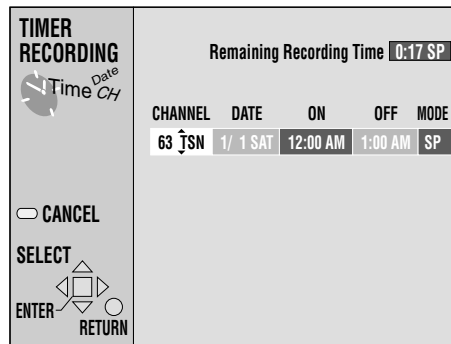

1.2.3

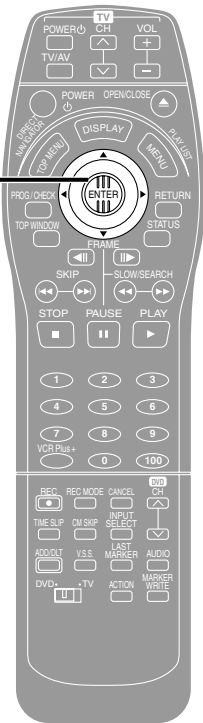

1



1 Use the joystick [◀, ▶] to select the item you want to change.

2



2 Use the joystick [▲, ▼] to change the setting.

The items change as follows:

- CHANNEL (Channel number and caption)

- DATE

Current date---→the day before one month later→
DAILY SUN-SAT→DAILY MON-SAT→DAILY MON-FRI→
WEEKLY SUN---→WEEKLY SAT

- ON (Start time)/OFF (Finish time)

The time increases or decreases in 30-minute increments if you hold the button.

- MODE (Recording mode)

SP→XP→FR→EP→LP

(SP, XP, EP and LP → page 26, FR → page 44)

3 Press [ENTER] when you have finished making changes.

The timer recording list appears.

3



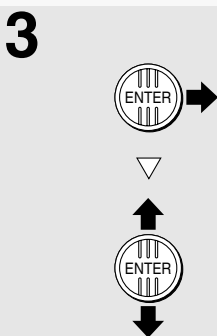
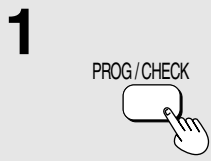
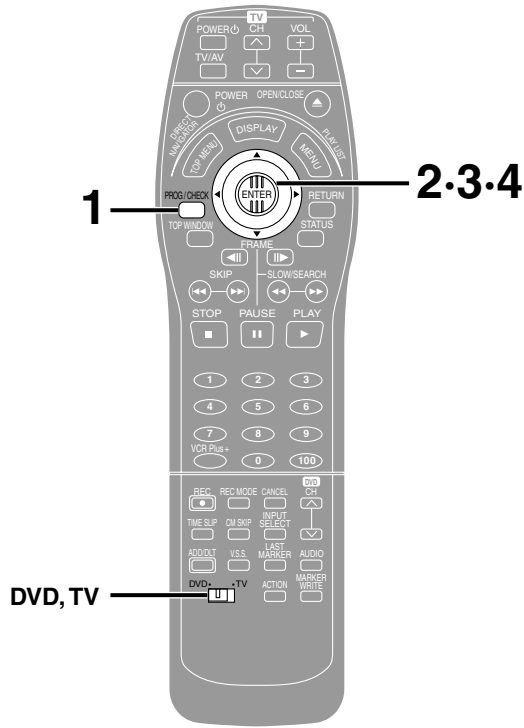

Timer recording

Manually programming the unit to make timer recording



RAM DVD-R

You can set your own programming conditions (up to 16 programs).

Preparation

- Switch [DVD, TV] to "DVD".
- Ensure that this unit's clock is set correctly.
- Insert a disc for recording (make sure there is enough room for the program you are going to record plus a little extra).

1 Press [PROG/CHECK].

The timer recording list appears.

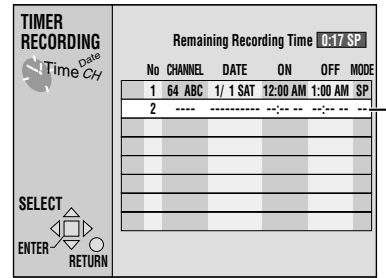

A line that is ready for programming is highlighted.

2 Press [ENTER].

The timer recording setting screen appears.

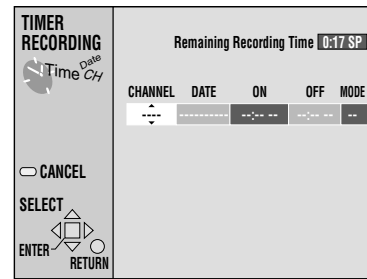

3 Use the joystick [▶] to move through the items and change the items with the joystick [▲, ▼].

• The current settings are shown each time you press [▶].

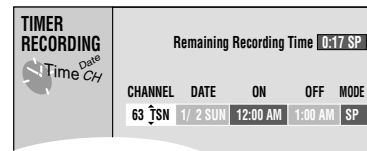

• **CHANNEL** (Channel number and caption)

• **DATE**
 Current date---→the day before one month later→
 DAILY SUN-SAT→DAILY MON-SAT→DAILY MON-FRI→
 WEEKLY SUN---→WEEKLY SAT

• **ON (Start time)/OFF (Finish time)**
 The time increases or decreases in 30-minute increments if you hold the button.

• **MODE (Recording mode)**
 SP→XP→FR→EP→LP
 (SP, XP, EP and LP → page 26, FR → page 47)

4 Press [ENTER] when you have finished programming the timer.

The timer recording list reappears.

Timer recording

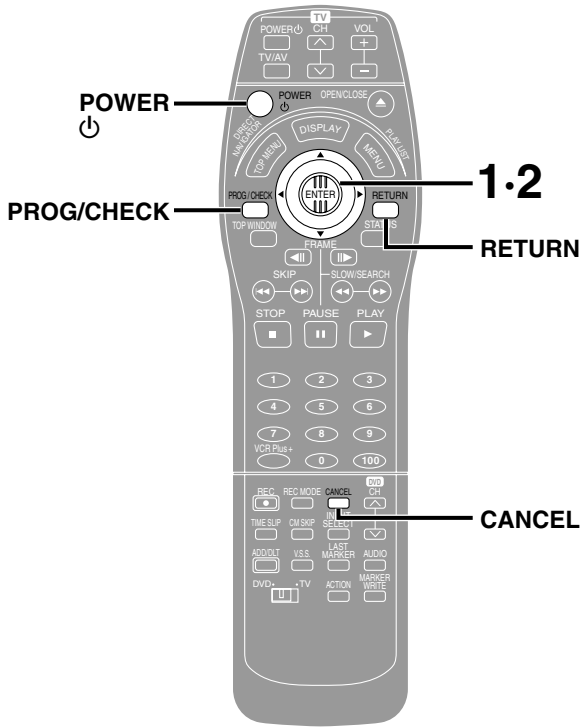

To continue programming

After selecting an available line, repeat steps 2, 3, and 4 on page 46.

To end programming

Press [PROG/CHECK] or [RETURN]. The timer recording list disappears and the message "TURN RECORDER OFF FOR TIMER RECORDING" is shown on the television.

A To put the unit on timer recording standby



Press [POWER].

Ensure "TV" lights on the unit's display.

Note

If the disc is protected or full, the unit switches to standby but does not go for timer recording standby. Check the disc carefully.

Flexible recording mode (FR)

- The unit automatically selects a recording rate between "XP" and "EP" that will enable the timer recording to fit in the available recording time on the disc with the best possible recording quality.
- You can use the mode only with timer recording.
- It may not be possible to record to the finish of the program if the remaining time doesn't allow.

Note

- The built-in clock employs 12-hour system.
- The remaining time displayed is calculated based on the current recording mode.
- Approximately 30 seconds at the beginning of subsequent programs is not recorded when you used timer recording to record multiple programs to a DVD-R.
- Recording is not possible unless you set "Disc Protection" in "DISC SETTING" to "Off" (⇒ page 53). **RAM**
- You can not record to a disc if the disc is protected with the write-protect tab. Release this before operation (⇒ page 99). **RAM**
- Timer recording may not work as set when summer time switches to winter time and vice versa (⇒ page 88).

B To change the timer recording program



TIMER RECORDING		Remaining Recording Time 0:17 SP			
No	CHANNEL	DATE	ON	OFF	MODE
1	64 ABC	1/ 1 SAT	12:00 AM	1:00 AM	SP
2	64 ABC	1/ 2 SUN	12:00 AM	1:00 AM	SP
3	64 ABC	1/ 3 MON	12:00 AM	1:00 AM	SP
4	----	-----	-----	-----	---

- While the timer recording list is being shown Use the joystick [▲, ▼] to select the program you want to change, and press [ENTER].

The timer recording setting screen is shown.

- Move through the items with the joystick [▶] and change the settings with the joystick [▲, ▼] and press [ENTER].

C To delete a timer recording program



TIMER RECORDING		Remaining Recording Time 0:17 SP			
No	CHANNEL	DATE	ON	OFF	MODE
1	64 ABC	1/ 1 SAT	12:00 AM	1:00 AM	SP
2	64 ABC	1/ 2 SUN	12:00 AM	1:00 AM	SP
3	64 ABC	1/ 3 MON	12:00 AM	1:00 AM	SP
4	----	-----	-----	-----	---

- While the timer recording list is being shown Use the joystick [▲, ▼] to select the program you want to clear and press [CANCEL].

Note

You cannot delete programs that are currently recording.

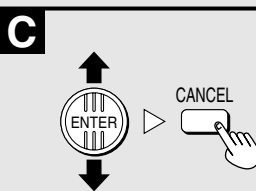
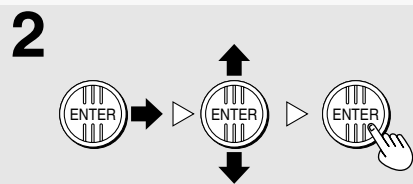
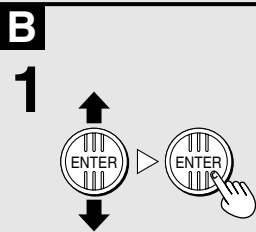
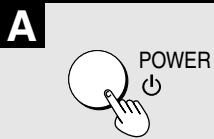

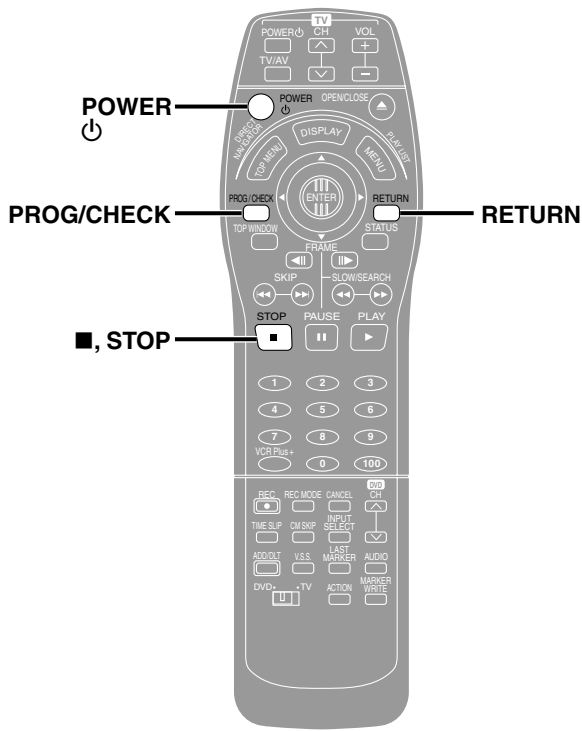

A



B

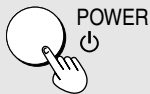

C

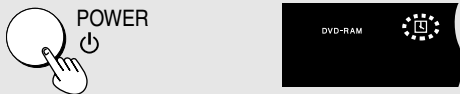

D



Timer recording



A To check programs

Press **[PROG/CHECK]**.

The timer recording list appears.

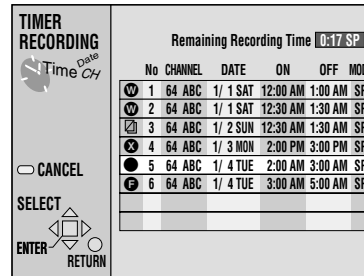

Icon explanations

- The times overlap those in another program.
- This program is currently recording.
- The disc was full or the maximum number of programs or scenes was reached so the program failed to record.
- The material was copy-guarded so the material failed to record.
- The program failed to record for some other reason.

■ To change the program

→ page 47

■ To exit the timer recording list

Press **[PROG/CHECK]** or **[RETURN]**. (The television is shown.)

For your reference

Programs that failed to record are displayed gray. These programs are deleted from the list at 4 a.m. the day after tomorrow.

Releasing the unit from timer standby

■ To release the unit from recording standby **B**

If you want to record something else before the program start time, for example:

Press **[⏻, POWER]**.

The unit turns on and "□" goes on.

- Be sure to press **[⏻, POWER]** before the program start time to put the unit on timer recording standby. The program only works if "□" is on.

■ To put the unit on timer recording standby **C**

Press **[⏻, POWER]**.

The unit turns off and "□" lights on the unit's display.

Note

"□" flashes when the unit couldn't go to timer recording standby (e.g., a disc isn't loaded, a disc that can't be recorded to is loaded, or the disc is protected). Check the disc carefully.

■ To stop recording while a program is working **D**

Press **[⏻, POWER]**, then **[■, STOP]** within **5 seconds**.

Recording stops. Recording standby is also canceled if there are other timer recording programs, so be sure to press **[⏻, POWER]** to put the unit on timer recording standby.

Recording from a video cassette recorder

RAM DVD-R

You can record audio and video being played on a video cassette recorder or video camera connected to the input terminals.

Preparation

- Connect the other equipment to this unit's input terminals (→ page 79).
- Switch [DVD, TV] to "DVD".
- Insert a disc that can be recorded on.
- Select the recording mode, XP, SP, LP, or EP (→ page 26).

1 While stopped
Press [INPUT SELECT] to select the input channel for the equipment you have connected.

Select L1, L2, or L3.

2 Start play on the other equipment.

3 Press [●, REC] at the point you want to start recording.

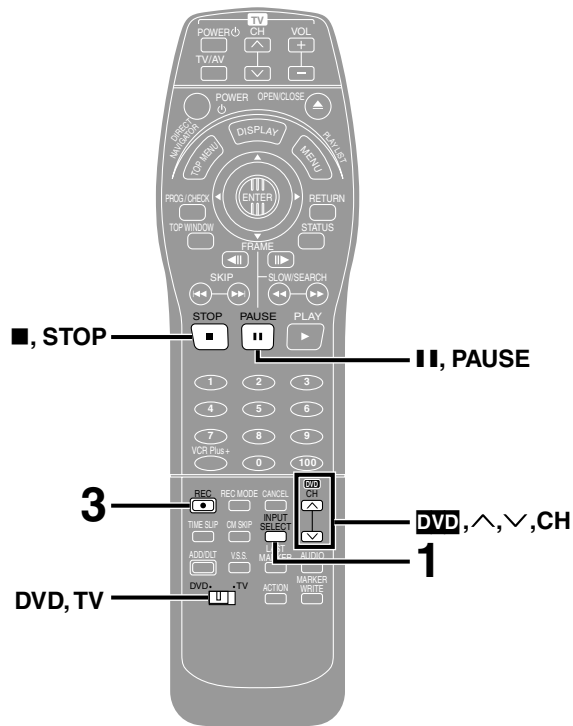

1
INPUT SELECT

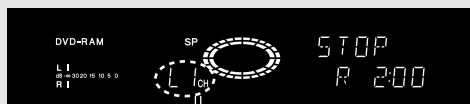

When you have selected "L1"

3
REC

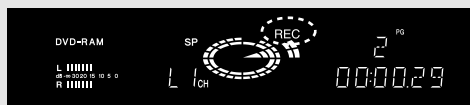

To skip unwanted parts

Press [II, PAUSE] to pause recording.

Press again to restart recording.

To stop recording

Press [■, STOP].

Stop play on the other equipment as well.

For your reference

- You can also select the input channel by pressing [DVD, ^, v, CH] in step 1.
- This unit complies with industry standards regarding the recording and duplication of copy-protected material. This includes commercial videotapes and DVDs. Apart from infringing copyright laws, copies of protected material are often of very poor quality.

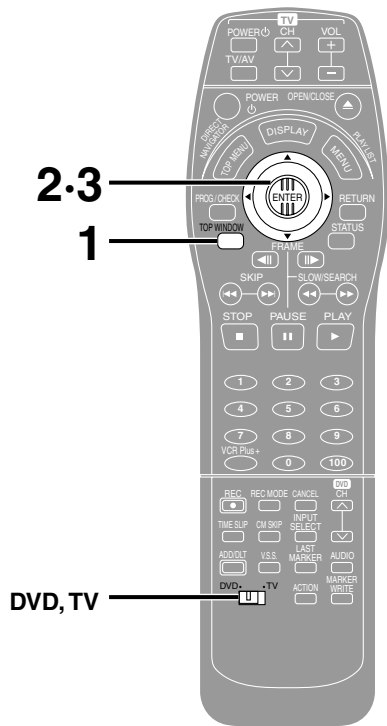

1



2

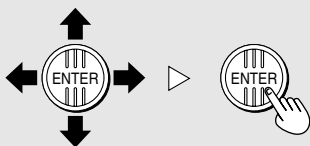

3

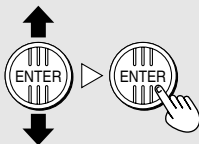

Disc setting

About DISC SETTING

RAM DVD-R

- You can give discs titles—Enter Title
- You can write-protect and write-enable DVD-RAM—Disc Protection
- You can format DVD-RAM—Format
- You can finalize DVD-R—Finalize

Enter Title



RAM DVD-R

Preparation

- Switch [DVD, TV] to “DVD”.
- Insert a disc you have recorded on.

- 1 While stopped
Press [TOP WINDOW].
- 2 Use the joystick [▲, ▼, ◀, ▶] to select “DISC SETTING” and press [ENTER].
- 3 Use the joystick [▲, ▼] to select “Enter Title” and press [ENTER].



- 3 Use the joystick [▲, ▼] to select “Enter Title” and press [ENTER].

e.g. DVD-RAM

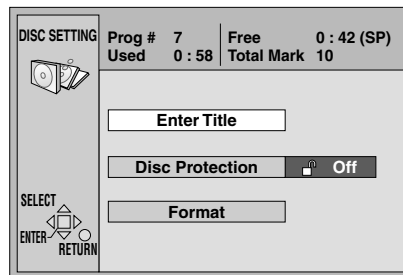

- 4 Enter the title (⇒ page 51).

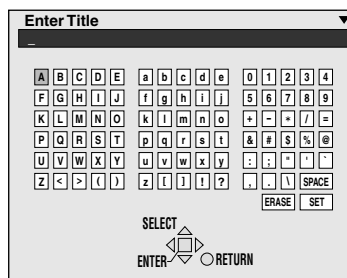

Note

- You can give DVD-RAM titles of up to 64 characters and DVD-R titles of up to 40 characters.
- You cannot give DVD-R titles once they have been finalized.
- You cannot enter titles if the disc is protected with the write-protect tab (⇒ page 99).
- You cannot enter titles if the disc is protected with DISC SETTING (⇒ page 52).

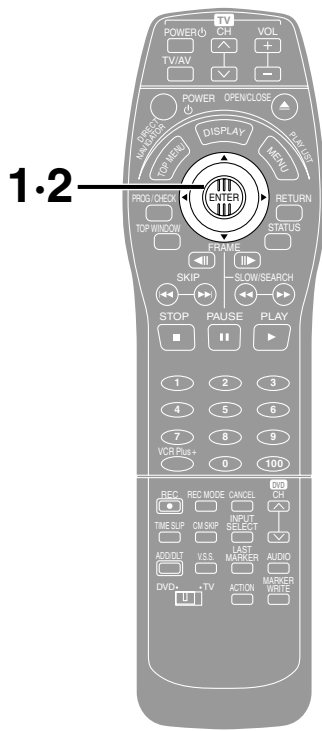

1.2

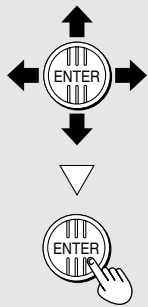

Entering characters for titles

RAM DVD-R

- 1** After the titling screen appears
Use the joystick [▲, ▼, ◀, ▶] to select the character you want to enter and press [ENTER].

You can enter the following characters.

Title field: shows the text you have entered

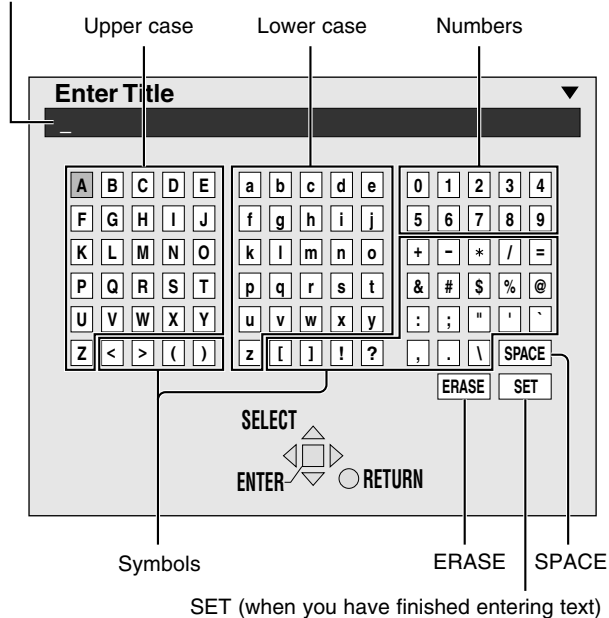

Repeat step 1 to enter other characters.

- 2** Use the joystick [▲, ▼, ◀, ▶] to select "SET" and press [ENTER].

The title is entered and the screen disappears.

■ To correct a character

- ① Use the joystick [▲, ▼, ◀, ▶] to select the character you want to correct in the title field.
- ② Use the joystick [▲, ▼] to move outside the title field.
- ③ Use the joystick [▲, ▼, ◀, ▶] to select "ERASE" and press [ENTER].
- ④ Use the joystick [▲, ▼, ◀, ▶] to select the correct character and press [ENTER].

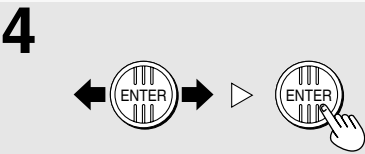
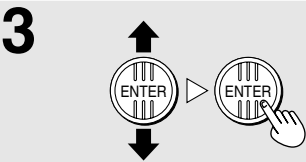
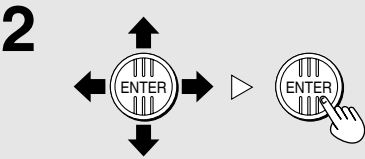
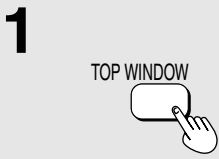
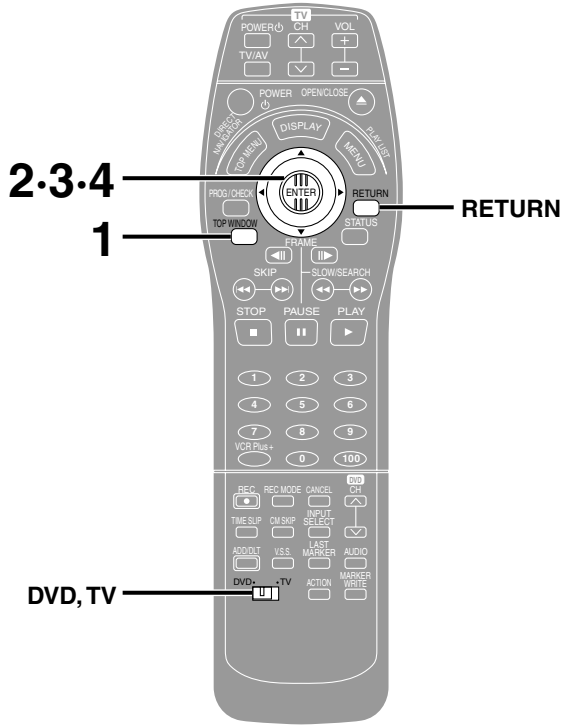

Disc setting



Disc Protection

RAM

This allows you protect discs from accidental erasure.

Preparation

- Switch [DVD, TV] to “DVD”.
- Insert the disc you want to protect.

1 While stopped
Press [TOP WINDOW].

2 Use the joystick [▲, ▼, ◀, ▶] to select “DISC SETTING” and press [ENTER].



3 Use the joystick [▲, ▼] to select “Disc Protection” and press [ENTER].

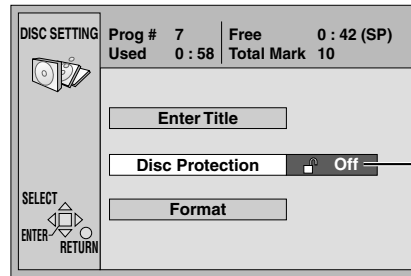

Disc protection is Off.

4 Use the joystick [◀, ▶] to select “Yes” and press [ENTER].



▽ When you press [ENTER]

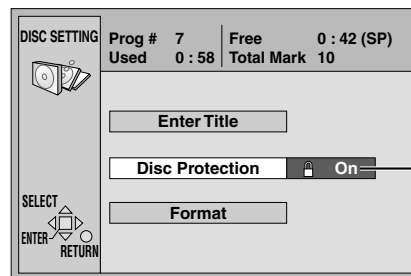

Disc protection is On.

■ To stop partway through

In step 4, either select “No” and press [ENTER] or press [RETURN].

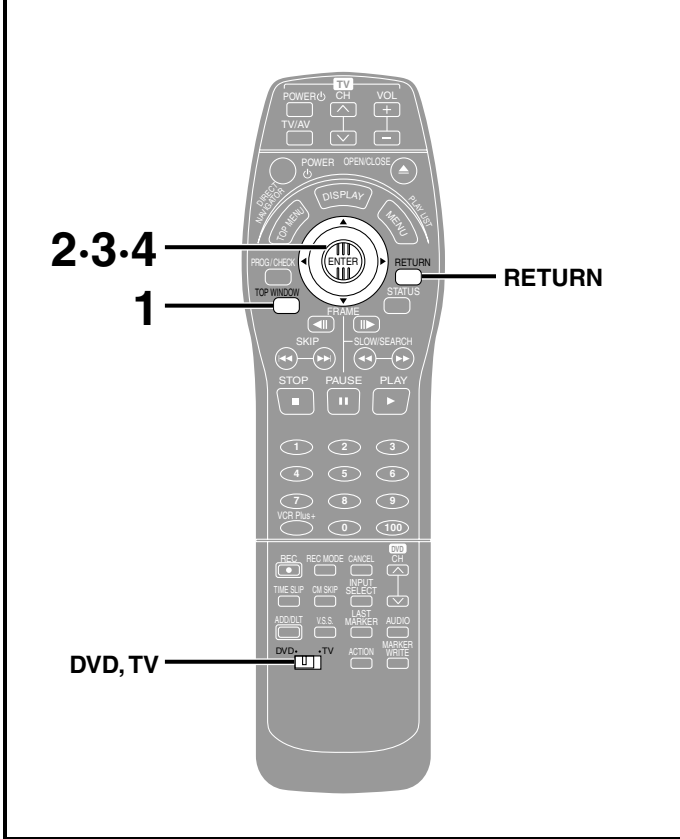

Disc setting

Releasing disc protection



RAM

Preparation

- Switch [DVD, TV] to “DVD”.
- Insert the disc you want to release protection.

- 1** While stopped
Press [TOP WINDOW].
- 2** Use the joystick [▲, ▼, ◀, ▶] to select “DISC SETTING” and press [ENTER].
- 3** Use the joystick [▲, ▼] to select “Disc Protection” and press [ENTER].

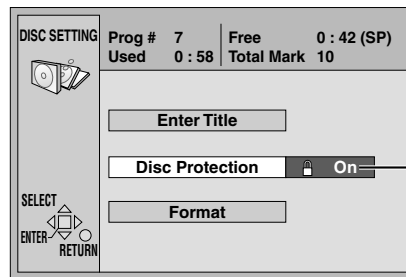

- 4** Use the joystick [◀, ▶] to select “Yes” and press [ENTER].

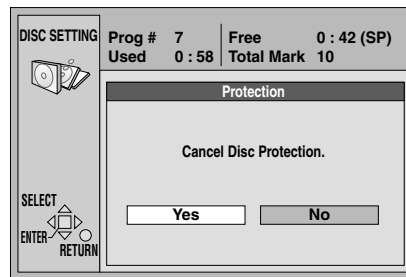

▽ When you press [ENTER]

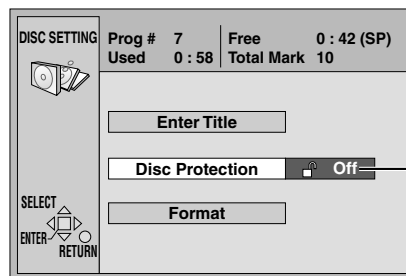

■ To stop partway through

In step 4, either select “No” and press [ENTER] or press [RETURN].

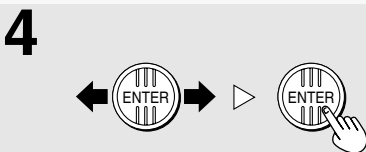
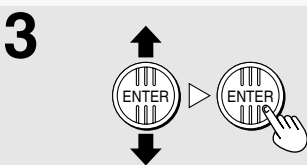
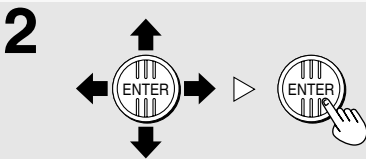
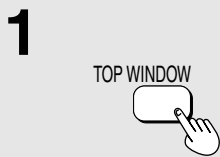

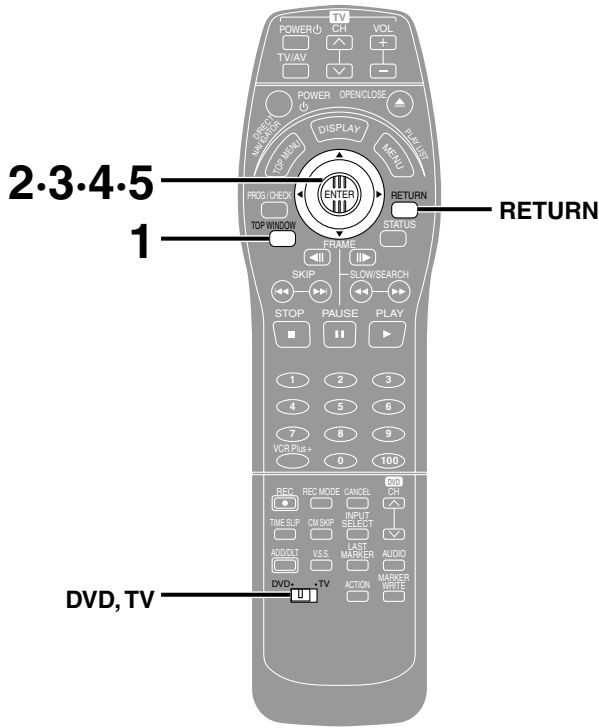

1



2

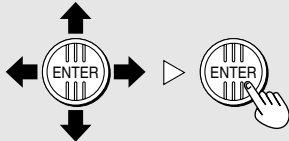

3

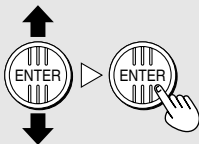

4-5

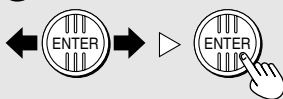

Disc setting

Format



RAM

Some DVD-RAM are unformatted. You must format these discs before you can use them in this unit. Formatting also allows you to erase the entire contents of a disc.

All recordings are irretrievably erased when a disc is formatted. Check the disc carefully before formatting to ensure it doesn't contain any programs you want to keep.

Preparation

- Switch [DVD, TV] to "DVD".
- Insert the disc you want to format.

- 1 While stopped
Press [TOP WINDOW].
- 2 Use the joystick [▲, ▼, ◀, ▶] to select "DISC SETTING" and press [ENTER].



- 3 Use the joystick [▲, ▼] to select "Format" and press [ENTER].

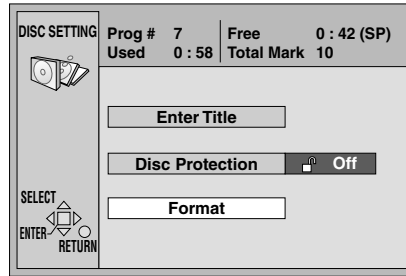

- 4 Use the joystick [◀, ▶] to select "Yes" and press [ENTER].

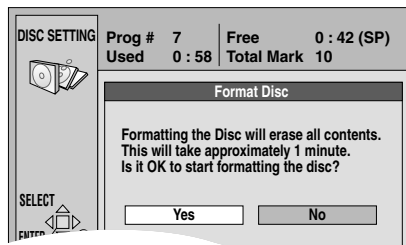

- 5 Use the joystick [◀, ▶] to select "Start" and press [ENTER].

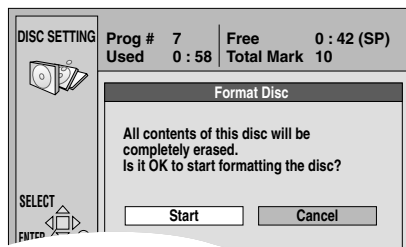

Formatting starts.
The message "Formatting is completed" appears when formatting is finished.

■ To stop formatting

Press [RETURN] in steps 4 and 5, or select "No" in step 4, "Cancel" in step 5 and press [ENTER].

Note

- Do not turn the unit off or disconnect the AC power supply cord while the message "Formatting the disc" is on the television. This can render the disc unusable. (Formatting takes up to 70 minutes. You can cancel formatting if it takes more than 2 minutes by pressing [RETURN]. The disc must be reformatted if you do this.)
- All data on the disc is erased when it is formatted, including recordings made with this unit. Data written to the disc by a computer is also erased.

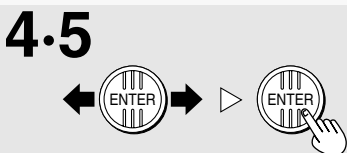
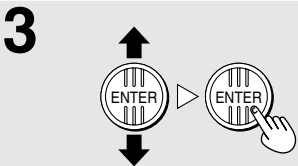
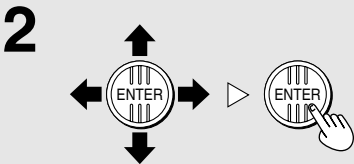
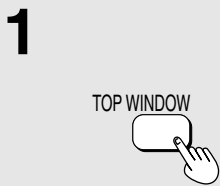
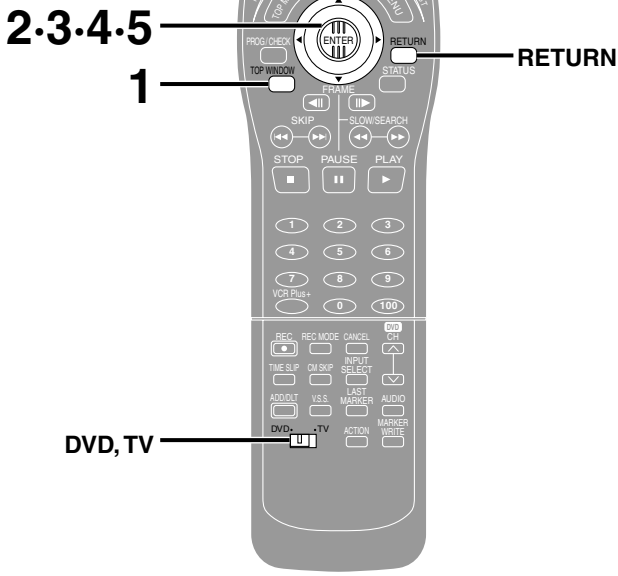

Disc setting

For your reference

- The disc cannot be formatted if the disc is protected with the write-protect tab. Release the protection to continue (➡ page 99).
- Formatting cannot be performed on DVD-R or CD-R/RW.
- The message “Unable to format” appears when you try to format discs this unit cannot use.
- If you have used the direct navigator to protect a program or DISC SETTING to protect the disc, the message “Contents on the disc have been protected. Is it OK to start formatting the disc?” appears in step 5. Select “Start” if you want to format the disc. The contents will be erased even if they have been protected.

Finalize—Creating DVD-Video

DVD-R

You can play DVD-R on compatible DVD players by finalizing them on this unit, effectively making them into DVD-Video. The titles you entered with this unit appear as menus when you play the finalized disc.

Preparation

- Switch [DVD, TV] to “DVD”.
- Insert the disc you want to finalize.

- 1 While stopped**
Press [TOP WINDOW].
- 2** Use the joystick [▲, ▼, ◀, ▶] to select “DISC SETTING” and press [ENTER].



- 3** Use the joystick [▲, ▼] to select “Finalize” and press [ENTER].

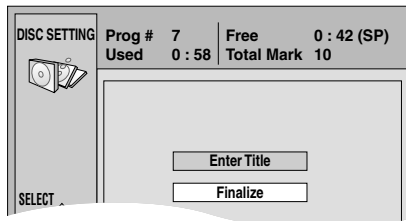

- 4** Use the joystick [◀, ▶] to select “Yes” and press [ENTER].

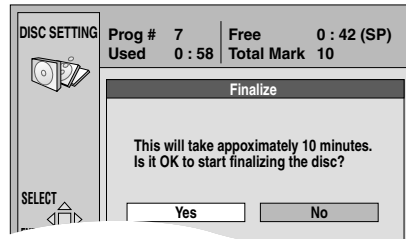

- 5** Use the joystick [◀, ▶] to select “Start” and press [ENTER].

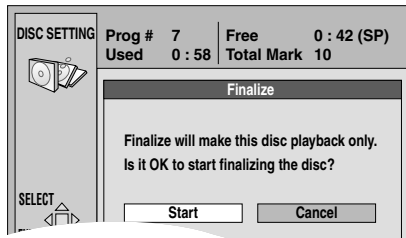

Finalizing starts.

The message “Finalizing is finished” appears when finalizing is finished.

■ To stop finalizing

Press [RETURN] in steps 4 and 5, or select “No” in step 4, “Cancel” in step 5 and press [ENTER].

Note

Do not turn the unit off or disconnect the AC power supply cord while the message “Finalizing” is on the television.

This will render the disc unusable.

- You can only finalize DVD-R that were recorded on this unit.
- You cannot record on DVD-R that have been finalized.
- The markers you entered (➡ page 36) will be lost.
- Finalizing takes up to 15 minutes.



Selecting programs to play

RAM DVD-R

A list of programs is created as you record them. You can use this list to find the programs you want to watch.

Preparation

- Switch [DVD, TV] to "DVD".
- Insert a disc you have recorded on.

- 1 While stopped**
Press [TOP WINDOW].
- 2 Use the joystick [▲, ▼, ◀, ▶] to select "DIRECT NAVIGATOR" and press [ENTER].**



The program list appears.

The images for the currently highlighted list are played in the background.

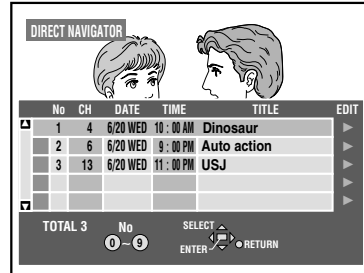

- 3 Use the joystick [▲, ▼] to select the program you want to watch and press [ENTER] or [▶, PLAY].**

Play of the images that were playing in the background continues.

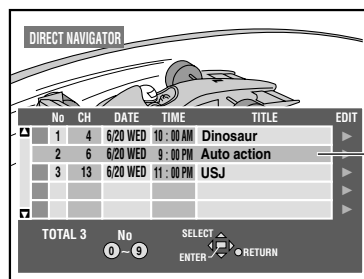

For example, when you select program number 2.

- Use the joystick [▼] to show program six and later.

To clear the program list

Press [TOP MENU, DIRECT NAVIGATOR].

For your reference

A You can also display the program list by pressing [TOP MENU, DIRECT NAVIGATOR] in step 1.

- The direct navigator works while recording (DVD-RAM), stopped or playing.
- You can also select programs from the list in step 3 by entering a 2-digit number with the numbered buttons (→ page 8) and pressing [ENTER].
If you enter a number larger than the total number of programs, the last program is selected.
- Titles are only displayed if you have given the program a title.

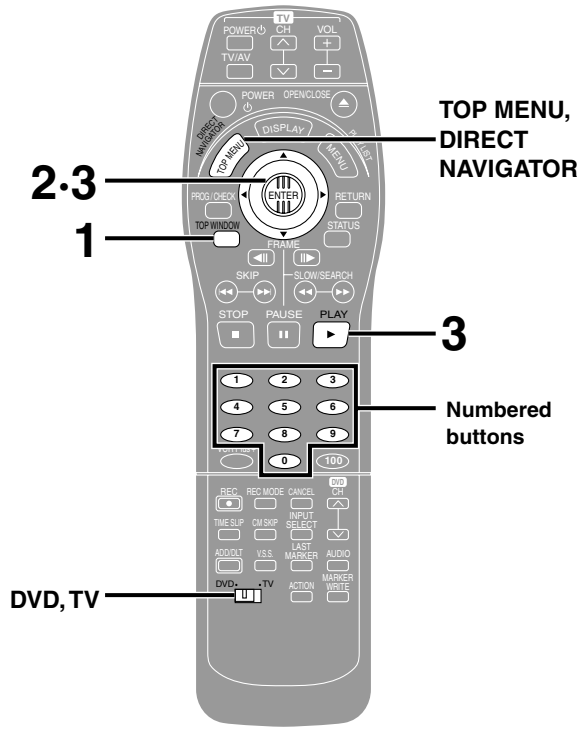

2-3
1

TOP MENU,
DIRECT
NAVIGATOR

3

Numbered
buttons

DVD, TV

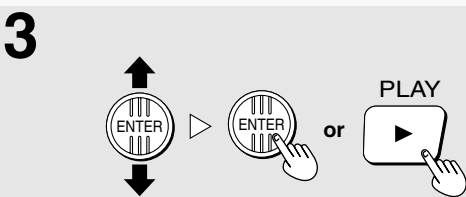
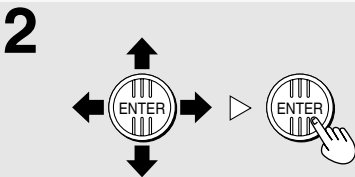
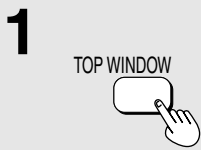

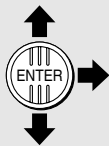
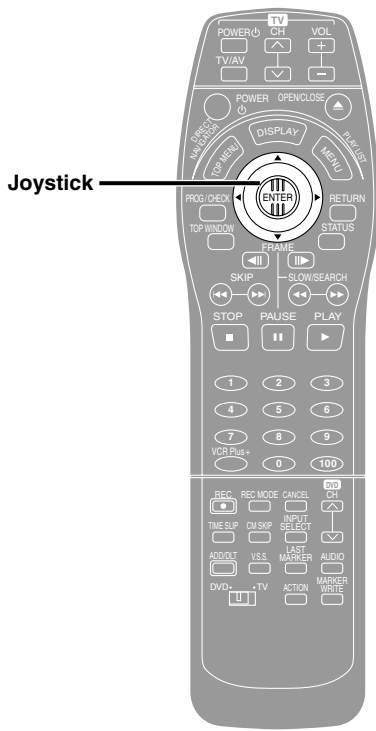

About the program list

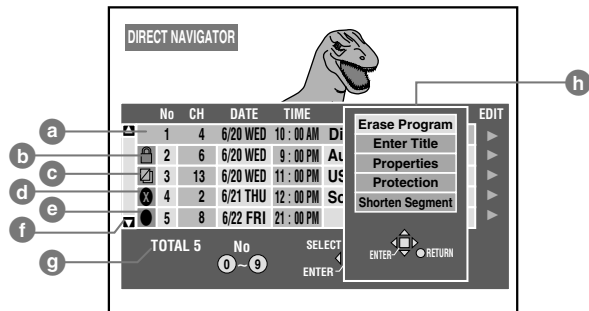

- a** **Program number, channel number (or caption), recording date, time recording started, program title (if entered).**
Program 1 is selected in the example.
- b** **Write-protected**
Displayed when you have protected the program. Program 2 has been protected in the example.
- c** **Copy-protected**
Displayed when you have recorded a program that has copy protection, from CATV broadcasts, for example.
- d** **Unable to play**
Displayed if you cannot play the program.
- e** **Currently recording**
Displayed when the program is being recorded.
- f** **Scroll bar**
If there are more than six programs, you can move down the list by using the joystick [**▲**, **▼**] and this bar shows your approximate position in the list.
- g** **Total number of programs**
Shows the total number of programs.
- h** **Submenu**
Displayed when you use the joystick [**▶**]. (You can see this during simultaneous rec and play but you are unable to perform operations.)
 - Erase a program (⇒ page 58).
 - Enter or edit a title (⇒ page 59).
 - Check a program's contents (⇒ page 62).
 - Write-protect a program (⇒ page 60).
 - Erase part of a program (⇒ page 63).

For your reference

- The list can show up to 99 programs that you have recorded or programmed to record.
- The message “**Maximum amount of programs are exceeded, cannot record**” is displayed if you try to start recording when there are already 99 programs on a disc. Erase unneeded programs (DVD-RAM only) or use a new disc to continue recording.
- When using DVD-R, “Protection” and “Shorten Segment” are not displayed in the submenu.
- The contents of the list are recorded on the disc.



Erasing programs

RAM DVD-R

The program is erased completely when you use this procedure and cannot be retrieved. Check the program carefully before erasing it to ensure it isn't one you want to keep.

Preparation

- Switch [DVD, TV] to "DVD".
- Insert a disc you have recorded on.

- 1** While stopped
Press [TOP WINDOW].
- 2** Use the joystick [▲, ▼, ◀, ▶] to select "DIRECT NAVIGATOR" and press [ENTER].
- 3** Use the joystick [▲, ▼] to select the program you want to erase.
- 4** Use the joystick [▶] so the submenu appears.
- 5** Use the joystick [▲, ▼] to select "Erase Program" and press [ENTER].



- Erase Program
- Enter Title
- Properties
- Protection
- Shorten Segment

- 6** Use the joystick [◀, ▶] to select "Erase".

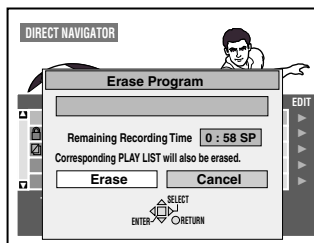

- 7** Press [ENTER].

■ To stop partway through

In step 6, either select "Cancel" and press [ENTER] or press [RETURN].

For your reference

- The disc's available recording time may not increase after erasing short programs.
- Computer data cannot be erased.
- The available recording time on DVD-R does not increase when you erase programs.

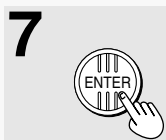
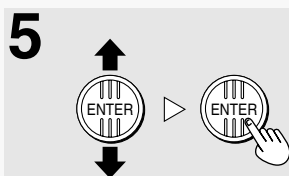
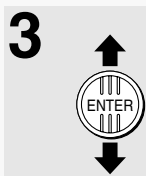
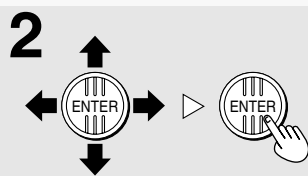
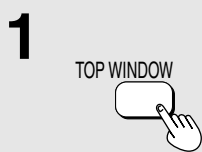
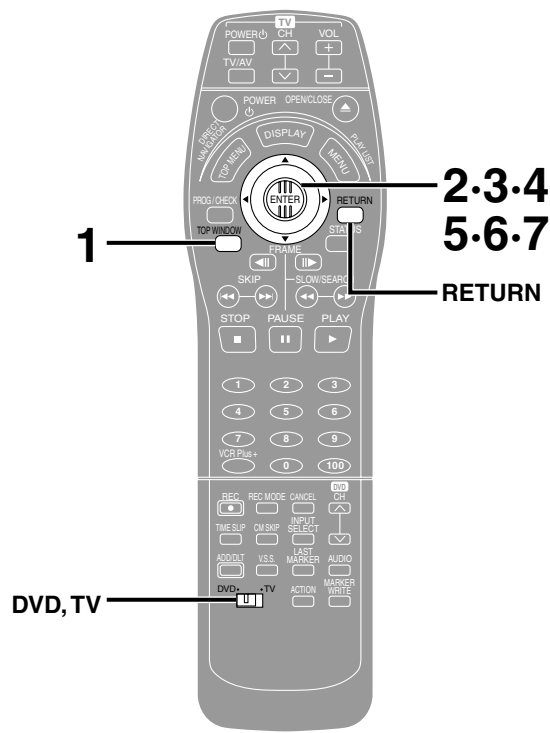

Entering and editing program titles



RAM DVD-R

Preparation

- Switch [DVD, TV] to "DVD".
- Insert a disc you have recorded on.

- 1 While stopped**
Press [TOP WINDOW].
- 2 Use the joystick [▲, ▼, ◀, ▶] to select "DIRECT NAVIGATOR" and press [ENTER].**



- 3 Use the joystick [▲, ▼] to select the program whose title you want to enter or edit.**
- 4 Use the joystick [▶] so the submenu appears.**
- 5 Use the joystick [▲, ▼] to select "Enter Title" and press [ENTER].**

Erase Program
Enter Title
Properties
Protection
Shorten Segment

- 6 Enter or edit the title.**
Enter titles as with disc titling (⇒ page 51).

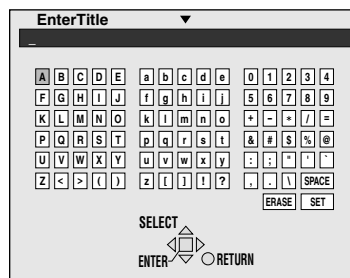

For your reference

You can give the programs on DVD-RAM titles of up to 64 characters and programs on DVD-R titles of up to 44 characters.

Note

- You cannot enter titles if the disc is protected with the write-protect tab (⇒ page 99).
- You cannot enter titles if the disc is protected with DISC SETTING (⇒ page 52).
- You cannot enter titles if the program is protected with the direct navigator (⇒ page 60).
- Even if you have entered up to the maximum number of characters, characters you enter after the position marked with "▼" in the title field and the two characters immediately prior to the mark will be replaced with "••" when displayed in the direct navigator.

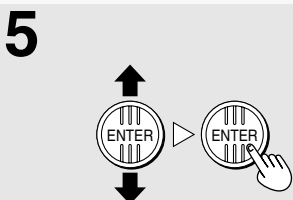
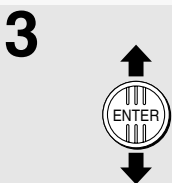
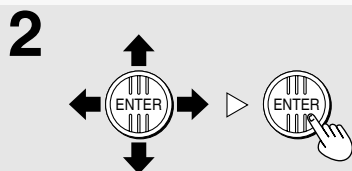
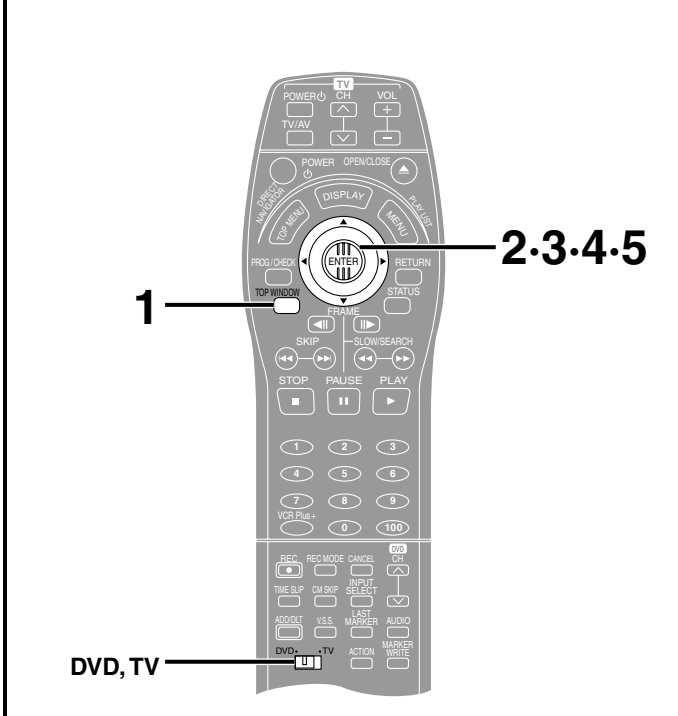



Protecting programs

RAM

You can prevent accidental erasure of programs by write-protecting them.

Preparation

- Switch [DVD, TV] to “DVD”.
- Insert a disc you have recorded on.

- 1 While stopped
Press [TOP WINDOW].
- 2 Use the joystick [▲, ▼, ◀, ▶] to select “DIRECT NAVIGATOR” and press [ENTER].



- 3 Use the joystick [▲, ▼] to select the program you want to protect.
- 4 Use the joystick [▶] so the submenu appears.
- 5 Use the joystick [▲, ▼] to select “Protection” and press [ENTER].



- 6 Use the joystick [◀, ▶] to select “Yes” and press [ENTER].

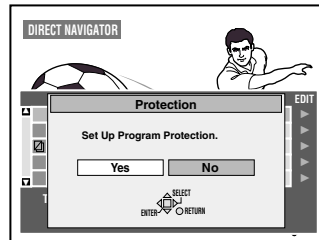

▽ When you press [ENTER]

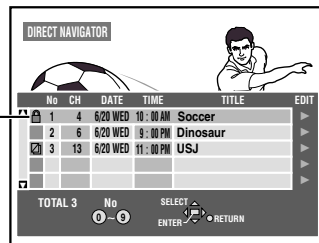

🔒 The padlock mark appears.

■ To stop partway through

In step 6, either select “No” and press [ENTER] or press [RETURN].

For your reference

Programs will be erased even if they are protected if you format the disc with DISC SETTING (➡ page 54).

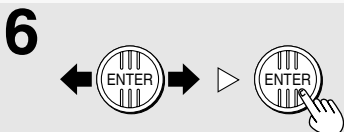
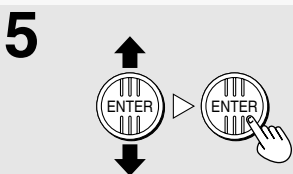
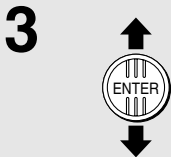
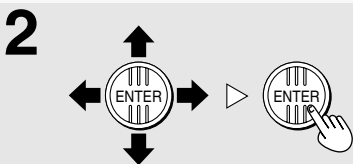
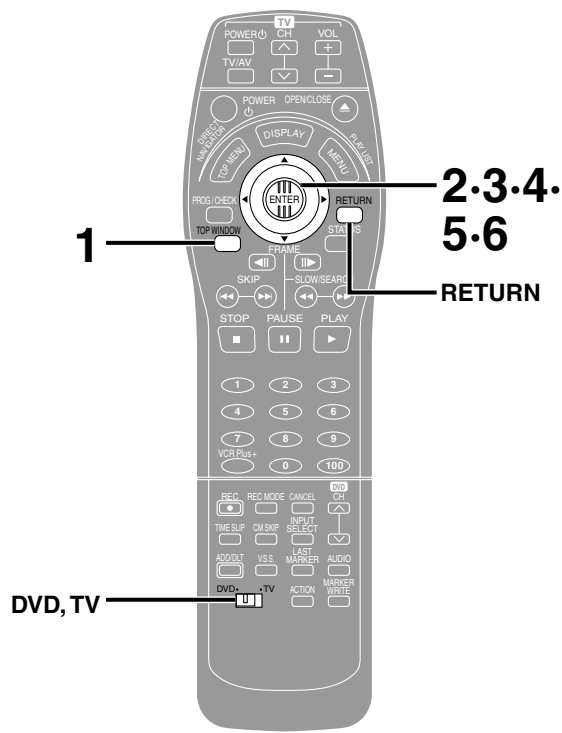

Releasing program protection



RAM

Preparation

- Switch [DVD, TV] to "DVD".
- Insert a disc you have recorded on.

- 1 While stopped
Press [TOP WINDOW].
- 2 Use the joystick [▲, ▼, ◀, ▶] to select "DIRECT NAVIGATOR" and press [ENTER].
- 3 Use the joystick [▲, ▼] to select the program you want to unprotect.
- 4 Use the joystick [▶] so the submenu appears.
- 5 Use the joystick [▲, ▼] to select "Protection" and press [ENTER].



- Erase Program
- Enter Title
- Properties
- Protection
- Shorten Segment

- 6 Use the joystick [◀, ▶] to select "Yes" and press [ENTER].

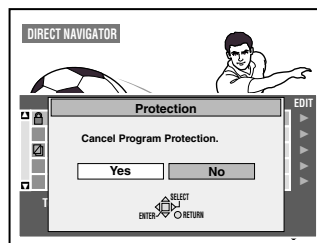

▽ When you press [ENTER]

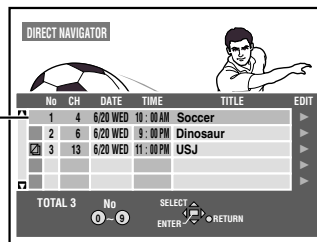

The padlock mark disappears.

■ To stop partway through

In step 6, either select "No" and press [ENTER] or press [RETURN].

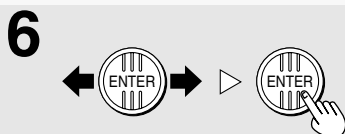
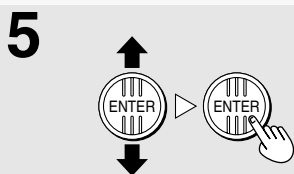
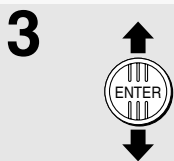
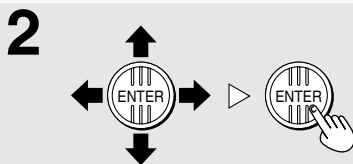
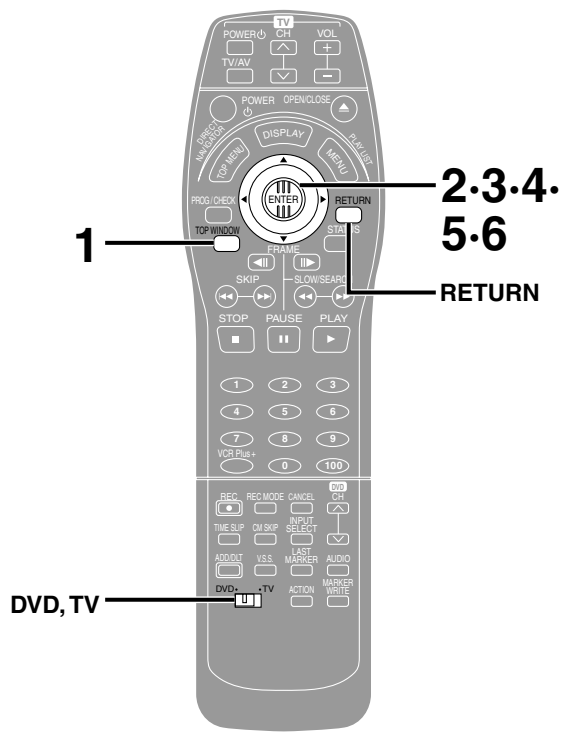



Checking program contents

RAM DVD-R

Preparation

- Switch [DVD, TV] to "DVD".
- Insert a disc you have recorded on.

- 1** While stopped
Press [TOP WINDOW].
- 2** Use the joystick [▲, ▼, ◀, ▶] to select "DIRECT NAVIGATOR" and press [ENTER].
- 3** Use the joystick [▲, ▼] to select the program whose contents you want to check.
- 4** Use the joystick [▶] so the submenu appears.
- 5** Use the joystick [▲, ▼] to select "Properties" and press [ENTER].



- Erase Program
- Enter Title
- Properties
- Protection
- Shorten Segment

▽ When you press [ENTER]

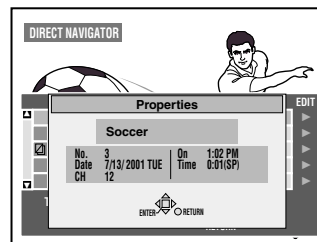

The contents of the program are shown: Program number, recording date, channel, recording start time, length of recording and recording mode.

- To return to the previous screen
Press [RETURN].

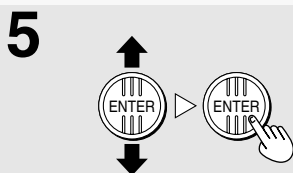
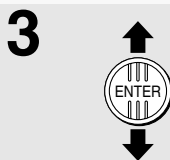
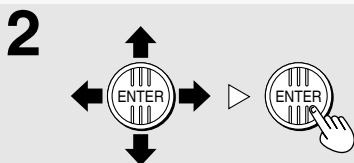
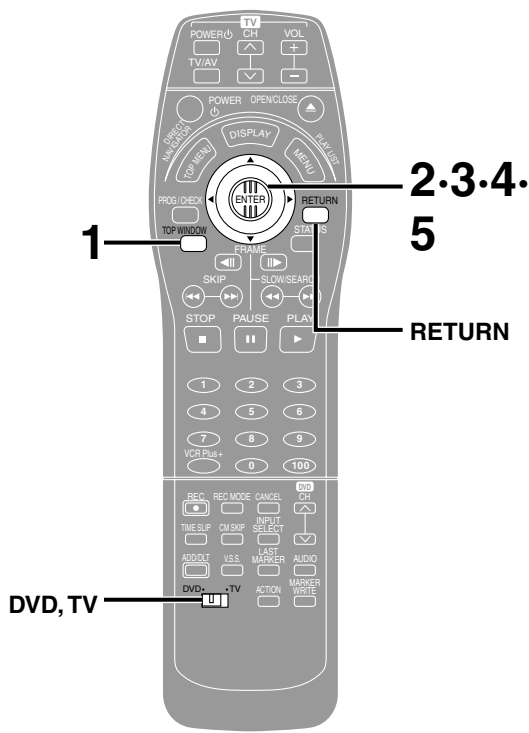

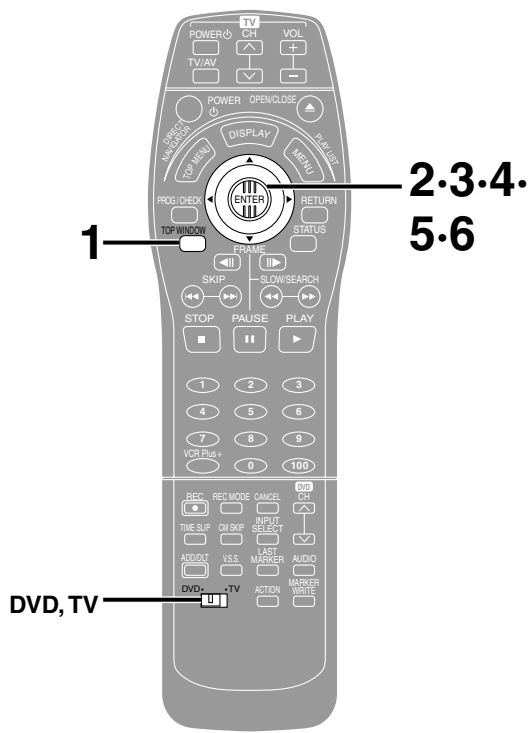
Erasing parts of a program—
Shorten Segment

RAM

The specified parts of the program are erased completely when you use this procedure and cannot be retrieved. Check the program carefully to ensure it isn't one you want to keep.

Preparation

- Switch [DVD, TV] to "DVD".
- Insert a disc you have recorded on.

- 1 While stopped
Press [TOP WINDOW].
- 2 Use the joystick [▲, ▼, ◀, ▶] to select "DIRECT NAVIGATOR" and press [ENTER].



- 3 Use the joystick [▲, ▼] to select the program which contains the part you want to erase.
- 4 Use the joystick [▶] so the submenu appears.
- 5 Use the joystick [▲, ▼] to select "Shorten Segment" and press [ENTER].

Erase Program

Enter Title

Properties

Protection

Shorten Segment

- 6 Use search functions such as fast-forward and slow-motion to find the start point of the part you want to erase and press [ENTER].

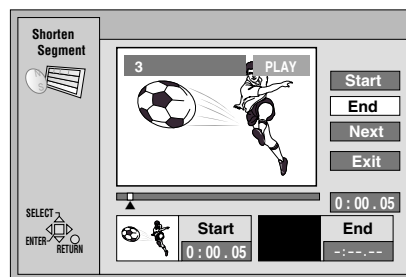

(Continued on next page)

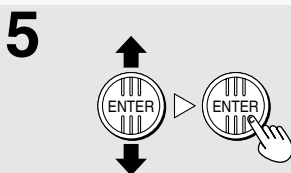
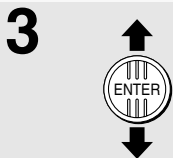
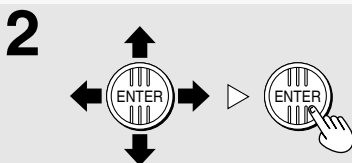
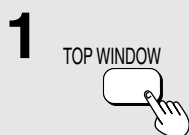

7.8.9 →

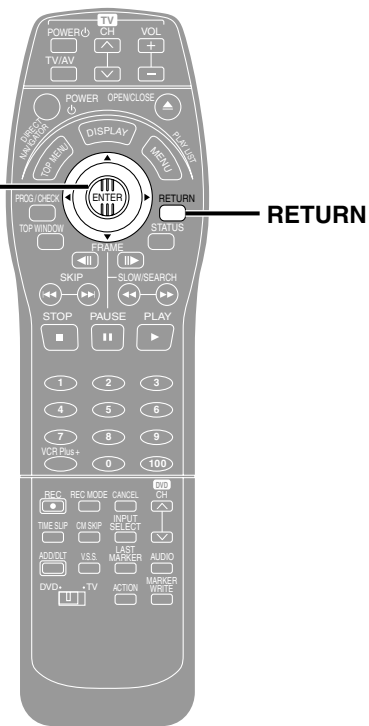

7 Use search functions such as fast-forward and slow-motion to find the end point of the part you want to erase and press [ENTER].

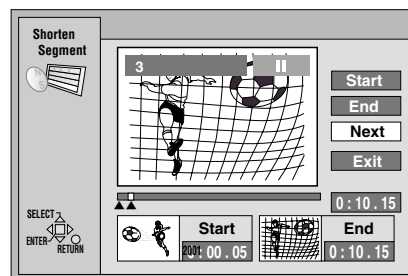

8 Use the joystick [▲, ▼] to select “Exit” and press [ENTER].

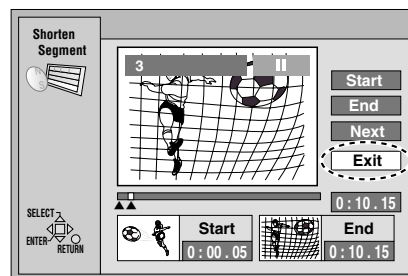

9 Use the joystick [◀, ▶] to select “Erase” and press [ENTER].

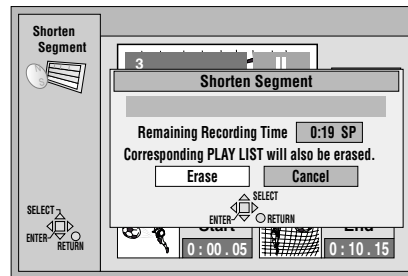

7



8

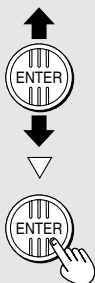

9

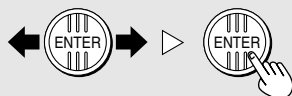

■ To stop partway through

Press [RETURN] or select “Cancel” and press [ENTER] in step 9.

■ To erase another part of the same program

Select “Next” after step 7 and press [ENTER], then repeat steps 9, 6 and 7.

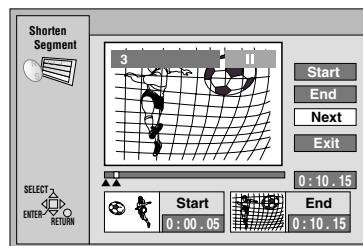

For your reference

- You can respecify the start or end points. The points you specify last are used.
- You cannot specify an end point before a start point or a start point after an end point.
- You may not be able to specify start and end points within 3 seconds of each other.
- You cannot specify start and end points if you have recorded still pictures on other equipment.
- The unit pauses play when the end of the program is reached during this procedure.
- The disc’s available recording time may not increase after erasing short parts of programs.
- You cannot erase parts of protected programs.
- Play lists created with the erased part are also erased.

Using play lists to edit programs

Displaying play lists

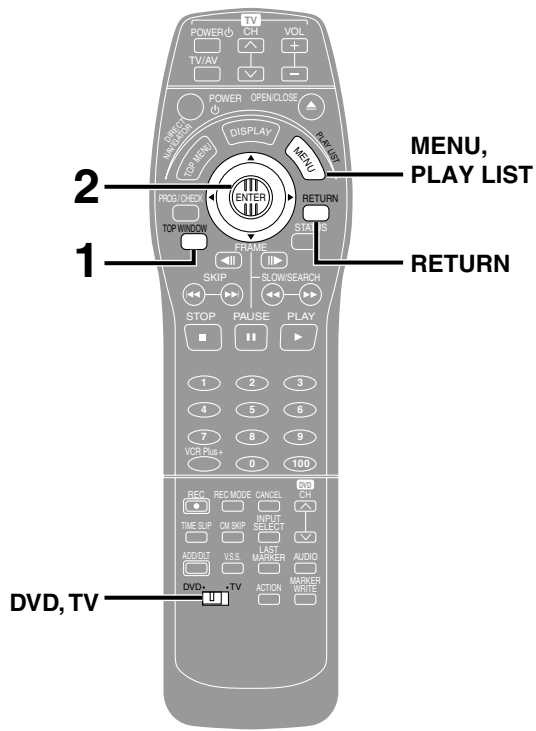

RAM

Preparation

- Switch [DVD, TV] to “DVD”.
- Insert a disc you have recorded on.

- 1 While stopped
Press [TOP WINDOW].
- 2 Use the joystick [▲, ▼, ◀, ▶] to select “PLAY LIST” and press [ENTER].

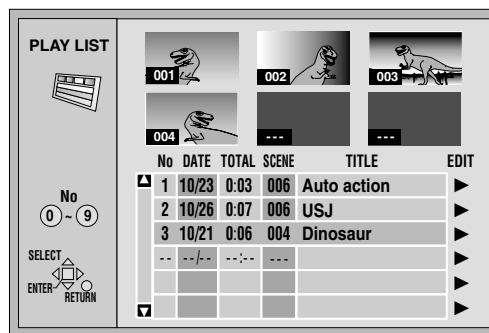

The play list screen appears. Scenes are not displayed if you have not yet created a play list with the disc.

■ To clear the play list screen

Press [MENU, PLAY LIST] or [RETURN].

The screen returns to the state it was in before you called up the play list.

■ What you can do with the play list screen

- Create play lists (⇒ page 66)
- Play play lists (⇒ page 67)
- Select a scene to play (⇒ page 68)
- Add, move, re-edit, and erase scenes (⇒ pages 68–71)
- Copy play lists (⇒ page 72)
- Erase play lists (⇒ page 72)
- Give play lists titles (⇒ page 73)
- Check a play list's contents (⇒ page 74)

For your reference

- ▲ You can also display the play list by pressing [MENU, PLAY LIST].

About the play list scene screen

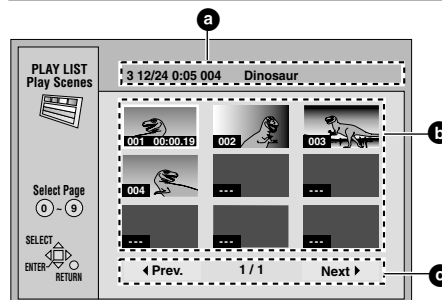

a Play list information

This shows the play list number, date of creation (month/date), total play time, the number of scenes it contains, and title (if entered).

b Scenes

9 scenes can be shown on a page.

c Turning pages

If there are more than nine scenes, use the joystick [▲, ▼, ◀, ▶] to select “◀ Prev.” or “Next ▶” and press [ENTER] to move to the previous page or next page. You can also enter the three digits with the numbered buttons (⇒ page 8).

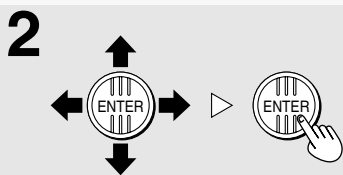
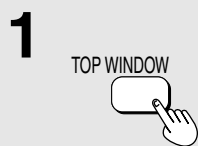



Creating play lists

RAM

You can specify start and end points to create a scene, then specify the order in which these scenes are played. These scenes are not recorded separately so this doesn't use up much of the disc's capacity.

Preparation

- Switch [DVD, TV] to "DVD".
- Insert a disc you have recorded on.

- 1** While stopped
Press [TOP WINDOW].
- 2** Use the joystick [**▲**, **▼**, **◀**, **▶**] to select "CREATE PLAY LIST" and press [ENTER].
- 3** Use search functions such as fast-forward and slow-motion to find the start point of the scene and press [ENTER].

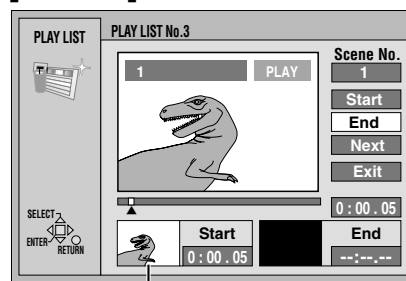

A thumbnail image of the start point appears.

- 4** Use search functions such as fast-forward and slow-motion to find the end point of the scene and press [ENTER].

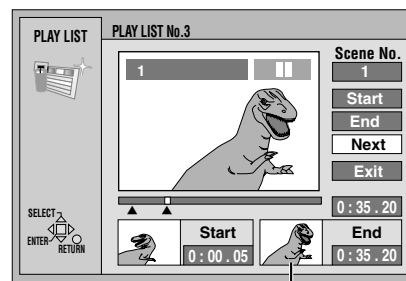

A thumbnail image of the end point appears.

■ To specify another scene

Select "Next" and press [ENTER], then repeat steps 3 and 4.

- 5** Use the joystick [**▲**, **▼**] to select "Exit" and press [ENTER].

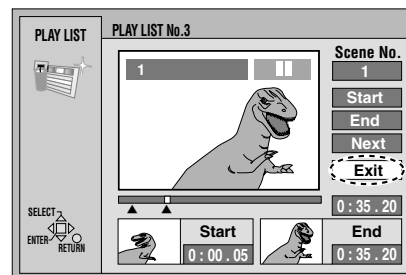

The play lists screen appears.

■ To stop partway through

Press [RETURN].

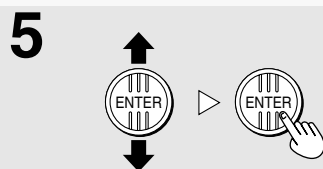
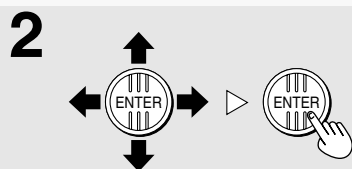
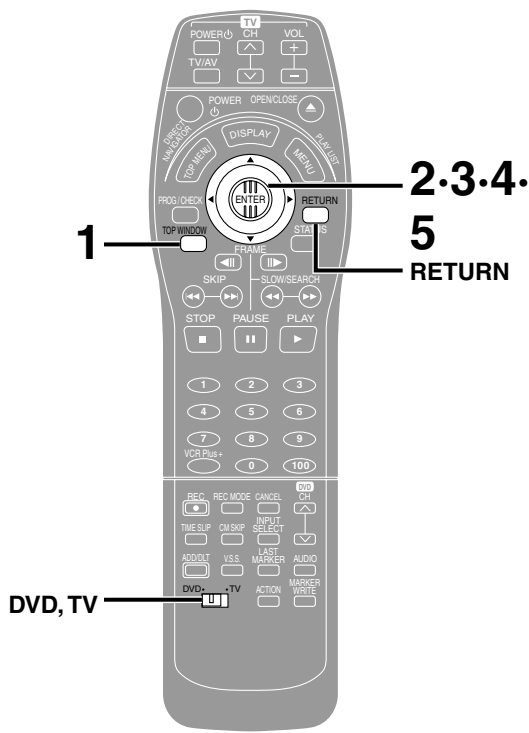

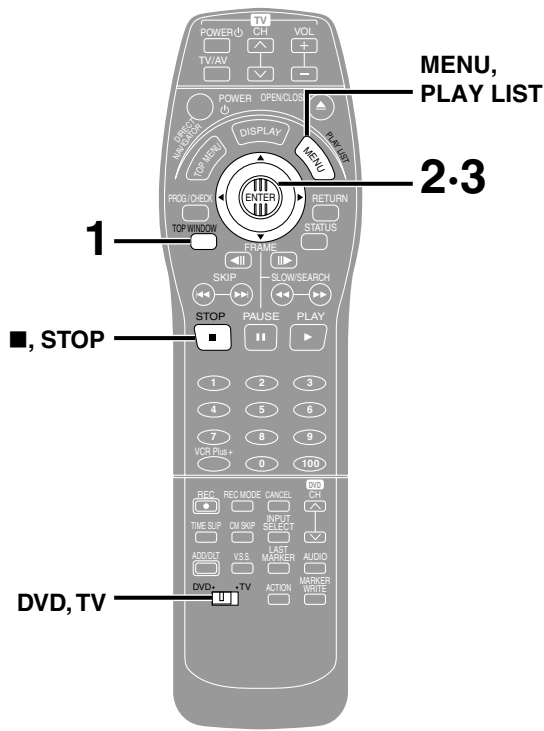

■ To clear the play list screen

Press [MENU, PLAY LIST].

The screen returns to the state it was in before you called up the play list.

For your reference

- One disc can have a maximum of 99 play lists and 999 scenes. These limits may be reduced under some conditions.
- You can respecify the start or end points. The points you specify last are used.
- You cannot specify an end point before a start point or a start point after an end point.
- If you specify an end point but not a start point, the unit determines the beginning of the program as the start point. Similarly, if you specify a start point but not an end point, the unit determines the end of the program as the end point.
- You cannot specify start and end points if you have recorded still pictures on other equipment.
- The unit pauses play when the end of the last program on the disc is reached during this procedure.
- You cannot create or edit play lists if Disc Protection in DISC SETTING is On (➡ page 52).
- You can not create or edit play lists if the disc is protected with the write-protect tab. Release this before operation (➡ page 99).

Playing play lists



RAM

Preparation

- Switch [DVD, TV] to "DVD".
- Insert a disc you created play lists on.

- 1 While stopped**
Press [TOP WINDOW].
- 2 Use the joystick [▲, ▼, ◀, ▶] to select "PLAY LIST" and press [ENTER].**
- 3 Use the joystick [▲, ▼] to select the play list you want to play and press [ENTER].**



All the scenes in the play list are played.

No	DATE	TOTAL	SCENE	TITLE	EDIT
1	10/23	0:03	006	Auto action	▶
2	10/26	0:07	006	USJ	▶
3	10/21	0:06	004	Dinosaur	▶
..	▶

- You can display the play lists after the sixth one by moving the joystick [▼].

■ To stop play list play

Press [■, STOP].

The play list appears.

For your reference

- You can also display the play list screen by pressing [MENU, PLAY LIST] at step 1.
- You can fast-forward, rewind, pause, and slow-motion while playing scenes just as you can during normal play.
- You can also select play lists from the list in step 3 by entering a 2-digit number with the numbered buttons (➡ page 8) and pressing [ENTER].
If you enter a number larger than the total number of play lists, the last play list is selected.

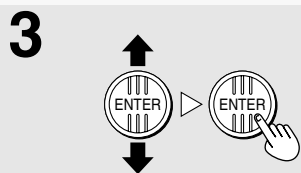
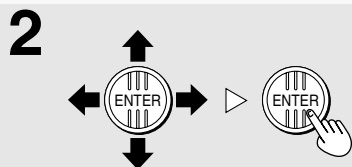

Playing play list scenes



RAM

Preparation

- Switch [DVD, TV] to “DVD”.
- Insert a disc you created play lists on.

- 1 While stopped
Press [TOP WINDOW].
- 2 Use the joystick [▲, ▼, ◀, ▶] to select “PLAY LIST” and press [ENTER].



- 3 Use the joystick [▲, ▼] to select the play list that contains the scene you want to play and use the joystick [▶].
- 4 Use the joystick [▲, ▼] to select “Play Scenes” and press [ENTER].

Play Scenes
Edit Scenes
PL Copy
PL Erase
Enter Title
Properties

- 5 Use the joystick [▲, ▼, ◀, ▶] to select the scene you want to play and press [ENTER].

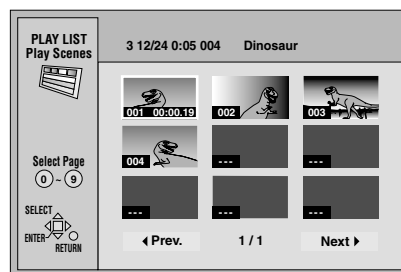

- The scene you select is played.

■ To stop scene play

Press [■, STOP].

The scene list appears.

■ To show scene 10 and later

In step 5, use the joystick [▲, ▼, ◀, ▶] to select “Next ▶” and press [ENTER].

For your reference

- You can fast-forward, rewind, pause, and slow-motion while playing scenes just as you can during normal play.
- You can also select a page of scenes in step 5 by entering a 3-digit number with the numbered buttons (➡ page 8) and pressing [ENTER].

Editing play list scenes



RAM

Preparation

- Switch [DVD, TV] to “DVD”.
- Insert a disc you created play lists on.

- 1 While stopped
Press [TOP WINDOW].
- 2 Use the joystick [▲, ▼, ◀, ▶] to select “PLAY LIST” and press [ENTER].



(Continued on next page)

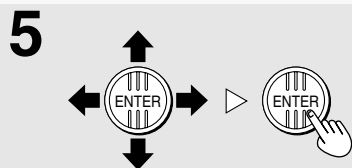
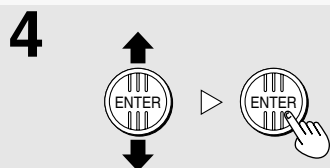
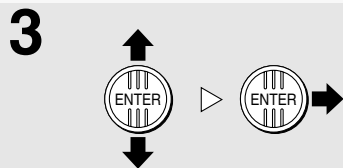
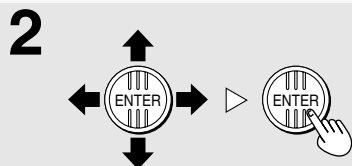
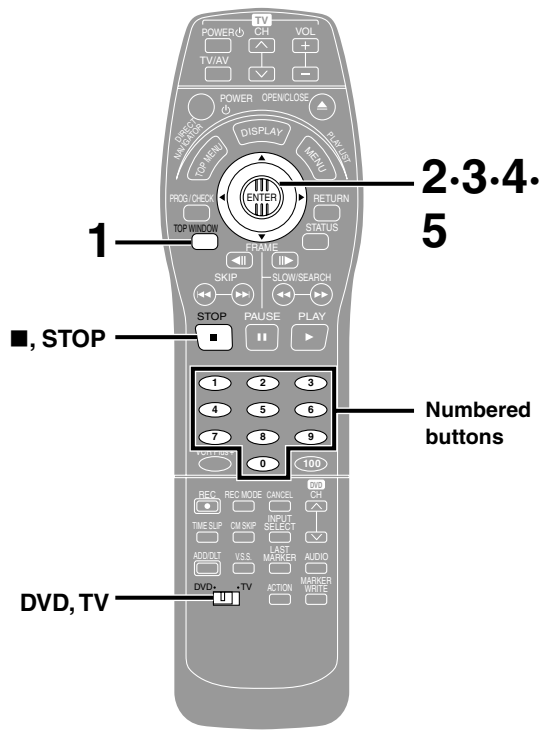

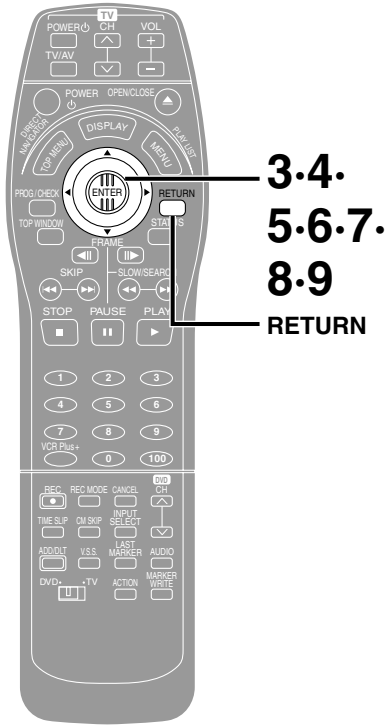

- 3 Use the joystick [▲, ▼] to select the play list you want to edit and use the joystick [▶].
- 4 Use the joystick [▲, ▼] to select “Edit Scenes” and press [ENTER].

Play Scenes
Edit Scenes
PL Copy
PL Erase
Enter Title
Properties

Adding scenes to a play list

Preparation

Do steps 1 to 4 of “Editing play list scenes” (↔ page 68 and above).

- 5 Use the joystick [◀, ▶] to select “Add” and press [ENTER].

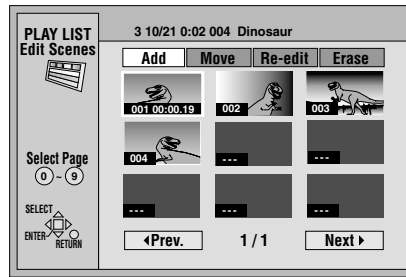

- 6 Use the joystick [▲, ▼, ◀, ▶] to select the scene after the position you want to add the scene and press [ENTER].
- 7 Use search functions such as fast-forward and slow-motion to find the start point of the scene and press [ENTER].

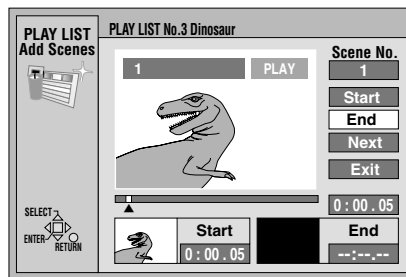

- 8 Use search functions such as fast-forward and slow-motion to find the end point of the scene and press [ENTER].
- 9 Use the joystick [▲, ▼] to select “Exit” and press [ENTER].

The screen from step 5 reappears.

■ To stop partway through

Press [RETURN].

■ To add other scenes

- ① Use the joystick [▲, ▼] after step 8 to select “Next” and press [ENTER].
- ② Repeat steps 7 and 8.

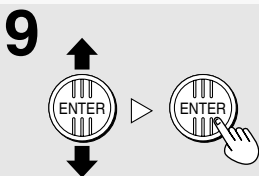
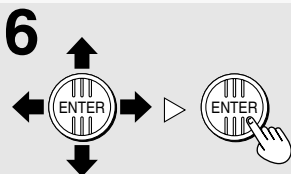
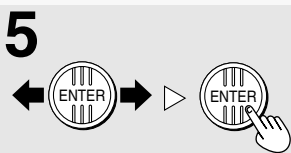
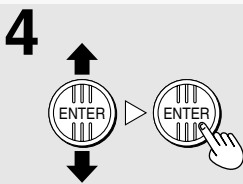
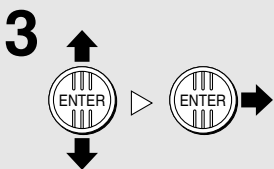

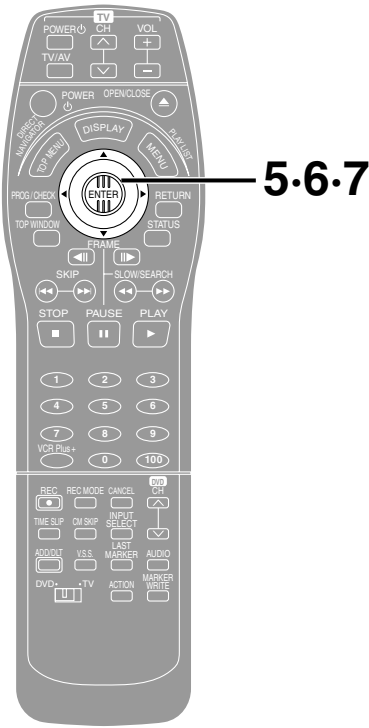

5



6.7

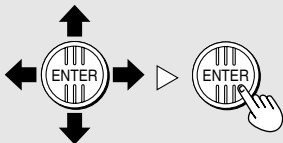

Using play lists to edit programs

Preparation

Do steps 1 to 4 of "Editing play list scenes" (→ pages 68 and 69).

Moving a scene

5 Use the joystick [◀, ▶] to select "Move" and press [ENTER].

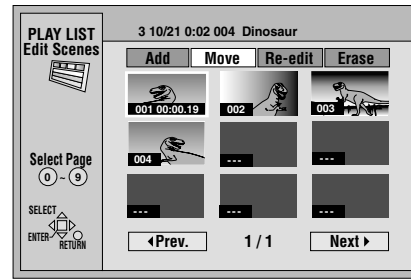

6 Use the joystick [▲, ▼, ◀, ▶] to select the scene you want to move and press [ENTER].

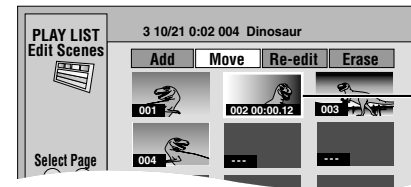

Selected scene

7 Use the joystick [▲, ▼, ◀, ▶] to select the scene currently in the position to which you want to move the scene to and press [ENTER].

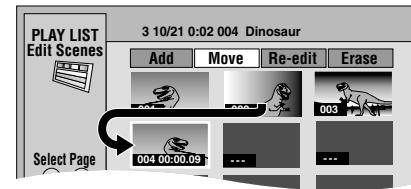

The scene you selected in step 6 moves to the position in front of the scene selected.

■ To move another scene

Repeat steps 6 and 7.

To re-edit a play list scene

5 Use the joystick [◀, ▶] to select "Re-edit" and press [ENTER].

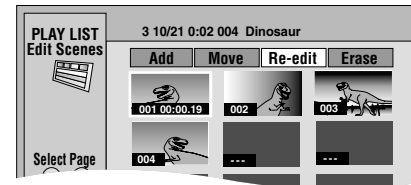

6 Use the joystick [▲, ▼, ◀, ▶] to select the scene you want to re-edit and press [ENTER].

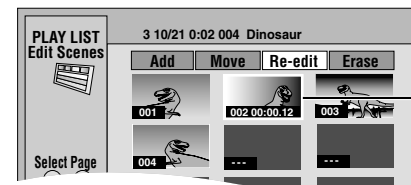

Selected scene

(Continued on next page)

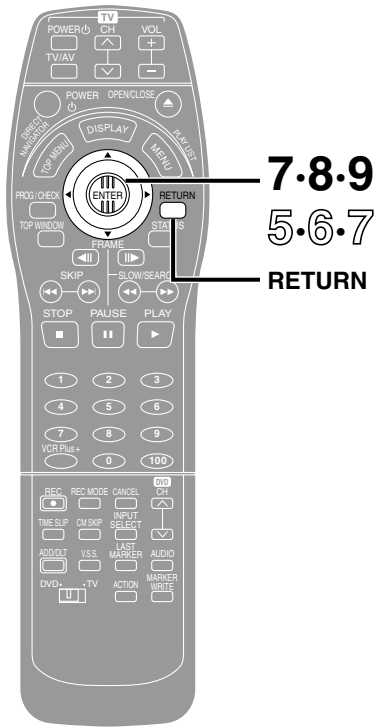

- 7** Use search functions such as fast-forward and slow-motion to find the start point of the scene and press [ENTER].

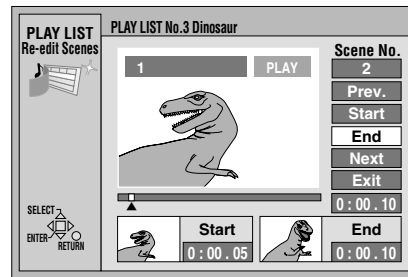

- 8** Use search functions such as fast-forward and slow-motion to find the end point of the scene and press [ENTER].
- 9** Use the joystick [▲, ▼] to select “Exit” and press [ENTER].

■ To re-edit another scene

- Use the joystick [▲, ▼] after step 8 to select “Prev.” or “Next” and press [ENTER] until you find the scene you want to reedit.
- Repeat steps 7 and 8 to continue re-editing other scenes.

Note

You cannot specify an end point before a start point or a start point after an end point.

Erasing a scene from a play list

Preparation

Do steps 1 to 4 of “Editing play list scenes” (→ pages 68 and 69).

- 5** Use the joystick [◀, ▶] to select “Erase” and press [ENTER].

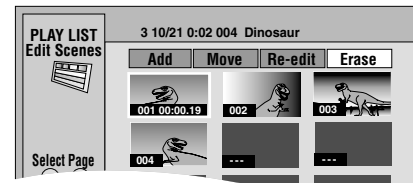

- 6** Use the joystick [▲, ▼, ◀, ▶] to select the scene you want to erase and press [ENTER].
- 7** Use the joystick [◀, ▶] to select “Yes” and press [ENTER].

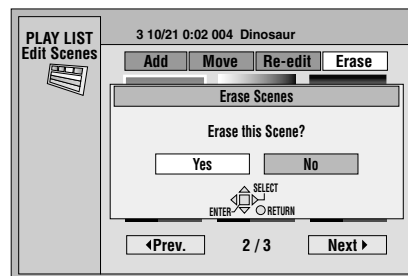

The selected scene is erased from the play list.

■ To erase other scene

Repeat steps 6 and 7.

■ To stop partway through

In step 7, either select “No” and press [ENTER] or press [RETURN].

For your reference

The play list itself is erased if you erase all the scenes in it.

7.8



9

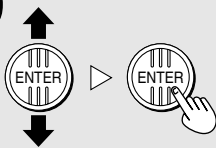

5

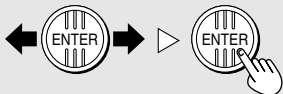

6

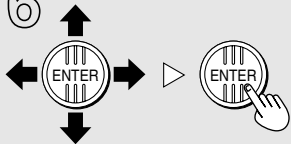

7

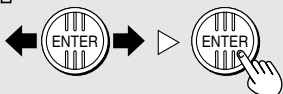

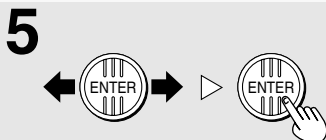
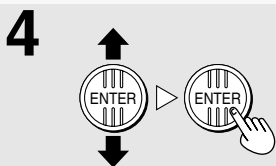
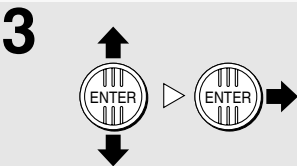
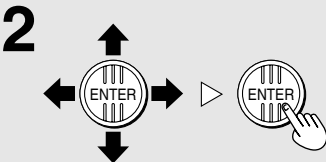
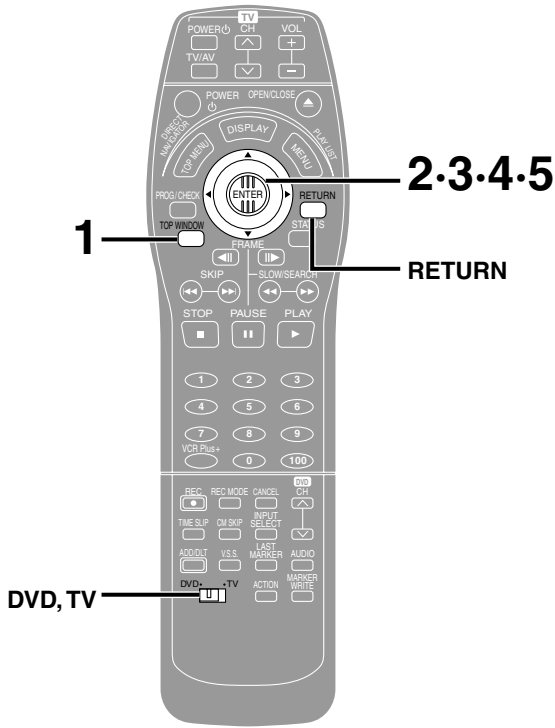

Using play lists to edit programs

RAM

Preparation

- Switch [DVD, TV] to “DVD”.
- Insert a disc you created play lists on.



Copying play lists

- 1** While stopped
Press [TOP WINDOW].
- 2** Use the joystick [▲, ▼, ◀, ▶] to select “PLAY LIST” and press [ENTER].



- 3** Use the joystick [▲, ▼] to select the play list you want to copy and then use the joystick [▶].
- 4** Use the joystick [▲, ▼] to select “PL Copy” and press [ENTER].

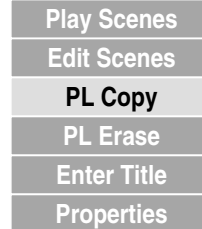

- 5** Use the joystick [◀, ▶] to select “Copy” and press [ENTER].

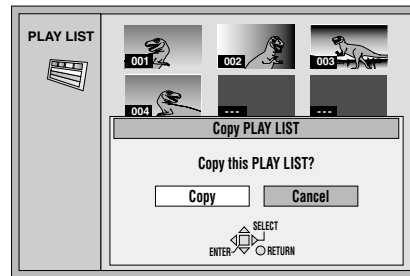

The copied play list appears at the bottom of the list.

■ To stop partway through

Is step 5, either select “Cancel” and press [ENTER] or press [RETURN].



Erasing a play list

- 1** While stopped
Press [TOP WINDOW].
- 2** Use the joystick [▲, ▼, ◀, ▶] to select “PLAY LIST” and press [ENTER].



- 3** Use the joystick [▲, ▼] to select the play list you want to erase and use the joystick [▶].

(Continued on next page)

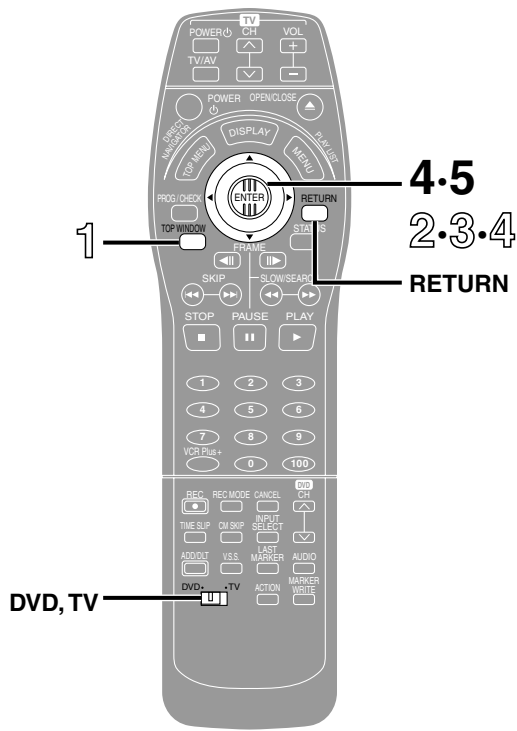

4 Use the joystick [▲, ▼] to select “PL Erase” and press [ENTER].

- Play Scenes
- Edit Scenes
- PL Copy
- PL Erase**
- Enter Title
- Properties

5 Use the joystick [◀, ▶] to select “Erase” and press [ENTER].

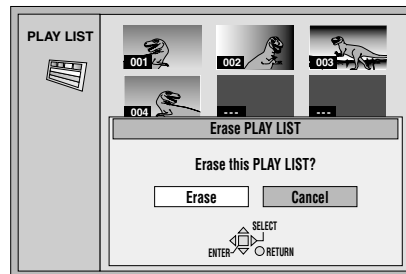

The play list is erased.

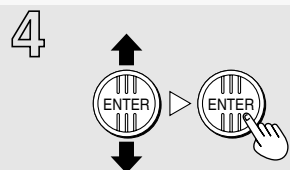
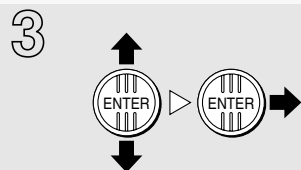
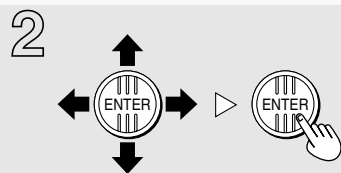
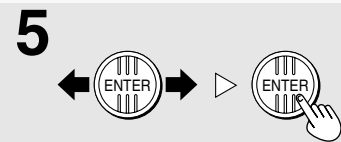
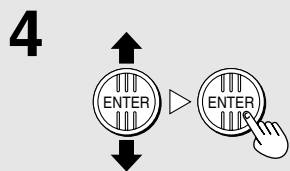

■ To stop partway through

In step 5, either select “Cancel” and press [ENTER] or press [RETURN].



Titling play lists

RAM

Preparation

- Switch [DVD, TV] to “DVD”.
- Insert a disc you created play lists on.

- 1** While stopped
Press [TOP WINDOW].
- 2** Use the joystick [▲, ▼, ▶, ◀] to select “PLAY LIST” and press [ENTER].



- 3** Use the joystick [▲, ▼] to select the play list you want to title and then move the joystick [▶].
- 4** Use the joystick [▲, ▼] to select “Enter Title” and press [ENTER].

- Play Scenes
- Edit Scenes
- PL Copy
- PL Erase
- Enter Title**
- Properties

- 5** Enter the title.
Enter titles as with disc titling (⇒ page 51).

For your reference

You can give play lists on DVD-RAM titles of up to 64 characters.

Note

Even if you have entered up to the maximum number of characters, characters you enter after the position marked with “▼” in the title field and the two characters immediately prior to the mark will be replaced with “..” when displayed in the play list screen.



Checking play list contents

RAM

Preparation

- Switch [DVD, TV] to "DVD".
- Insert a disc you created play lists on.

- 1** While stopped
Press [TOP WINDOW].
- 2** Use the joystick [▲, ▼, ◀, ▶] to select "PLAY LIST" and press [ENTER].
- 3** Use the joystick [▲, ▼] to select the play list whose contents you want to check and then use the joystick [▶].
- 4** Use the joystick [▲, ▼] to select "Properties" and press [ENTER].



- Play Scenes
- Edit Scenes
- PL Copy
- PL Erase
- Enter Title
- Properties

▽ When you press [ENTER]

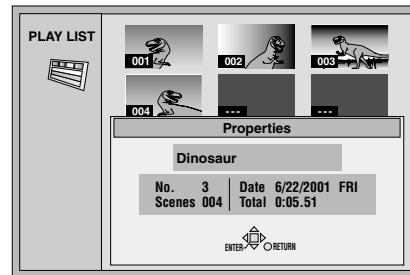

You can confirm the play list title (if entered), play list number, date of creation, total number of scenes and total time.

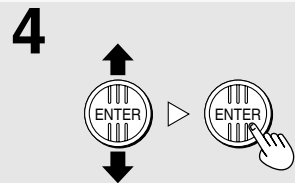
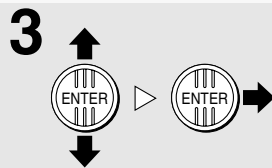
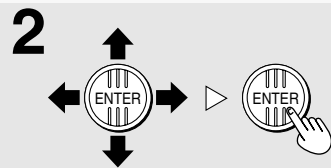
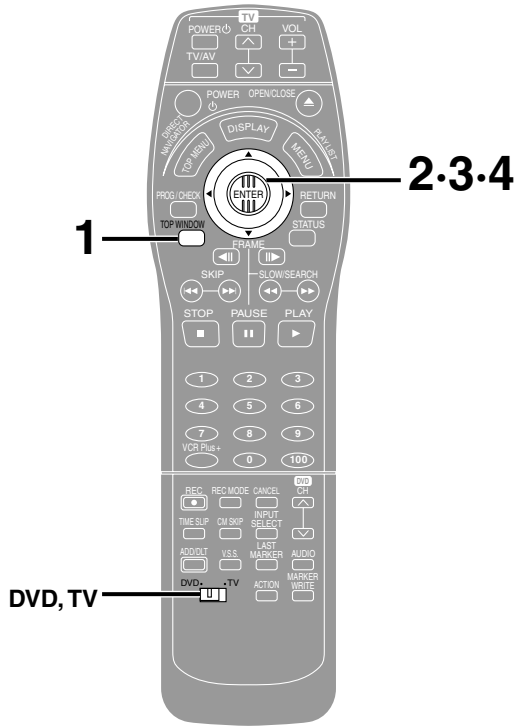

Expanding your home theater system

Refer to the relevant pages for details.

Enjoying CATV broadcasts

What you want to do	How to do it	Reference pages	Settings	Reference pages
Enjoying CATV broadcasts	Connect a cable TV box.	76 A	Tune to channels correctly.	16, 18, 91
			Change the necessary settings on the equipment you have connected.	—

Enjoying more powerful sound

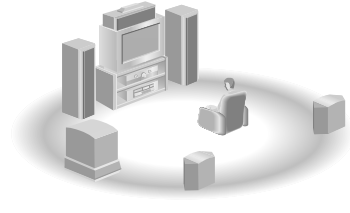
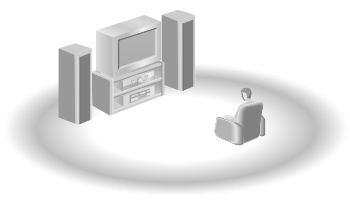
Enjoying 5.1-channel surround sound with Dolby Digital and DTS 	Digital connection Connect to an amplifier with built-in decoders.	78 B	ACTION settings—Audio •Set PCM Down Conversion to On. •Set Dolby Digital and DTS to suit the equipment.	86
			Change speaker settings on the amplifier.	—
Enjoying stereo or Dolby Pro Logic 	Analog connection Connect to an analog amplifier or system component.	78 C	ACTION settings—Audio •Set PCM Down Conversion to Off.	86
			Digital connection Connect to a digital amplifier or system component.	78 B

Other uses

Record to digital recording equipment or cassette deck (**B C**)

→ page 78)

Record from a video cassette recorder (→ pages 49 and 79 **D**)

Use connection **C** to enjoy discs recorded with a sampling frequency of 96 kHz. Sound will not be output if you use connection **B** and set PCM Down Conversion to “Off” due to copy protection.

(Convert the signal to 48 kHz to enjoy this type of audio.)

For your reference

- The equipment connections described are examples.
- Before connection, turn off all equipment and read the appropriate operating instructions.

Note

You can enjoy Dolby Digital in stereo with this unit alone. (This unit does not have a DTS decoder.)

Select channel 3 or 4 to see the output from the cable TV box or DSS receiver. Select the appropriate video input if your television has more than one.

A Connecting a cable TV box

You need to have a cable TV box and a contract with a cable TV company to enjoy CATV broadcasts.

- Consult your cable TV company for an appropriate cable TV box.

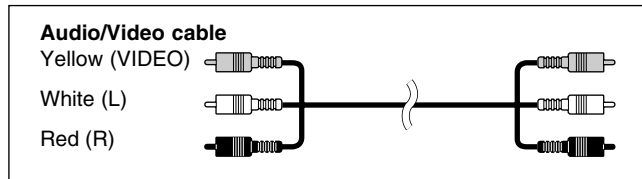

■ With a cable TV box

Television (not included)

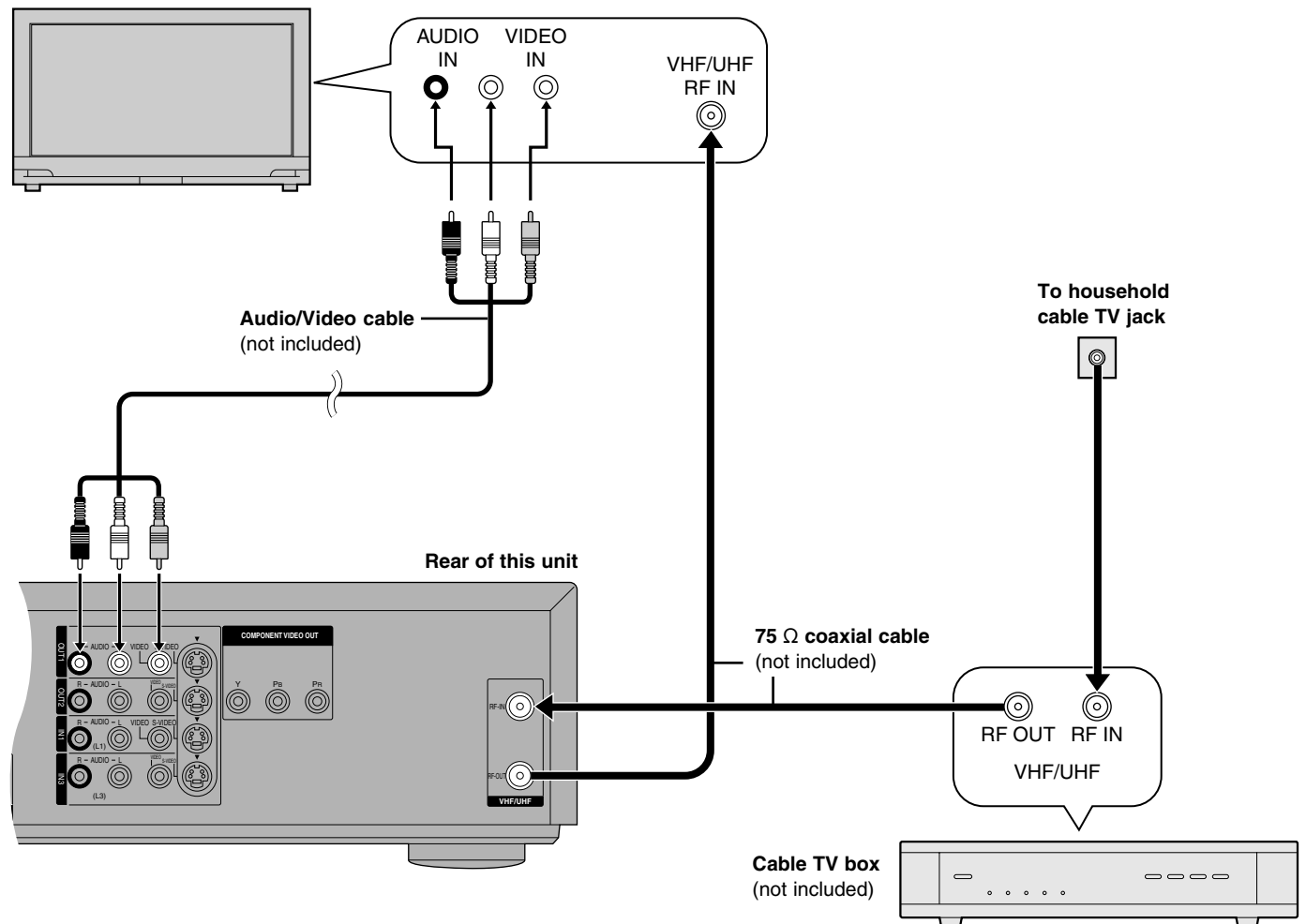

You cannot

- view channels other than the one selected when recording.
- do a timer recording unless the channel is first selected on the cable TV box.

With two cable boxes
Television (not included)

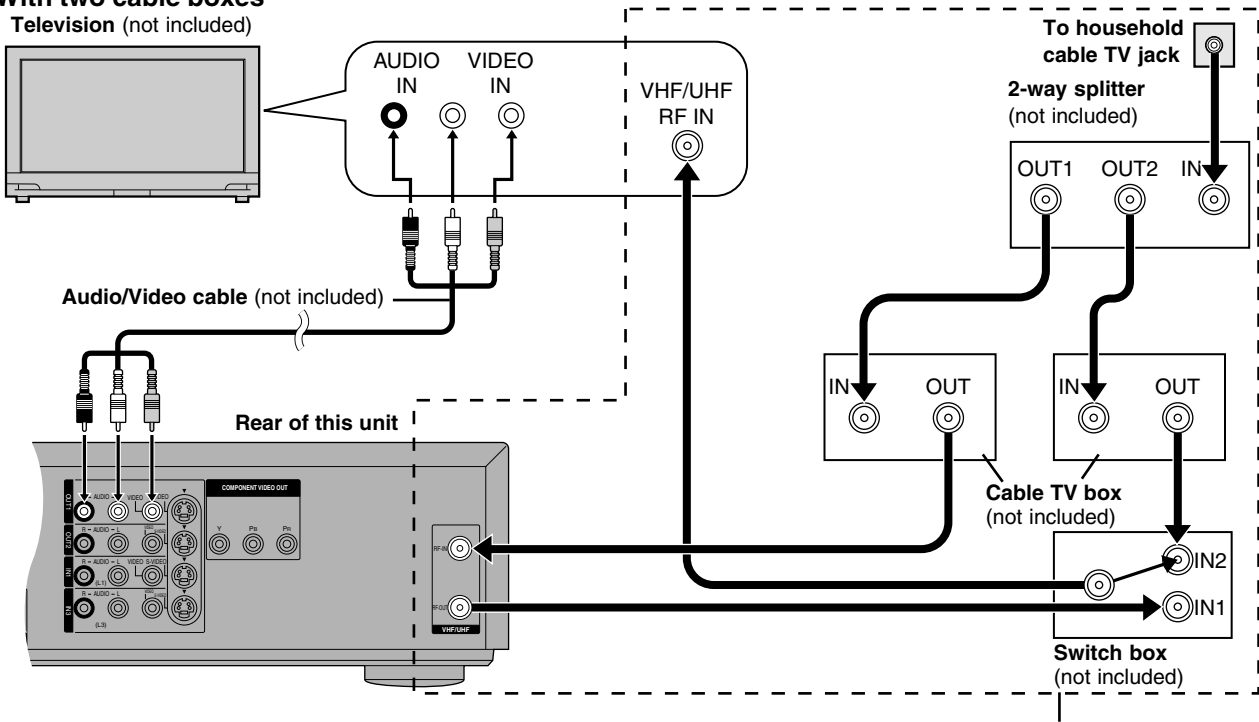

Connect with 75 Ω coaxial cables (not included)

You can

- record and view both scrambled and unscrambled channels if additional equipment is added. This connection requires: two cable TV boxes, a switch box, and a 2-way splitter.

You cannot

- view channel other than the one selected when recording.
- do a timer recording unless the channel is first selected on the cable TV box.

Connecting a home satellite system (Dishnetwork/DSS)

Note

When a home satellite system (Dishnetwork/DSS) is connected, auto channel program and auto time set may not operate properly. Set the clock manually (➔ page 88).

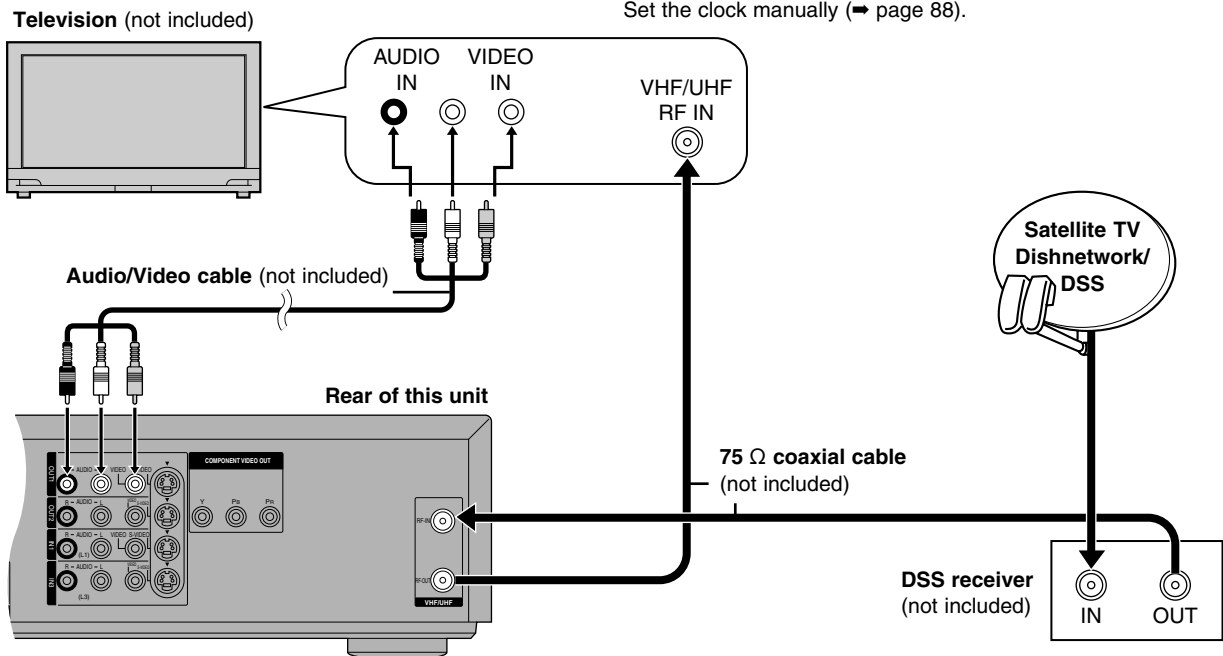

You cannot

- view channel other than the one selected when recording.
- do a timer recording unless the channel is first selected on the DSS receiver.

B Connecting to a digital amplifier or system component

Rear of this unit

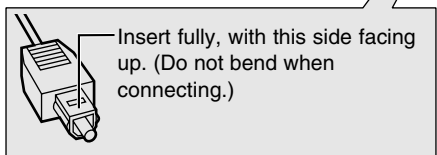
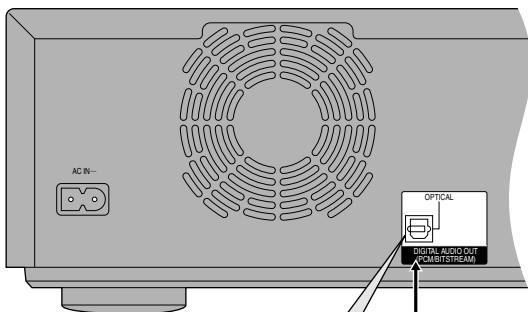

Optical digital audio cable (not included)

To optical digital input

Amplifier or system component (with or without decoders) (not included)

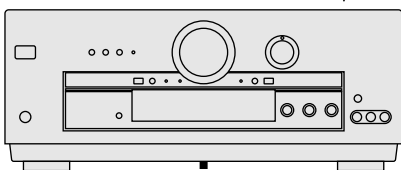

Speakers (not included)
Example:
Six speakers

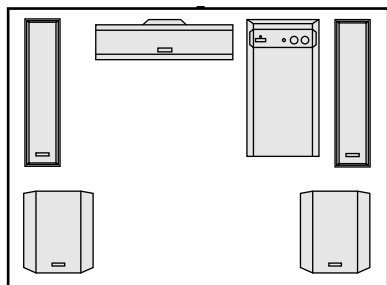

For your reference

- Change the settings in the Audio ACTION menus (⇒ page 83) to suit the digital equipment you have connected.
If the equipment can decode Dolby Digital, set “Dolby Digital” to “Bitstream” (factory setting).
If the equipment can decode DTS, set “DTS” to “Bitstream”.
- The DTS decoder must be compatible with the signals recorded on DVD.

You can record the digital signal directly onto digital recording equipment.

The signals on DVDs will be converted to 48 kHz/16 bit linear PCM.

When recording DVDs, ensure the following conditions are met.

- There is no copy guard recorded on the disc.
- The recording equipment can handle a sampling frequency of 48 kHz/16 bit.

If you want to use the synchro recording feature on your digital recording equipment and you use connection **B** or **C** to record from CDs or video CDs, first pause at the point you want to record from, activate the synchro feature, then restart play on the unit.

C Connecting an analog amplifier or system component

Audio cable



Rear panel of this unit

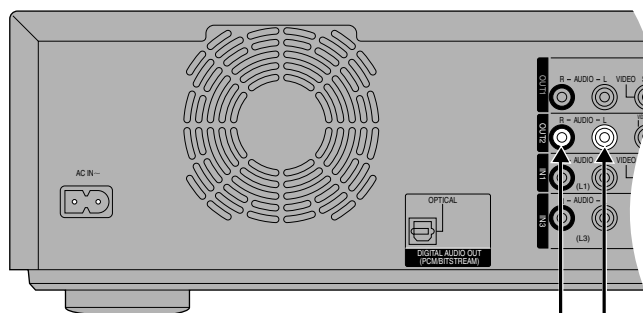

Audio cable (not included)

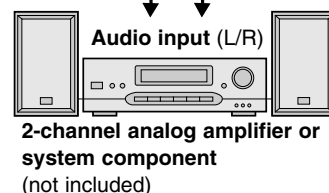

■ To enjoy Dolby Pro Logic (⇒ page 96)

You will also need to connect center and surround speakers in addition to the front speakers to enjoy surround sound. Read the instructions for the equipment for connection details. Turn V.S.S. off. Dolby Pro Logic will not function correctly if V.S.S. is on.

D Connecting a video cassette recorder

When connecting to the L2 input terminals on the front of the unit

Audio/Video cable

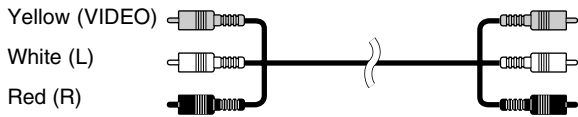

When connecting to the input terminals on the rear of the unit

Audio/Video cable

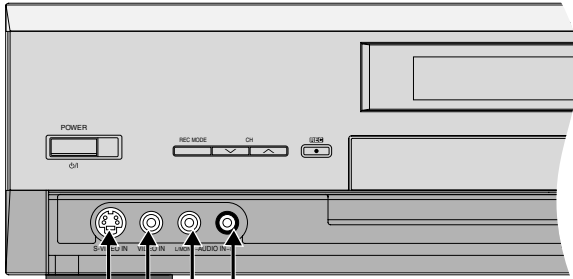
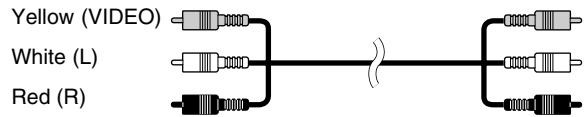

S video cable
(not included)

Audio/Video cable
(not included)

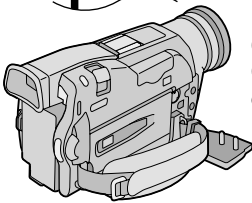

Other playback equipment
Connect to the video and audio output terminals.

Rear panel of this unit

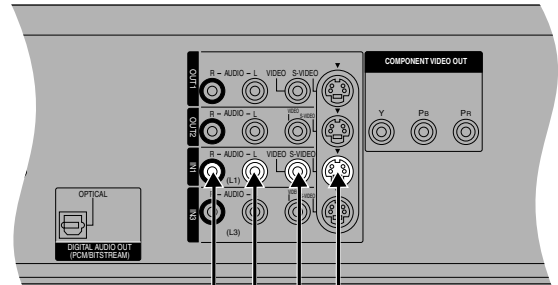

Audio/Video cable
(not included)

S video cable
(not included)

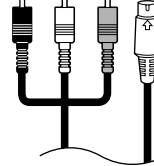

Other playback equipment
Connect to the video and audio output terminals.

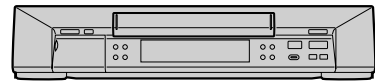

Note

If the audio output of the other equipment is monaural, connect to L/MONO. (Both left and right channels are recorded when connected through L/MONO.)

Note

If audio output on the other equipment is monaural, use a stereo-monaural conversion cable (not included).

When you can't directly connect the antenna you disconnected from your television to the unit

Check the type of antenna input on your television and make the appropriate connection.

■ **If it is a twin lead**

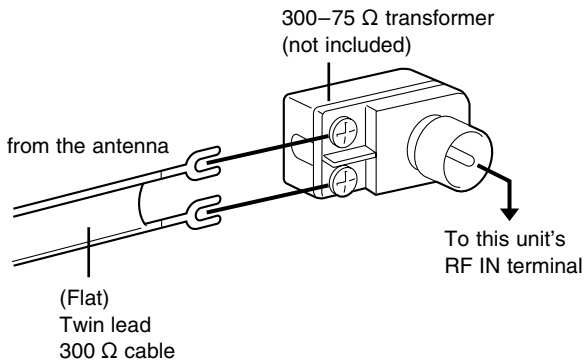

■ **If there is a twin lead and a coaxial cable**

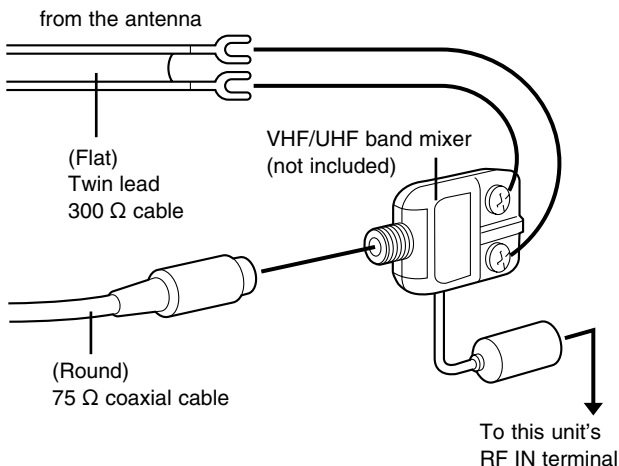

■ **If there are two twin leads**

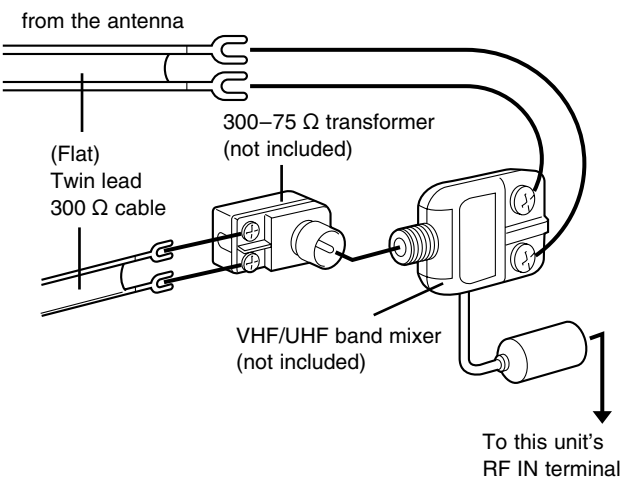

● If your television has both post and plug-type VHF terminals, the post connection is recommended to minimize signal loss.

When you can't directly connect the included 75 Ω coaxial cable to the television

Use the connection that suits the type of terminal.

■ **If it is a screw & plug type terminal**

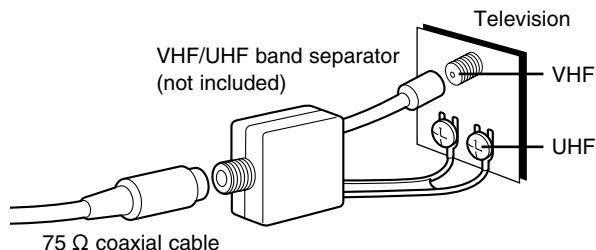

■ **If it is a screw type terminal**

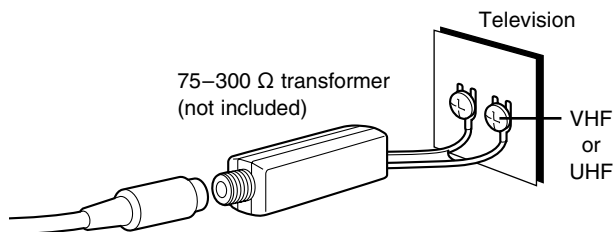

■ **If it is a double screw type terminal**

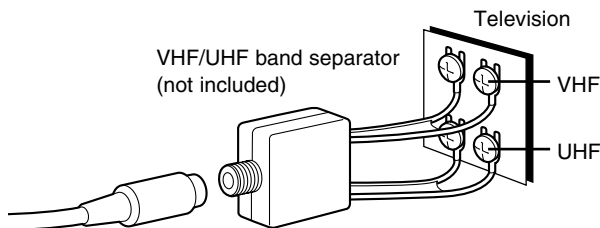

■ **If it is a complex TV terminal**

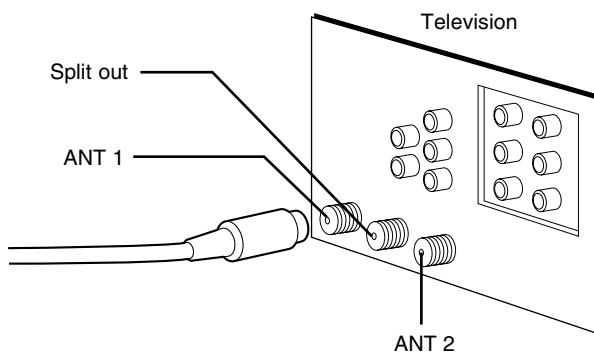

● Connect to one of the ANT terminals and select the same antenna number on the television.

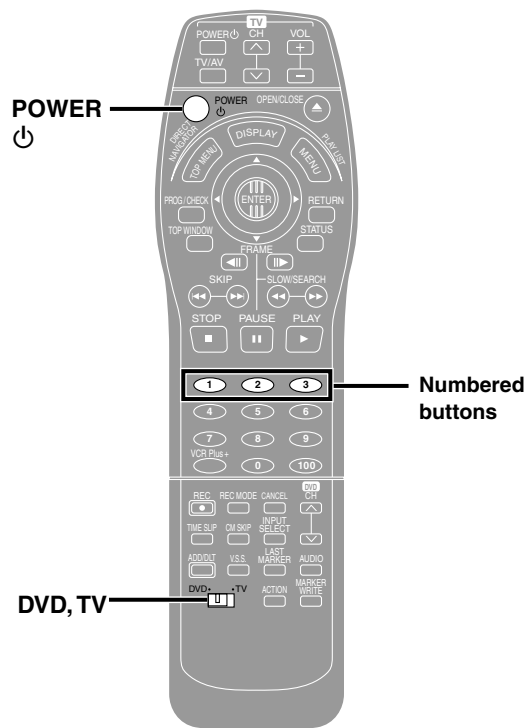

Operating other Panasonic DVD equipment with the remote control



By changing the remote control code, you can operate other DVD recorders and players **manufactured by Panasonic**. Most of the DVD recorders and players manufactured by Panasonic use the same system for their remote controls, so if you operate them in the same place, the controls can be confused by the different pieces of equipment. Use the following procedure to change the remote control code to solve this problem.

- Use “1”, the factory set code, under normal circumstances.

Be sure to set the same remote control code on the main unit as you did for the remote control itself (➔ page 82, ACTION—Set Up—Remote Control Code).

Preparation

- Switch [DVD, TV] to “DVD”.
- Change the code on the main unit.

Press [⏻, POWER] and the numbered buttons corresponding to the code you want to set, [1], [2], or [3], at the same time.

Note

- The following display appears on the unit's display if its code and the remote control's code are different. Change the remote control's code to suit the unit.



The unit's remote control code





- The display disappears after about 5 seconds.





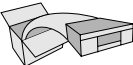

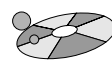





Summary of settings

This chart shows the initial settings for this unit. See page 85 for details on menu operation.

• Underlined items are the factory presets.

Main menus	Menus	Options
Set Up 	Off Timer  Select how long the unit remains on when it is not being used.	• 2 hr • <u>6 hr</u> • Off
	Remote Control Code  Change the remote control code so you can use other Panasonic DVD equipment at the same time.	• <u>Set Code 1</u> • Set Code 2 • Set Code 3
	Clock Settings	
	• Auto Clock Setting (⇒ page 87) The unit adjusts the clock automatically.	
	• Manual Clock Setting (⇒ page 88) You can adjust the clock.	
	• Time Zone Adjust (⇒ page 89) Adjust the time zone if it was not set correctly after auto clock setting. This appears only after auto clock setting is complete.	• -1 • <u>0</u> • +1
	Channel Settings	
	• Antenna System (⇒ page 90) Select to suit the type of antenna you are using. Channels are set corresponding to the antenna system you select.	• TV • <u>CATV</u>
• Auto Channel Setting (⇒ page 91) The unit sets the channels automatically.		
• Preset Channel Caption • Manual Channel Caption (⇒ page 92) Give captions to the channels.		
• VCR Plus+ CH Setting (⇒ page 19) Set the guide channels for use with VCR Plus+ timer recording.		
Re-initialize Setting This returns all values in the ACTION menus, except for the clock, channels, ratings level, and display language, to the default settings.	• Yes • <u>No</u>	
Disc 	Audio (⇒ page 84) Choose the preferred audio language.	• <u>English</u> • French • Spanish • Original • Other *****
	Subtitle (⇒ page 84) Choose the preferred subtitle language.	• <u>Automatic</u> • English • French • Spanish • Other *****
	Menus (⇒ page 84) Choose the preferred language for disc menus.	• <u>English</u> • French • Spanish • Other *****
	Ratings (⇒ page 86) Set a ratings level to limit DVD-Video play.	Setting ratings (When level 8 is selected) 8 <u>No Limit</u> : All DVD-Video can be played. 1 to 7: Prohibits play of DVD-Video with corresponding ratings recorded on them. 0 Lock All: Prohibits play of all DVD-Video. Changing ratings (When level 0–7 is selected) • Unlock Recorder • Change Level • Change Password • Temporary Unlock
Video 	3-D Y/C Separation (⇒ page 84) Turn 3-D Y/C separation on or off.	• <u>On</u> • Off
	Hybrid VBR Resolution (⇒ page 84) Switch between automatic and fixed hybrid VBR resolution when recording.	• <u>Automatic</u> • Fixed
	Still Mode (⇒ page 84) Select the type of picture shown when you pause play.	• <u>Automatic</u> • Field • Frame
	Black Level Control (⇒ page 84) Change the black level of the picture.	• <u>Lighter</u> • Darker
	Seamless Play (⇒ page 84) Turn seamless play on or off on discs with play lists.	• <u>On</u> • Off

Main menus	Menus	Options
Audio 	Audio during Search RAM DVD-R DVD-V VCD Choose whether to have sound during the first level of fast-forward.	<input type="radio"/> On <input type="radio"/> Off
	D. Range Compression DVD-V (Dolby Digital only) Change the dynamic range for late night viewing.	<input type="radio"/> On <input type="radio"/> Off
	MTS Selection for DVD-R Disc (⇒ page 35) Select whether to record the main or secondary audio type (SAP) to DVD-R. 	<input type="radio"/> Main <input type="radio"/> SAP
	PCM Down Conversion (⇒ page 86) Choose whether to convert 96-kHz LPCM signals to 48-kHz/16 bit.	<input type="radio"/> On <input type="radio"/> Off
	Dolby Digital (⇒ page 86) Choose whether to output Dolby Digital bitstream signals for decoding on other equipment or to convert them to PCM signals for 2-channel output.	<input type="radio"/> Bitstream <input type="radio"/> PCM
	DTS (⇒ page 86) Choose whether to output DTS bitstream signals for decoding on other equipment or to not output signals at all.	<input type="radio"/> Bitstream <input type="radio"/> Off
Display 	Status Messages  Choose whether to show on-screen messages automatically or not.	<input type="radio"/> Automatic <input type="radio"/> Off
	Blue Background  Select "Off" if you do not want to have the unit show the blue background when reception is weak.	<input type="radio"/> On <input type="radio"/> Off
	Language of Display Message Choose the preferred language for these menus and the on-screen messages.	<input type="radio"/> English <input type="radio"/> Français
	FL Display (⇒ page 84)  Changes the brightness of the unit's display.	<input type="radio"/> Bright <input type="radio"/> Dim <input type="radio"/> Dim during DVD/VCD Play
TV Screen 	TV Aspect (⇒ page 21)  Choose the setting to suit your television.	<input type="radio"/> 4:3 <input type="radio"/> 16:9
	4:3 TV Settings for DVD-Video (⇒ page 84)  Select how video from DVD-Video is shown on a 4:3 standard aspect television.	<input type="radio"/> Pan&Scan <input type="radio"/> Letterbox
	4:3 TV Settings for DVD-RAM (⇒ page 84)  Select how video from DVD-RAM is shown on a 4:3 standard aspect television.	<input type="radio"/> 4:3 <input type="radio"/> Pan&Scan <input type="radio"/> Letterbox

Summary of settings

■ Disc—Audio, Subtitle and Menus DVD-V

Original: The original language of each disc will be selected.
Other **:** Input a code number with the numbered buttons (➡ see below).

Automatic: If the language selected for "Audio" is not available, subtitles of that language will automatically appear if available on that disc.

• Some discs are designed to start in a certain language despite any changes you make here.

■ Video—3-D Y/C Separation

On: Reduces noise for recording by separating the luminance (Y) and color (C) signals received from the television station.

Off: Reduces the ghosting that occurs when recording fast moving images.

■ Video—Hybrid VBR Resolution

Automatic: The unit automatically switches resolution rates during recording. The unit reduces block noise, which occurs during MPEG compression, by selecting the optimum rate.

Fixed: The resolution rate is fixed during recording. This ensures the resolution rate is not reduced.

■ Video—Still Mode

Field: Less blurred field stills are shown. Select if jittering occurs when "Automatic" is selected.

Frame: Sharper frame stills are shown. Select if small text or fine patterns cannot be seen clearly when "Automatic" is selected.

■ Video—Black Level Control

Lighter: when connected to a TV through the VIDEO OUT or S VIDEO OUT terminal.

Darker: when connected to a TV through the COMPONENT VIDEO OUT (Y/P_B/P_R) terminals.

■ Video—Seamless Play

On: The scenes in play lists created with this unit are played seamlessly. This may cause shifting of the points where scenes change. Some play lists cannot be played seamlessly.

Off: The points where scenes in play lists are played accurately, but this may cause the picture to freeze for a moment when scenes change.

■ Display—FL Display

Dim during DVD/VCD play: The unit's display dims during play of discs with video recorded. (The TIME SLIP indicator is off while the display is dimmed.)

■ TV Screen—4:3 TV Settings for DVD-Video

Pan&Scan: Video recorded for a widescreen is played with the sides cut off if the pan & scan was specified by the producer of the disc. 16:9 software prohibited from being shown in the pan and scan style will appear in the letterbox style (with black bands above and below the picture) despite the setting here.

Letterbox: Video recorded for a widescreen is played in the letterbox style.

■ TV Screen—4:3 TV Settings for DVD-RAM

4:3: Programs played as recorded.

Pan&Scan: Video recorded for a widescreen is played as pan & scan.

Letterbox: Video recorded for a widescreen is played in the letterbox style.

Language code list

Abkhazian: 6566	Chinese: 9072	Hausa: 7265	Lithuanian: 7684	Romanian: 8279	Telugu: 8469
Afar: 6565	Corsican: 6779	Hebrew: 7387	Macedonian: 7775	Russian: 8285	Thai: 8472
Afrikaans: 6570	Croatian: 7282	Hindi: 7273	Malagasy: 7771	Samoan: 8377	Tibetan: 6679
Albanian: 8381	Czech: 6783	Hungarian: 7285	Malay: 7783	Sanskrit: 8365	Tigrinya: 8473
Ameharic: 6577	Danish: 6865	Icelandic: 7383	Malayalam: 7776	Scots Gaelic: 7168	Tonga: 8479
Arabic: 6582	Dutch: 7876	Indonesian: 7378	Maltese: 7784	Serbian: 8382	Turkish: 8482
Armenian: 7289	English: 6978	Interlingua: 7365	Maori: 7773	Serbo-Croatian: 8372	Turkmen: 8475
Assamese: 6583	Esperanto: 6979	Irish: 7165	Marathi: 7782	Shona: 8378	Twì: 8487
Aymara: 6588	Estonian: 6984	Italian: 7384	Moldavian: 7779	Sindhi: 8368	Ukrainian: 8575
Azerbaijani: 6590	Faroese: 7079	Japanese: 7465	Mongolian: 7778	Singhalese: 8373	Urdu: 8582
Bashkir: 6665	Fiji: 7074	Javanese: 7487	Nauru: 7865	Slovak: 8375	Uzbek: 8590
Basque: 6985	Finnish: 7073	Kannada: 7578	Nepali: 7869	Slovenian: 8376	Vietnamese: 8673
Bengali; Bangla: 6678	French: 7082	Kashmiri: 7583	Norwegian: 7879	Somali: 8379	Volapük: 8679
Bhutani: 6890	Frisian: 7089	Kazakh: 7575	Oriya: 7982	Spanish: 6983	Welsh: 6789
Bihari: 6672	Galician: 7176	Kirghiz: 7589	Pashto, Pushto: 8083	Sundanese: 8385	Wolof: 8779
Breton: 6682	Georgian: 7565	Korean: 7579	Persian: 7065	Swahili: 8387	Xhosa: 8872
Bulgarian: 6671	German: 6869	Kurdish: 7585	Polish: 8076	Swedish: 8386	Yiddish: 7473
Burmese: 7789	Greek: 6976	Laotian: 7679	Portuguese: 8084	Tagalog: 8476	Yoruba: 8979
Byelorussian: 6669	Greenlandic: 7576	Latin: 7665	Punjabi: 8065	Tajik: 8471	Zulu: 9085
Cambodian: 7577	Guarani: 7178	Latvian, Lettish: 7686	Quechua: 8185	Tamil: 8465	
Catalan: 6765	Gujarati: 7185	Lingala: 7678	Rhaeto-Romance: 8277	Tatar: 8484	

Common procedures

Refer to the summary of settings table on page 82 and use the following procedure to change the settings if necessary.

Preparation

Switch [DVD, TV] to "DVD".

1 While stopped

Press [ACTION] to show the menus.

- You can also press [TOP WINDOW] and use the joystick [▲, ▼, ◀, ▶] to select "ACTION" and press [ENTER].

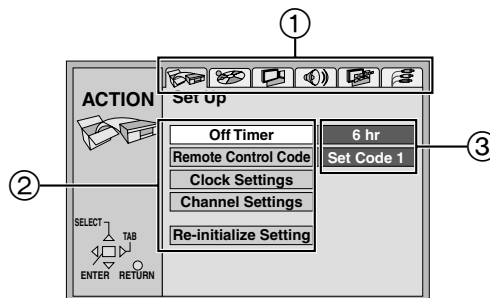

- ① **Menus**
The Action menu is made up of six menus—Set Up, Disc, Video, Audio, Display, and TV Screen. Select the menu's tab to display the items.
- ② **Items**
A list of items in the menu you selected.
- ③ **Options**
This shows the current settings. The options are shown when you select an item.

2 Use the joystick [◀, ▶] to select the menu's tab.

3 Use the joystick [▲, ▼] to select the item you want to change and press [ENTER].

4 Use the joystick [▲, ▼] to select the option and press [ENTER].

- Some options require different operations. Follow the on-screen instructions and the instructions described later.

■ To return to the previous screen

Press [RETURN]. Even if you have changed an option, the change is not accepted unless you press [ENTER].

■ When you are finished

Press [ACTION].

For your reference

The unit retains these settings in its memory until you change them, even if you turn it off.



DVD, TV ACTION

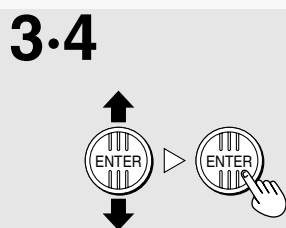
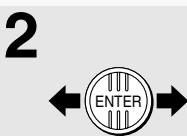

Entering a password



You can limit play of DVDs unsuitable for some audiences. Play and changes to the settings are not possible unless you enter a password.

When setting ratings

The password screen is shown when you select levels 0 to 7.

- Input a 4-digit password with the numbered buttons.
 - If you enter a wrong number, press [CANCEL] to erase it before you press [ENTER].

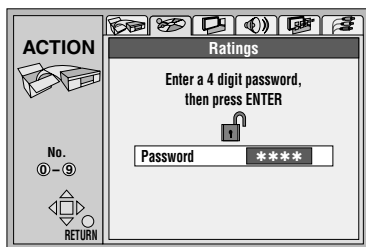

Do not forget your password.

- Press [ENTER].
- Press [ENTER].

The password is entered and the unit is locked.

Now, when you insert a DVD-Video that exceeds the ratings limit you set, a message appears on the television. Follow the on-screen instructions.

When changing ratings

The password screen is shown when you select "Ratings".

- Input your 4-digit password with the numbered buttons and press [ENTER].

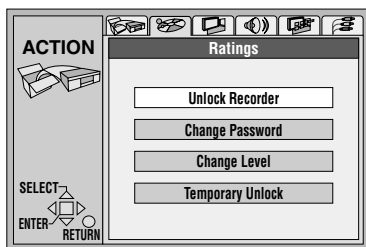

- Unlock Recorder:** To unlock the unit and return the rating to 8
- Change Password:** To change your password
- Change Level:** To change the rating level
- Temporary Unlock:** To temporarily unlock the unit (the unit locks again if you switch it to standby or open the disc tray)

- Select the item with the joystick [▲, ▼] and press [ENTER]. Actual screens depend on the operation. Follow the on-screen instructions.

Digital output

Change these settings when you have connected equipment through this unit's OPTICAL DIGITAL AUDIO OUT terminal.

PCM Down Conversion

Off (factory setting):

When you have used audio cables to connect the unit to other equipment (analog connection **C** → page 78).

On:

When you have used an optical digital cable to connect the unit to other equipment (digital connection **B** → page 78). Output is limited to 48 kHz/16 bit.

Output of audio with a sampling frequency of 96 kHz

Audio is output as follows in accordance with the connections and settings you make.

Connection \ Setting	B (digital)	C (analog)
Off	No output*1	Output as 96 kHz
On	Converted and output as 48 kHz/16 bit	Converted and output as 48 kHz

*1 96 kHz audio is output if the DVD is unprotected, but the connected equipment must be able to handle such signals in order to play them.

Dolby Digital

Bitstream (Factory preset):

When you have connected a unit with a built-in Dolby Digital decoder.

PCM:

When you have connected a unit that doesn't have a built-in Dolby Digital decoder.*2

DTS

Off (Factory preset):

When you have connected a unit that doesn't have a built-in DTS decoder.*2

Bitstream:

When you have connected a unit with a built-in DTS decoder.

*2 Set "Dolby Digital" to "PCM" and "DTS" to "Off" if the other equipment doesn't have decoders. Incorrect settings can cause noise to be output which can be harmful to your ears and speakers, and audio will not be recorded properly to digital recording equipment.

Changing the unit's settings

Preparation

Switch [DVD, TV] to "DVD".

Clock Settings

Auto Clock Setting



- 1 While stopped
Press [ACTION].
The ACTION screen appears.
- 2 Use the joystick [◀, ▶] to select the Set Up tab.
- 3 Use the joystick [▲, ▼] to select "Clock Settings" and press [ENTER].

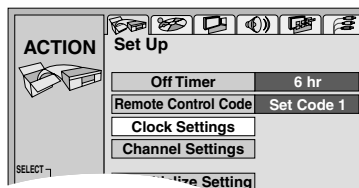

- 4 Use the joystick [▲, ▼] to select "Auto Clock Setting" and press [ENTER].

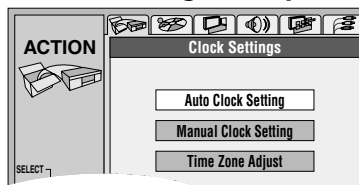

▽ When you press [ENTER]

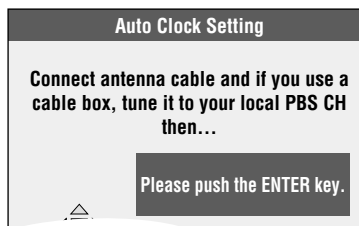

If channel setting is complete, the "Auto Clock Setting" screen appears. If you have not yet set channels, the "Auto Channel/Clock Setting" screen appears.

- 5 Press [ENTER].
Auto clock setting (or auto channel and auto clock setting) starts. This can take some time, up to a few hours in some cases. The following screen appears when setting is complete.

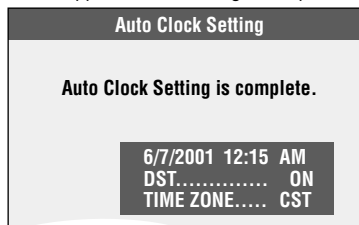

- Check that the time was set correctly. If it was not, use manual clock setting (⇒ page 88) or time zone adjust (⇒ page 89) to correct it.
- If you connect the unit through a cable TV box or DSS receiver (⇒ page 76), tune to your local PBS station before starting auto clock setting. Use manual clock setting (⇒ page 88) if this does not work.
- If there is no local PBS channel in your area, then auto clock setting may not work correctly.
In this case the time must be set manually (⇒ page 88).

Note

- DST, Daylight Saving Time, shows the summertime setting (⇒ page 88).
- TIME ZONE shows the time difference from Greenwich meantime (GMT) (⇒ page 88).
EST=GMT -5, CST=GMT -6, MST=GMT -7, PST=GMT -8,
AST=GMT -9, HST=GMT -10.
For other areas: xx hr
- When you change the time zone, the recording times for programs recorded before the time zone was changed also change to correspond to the new time zone.

To stop auto clock setting

Press [RETURN].

2.3.4.5

DVD, TV

RETURN

1

1



2



3.4

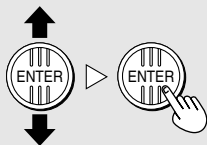

5



Preparation

Switch [DVD, TV] to "DVD".

Clock Settings

Manual Clock Setting



- 1 Press [ACTION].**
The ACTION screen appears.
- 2 Use the joystick [◀, ▶] to select the Set Up tab.**
- 3 Use the joystick [▲, ▼] to select "Clock Settings" and press [ENTER].**

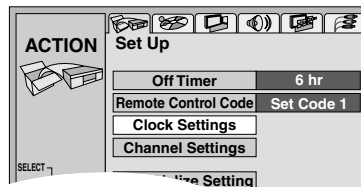

- 4 Use the joystick [▲, ▼] to select "Manual Clock Setting" and press [ENTER].**

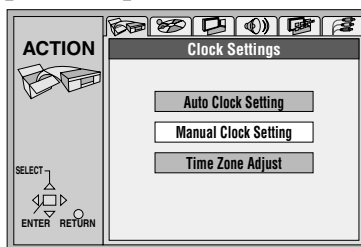

- 5 Use the joystick [◀, ▶] to select the item you want to change and use the joystick [▲, ▼] to change the setting.**

The items change as follows:
 MONTH ↔ DAY ↔ YEAR ↔ HOUR
 ↑ TIME ZONE ↔ DST ↔ MINUTE ↔

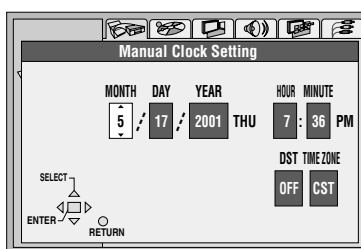

HOUR: 12-hour display
 DST (Daylight Saving Time): ON or OFF

If you select "ON", the clock is advanced one hour starting at 2 a.m. on the first Sunday in April and ending at 2 a.m. on the last Sunday in October.

TIME ZONE:
 EST ↔ CST ↔ MST ↔ PST ↔ AST ↔ HST
 (-5) (-6) (-7) (-8) (-9) (-10)

Repeat step 5 as necessary.

- 6 Press [ENTER].**
The "Clock Settings" screen (→ step 4) reappears and the clock starts.

Note

- When you change the time zone, the recording times for programs recorded before the time zone was changed also change to correspond to the new time zone.

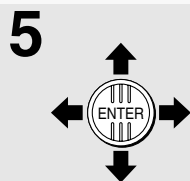
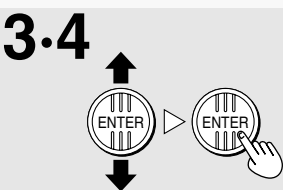
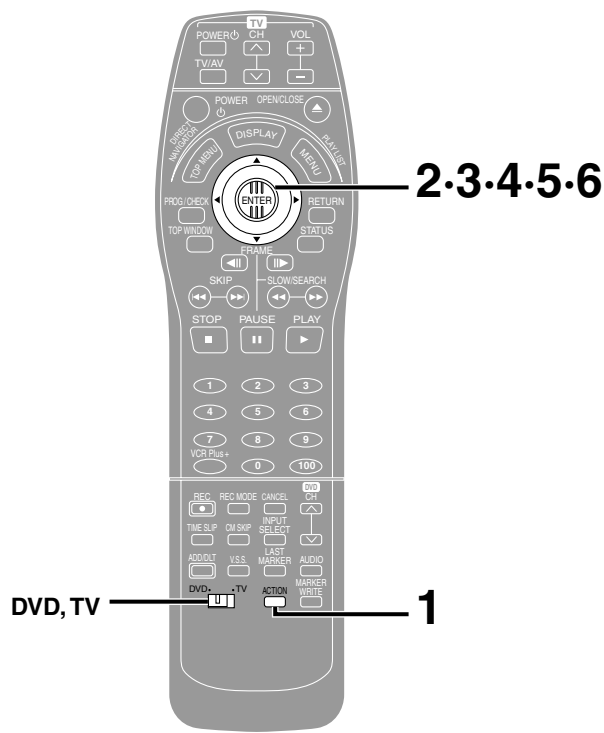



Time Zone Adjust

Adjust the time zone (-1 or +1) if it was not set correctly with auto clock setting.

You cannot change this setting if you set the clock manually.

- 1** Press [ACTION].
The ACTION screen appears.
- 2** Use the joystick [◀, ▶] to select the Set Up tab.
- 3** Use the joystick [▲, ▼] to select "Clock Settings" and press [ENTER].

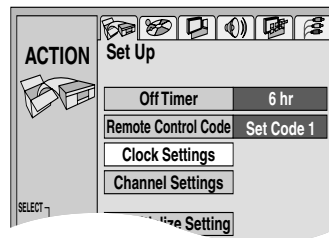

- 4** Use the joystick [▲, ▼] to select "Time Zone Adjust" and press [ENTER].

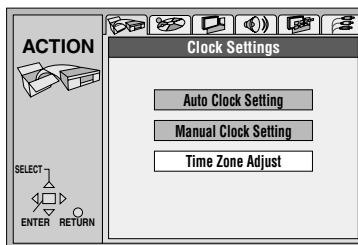

▽ When you press [ENTER]

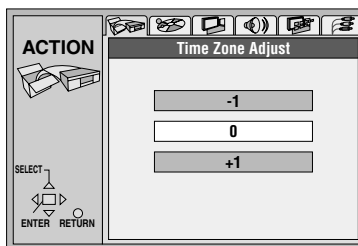

- 5** Use the joystick [▲, ▼] to select "-1", "0", or "+1" and press [ENTER].

The "Clock Settings" screen (→ step 4) reappears.

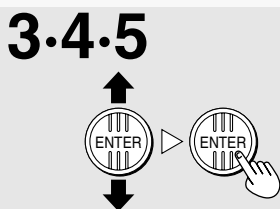
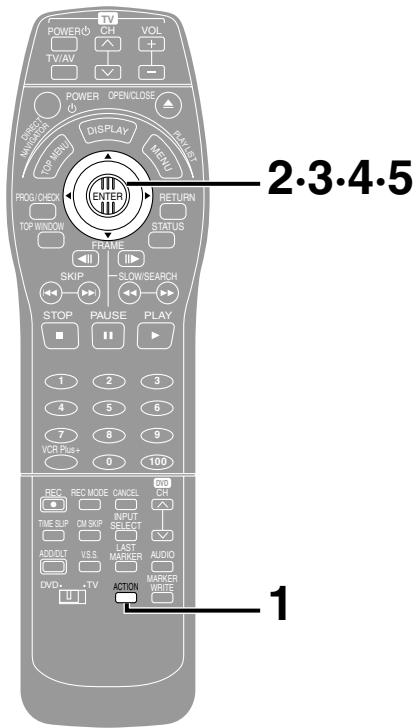

Preparation

Switch [DVD, TV] to "DVD".

Channel Settings

Antenna System



The following settings must be reset when you change the antenna system.

VCR Plus+ guide channel settings (⇒ page 19)

Auto channel setting (⇒ page 91)

Channel captions (⇒ page 92)

- 1 Press [ACTION].**
The ACTION screen appears.
- 2 Use the joystick [◀, ▶] to select the Set Up tab.**
- 3 Use the joystick [▲, ▼] to select "Channel Settings" and press [ENTER].**

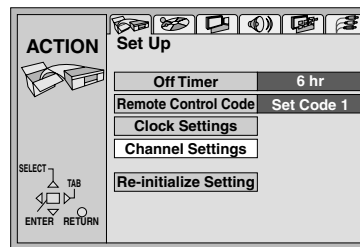

- 4 Use the joystick [▲, ▼] to select "Antenna System" and press [ENTER].**

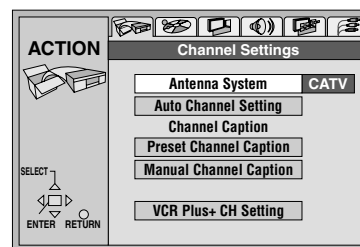

- 5 Use the joystick [▲, ▼] to select "TV" or "CATV" and press [ENTER].**

TV: TV broadcast (2CH–69CH)
CATV: CATV broadcast (1CH–125CH)

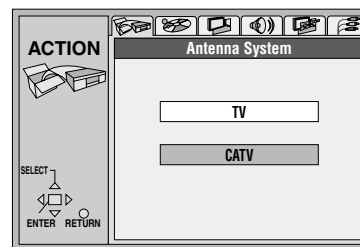

The screen shown in step 4 reappears.

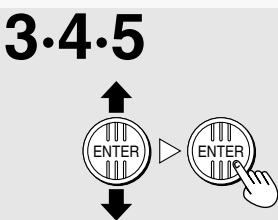
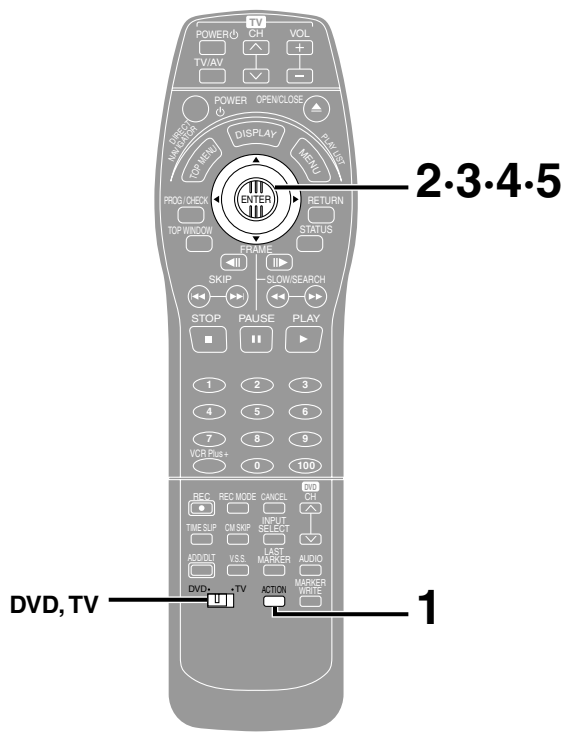



Auto Channel Setting

You can use the ACTION menus to start Auto Channel Setting if Plug-in Auto Tuning (▶ page 16) fails for some reason.

- 1 Press [ACTION].
The ACTION screen appears.
- 2 Use the joystick [◀, ▶] to select the Set Up tab.
- 3 Use the joystick [▲, ▼] to select "Channel Settings" and press [ENTER].

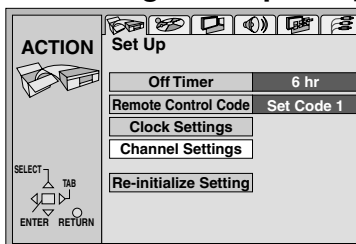

- 4 Use the joystick [▲, ▼] to select "Auto Channel Setting" and press [ENTER].

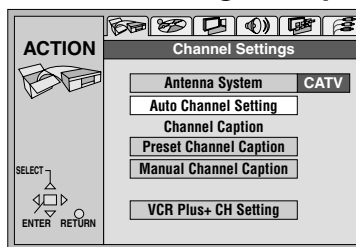

Check the antenna system. Automatic setting is performed based on the current antenna system.

▽ When you press [ENTER]

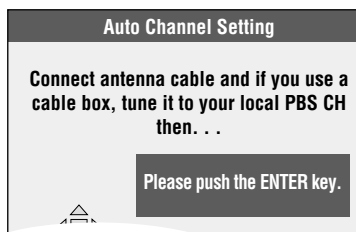

If clock setting is complete, the "Auto Channel Setting" screen appears. If you have not yet set clock, the "Auto Channel/Clock Setting" screen appears.

- 5 Press [ENTER].

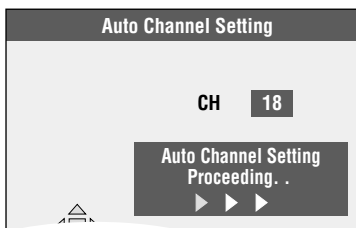

▽ When finished

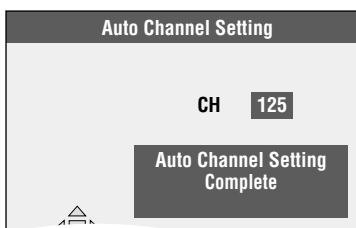

Auto channel setting (or auto channel and auto clock setting) starts. This takes a few minutes. When finished, the Complete screen or time display is shown. Press [ENTER].

•The channels are set based on the currently selected antenna system.

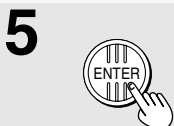
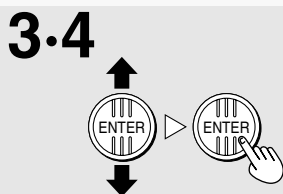
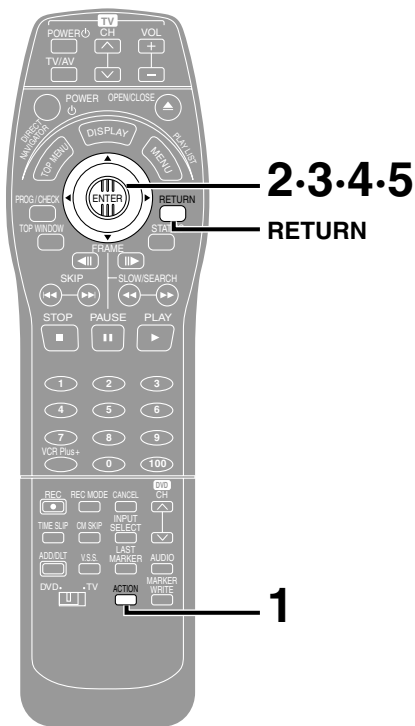

■ To stop auto channel setting

Press [RETURN].

Preparation

Switch [DVD, TV] to "DVD".



Channel Settings

Channel Caption

You can give stations captions. You can use the Preset Captions, or manually enter new ones yourself.

The captions you enter are displayed when the channel is displayed and in the direct navigator screen.

- 1 Press [ACTION].**
The ACTION screen appears.
- 2 Use the joystick [◀, ▶] to select the Set Up tab.**
- 3 Use the joystick [▲, ▼] to select "Channel Settings" and press [ENTER].**

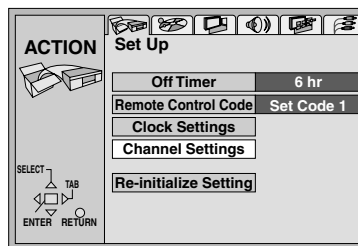

- 4 Use the joystick [▲, ▼] to select "Preset Channel Caption" or "Manual Channel Caption" and press [ENTER].**

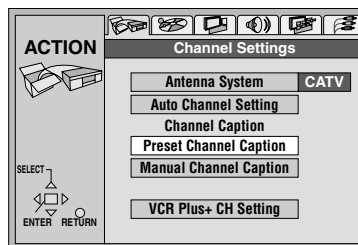

- 5 If you selected "Preset Channel Caption"**

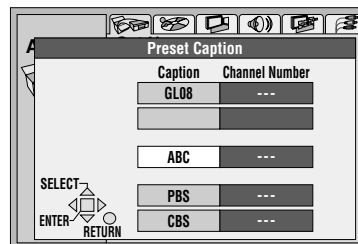

- ① Use the joystick [▲, ▼] to select the caption and then move the joystick [▶].**

You can choose from the following captions.
 ABC, PBS, CBS, CNN, FOX, ESPN, NBC, HBO, A&E, AMC, FAM, MAX, MTV, SHOW, TBS, USA, TNT, CBC, UPN, CTV, WB, TSN, DSC, GLOB

(Continued on next page)

2-3-4-5

DVD, TV

1

1



2



3-4

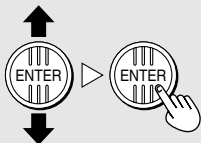

5

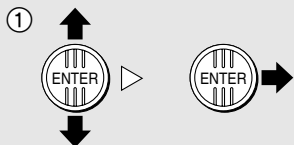

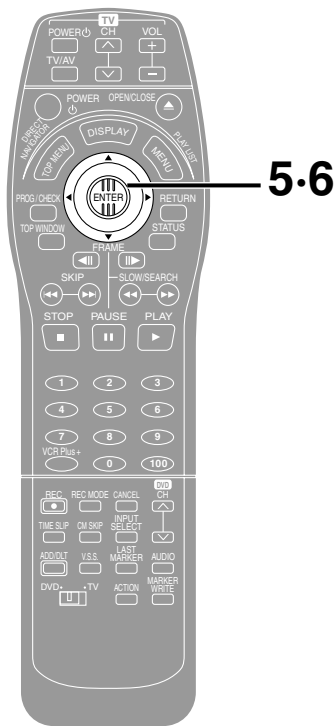

- Use the joystick [▲, ▼] to select the channel corresponding to the caption and then move the joystick [◀].

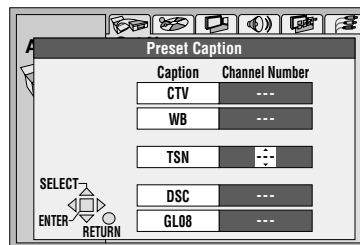

•Channels are not displayed if they do not contain a station or if captions have been added manually.
Repeat steps ① and ② as necessary.

5 If you selected "Manual Channel Caption"

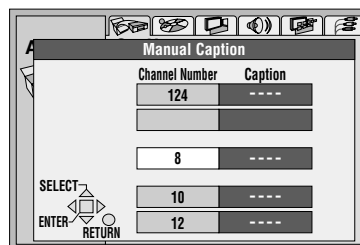

- Use the joystick [▲, ▼] to select the channel and then move the joystick [▶].
- Use the joystick [▲, ▼] to select the first character and then move the joystick [▶].

You can choose from the following characters:
A-Z, 0-9, -, &, !, /, (space)
Repeat this step to enter the other characters.

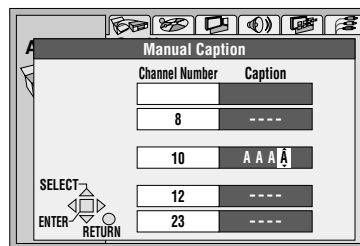

- Press [◀] to return to the Channel Number column when you are finished.

Repeat steps ①, ②, and ③ as necessary.

6 Press [ENTER].

The screen shown in step 4 reappears.

5

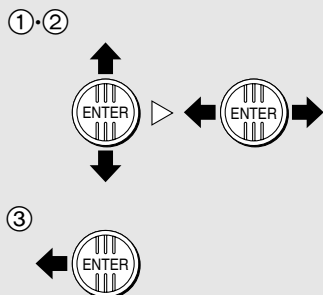

6



For your reference

In step 5-①, the screen scrolls a page at a time if you hold the joystick up or down before pressing [ENTER].

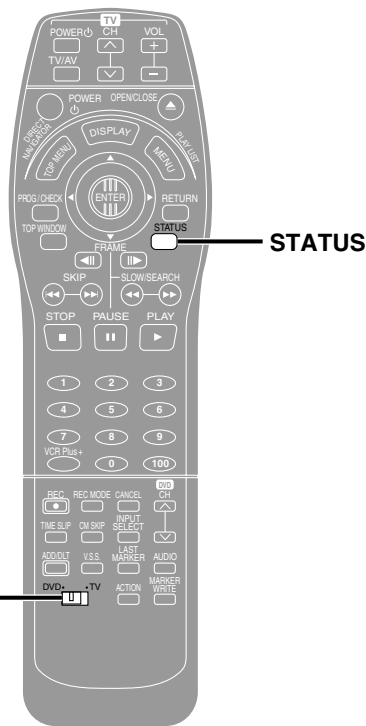

DVD, TV

STATUS

A

STATUS



B

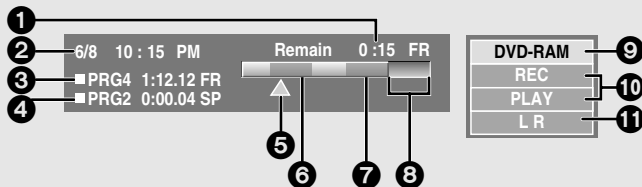

A Changing the information displayed

Displays appear on the television when you operate the unit to let you know what operation was performed and what condition the unit is in.

- You can change the setting in the ACTION menu so these displays do not appear automatically (➔ page 83, Display—Status Messages).

Remote control only

Preparation

Switch [DVD, TV] to “DVD”.

Press [STATUS] to change the information displayed.

The display changes each time you press the button.

For example, DVD-RAM

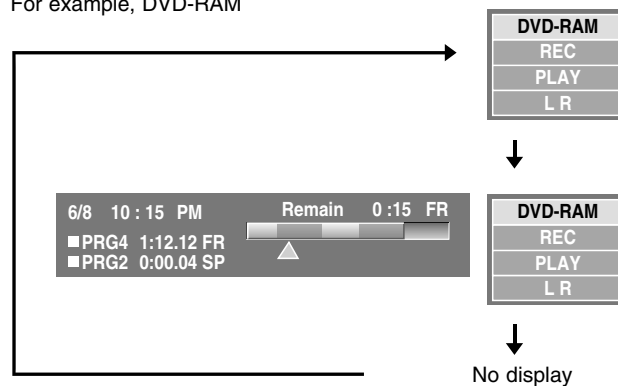

B Display examples

- Available recording time and recording mode
- The current date and time
- Recording information
 - Shows the program number, elapsed time, and recording mode.
- Play information
 - Shows the program number, elapsed time, and recording mode.
- Play position
- Program being played (green)
- Program being recorded (red)
- Available time on disc
- Current media
- Current recording or play status/input channel and caption (if entered)
 - Shows the current state of the unit or input channel and caption (if entered).
 - REC: Recording
 - PAUSE: Recording paused
 - PLAY: Playing
 - II: Playing paused
 - ◀◀: Rewinding (5 speeds)
 - ▶▶: Fast forwarding (5 speeds)
 - ▶: Slow-motion (5 speeds)
 - ◀: Reverse slow-motion (5 speeds)
- Audio type (➔ page 34)
 - Shows the selected audio type.
 - During reception
 - Stereo: Stereo is selected
 - Mono: Monaural is selected
 - SAP: Secondary audio program is selected (“(((” appears when the type you have selected is actually being received.)
 - During play
 - LR, R, L: a stereo program is recorded
 - MAIN, SAP: an MTS program is recorded

Specifications

Power supply:	AC 120 V, 60 Hz
Power consumption:	35 W
Recording system:	DVD video recording standards (DVD-RAM), DVD video standards (DVD-R)
Optical pick-up:	System with 1 lens, 2 integration units (662 nm wavelength for DVDs, 790 nm wavelength for CDs)
Recordable discs:	12 cm 4.7 GB DVD-RAM discs 12 cm 9.4 GB DVD-RAM discs 8 cm 2.8 GB DVD-RAM discs 12 cm 4.7 GB DVD-R discs (for General Ver. 2.0)
Recording time:	Max. 6 hours (using 4.7 GB disc) XP: 60 minutes SP: 120 minutes LP: 240 minutes EP: 360 minutes
Discs played:	12 cm 4.7 GB DVD-RAM discs 12 cm 9.4 GB DVD-RAM discs 8 cm 2.8 GB DVD-RAM discs 12 cm 4.7 GB DVD-R discs (for General Ver. 2.0) DVD-VIDEO discs CD-Audio discs (CD-DA) Video CD discs CD-R/CD-RW discs (CD-DA, Video CD formatted discs)
Video system	
TV system:	NTSC system, 525 lines, 60 fields
Recording system:	MPEG2 (Hybrid VBR)
Input:	LINE (pin jack), 1.0 Vp-p; 75 Ω S connector Y: 1.0 Vp-p; 75 Ω C: 0.286 Vp-p; 75 Ω
Output:	LINE (pin jack), 1.0 Vp-p; 75 Ω S connector Y: 1.0 Vp-p; 75 Ω C: 0.286 Vp-p; 75 Ω
Component video output 525i:	Y: 1.0 Vp-p; 75 Ω Pb: 0.7 Vp-p; 75 Ω Pr: 0.7 Vp-p; 75 Ω
Antenna reception input:	TV Channel: 2ch–69ch, 75 Ω CATV Channel: 1ch–125ch, 75 Ω

Audio system	
Recording system:	Dolby Digital
Input:	LINE (pin jack) Reference input: 309 mVrms FS: 2 Vrms (1 kHz, 0 dB) Input impedance: 47 kΩ
Output:	LINE (pin jack) Reference output: 309 mVrms FS: 2 Vrms (1 kHz, 0 dB) Output impedance: 1 kΩ (Load impedance: 10 kΩ)
Number of channels:	Recording: 2 channels Playback: 2 channels
Other input/output connectors:	Digital audio optical output connector
Dimensions:	Approx. 430 (W)×120 (H)×351 (D) mm [Approx. 16 ¹⁵ / ₁₆ " (W)×4 ³ / ₄ " (H)×13 ⁷ / ₈ " (D)] (excluding protrusions)
Mass:	Approx. 5.6 kg (12.36 lbs)
Operating temperature range:	5 °C–40 °C (41 °F–104 °F)
Operating humidity range:	10 %–80 % RH (no condensation)
Clock unit:	Quartz-controlled 12-hour digital display

LASER Specification

Class I LASER Product

Wave length:	775–815 nm 655–666 nm
Laser power:	No hazardous radiation is emitted with the safety protection.

Power consumption in standby mode: approx. 5 W

Note

Specifications are subject to change without notice.
Mass and dimensions are approximate.

Bitstream

This is the compressed form of digital signals. A decoder decodes these signals into 5.1 surround and multi-channel signals.

Channel (when referring to DVD)

Sound is divided into channels based on the sound's role.

For example, 5.1 channel

- Front speakers—1 left channel and 1 right channel
- Center speaker—1 channel
- Surround speakers—1 left channel and 1 right channel
- Subwoofer—1 channel×0.1 (the ratio of bass to the total amount of sound output)

Examples as shown in the on-screen menus

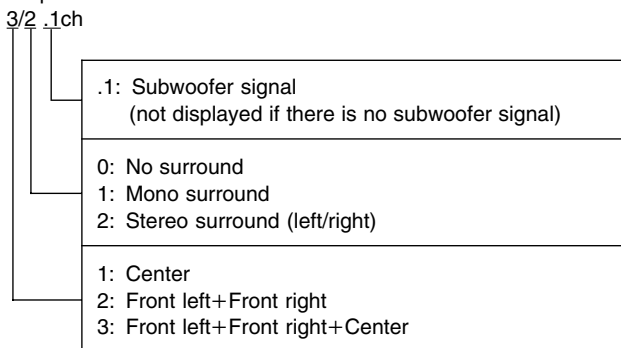

Component video output (Y, P_B, P_R)

The luminance (Y) and color difference (P_B and P_R) signals are separated for output so colors are reproduced faithfully. The output form differs from that for 480P progressive output.

Decoder

A decoder restores the coded audio and video signals on DVDs to normal. This is called decoding.

Direct navigator

This is a list of programs you have recorded. You can select programs from the list to view. The list also shows the date and time of recording, the channel, and the titles of titled programs. The selected program is played in the background, making selection even simpler.

Dolby Digital

This is a method of coding digital signals developed by Dolby Laboratories. Apart from stereo (2-channel) audio, these signals can also be 5.1-channel audio. A large amount of audio information can be recorded on one disc using this method.

Dolby Pro Logic

A surround system where a 4-channel audio track is recorded as 2 channels and then is restored to 4 channels for play. The surround channel is monaural.

DTS Digital Surround

This surround system is used in many movie theaters around the world. The separation between channels is good and the compression ratio is low, so realistic sound effects are possible.

DTS soundtracks are produced with the assumption that all channels will be used.

Dynamic range

Dynamic range is the difference between the lowest level of sound that can be heard above the noise of the equipment and the highest level of sound before distortion occurs.

Finalize

This process allows DVD-R to be played on compatible equipment.

Frame and field

Frames are the still pictures that go together to make a moving picture. A frame is made up of two fields.

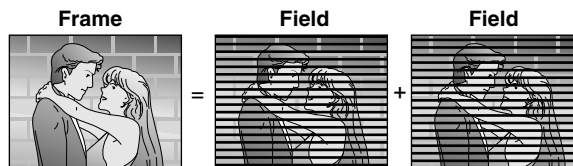

- A frame still is made up of two alternating fields, so the picture may appear blurred, but overall quality is high.
- A field still is not blurred, but it has only half the information of a frame still so picture quality is lower.

Linear PCM

This is a form of signal that has been digitized without compressing it. CDs are recorded with 44.1 kHz/16 bit PCM, while DVDs use PCM between 48 kHz/16 bit and 96 kHz /24 bit, allowing reproduction of greater quality sound.

The linear PCM signals output from the DIGITAL AUDIO OUT, OPTICAL terminal are stereo (2 channel).

Pan&Scan/Letterbox

In general, DVD-Video are produced with the intention that they be viewed on a widescreen television with an aspect ratio of 16:9. This means you can view most material with the intended aspect ratio on a widescreen television.

Material with this ratio will not fit onto a standard television with an aspect ratio of 4:3. Two styles of picture, "Pan&Scan" and "Letterbox", deal with this problem.

Pan&Scan: The sides are cut off so the picture fills the screen.



Letterbox: Black bands appear at the top and bottom of the picture so the picture itself appears in an aspect ratio of 16:9.



Playback control (PBC)

This is a method of playing video CDs. You can select parts to play by using menus recorded on the disc.

Play list

This is a collection of scenes. It enables you to play these scenes in succession or to select specific ones to play.

Program (PRG)

The section between the point where recording is started and the point where it is stopped.

Sampling frequency

This is the number of samples of sound taken per second during conversion to a digital signal. A high sampling frequency results in a sound close to the original when played back.

S video output

The color (C) and luminance (Y) signals are separated before being sent to the television, making for greater picture clarity.

Title/Chapter (DVD-Video)

DVD-Video are divided up into large sections, titles, and smaller sections, chapters. The numbers allocated to these sections are called title numbers and chapter numbers.

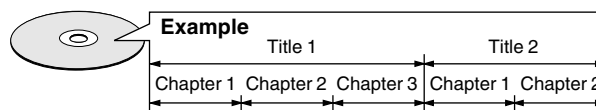

Track (Video CD/CD)

This is the smallest division on CD and Video CD, and usually equates to a single song.

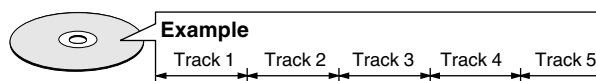

Maintenance

The precision parts in this unit are readily affected by the environment, especially temperature, humidity, and dust. Observe the following points to ensure continued listening and viewing pleasure.

To clean this unit, wipe with a soft, dry cloth.

- Never use alcohol, paint thinner or benzine to clean this unit.
- Before using chemically treated cloth, read the instructions that came with the cloth carefully.

Dust and dirt may adhere to the unit's lenses over time, possibly making it impossible to record or play discs.

Use the recommended **DVD-RAM/PD lens cleaner (LF-K123LCA1)** every 1 to 4 months, depending on frequency of use and the operating environment.

Read the lens cleaner's instructions carefully before use.

Disc handling

Do not use irregularly shaped discs, such as heart-shaped. (These can damage the unit.)

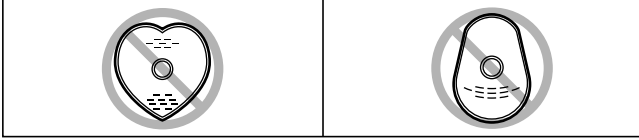

■ How to hold a disc

Do not touch the recorded surface.

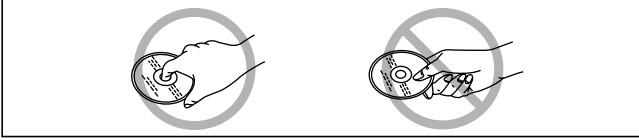

■ If there is dirt or condensation on the disc

Moisture may condense on discs after they are brought inside from the cold.

DVD-RAM and DVD-R

Clean and dry only with the DVD-RAM/PD disc cleaner available as an optional accessory, part number LF-K200DCA1. Do not use cleaners or cloths for CDs to clean DVD-RAM and DVD-R.

DVD-Video, Video CD, CD

Wipe with a damp cloth and then wipe dry.

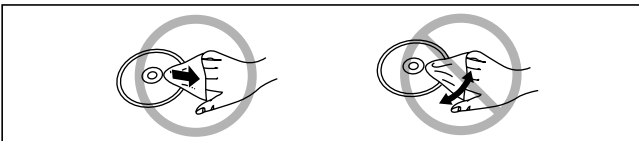

■ Handling precautions

- Do not write on the label side with a ball-point pen or other writing instrument.
- Do not use cleaning sprays, benzene, thinner, static electricity prevention liquids or any other solvent.
- Do not attach labels or stickers to discs. (Do not use discs with exposed adhesive from tape or left over peeled-off stickers.)
- Do not use scratch-proof protectors or covers.
- Do not use discs printed with label printers available on the market.
- Do not use discs that are badly warped or cracked. 

■ Do not place or store discs in the following places

- Locations exposed to direct sunlight
- Humid or dusty locations
- Locations directly exposed to a heat vent or heating appliance

Self-diagnosis





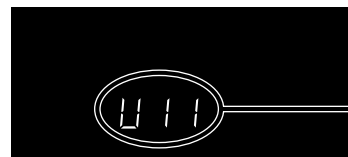

The service numbers ("U" followed by two digits) and messages shown in the table appear.

Reference pages are shown as black circled numbers .

Possible solutions are indicated with " " on the relative pages in the operating instructions.





Service number

Service number	Unit status	Solutions
U11	The disc is dirty or badly scratched.	<ul style="list-style-type: none"> • Follow the instructions in "Disc handling" to clean the disc if it is dirty.  • The disc cannot be played if it is scratched and this display doesn't disappear. 
	You have inserted a disc the unit cannot play or record on.	<ul style="list-style-type: none"> • Insert a disc the unit can play or record on. 
U14 	The unit is hot.	<ul style="list-style-type: none"> • The unit switches to standby automatically for safety reasons and you cannot operate it. Wait for about 30 minutes for the service number to disappear. • Select a position with good ventilation when installing the unit. • Do not block the cooling fan on the rear of the unit.
U99	The unit fails to operate properly.	<ul style="list-style-type: none"> • Press [⏻/I, POWER] to switch the unit to standby. Now press [⏻/I, POWER] again to turn the unit on.
CHK REMOTE	The remote control and main unit are using different codes.	<ul style="list-style-type: none"> • Change the code on the remote control or main unit. , 

Error messages

Reference pages are shown as black circled numbers ②.

Possible solutions are indicated with “” on the relative pages in the operating instructions.

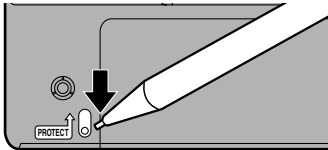
Error messages	Causes and solutions
No Disc.	<ul style="list-style-type: none"> You haven't inserted a disc. Correctly insert a disc that this unit can use. ② ②⑥ The disc is upside down. If it is a single-sided disc, insert it so the label is facing up. ②② ②⑥
This is non-recordable disc.	<ul style="list-style-type: none"> The unit cannot record on the disc you inserted. The unit cannot record onto finalized DVD-R, DVD-Video, CDs, or video CDs. Insert a DVD-RAM or unfinalized DVD-R. ⑥ ⑦ You inserted an unformatted DVD-RAM. Format the disc with this unit. ⑤④
This disc is not formatted properly. Please format the disc in 'DISC SETTING' to record.	
This disc cannot be read.	<ul style="list-style-type: none"> You inserted an incompatible disc. Insert a compatible disc. ⑥
Please check write protect tab on the disc. 	<ul style="list-style-type: none"> The write-protect tab on the cartridge is set to PROTECT. Use a ballpoint pen or similar to release the write protection. 
Contents of this disc are protected.	<ul style="list-style-type: none"> The program is write-protected. Release the protection with the direct navigator. ⑥① The disc is write-protected. Release the protection with the Disc Protection of DISC SETTING. ⑤③
Cannot finish recording completely.	<ul style="list-style-type: none"> The program was copy-guarded. The disc is full. Recording was not completed for some other reason.
Cannot record on the disc.	<ul style="list-style-type: none"> The disc is scratched. Use another disc. The disc is dirty. Clean the disc as described in these operating instructions. ⑨⑨
Please set clock.	<ul style="list-style-type: none"> The clock is not set correctly. Reset the clock using “Manual Clock Setting”. ⑧⑧
This disc may not be played in your region.	<ul style="list-style-type: none"> You tried to play a disc with a region number different from this unit's region number. This unit can only play discs with the region numbers compatible with this unit (1, All, or including the number 1). ⑥
Your selection exceeds the recorder's rating limit.	<ul style="list-style-type: none"> A ratings level has been set for DVD-Video with this unit. Temporarily unlock the unit with “Ratings” in the Disc ACTION menu. ⑥⑥

Troubleshooting guide

Before requesting service, make the below checks. If you are in doubt about some of the check points, or if the remedies indicated in the chart do not solve the problem:

In the U.S.A., contact the Panasonic Customer Call Center at 1-800-211-7262, or e-mail consumerproducts@panasonic.com, or web site (<http://www.panasonic.com>).

In Canada, contact Panasonic Canada Inc. Customer Care Centre at 1-800-561-5505, web site (www.panasonic.ca), or an authorized Servicentre closest to you.

Reference pages are shown as black circled numbers ⑭.

Possible solutions are indicated with “” on the relative pages in the operating instructions.

Power

No power.	<ul style="list-style-type: none"> ● Insert the AC power supply cord securely into the household AC outlet. ⑭
The unit is on but cannot be operated.	<ul style="list-style-type: none"> ● The unit is hot (“U14” appears on the display). ⑳ ● Wait for “U14” to disappear. ● One of the unit’s safety devices may have activated. ● Reset the unit as follows: <ol style="list-style-type: none"> 1. Press [⏻/I, POWER] on the main unit to switch the unit to standby. <ul style="list-style-type: none"> ● If the unit doesn’t switch to standby, press and hold [⏻/I, POWER] for about 10 seconds. The unit is forcibly switched to standby. ● Alternatively, disconnect the AC power supply cord, wait one minute, then reconnect it. 2. Press [⏻/I, POWER] to turn the unit on.
The unit switches to standby automatically.	<ul style="list-style-type: none"> ● This is a power saving feature. You can turn it off if you would prefer (ACTION—Set Up—Off Timer—Off). ㉒ ● Press [⏻/I, POWER] to turn the unit on. ● One of the unit’s safety devices may have activated. ● Press [⏻/I, POWER] to turn the unit on.

Picture

The images from this unit do not appear on the television.	<ul style="list-style-type: none"> ● Make sure the television’s input setting (e.g., VIDEO 1) is correct.
Television reception worsens after connecting the unit.	<ul style="list-style-type: none"> ● This can occur because the signals are being divided between the unit and the television. It can be solved by using a signal booster, available from audio-visual suppliers. Consult your dealer if reception does not improve.
Screen size is wrong.	<ul style="list-style-type: none"> ● Check the settings on your television. ● Check the settings for “TV Aspect”, “4:3 TV Settings for DVD-Video” or “4:3 TV Settings for DVD-RAM” in the TV Screen ACTION menus. ㉑, ㉓
The picture flickers.	<ul style="list-style-type: none"> ● Adjust the television’s vertical hold. Read the television’s operating instructions or consult your dealer.
On-screen messages do not appear.	<ul style="list-style-type: none"> ● Go to Display in the ACTION menus and select “Automatic” for “Status Messages”. ㉔ ● Press [STATUS] to show the on-screen messages constantly. ㉕
The blue background does not appear.	<ul style="list-style-type: none"> ● Go to Display in the ACTION menus and select “On” for “Blue Background”. ㉖

Sound

No sound. Low volume. Distorted sound.	<ul style="list-style-type: none"> ● Check the connections. ⑭, ㉗ ● Check the input mode on the amplifier if you have connected one. ● Turn V.S.S. off if it causes distortion. ㉘
Cannot hear the desired audio type.	<ul style="list-style-type: none"> ● Press [AUDIO] on the remote control to select the desired audio type. ㉙ ● DVD-R ● Go to Audio in the ACTION menus and choose the correct setting with “MTS Selection for DVD-R Disc”. ㉚
Cannot switch audio during stereo or MTS broadcasts.	<ul style="list-style-type: none"> ● You have used digital connection. Connect to other equipment using audio cables (analog connection). ⑭, ㉗ ● You cannot change the audio type when using DVD-R. ㉛

Play

<p>Play fails to start even when [▶, PLAY] is pressed. Play starts but then stops immediately. “U11”, “NO DISC”, or “NO PLAY” appears on the unit’s display.</p>	<ul style="list-style-type: none"> ● Insert the disc correctly with the label facing up. 22 ● This unit cannot play discs other than DVD-RAM, DVD-R, DVD-Video, Video CD, and CD. 6 ● The disc is dirty. Clean it. 93 ● The disc may be badly scratched. 93 ● You inserted a blank DVD-RAM or DVD-R. ● Condensation has formed: Wait 1 to 2 hours for it to evaporate.
<p>No response when buttons pressed.</p>	<ul style="list-style-type: none"> ● Some operations may be prohibited by the disc. ● If the unit is not operating at all, press [⏻/I, POWER] to switch the unit to standby, then press [⏻/I, POWER] again to turn the unit on. The unit may not be operating correctly due to lightning, static electricity, or some other external factor.
<p>A title or chapter doesn’t play when it is selected.</p>	<ul style="list-style-type: none"> ● Some titles and chapters on DVD-Video are not played when you have changed the ratings level. 86
<p>Picture distorted during search.</p>	<ul style="list-style-type: none"> ● Some distortion is normal.
<p>There is ghosting.</p>	<ul style="list-style-type: none"> ● Change the settings for “3D NR”, “Block NR”, and “Mosquito NR” to “0” or turn MPEG DNR off with the on-screen menu icons. 42
<p>Alternative soundtrack and subtitles cannot be selected.</p>	<ul style="list-style-type: none"> ● The languages are not recorded on the disc. ● You may have to use the disc’s menus to select languages. 23
<p>No subtitles.</p>	<ul style="list-style-type: none"> ● Subtitles are not recorded on the disc. ● Turn the subtitles on. 41
<p>Angle cannot be changed.</p>	<ul style="list-style-type: none"> ● This function depends on software availability. Angles can only be changed during scenes where different angles are recorded (“⏮” appears on the display).
<p>You have forgotten your ratings password.</p>	<ul style="list-style-type: none"> ● Return the ratings setting to “8”. While the disc tray is open, press and hold [◀◀] and [▶▶] on the main unit at the same time for 5 or more seconds.

Displays

<p>The display is dim.</p>	<ul style="list-style-type: none"> ● Go to Display in the ACTION menus and change the display’s brightness with “FL Display”. 83
<p>“12:00” is flashing on the unit’s display.</p>	<ul style="list-style-type: none"> ● The clock is not set. Go to Set Up in the ACTION menus and set the clock with “Clock Settings”. 87

Remote control

<p>The remote control doesn’t work.</p>	<ul style="list-style-type: none"> ● [DVD, TV] is not switched to “DVD”. Switch to “DVD” when operating this unit. 8, 12 ● The remote control and main unit are using different codes. Change the code on the remote control or main unit. 31, 32 ● The batteries are depleted. Replace them with new ones. 12 ● Point the remote control at the remote control sensor on the main unit. 12 ● Remove obstacles from between the remote control and main unit.
<p>Cannot operate the television.</p>	<ul style="list-style-type: none"> ● Change manufacturer code. Some televisions cannot be operated even if you change the code. 13 ● [DVD, TV] is not switched to “TV”. Switch to “TV” when operating the television. 8

Recording and timer recording

<p>Cannot record.</p>	<ul style="list-style-type: none"> • You haven't inserted a disc or the disc you inserted cannot be recorded on. Insert a disc the unit can record onto. 6 • The disc is unformatted. Format the disc so this unit can record on it. 54 • The disc is protected with the write-protect tab. Use a ballpoint pen or similar to release the write protection. 49 • The disc is protected with DISC SETTING. Release the disc protection. 55 • The disc is full or nearly full. Erase unneeded programs or use another disc. 53
<p>VCR Plus+ programming does not work properly.</p>	<ul style="list-style-type: none"> • The guide channels are incorrect. Go to Set Up in the ACTION menus and correct the guide channels with "VCR Plus+ CH Setting". 19 • The clock is wrong. Go to Set Up in the ACTION menus and correct the clock with "Clock Settings". 67
<p>Timer recording does not work properly.</p>	<ul style="list-style-type: none"> • The timer program is incorrect. Correct the program. 45, 47 • The unit is not on timer recording standby. ("□" on the unit's display is not on.) Press [⏻/I, POWER] to turn "□" on. 44, 47 • Different timer program times overlap. 48 • The clock is wrong. Go to Set Up in the ACTION menus and correct the clock with "Clock Settings". 67
<p>The unit switches to standby while making a timer recording.</p>	<ul style="list-style-type: none"> • The disc runs out of space. Use a disc that has enough space to record the program.
<p>The timer program remains even after recording finishes.</p>	<ul style="list-style-type: none"> • The program remains if you select "DAILY" or "WEEKLY". 45, 46 The program also remains if recording failed for some reason, but is cleared automatically at 4 a.m. the day after tomorrow. 48
<p>Timer recording does not stop even when [■, STOP] is pressed.</p>	<ul style="list-style-type: none"> • Press [⏻/I, POWER] and then [■, STOP] within 5 seconds to turn "□" off. Recording stops.
<p>The available recording time doesn't increase even after erasing all recordings on the disc.</p>	<ul style="list-style-type: none"> • As this unit is unable to erase data written to DVD-RAM with a computer, the available recording time does not increase. The data will be erased if you reformat the disc. 54 If the disc is dirty, wipe with the DVD-RAM/PD disc cleaner (optional) before formatting. 98

Discs make sounds as they rotate. This does not indicate a malfunction.

Product Service

1. **Damage requiring service**—The unit should be serviced by qualified service personnel if:
 - (a) The AC power supply cord or AC adaptor has been damaged; or
 - (b) Objects or liquids have gotten into the unit; or
 - (c) The unit has been exposed to rain; or
 - (d) The unit does not operate normally or exhibits a marked change in performance; or
 - (e) The unit has been dropped or the cabinet damaged.
2. **Servicing**—Do not attempt to service the unit beyond that described in these operating instructions. Refer all other servicing to authorized servicing personnel.
3. **Replacement parts**—When parts need replacing ensure the servicer uses parts specified by the manufacturer or parts that have the same characteristics as the original parts. Unauthorized substitutes may result in fire, electric shock, or other hazards.

4. **Safety check**—After repairs or service, ask the servicer to perform safety checks to confirm that the unit is in proper working condition.

Product information

For product information or assistance with product operation:

In the U.S.A., contact the Panasonic Customer Call Center at 1-800-211-7262, or e-mail consumerproducts@panasonic.com, or web site (<http://www.panasonic.com>).
In Canada, contact Panasonic Canada Inc. Customer Care Centre at 1-800-561-5505, web site (www.panasonic.ca), or an authorized Servicentre closest to you.

Panasonic Consumer Electronics Company, Division of Matsushita Electric Corporation of America
One Panasonic Way Secaucus,
New Jersey 07094

Panasonic Sales Company, Division of Matsushita Electric of Puerto Rico, Inc
Ave. 65 de Infanteria, Km. 9.5
San Gabriel Industrial Park, Carolina, Puerto Rico 00985

PANASONIC DVD RECORDER Limited Warranty

Panasonic Consumer Electronics Company or Panasonic Sales Company (collectively referred to as "the Warrantor") will repair this product and all included accessories with new or refurbished parts, free of charge in the USA or Puerto Rico, from the date of the original purchase in the event of a defect in materials or workmanship as follows:

Parts—New or rebuilt parts in exchange for defective parts for one (1) year from the date of original purchase.

Labor—Carry-in or mail-in service for one (1) year from the date of original purchase.

Batteries—(if included) New rechargeable batteries in exchange for defective rechargeable batteries for ten (10) days from the date of original purchase. Non-rechargeable batteries are not warranted.

4.7 DVD-RAM Disc—(if included) New 4.7 DVD-RAM Disc in exchange for defective disc for ten (10) days from the date of original purchase.

Carry-in or mail-in service in the USA may be obtained during the warranty period by contacting a Panasonic Services Company (PASC) Factory Servicenter listed in the Service Directory. Or call toll free 1-800-211-PANA(7262) to locate an authorized PASC Servicenter. Carry-in or mail-in service in Puerto Rico can be obtained during the warranty period by calling the telephone number listed in the Servicenter Directory.

This warranty is extended only to the original purchaser. A purchase receipt or other proof of date of original purchase will be required before warranty service is rendered.

This warranty only covers failures due to defects in materials and workmanship which occur during normal use. The warranty does not cover damage which occurs in shipment, or failures which are caused by products not supplied by the warrantor, or failures which result from accident, misuse, abuse, neglect, mishandling, misapplication, alteration, modification, faulty installation, set-up adjustments, improper antenna, inadequate signal pickup, maladjustment of consumer controls, improper operation, power line surge, improper voltage supply, lightning damage, commercial use such as hotel, office, restaurant, or other business or rental use of the product, or service by anyone other than a DVD Recorder authorized repair facility, or damage that is attributable to acts of God.

LIMITS AND EXCLUSIONS

There are no express warranties except as listed above.

THE WARRANTOR SHALL NOT BE LIABLE FOR INCIDENTAL OR CONSEQUENTIAL DAMAGES (INCLUDING, WITHOUT LIMITATION, DAMAGE TO DISCS) RESULTING FROM THE USE OF THIS PRODUCTS, OR ARISING OUT OF ANY BREACH OF THE WARRANTY. ALL EXPRESS AND IMPLIED WARRANTIES, INCLUDING THE WARRANTIES OF MERCHANTABILITY AND FITNESS FOR PARTICULAR PURPOSE, ARE LIMITED TO THE APPLICABLE WARRANTY PERIOD SET FORTH ABOVE

Some states do not allow the exclusion or limitation of incidental or consequential damages, or limitations on how long an implied warranty lasts, so the above exclusions or limitations may not apply to you.

This warranty gives you specific legal rights and you may also have other rights which vary from state to state.

If you have a problem with this product that is not handled to your satisfaction, then write to the Consumer Affairs Department at the Company address indicated above.

Panasonic Canada Inc.
5770 Ambler Drive, Mississauga, Ontario L4W 2T3

PANASONIC/TECHNICS PRODUCT—LIMITED WARRANTY

Panasonic Canada Inc. warrants this product to be free from defects in material and workmanship and agrees to remedy any such defect for a period as stated below from the date of original purchase.

Panasonic DVD Recorder One (1) year, parts and labour

LIMITATIONS AND EXCLUSIONS

This warranty does not apply to products purchased outside Canada or to any product which has been improperly installed, subjected to usage for which the product was not designed, misused or abused, damaged during shipping, or which has been altered or repaired in any way that affects the reliability or detracts from the performance, nor does it cover any product which is used commercially. Dry cell batteries are also excluded from coverage under this warranty.

This warranty is extended to the original end user purchaser only. A purchase receipt or other proof of date of original purchase is required before warranty service is performed.

THIS EXPRESS, LIMITED WARRANTY IS IN LIEU OF ALL OTHER WARRANTIES, EXPRESS OR IMPLIED, EXCLUDING ANY IMPLIED WARRANTIES OF MERCHANTABILITY OR FITNESS FOR A PARTICULAR PURPOSE. IN NO EVENT WILL PANASONIC CANADA INC. BE LIABLE FOR ANY SPECIAL, INDIRECT OR CONSEQUENTIAL DAMAGES.

In certain instances, some jurisdictions do not allow the exclusion or limitation of incidental or consequential damages, or the exclusion of implied warranties, so the above limitations and exclusions may not be applicable.

WARRANTY SERVICE

For product operation and information assistance, please contact your Dealer or our Customer Care Centre at: Telephone #: (905) 624-5505 Fax #: (905) 238-2360 Web: www.panasonic.ca

For product repairs, please contact one of the following:

- Your Dealer who will inform you of an authorized Servicentre nearest you.
- Our Customer Care Centre at (905) 624-5505 or www.panasonic.ca
- A Panasonic Factory Servicentre listed below:

Richmond, British Columbia
Panasonic Canada Inc.
12111 Riverside Way,
Richmond, BC, V6W 1K8
Tel: (604) 278-4211
Fax: (604) 278-5627

Calgary, Alberta
Panasonic Canada Inc.
6835-8th St. N. E.
Calgary, AB T2E 7H7
Tel: (403) 295-3955
Fax: (403) 274-5493

Mississauga, Ontario
Panasonic Canada Inc.
5770 Ambler Dr.
Mississauga, ON L4W 2T3
Tel: (905) 624-8447
Fax: (905) 238-2418

Lachine, Québec
Panasonic Canada Inc.
3075, rue Louis A. Amos
Lachine, QC H8T 1C4
Tel: (514) 633-8684
Fax: (514) 633-8020

Reference

CUSTOMER'S RECORD: _____

Customer Name: _____

Model Number: _____ **Serial Number:** _____

Date of Purchase: _____

Dealer's Name: _____

Address: _____ **Phone Number:** _____

IF YOU SHIP THE PRODUCT TO A SERVICENTRE

Carefully pack and send prepaid, adequately insured and preferably in the original carton. Include details of the defect claimed, and proof of date of original purchase.

Ref: Audwar0600

Panasonic

Technics

Quasar

*For Product Information, Operating Assistance, Literature Request, Dealer Locations, and all Customer Service inquiries please contact:
1-800-211-PANA (7262), Monday–Friday 9 am–9 pm; Saturday–Sunday 9 am–7 pm, EST.*

*Web Site: <http://www.panasonic.com>
You can purchase parts, accessories or locate your nearest servicenter by visiting our Web Site.*

Accessory Purchases:

1-800-332-5368 (Customer Orders Only)
Panasonic Services Company 20421 84th Avenue South, Kent, WA 98032
(6 am to 5 pm Monday–Friday; 6 am to 10:30 am Saturday; PST)
(Visa, MasterCard, Discover Card, American Express, Check)

Factory Servicenters Locations

<p>CALIFORNIA 6550 Katella Avenue Cypress, CA 90630</p> <p>800 Dubuque Avenue S. San Francisco CA 94080</p> <p>3878 Ruffin Road Suite A San Diego, CA 92123</p> <p>FLORIDA 3700 North 29th Avenue Suite 102 Hollywood, FL 33020</p>	<p>GEORGIA 8655 Roswell Road Suite 100 Atlanta, GA 30350</p> <p>ILLINOIS 9060 Golf Road Niles, IL 60714</p> <p>1703 North Randall Road Elgin, IL 60123 (Pick-up/Drop-off only)</p> <p>MASSACHUSETTS 60 Glacier Drive Suite G Westwood, MA 02090</p>	<p>MINNESOTA 7850-12th Avenue South Airport Business Center Bloomington, MN 55425</p> <p>OHIO 2236 Waycross Road Civic Center Plaza Forest Park, OH 45240</p> <p>PENNSYLVANIA 2221 Cabot Blvd. West Suite B Langhorne, PA 19047</p>	<p>TEXAS 13615 Welch Road Suite 101 Farmers Branch TX 75244</p> <p>WASHINGTON 20425-84th Avenue South Kent, WA 98032</p> <p>HAWAII 99-859 Iwaiwa Street Aiea, Hawaii 96701 Phone (808) 488-1996 Fax (808) 486-4369</p>
--	--	---	--

Service in Puerto Rico

*Matsushita Electric of Puerto Rico, Inc. Panasonic Sales Company/Factory Servicenter:
Ave. 65 de Infanteria, Km. 9.5, San Gabriel Industrial Park, Carolina, Puerto Rico 00985
Phone (787) 750-4300 Fax (787) 768-2910*

Conexiones de antena y televisor

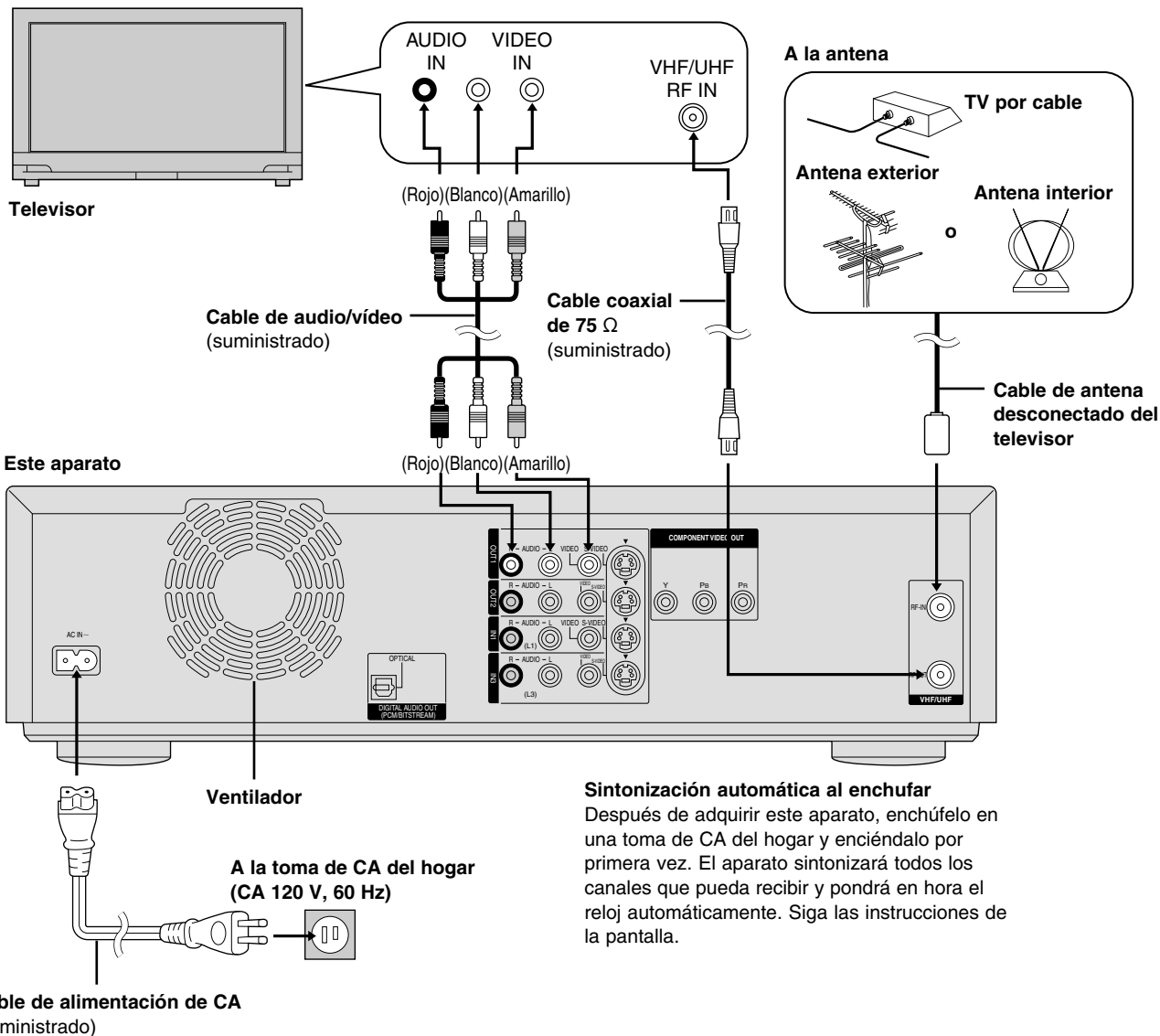

Sintonización automática al enchufar

Después de adquirir este aparato, enchúfelo en una toma de CA del hogar y enciéndalo por primera vez. El aparato sintonizará todos los canales que pueda recibir y pondrá en hora el reloj automáticamente. Siga las instrucciones de la pantalla.

Selección del tipo de la pantalla del televisor

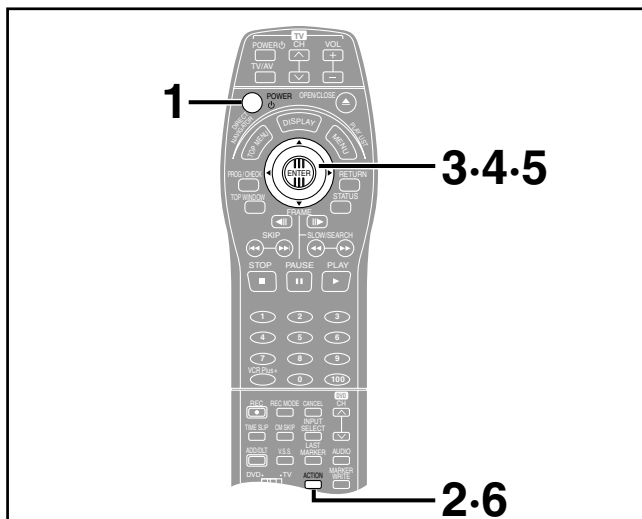

Estas instrucciones de funcionamiento describen las operaciones llevadas a cabo utilizando principalmente el mando a distancia. Las operaciones descritas también pueden realizarse utilizando el aparato principal siempre que sus botones tengan el mismo nombre que los del mando a distancia.

- 1 Pulse [POWER] para encender este aparato.
- 2 Pulse [ACTION] para visualizar los menús.
- 3 Utilice el mando de control [◀, ▶] para seleccionar la lengüeta TV Screen.
- 4 Utilice el mando de control [▲, ▼] para seleccionar "TV Aspect" y pulse [ENTER].
- 5 Utilice el mando de control [▲, ▼] para seleccionar el aspecto del televisor y pulse [ENTER].
 - 4:3 (ajuste de fábrica)
 - 16:9
- 6 Pulse [ACTION] para finalizar el ajuste.

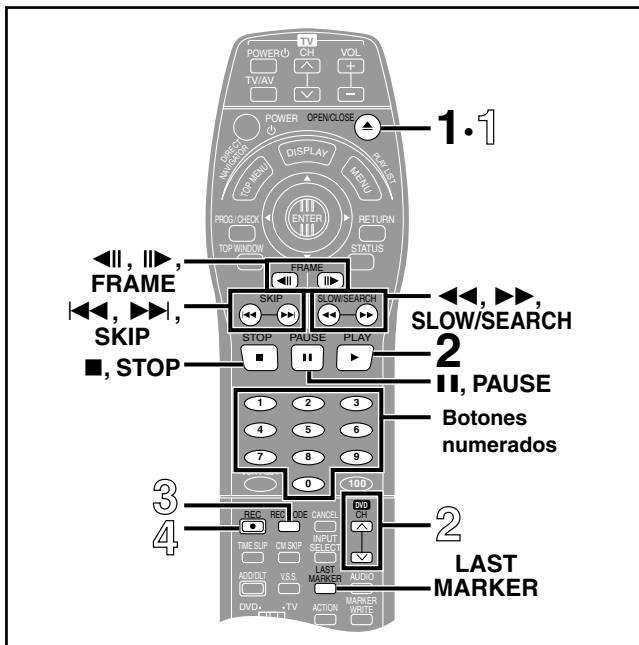

Reproducción de discos

RAM DVD-R DVD-V CD VCD

1 Pulse [**▲**, OPEN/CLOSE] para abrir la bandeja del disco y coloque el disco.

Insértelo con la etiqueta hacia arriba y la flecha hacia adentro.

Insértelo con la etiqueta hacia arriba.

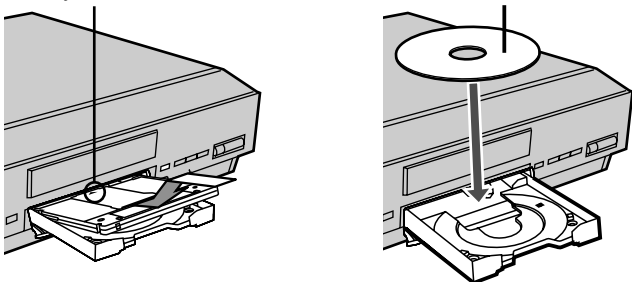

- Con los discos de dos caras, insértelos de forma que la etiqueta de la cara que desee reproducir quede hacia arriba.

2 Pulse [**▶**, PLAY].

La bandeja del disco se cierra y la reproducción empieza.

- Para detener la reproducción, pulse [**■**, STOP].
- Para hacer una pausa, pulse [**⏸**, PAUSE].

Grabación de programas de TV

RAM DVD-R

1 Pulse [**▲**, OPEN/CLOSE] para abrir la bandeja del disco y coloque el disco.

2 Pulse [**DVD**, **▲**, **▼**, CH] para seleccionar el canal.

3 Pulse [REC MODE] para seleccionar el modo de grabación.

4 Pulse [**●**, REC] para iniciar la grabación.

Cuando una pantalla de menú aparece en el televisor

DVD-V VCD

Pulse los botones numerados para seleccionar un elemento.

Función de reanudación

Cuando pulse [**▶**, PLAY], el aparato recordará la posición. Cuando pulse [**▶**, PLAY] mientras parpadea "PLAY" en el visualizador, la reproducción empezará desde donde usted la detuvo.

Para cancelar

Pulse [**■**, STOP] hasta que "PLAY" desaparezca del visualizador del aparato.

Para iniciar la reproducción desde una posición memorizada después de apagar el aparato

Pulse [LAST MARKER] durante la reproducción.

(El mensaje "Position Memorized" aparece en el televisor.)

Ahora, cuando pulse [**▶**, PLAY] después de poner el aparato en el modo de espera y luego encenderlo, la reproducción empezará desde la posición memorizada.

Salto

Puede saltar al principio de las pistas y los capítulos y reiniciar la reproducción desde allí.

En los DVD-RAM y DVD-R puede saltar al principio de un programa o a un marcador e iniciar la reproducción desde allí.

Durante la reproducción o durante la pausa

Pulse [**⏮**, SKIP] o [**⏭**, SKIP].

Visión cuadro a cuadro

RAM DVD-R DVD-V VCD

Durante la pausa

Pulse [**⏮**, FRAME] o [**⏭**, FRAME].

Avance rápido y rebobinado—SEARCH

Durante la reproducción

Pulse [**⏮**, SLOW/SEARCH] o [**⏭**, SLOW/SEARCH].

Reproducción a cámara lenta

RAM DVD-R DVD-V VCD

Durante la pausa

Pulse [**⏮**, SLOW/SEARCH] o [**⏭**, SLOW/SEARCH].

- Pulse [**▶**, PLAY] para volver a iniciar la reproducción.
- Durante las reproducciones cuadro a cuadro y a cámara lenta no puede retroceder en los CDs de vídeo.
- [**⏮**], [**⏮**], [**⏮**]: Retroceso
- [**⏭**], [**⏭**], [**⏭**]: Avance

Reproducción desde el comienzo del programa que está grabando—Persecución de reproducción

RAM

Durante la grabación o la grabación con temporizador

Pulse [**▶**, PLAY].

La reproducción empieza desde el principio del programa que está siendo grabado.

Grabación y reproducción simultáneas

RAM

Durante la grabación o la grabación con temporizador

1 Pulse [TOP MENU, DIRECT NAVIGATOR].

2 Utilice el mando de control [**▲**, **▼**] para seleccionar el programa y pulse [ENTER].



antenna	
advanced	80
basic	14
CATV	76
audio	
connections	75
during search	83
settings	34, 41, 86
connections	
antenna	14, 80
audio, advanced	75–79
audio, basic	14
cable television	76, 77
surround	78
television	14, 76
video	14, 15
digital	
connections	78
settings	86
discs	
care and cleaning of	98
protection	99
types of	6
erasing	
programs	58
parts of programs	63
finalizing DVD-R	7, 55
formatting DVD-RAM	54
frame-by-frame	24
languages	
abbreviations	41
audio	41, 84
code list	84
menu	84
on-screen	83
subtitle	41, 84
play	
chasing play	28
program	38
random	39
repeat	33, 42
seamless	84
while recording	28
protection, disc	
releasing protection	53
using DISC SETTING	52
with the write-protect tab	99
protection, program	60
ratings	82, 86
recording	
from other equipment	49
modes	26, 44
setting a time to finish	27
timer	43, 46
VCR Plus+	43
while playing	28
remote control	
batteries	12
code	81, 82
use	8, 12
with other equipment	81
with the television	13
slow motion	24
subtitles	41
surround sound	
connections	75, 78
settings	86
virtual	39, 42, 78
television	
connections	14
recording	26
settings	21, 83
tuning	16, 90, 91
time	
setting the clock	87
timer recordings	43
tuning	
auto	16, 91
VCR Plus+	19
video	
connections	14, 15
picture quality	42
settings	42

Apparatus Claims of U.S. Patent Nos. 4,631,603, 4,577,216, and 4,819,098, licensed for limited viewing uses only.

This product incorporates copyright protection technology that is protected by method claims of certain U.S. patents and other intellectual property rights owned by Macrovision Corporation and other rights owners. Use of this copyright protection technology must be authorized by Macrovision Corporation, and is intended for home and other limited viewing uses only unless otherwise authorized by Macrovision Corporation. Reverse engineering or disassembly is prohibited.

Panasonic Consumer Electronics Company, Division of Matsushita Electric Corporation of America
 One Panasonic Way Secaucus,
 New Jersey 07094
<http://www.panasonic.com>

Panasonic Sales Company, Division of Matsushita Electric of Puerto Rico, Inc. ("PSC")
 Ave. 65 de Infantería, Km. 9.5
 San Gabriel Industrial Park,
 Carolina, Puerto Rico 00985

Panasonic Canada Inc.  
 5770 Ambler Drive
 Mississauga, Ontario
 L4W 2T3
www.panasonic.ca

© 2001 Matsushita Electric Industrial Co., Ltd.

Printed in Japan

RQT6035-P
 F0701MFO