

These are simplified instructions for recording and playback with the VIDEO Cassette Recorder. It is recommended that you first thoroughly read the instructions in the owner's manual before referring to this card. This card may be kept handy by placing it near the VCR.

### NOTE:

A rapid change in temperature can cause moisture to condense on the recorder mechanism. To prevent damage to the video tape, the DEW indicator lamp will remain on and the recorder will not operate.

For instructions, refer to the Owner's Manual.

## TO INSERT THE CASSETTE

1. Push the "POWER" switch to "ON".
2. Insert the cassette into the cassette compartment correctly. The cassette is automatically drawn into the VCR for operation, and the compartment door closes automatically.
3. The Cassette Indicator Lamp will light.

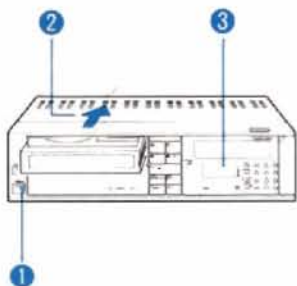

## TO REMOVE THE CASSETTE

1. Push the "POWER" switch to "ON".
2. Push the "EJECT" button. (The cassette will appear about 3 seconds after the "EJECT" button has been pushed.)
3. Remove the cassette.

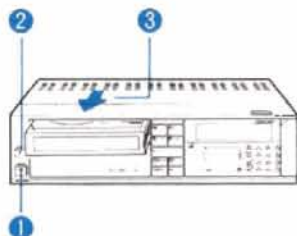

## RECORDING TV PROGRAMS

1. Turn "ON" the "POWER" switches of the VCR and TV receiver.
2. Set the TV channel selector to the VCR CHANNEL (Channel 3 or 4).
3. Insert the cassette into the compartment.
4. Push the "TV/VCR" switch to the "VCR" position. The red lamp will light.
5. Select the VCR channel which you wish to record.
6. Push the "REC" Button of the VCR. The VCR will start recording the program you see on your TV screen.
7. After recording, push the "STOP" Button.
8. Push the "REW" button to rewind the tape.

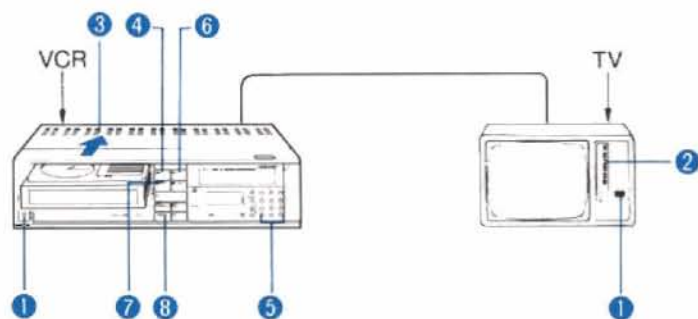

## TO PLAY THE RECORDED TAPE

1. First, follow steps 1 to 3 described in "RECORDING TV PROGRAMS".
2. Push the "PLAY" button. If tape was recorded on another VCR, it may be necessary to adjust "TRACKING" control for best picture.
3. When the playback is over, push the "STOP" Button.
4. Rewind the tape by pushing the "REW" Button.
5. Push "EJECT" button to remove the cassette.

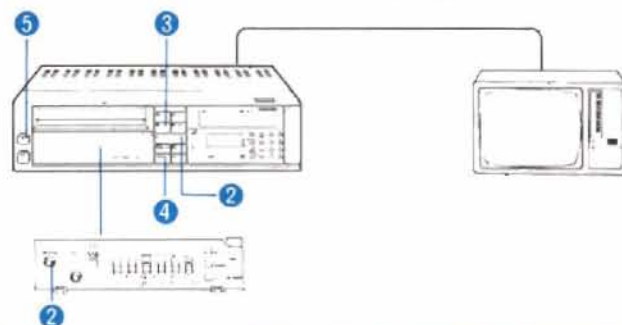

## RECORDING ONE PROGRAM WHILE VIEWING ANOTHER

1. Turn ON the "POWER" switches of the VCR and TV receiver. (Set the "INPUT" Selector switch of the VCR to "TV" position.)
2. Set the TV channel selector to the VCR CHANNEL (Ch 3 or Ch 4).
3. Insert the cassette into the compartment.
4. Push the "TV/VCR" switch of VCR and set it to "VCR" position. (The red lamp lights up.)
5. Select the channel which you want to record.
6. Push the "REC" Button of the VCR. The VCR will start recording the program you see on your TV screen.
7. Set the "TV/VCR" switch to "TV". (The lamp goes off.)
8. On your television receiver, select the channel you wish to view. Recording of the other program will continue.

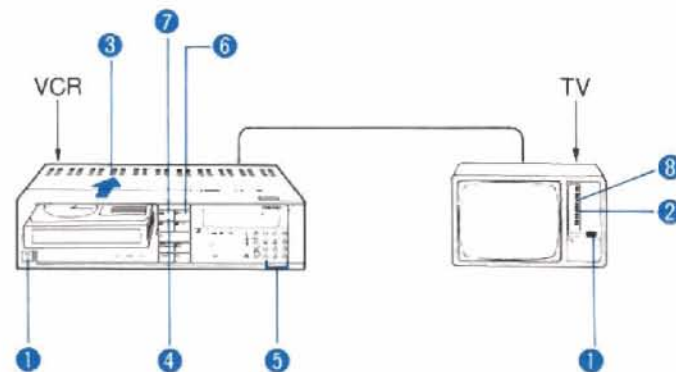

## PROGRAMMING WHILE YOU ARE AWAY

Example Program No. 1: Channel 6 on Friday this (1st) week from 8:15pm to 9:00 pm.

After turning the VCR "ON" by pressing the "POWER" switch,

1. Press the "PGM" (PROGRAM) button. Then Program number "1" will be flashing (For other program numbers, press the "SET" button until you reach the desired number.)
2. Press the "ENTER" button. Then "1st" will be flashing. (For the "2nd" week or both "1st" and "2nd" weeks, press the "SET" button until you have the desired indication flashing.)
3. Press the "ENTER" button. Then "SUN" will be flashing.
4. Press the "SET" button until the day is "FRI".
5. Press the "ENTER" button. Then the hour indicator, "--" will be flashing.
6. Press the "SET" button until the hour reads "PM 8".
7. Press the "ENTER" button. Then tens minute digit will be flashing.
8. Press the "SET" button until the tens minute digit reads "1".
9. Press the "ENTER" button. Then the minute digit "-" will be flashing.
10. Press the "SET" button until the minute digit reads "5".
11. Press the "ENTER" button. Then "OFF" display will appear with "PM" and "8" flashing, being ready for the "OFF" time setting.
12. Set the "OFF" time to "PM" "9:00" in the same manner as in the above 6) through 11). Then "CH" will now be flashing.
13. Select Channel 6 by pushing "0" and "6" on the 10—KEY buttons.
14. Press the "ENTER" button. Then the "END" will appear. The Program No. 1 has been now set.
15. For program No. 2, press the "ENTER" button again. Then, "2" will be flashing, being ready for next program.

### Notes:

- 1) If you do not wish to set another program, press the "CLOCK" button and then the "TIMER" button.
- 2) By pressing the "TIMER" button after completing program(s) as in the above Note 1), your VCR is all set for unattended timer recording.

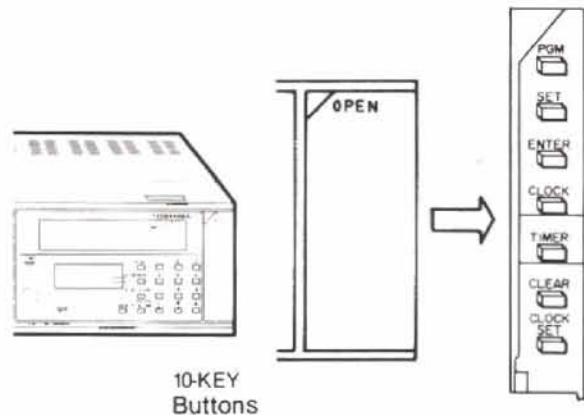
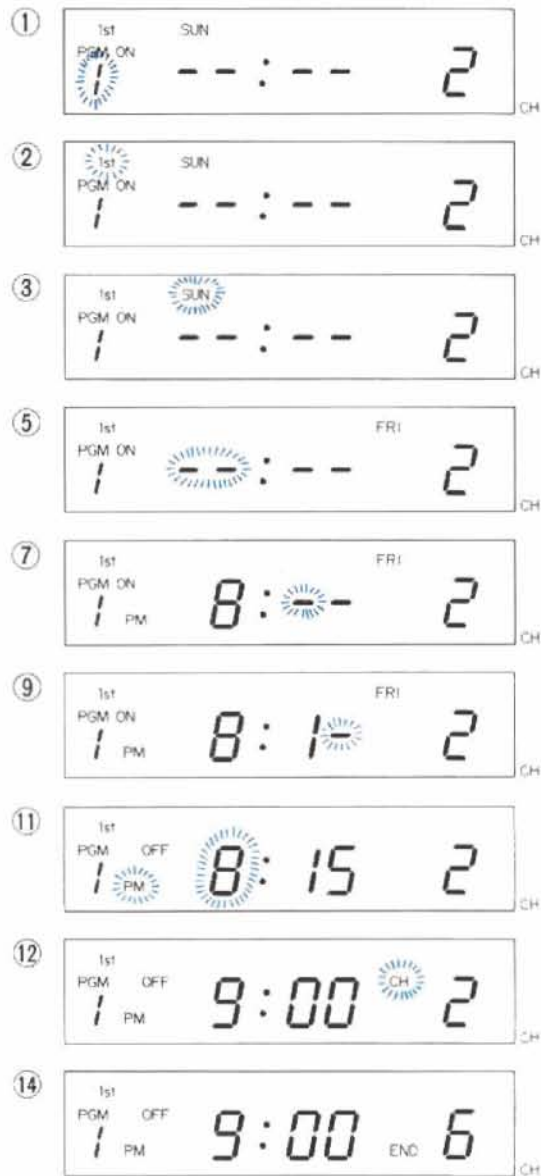

# TOSHIBA

OWNER'S MANUAL

## VIDEO CASSETTE RECORDER

# V-S46

# Beta hi-fi



### <FEATURES>

1. Beta Hi-Fi Stereo
2. Four-Head System
3. 20-Function Wireless Remote Control
4. New Fashionable Design
5. Electronic Counter & Elapsed Timer Display
6. Cable TV Facility
7. Clean Editing System
8. Six Motors

SHOULD YOUR UNIT REQUIRE SERVICE, PLEASE REFER  
TO "TOSHIBA SERVICE PROCEDURE" ON BACK COVER.

This instruction manual is important to you. Please read it. In a short time, it shows exactly how to connect, operate and adjust this VCR for best performance.

It can save your money. It shows you simple things to do and check before you call for help . . . so you may save the cost of unnecessary service.

**WARNING: TO REDUCE THE RISK OF FIRE OR ELECTRIC SHOCK, DO NOT EXPOSE THIS APPLIANCE TO RAIN OR MOISTURE. DANGEROUS HIGH VOLTAGES ARE PRESENT INSIDE THE ENCLOSURE. DO NOT OPEN THE CABINET. REFER SERVICING TO QUALIFIED PERSONNEL ONLY.**

Record in the spaces provided below the Model and Serial Nos as found at the rear of your video cassette recorder.

Model No \_\_\_\_\_

Serial No \_\_\_\_\_

Retain the information for future reference

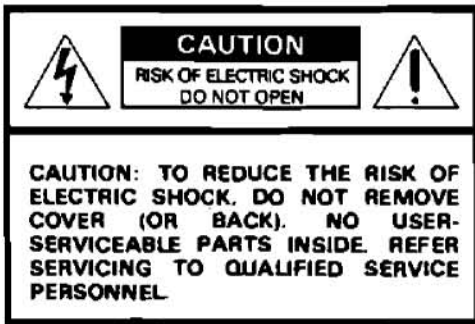



The lightning flash with arrowhead symbol, within an equilateral triangle, is intended to alert the user to the presence of uninsulated "dangerous voltage" within the product's enclosure that may be of sufficient magnitude to constitute a risk of electric shock to persons.



The exclamation point within an equilateral triangle is intended to alert the user to the presence of important operating and maintenance (servicing) instructions in the literature accompanying the appliance.

## ACCESSORIES

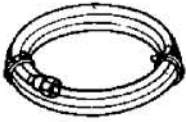
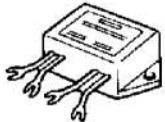
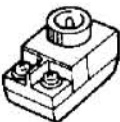
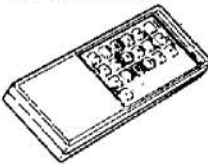
Check to make sure you have the following accessories before disposing of the packing material.

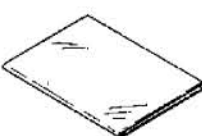
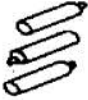
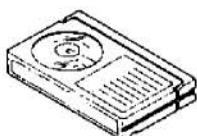
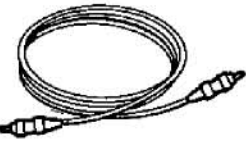
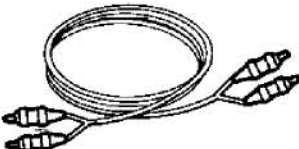
<p>1 ANTENNA CABLE</p> 	<p>2 UHF/VHF SPLITTER</p> 	<p>3 300-ohm/75-ohm MATCHING TRANSFORMER</p> 	<p>4 Remote Control Unit (Wireless)</p> 
<p>5 Quick Reference Card</p> 	<p>6 Safety Instructions</p> 	<p>7 Batteries 3 pcs ("AA" size)</p> 	<p>8 Cassette Tape</p> 
<p>9 Cable (VIDEO)</p> 	<p>10 Cable (AUDIO)</p> 		

NOTE: This Video Cassette Recorder is compatible with any Video Cassette Recorder bearing the  mark. The VCR is designed to expand your opportunities for home viewing and not for any usage which might violate the copyright laws.

Save the original shipping carton and packing materials; they will come in handy if you ever have to ship your VCR. For maximum protection, repack the set as it was originally packed at the factory.

## TABLE OF CONTENTS

CONNECT THE ANTENNA .....	3
CONNECT THE TELEVISION .....	3
CABLE ANTENNA CONNECTION .....	4
TELECATION ADAPTOR CONNECTION .....	4
SET YOUR TELEVISION TO THE VCR CHANNEL .....	5
SETTING THE CLOCK .....	5-6
SYNTHESIZER TUNER (Auto tuning system) .....	6-8
MAKING A SAMPLE RECORDING AND PLAYBACK .....	8
PLAYBACK WITH TV EQUIPPED WITH VIR .....	8
GET FAMILIAR WITH YOUR VCR .....	8
IDENTIFICATION AND OPERATION OF CONTROLS .....	9-20
AUDIO DUBBING .....	21
EDITING RECORDING .....	21
RECORDING ONE PROGRAM WHILE VIEWING ANOTHER .....	22
VCR TO VCR DUBBING .....	22
USING A CAMERA WITH THE VCR .....	23
PROGRAMMABLE TIMER .....	24-27
CONFIRMING THAT PROGRAM(S) ARE PRESET .....	27
TO CANCEL PREVIOUSLY TIMED PROGRAM(S) .....	27
USING THE "PICTURE SEARCH" (CUE AND REVIEW) FEATURES .....	28
USING THE "AUTO FIND" FEATURE .....	29
USING THE "MEMORY" FEATURE .....	29
USING THE TAPE "COUNTER/PLAY TIME" FEATURE .....	30
TIME/TAPE COUNTER CHART .....	30
HOW TO INSTALL BATTERIES IN THE REMOTE CONTROL UNIT .....	31
REMOTE CONTROL OPERATION RANGE .....	31
USING THE REMOTE CONTROL SPECIAL FEATURES .....	32
FORWARD SLOW .....	32
DOUBLE SPEED PLAYBACK .....	32
VARIABLE "SEARCH" (5-20 times normal playback) .....	32
SPECIAL FEATURE: "BETA hi-fi" SOUND SYSTEM .....	33
WHAT IS "BETA hi-fi"? .....	33
"BETA hi-fi" RECORDING/PLAYBACK CONNECTIONS .....	34
HOW TO OPERATE SWITCHES TO RECORD A TAPE WITH "BETA hi-fi" SOUND .....	35
HOW TO OPERATE SWITCHES TO PLAYBACK A TAPE PRE-RECORDED WITH "BETA hi-fi" SOUND .....	36
DEW WARNING .....	37
OPERATING HINTS .....	37
TROUBLESHOOTING .....	38-39
SPECIFICATIONS .....	40

## CONNECT THE ANTENNA

Identify the type of cable from your antenna. If it is a round cable as illustrated, it is a 75-ohm coaxial antenna cable. This cable will connect directly to the connector marked "ANTENNA IN" on your VCR.

If your antenna lead wire is a flat type antenna cable, connect it to the 300/75-ohm Matching Transformer (accessory number 3). Then slip the Matching Transformer onto the "ANTENNA IN" connector on the VCR. The Matching Transformer does not screw onto the VCR, it just slips over the connector.

**Note:** If your antenna has two leads (one for UHF and one for VHF), you will have to purchase a combiner/mixer to combine the two leads before connection to the VCR.

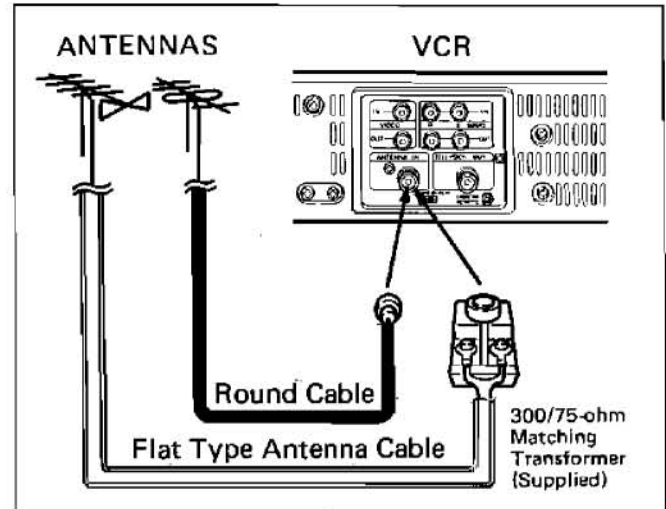

## CONNECT THE TELEVISION

1. Locate the Antenna Cable (accessory number 1).
2. Slide one end onto the VCR connector marked "TELEVISION OUT" located on the back of the VCR.
3. Locate the U/V Splitter (accessory number 2.) and connect it to the opposite end of the cable.
4. Connect the wires marked "UHF" on the Splitter to the UHF terminals on the back of your television. If you already have an adaptor on your TV antenna terminals, remove it.
5. Connect the wires marked "VHF" on the Splitter to the VHF terminals on the back of your television. Again, if you already have an adaptor on your TV antenna terminal, remove it.
6. Locate the "TV/VCR" switch on the front of the VCR. Press the "TV/VCR" switch to TV position, and then the light will go off.
7. Check that your TV is operating correctly. If it is not, recheck the antenna connections you just made.

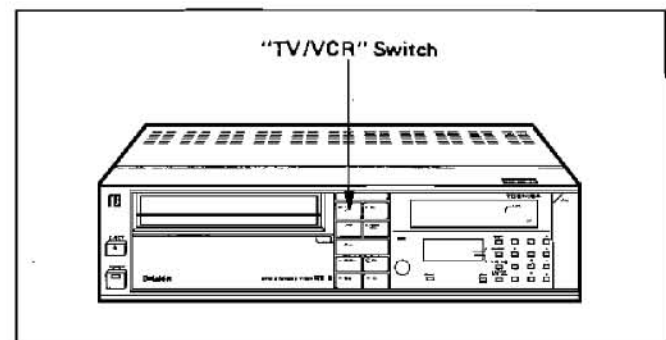
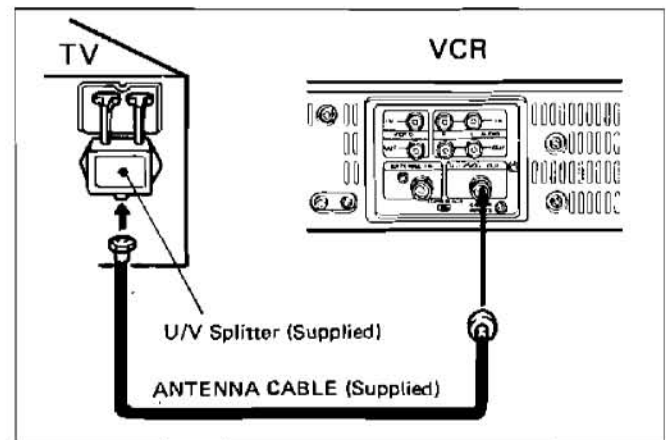

## CABLE ANTENNA CONNECTION

If you have cable TV in your area, you may be able to use one of the following methods of connection.

### CABLE ANTENNA LEAD AND CONVERTER

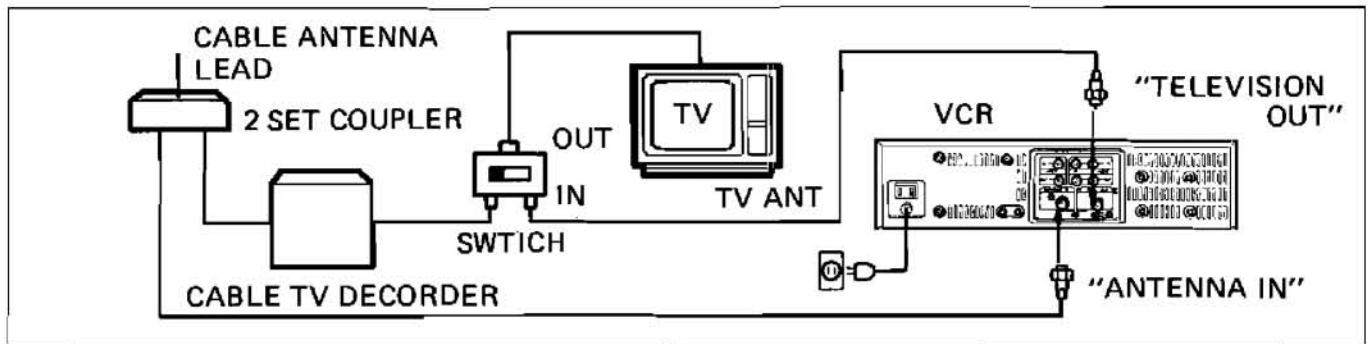

This hook-up will permit all VCR functions except that you cannot record any encoded (scrambled) channels.

### CABLE ANTENNA LEAD-NO CONVERTER

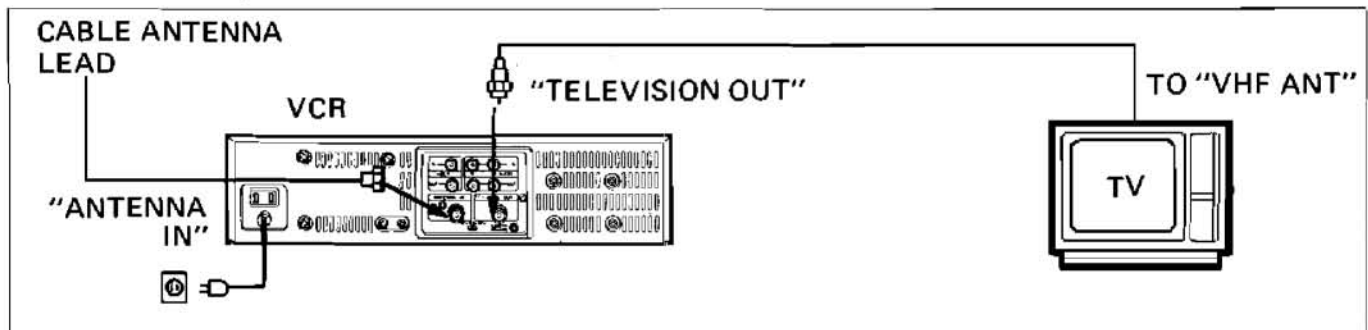

This hook-up will permit all VCR functions.

**NOTE:** These are the most popular types of Cable Systems. If your Cable Company uses a different system, please consult with the Cable Company for proper connections.

## TELECAPTION ADAPTOR CONNECTION

### CONNECTING THE VCR AND TELECAPTION ADAPTOR

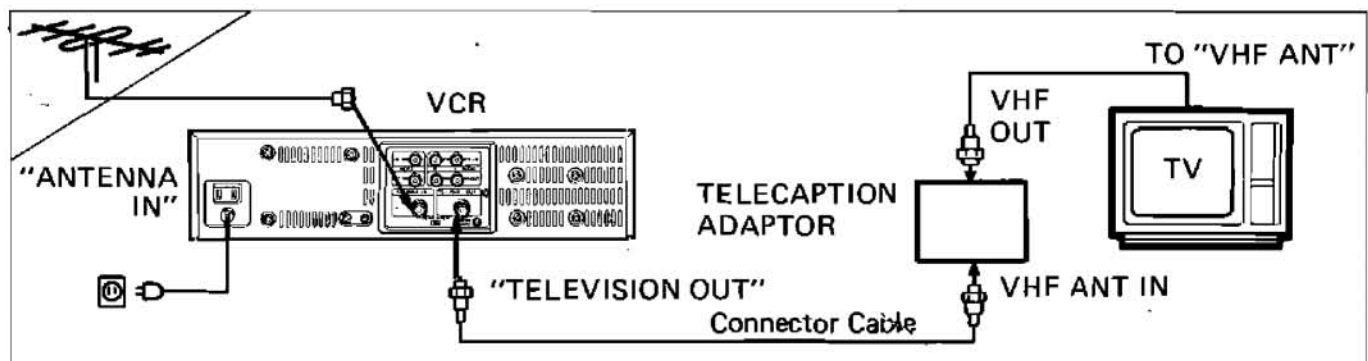

1. Connect the TV antenna lead to the VCR "ANTENNA IN" Connector.
2. Connect the Antenna Cable (accessory number 1) to the "TELEVISION OUT" Connector on the VCR. Connect the other end to the VHF IN on the Telecaption Adaptor.
3. Connect another antenna cable to the VHF

OUT on the Telecaption Adaptor. Connect the other end to the TV VHF Antenna Terminal.  
**NOTE:** The Telecaption Adaptor should always be connected so that it is between the VCR and TV. For alternate antenna connections, consult your Telecaption Adaptor Owners Manual.

## SET YOUR TELEVISION TO THE VCR CHANNEL

1. Set your TV to Channel 3 unless Channel 3 is one of the TV stations in your area. If Channel 3 is used in your area, set your TV to Channel 4.
2. Locate the RF Channel Select Switch on the lower portion of the back panel.
3. With a small screwdriver, slide the RF Channel Select Switch toward Channel 4. This is the VCR channel on your television set. Your television receiver must be tuned to this channel any time a video cassette is played back on the VCR.
4. Plug the VCR power cord into a 120V electrical outlet and press the "POWER" Switch. The "POWER" Light will come on. The clock will be flashing. (Don't worry, we will set that later.)
5. Press the "TV/VCR" Switch to the "VCR" position. The "VCR" Light will come on. Select an active TV channel by pushing the proper VCR Channel Selector Button. The picture from that channel should now be displayed on your television.

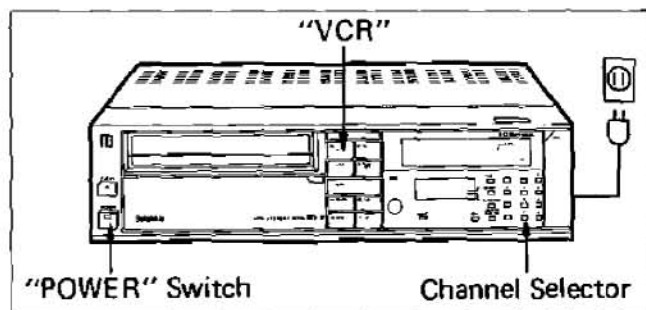
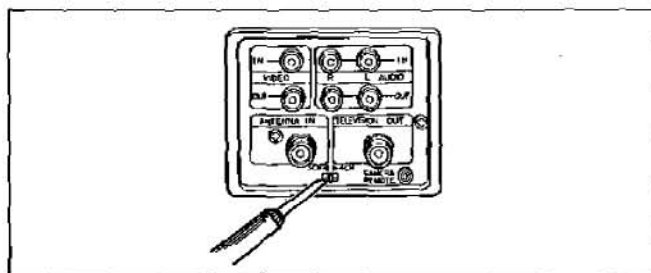

6. Fine tune the television for best picture.

## SETTING THE CLOCK

(EXAMPLE: Monday 9:00 AM)

1. When connecting the VCR to the AC power, the digital display will start flashing "SUN" "AM" "12:00".
2. Press the "CLOCK SET" button. (The "SUN" will flash.)
3. Press the "SET" button until the day indicator reaches correct day. (See Note 1.)  
..... "MON"

Press "ENTER" button.

(The hour indicator will now be flashing.)

4. Press the "SET" button until the hour indicator reaches correct figure. .... "AM 9"

Press "ENTER" button.

(The tens minute digit indicator will now be flashing.)

5. Press the "SET" button until the tens minute digit indicator reaches correct figure.  
..... "0"

Press "ENTER" button.

(The minute digit indicator will now be flashing.)

6. Press the "SET" button until the minute digit indicator reaches correct figure.  
..... "0"

Press "ENTER" button.

(The "END" indicator will now light.)

7. Press the "CLOCK" button to start clock. For the zero second setting, push "CLOCK" button when the correct time passes through zero seconds.

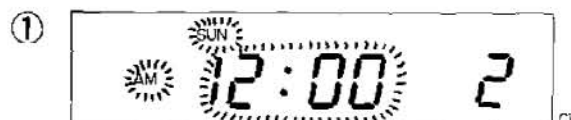



- Notes 1. If the "SET" button is held down, the day will change rapidly.
2. Always be certain the clock is set to the correct time and day before attempting programming.
3. Be careful to set "AM-PM" correctly.
4. Even if AC power to the VCR is interrupted, the clock will continue to run and the programming will not be disturbed for about 10 minutes. After 10 minutes of power interruption, if the clock flashes "SUN" "AM" "12:00", the clock and programming will have to be reset. (During power interruption there will be no clock display.)  
(If the colon flashes, it indicates there has been short power interruption. Then push the "CLOCK SET" button once and

flashing of colon goes out now and the day of week will be flashing. Then push the "CLOCK SET" button once again and the flashing will go out.)

5. The clock setting can be made whether the power is turned on or off.

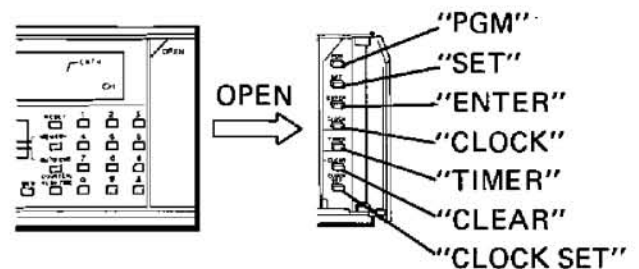

## SYNTHESIZER TUNER (Auto tuning system)

- \* Press the "POWER" switch "ON" after connecting antenna. The VCR automatically searches and memorizes the STANDARD Channels in your local area.
- \* While memorizing the STANDARD Channels, the Channel Indicator changes the number from 2 through 83.
- \* After memorizing the active channels in your area, the tuner will automatically stop at the lowest active channel number.
- \* If you move to a different area, press the "AUTO MEMORY" button inside the door to reprogram the active channels for your new area.
- \* The Automatic Memory operation will work with STANDARD Channels only; it will not work with CATV Channels.

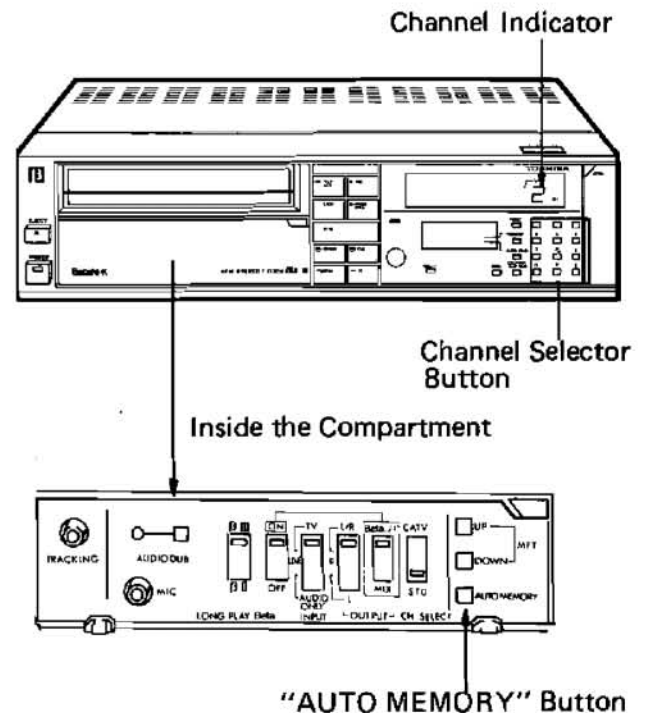

### < To Select a Channel >

This tuner is designed to allow you to select the desired channels by 10-KEY buttons as well as to automatically stop at next active channels by CHANNEL UP (▲)/DOWN (▼) buttons.

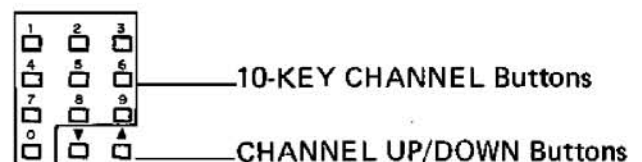

< To Select a Channel with the 10-KEY CHANNEL Buttons >

Example 1. Suppose you wish to select channel 4.

< Procedure 1. >

Suppose the TV is on channel 2. Press "0" and "4". Channel 4 will be selected immediately after pressing "4".

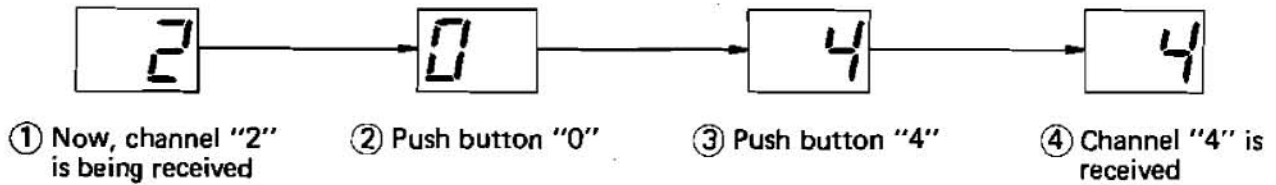

Note: For timed recording, always follow this procedure for selecting single-digit number channels on VCR.

< Procedure 2. >

Channel 0 through 9 may also be selected by pushing only the single channel number. For example, push "4" and wait 2-3 seconds. Then channel "4" will automatically be selected.

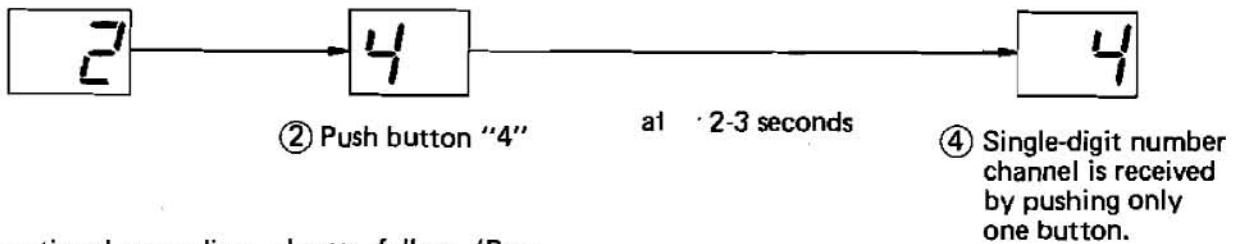

Note: For timed recording, always follow (Procedure 1) for selecting single-digit number channels on VCR.

Example 2. Suppose you wish to select channel "38".

Two digit channels will, of course, require 2 buttons to be pressed in sequence.

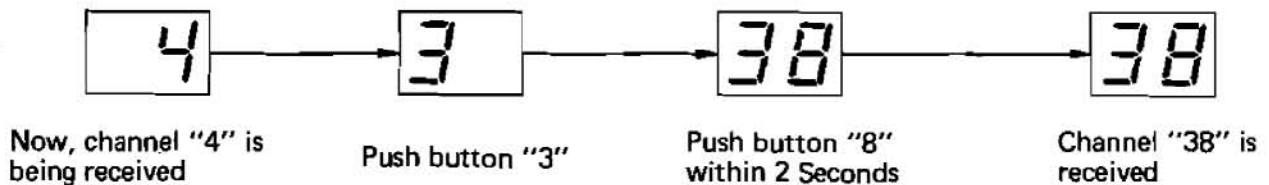

Note: If you wait longer than 2 seconds before pushing the second button, the tuner figures out you want only the first number you pushed and will select that station. In the above example, if you wait more than 2 seconds before pushing the "8" button,

channel "3" will be selected. If a non existing channel number is pressed, the tuner will select channel "2". For example 0, 1, 84, in STANDARD Channel or 47, 48, ..... in CATV.

**< To Select a Channel with the CHANNEL UP/DOWN Button >**

Push and release CHANNEL (▲) or CHANNEL (▼) button.

The channel steps automatically as shown in the chart below and stops at next active channel. It will skip unused channels. If you want to select the next channel, push the button again.

**Channel Indicator in CATV**

BAND	VHF Low					VHF MID					VHF HIGH				VHF SUPER				VHF HYPER			
CHANNEL	2	3	4	5	6	A-2	A-1	A	.....	1	7	8	.....	13	J	K	.....	V	W	AA	.....	JJ
INDICATOR	2	3	4	5	6	0	1	14	.....	22	7	8	.....	13	23	24	.....	35	36	37	.....	46

**MAKING A SAMPLE RECORDING AND PLAYBACK**

1. Press the "POWER" switch "ON" and red lamp will light.
2. Hold a Cassette so the small arrow is up and pointing toward the VCR. Slide the Cassette into VCR Cassette compartment as far as it will go. The cassette is automatically drawn into the cassette compartment.
3. Press the "TV/VCR" switch to the "VCR" position.
4. Now press the "REC" (recording) button to begin recording. You are now recording the program you see on your TV screen.
5. Record a few minutes, press the "STOP" button. Then press the "REW" button. The tape will rewind to the beginning.
6. To playback press the "PLAY" button. The TV picture will continue for a moment. Then the program you just recorded will be shown.
7. Press "STOP" button.

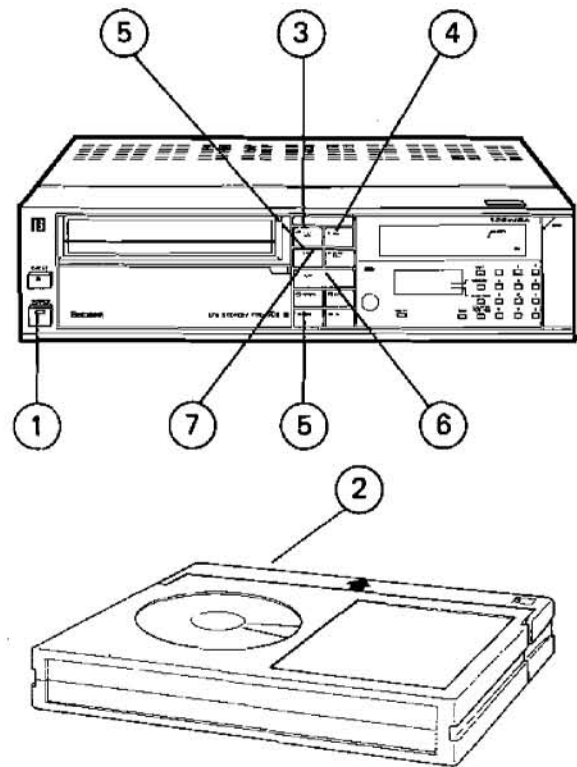

**PLAYBACK WITH TV EQUIPPED WITH VIR**

If your television receiver is equipped with VIR, it may be necessary to turn VIR OFF when playing back the video tape. Otherwise the color may be too bright, too faint or even change.

**GET FAMILIAR WITH YOUR VCR**

Now that you have experienced the simple operation of your VCR, let's get familiar with the complete operation of your VCR and all its capabilities on the following pages.

# IDENTIFICATION AND OPERATION OF CONTROLS

## FRONT PANEL

### "STOP" Button

Push "STOP" button while the set is operating, the running of tape stops and all operating modes are cancelled.

### Cassette Compartment

When a cassette is inserted in this compartment, the cassette will automatically be ready for operation. The cassette indicator lamp will light.

Avoid inserting anything into the cassette compartment except a cassette.

### "EJECT" Button

Used to remove the cassette from the cassette compartment.

### "POWER" Switch

Turns VCR power on and off.

When the switch is pressed to off, there will be a delay of 2 seconds before the VCR is actually off.

### "TV/VCR" Switch

TV: Used for normal operation of the TV set when VCR is not in use or for recording a program while watching another. (When turning on or off the VCR, "TV/VCR" switch is automatically set to "TV" position.)

VCR: Used to watch the playback picture or to monitor the program being recorded. (When the "PLAY" button is pressed, the "TV/VCR" switch is automatically set to the "VCR" position.)

Note: The red lamp will light when the "TV/VCR" switch is in "VCR" position.

### "PLAY" Button

Press for playing back recorded tape.

### Infrared Remote Control Receiver

To receive infrared signals from a Remote Control Unit.

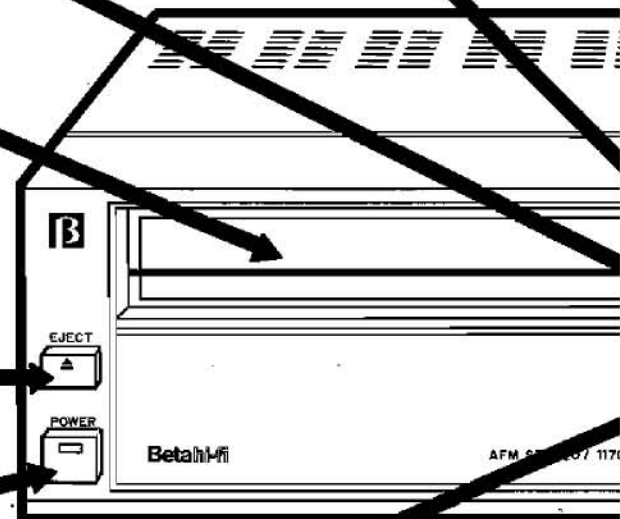

### Erase Prevention Tab

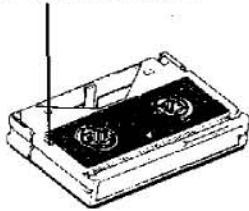

### "REC"ord Button

Used for recording. If the safety tab has been removed from the cassette, it will not be possible to record, thereby preventing your recording from being accidentally erased.

### "PAUSE/STILL" Button

In the recording mode, you can pause the operation of the recorder temporarily. In the playback mode, a picture will appear in the STILL mode. (The VCR will return to STOP from PAUSE (REC mode) after 10 minutes or to PLAY from STILL (PLAYBACK mode) after 5 minutes.)

- \* If noise appears or picture moves up and down slightly in the still mode, change to "SLOW" operation and adjust the "SLOW TRACKING" button on the Remote Control Unit to eliminate the noise. But there has been remained noise, when playing back a recorded tape with other VCR.
- \* The "STILL" picture may be slightly distorted when the tape is recorded in  $\beta$ II speed.

### "2 TIMES" Indicator

To indicate double speed playback operation. Two times speed can be controlled only from the Remote Control. (See page 32.)

### Cassette Indicator Lamp

When a cassette is correctly set in the cassette compartment and ready for operation, this cassette indicator lamp will light up.

### Dew Indicator Lamp

When moisture condenses on the VCR mechanism, the dew sensor will be activated to stop all functions (except for ejecting cassette) and the Dew Indicator Lamp will light. The VCR will not operate until the moisture has evaporated.

### Tape Running Indicator Lamp

To indicate the running direction of tape.

### "Beta hi-fi" Indicator

Lights up automatically when Beta hi-fi sound is either recorded or played back with "Beta hi-fi" switch (behind the door under cassette compartment) set at "ON" position.

## FRONT PANEL

### " $\beta$ II/ $\beta$ III" Indicator Lamp

This light will be on when tape speed is at  $\beta$ II or  $\beta$ III in record, normal playback and double speed playback modes.

### "AUTO FIND" Button

With the switch ON, the tape automatically stops as the beginning of each recording is reached in the "REW"ind and "FF" (Fast-Forward) modes. With both the "AUTO FIND" and counter "MEMORY" switches OFF, the tape will be rewound to the beginning of the tape.

### "REVIEW" Button

When this button is pressed, the picture moves quickly in reverse direction (about 8 times the normal playback speed) and you can search for the desired part of the program.

### "REW"ind Button

Used to rewind the tape.

### "FF" Button

Used to fast forward the tape.

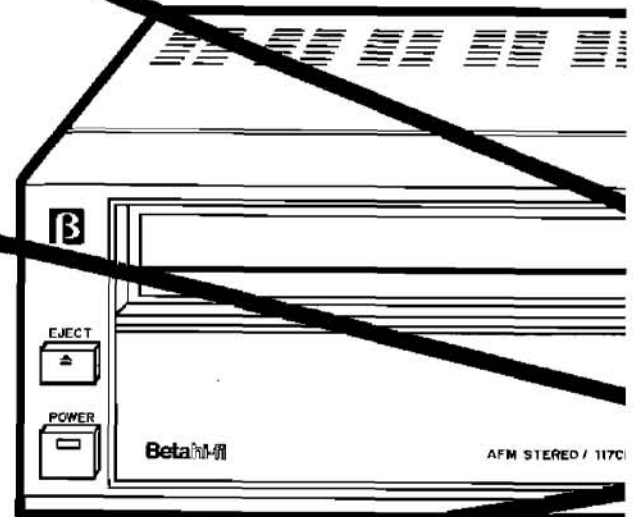

**"CATV" Indicator Lamp**

To indicate the "STD/CATV" switch is set to "CATV" position.

Clock Display

Channel Indicator

**COUNTER "RESET" Button**

Used to set the tape counter to the "0000" indication or play time to the "0-00" indication.

**COUNTER "MEMORY" Switch**

Used for tape counter memory operation.

**TIMER Section**

Buttons for setting the programmable timer are behind this door.

**CHANNEL Buttons**

Used to select the channel you wish to view or record.

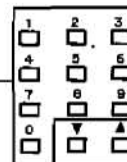

10-KEY Channel Buttons

Channel UP/DOWN Buttons

Tape "Counter/Playtime" display

**"CUE" Button**

When this button is pressed, the picture moves quickly in the forward direction (about 8 times the normal speed) and you can search for the desired part of the program.

**"COUNTER/PLAYTIME" Selector Button**

Pushing the button alternately selects the display functions of tape counter and tape running time in hour and minute.

The time display is reset to "0-00" when Betascan (reverse and forward search). Rewind and fast forward are activated, but the 4-digit counter display keeps counting. When "EJECT" is activated, either display is reset to "0000" for the tape counter function.

## FRONT PANEL

### Switches for Beta hi-fi Record/Playback

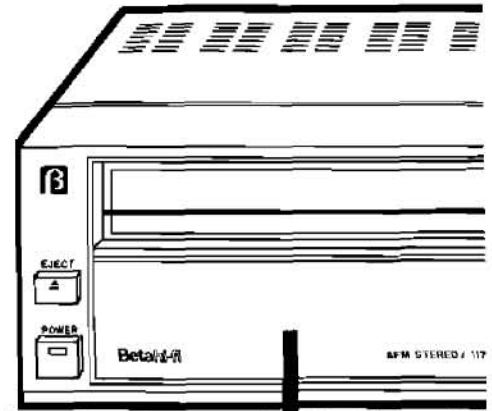

#### "Beta hi-fi" Switch

Selects both recording and playback of Beta hi-fi sound. (see page 33 for details.)

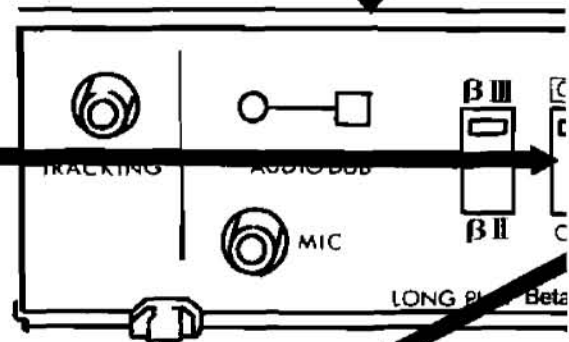

#### "INPUT" Selector

Selects input sources for recording. (See page 35-36 for details)

at "AUDIO ONLY" position

-- Audio sound only with no picture from line.

at "LINE" position

-- Both sound and picture from other equipment.

at "TV" position

-- Both sound and picture from TV.



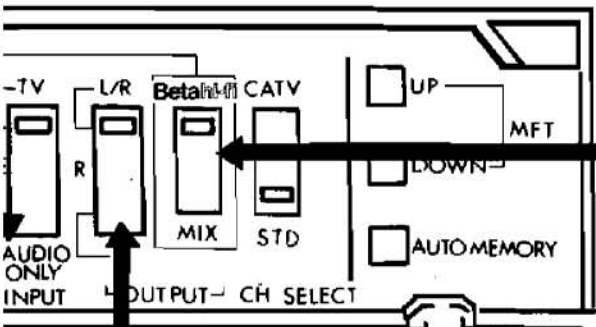
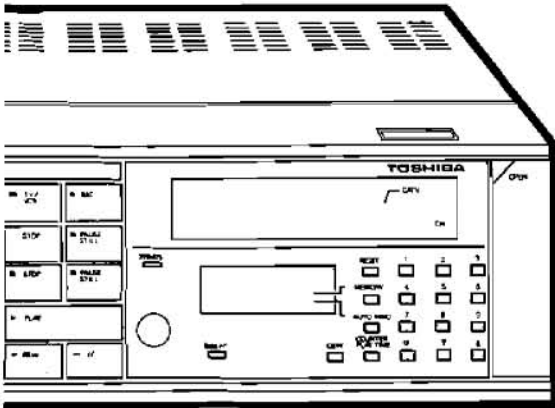

**"Beta hi-fi/MIX" Selector**

Selects audio sound tracks.

at "Beta hi-fi" position

-- Selects helically scanned Beta hi-fi stereo sound tracks.

at "MIX" position

-- Selects both the Beta hi-fi stereo sound and the conventional horizontal monaural sound track simultaneously.

**Audio "OUTPUT" Channel Selector**

Selects audio outputs of a "recorded by Beta hi-fi" system (See page 33 for details.)

at "R" position

-- Selects right channel of helically scanned Beta hi-fi stereo sound.

at "L" position

-- Selects left channel of helically scanned Beta hi-fi stereo sound.

at "R/L" position

-- Selects both R/L channel of helically scanned Beta hi-fi stereo sound.

The above three positions have no bearing for playback of a tape that is not recorded by Beta hi-fi system. The level of "AUDIO OUT" connector is 0.25 Vrms.

## FRONT PANEL

### "AUDIO DUB"bing Button

Allows you to record your own sound on a previously-recorded cassette using either a microphone or audio system. The previously recorded sound will be automatically erased during this process.

### "TRACKING" CONTROL

Used when playing tape recorded by other Beta system machines. Adjust this control to minimize black streaks across the TV picture during playback. Allow a second or two for the new settings of this control to take effect. Always return this control to its central position after use. This position is indicated by a definite notch which can be felt as the control is turned.

When playing back tapes recorded on this VCR, this control should be in the center position.

### "MIC" Jack

Used for connecting a microphone for dubbing sound onto a tape, or for use with a video camera. When a microphone is inserted in this jack during recording, the TV sound is disconnected and sound from the microphone is recorded. Unplug microphone when it is not being used.

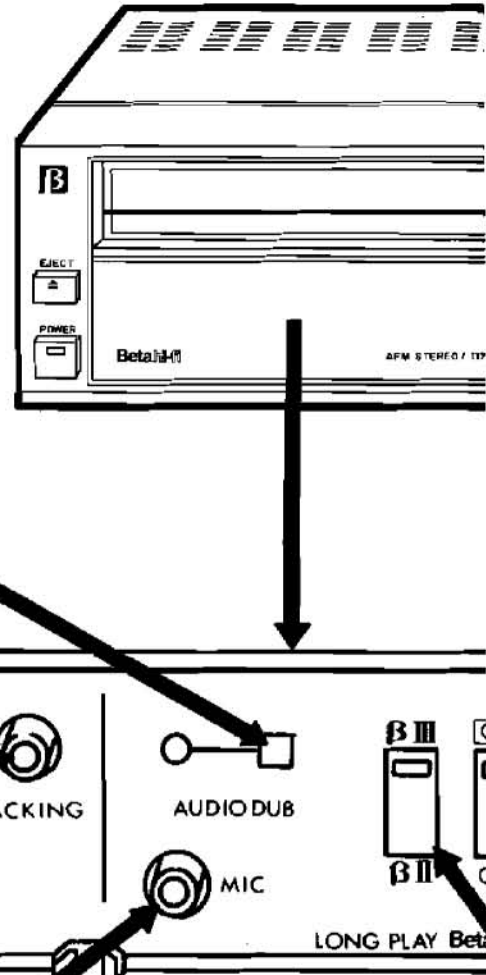

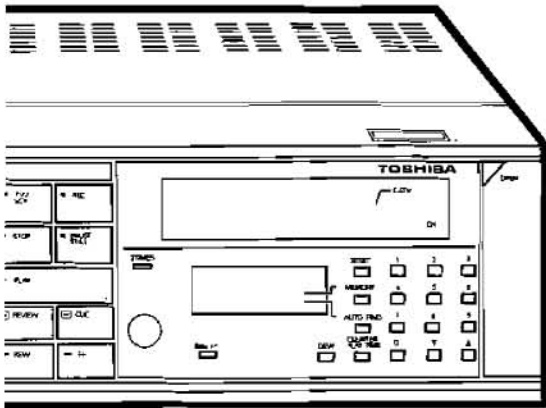

**"CATV/STD" Switch**  
 Selects CATV or standard channels.

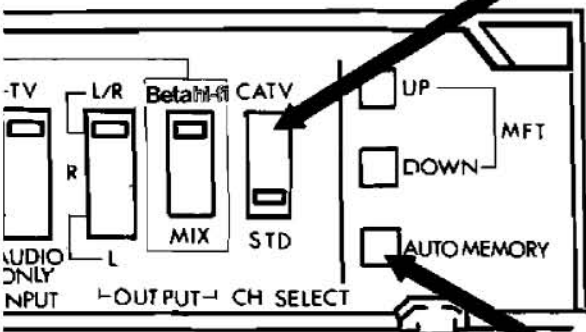

**"MFT" (Manual Fine Tuning)**  
 If the picture is poor on CATV or standard channels, use these buttons to fine tune for best picture.

**Tape Speed ("LONG PLAY") Switch**  
 Selects the tape speed in the recording mode. In the playback mode, tape speed is automatically changed to correct playback speed regardless of this switch position.

Mode Cassette	Cassette Record Time	
	$\beta$ II	$\beta$ III
L250	60min	90min
L500	120min	180min
L750	180min	270min
L830	200min	300min

**"AUTO MEMORY" Switch**  
 In case "POWER" switch has been pressed "ON" before the antenna connection, simply press the button. Then, memorizing the active channels in your area will be automatically achieved with a rapid successive indication of the channel number display.

It is not necessary to operate this button, when the "POWER" switch is pressed after the antenna connection is made to the VCR, when initially installing VCR.

**NOTE**  
 Auto Memory operation will work with standard channel only. It will not work with CATV channel.

## REAR PANEL

### "VIDEO OUT"

Standard video (1.0Vp-p at 75-ohms) is available at this jack for use with an other video recorder or TV monitor.

### "ANTENNA IN"

Lead wire from antenna connects to this 75-ohm input.

### AC Power Supply Outlet (Unswitched)

This receptacle supplies AC 120V, 60Hz (max. 400 watts). Power is supplied regardless of the power switch mode. (on or off.)

### Power Cord

Connect this cord into the AC outlet (AC 120V).

### VCR/VHF OUTPUT Channel Selector Switch

Set this Switch to a locally inactive channel (Ch 3 or Ch 4); If channel 3 is in use in your area, set this switch to the Channel 4 position. When playing back a recorded tape, the TV set must be set to the same channel.

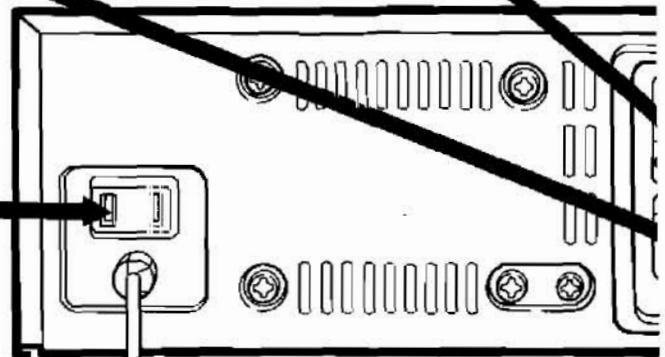

### "VIDEO IN"

Used with a video camera for recording home movies. Connecting a plug into this jack cuts off the picture from the tuner and records the video input connected into this jack. Disconnecting the plug automatically resumes the picture from the tuner.

### "AUDIO IN" (R and L)

Used with a video camera (with microphone) for home movies or for recording audio coming from other audio equipment. The level at these jacks is 0.25 Vrms.

### "AUDIO OUT" (R and L)

The audio that is supplied to the television monitor is also available at these jacks. It can be connected to an external audio amplifier. The level at these jacks is 0.25 Vrms.

### "TELEVISION OUT"

Connect this terminal to your television ANTENNA terminals, using the accessories provided.

### "CAMERA REMOTE" Jack

You can start and stop recording by a trigger switch on the camera when you connect the trigger output of the camera to this jack.

### "Note to CATV system installer:

This reminder is provided to call the CATV system installer's attention to Article 820-22 of the NEC that provides guidelines for proper grounding and, in particular, specifies that the cable ground shall be connected to the grounding system of the building, as close to the point of cable entry as practical".

# REMOTE CONTROL UNIT

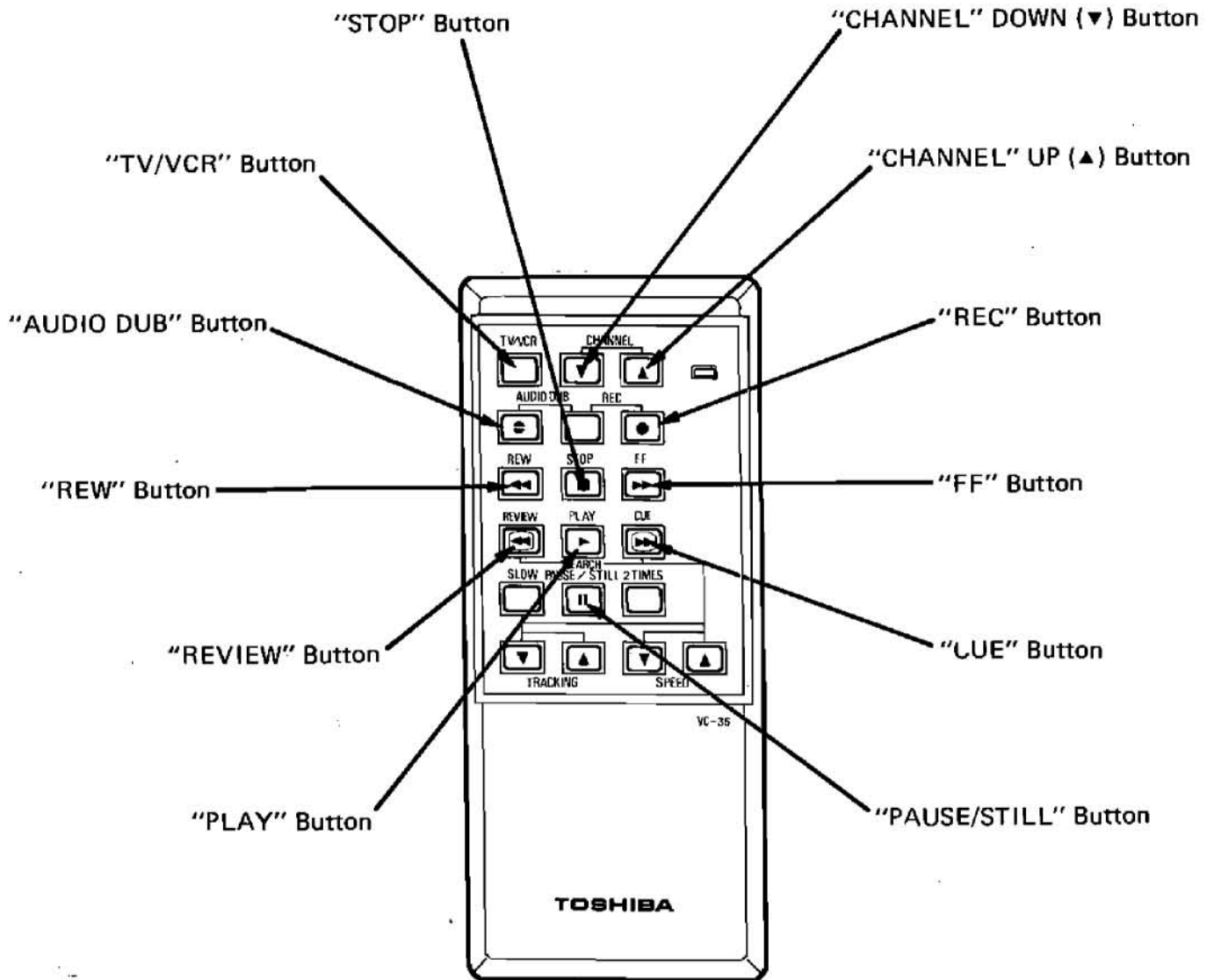

These buttons function same as from the VCR.

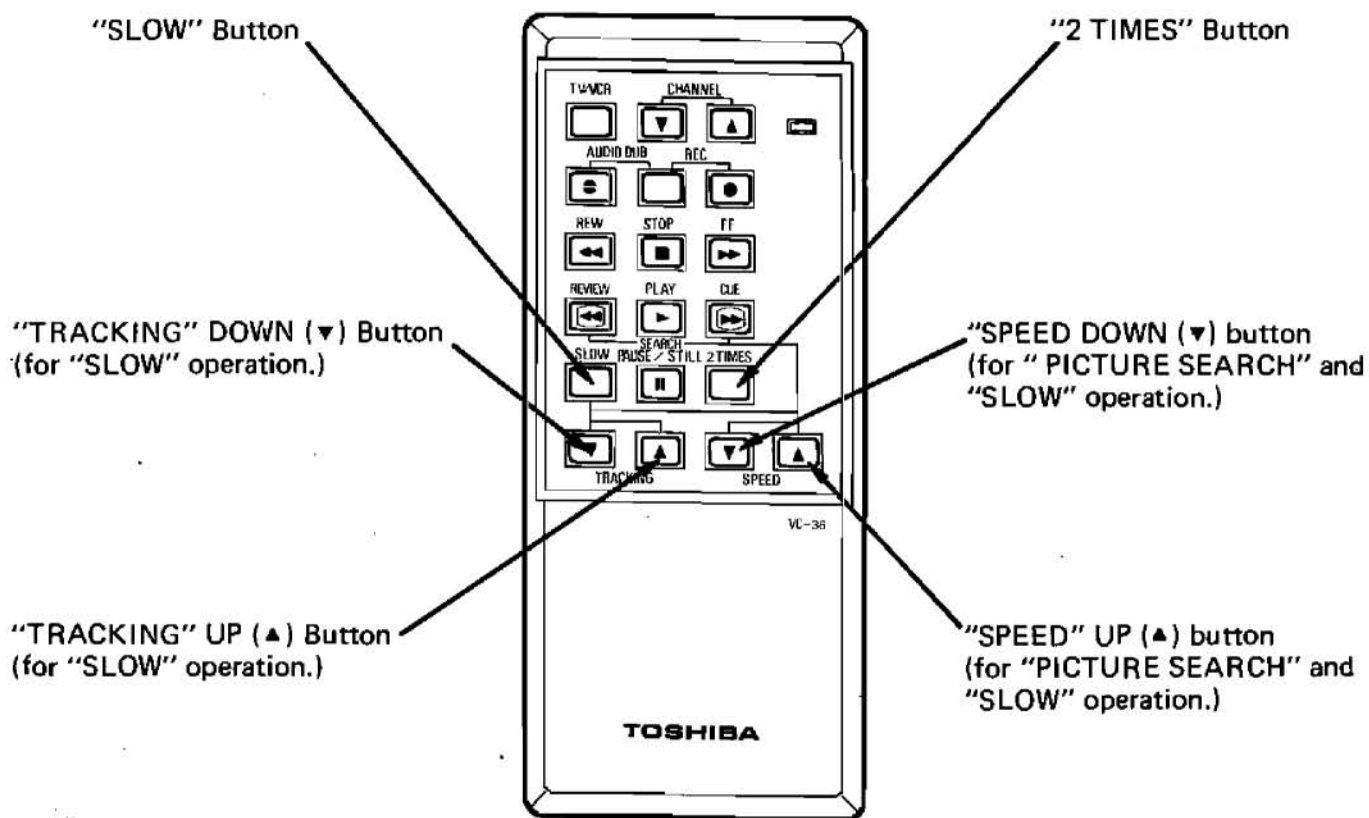

The function of these buttons is available only from this unit.  
 (see Pages 31 and 32 for details.)

## AUDIO DUBBING

Audio dubbing is used to record narration or music on pre-recorded tapes.

1. Turn ON the "POWER" switches of the VCR and TV receiver.
2. Set the TV channel selector to the VCR CHANNEL (Channel 3 or 4).
3. Insert the cassette into the compartment.
4. Set the "TV/VCR" switch to "VCR" position.
5. Set the "INPUT" selector switch to "LINE" position.

6. The sound to be recorded may be Television Sound, Audio connected to the "AUDIO IN" jack or from a microphone connected to the "MIC" jack.
7. Press the "PLAY" button.
8. When the tape comes to the point where you want to dub the sound, press the "PAUSE/STILL" button.
9. Then press the "AUDIO DUB" button.
10. Press the "PAUSE/STILL" button again to start the dubbing.
11. Press the "STOP" button to stop the dubbing.

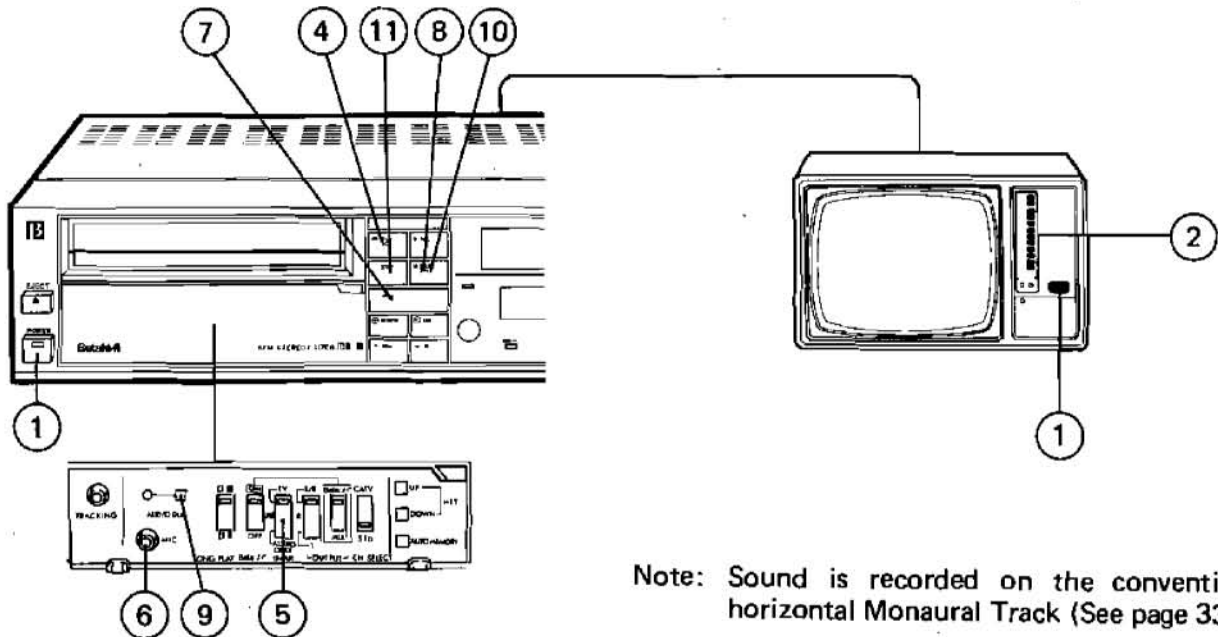

Note: Sound is recorded on the conventional horizontal Monaural Track (See page 33.)

## EDITING RECORDING

1. Push "PLAY" button and watch the program until the exact point is reached where you want the new recording to begin.
2. Push the "PAUSE/STILL" button. Then the television screen will display the still picture.
3. Push the "REC" button. Then the program material to be recorded will appear on the television.

4. When you want to begin recording, push the "PAUSE/STILL" button again. The new program material will directly follow the previously recorded material without interruption. This feature is especially helpful during camera use, so each segment of the recording becomes a continuous program.

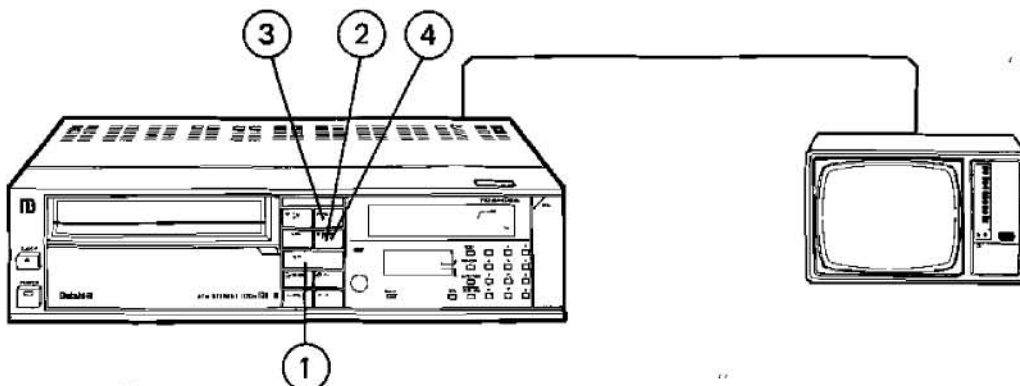



## RECORDING ONE PROGRAM WHILE VIEWING ANOTHER

1. Turn ON the "POWER" switches of the VCR and TV receiver.  
(Set the "INPUT" Selector switch of the VCR to "TV" position.)
2. Set the TV channel selector to the VCR CHANNEL (Ch 3 or Ch 4).
3. Insert the cassette into the compartment.
4. Push the "TV/VCR" switch of VCR and set it to "VCR" position. (The "VCR" lamp lights.)
5. Select the channel which you want to record.
6. Push the "REC" Button of the VCR. The VCR will start recording the program you see on your TV screen.
7. Set the "TV/VCR" switch to "TV". (The lamp goes off.)
8. On your television receiver, select the channel you wish to view. Recording of the other program will continue.

Note: Any connection to "VIDEO IN" jack should be disconnected.

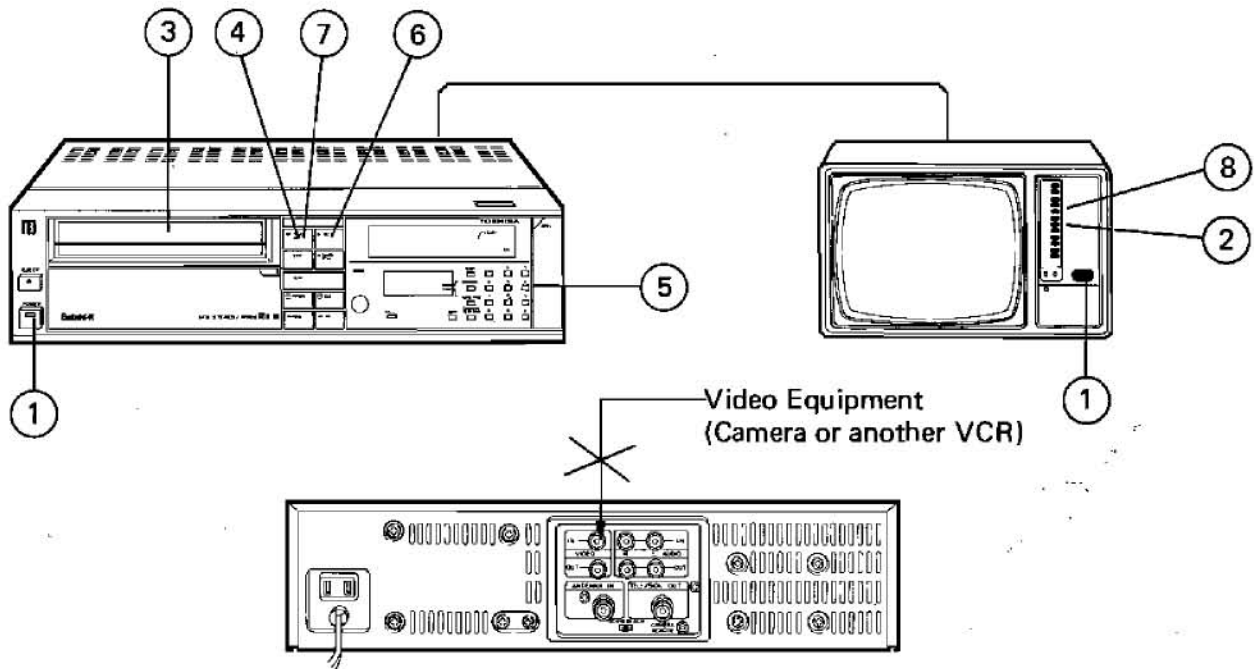

## VCR TO VCR DUBBING

If you wish to exchange or copy some of your friend's favorite home recordings, the following instructions can be used to connect one VCR to another.

1. Connect "VIDEO OUT/AUDIO OUT" of VCR 1 to "VIDEO IN/AUDIO IN" of VCR 2.
2. Play the tape on VCR 1 and record it on VCR 2.

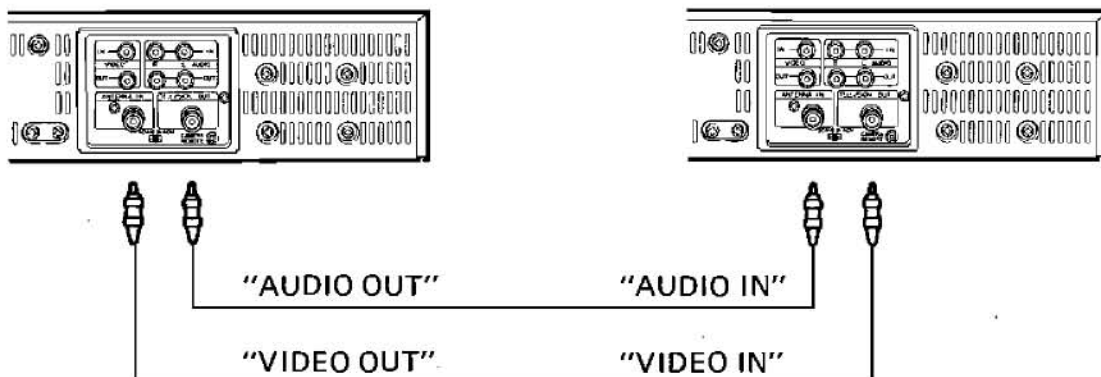

## USING A CAMERA WITH THE VCR

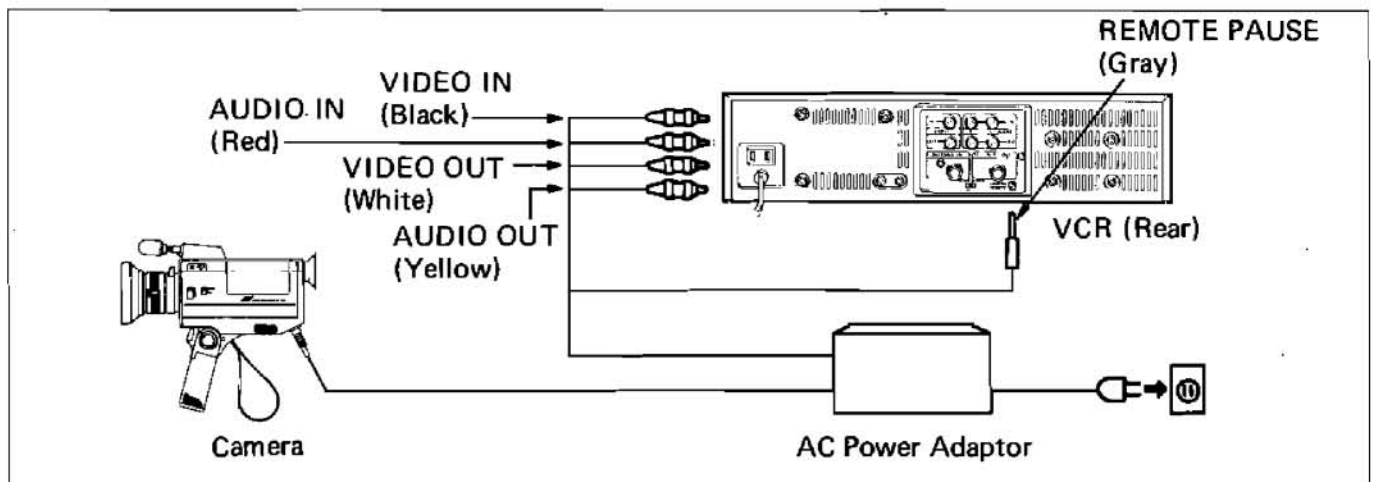

1. Connect your Video Camera to the Camera Terminals on the AC Power Adaptor.
2. Connect the VCR Cable to the VCR Terminal on the AC Adaptor.
3. Connect the VCR Cable to the VCR as follows:
  - A. Connect the Gray Lead to "REMOTE PAUSE".
  - B. Connect the Red Lead to "AUDIO IN".
  - C. Connect the Black Lead to "VIDEO IN".
  - D. Connect the White Lead to "VIDEO OUT".
  - E. Connect the Yellow Lead to "AUDIO OUT".

Note: Other Cameras may also connect to this VCR. For proper connections, consult your Camera Owners Manual.

4. Set the TAPE SPEED ("LONG PLAY") switch to the appropriate position. ( $\beta$ II or  $\beta$ III)
5. Press the VCR "POWER" switch "ON" and set your television set to the VCR channel (3 or 4.)
6. Insert a cassette tape into the cassette compartment.
7. Press the "TV/VCR" switch to the "VCR" position.  
Your television set will act as a monitor of the picture and sound from the camera and microphone. (The microphone is built into the camera.)
8. Push the "REC" button to begin recording. The "REMOTE PAUSE" switch on the camera can be used to stop recording between scenes.

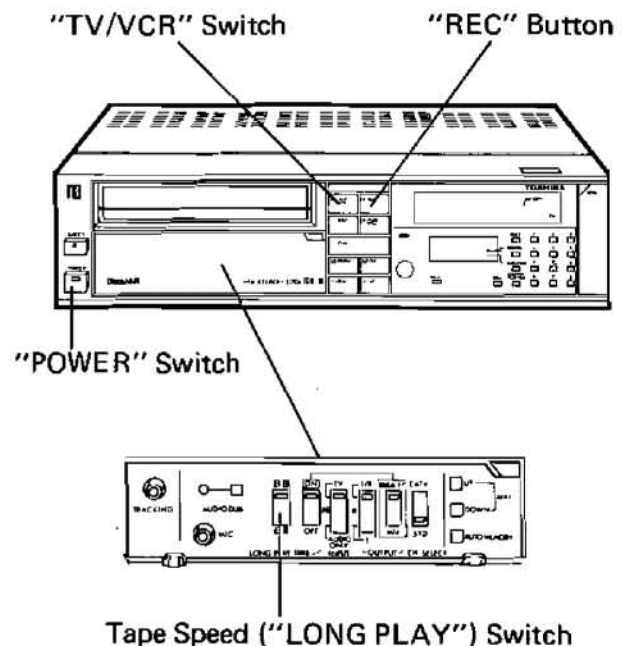

- Notes:
1. Be sure to connect the video output and audio output of the camera into the "VIDEO IN" and "AUDIO IN" of the VCR, when recording with the camera. When connected, the input from the tuner will be cut off. When connected only into the "VIDEO IN" the audio signals of the tuner input will be recorded.
  2. If the volume on the TV is turned too high, audio feedback can cause a squeal or howl to occur.

## PROGRAMMABLE TIMER

- \* The clock used is of the 12-hour type.
- \* Using the timer enables you to preset your VCR as long as 14 days in advance to record up to 8 programs at different times.
- \* The timer also enables you to preset your VCR at the same time every day and/or at the same day of week every week.
- \* Even if the power to the VCR is interrupted, the clock will continue to run and the programming will not be disturbed for about 10 minutes.

After 10 minutes of power interruption, if the clock flashes "SUN" "AM" "12:00", the clock and programming will have to be reset. (During power interruption, there will be no clock display.)

(If the colon flashes, it indicates there has been short power interruption. Then push the "CLOCK SET" switch in the VCR "ON" mode, and flashing will stop.)

### DESCRIPTION OF DISPLAY AND SETTING BUTTONS

The clock display device is used also for programming, and its total display function is as illustrated below:

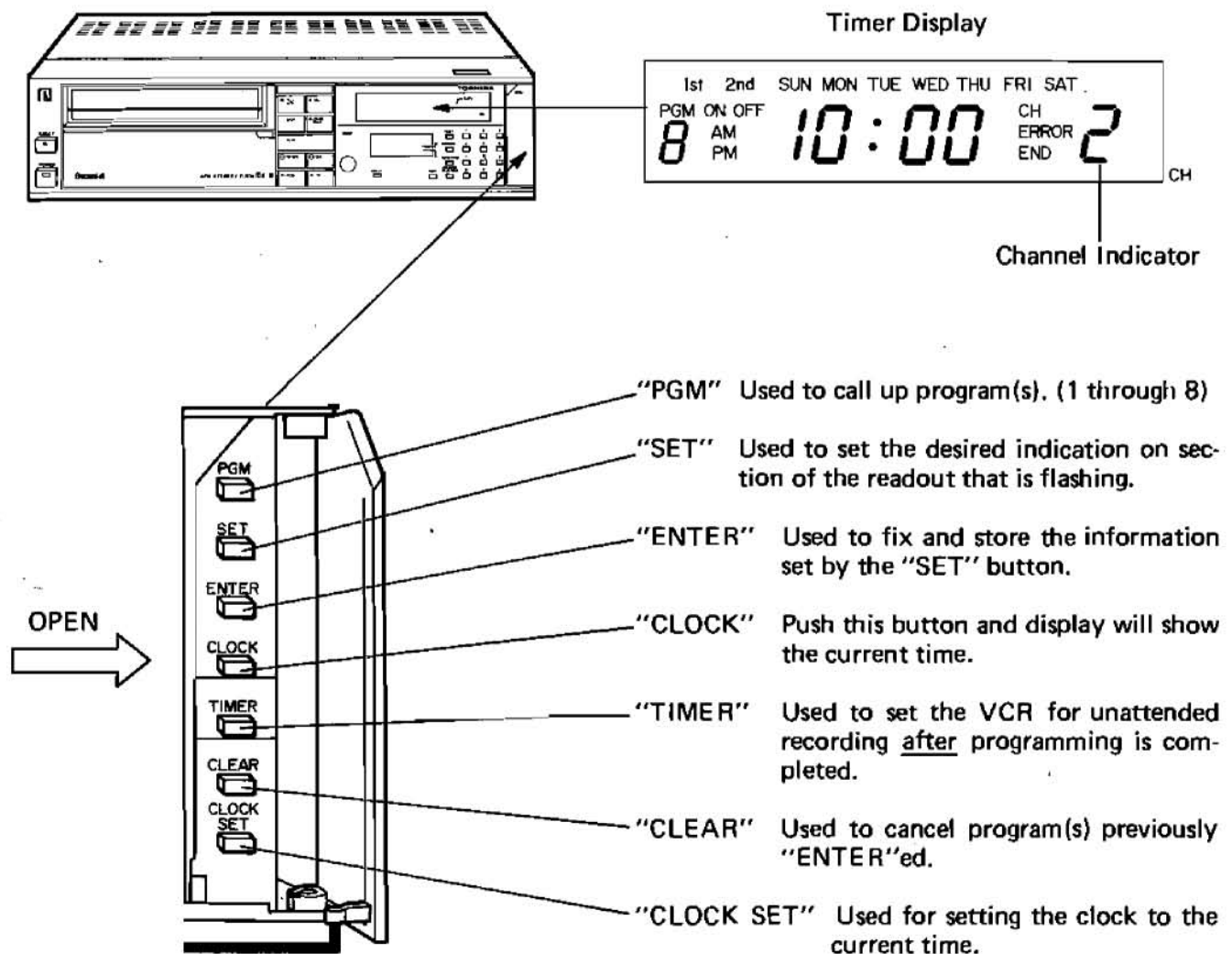

## HOW TO SET THE PROGRAMMABLE TIMER

The programmable timer is capable of storing the memories in the following sequence:

1. Program number (up to 8).
2. 1st, 2nd or both weeks
3. Day of the week
4. Hour digit (for record-starting "ON" time)
5. Tens minute digit (for record-starting "ON" time)
6. The minute digit (for record-starting "ON" time)
7. Hour digit (for record-ending "OFF" time)
8. Tens minute digit (for record-ending "OFF" time)
9. The minute digit (for record-ending "OFF" time)
10. Channel number

Program setting requires use of the following fundamental procedures:

- I. Push the "SET" button to have the desired indication on the flashing portion of the read-out display.
- II. Push the "ENTER" button to fix and store the input or desired information into the memory.

NOTE: The clock must be set to the correct day and time before attempting programming. The following example illustrate the various ways the timer may be programmed.

EXAMPLE I: Program No. 1, Channel 6 on Friday this (1st) week from 8:15 pm to 9:00 pm.

After turning the VCR "ON" by pressing the "POWER" switch,

1. Press the "PGM" (program) button. Program number "1" will be flashing. (For other program numbers, press the "SET" button until you reach the desired number.)
2. Press the "ENTER" button. Then "1st" will be flashing. (For the "2nd" week or both "1st" and "2nd" weeks, press the "SET" button, until you have the desired indication flashing.)
3. Press the "ENTER" button. Then "SUN" will be flashing.
4. Press the "SET" button until the day is "FRI".
5. Press the "ENTER" button. Then the hour indicator "--" will be flashing.
6. Press the "SET" button until the hour reads "PM 8".
7. Press the "ENTER" button. Then tens minute digit will be flashing.
8. Press the "SET" button until the tens minute digit reads "1".
9. Press the "ENTER" button. Then the minute digit "--" will be flashing.
10. Press the "SET" button until the minute digit reads "5".

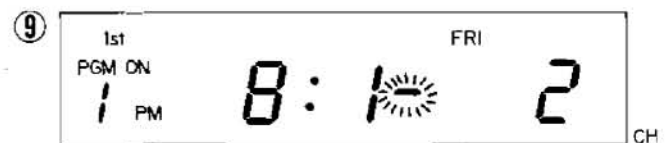
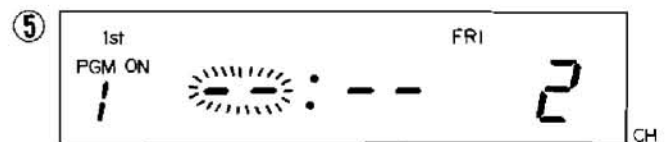
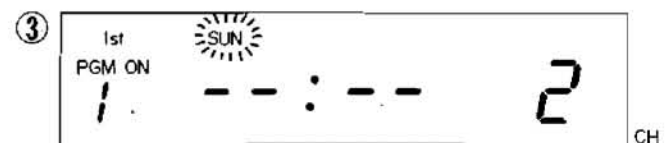
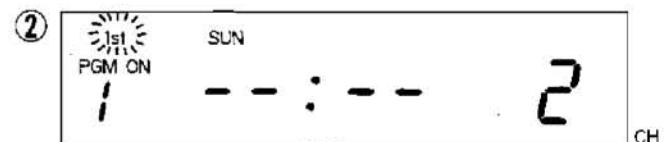
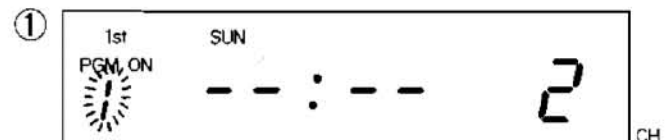

11. Press the "ENTER" button. Then "OFF" display will appear with "PM" and "8" flashing, being ready for the "OFF" time setting.
12. Set the "OFF" time to "PM" "9:00" in the same manner as in the above 6) through 11). Then "CH" will now be flashing.
13. Select Channel 6 by pushing "0" and "6" on the 10-key buttons.
14. Press the "ENTER" button. Then the "END" will appear. Program No. 1 has now been set.
15. For program No. 2 press the "ENTER" button again. Then, "2" will be flashing, being ready for next program.

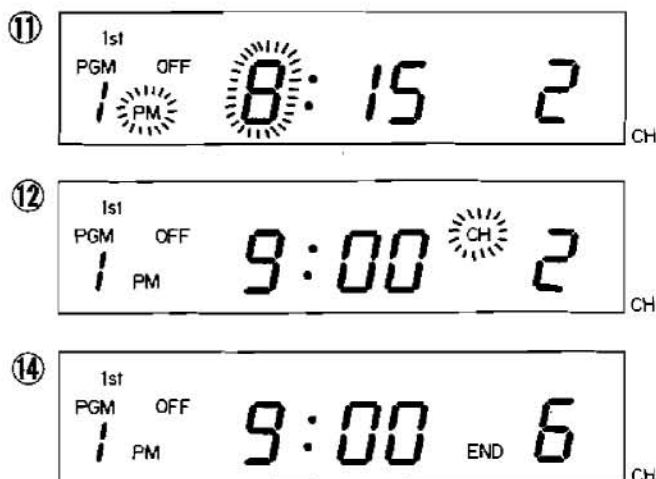

- Notes: 1) If you do not wish to set another program, press the "CLOCK" button and then the "TIMER" button.
- 2) By pressing the "TIMER" button after completing program(s) as in the above Note 1), your VCR is all set for unattended timer recording. Be sure to read "Important Notes" on page 27.

EXAMPLE II: Program No. 2, Channel 24 on Wednesday next (2nd) week from 6:00 am to 6:30 am.

1. Follow the same steps 1) and 2) as in the above EXAMPLE I.
2. Press the "SET" button until "2nd" is flashing.
3. Follow the same steps 3) through 14) as in the above EXAMPLE I.

EXAMPLE III: Program No. 3, Channel 8, every day of the week from 11:00 pm to 11:15 pm.

1. Follow the same steps 1) and 2) as in the above EXAMPLE I.
2. Press the "SET" button until both "1st" and "2nd" are flashing. Press the "ENTER" button. Then "MON" will be flashing.
3. Press the "SET" button until the days of week are all flashing ("SUN MON TUE WED THU FRI SAT").
4. Follow the same steps 3) through 14) as in the above EXAMPLE I.

EXAMPLE IV: Program No. 4, Channel 10, every Saturday from 7:00 pm to 7:30 pm.

1. Follow the same steps 1) and 2) as in the above EXAMPLE I.
2. Press the "SET" button until both "1st" and "2nd" are flashing.
3. Follow the same steps 3) through 14) as in the above EXAMPLE I.

Note: The 14 days' period is divided into the "1st" and "2nd" weeks, and the time span of each week for the timer memory is calculated as illustrated below:

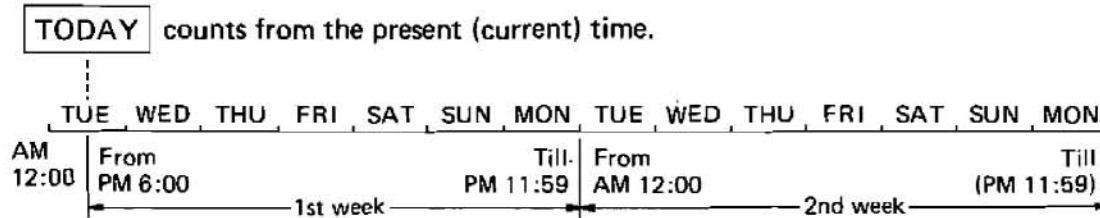

### Important Notes:

1. The "Power" Switch must be "ON" when programming the Timer.
2. After programming is completed, push the "CLOCK" button and push the "Timer" button.
3. It is not necessary to push the "REC" button as this is automatic in the "TIMER" Mode.
4. "ERROR" will be flashing after the "TIMER" button is pressed in the cases when:
  - a) A cassette tape is not loaded into VCR.
  - b) The safety tab of cassette tape is removed.
5. "ERROR" will light up during program setting in the cases when:
  - a) Programs overlap in time. The first (earlier) program will be executed, however, interrupted and switched over to the second (later) program, when the time comes.
6. Both the "ON" and "OFF" are at the same time. (Program will not be executed.)
7. The "everyday" and "same day everyweek" programs will stay memorized unless cleared by the "CLEAR" button. (Other programs will go off after they are executed.)
7. When the "TIMER" button is pressed for unattended recording, the program display will indicate the program which is to be executed earliest in time for about 5 seconds and then automatically switched back to the clock display.

## CONFIRMING THAT PROGRAMS ARE PRESET

1. Push the "POWER" switch "ON".
  2. Push the "PGM" button to have a timer display. (Program number will be flashing.)
  3. Push the "SET" button to move to next program. (The program of the "ON" time will be displayed.)
- Note: The displays of the "ON" and "OFF" times will alternately appear, if the "SET" button is held pressed.
4. After confirming the programs, be sure to push the "TIMER" button.
- Note: The clock and timer display alternately appear if the button is held pressed.

## TO CANCEL PREVIOUSLY TIMED PROGRAM (S)

1. Push the "POWER" switch "ON".
2. Push the "PGM" button to have a timer display.
3. Press the "SET" button to recall the program you desire to cancel.
4. Push the "CLEAR" button. Then the program will be cleared.
5. Repeat steps 2) through 4) for cancelling other program 6.

## USING THE "PICTURE SEARCH" (CUE AND REVIEW) FEATURES

This VCR is featured to provide Forward and Reverse visible search for both  $\beta$ II and  $\beta$ III recording.

1. When the "SEARCH" Button is pressed, the picture moves quickly in reverse or forward direction and you can search for the desired parts of the program.
2. When you want to return to the normal playback mode, press the "PLAY" button.
3. You can also operate picture search by using the Remote Control unit.

Notes: 1. The search speed is 8 times normal playback speed when operated at VCR's control panels.

2. The speed is 5 ~ 20 times adjustable when operated at the Remote Control Unit.

4. During picture search operation, a few noise bars will appear on the playback picture.
5. During picture search operation, if the picture flows vertically on the TV screen, adjust the V-HOLD Knob on the TV set.
6. During picture search operation, the speed will be increased up to the same speed as the normal fast forward or rewind speed if there is nothing recorded on the tape.
7. During picture search operation, the sound will be muted.
8. During picture search operation, the color may be lost temporarily where frequent scene changes are recorded.

"SEARCH" Button  
(8 times normal playback)

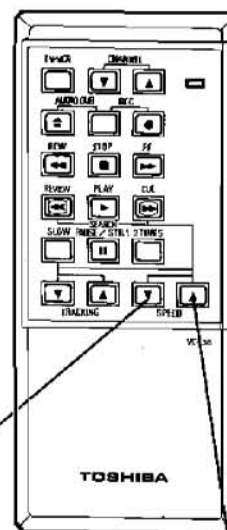
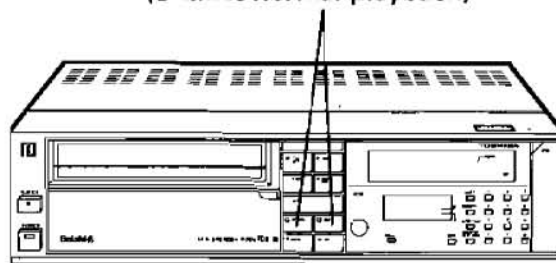

SPEED "DOWN (▼)" Button  
(MIN. 5 times normal playback)

SPEED "UP (▲)" Button  
(MAX. 20 times normal playback)

## USING THE "AUTO FIND" FEATURE

This VCR automatically inserts a signal on the tape when each recording starts. During subsequent rewind or fast forward operations, if the "AUTO FIND" switch is in the "ON" position, the tape will stop as the beginning of each recording is reached. If you want to resume rewind or fast forward, simply push the "REW"ind or "FF" (Fast Forward) button to continue to the start of next recording.

- Notes:
1. "Auto Find" can only stop the tape in the REWIND or Fast Forward Mode.
  2. This "AUTO FIND" function cannot be used with the tape recorded by other VCRs without "AUTO FIND" function.

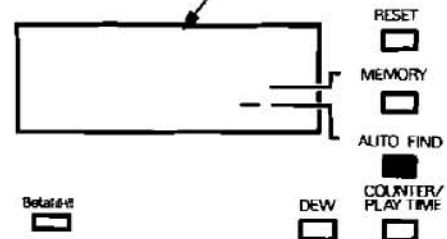
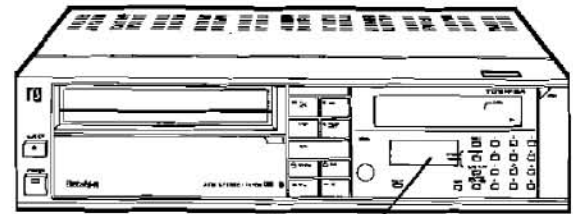

## USING THE "MEMORY" FEATURE

The memory feature allows you to return to a specific spot on the tape after recording or playback. The memory works together with the counter and is designed to stop when the counter reaches "0000" during rewind (REW). When the "MEMORY" button is pressed, "M" is indicated on the right side of the counter display.

This feature is especially helpful when using a camera or when editing a recording.

1. Push the "RESET" button. Counter will read "0000".
2. Push the "MEMORY" button, "M" is indicated on the right side of the counter display.
3. Continue playback or recording until it is desired to return to the selected spot.
4. Push the "STOP" button.
5. Push the "REW" button. The tape will be rewound to the spot selected.

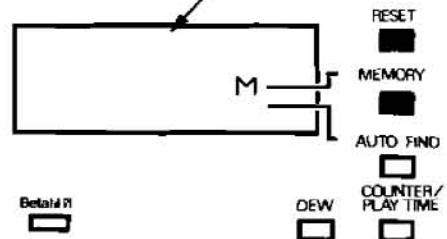
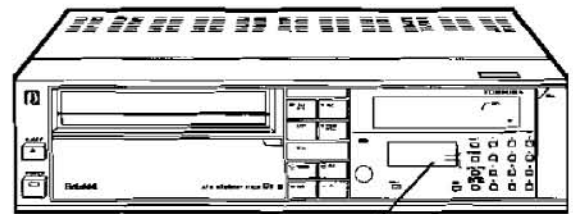



## USING THE TAPE "COUNTER/PLAY" TIME FEATURE

The "COUNTER/PLAY TIME" button has dual functions. One is Counter display and another is PLAY TIME display.

### COUNTER DISPLAY

1. When the VCR is turned "ON", the display automatically function as a four-digit tape "COUNTER".
2. Push the "RESET" button to reset the display to "0000".

### PLAY TIME DISPLAY

1. Push the "COUNTER/PLAY TIME" button to shift the display to count the recording/playback time in hours and minutes.
2. Push the "RESET" button to reset the display to "0-00".

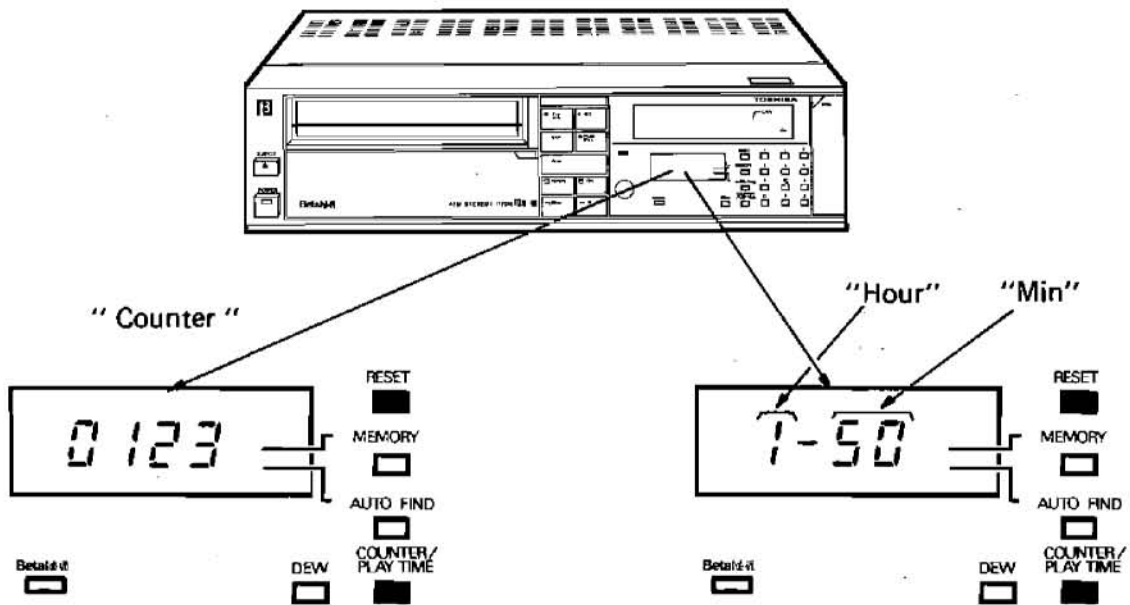

## TIME/TAPE COUNTER CHART

The following chart indicates an approximate relation between Record/Playback time and the tape counter display.

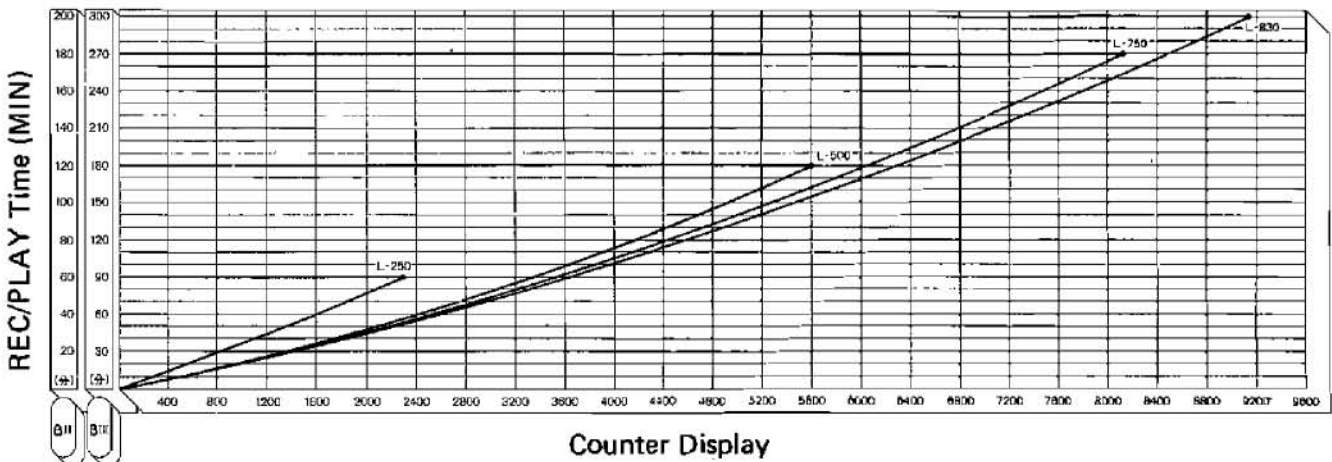

## HOW TO INSTALL BATTERIES IN THE REMOTE CONTROL UNIT

Remove the battery cover on the reverse side of the unit.

Install 3 batteries ("AA" size) into the unit.

Close the battery cover.

Note: Carefully install batteries to match the polarity diagrams.

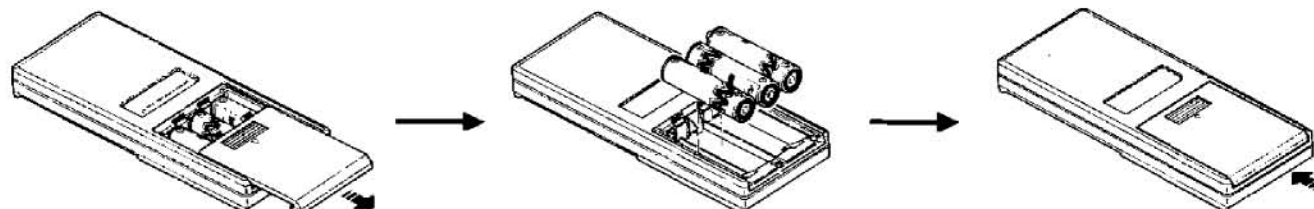

## REMOTE CONTROL OPERATION RANGE

The Remote Control must have "Line of Sight" to the receiver on the front of the VCR. It must be within an angle of 30° either side of center. The maximum operating distance is 23 feet.

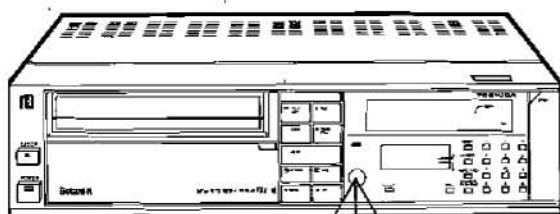

FRONT  
END

Point the Front End of the Remote Control at the VCR.

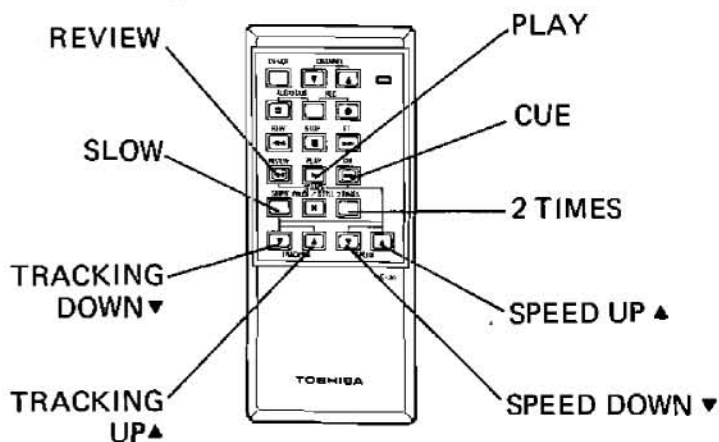
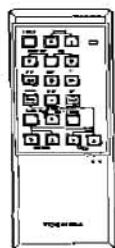

## USING THE REMOTE CONTROL SPECIAL FEATURES

Remote Control Operation incorporates the following special functions marked with (\*). All other functions are the same as those operated from the VCR.

1. TV/VCR
2. CHANNEL UP
3. CHANNEL DOWN
4. AUDIO DUB
5. REC
6. REW
7. STOP
8. FF
9. REVIEW
- \*10. REVIEW SPEED UP  
(MAX 20 Times normal speed)
- \*11. REVIEW SPEED DOWN  
(MIN 5 Times normal speed)
12. CUE
- \*13. CUE SPEED UP  
(MAX 20 Times normal speed)
- \*14. CUE SPEED DOWN  
(MIN 5 Times normal speed)
15. PLAY
- \*16. SLOW
- \*17. SLOW TRACKING UP
- \*18. SLOW TRACKING DOWN
- \*19. SLOW SPEED UP  
(MAX 1/3 Times normal speed)
- \*20. SLOW SPEED DOWN  
(MIN 1/30 Times normal speed)
21. PAUSE/STILL
- \*22. 2 TIMES

## FORWARD SLOW

1. Press the "PLAY" button.
2. Press the "SLOW" button.
3. Adjust (▲) or (▼) button to change the speed to 1/3 ~ 1/30 of normal speed.
4. If visual 'noise' occurs during slow motion, adjust the tracking button (▲) or (▼).
5. Push "PLAY" button to return to normal play.

But in rare case, there has been remained noise when playing back a recorded tape with other VCR.

- Notes:
1. The "SLOW" mode will cease automatically after a lapse of approximately 5 minutes, and the VCR will return to normal playback mode.
  2. During "FORWARD SLOW" operation, the sound will be muted.
  3. During "FORWARD SLOW" operation, the picture may move slightly up and down in  $\beta$ II mode.

## DOUBLE SPEED PLAYBACK

1. Press the "2 TIMES" button. The "2 TIMES" indicator will light.
2. Press the "PLAY" button. The VCR will return to the normal playback mode.

- Notes:
1. During Double Speed Playback operation, the sound is not muted.
  2. If visual "noise" occurs during Double Speed Playback, adjust the "TRACKING" control of VCR.

## VARIABLE "SEARCH" (5 ~ 20 times normal playback)

1. Press the "CUE" or "REVIEW" button.
2. Adjust "SPEED" buttons "▼" or "▲" to change the speed to 5 ~ 20 times the normal playback.

# SPECIAL FEATURE: "BETA hi-fi" SOUND SYSTEM

What is "Beta hi-fi"?

"Beta hi-fi" sound is a helically-scanned FM sound recording system with very high relative tape writing speed. The sound quality is of extraordinary high fidelity as shown in the table below. Whereas ordinary audio cassette decks give a maximum of 2 hours' playing time, the "Beta hi-fi" stereo sound can be enjoyed for as long as 5 hours' continuously.

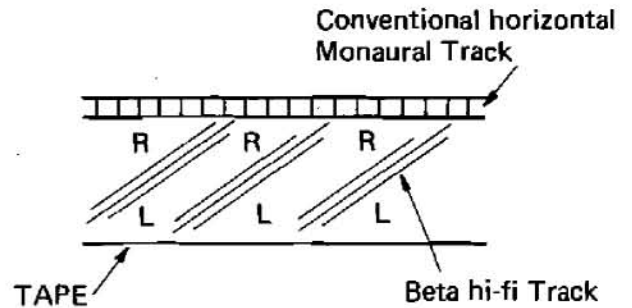

Specification Comparison

Items	Beta hi-fi		Conventional	
Relative tape speed (Audio Track)	<b>B II</b>	6.993m/sec	<b>B II</b>	2.0cm/sec
	<b>B III</b>	7.0m/sec	<b>B III</b>	1.33cm/sec
Frequency Range	20Hz ~ 20KHz		<b>B II</b>	50Hz ~ 8KHz
			<b>B III</b>	50Hz ~ 7KHz
Dynamic Range	More than 80dB		_____	
Distortion	Less than 0.3%		_____	
Crosstalk	More than 60dB		_____	

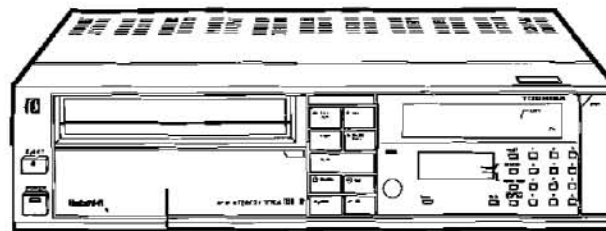

Switches for Beta hi-fi  
(See Pages 13, 14, 35 and 36 for details.)

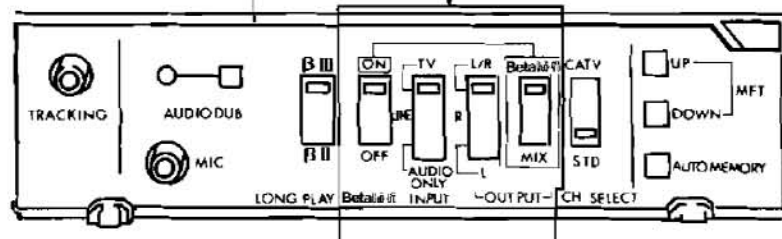

# "BETA hi-fi" RECORDING/PLAYBACK CONNECTIONS

Example I

Color monitor

+

Speaker(s)

+

VCR

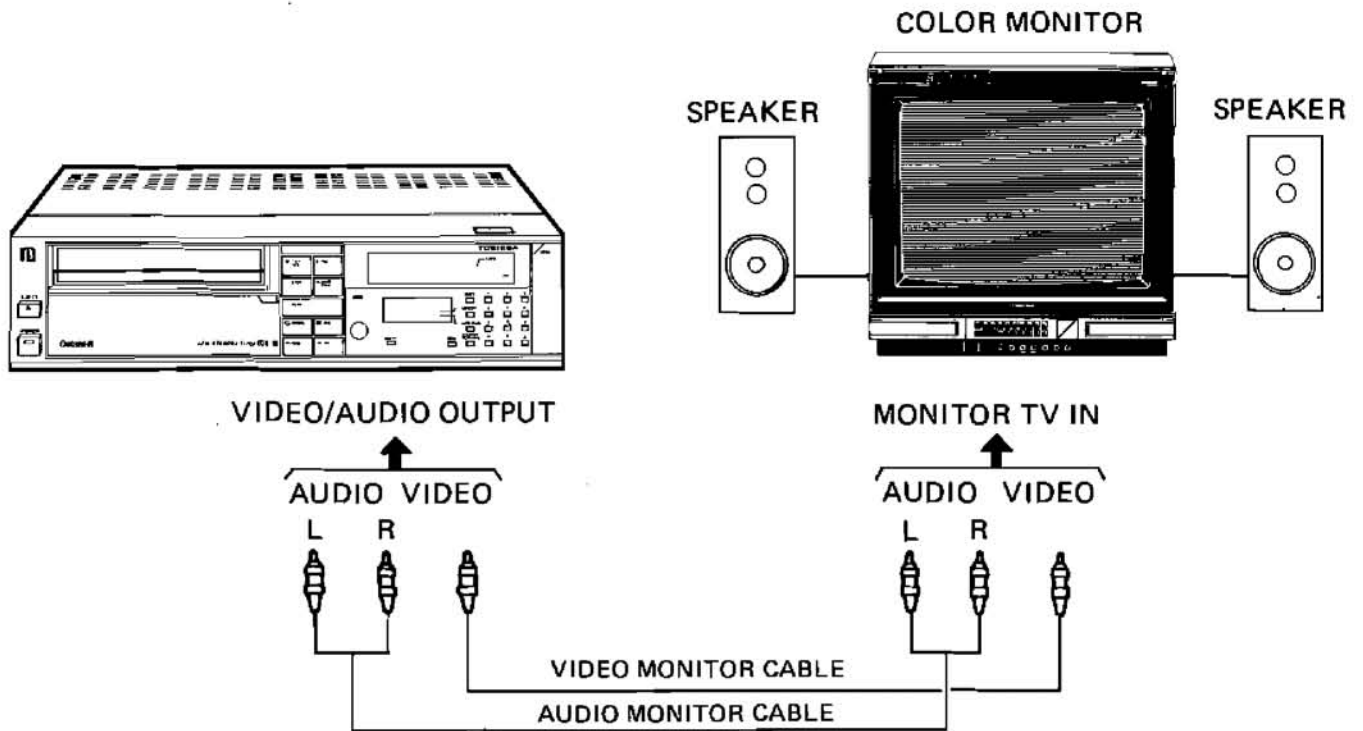

Example II

Stereo Set

+

Color Monitor

+

VCR

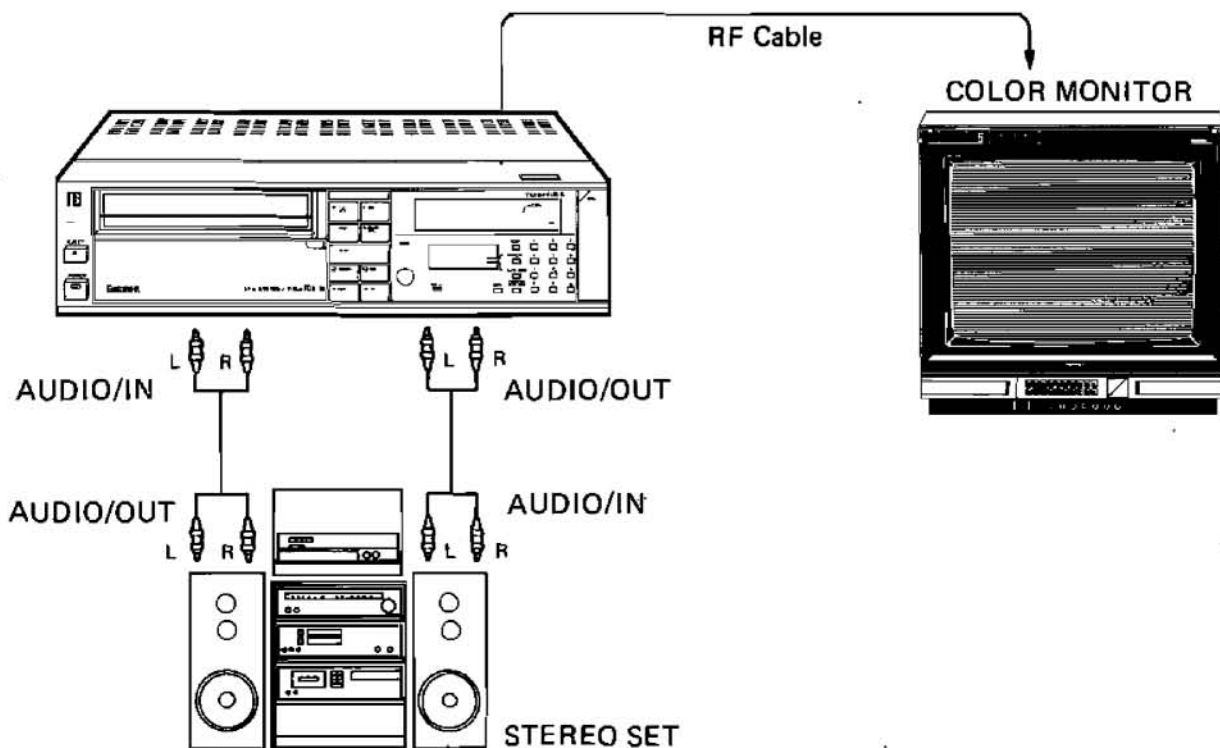

# HOW TO OPERATE SWITCHES TO RECORD A TAPE WITH "BETA hi-fi" SOUND

1. Set the "Beta hi-fi" switch to "ON" position.
  2. Set the audio "INPUT" switch to "TV", "LINE" or "AUDIO ONLY" as illustrated below.
  3. Set the "OUTPUT" switches to "R/L" and "Beta hi-fi" positions respectively.
- Now, ready for recording. See "MAKING A SAMPLE RECORDING and PLAYBACK" on page 8.

Note: These switch positions should stay same for playback of tape.

For "TV" recording

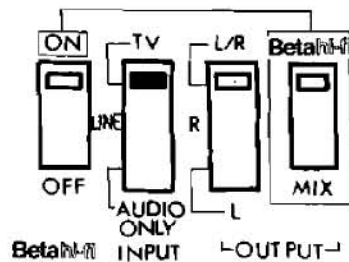

Records both sound and picture from TV.

For "LINE" Recording

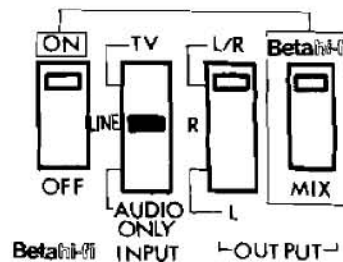

Records sound from audio equipment and picture from TV.

For "AUDIO" recording

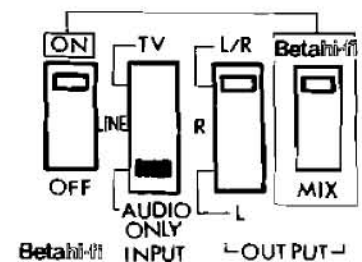

Records sound only from audio equipment. (with No picture)

Note: When the sound noise will occur in playback, adjust the tracking control of the VCR to reduce the noise.

- Notes:
1. When the "Beta hi-fi" switch is in "ON" position, the sound is recorded on both "Beta hi-fi" tracks and the conventional horizontal monaural track.
  2. When a video camera is connected to the "VIDEO IN" jack, it defeats the signal from the tuner.
  3. For playback of the "Beta hi-fi" sound the "OUTPUT" switches should be set in the "R/L" and "Beta hi-fi" positions.
  4. When the "Beta hi-fi" switch is in "OFF" position, set the "OUTPUT" switch to the "R/L" position.

# HOW TO OPERATE SWITCHES TO PLAYBACK A TAPE PRE-RECORDED WITH "BETA hi-fi" SOUND

1. Set the "Beta hi-fi" switch to "ON" position.
2. Set the "Beta hi-fi/MIX" switch to "Beta hi-fi" or "MIX" position.

A) With "Beta hi-fi/MIX" switch set to "Beta hi-fi" position:

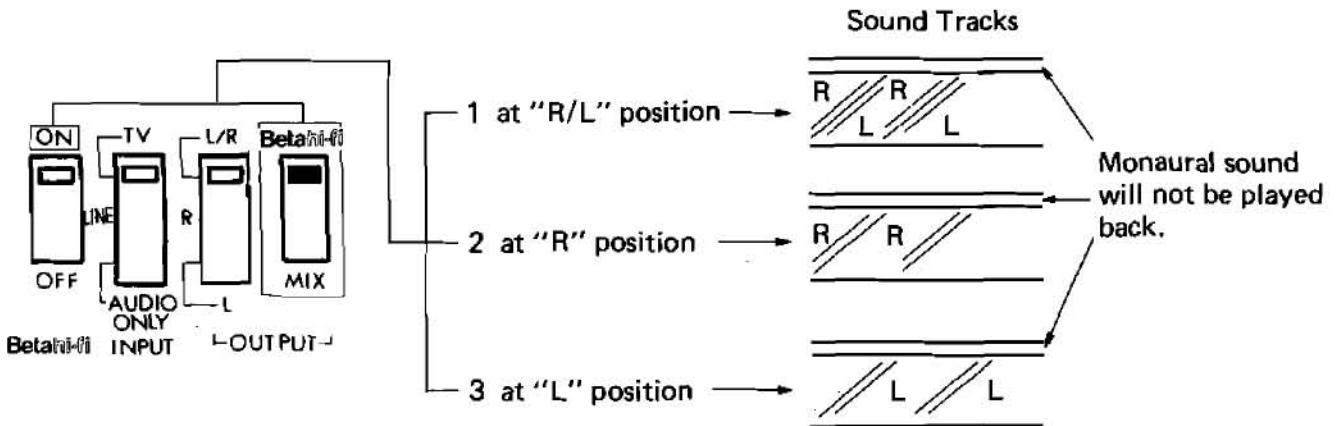

B) With "Beta hi-fi/MIX" switch set to "MIX" position:

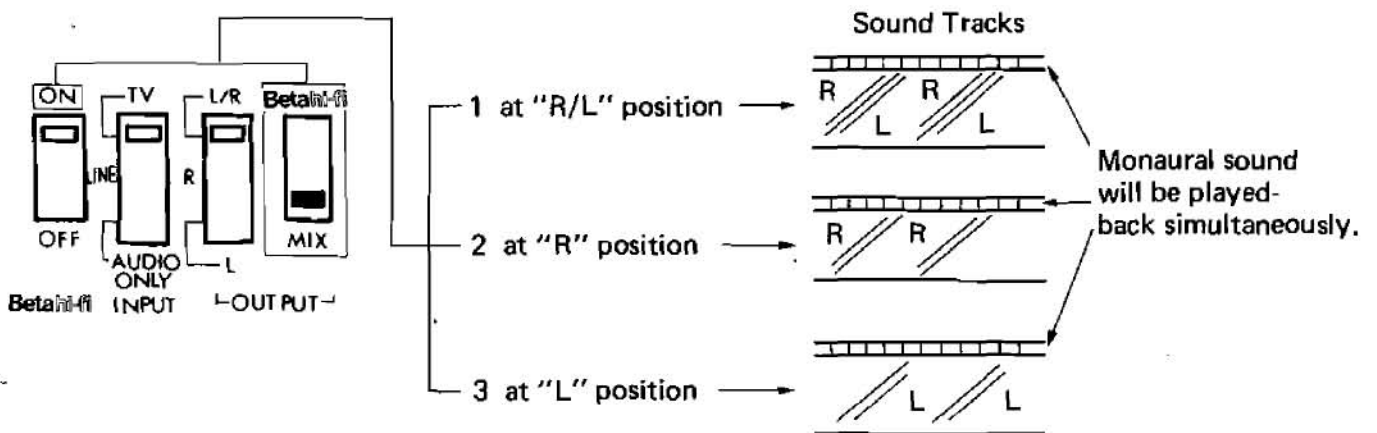

3. Now, ready for playback.

Notes: 1. Regardless of the "Beta hi-fi" switch position, the sound of the tape recorded on the conventional monaural audio track can be played back for compatibility.

2. The "INPUT" selector switch can be in any position for playback.

## DEW WARNING

The light indicates condensation (DEW) on the recorder mechanism. If the VCR is moved from a cold area to a warm area and the humidity is high, moisture can form on the metal surface of the recording mechanism. If this happens the tape could be damaged. To prevent damage the VCR will not operate except for "EJECT". Should the "DEW" Light stay on when the "POWER" Switch is in the "ON" position, press "EJECT" and remove the cassette. Wait for the moisture to dry (until the "DEW" Indicator lamp goes off).

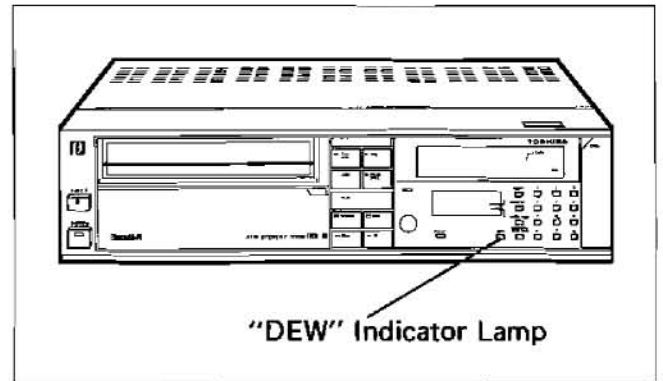

## OPERATING HINTS

- \* After you have finished using the VCR, rewind, eject and remove the cassette. Place the cassette in its protective sleeve to protect it from dust. It is not necessary to rewind the tape before removing the cassette, but if you do, it will be ready to play or record the next time you use it.
- \* Be sure the VCR Channel Selector is on the correct channel you wish to record. The channel that is being recorded can always be checked by setting the television on the VCR channel (3 or 4) and setting the "TV/VCR" switch to "VCR".
- \* Do not attempt to hook up more than one television set to the VCR for either recording or playback.

### ERASE PREVENTION TAB

- \* If you wish to save a recording and prevent accidental erasure, remove the erase prevention tab from the cassette. This will prevent recording on the cassette.



Later, if you wish to record, place a piece of cellophane tape over the opening.

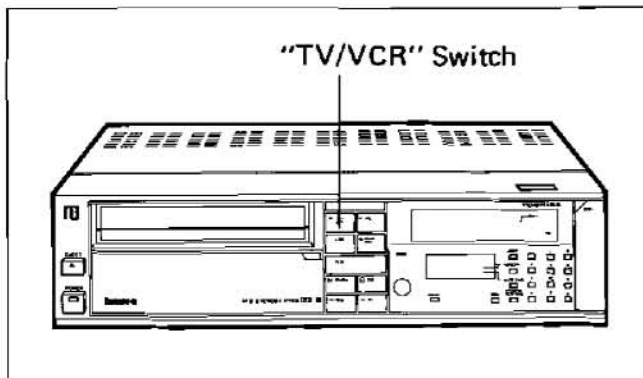



## TROUBLESHOOTING

Your Video Cassette Recorder is a highly sophisticated instrument. It has been carefully checked and adjusted at the factory under the most rigid quality control and inspection systems. However, should problems develop, check the following points and take necessary corrective measures.

### INSERTING OR REMOVING THE CASSETTE

Symptom	Check Point & Correction
Cassette cannot be inserted into Cassette Compartment.	<ul style="list-style-type: none"> <li>* Load cassette in direction indicated by arrow on cassette.</li> <li>* Push the "POWER" switch to ON.</li> </ul>

### RECORDING TV PROGRAMS OFF THE AIR

Symptom	Check Point & Correction
<p>No picture appears on television screen.</p> <p>A picture appears on television screen but is not clear.</p> <p>A picture appears on television screen but there is no sound.</p> <p>The VCR will not go in to the recording mode, even when the "REC" Button is pushed.</p> <p>The VCR will not go in to the recording mode, even when the ("REC" light is not on. "DEW" indicator lamp is on.)</p>	<ul style="list-style-type: none"> <li>* Press the "TV/VCR" switch to "VCR" position.</li> <li>* Set the television to the same channel selected on the RF Channel Selector Switch on bottom rear of VCR. (Channel 3 or 4)</li> <li>* Remove connector from the "VIDEO IN" jack. (if it has been connected.)</li> <li>* Adjust Tuning Controls on VCR and television to obtain the best picture.</li> <li>* When recording off the air, remove connector from the "AUDIO IN" jack.</li> <li>* The cassette has had the erase prevention tab removed. Stick a piece of cellophane tape over erase prevention hole on cassette to reuse cassette.</li> <li>* Wait until "DEW" Indicator lamp goes out.</li> </ul>

### RECORDING WITH VIDEO CAMERA

Symptom	Check Point & Correction
<p>No picture appears on television screen.</p> <p>A picture appears on television screen but is not clear.</p>	<ul style="list-style-type: none"> <li>* Set the television to the VCR channel (3 or 4).</li> <li>* Make required adjustments on the video camera referring to the Owners Manual supplied with the video camera.</li> <li>* Adjust fine tuning knob of television to obtain the best picture.</li> <li>* Adjust camera.</li> <li>* Increase illumination of the subject.</li> </ul>

## PLAYBACK OF PRE-RECORDED CASSETTE

Symptom	Check Point & Correction
<p>No picture appears on television screen when "PLAY" is pushed.</p> <p>No picture, but audio is clear.</p> <p>The VCR will not go in to the play mode, even when the "PLAY" Button is pushed. ("PLAY" Light is not on.) "DEW" Light is on.</p>	<ul style="list-style-type: none"> <li>* Set the television to the VCR channel (3 or 4) depending upon the selected channel on the RF Channel Select Switch at the bottom rear of VCR.</li> <li>* Press "TV/VCR" Switch to "VCR" position.</li> <li>* Try another cassette tape.</li> <li>* Take VCR to Toshiba Authorized Service Store for Service.</li> <li>* Adjust fine tuning knob on television set to obtain the best picture.</li> <li>* Adjust "TRACKING" control.</li> <li>* Wait until "DEW" Light goes out.</li> </ul>

## CLOCK AND DEW LIGHT

Symptom	Check Point & Correction
<p>Time display is flashing.</p> <p>VCR does not start at preset record start time.</p> <p>"DEW" Light remains ON.</p> <p>"PAUSE/STILL" Light remains ON.</p>	<ul style="list-style-type: none"> <li>* Reset time according to instructions. Power has been interrupted.</li> <li>* Set up recording start and up time according to instructions. Be sure the "AM-PM" display is correct.</li> <li>* Push "TIMER" Button.</li> <li>* Condensation on the recorder mechanism -- wait until the VCR has reached normal room temperature, and condensation has dried. "DEW" Light will then go out.</li> <li>* Remote Pause/Still and Switch is in the "PAUSE/STILL" mode.</li> <li>* If camera is being used the trigger switch is in the pause mode.</li> </ul>

## SPECIFICATIONS

Video input	VIDEO LINE IN: 1V (p-p) Phono-type connector 75-ohm unbalanced, sync negative
Video output	VIDEO LINE OUT: 1V (p-p) Phono-type connector 75-ohm unbalanced, sync negative
Audio input	AUDIO LINE IN: Phono-type 50k-ohms, -10dB  MIC IN: Oin-jack more than 600-ohms, -70dB
Audio output	AUDIO LINE OUT: Phono-type, less than 10k-ohms, -7 dB unbalanced -10dB unbalanced (Beta hi-fi)
Fast forward time	With 3.5 min. (L-500)
Rewind time	Within 3.5 min. (L-500)
Dimensions	16-8/16 x 4-2/16 x 15-6/16 inches (W/H/D)
Weight	26.9 lbs.

## WARRANTY

Refer to warranty card concerning warranty.

# TOSHIBA SERVICE PROCEDURE

### IN THE CONTINENTAL UNITED STATES...

Should your unit require service, CALL



IN THE EVENT A PROBLEM SHOULD DEVELOP WITH YOUR PRODUCT, PLEASE PROCEED AS FOLLOWS:

- Step 1: Refer to the troubleshooting guide in your owner's manual. This check list may help to solve your problem.
- Step 2: Contact Toshiba toll free (PH #: 800-631-3811) or a Toshiba Service Center (listed below) and give product category and model number.
- Step 3: Ship the entire product and enclose your receipt to a Toshiba Service Center.

Toshiba America, Inc.  
Service Center  
82 Totowe Road  
Wayna, New Jersey 07470  
Phone Number:  
(201) 628-8000

19500 South Vermont Ave.  
Torrance, Cal. 90502  
Phone Number:  
(213) 538-9960  
(213) 770-3300

2900 MacArthur Blvd.  
Northbrook, Ill 60062  
Phone Number:  
(312) 564-1200

### IN HAWAII...

Toshiba Hawaii Inc.  
Service Department  
327 Kamakee Street,  
Honolulu, Hawaii 96814  
Phone Number:  
(808) 521-5377

### IMPORTANT: PACKING AND SHIPPING INSTRUCTIONS

When you send the product to a service center, you must use the original carton box and packing material, then insert the original carton box containing the unit into another carton, using more packing material.

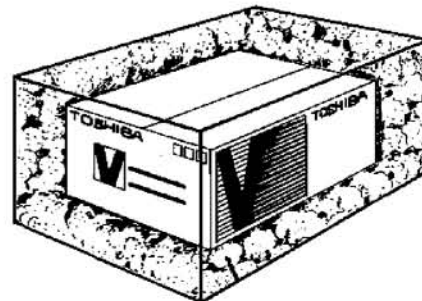

MANUFACTURED BY  
**TOSHIBA CORPORATION**

 **TOSHIBA**