



HOW IT WORKS

SAFETY PRECAUTIONS



WARNING: TO REDUCE THE RISK OF ELECTRIC SHOCK, DO NOT REMOVE COVER (OR BACK). NO USER-SERVICEABLE PARTS INSIDE. REFER SERVICING TO QUALIFIED PERSONNEL.

The lightning flash with an arrowhead within a triangle alerts you to uninsulated dangerous voltage within the product's enclosure that could cause an electric shock.

The exclamation point within a triangle alerts you to the presence of important operating, maintenance and servicing instructions in this user's manual.

This product contains a low power laser device.

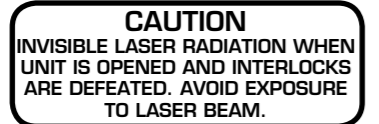

PLACEMENT INFORMATION
• Do not use this unit in places which are extremely hot, cold, dusty, or humid.
• Do not restrict the air flow of this unit by placing it somewhere with poor air flow, by covering it with a cloth, or by placing it on bedding or carpeting.

FCC INFORMATION
This device complies with the Part 15 of FCC rules. Operation is subject to the following two conditions:
(1) This device may not cause harmful interference, and
(2) This device must accept any interference received, including interference that may cause undesirable operation.

SAFETY INFORMATION
• When connecting or disconnecting the AC adapter, grip the plug and not the cord itself. Pulling the cord may damage it and create a hazard.
• When you are not going to use the unit for a long period of time, disconnect the AC adapter.

CONDENSATION INFORMATION
• When left in a heated room where it is warm and damp, water droplets or condensation may form inside the unit. When there is condensation inside the unit, the unit may not function normally. Let the unit stand for 1-2 hours before turning the power on, or gradually heat the room and let the unit dry before use.

RATING PLATE LOCATION
The rating plate is located on the bottom of unit.

WARNING: Should any problems occur, disconnect the AC adapter and refer servicing to a qualified technician.

NOTES ON COPYRIGHT
It is forbidden by law to copy, broadcast, show or play in public, or rent copyrighted material without permission. Apparatus Claims of U.S. Patent #: 4,631,603; 4,577,216; 4,819,098 and 4,907,093 licensed for limited viewing uses only. DVD video discs are copy protected, and any recordings made from these discs will be distorted. This product incorporates copyright protection technology that is protected by method claims of certain U.S. patents and other intellectual property rights owned by Macrovision Corporation and other rights owners. Use of this copyright protection technology must be authorized by Macrovision Corporation, and is intended for home and other limited viewing uses only, unless otherwise authorized by Macrovision Corporation. Reverse engineering or disassembly is prohibited.

DISC FORMATS

THE UNIT CAN PLAYBACK



REGION MANAGEMENT INFORMATION
Region Management Information: This unit is designed and manufactured to respond to the Region Management Information that is encoded on DVDs. If the Region number printed on the DVD does not correspond to the Region number of this unit, it cannot play that disc. The region number of this unit is 1.

DISC FUNCTION OR OPERATION THAT IS NOT AVAILABLE
When the symbol appears on the screen, it indicates that the function or operation you have selected is not available at that time. This occurs because the DVD manufacturer sets the specific functions of DVDs. Certain functions may not be available on some DVDs. For more information, refer to the documentation provided with the DVD.

- Language selections for audio
- Language selections for subtitles
- Screen aspect ratio
- Multiple camera angles
- Region code indicator

Note
When playing back a CD-G (karaoke) or CD EXTRA disc, the audio portion will be played, but the graphic images will not be shown.

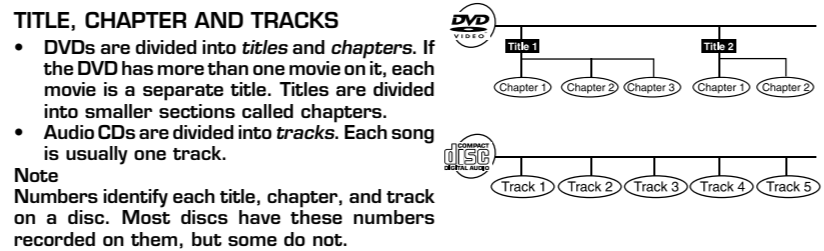

NOTES ON UNAUTHORIZED DISCS
You may not be able to play some DVDs on this unit, particularly if they were purchased from outside your geographic area (refer to Region Management Information above), or made for business purposes.

REMOTE CONTROL

REMOVE THE PLASTIC SHEET BEFORE USING THE REMOTE CONTROL.
• Point the remote control at the REMOTE SENSOR located on the unit.
• When using this unit in very bright light, the infrared REMOTE CONTROL SENSOR may not work properly.
• The recommended effective distance for using the remote control is about 16 feet (5 meters).

TO CHANGE THE REMOTE CONTROL BATTERY
1. Open the battery door.
2. Insert one CR2025 (3V) size battery.

BATTERY REPLACEMENT
When the battery becomes weak, the operating distance of the remote control will be greatly reduced and you will need to replace the battery.

WARNING: Do not dispose of the battery in a fire or it may leak and/or explode.

ACCESSORIES

PLEASE LOCATE THE INCLUDED ACCESSORIES.
• To order replacement, call customer service at 1-888-252-6252 or visit <http://www.alcosupport.com>.

- Remote Control with battery
- AC adapter
- Car Power adapter
- Rechargeable battery
- Audio/Video cable

Specifications and appearance are subject to change without notice.

Need More Help?
DO NOT RETURN THIS PRODUCT TO THE STORE
Please call Customer Service at 1-888-252-6252 or visit online help at <http://www.alcosupport.com>

TROUBLE SHOOTING GUIDE

SYMPTOM	CAUSE AND SOLUTION
No power.	• Make sure that the AC adapter is connected. • Make sure that the unit is turned on.
The remote control does not function.	• Make sure the infrared remote sensor is not blocked. • Make sure the plastic sheet has been removed from the remote. • Point the remote directly at the infrared remote sensor on the unit. • Replace the battery in the remote with a new one.
Very little or no sound is coming from a DVD	• Make sure the unit is in DVD mode. • Make sure the unit is not paused. Press the ► PLAY button. • Make sure the unit is not in fast-forward or fast-reverse mode. Press the ► PLAY button. • Make sure that the AUDIO/VIDEO output connections are correct. • Make sure you have not selected the "DTS" audio track on the DVD. This unit does not decode "DTS" audio. • The unit has overheated, shut it off for 30 minutes to allow it to cool down.
No picture.	• The region number of the disc does not match the region number of this unit.
The picture is not clear.	• The DVD is dirty. Gently clean the disc. • The DVD is scratched.
Loud hum or noise is heard.	• The plugs and jacks are dirty. Wipe them with a cloth slightly moistened with alcohol. • Clean the disc.
The disc does not play.	• There is no disc inside the unit ("No Disc" appears on the screen). Insert the disc correctly with the graphics facing up. • Clean the disc. • A non-NTSC disc has been inserted, or the disc region number does not match the region number of the unit. • Condensation may have formed inside the unit due to a sudden change in temperature. Wait about an hour for it to clear and try again.

MAINTENANCE

CLEANING DISC
A defective or dirty disc inserted into the unit can cause sound to drop out during playback. Handle the disc by holding its inner and outer edges.
• Do NOT touch the surface of the unlabeled side of the disc.
• Do NOT stick paper or tape on the surface of the disc.
• Do NOT expose the disc to direct sunlight or excessive heat.
• Clean the disc before playback. Wipe the disc from the center outward with a cleaning cloth.
• NEVER use solvents such as benzene or alcohol to clean the disc.
• Do NOT use irregular shape discs (example : heart shaped, octagonal, etc.). They may cause malfunctions.

CLEANING THE UNIT
• Be sure to turn the unit off and disconnect the AC adapter before cleaning the unit.
• Wipe the unit with a dry soft cloth. If the surfaces are extremely dirty, wipe clean with a cloth which has been dipped in a weak soap-and-water solution and wrung out thoroughly, then wipe it with a dry cloth.
• Never use alcohol, benzene, paint-thinner, cleaning fluid or other chemicals. Do NOT use compressed air to remove dust.

IMPORTANT NOTE
Before shipping the unit, remove any disc from the disc compartment.

IMPORTANT SAFETY INSTRUCTIONS

- Read Instructions - All the safety and operating instructions should be read before you use the unit.
- Keep the Instructions - The safety and operating instructions should be kept for future reference.
- Pay Attention to Warnings - All warnings on the unit and in this user's manual should be followed.
- Follow Instructions - All operating and use instructions should be followed.
- Water and Moisture - This unit should not be used near water or liquids- for example, near a bathtub, sink, wet basement, swimming pool, lake or ocean, beach, or similar places where there is a chance that the unit may come into contact with water or liquid.
- Carts and Stands - This unit should only be used with a cart or stand that is recommended by the manufacturer. If this unit is placed on a cart, it should be moved with care. Quick stops, excessive force, and uneven surfaces may cause the cart to overturn.
- Wall or Ceiling Mounting - This unit is not designed to be mounted to a wall or ceiling.
- Ventilation - This unit should be situated so that its location or position does not interfere with its proper ventilation. For example, the unit should not be used on a bed, sofa, rug, or similar soft surface which may block the ventilation openings. The unit should also not be built-in to a book case or cabinet, as that may impede the flow of air through the ventilation openings.
- Heat - This unit should be situated away from heat sources such as radiators, heat registers, stoves, or other items (including amplifiers) that produce heat.
- Power Sources - The appliance should be connected to a power supply only of the type described in these instructions or as marked on the unit.
- Grounding or Polarization - Do not try to defeat the grounding or polarization safeguards built into the unit.
- Powercord Protection - Power cords should be routed so that they are not likely to be walked on or pinched by items placed on or against them. Pay particular attention to cords at plugs, power outlets, and the point where the cord exits the unit.
- Cleaning - This unit should be cleaned only as recommended by the manufacturer.
- Nonuse Periods - The power cord should be unplugged from the wall outlet when the unit will not be used for a long period of time.
- Drops and Spills - Care should be taken so that objects do not fall on this unit, and liquids are not spilled on or in the unit through openings in its enclosure.
- Damage Requiring Service - This unit should be serviced by qualified personnel when:
A. The power cord or plug has been damaged;
or
B. Objects have fallen on, or liquid has been spilled into the unit; or
C. The unit has been exposed to rain; or
D. The unit does not appear to operate normally or there is a noticeable change in its performance; or
E. The unit has been dropped, and/or the enclosure damaged.
- Service - You should not attempt to service this unit beyond what is described in these instructions. All other servicing should be referred to qualified personnel.

REMOTE CONTROL REFERENCE GUIDE

REMOTE CONTROL

- TV MODE button**
When the STOP button has been pressed, TV MODE allows you to select the TV shape (Pan Scan, Letter Box or Widescreen).
- STOP button**
Stop playing a disc.
► PLAY button
Start or resume playing a disc.
■ PAUSE button
Press once to pause playback. Press subsequently to advance the DVD one frame at a time.
- PREV button**
Move back through titles, chapters or tracks on a disc.
- MEMORY button**
When the STOP button has been pressed, this feature is used to enter the number of a chapter or track which you wish to save in memory.
- Cursor (V, A, L, R) buttons**
Use to move between selections on a menu screen and adjust certain settings.
ENTER button
Confirm selections on a menu screen.
- Number (0 - 9) buttons**
Use when creating programs and entering a password. Also use to select a CD track directly.
- REPEAT A-B**
Perform point-to-point repeat playback on a DVD or CD.
- MENU button**
Enter and exit the main DVD menu.
- GOTO button**
Skip directly to a location on a DVD.
- NEXT button**
Move forward through titles, chapters or tracks on a disc.

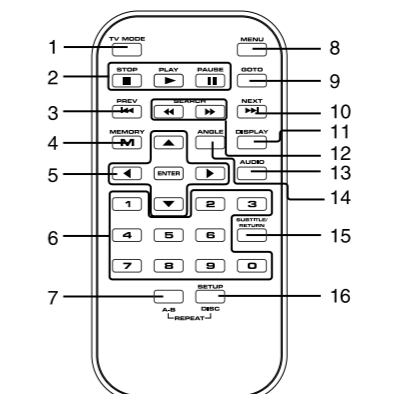

- DISPLAY button**
Show status information on the screen.
- SEARCH buttons**
◀◀ SEARCH: Fast reverse playback.
▶▶ SEARCH: Fast forward playback.
- AUDIO button**
Select one of the audio sound tracks on a DVD (if more than one is available) or select the audio output mode on a CD.
- ANGLE button**
Switch between multiple camera angles when the DVD you are playing has been programmed with multiple camera angles.
- SUBTITLE / RETURN button**
Select one of the subtitle languages programmed on a DVD (if available). Return to the normal operation after using the SETUP menu of a DVD.
- SETUP / REPEAT DISC button**
When a DVD is stopped, brings up the unit's SETUP menu.
Repeat a DVD chapter or title.
Repeat a CD track or the entire disc.

UNIT

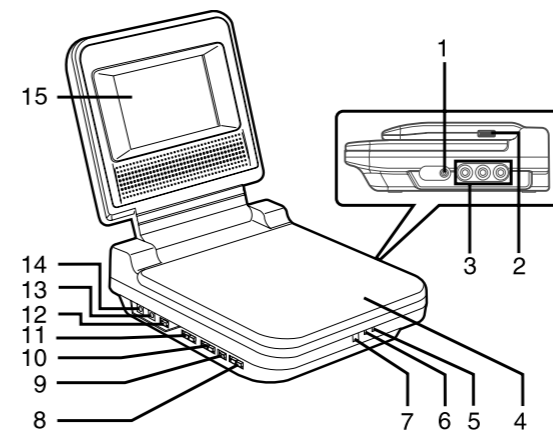

- Headphone jack**
- BRIGHTNESS button**
Adjusts the lightness or darkness of the screen color.
- AUDIO OUT L / R jacks**
LINE OUT (VOL MAX) jacks
Adjust the VOLUME to MAX when connecting the unit to another device. VIDEO OUT jack
- Disc Door**
Close door by gently pushing down.
- POWER ON indicator**
When the POWER ON / OFF switch is in the ON position, the light will illuminate.
- CHARGING indicator**
Remote sensor
Receives the remote control signal.
- PAUSE button**
Press to pause playback of a disc. Each time you subsequently press the PAUSE button the picture advances one frame at a time. Press the PLAY ► button to resume playback at normal speed.
- PLAY button**
Press to start or resume playing a disc.
- STOP button**
Stop playing a disc.
- PREV button**
Press ◀◀ PREV to go back to the previous chapters/tracks. Press and hold ◀◀ PREV to begin fast backward scan.
- NEXT button**
Press ▶▶ NEXT to advance chapters / tracks. Press and hold ▶▶ NEXT to begin fast forward scan.
- VOLUME + / - controls**
Adjusts the volume up(+) and down (-).
- POWER ON / OFF switch**
- DC IN 9V / Car Plug 12V**
Connect the car plug or AC adapter.
- BATT IN jack**
Connect the rechargeable battery plug.
- VIDEO SCREEN**

POWER SUPPLY

A. USING THE AC ADAPTER
This AC adapter operates on AC 100V -120V.

- CAUTION**
• The included AC adapter is for use with this unit only. Do not use it with other equipment.
• If you are not going to use the unit for a long time, disconnect the AC adapter from the power outlet.
• Whenever the AC adapter is plugged in to a power outlet, electricity is running through the unit, even when the power switch is turned off.

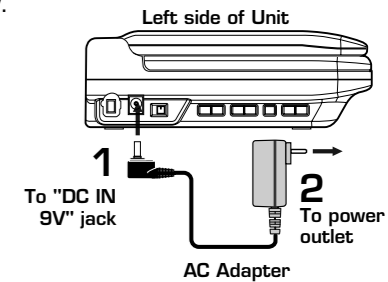

B. USING THE CAR POWER ADAPTER
The included 12V car power adapter allows the unit to be used with vehicles that have a 12V, negative ground electrical system.

- WARNING**
• Unplug the car power adapter from the cigarette lighter socket when not in use.
• Do not use in vehicles with 24V electrical systems.

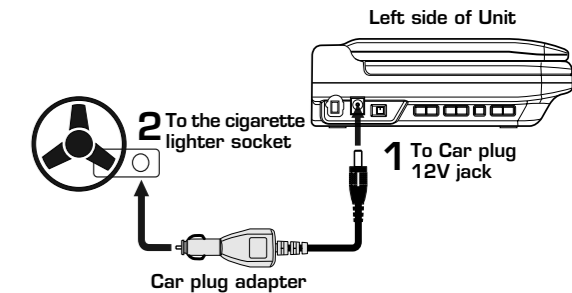

- CAUTION**
• Only use the included car power adapter with this unit. Using other car power adapters could damage the unit or your vehicle.
• The included car power adapter is only for use with this unit. Do not use it with other equipment.
• In the interest of traffic safety, the vehicle's driver should not operate or watch this unit.
• If the cigarette lighter socket is dirty with ashes or dust, the plug may become hot due to poor contact. Clean the cigarette lighter socket before use.
• After use, disconnect the car power adapter from both the unit and the cigarette lighter socket.
• Do not leave this unit in your vehicle unattended for long periods of time. The interior temperature of parked vehicles can get very hot. Keep this unit out of prolonged direct sunlight.

C. USING THE RECHARGEABLE BATTERY
Charge the battery for at least 4-5 hours before using it for the first time. The charging light will go out when the battery is fully charged.

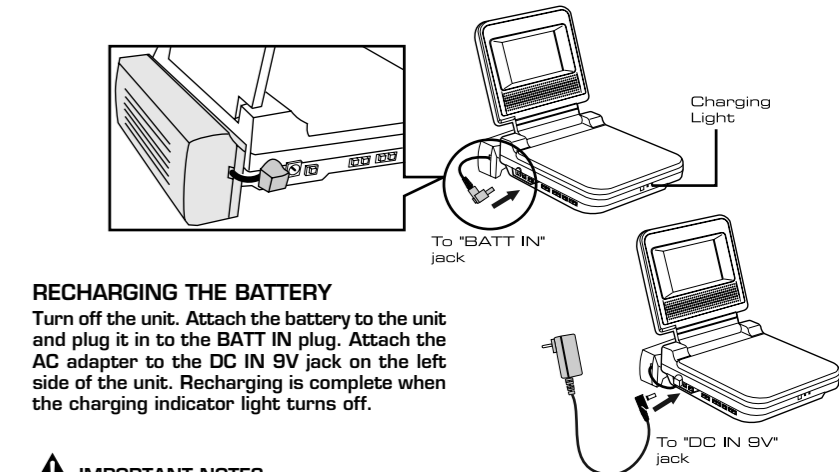

RECHARGING THE BATTERY
Turn off the unit. Attach the battery to the unit and plug it in to the BATT IN plug. Attach the AC adapter to the DC IN 9V jack on the left side of the unit. Recharging is complete when the charging indicator light turns off.

- IMPORTANT NOTES**
• The battery can only be recharged when the unit is OFF.
• The battery can only be recharged using the AC adapter. The battery cannot be recharged using the 12V car power adapter.
• When the battery power is low, the unit will stop playing.
• Recharge the battery when you are ready to use it again.
• While using the rechargeable battery, the air temperature should be between 41 - 95°F (5 - 35°C).
• To get the longest battery life, charge the battery at indoor temperatures.
• Never dispose of the rechargeable battery pack in fire or water.
• Never heat up the rechargeable battery pack.
• Do not open the rechargeable battery, refer servicing to qualified personnel.

- CAUTION**
• The included AC adapter is for use with this unit only. Do not use it with other equipment.
• If you are not going to use the unit for a long time, disconnect the AC adapter from the power outlet.
• Whenever the AC adapter is plugged in to a power outlet, electricity is running through the unit, even when the power switch is turned off.
• Do not short-circuit the terminals on the battery.

TURNING ON THE UNIT

- Slide the POWER ON/OFF switch to the "ON" position.
- The DVD logo (start-up picture) will appear on the screen.



CONNECTIONS

A. CONNECTING TO A TV

- If your TV has audio/video inputs, you can connect the unit to your TV using the included audio/video cable.
- Adjust the VOLUME to MAXIMUM when you connect this unit to other equipment.
- Close the screen when using this unit to playback DVDs on other equipment.

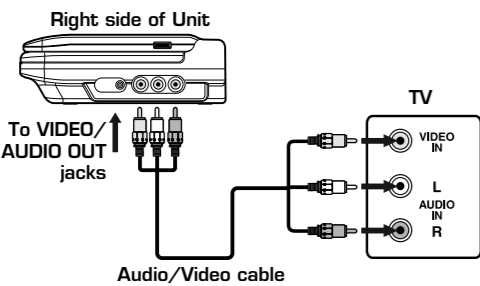

Watching a DVD on your TV

- Turn on the unit.
- Turn on the TV and set it to DVD mode.

B. USING HEADPHONES / EARPHONES

- Turn down the volume before connecting, and then adjust the volume level.
- When headphones / earphones are connected, no sound will be output from the unit's speaker.

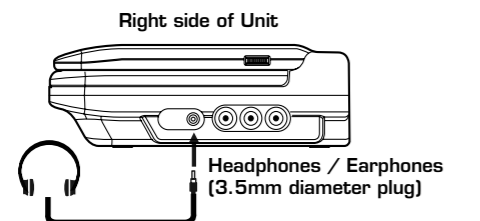
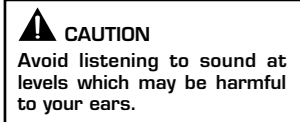

SOUND SYSTEM

DOLBY DIGITAL

Dolby Digital is a technology developed by Dolby Laboratories. Soundtracks encoded in Dolby Digital can reproduce from one to 5.1 discrete channels of excellent quality audio. The unit automatically recognizes the Dolby Digital bitstream and provides a downmix suitable for two-channel listening. An additional Dolby Digital decoder is required for reproduction of the discrete multi-channel soundtracks available on many DVDs.



Manufactured under license from Dolby Laboratories. 'Dolby' and the double-D symbol are trademarks of Dolby Laboratories.

PLAYING A DISC

This owner's manual explains the basic instructions for operating this unit. Some DVDs are produced in a manner that allows specific or limited operation during playback. Therefore, this unit may not respond to all operating commands. THIS IS NOT A DEFECT. Please refer to the instructions accompanying the specific DVD in question for more information about the options available on that DVD. "No" may appear on the screen during operation. The "No" symbol means that the desired operation is not permitted by the unit or disc.

PLAYING A DISC

- Slide the POWER ON/OFF switch on the right side of the unit to the ON position. See CUSTOMIZING THE FUNCTION SETTINGS before proceeding to step 2.
- Open the disc door.
- Hold the disc by its sides and carefully place it onto the spindle with the label side facing up, pushing gently until you hear a "click".
- Close the disc door. It takes a short while for your unit to load the disc. After loading, the unit will automatically either bring you to the main menu of the DVD, or start playing the DVD.
- If the unit does not automatically start playing the DVD, press the ► PLAY button from the main menu.



PAUSING PLAYBACK (STILL MODE)

Press the PAUSE button. To resume normal playback, press the ► PLAY button. Each time you press the PAUSE button, the picture advances one frame.

STOPPING PLAYBACK

Press the STOP button at the location where you want to interrupt playback. To resume playback at the position where the disc was stopped, press the ► PLAY button.

If you press the STOP button twice, the unit's memory will be cleared and pressing the ► PLAY button will reset the disc to the beginning.

SKIPPING TO A DIFFERENT TRACK

- Press the PREV button to skip to the start of the current track.
- Press the NEXT button to skip to the next track.
- For audio CDs, use the number buttons on the remote control to jump immediately to the desired track number.

FAST FORWARD/FAST REVERSE

- Press the SEARCH or SEARCH button when a disc is playing.
 - The disc begins a fast scan at two times normal (x2) speed.
 - Four speeds are available. Each time the SEARCH button is pressed, the speed of the fast scan changes.

Note

You also can press and hold / (PREV/NEXT) buttons repeatedly to select different fast scan speeds.

- Press the ► PLAY button when you reach the desired point to resume playback at normal speed.

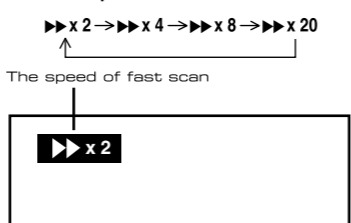

SKIP (FORWARD / REVERSE)

While you are playing a disc, press the NEXT button to move to the beginning of the next chapter or track. Press the PREV button to move to the previous chapter or track and playback will automatically begin.

AUDIO SELECTION

On some discs, the sound is recorded in two or more formats. Follow the directions below to select the type of playback.

- While a disc is playing, press the AUDIO button to show the current audio format number.
- Press the AUDIO button repeatedly to select the desired audio format.

Notes

- If only one audio format is recorded, the number does not change.
- About two seconds after a selection is made, playback continues in the new audio format.

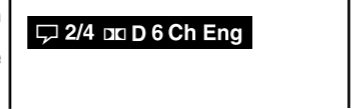

SUBTITLE SELECTION

- While a DVD is playing, press the SUBTITLE / RETURN button to display the current language setting, as shown in the diagram.
- Press the SUBTITLE / RETURN button repeatedly to select the desired subtitle language.

Notes

- If only one language is recorded, the language does not change.
- About two seconds after selecting the subtitle language, playback continues with the new subtitle you selected.
- The number of languages recorded differs depending on the disc.
- If no button is pressed within a few seconds, playback continues without changing the current subtitle.
- This function can only be used for discs on which subtitles have been recorded in multiple languages.
- On some DVDs, subtitles are activated from the main menu of the DVD. Press the MENU button to activate the main menu.

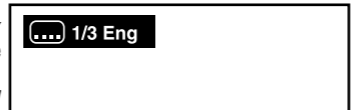

ANGLE SELECTION

Some DVDs contain scenes which have been shot from a number of different angles. For these discs, the same scene can be viewed from each of these different angles.

- While you are playing a DVD with different angles recorded, press the ANGLE button to view the number of current angles available.
- Press the ANGLE button repeatedly to change the scene to the next recorded angle.
 - After approx. two seconds, playback will continue from the new angle you selected.
 - If no button is pressed within 10 seconds, playback continues without changing the current angle.

Notes

- This function can only be used for discs on which scenes shot from multiple angles have been recorded.
- If only one angle is recorded, "1/1" is displayed.

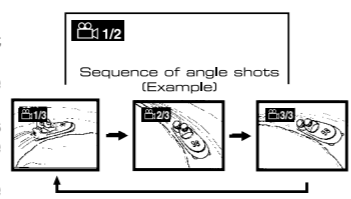

DISPLAY FUNCTION

Using DISPLAY, you can check the current settings of the following items: ANGLE, AUDIO and SUBTITLE.

- While the disc is playing, press the DISPLAY button to display the screen as shown in diagram.

Elapsed time: Elapsed time from the beginning of the chapter which is currently playing.

Remaining time: Remaining time of the title which is currently playing.



GOTO FUNCTION

This function allows you to skip directly to any part of the disc while a disc is playing.

SPECIAL FUNCTIONS

LOCATING A SPECIFIC TITLE

If a DVD contains title numbers, you can locate a specific title by directly selecting its title number.

- In stop mode, press the GOTO button.
- Press or button to highlight a specific field and press the corresponding number button(s) for the title you want.
- Press the ENTER button to confirm. The unit will start playback about 3 seconds later.

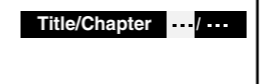

LOCATING A SPECIFIC TITLE / CHAPTER / TRACK

If you know the title/chapter/track number for the title/chapter/track that you want to play, you can locate it by directly selecting that number.

- Press the GOTO button to search for your desired title/chapter/track.
- Press or button to highlight a title/chapter/track and press the corresponding number button(s) for the chapter you want.
- Press the ENTER button to confirm. The unit will start playback about 3 seconds later.

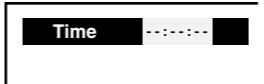
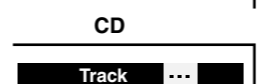
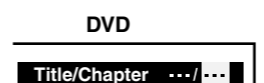

LOCATING A SPECIFIC TIME

You can move to a specific location by entering its corresponding time (hours, minutes, seconds)

- Press the GOTO button.
- Press or button to highlight time.
- Press the corresponding number buttons for the setting point you want.
- Press the ENTER button to confirm. The unit will start playback about 3 seconds later.

Notes

- Some discs may not respond to this process.
- Some scenes may not be located as precisely as you specified.
- This method for accessing specific locations is available only within the current title of the DVD disc.

CD/DVD PROGRAMMABLE MEMORY

PROGRAMMABLE MEMORY

The two types of programmed playback provided by this Unit are title/chapter programmed playback and track programmed playback.

Title / Chapter programmed playback

- Press the MEMORY button while the disc is stopped.
- Enter the title numbers in . Use or button to highlight your desired chapter and enter the chapter numbers in .
- Use , , or button to move to another field.
- Repeat steps 2 to 3.
- Press the ► PLAY button to start the programmed playback.

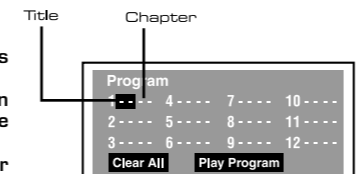

Track programmed playback

- Press the MEMORY button while the disc is stopped.
- Enter the track numbers in .
- Use , , or button to other field.
- Repeat steps 2 to 3.
- Press the ► PLAY button to start the programmed playback.

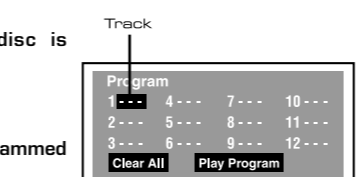

REPEAT PLAYBACK

You can play a specific title or chapter repeatedly. (Title repeat, chapter repeat, A-B repeat)

REPEATING A DVD CHAPTER

While the disc is playing, press the REPEAT DISC button until the "Repeat Chapter" indicator displays on the screen. The current chapter is played repeatedly.

REPEATING A DVD TITLE

While the disc is playing, press the REPEAT DISC button until the "Repeat Title" indicator displays on the screen. The current title is played repeatedly.

RESUMING NORMAL DVD PLAYBACK

While the disc is playing, press the REPEAT DISC button until the "Off" indicator displays on the screen.

You can play a single track or the whole DVD repeatedly.

REPEATING A SINGLE CD TRACK

While the disc is playing, press the REPEAT DISC button until the "Repeat Single" indicator displays on the screen. The current track is played repeatedly.

REPEATING A WHOLE CD

While the CD is playing, press the REPEAT DISC button until the "Repeat All" indicator displays on the screen. The whole disc is played repeatedly.

RESUMING NORMAL CD PLAYBACK

Press the REPEAT DISC button until the "Off" indicator displays on the screen.

REPEATING A SPECIFIC SECTION

You can play a specific section repeatedly.

- While the disc is playing, press the REPEAT A-B button at the beginning of the section (is displayed) you want to play repeatedly.
- Press the REPEAT A-B button again at the end of the section (is displayed).
- The unit will immediately begin replaying your selection.

To resume normal playback

- While the disc is playing, press the REPEAT A-B button until the "Off" indicator displays on the screen.

Notes

- A-B repeat can only be used within the same title. If the start and end of the section to be repeated are in different titles, A-B repeat is cancelled.
- The A-B repeat function does not operate in scenes where different camera angles are recorded.

PLAYING MP3 AND PICTURE FILES

This unit can play MP3 and Picture files recorded on CD-R and CD-RW discs.

PLAYING AN MP3/PICTURE FILE DISC

- Insert the MP3/Picture file disc.
- Close the disc door.
- The unit will load the disc and automatically display the contents of the disc on the screen, while also beginning to play the first MP3 file or Picture files. Each file will be played one after another.
- Press the , , or CURSOR button to view and select the file(s) that you want to play, then press the ENTER button to confirm the selected file.

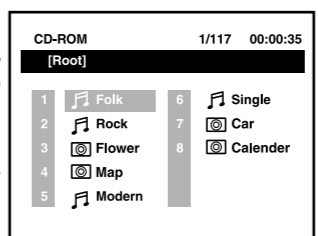

Notes

- You can press the PAUSE button to interrupt playback, and press the ► PLAY button to resume playback.
- You also can use the GOTO function or use the numbered buttons to enter a photo number and quickly select any image.
- Press the ANGLE button on the remote control to rotate the picture orientation by 90°.

Playable files

The ability of this unit to read MP3 discs is dependent on the following:

- The Bit Rate must be within 64 - 256 kbps.
- The total number of files on the disc should not exceed 254.
- The maximum number of directories should not exceed 32.
- The maximum depth level of directories should not exceed 4.
- File names should be named using 7 or fewer letters and/or numbers, and must incorporate the "MP3" file extension. EXAMPLE: *****.MP3 where each * is a letter or number.
- Use only letters and / or numbers in file names. If you use special characters, the file and/or folder names may not be displayed correctly on the on-screen display.
- When recording on CD-R discs, use 74-minute (650MB) discs.
- The CD-R or CD-RW discs should be "finalized" on the computer using "single session format" with recording speed less than "8x".
- See your CD/MP3 creation software for more information.

CUSTOMIZING THE FUNCTION SETTINGS

LANGUAGE SETTING

- Press the SETUP button in stop mode.
- Use or button to select a language, then press the ENTER button. The screen will change to your selected language immediately.
- To exit the SETUP MENU and return to the normal screen, press the RETURN or SETUP button.



VIDEO SETTING

- Press the SETUP button in stop mode.
- Use or button to select Video, then press the ENTER button.
- Use or button to select the options (TV Shape, Brightness or Edges) to be adjusted by press or button, then press the ENTER button. (The screen will change to your desired setting).
- Repeats step 2 and 3 above to adjust other options.
- To exit the FUNCTION SETUP MENU and return to the normal screen, press the RETURN or SETUP button.



Pan Scan

- When wide-screen video is played, this mode clips the right and left sides of the image so that it can be viewed on a conventional screen.
- Some wide-screen DVDs that do not permit Pan Scan playback are automatically played in Letter Box mode (black bands at top and bottom of screen).

Cut off when a wide-screen video image is played.



Pan Scan

Letter Box

- When wide-screen video is played in this mode on a conventional screen, black bands appear at the top and bottom of the screen.



Letter Box

Wide Screen

- This is the correct mode for playing wide-screen videos on a wide-screen.



Wide Screen

Notes

- The displayable picture size is preset on the DVD discs. Therefore the playback picture of some DVDs may not conform to the picture size you select.
- When you play DVDs recorded in the 4:3 aspect ratio, the playback picture will always appear in the 4:3 aspect ratio regardless of the TV shape setting.

RATING

Some DVDs are equipped with a password function and are rated according to their content. The contents allowed by parental lock levels and the way a DVD is controlled may vary from disc to disc. For example, if the disc allows, you could lock-out violent scenes unsuitable for children or you could lock out playback of the disc altogether.

- Press the SETUP button in stop mode.
- Use or button to select Rating, press the ENTER button.
- Use or button to select parental lock and then press the ENTER button repeatedly to set the parental lock level.
- Use or button to shift and select Password, enter your 4-digit security code and then press the ENTER button.

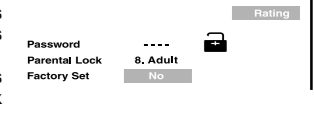

You cannot play DVDs rated higher than the level you selected unless you cancel the parental lock function.

The parental lock levels are equivalent to the following ratings.

Level 1 : Kid Safe	Level 5 : PG-R
Level 2 : G	Level 6 : R
Level 3 : PG	Level 7 : NC-17
Level 4 : PG-13	Level 8 : Adult

Note

It takes 3-5 seconds to reset the unit to the factory default.

- The Parental lock is active.
- Indicates Parental lock is NOT active.