

# High-Definition LCD TV Service Manual

Models: LT3200, LT3700, LT4200, LT4700



Copyright 2007, 2008 Hewlett-Packard Development Company, L.P. The information contained herein is subject to change without notice.

Microsoft and Windows are trademarks of Microsoft Corporation in the U.S. and other countries.

The only warranties for HP products and services are set forth in the express warranty statements accompanying such products and services. Nothing herein should be construed as constituting an additional warranty HP shall not be liable for technical or editorial errors or omissions contained herein.

This document contains proprietary information that is protected by copyright. No part of this document may be photocopied, reproduced, or translated to another language without the prior written consent of Hewlett-Packard Company.

**Service Reference Guide**

Business PCs

Second Edition (April 2008)

First Edition (June 2007)

Document Part Number: 454404-002

# Table of Contents

<b>High-Definition LCD TV Service Manual .....</b>	<b>1</b>
Models: LT3200, LT3700, LT4200, LT4700.....	1
<b>Table of Contents.....</b>	<b>iii</b>
<b>Important Service Safety Precautions.....</b>	<b>1</b>
Warnings and Cautions .....	1
Safe Handling and Servicing.....	2
Repair Tips .....	3
About Lead-Free Solder .....	3
Suggested Pb-Free Solder .....	4
Servicing of Surface-Mounted Devices (SMDs).....	4
Rework on Ball Grid Array (BGA) ICs.....	5
<b>Product Information and Specifications .....</b>	<b>6</b>
Product Information .....	6
Product Profile .....	6
Specifications.....	6
LCD Panel Module.....	6
General TV Specifications LT3200 and LT3700 .....	7
General TV Specifications LT4200 and LT4700 .....	9
I/O Connectors .....	11
Factory Preset Display Modes.....	11
Controlling the Onscreen Display .....	12
TV Indicators and Controls .....	12
Remote Control .....	13
TV Connectors .....	14
Connectors.....	17
<b>Basic Operation.....</b>	<b>20</b>
Basic Operation.....	20
OSD (On-Screen Display) Functions – Simplemenu .....	20
OSD Functions – Fullmenu .....	21
Command Table RS-232 .....	25
Return messages.....	32
Special command extension .....	32
<b>Replaceable Parts.....</b>	<b>33</b>
Parts List by Model .....	33
Model LT3200.....	33
Model LT3700 .....	34
Model LT4200 .....	35
Model LT4700 .....	36
Replacement Parts List Reference Pictures.....	37
<b>Removal and Replacement .....</b>	<b>42</b>
Equipment and Tools Needed for Removal and Replacement.....	42

Tools.....	42
After Service Checklist .....	42
Basic Adjustment Settings.....	42
Four Models – Comparison Pictures.....	43
LT3200 .....	43
LT3700 .....	43
LT4200 .....	44
LT4700 .....	44
Removal Procedures .....	45
Removal Order .....	45
Screws .....	45
Removing the Pedestal .....	46
Disassembling the Pedestal .....	47
Removing the Back Cover .....	48
Removing the Function Keyboard.....	49
Removing the Infrared Board.....	50
Removing the Wall Mount Brackets .....	51
Removing the Board Cover.....	52
Removing the Main Board .....	52
Removing the Power Supply.....	56
Removing the Main Bracket.....	60
Removing the Inverters .....	61
Removing the Speakers .....	64
Removing the Control Board .....	66
Removing the Front Bezel.....	70
<b>Diagnostics .....</b>	<b>71</b>
LED Indicators .....	71
Software version information.....	71
How to run diagnostics .....	71
How to get back to normal TV operation after running diagnostics .....	72
Installation menu.....	72
Hotel mode.....	73
How to enable and disable.....	74
<b>Troubleshooting.....</b>	<b>75</b>
Remote Control .....	75
Function Key.....	76
Power: TV Does Not Turn On.....	77
Audio .....	78
VGA Input.....	79
HDMI Input .....	80
DVI Input.....	81
YPbPr Input .....	82
TV/Video/S-video Input.....	83
Troubleshooting Tips .....	84
No Power.....	84
No Video .....	84

Keypad abnormal .....	84
LED Display abnormal.....	84
Abnormal Display .....	84
LED Display abnormal.....	85
LCD Panel Troubleshooting Tips.....	85
Inverter board .....	85
Control board (panel driver).....	85
LVDS cable .....	85
Screen.....	85
Example of defective LCDs .....	86
<b>Chassis Layout and Overall Wiring Diagrams.....</b>	<b>89</b>
Boards Layout (Typical of all models except 32-inch*).....	89
Connectors .....	90
Main Board.....	90
Keypad and IR Boards .....	91
Wires and Cables Wiring .....	92
Main Board.....	92
Wiring Diagram .....	93
<b>Firmware Update Procedure.....</b>	<b>94</b>
Overview.....	94
Safe Software Update Procedure .....	94
Introduction .....	94
Software Feature Requirement.....	95
Software Update Procedure.....	95
Limitation of this Implementation.....	95



# Important Service Safety Precautions

BEFORE SERVICING THE LCD MODULE, READ THE SAFETY PRECAUTIONS IN THIS MANUAL.

WHEN REPLACEMENT PARTS ARE REQUIRED, BE SURE TO USE REPLACEMENT PARTS SPECIFIED BY THE MANUFACTURER.

Proper service and repair is important to the safe, reliable operation of all HP equipment. The service procedures recommended by HP and described in this service manual are effective methods of performing service operations. Some of these service operations require the use of tools specifically designed for their purpose, and should be used as recommended.

It is important to note that this manual contains various Cautions and Notices that should be carefully read in order to minimize the risk of personal injury to service personnel. Improper service methods may damage the equipment. It is also important to understand that these Cautions and Notices are not exhaustive. HP could not possibly know, evaluate, and advise the service trade of all conceivable ways in which service might be done or of the possible hazardous consequences of each way. Consequently, HP has not undertaken any such broad evaluation. Service technicians who use service procedures or tools that are not recommended by HP must exercise caution and be sure that neither their safety nor the safe operation of the equipment will be jeopardized by the service method selected.

## Warnings and Cautions



**WARNING:** Critical components having special safety characteristics are identified with a ▲ by the reference number in the parts list.



**WARNING:** Use of substitute replacement parts, which do not have the same specified safety characteristics, may create shock, fire, or other hazards. Under no circumstances should the original design be modified or altered without written permission from HP. HP assumes no liability, express or implied, arising out of any unauthorized modification of design. The service technician assumes all liability.



**CAUTION:** To ensure the continued reliability of this product, use only the original manufacturer's replacement parts, which are listed with their part numbers in the "Replaceable Parts List" section of this service manual.



**WARNING:** All ICs and many other semiconductors are susceptible to electrostatic discharges (ESDs). Careless handling during repair can be life-threatening. When repairing, make sure that you are connected with the same potential as the mass of the set by a wristband with resistance. Keep components and tools also at this same potential.



**WARNING:**

- 1 Never replace modules or other components while the unit is turned on.
- 2 When making settings, use plastic rather than metal tools. This will prevent any short circuits and the danger of a circuit becoming unstable.



**WARNING:** To prevent electrical shock, do not use the polarized AC plug with an extension cord, receptacle, or the outlet unless the blades can be fully inserted to prevent blade exposure. To prevent electrical shock, match the wide blade or plug to a wide slot and fully insert.



**WARNING:** When replacement parts are required, be sure to use replacement parts specified by the manufacturer or have the same characteristics as the original part. Unauthorized substitutions may result in fire, electric shock, or other hazards.



## WARNINGS:

Safety regulations require that after a repair the set must be returned in its original condition. In particular attention should be paid to the following points:

---

**NOTE:** The wiring should be routed correctly and fixed with the mounted cable clamps. The insulation of the main leads should be checked for external damage.

---

- Do not touch the signal and the power connector while this product is operating. Do not touch the EMI ground part and the heat sink of the film filter.
- Do not supply a voltage higher than that specified to this product. This may damage the product and may cause a fire.
- Do not use this product in locations where the humidity is extremely high, where it may be splashed with water, or where flammable materials surround it. Do not install or use the product in a location that does not satisfy the specified environmental conditions. This may damage the product and may cause a fire.
- If a foreign substance (such as water, metal, or liquid) gets inside the panel module, immediately turn off the power. Continuing to use the product, may cause fire or electric shock.
- If the product emits smoke or an abnormal smell, or it makes an abnormal sound, immediately turn off the power. Continuing to use the product, may cause fire or electric shock.
- Do not disconnect or connect the connector while power to the product is on. It takes some time for the voltage to drop to a sufficiently low level after the power has been turned off. Confirm that the voltage has dropped to a safe level before disconnecting or connecting the connector.
- Do not pull out or insert the power cable from or to an outlet with wet hands. It may cause electric shock.
- Do not damage or modify the power cable. It may cause fire or electric shock.
- If the power cable is damaged, or if the connector is loose, do not use the product; this can lead to fire or electric shock.
- If the power connector or the connector of the power cable becomes dirty or dusty, wipe it with a dry cloth. Continuing to use the product may cause fire or electric shock.
- The LCD module uses a high-voltage (maximum 450V DC). Be cautious of electric shock and do not touch the device circuitry when handling the LCD unit. Because

the capacitor of the device circuitry may remain charged at the moment of power off, standing by for 1 minute is strongly recommended before touching the device circuitry.

- Use only with the cart, stand, tripod, bracket, or table specified by the manufacturer, or sold with the apparatus. When a cart is used, use caution when moving the cart/apparatus combination to avoid injury from tip-over.

## Safe Handling and Servicing

The work procedures shown with the Warning symbol are important for ensuring the safety of the product and the servicing work. Be sure to follow these instructions.



- Before starting the work, secure a sufficient workspace.
- At all times, other than when adjusting and checking the product, be sure to turn off the Power button and disconnect the power cable from the power source of the TV during servicing.
- To prevent electric shock and breakage of PC board, start the servicing work at least 30 seconds after the main power has been turned off. Especially when installing and removing the power supply board and the SUS board, which involve high voltages, start servicing at least 2 minutes after the main power has been turned off.
- While the main power is on, do not touch any parts or circuits other than the ones specified. The high-voltage power supply block within the LCD module has a floating ground. If any connection other than the one specified is made between the measuring equipment and the high voltage power supply block, it can result in electric shock or activation of the leakage-detection circuit breaker.
- When installing the LCD module into and removing it from the packing carton, be sure to have at least two people perform the work while being careful to ensure that the flexible printed-circuit cable of the LCD module does not get caught by the packing carton.
- When the surface of the panel comes into contact with the cushioning materials, be sure that there is no foreign matter on top of the cushioning materials. Foreign matter may scratch the surface of the panel.
- Be sure to remove static electricity from your body before handling the circuit board.
- Be sure to handle the circuit board by holding the large parts such as the heat sink or transformer. Failure to observe this precaution may result in the occurrence of an abnormality in the soldered areas.



- Do not stack the circuit boards. Failure to observe this precaution may result in problems resulting from scratches on the parts, the deformation of parts, and short-circuits due to residual electric charge.
- Routing the wires and fixing them in position must be done in accordance with the original routing and fixing configuration when servicing is completed. All the wires are routed far away from the areas that become hot (such as the heat sink). These wires are fixed in position with the wire clamps so that the wires do not move, thereby ensuring that they are not damaged and their materials do not deteriorate over long periods of time. Therefore, route the cables and fix the cables to the original position and states using the wire clamps.
- Perform a safety check when servicing is completed. Verify that the peripherals of the serviced points have not undergone any deterioration during servicing. Also verify that the screws, parts, and cables removed for servicing purposes have all been returned to their proper locations in accordance with the original setup.
- A glass plate protects the LCD display. This glass plate can be cleaned with a slightly moist cloth. If dirt appears between the glass plate and the LCD display panel have only a qualified service employee clean it.

## Repair Tips



**WARNING:** All ICs and many other semiconductors are susceptible to electrostatic discharges (ESDs). Careless handling during repair can be life-threatening. When repairing, make sure that you are connected with the same potential as the mass of the unit via a wrist wrap with resistance. Keep components and tools also at the same potential.

## About Lead-Free Solder

**NOTE:** LEAD IS LISTED AS (PB) IN THE PERIODIC TABLE OF THE ELEMENTS. IN THE INFORMATION THAT FOLLOWS, PB WILL REFER TO LEAD SOLDER, AND PBF WILL REFER TO LEAD-FREE SOLDER. THE LEAD-FREE SOLDER USED IN OUR MANUFACTURING PROCESS AND DISCUSSED HERE IS (SN+AG+CU). THAT IS TIN (SN), SILVER (AG), AND COPPER (CU), ALTHOUGH OTHER TYPES ARE AVAILABLE.

This model is manufactured using Pb-free solder for the sake of environmental conservation. For service and repair work, we suggest using Pb-free solder as well, although Pb solder may be used.

PCBs manufactured using Pb-free solder have the sign  stamped on the PCB.



### CAUTIONS:

- Pb-free solder has a higher melting point than Pb solder. Typically the melting point is 50–70°F (30–40°C) higher. Use a high temperature soldering iron. Adjust your solder tool so that a temperature around 360–380°C is reached and stabilized at the solder joint. Heating time of the solder joint should not exceed 4 seconds. Avoid temperatures above 400°C; wear-out of tips will rise drastically and flux-fluid will be destroyed.
- Pb-free solder will tend to splash when heated too high (about 1,100°F or 600°C).
- Mix of Pb-free solder Tin (SN)/parts with leaded soldering Tin (SN) in/parts is possible but not recommended. If you have to use Pb solder, completely remove all of the Pb-free solder on the pins or solder area before applying Pb solder. If this is not practical, be sure to heat the Pb-free solder until it melts, before applying Pb solder.
- After applying Pb-free solder to double-layered boards, check the component side for excess solder that may flow onto the opposite side (see the following illustration).

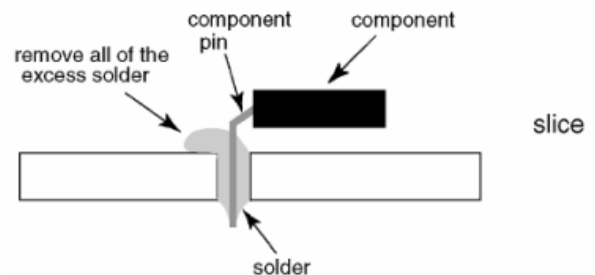

- Special information for Pb-free BGA-ICs: These ICs will be delivered in so-called dry-packaging to protect the IC against moisture and with the Pb-free logo on it. This packaging may only be opened shortly before it is used (soldered). Otherwise the body of the IC gets wet inside, and during the heating time the structure of the IC will be destroyed from steam pressure. If the packaging was opened before usage the IC has to be heated up for about 90 hours to dry. Make sure you use ESD protection!

### Suggested Pb-Free Solder

Several kinds of Pb-free solder (some shown in the following illustration) are available for purchase. This product uses Sn+Ag+Cu (tin (SN), silver (AG), copper (CU)) solder. However, Sn+Cu (tin (SN), copper (Cu)), Sn+Zn+Bi (tin (SN), zinc (Zn), bismuth (Bi)) solder can also be used.

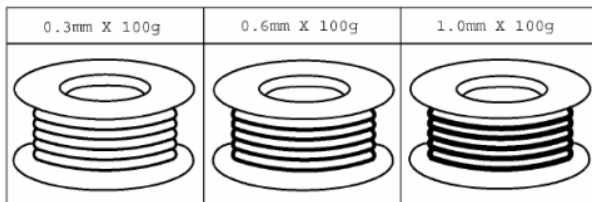

### Servicing of Surface-Mounted Devices (SMDs)



#### CAUTIONS:

General cautions on handling and storage:

- Oxidation on the terminals of SMDs results in poor soldering. Do not handle SMDs with bare hands.
- Avoid using storage places that are sensitive to oxidation, such as places with sulphur or chlorine gas, direct sunlight, high temperatures, or a high degree of humidity. The capacitance or resistance value of the SMDs may be affected by these conditions.
- Rough handling of circuit boards containing SMDs may cause damage to the components as well as the circuit boards. Circuit boards containing SMDs should never be bent or flexed. Different circuit board materials expand and contract at different rates when heated or cooled and the components and/or solder connections may be damaged due to the stress.
- Never rub or scrape chip components as this may cause the value of the component to change. Similarly, do not slide the circuit board across any surface.

### Removal of SMDs

- 1 Heat the solder (for 2 to 3 seconds) at each terminal of the chip. By means of solder wick and a slight horizontal force, small components can be removed with the soldering iron. They can also be removed with a solder sucker (A).
- 2 While holding the SMD with a pair of tweezers, take it off gently using the soldering iron's heat applied to each terminal (B).
- 3 Remove the excess solder on the solder lands by means of solder wick or a solder sucker (C).

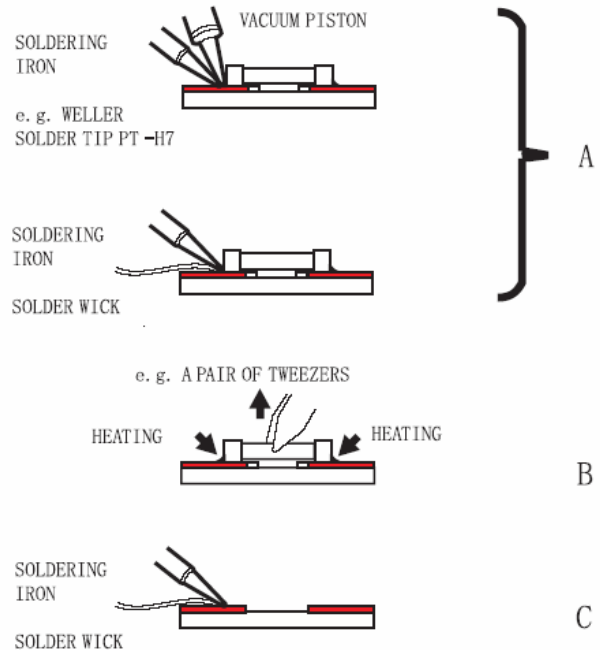

#### CAUTIONS:

- When handling the soldering iron, use suitable pressure and be careful.
- When removing the chip, do not use undue force with the pair of tweezers.
- The soldering iron to be used (approx. 30 W) should preferably be equipped with a thermal control (soldering temperature: 360° to 380° C).
- Once removed, the chip cannot be reused.

## Attachment of SMDs

- 1 Locate the SMD on the solder lands by means of tweezers and solder the component on one side. Ensure that the component is positioned correctly on the solder lands (A).
- 2 Complete the soldering of the terminals of the component (B).

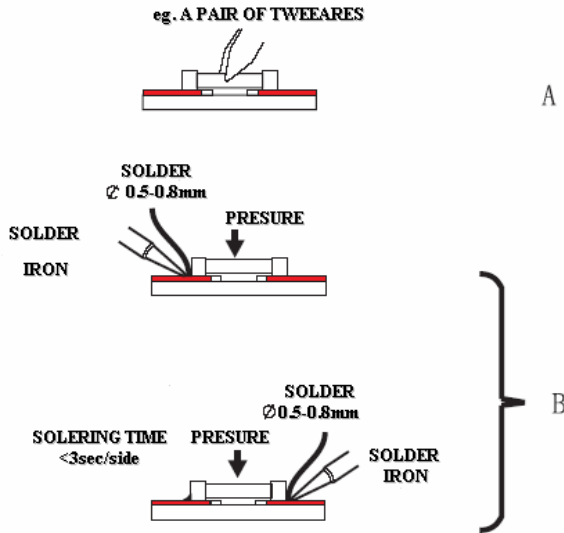

### CAUTIONS:

- When soldering the SMD terminals, do not touch them directly with the soldering iron. The soldering should be done as quickly as possible; care must be taken to avoid damage to the terminals of the SMDs themselves.
- Keep the SMD's body in contact with the printed board when soldering.
- The soldering iron to be used (approximately 30 W) should preferably be equipped with a thermal control (soldering temperature: 360° to 380° C).
- Soldering should not be done outside the solder land.
- Soldering flux (of rosin) may be used but should not be acidic.
- After soldering, let the SMD cool down gradually at room temperature.
- The quantity of solder must be proportional to the size of the solder land. If the quantity is too great, the SMD might crack or the solder lands might be torn loose from the printed board.

## Rework on Ball Grid Array (BGA) ICs

### General information

Although (LF) BGA assembly yields are very high, there may still be a requirement for component rework. By *rework*, we mean the process of removing the component from the PWB and replacing it with a new component. If an (LF) BGA is removed from a PWB, the solder balls of the component are deformed drastically so the removed (LF) BGA has to be discarded.

### Device removal

As is the case with any component that, it is essential when removing an (LF) BGA, the board, tracks, solder lands, or surrounding components are not damaged. To remove an (LF) BGA, the board must be uniformly heated to a temperature close to the reflow soldering temperature. A uniform temperature reduces the chance of warping the PWB. To do this, we recommend that the board is heated until it is certain that all the joints are molten. Then carefully pull the component off the board with a vacuum nozzle. For the appropriate temperature profiles, see the IC data sheet.

### Area Preparation

When the component has been removed, the vacant IC area must be cleaned before replacing the (LF) BGA.

Removing an IC often leaves varying amounts of solder on the mounting lands. This excessive solder can be removed with either a solder sucker or solder wick. The remaining flux can be removed with a brush and cleaning agent. After the board is properly cleaned and inspected, apply flux on the solder lands and on the connection balls of the (LF) BGA.

---

**NOTE:** Do not apply solder paste, as this has shown to result in problems during resoldering.

---

### Device replacement

The last step in the repair process is to solder the new component on the board. Ideally, the (LF) BGA should be aligned under a microscope or magnifying glass. If this is not possible, try to align the (LF) BGA with any board markers. To reflow the solder, apply a temperature profile according to the IC data sheet. To avoid damaging neighboring components, it may be necessary to reduce some temperatures and times.

# Product Information and Specifications

## Product Information

This specification table describes the key areas of all hardware service requirements of large entertainment High-Definition LCD Television models LT3200, LT3700, LT4200, and LT4700. This document is for HP service personnel (bench and in-home technicians) and ASP technicians in the repair and refurbishment of HP flat-panel televisions.

## Product Profile

HP High-Definition Digital TV models LT3200, LT3700, LT4200, and LT4700 can display ATSC, NTSC and Clear-QAM TV signals. All models also support High Definition Multimedia Interface (HDMI) and YPbPr (HD) display technology. All models can be used as monitors for your PC with a VGA connector.

## Specifications

### LCD Panel Module

Model name	LT3200 (32" Model)	LT3700 (37" Model)	LT4200 (42" Model)	LT4700 (47" Model)
Number of pixels	1366 (H) x 768 (V)	1366 (H) x 768 (V)	1920 (H) x 1080 (V)	1920 (H) x 1080 (V)
Expected lifetime	60,000 hours	60,000 hours	60,000 hours	60,000 hours

**NOTE:** For more detailed specifications, refer to the panel specification documentation in the Appendix.

## General TV Specifications LT3200 and LT3700

Model number		LT3200	LT3700
Description		32" HDTV	37" HDTV
Availability		June 2007	June 2007
Video	Brightness	500 cd/m2	500 cd/m2
	Resolution	1366 x 768	1366 x 768
	Contrast Ratio	1200:1	1000:1
	Viewing Angle	176 degrees	178 degrees
	Response Time	8 ms	6 ms
	Scalar	Trident PX66	Trident PX66
	Supported Input	480i, 480p, 720p, 1080i, 1080p (HDMI only)	480i, 480p, 720p, 1080i, 1080p (HDMI only)
Tuning	ATSC/NTSC/Clear -QAM	1	1
	Unidirectional Cable Card	No	No
Video enhancers	3D Digital Comb Filter	Yes	Yes
	Video Noise Reduction	Yes	Yes
	3:2 Pull Down	Yes	Yes
	HP Visual Fidelity Engine	Yes	Yes
	Photorealistic Sharpness Enhancement	Yes	Yes
	3D Color Enrichment	Yes	Yes
	Motion-Adaptive Deinterlacer	Yes	Yes
Audio	Speakers	2 x 10W, 1 way	2 x 10W, 1 way
	Dolby Digital Out	Yes	Yes
	Virtual Surround Sound	Theater, Music Hall	Theater, Music Hall
	SAP/MTS	Yes	Yes
Connectivity	AV In	2	2
	Component In (YPbPr)	2	2
	HDMI	3	3
	S-Video In	2	2
	Antenna In (RF)	1	1
	PC VGA In	1	1
	Analog Audio In (L/R)	5	5
	PC Audio In	1	1
	RS-232c	1	1
	USB Port (service only)	1	1
	Audio Out	1	1
	SPDIF Out	1	1
Composite	0	0	

**General TV Specification Continued**

Model number		LT3200	LT3700
Convenience	OSD Languages	English/French/Spanish	English/French/Spanish
	Custom Input Presets	Yes	Yes
	Custom Input Labeling	Yes	Yes
	V-Chip	Yes	Yes
	Closed Captioning	Yes	Yes
	Sleep Timer	Yes	Yes
	Favorite Channels	Yes	Yes
	PIP/POP	No	No
	Split Screen	No	No
	Clock	No	No
	Auto On	No	No
	EPG TV Guide Support	No TV Guide	No TV Guide
Finish and Color	Bezel and Stand	40%-60% Gloss Midnight Black, Bezel and Stand	40%-60% Gloss Midnight Black, Bezel and Stand
Accessories	Stand	Detachable (included)	Detachable (included)
	Speakers	Integrated	Integrated
	Remote	Standard, Philips, 35-button	Standard, Philips, 35-button
	Wall mounts	Optional/recommended	Optional/recommended
	Media Center/DEC	Optional/recommended	Optional/recommended
General	Power supply	120V AC 60Hz	120V AC 60Hz
	Power consumption (W)	180W	220W
	Dimensions with stand (H/W/D) (inches/centimeter)	24.0 (60.7) x 30.9 (78.5) x 9.4 (23.9)	26.7 (67.8) x 35.7 (90.7) x 11.0 (27.9)
	Dimensions without stand (H/W/D) (inches/centimeter)	21.6 (54.8) x 30.9 (78.5) x 5.0 (12.7)	24.3 (61.7) x 35.7 (90.7) x 5.2 (13.2)
	Weight (with stand)	40.7 lb/18 kg	49.5 lb/22 kg
	Weight (without stand)	33 lb/15 kg	40.7 lb/18 kg
	VESA wall mount standard	VESA 200mm	VESA 200mm
	Energy Star	Yes	Yes
Front Bezel Trademarks	<i>Dolby Digital</i>	<i>Dolby Digital</i>	
Regulatory compliance	Safety	FCC Class B, C-UL and UI	FCC Class B, C-UL and UI

## General TV Specifications LT4200 and LT4700

Model number		LT4200	LT4700
Description		42" HDTV	47" HDTV
Availability (On Ad)		June 2007	June 2007
Video	Brightness	500 cd/m2	500 cd/m2
	Resolution	1920 x 1080	1920 x 1080
	Contrast Ratio	1200:1	1200:1
	Viewing Angle	176 degrees	176 degrees
	Response Time	8 ms	6.5 ms
	Scalar	Trident LX66	Trident LX66
	Supported Input	480i, 480p, 720p, 1080i, 1080p (HDMI only)	480i, 480p, 720p, 1080i, 1080p (HDMI only)
Tuning	ATSC/NTSC/Clear -QAM	1	1
	Unidirectional Cable Card	No	No
Video enhancers	3D Digital Comb Filter	Yes	Yes
	Video Noise Reduction	Yes	Yes
	3:2 Pull down	Yes	Yes
	HP Visual Fidelity Engine	Yes	Yes
	Photorealistic Sharpness Enhancement	Yes	Yes
	3D Color Enrichment	Yes	Yes
	Motion-adaptive Deinterlacer	Yes	Yes
Audio	Speakers	2 x 10W, 1 way	2 x 10W, 1 way
	Dolby Digital Out	Yes	Yes
	Virtual Surround Sound	Theater, Music Hall	Theater, Music Hall
	SAP/MTS	Yes	Yes
Connectivity	AV	2	2
	Component In (YPbPr)	2	2
	HDMI	3	3
	S-Video In	2	2
	Antenna In (RF)	1	1
	PC VGA In	1	1
	Analog Audio In (L/R)	5	5
	PC Audio In	1	1
	RS-232c	1	1
	USB Port (service only)	1	1
	Audio Out	1	1
	SPDIF Out	1	1
Composite	0	0	

**General TV Specification Continued**

Model number		LT4200	LT4700
Convenience	OSD Languages	English/French/Spanish	English/French/Spanish
	Custom Input Presets	Yes	Yes
	Custom Input Labeling	Yes	Yes
	V-Chip	Yes	Yes
	Closed Captioning	Yes	Yes
	Sleep Timer	Yes	Yes
	Favorite Channels	Yes	Yes
	PIP/POP	No	No
	Split Screen	No	No
	Clock	No	No
	Auto On	No	No
	EPG TV Guide Support	No TV Guide	No TV Guide
Finish and Color	Bezel and Stand	40%-60% Gloss Midnight Black, Bezel and Stand	40%-60% Gloss Midnight Black, Bezel and Stand
Accessories	Stand	Detachable (included)	Detachable (included)
	Speakers	Integrated	Integrated
	Remote	Standard, Philips, 35-button	Standard, Philips, 35-button
	Wall mounts	Optional/recommended	Optional/recommended
	Media Center/DEC	Optional/recommended	Optional/recommended
General	Power supply	120V AC 60Hz	120V AC 60Hz
	Power consumption (W)	300W	330W
	Dimensions with stand (H/W/D) (inches/centimeter)	28.5 (72.4) x 40.0 (101.6) x 11.0 (27.9)	31.7 (80.5) x 44.4(112.8) x 11.0 (27.9)
	Dimensions without stand (H/W/D) (inches/centimeter)	26.6 (67.6) x 40.0 (101.6) x 5.3 (13.5)	29.3 (74.4) x 44.4 (112.8) x 5.4 (13.7)
	Weight (with stand)	61.6 lb/28 kg	75.9 lb/24 kg
	Weight (without stand)	52.8 lb/24 kg	66.0 lb/30 kg
	VESA wall mount standard	VESA 200mm	VESA 200mm
	Energy Star	Yes	Yes
Front Bezel Trademarks	<i>Dolby Digital, e-Star (on top)</i>	<i>Dolby Digital, e-Star (on top)</i>	
Regulatory compliance	Safety	FCC Class B, C-UL and UI	FCC Class B, C-UL and UI



## I/O Connectors

Name	Description
HDMI	Digital High Definition Input Video Input Connector with HDCP — Type A <ul style="list-style-type: none"> <li>• HDMI 1 (with HDMI audio in L and R)</li> <li>• HDMI 2</li> <li>• HDMI 3</li> </ul> Audio L and R must be set to PCM at the source across HDMI.
VGA	VGA monitor input with audio L/R (line in)
Audio Output	<ul style="list-style-type: none"> <li>• Digital (Optical) in Dolby Digital or PCM format (S/PDIF)</li> <li>• Audio Output L and R stereo analog (RCA)</li> </ul>
ANT/Cable in (RF input)	75-ohm unbalanced, F-type for VHF/UHF/CATV in
Component High Definition Input	<ul style="list-style-type: none"> <li>• 1: Y, Pb, and Pr, and audio L and R</li> <li>• 2: Y, Pb, and Pr, and audio L and R</li> </ul>
Serial RS-232	Serial input (Commercial use only)
Standard Definition Input	<ul style="list-style-type: none"> <li>• AV Input 1: S-Vid, Video, and Audio L and R</li> <li>• AV Input 2: S-Vid, Video, and Audio L and R</li> </ul>
Service Port	USB (For firmware upgrade use)

## Factory Preset Display Modes



Preset	Pixel format	Horizontal frequency (kHz)	Horizontal polarity	Vertical frequency (Hz)	Vertical polarity	Pixel Clk (MHz)	Source
1	640 x 480	31.469	–	59.940	–	25.175	VGA
2	640 x 480	37.500	–	75.000	–	31.500	VESA
3	720 x 400	31.469	–	70.087	+	28.322	VGA
4	800 x 600	37.879	+	60.317	+	40.000	VESA
5	800 x 600	46.875	+	75.000	+	49.500	VESA
6	1024 x 768	48.363	–	60.004	–	65.000	VESA
7	1024 x 768	56.476	–	70.069	–	75.000	VESA
8	1024 x 768	60.023	–	75.029	–	78.750	VESA
9	1280 x 768	47.396	+	59.995	–	68.250	VESA
10	1280 x 1024	63.981	+	60.020	+	108.000	VESA
11	1366 x 768	47.712	+	60.015	+	85.500	VESA
12	1920 x 1080	65.000	+	30.000	+	74.250	EIA

## Controlling the Onscreen Display

The onscreen display (OSD) is controlled by using the remote control or the bezel buttons on the left side of the TV.

The TV indicators (A and B) are located on the front of the TV.

## TV Indicators and Controls

<b>POWER</b>	<b>Power</b> button turns on the TV or places it in standby mode.		
<b>MENU</b>	<b>Menu</b> displays the onscreen display (OSD) or closes the OSD menu.		
<b>SELECT</b>	<b>SELECT</b> starts the Auto Sync function for a connected PC signal. In an OSD menu, selects the highlighted item in the OSD.		
<b>SOURCE</b>	<b>Source (SRC)</b> selects the input Menu. In an OSD menu, this functions as a back button or moves you up one item or menu level.		
<b>+CH</b> <b>-CH</b>	<b>Channel (CH)</b> selects the next or previous channel. In an OSD menu, press these buttons to move up or down in the menu.		
<b>+VOL</b> <b>-VOL</b>	<b>Volume (VOL)</b> raises or lowers the sound level. In an OSD menu, press these buttons to move right or left in the menu or to adjust an item.		
<b>A - LED Indicator</b>	Amber: TV is powering on (light turns off after about 30 seconds). HP Aqua Blue: TV is off but plugged into the power source. No light: TV is on or AC power cord is disconnected.		
<b>B - Remote Control Sensor</b>	Receives the signal from the remote control.		

# Remote Control

(IR protocol: RC6)

Remote control	Remote control button label	Remote control function
	Power	Use to turn power on or place TV into standby mode.
	SAP/MTS	Turn secondary audio program on and off.
	Sound	Select audio mode: Voice, Music, Standard, User.
	Picture	Select video mode: Vivid, Standard, Movie, or User.
	Source	Display list of input source.
	Menu	Open and exit OSD menu.
	Arrows	Move cursor left/right/up/down in the OSD menu or adjust a selected item
	OK	Choose the current menu option.
	Aspect	Change the image aspect ratio.
	Back	Go up one menu level when the OSD is displayed.
	Info	Display channel information about your current TV program.
	Volume	Turn volume up and down.
	Last	Go back to the previous channel.
	Mute	Turn the sound on and off.
	Ch+/Ch-	Move the channels up and down.
	CC	Display the closed caption content.
	Sleep	Display the sleep timer (15, 30, 60, 90,120 minutes).
	Fav	Shows Favorite channel list and allows adding current channel to the list and allows replacing one from the list with current channel.
	Numeric keypad	Enter channel number.
	_ (Dash)	Enter a dash for a subchannel number of a digital channel.
Enter	Select desired channel after entering the channel number with the numeric keypad.	

## TV Connectors

The connectors listed in the table following the images are located on the right and left sides and back of the TV.

While only one model is shown below, all four models (LT3200, LT3700, LT4200, LT4700) use the same connector configurations.



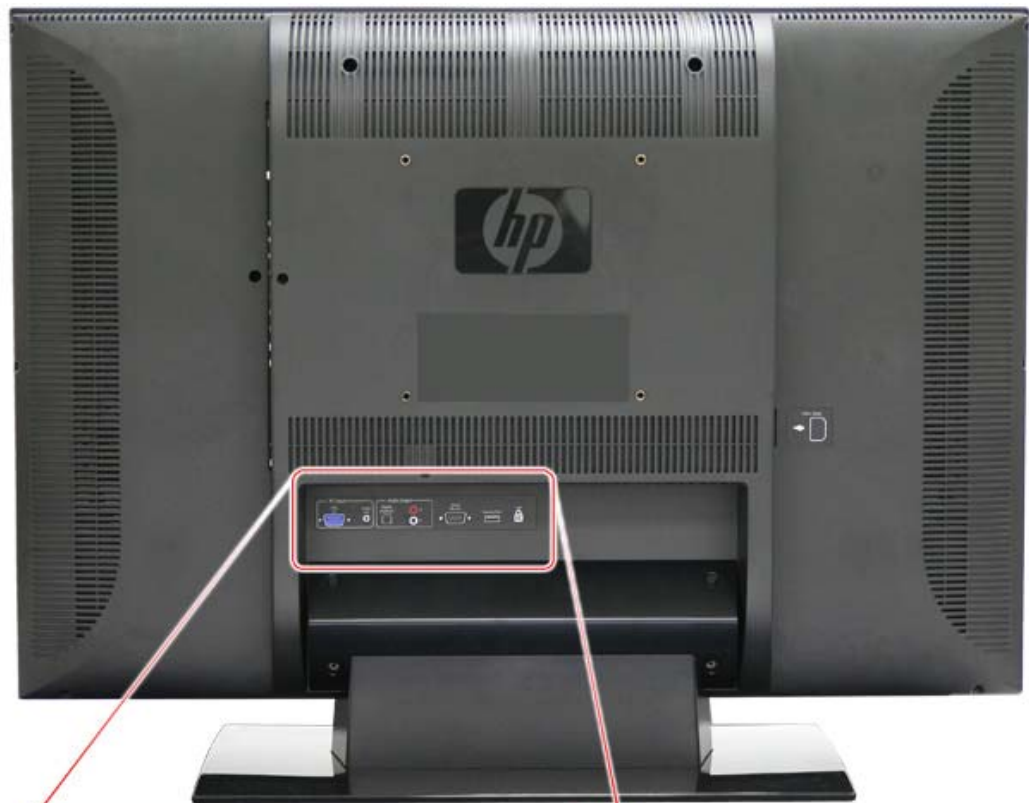

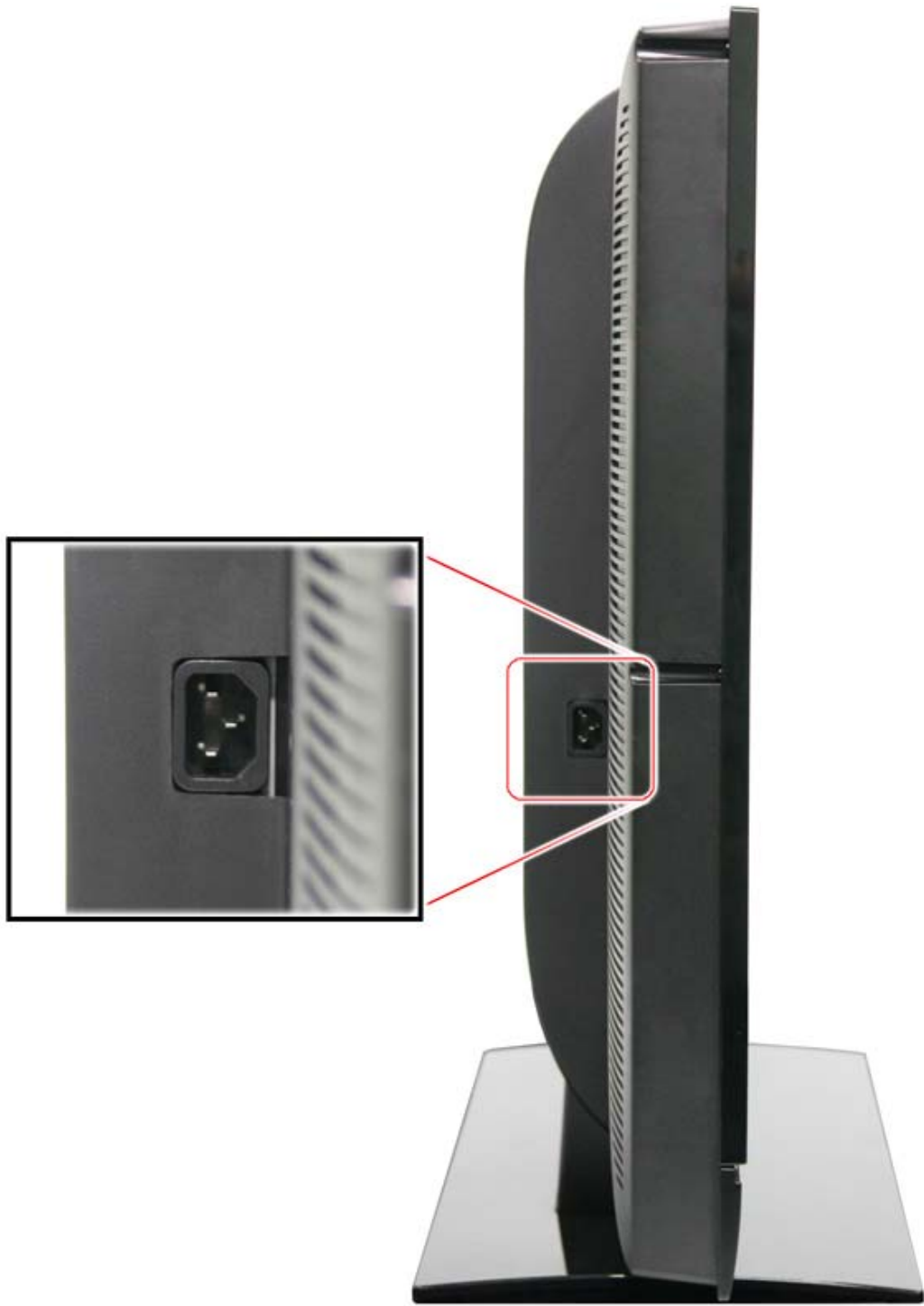

# Connectors

## AV Input

You can connect two sources of AV (audio/video) input simultaneously. The left column of ports is for Source 1 and the right column of ports is for Source 2. Each set consists of four ports:



- The yellow ports labeled **Video** connect single-channel composite video, which provides a sharper image than a coaxial RF connection.
- The adjacent red and white input ports labeled **Audio** connect the stereo audio soundtrack corresponding to composite or S-Video connections. The white port is for the left channel and the red port is for the right channel.
- The black ports labeled **S-Vid** connect S-Video, which transmits video in separate color and black-and-white image signals and delivers a sharper image than a composite video connection.

## Component Video Ports

Component video provides the highest video quality currently available. Component video is used by HDTV receivers, as well as some DVD players and other audio/video devices equipped with component video output. You can connect two component video sources simultaneously by using the left column of ports for Source 1 and the right column of ports for Source 2.



Component video cables transmit video in three channels—Y, Pb, and Pr. Some cables are five-headed with three channels of video and two of audio, whereas others are three-headed and require a separate stereo audio cable. The cables are connected as follows:

- The green port labeled **Y** connects to the cable carrying the Y signal.
- The blue port labeled **Pb** connects to the cable carrying the Pb signal.
- The red port labeled **Pr** connects to the cable carrying the Pr signal.
- The red port labeled **R** connects to the right audio channel.
- The white port labeled **L** connects to the left audio channel.

These connectors support 480i, 480p, 720p, and 1080i analog standard and high-definition format inputs. The TV automatically determines what format is being used by the currently connected device.

### HDMI Connectors

High Definition Multimedia Interface (HDMI) is an all digital audio/video interface. This series of TVs uses HDMI version 1.2 and supports 480i, 480p, 720p, and 1080i digital-format inputs. The TV automatically determines what format is being used by the currently connected device.

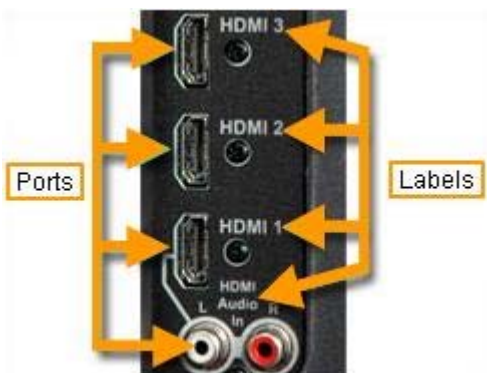



HDMI devices are usually HDTV receivers or DVD players. They connect using a single cable with a multipin connector. These TVs have three HDMI ports, so up to three HDMI devices can be connected at the same time.

The HDMI 1 port additionally supports separate HDMI audio. This configuration requires a DVI-to-HDMI converter that connects a DVI cable from optional DVI equipment and connects to the HDMI audio in ports using a pair of stereo audio connectors. The white port is for the left channel and the red port is for the right channel.

### RS-232 Port

The RS-232 connector works like a serial port on a PC and is also sometimes called a serial port. It is used to receive digital instructions from control applications running on a computer.

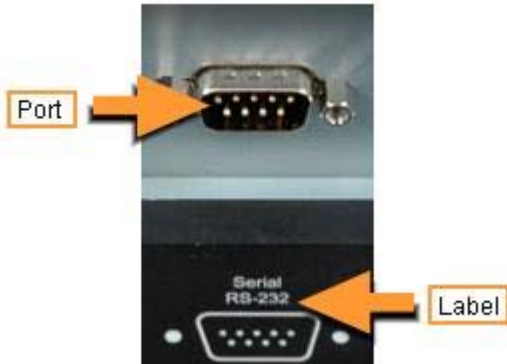

# Basic Operation

## Basic Operation

For more information about using your HP LCD TV, refer to the *HP HD LCD TV User's Guide* included with your TV.

There are two menus available – a customer-based menu (Simplemenu) and an advanced menu (Fullmenu). Simplemenu is the default setting.

Default selections are shown in **bold**.

## OSD (On-Screen Display) Functions – Simplemenu

TV OSD Menu Structure - Simplemenu		
Main	Sub1	Sub2/Options
<b>Picture</b>	Mode	<b>Vibrant</b> Standard Studio User
		Brightness
		Contrast
		Saturation
		Hue
		Sharpness
	Color Temp	Cool <b>Standard</b> Warm
	Aspect Ratio	<b>Auto</b> 16:9 Mode 4:3 Mode Zoom1 Zoom2 Panorama
	PC	<b>Auto Sync</b>
	<b>Audio</b>	Mode
Auto Volume		<b>On</b> Off
Virtual Surround		<b>Off</b> Theater Music Hall
Speaker		<b>On</b>
<b>Setup</b>	Caption	On <b>Off</b> On Mute
	Default Settings	Reset

## OSD Functions – Fullmenu

To access Fullmenu, select **SETUP > Caption**. Note that Caption Menu is only valid when current input selection is either TV, AV1/S-Video, or Component. Otherwise, caption menu will be disabled. Press the following remote keys: **MTS > 7 > 0 > 4**. To return to Simplemenu, select **Simplemenu** from Fullmenu.

TV OSD Menu Structure - Fullmenu					
Main	Sub1	Sub2/Options	Sub3/Options	Options	
<b>Picture</b>	Mode	<b>Vibrant</b>			
		Standard			
		Studio User			
		Brightness			
		Contrast			
		Saturation			
		Hue			
		Sharpness			
		Color Temp	Cool		
			<b>Standard</b>		
		Warm			
	Aspect Ratio	<b>Auto</b>	16:9 Mode		
			4:3 Mode		
			Zoom1		
			Zoom2		
			Panorama		
	PC	<b>H-Position</b>	V-Position		
			H-Size		
			V-Size		
			Phase Adjust		
Clock Adjust					
Auto Sync					
Default					
<b>Audio</b>	Mode	Voice			
		<b>Standard</b>			
		Music			
		User			
		Treble		<i>User mode only</i>	
	Bass		<i>User mode only</i>		
	Balance				
	Auto Volume	<b>On</b>			
		Off			
	SAP/MTS	Mono			
		<b>Stereo</b>			
		SAP			
		<b>English</b>	Spanish		
			French		
Digital Audio	<b>Dolby Digital</b>				
	PCM				
Virtual Surround	<b>Off</b>				
	Theater				
	Music Hall				

<b>Audio</b>	Speaker	On Off		
<b>Channel</b>	Channel Scan	Air Cable		
	Channel List			Show/Hide channel
	Signal Strength			
<b>Parental</b>	Change Password			
	Lock Enable	On Off		
	MPEG	G PG PG-13 R NC-17 X Not Rated		
	US TV Rating	FV, V, S, L, D TV-Y TV-Y7 TV-G TV-PG TV-14 TV-MA		
	Canadian English	E C C8+ G PG 14+ 18+		
	Canadian French	E G 8 ans+ 13 ans+ 16 ans+ 18 ans+		
<b>Setup</b>	<b>Time</b>	<b>Clock Mode</b>	Auto Manual	
		<b>Clock Set</b>	Month, Day, YR, Hr. Min, AM/PM	
		<b>Time Zone</b>	NST AST EST CST MST PST AKST HST	Active for "Auto".

<b>Setup (cont)</b>	<b>Time (cont)</b>	<b>Daylight Saving</b>	On Off	Active for "Auto".
		<b>Sleep Timer</b>	<b>Off</b> 15 min 30 min 60 min 120 min 150 min	
	<b>Caption</b>	<b>Mode</b>	On <b>Off</b> On Mute	
		<b>Service Analog</b>	<b>CC1</b> CC2 CC3 CC4 Text1 Text2 Text3 Text4	
		<b>Service Digital</b>	<b>Service1</b> Service2 Service3 Service4 Service5 Service6	
		<b>Style</b>	Font Size	<b>Default</b> Small Standard Large
			Font Style	<b>Default</b> Style0 Style1 Style2 Style3 Style4 Style5 Style6 Style7
			Foreground Color	<b>Default</b> White Black Red Green Blue Yellow Magenta Cyan
			Background Color	<b>Default</b> White Black Red Green

Setup (cont)	Caption (cont)	Style (cont)	Background Color (cont)	Blue
				Yellow
				Magenta
				Cyan
			Foreground Opacity	<b>Default</b>
				Solid
				Translucent
				Transparent
				Flashing
			Background Opacity	<b>Default</b>
				Solid
				Translucent
				Transparent
				Flashing
			Edge Style	<b>Default</b>
				Edge Style0
				Edge Style1
				Edge Style2
				Edge Style3
				Edge Style4
				Edge Style5
	OSD Language	<b>English</b>		
		Spanish		
		French		
	Setup Wizard			
		[ Start ]		
	Input Labels			
		AV1	Default	
		AV2	AVR	
		Component 1	DVD	
		Component 2	PVR	
		HDMI 1	CABLE	
		HDMI 2	DEC	
		HDMI 3	AUX	
		VGA	SAT	
			VCR	
	Default Settings			
		[ Reset ]		
SimpleMenu™				

# Command Table RS-232

## Remote Commands Over RS232c Port

The HP HDTVs include a male DB-9 RS-232 connector with the following pin out.

Pin	Function
2	TX
3	RX
5, 10	GND
1, 4, 6, 7, 8, 9	No Connect

Set the RS-232c communications settings on the PC to match the TV's communication conditions. The TV's communications settings are as follows:

<b>Baud rate</b>	9600 bps
<b>Data length</b>	8 bits
<b>Parity bit</b>	None
<b>Stop bit</b>	1 bit
<b>Flow control</b>	CTS/RTS

The 7-byte command format uses a 3-byte command field and a 4-byte parameter field as follows:

CMD-1	CMD-2	CMD-3	PAR-1	PAR-2	PAR-3	PAR-4	CR
-------	-------	-------	-------	-------	-------	-------	----

## Command Set

COMMAND: 3 bytes  
PARAMETER: 4 byte  
CR (Carriage Return) at the end of string

"OK" + CR: success  
"ERR" + CR: failure

The command is terminated by a Carriage Return (CR). Don't send multiple commands at the same time. Wait until you receive an OK response before you send the next command. Make sure parameter values are entered left-aligned and that you fill with blanks the remaining values. In the following RS-232 Command Table, "\_" indicates "space", "\*" indicates a valid value in the range specified under the "Control Contents" columns, and "x" indicates any numerical value.

**Note:** The TV is expecting to receive the entire 8-byte string (3-byte command + 4-byte command + CR) at once. If you use a tool that sends a single character at a time, like a Hyper terminal, the TV will automatically return an error (ERR) signal.

**Example:** To turn off the TV. The command is P W R 0 \_ \_ \_ CR, which translates in Hex to the 8-byte command: 50 57 52 30 20 20 20 OD.

Control Item		Command			Parameter				Control Contents	
Power setting		P	W	R	0	_	_	_	Off	Shifts TV to standby if it is in power-on mode.
		P	W	R	1	_	_	_	On	
Input Select		I	N	P	x	x	_	_	Input terminal number (0-8) or (0-7) depends on SKU	It switches input (the sequence is TV Air/Cable, AV1, AV2, YPbPr1, YPbPr2, VGA, HDMI1, HDMI2, HDMI3)
AV mode selection		A	V	M	0	_	_	_	Movie	
					1	_	_	_	Vivid	
					2	_	_	_	Standard	
					3	_	_	_	USER	
Volume		V	O	L	*	*	_	_	Volume (0-100)	
VGA	H-Position	H	P	O	*	*	*	_	PC mode (0-100)	
	V-Position	V	P	O	*	*	*	_	PC mode (0-100)	
	H-Size	H	S	Z	*	*	*	_	PC mode only (0-100)	
	V-Size	V	S	Z	*	*	*	_	PC mode only (0-100)	
	Clock	C	L	K	*	*	*	_	PC mode only (0-100)	
	Phase	P	H	S	*	*	*	_	PC mode only (0-100)	
Aspect		A	S	P	0	_	_	_	Auto mode	
					1	_	_	_	16:9 mode	
					2	_	_	_	4:3 mode	
					3	_	_	_	Zoom1 mode	
					4	_	_	_	Zoom2 mode	
					5	_	_	_	Panorama mode	
Mute		M	U	T	0	_	_	_	Mute On	
					1	_	_	_	Mute Off	
Dolby Virtual		A	C	B	0	_	_	_	PCM	
					1	_	_	_	Dolby	
Audio Selection		A	C	H	0	_	_	_	Analog - Mono/Digital-audio1	
					1	_	_	_	Analog - Sap/Digital- audio2	
					2	_	_	_	Analog - Stereo/Digital-audio3	
Sleep Timer		S	L	P	0	_	_	_	Off	
					1	_	_	_	Off Timer – 30 Min.	
					2	_	_	_	Off Timer – 60 Min.	
					3	_	_	_	Off Timer – 90 Min.	
					4	_	_	_	Off Timer – 120 Min.	
					5	_	_	_	Off Timer – 150 Min.	



Control Item		Command			Parameter				Control Contents	
Channel	Direct Channel (Analog)	D	C	A	*	*	*	_	The channel number of TV (1-125)	An input change is included if it is not TV display. In air, channel 2 - 69 are effective. In cable, channel 1 - 125 are effective.
		D	C	J	*	*	*	*	0 - 999	Major number for digital channel, combine with DCN command
		D	C	N	*	*	*	_	0 - 999	Minor number for digital channel, combine with DNJ command
	CH Up	C	U	P	0	_	_	_	The channel number of TV +1	If not TV display, it will input switch to TV, same function as CH Up
	CH Down	C	D	W	0	_	_	_	The channel number of TV - 1	If not TV display, it will input switch to TV, same function as CH Down
CC operation		C	C	O	0	_	_	_	CC Off	
					1	_	_	_	CC On	
					2	_	_	_	CC Mute	Toggle CC on while audio muted
Brightness		B	R	T	*	*	*	_	Brightness (0-100)	
Contrast		C	T	R	*	*	*	_	Contrast (0-100)	
Color		C	L	R	*	*	*	_	Color (0-100)	
Hue		H	U	E	*	*	*	_	Hue (0-100)	
Sharpness		S	R	P	*	*	*	_	Sharpness (0-100)	
Color temperature		C	T	M	0	_	_	_	Warm	
					1	_	_	_	Standard	
					2	_	_	_	Cool	
Auto sync		A	S	Y	0				Auto sync only in PC mode	
Audio mode		A	M	D	0	_	_	_	Voice mode	
					1	_	_	_	Music mode	
					2	_	_	_	Standard mode	
					3	_	_	_	User mode	
Virtual Surround		O	S	R	0	_	_	_	Off	
					1	_	_	_	Theater	
					2	_	_	_	Music Hall	
Internal Speaker		S	P	K	0	_	_	_	Off	Internal speaker off (SPDIF is still working)
					1	_	_	_	On	

Control Item		Command			Parameter				Control Contents	
Air/cable selection for <b>Auto Search</b>		A	C	S	0	-	-	-	<b>Air for Auto Scan</b>	Move this command to <b>Auto Search</b> .
					1	-	-	-	<b>Cable for Auto Scan</b>	
Start auto search		A	S	H	0	-	-	-	<b>Start</b> auto search if current source is TV	Need air/cable input type (ACS command) before starting auto search
Manual search		M	S	H	*	*	*	-	Manually search a certain channel if current source is TV.	Digital air channel: 2~69 Cable channel: 2~135
Channel skip	Skip analog channel	K	A	C	*	*	*	-	Skip a certain valid analog channel	
	Skip digital channel (Major)	K	D	J	*	*	*	-	Skip a certain valid digital channel (major)	Combined with „ KDN” command.
	Skip digital channel (Minor)	K	D	N	*	*	*	-	Skip a certain valid digital channel (minor)	Combined with „ KDJ” command
Reset to default		R	D	F	0	-	-	-	Reset all settings to default	
Set time mode		T	M	M	0	-	-	-	Auto	
					1	-	-	-	Manual	
Set time	Set time year	S	T	Y	*	*	*	*	Year, if time mode is manual (1990~2037)	
	Set time month	S	T	M	*	*	-	-	Month, if time mode is manual (01~12)	
	Set time day	S	T	D	*	*	-	-	Day, if time mode is manual (01~31)	
	Set time hour	S	T	H	*	*	-	-	Hour, if time mode is manual (00~23)	
	Set time minute	S	T	U	*	*	-	-	Minute, if time mode is manual (00~59)	

Control Item	Command			Parameter			Control Contents		
Time Zone	T	M	Z	0	_	_	_	NST	
				1	_	_	_	AST	
				2	_	_	_	EST	
				3	_	_	_	CST	
				4	_	_	_	MST	
				5	_	_	_	PST	
				6	_	_	_	AKST	
				7	_	_	_	HST	
Select analog CC service	A	C	C	0	_	_	_	CC1	
				1	_	_	_	CC2	
				2	_	_	_	CC3	
				3	_	_	_	CC4	
				4	_	_	_	T1	
				5	_	_	_	T2	
				6	_	_	_	T3	
				7	_	_	_	T4	
Select digital CC service	D	C	C	1	_	_	_	Select a certain service 1	
				2	_	_	_	Service 2	
				3	_	_	_	Service 3	
				4	_	_	_	Service 4	
				5	_	_	_	Service 5	
				6	_	_	_	Service 6	
				Select OSD language	L	A	G	0	_
1	_	_	_					French	
2	_	_	_					Spanish	
All screen white mode (PDP only)	S	R	W	1	_	_	_		Displayed for 3 minutes to help reduce the appearance of after image on the screen
Black Level	B	L	K	0	_	_	_	Light (0 IRE)	Enabled component input only. Effective for 480i.
				1	_	_	_	Black (7.5 IRE)	

**RS-232 Commands Extensions for Professional Series HDTVs**

Control Item	Command			PARAMETER				Parameter	Return Data/Description
PWR MANAGE	P	M	G	*	-	-	-	SELECT	0-7, selects number of hours of no activity before auto SHUT_OFF is activated. 0=PWR Manage is OFF (Default), 1=1 hr, 2=2 hrs, etc.  This command detects I/O activity (IR or keypad or RS232 commands) and if there is no activity for „ specified hours” , TV will be turned off after specific times.
CAPTION LOCK	C	A	L	*	-	-	-	RETAIN SETTINGS	1 = Retain caption setting (current setting) at power off (Default). 0 = Captions is always OFF at turn on. CC Enable / Disable during the power cycle.
STR_AUX_SOURCE	S	A	S	1	-	-	-	SET (ON)	1 = Set starting with auxiliary source/input which is selected by ‘SOURCE AT-P-ON’ command (SON) on Power ON. Pair with SOURCE AT-P-ON command (SON).
				0	-	-	-	RESET (OFF)	0 = TV starting with “Previous” input on Power On (Default).
SOURCE AT P-ON	S	O	N	*	-	-	-	INPUT SOURCE	TV input source at PWR on. 0: TV (Cable or AIR) (Default). 1:AV1, 2:AV2, 3:YPbPr1, 4:YPbPr2, 5. VGA, 6:HDMI1, 7.HDMI2, 8:HDMI3 Pair with STR_AUX_SOURCE command (SAS)
EN NOISE MUTE	E	N	M	*	-	-	-	AUDIO MUTE	1 = Audio muted if no signal is present. 0 = Audio is NOT muted (Same as current implementation. Default.)
KEY LOCK	K	L	K	*	-	-	-	KEYBOARD LOCK	1 = TV front keyboard except PWR is locked, IR control key works. 0 = TV front keyboard is unlocked (Default).
VIDEO MUTE ENABLE	V	M	E	*	-	-	-	ENABLE	1 = Blank video (mute). 0 = Normal video (Default) This is only through RS232 commands.
REMOTE CON MODE	R	C	M	*	-	-	-	REMOTE ACTIVE	0 = PC. 1 = Remote control. 2 = Enable both PC and remote (Default).
START CHANNEL	S	T	C	*	*	*	-	SELECT (Analog Channel)	Channel a Power ON. 1-125=channel 1-125. 126=map to Ch3. 127=map to Ch4. 255=tune to last channel before turn power OFF.  This command is valid only when SOURCE AT P-ON (SON) is set to 0 (TV Input). When both STC (Analog) and STA + STI are set, the last command set is effective.

Control Item	Command			PARAMETER				Parameter	Return Data/Description
	S	T	A	*	*	*	_	SELECT (Digital, MAJOR Channel)	1-999 (Major channel number)
	S	T	I	*	*	*	_	SELECT (Digital, MINOR Channel)	1-999 (Minor channel number) This Command is valid only when SOURCE
CHANNEL LOCK	C	H	L	*	_	_	_	ENABLE	1 = Enables channel lock so cannot change channel from current channel from IR remote, usually the START channel. 0 = Default (channel lock is disabled). No change from Remote.
START VOLUME	S	T	V	*	*	*	_	SELECT	0-100 = Select volume level on TV turn on. 255 = Retain last volume setting (Default). This command sets initial volume level on PWR ON regardless of previous volume level.
MIN VOLUME	M	N	V	*	*	*	_	SELECT	0-100 = Select MIN allowance volume setting, 0 = Default. MNV setting must be less than MXV.
MAX VOLUME	M	X	V	*	*	*	_	SELECT	0-100 = Select MAX allowance volume setting, 100 = Default. MNV setting must be less than MXV.
MUTE DISABLE	M	D	I	*	_	_	_	SELECT	1 = Disable audio mute. 0 = Sound mute can be activated (Default). Blocks Mute function. When TV is in Mute status and receives MDI1, TV audio is activated. Then Mute button of remote and MUT0/1 (Mute On/Off) command is ignored.

## Return messages

For every command, TV should return reply. Controller waits before sending another command because some commands take time before TV is ready to accept next command. For example, the “channel scan” command takes minutes.

For Normal Response

O K CR

CR : Carriage Return (0Dh)

For Error condition:

E R CR

CR : Carriage Return (0Dh)

## Special command extension

CONTROL ITEM	Command			PARAMETER	Parameter	Return Data	
GET STATUS (Return current TV status value)	G	S	T	0	_ _ _	Power	0: Off (return from MCU), 1: On
				1	_ _ _	Mute	0: Off, 1: On, 2: On Mute
				2		Volume	Current Volume level: 0 ~ 100 (ASCII format)
				3		CH (major)	0 ~ 9999 (e.g.) Ch 99 : 0099, Ch 9 : 0009 in ASCII)
				4		CH (minor)	0 ~ 9999 (e.g.) Ch 99 : 0099, Ch 9 : 0009 in ASCII)
				5		Caption	0: Off, 1: On
				6		Input source	0 ~ 8 : (TV Air/Cable, AV1, AV2, YPbPr1, YPbPr2, VGA, HDMI1, HDMI2, HDMI3)
				7		Aspect	0: Auto, 1: (16:9), 2: (4:3), 3: (Zoom1), 4: (Zoom2), 5: (Panorama)
				8		Brightness	0 ~ 100 (e.g. 7 -> 0007, 77 -> 0077) in ASCII
				9		Contrast	0 ~ 100 (e.g. 7 -> 0007, 77 -> 0077) in ASCII
				A		Sharpness	0 ~ 100 (e.g. 7 -> 0007, 77 -> 0077) in ASCII
				B		Color	0 ~ 100 (e.g. 7 -> 0007, 77 -> 0077) in ASCII
				C		Hue	0 ~ 100 (e.g. 7 -> 0007, 77 -> 0077) in ASCII

Get Status *RETURN* message format for “GST”(Get Statue) command:

?	O	K	W	X	Y	Z	CR	0	0	0	0
---	---	---	---	---	---	---	----	---	---	---	---

**Format of WXYZ (always 4 bytes):**

For all return values: (add prefix with 0s, right justify).

If volume is 89, return value will be 0089 (add '00').

If channel is 7, return value will be 0007 (add '000').

If Mute is 1, return value will be 0001 (add '000').

# Replaceable Parts

This chapter contains the service parts lists of each model.

## Parts List by Model

To see the pictures of the replaceable parts, go to the “Replacement Parts List Reference Picture” section.

### Model LT3200

Picture Number	Part Description	OEM Part Numbers	HP Part Number
1	Stand base	60.3YI02.001	452084-001
2	Stand neck assy Stand neck Repair screw kit	42.3YI02.001 6K.3YISC.003	455587-001
3	Power supply assy - For 3x models -230W Power supply - 3x model System board to power supply cable	56.04230.Q01 50.3YJ02.001	455591-001
4	Main Board assy Main board System board to power supply cable	91.3YW10.001G 50.3YJ02.001	455593-001
5	Back cover - bucket	60.3YI07.001	452092-001
6	Keypad - Infrared assy Keypad buttons Keypad PCA board Infrared board System board to keypad/IR cable	60.3YJ03.001 91.3YK10.003G 91.3YK10.002G 50.3YJ03.001	455604-001
7	Internal support wall mount	33.3YI06.001	452097-001
8	Mesh bracket board cover	34.3YI01.001	452098-001
9	Speakers (L and R and wire connectors)	23.40276.001	452108-001
10	Front bezel including speaker cover	60.3YI01.001	452114-001
11	I/O bracket with AC inlet	90.3YI28.007G	452126-001
12	Inverter board Inverter board - Master Inverter cable	27-D010279 50.3YI02.001	455596-001
13	Control board Control board LVDS cable	35-D013932 50.3YI01.001	455600-001
--	Power cord	8121-0740	--
--	Remote control	5188-6301 / 90.3YI26.001	452113-001
--	Cable clamp	38.05031.001	452127-001
--	Repair screw kit	34.37P06.001 (2) 86.00G29.668 (4) 86.1A334.6R0 (4) 86.1A336.6R0 (10) 86.1H524.8R0 (4) 86.RA324.100 (2) 86.VA314.6R0 (4) 86.VA326.100 (4) 86.9A338.150 (8) 86.TA526.100 (4)	452128-001
--	VGA cord	--	453143-001
--	Whole unit – head only	--	451704-001

## Model LT3700

To see the pictures of the replaceable parts, go to the “Replacement Parts List Reference Picture” section.

Picture Number	Part Description	OEM Part Number	HP Part Number
1	Stand base	60.3YG11.001	452085-001
2	Stand neck assy Stand neck Repair screw kit	42.3YH02.001 6K.3YISC.003	455588-001
3	Power supply assy - For 3x models -230W Power supply - 3x model Main board to power supply cable	56.04230.Q01 50.3YJ02.001	455591-001
4	Main board assy Main board Main board to power supply cable	91.3YW10.002G 50.3YJ02.001	455594-001
5	Back cover - bucket	60.3YI07.001	452093-001
6	Keypad - Infrared assy Keypad buttons Keypad PCA board Infrared board System board to keypad/IR cable	60.3YJ03.001 91.3YK10.003G 91.3YK10.002G 50.3YJ03.001	455604-001
7	Internal support wall mount	33.3YI06.001	452097-001
8	Mesh bracket board cover	34.3YI01.001	452098-001
9	Speakers (L and R and wire connectors)	23.40276.001	452108-001
10	Front bezel including speaker cover	60.3YH06.001 (speaker cover) adhered to 60.3YH08.001 (front bezel)	452115-001
11	I/O bracket assy with AC inlet	90.3YI28.007G	452126-001
12	Inverter board assy Inverter boards (master and slave) (master pictured) Inverter cable - master or 1 Inverter cable - slave or 2	6632L-0314A – master 6632L-0315A – slave 50.3YG03.001 50.3YG04.001	455597-001
13	Control board assy Control board LVDS cable Ribbon cables	6871L-1083A 50.3YG02.001 6851L-0071E	455601-001
--	Power cord	8121-0740	--
--	Remote control	5188-6301 / 90.3YI26.001	452113-001
--	Cable clamp	38.05031.001	452127-001
--	Repair screw kit	34.37P06.001 (2) 86.00G29.668 (4) 86.1A334.6R0 (4) 86.1A336.6R0 (10) 86.1H524.8R0 (4) 86.RA324.100 (2) 86.VA314.6R0 (4) 86.VA326.100 (4) 86.9A338.150 (8) 86.TA526.100 (4)	452128-001
--	VGA Cord	--	453143-001
--	Whole unit - head only	--	451705-001



## Model LT4200

To see the pictures of the replaceable parts, go to the “Replacement Parts List Reference Picture” section.

Picture Number	Part Description	OEM Part Number	HP Part Number
1	Stand base	60.3YJ17.001	452086-001
2	Stand neck assy Stand neck Repair screw kit	42.3YJ06.001 6K.3YISC.003	455589-001
3	Power supply assy - For 4x models -338W Power Supply - 4x model System board to power supply cable	56.04338.R01 50.3YJ02.001	455592-001
4	Main board assy Main board System board to power supply cable	91.3YW10.003G 50.3YJ02.001	455595-001
5	Back cover - bucket	60.3YJ05.001	452094-001
6	Keypad - Infrared assy Keypad buttons Keypad PCA board Infrared board System board to keypad/IR cable	60.3YJ03.001 91.3YK10.003G 91.3YK10.002G 50.3YJ03.001	455604-001
7	Internal support wall mount	33.3YI06.001	452097-001
8	Mesh bracket board cover	34.3YI01.001	452098-001
9	Speakers (L and R speaker and wire connectors)	23.40276.001	452108-001
10	Front bezel including speaker cover	60.3YJ16.001 (speaker cover) adhered to 60.3YJ15.001 (front bezel)	452116-001
11	I/O bracket assy with AC inlet	90.3YI28.007G	452126-001
12	Inverter board assy Inverter boards (master and slave) (master pictured) Inverter cable - master or 1 Inverter cable - slave or 2	27-D005861 50.3YJ05.001 50.3YJ08.001	455598-001
13	Control board assy Control board LVDS cable Ribbon cables – qty 4	35-D010727-M 50.3YJ04.001 32-D005703	455602-001
--	Power cord	8121-0740	--
--	Remote control	5188-6301 / 90.3YI26.001	452113-001
--	Cable clamp	38.05031.001	452127-001
--	Repair screw kit	34.37P06.001 (2) 86.00G29.668 (4) 86.1A334.6R0 (4) 86.1A336.6R0 (10) 86.1H524.8R0 (4) 86.RA324.100 (2) 86.VA314.6R0 (4) 86.VA326.100 (4) 86.9A338.150 (8) 86.TA526.100 (4)	452128-001
--	VGA cord	--	453143-001
--	Whole unit – head only	--	451706-001



## Model LT4700





To see the pictures of the replaceable parts, go to the “Replacement Parts List Reference Picture” section.

Picture Number	Part Description	OEM Part Number	HP Part Number
1	Stand base	60.3YK13.001	452087-001
2	Stand neck assy Stand neck Repair screw kit	60.3YK02.001 6K.3YISC.003	455590-001
3	Power supply assy - For 4x models -338W Power supply - 4x model System board to power supply cable	56.04338.R01 50.3YJ02.001	455592-001
4	Main board assy Main board System board to power supply cable	91.3YW10.003G 50.3YJ02.001	455595-001
5	Back cover - bucket	60.3YK04.001	452095-001
6	Keypad - Infrared assy Keypad buttons Keypad PCA board Infrared board System board to keypad/IR cable	60.3YJ03.001 91.3YK10.003G 91.3YK10.002G 50.3YJ03.001	455604-001
7	Internal support wall mount	33.3YI06.001	452097-001
8	Mesh bracket board cover	34.3YI01.001	452098-001
9	Speakers (L and R and wire connectors)	23.40276.001	452108-001
10	Front bezel with speaker cover	60.3YJ16.001 (speaker cover) adhered to 60.3YJ15.001 (front bezel)	452117-001
11	I/O bracket assy with AC inlet	90.3YI28.007G	452126-001
12	Inverter board assy Inverter boards (master and slave) (master pictured) Inverter cable - master or 1 Inverter cable - slave or 2	27-D005130 50.3YK02.001 50.3YJ08.001	455599-001
13	Control board assy Control board LVDS cable Ribbon cables – qty 4	35-D013131 50.3YK01.001 32-D007123	455603-001
--	Power cord	8121-0740	--
--	Remote control	5188-6301 / 90.3YI26.001	452113-001
--	Cable clamp	38.05031.001	452127-001
--	Repair screw kit	34.37P06.001 (2) 86.00G29.668 (4) 86.1A334.6R0 (4) 86.1A336.6R0 (10) 86.1H524.8R0 (4) 86.RA324.100 (2) 86.VA314.6R0 (4) 86.VA326.100 (4) 86.9A338.150 (8) 86.TA526.100 (4)	452128-001
--	VGA cord	--	453143-001
--	Whole unit - head only	--	451707-001

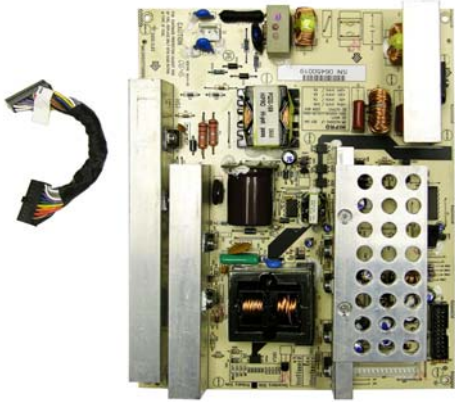
# Replacement Parts List Reference Pictures

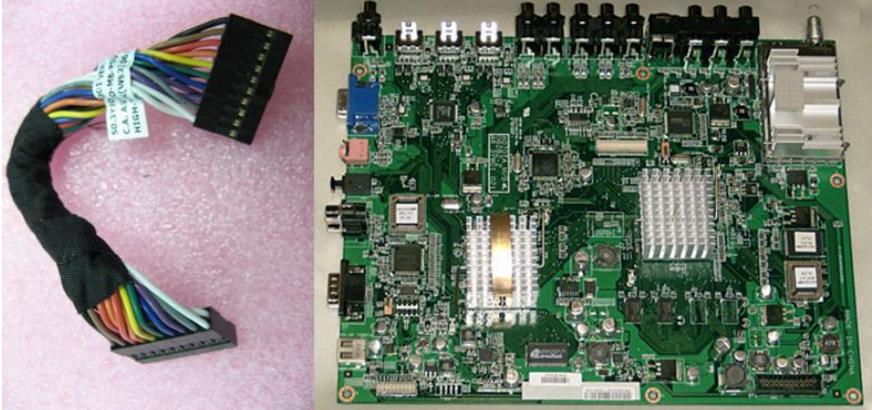
**Note:** Not every individual part for every model is shown here. However, you can use the pictures as a reference for all models.

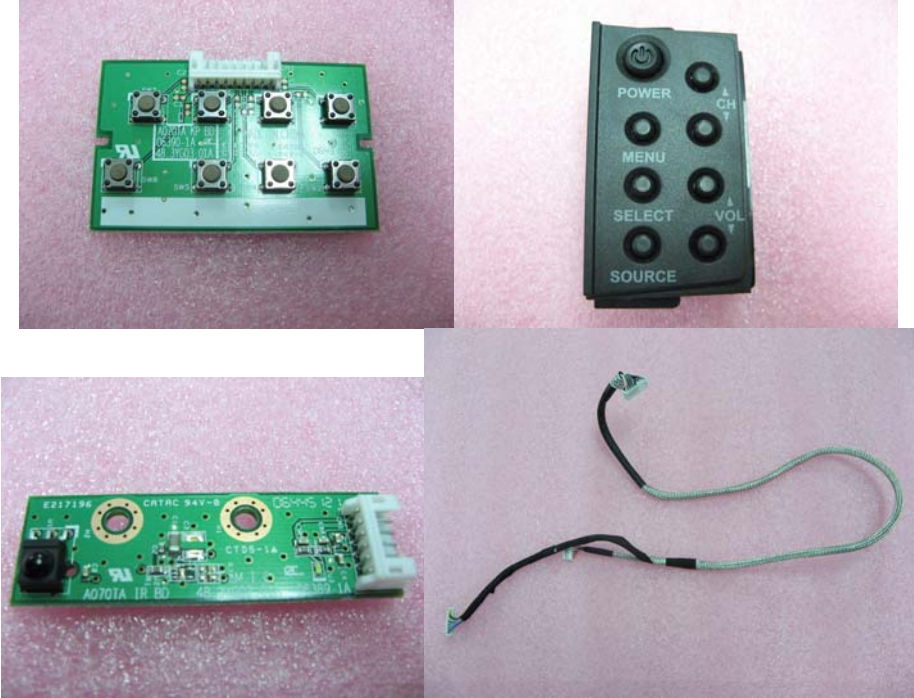
Picture Reference Number	Picture of Replacement Part
1	
2	
3	

Picture Reference Number	Picture of Replacement Part
4	
5	
6	
7	

Picture Reference Number	Picture of Replacement Part
8	
9	
10	
11	

Picture Reference Number

Picture of Replacement Part

12

**LT3200**

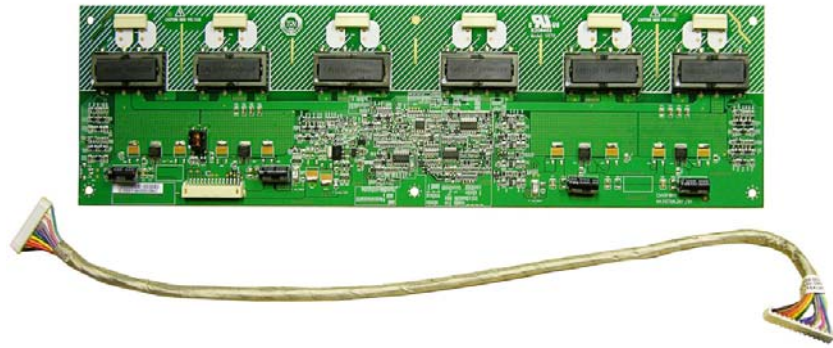

**LT3700**



**LT4200**

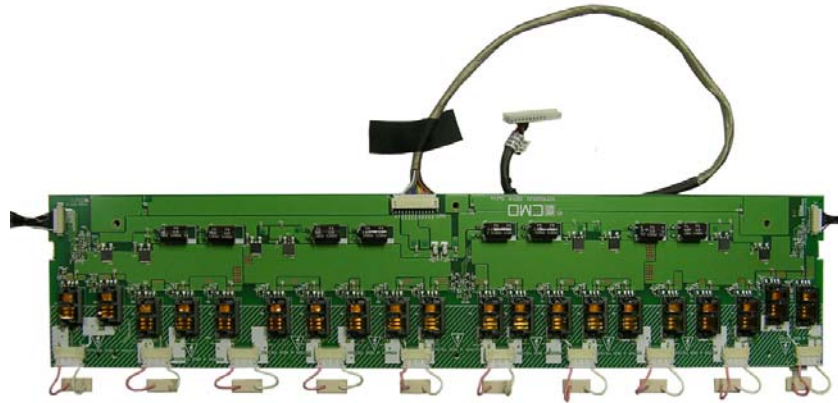

**LT4700**

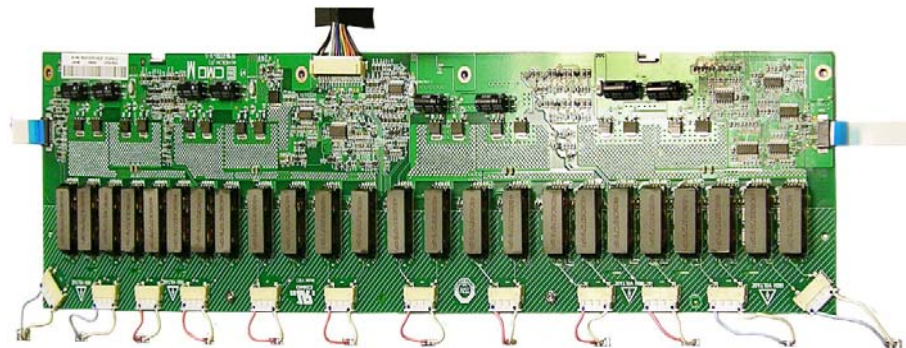

**Note:** 37", 42", 47" models will include two inverter boards. Only one inverter board is shown for each model.

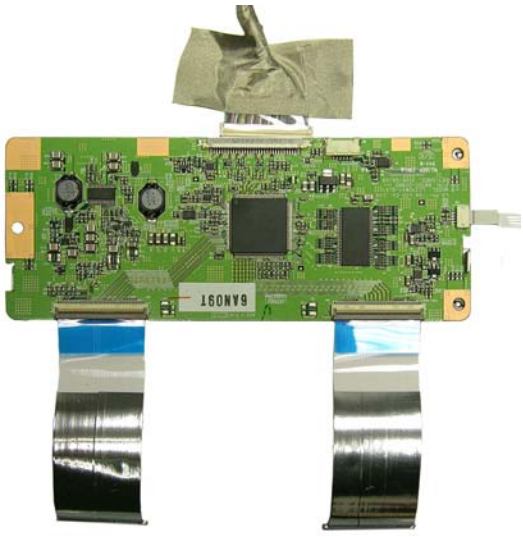
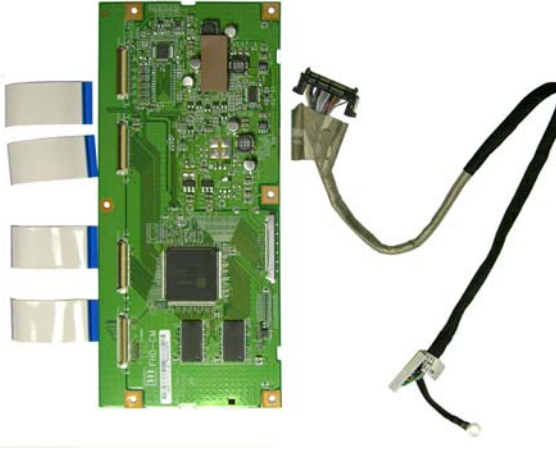
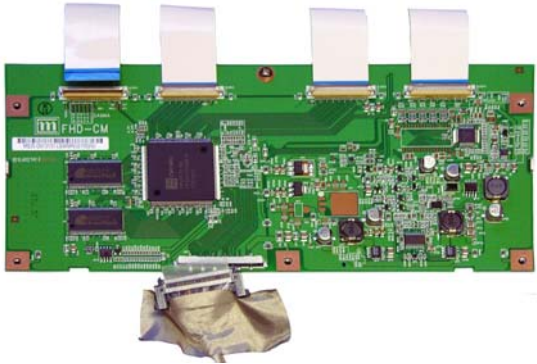
Picture Reference Number	Picture of Replacement Part
13	<p style="text-align: center;"><u>LT3200</u></p>  <p>The image shows a green printed circuit board (PCB) for the LT3200 model. It features a central black integrated circuit (IC) with the 'orly' logo. The board is populated with various electronic components, including capacitors and resistors. It has four gold-colored ribbon cable connectors along the bottom edge and four mounting tabs along the top edge.</p>
	<p style="text-align: center;"><u>LT3700</u></p>  <p>The image shows a green PCB for the LT3700 model. It has a central black IC and various components. Two wide, silver-colored ribbon cables are attached to the bottom edge. A piece of brown paper is attached to the top edge. A white label with the number '160N9' is visible on the board.</p>
	<p style="text-align: center;"><u>LT4200</u></p>  <p>The image shows a green PCB for the LT4200 model. It has a central black IC and various components. Three wide, silver-colored ribbon cables are attached to the left edge. A black cable with a connector is attached to the right edge.</p>
	<p style="text-align: center;"><u>LT4700</u></p>  <p>The image shows a green PCB for the LT4700 model. It has a central black IC and various components. Four wide, silver-colored ribbon cables are attached to the top edge. A piece of brown paper is attached to the bottom edge. A white label with the number '160N9' is visible on the board.</p>

# Removal and Replacement

This section includes information about disassembling the LCD TV for service.

## Equipment and Tools Needed for Removal and Replacement

### Tools

- #1 and #2 magnetic Philips screwdriver with 6-inch shaft, no greater than 3/8-inch in diameter
- 3/16-inch hex driver
- 5/8-inch hex driver
- ESD protect gloves
- ESD protect wristband

---

**Note:** An HDMI to DVI converter is for use on notebook computers with DVI connectors.

---

### After Service Checklist

- 1 Make sure all the mechanical parts such as screws are replaced properly.
- 2 Verify that the peripherals of the serviced points have not undergone any deterioration during servicing.
- 3 Verify that the screws, parts, and cables that are removed for servicing have all been returned to their proper locations per the original setup.
- 4 Check the software version.
- 5 Check whether or not the TV works properly from each source.

### Basic Adjustment Settings

No extra adjustments settings are needed.



## Four Models – Comparison Pictures

This section provides pictures of each TV model with the rear cover removed. Use these images to familiarize yourself with each TV and its associated parts.

### LT3200



### LT3700



## LT4200



## LT4700

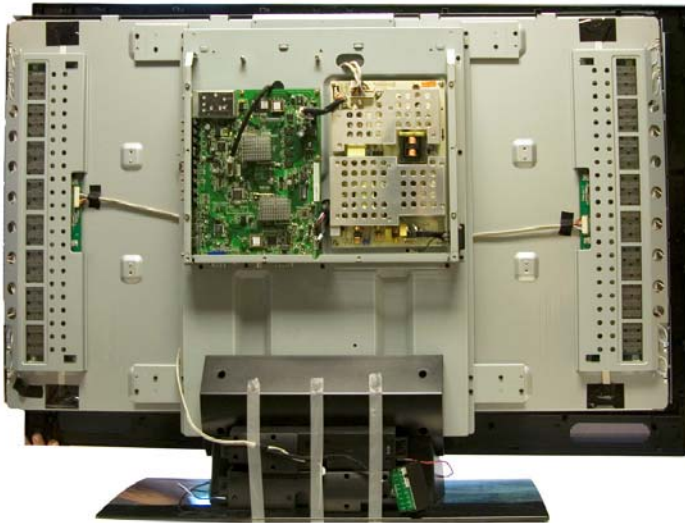

# Removal Procedures

Included in this section are the following procedures and illustrations:

- Removing the TV Pedestal
- Disassembling the Pedestal
- Removing the Back Cover
- Removing the Function Keyboard
- Installing the Keyboard PCA
- Removing the Infrared Board
- Removing the Wall Mount Bracket
- Removing the Board Cover
- Removing the Main Board
- Removing the Power Supply
- Removing the Main Bracket
- Removing the Inverters
- Removing the Speakers
- Removing the Control Board
- Removing the Front Bezel

## Removal Order

To remove the following components, you can remove the main bracket while leaving the main board and power supply in place:

- Control board
- IR board
- Inverters
- Speakers

## Screws

All screws in the TV are all Philips head of differing sizes, lengths, and threads.

As a general rule, screws that secure plastic components are self-tapping, while screws that secure metal components are machine screws.

A repair screw kit (452128-001) containing a sampling of all screws is available.

## Removing the Pedestal

- 1 Carefully place the TV with the glass screen facing downward on a padded, stable table.
- 2 Position the bottom of the TV near the edge of the table so the pedestal hangs off the edge of the table.
- 3 Remove the four screws.



- 4 Carefully lift the pedestal off the TV.



## Disassembling the Pedestal

- 1 Position the pedestal so you can access the screws from the bottom of the pedestal.
- 2 Remove the four screws that hold the two pieces of the pedestal together.  
**Note:** Hole usage varies depending on model.

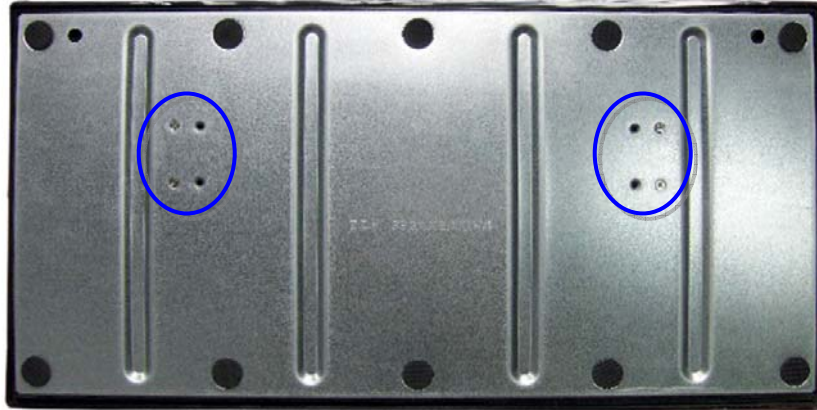

Model LT3200/LT3700 shown

- 3 Separate the two pieces of the pedestal.

## Removing the Back Cover

1 Remove the thirteen screws as shown.

**Note:** Screws 9, 10, 11, 12, and 13 are sheet metal screws. During reassembly, make sure you return these sheet metal screws to their proper location.

**Note:** The 47-inch model has two extra screws (total of 15), one on each side toward the bottom of the unit.

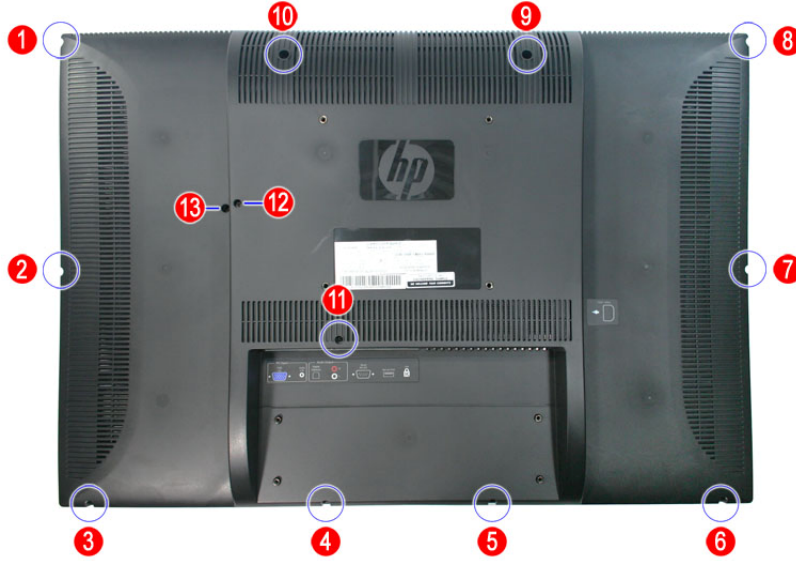

2 On all sides of the unit, press the side of the back cover inward to release it from the inner latches.

**Note:** All models except for the 32-inch have small bumps on the edge of the bezel that indicate the locations where the cover is connected to the bezel. Apply pressure at these locations to loosen the cover.

**Note:** Removing the cover can be difficult and may take some time.



3 Carefully lift the back cover straight up off the unit.



### Removing the Function Keyboard

Lift the function keyboard from the slot and detach the cable from the connector.



## Installing the PCA into the Keyboard

The keyboard PCA may not come installed into the keyboard. If not installed, use the following procedure to install:

- 1 Make sure the connector on the PCA is facing outward so it fits into the slot in the keyboard, and make sure the buttons on the PCA are facing down and aligned with the buttons on the keyboard.
- 2 One side of the keyboard has two tabs. Snap the PCA into the slot below the two tabs.
- 3 While properly aligning the PCA so it is straight in the keyboard, press the PCA down into the slot below the tabs on the other sides of the keyboard until it snaps into place.

## Removing the Infrared Board

- 1 Remove the one screw securing the infrared board.



- 2 Lift the infrared board and detach the cable from the connector.

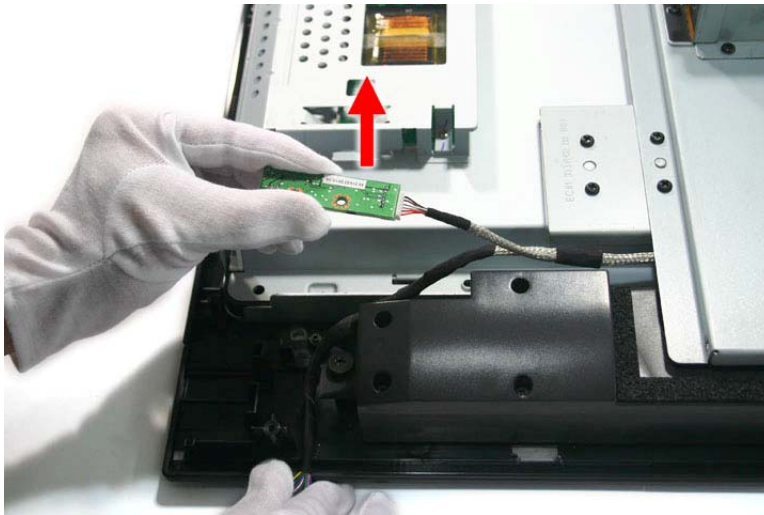



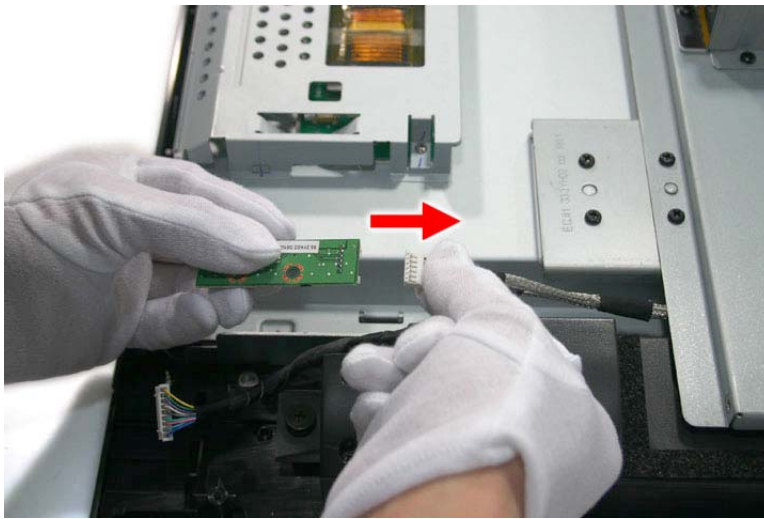

**Note:** On 32-inch models, to replace the IR board, plug the cable into the connector on the IR board before you replace the screws.

### Removing the Wall Mount Brackets

Remove the four screws and lift the wall mount brackets away from the board cover.

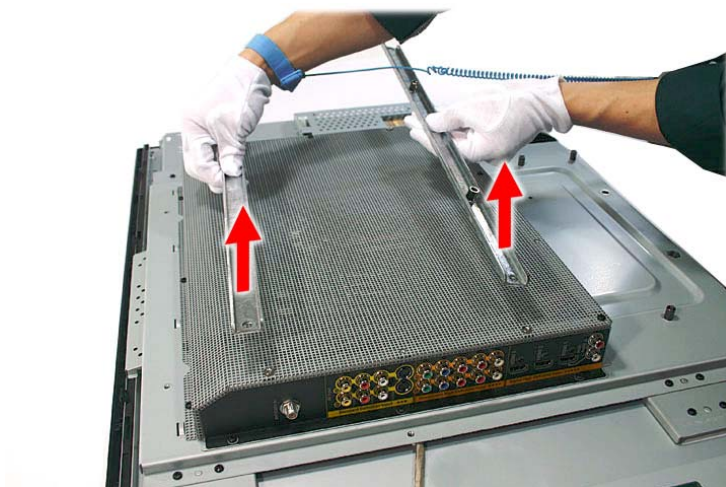
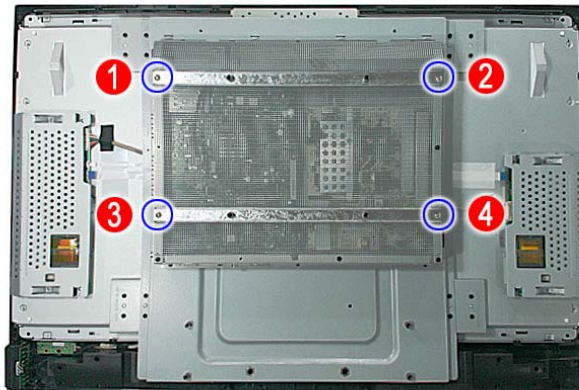

## Removing the Board Cover

Remove the seven screws from the board cover and remove the board cover.

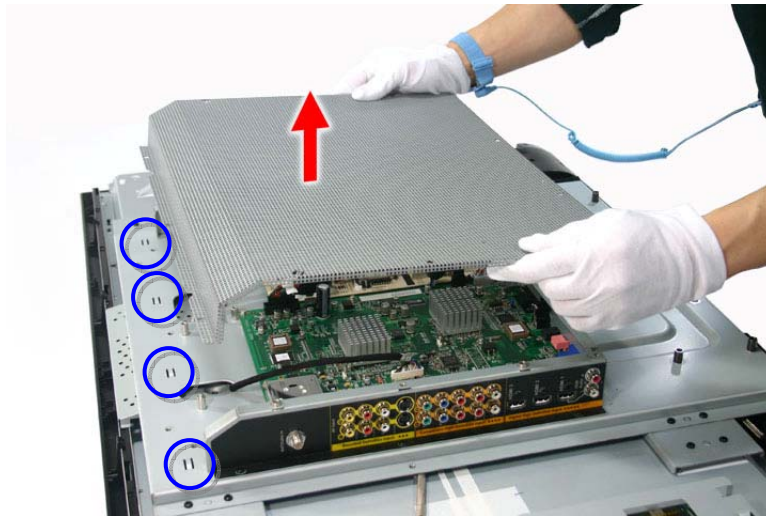
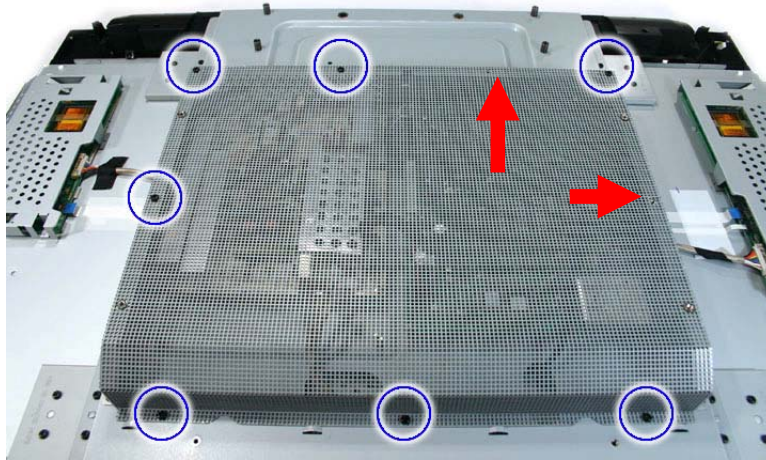

**Note:** When replacing the board cover, do NOT replace the screws above the s-video connectors and the red and white RCA jacks (audio output) as indicated by the arrows in the first of the two pictures above. You will replace these screws when you replace the back cover.

**Note:** When replacing the board cover, place the edge of the cover under the slots in the main bracket, as indicated by the blue circles in the second of the two pictures above.

## Removing the Main Board

Removal procedures are similar for all models.

It is not necessary to remove the power supply to remove the main board.

Only the main board and cable are spared; therefore, after removing the assembly from the unit, you must remove the two brackets from the board, and replace them on the new board.

- 1 Detach all the cables connected to the main board.  
You must remove one screw to remove the LVDS cable.



Power jumper (above)



Speaker IR cable (above)



LVDS cable, requires screw removal (above)

2 Remove the six screws from the I/O bracket.

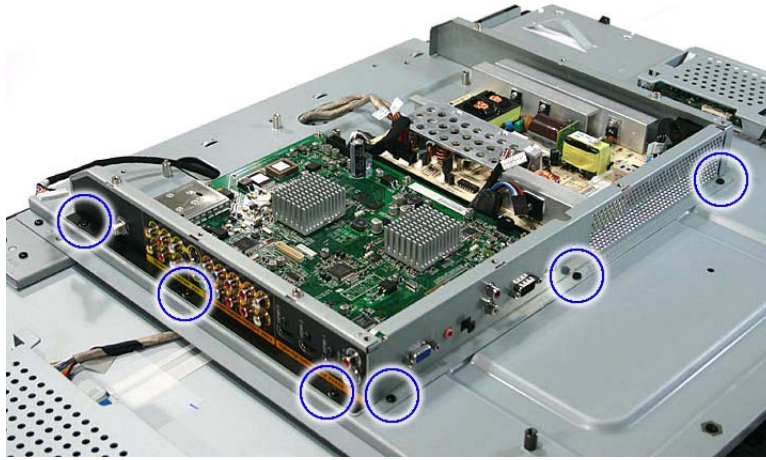

3 Remove the five screws securing the main board to the main bracket.

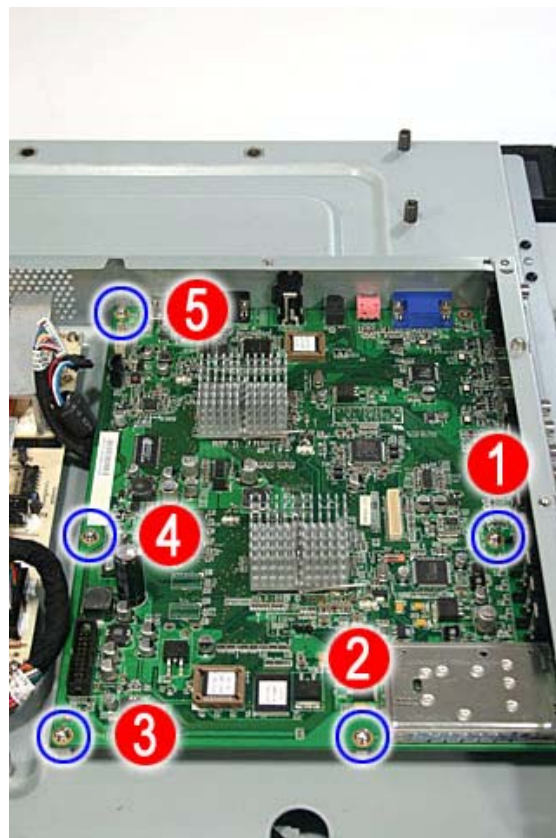

4 Remove the main board together with the I/O bracket.

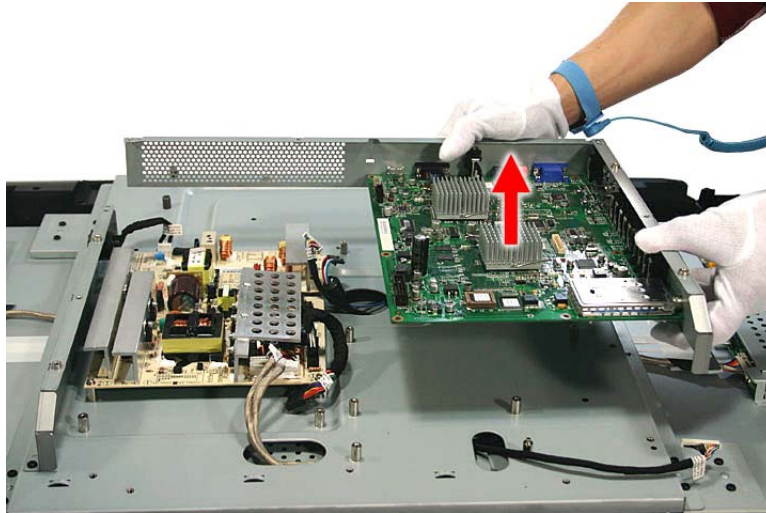

5 To remove the brackets from the main board:

- a. Remove the collar nut from the antenna/cable in connector.
- b. On the black-faced bracket that has the row of TV connectors, remove the three black machine screws located over the HDMI ports.
- c. Remove the five remaining black, self-tapping screws, and then remove the bracket from the main board.
- d. On the bracket with the VGA and RS-232 ports, remove the one black, self-tapping screw next to the RCA jack and four hex screws (two for each connector), and then remove the bracket from the main board.



When attaching the new main board to the brackets:

- Place the brackets and board on a flat surface.
- First install the bracket with the VGA and RS-232 ports. This bracket fits on the inside of the black connector bracket.
- When replacing the main board/bracket assembly, install the system board bracket below the rails in the TV.

## Removing the Power Supply

LT3200 and LT3700 models use the same power supply. LT4200 and LT4700 models use the same power supply, but differ from the LT3x00 models.

You do not have to remove the main board to remove the power supply.

Use the following image to note of the wiring when replacing the cables to their respective connectors. The image is representative of all four models except for the 32-inch model, which has only one inverter.

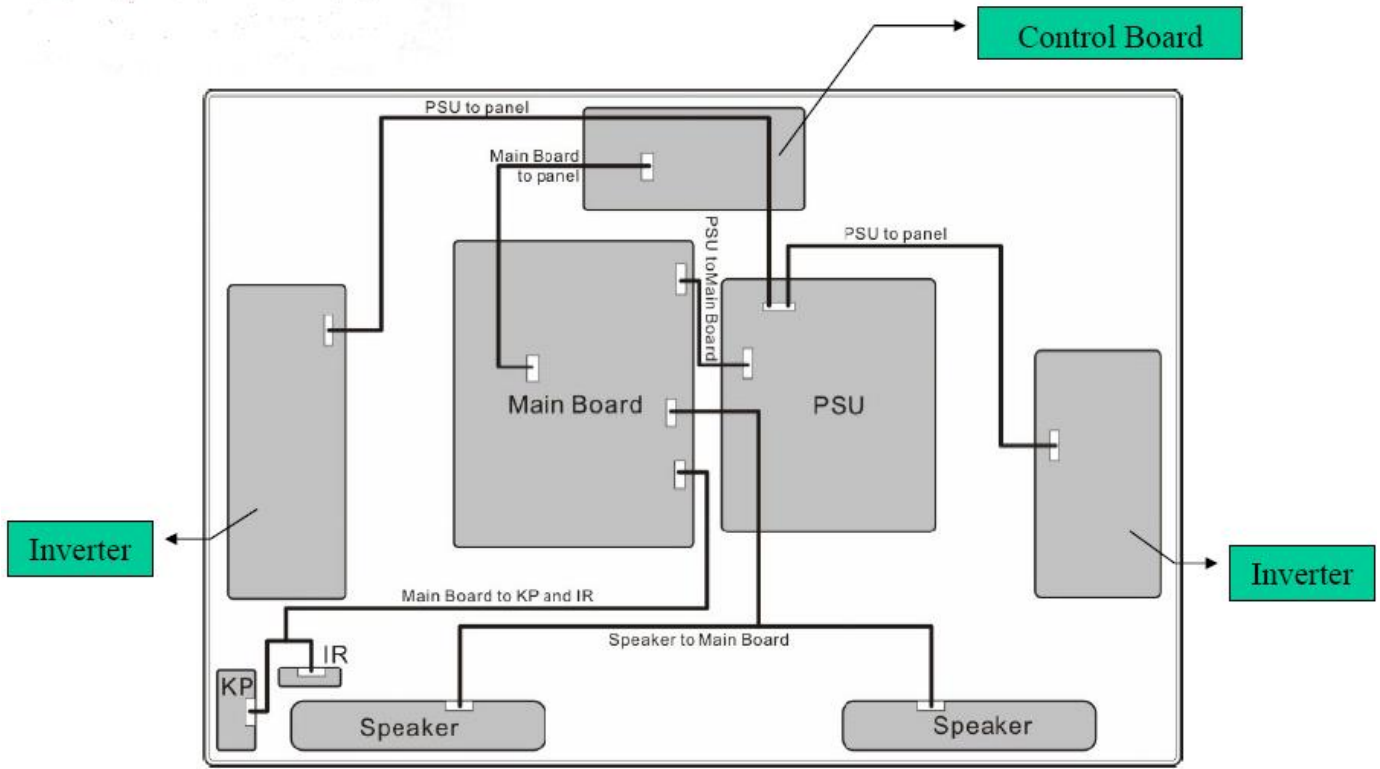

1 Detach all the cables connected to the power supply

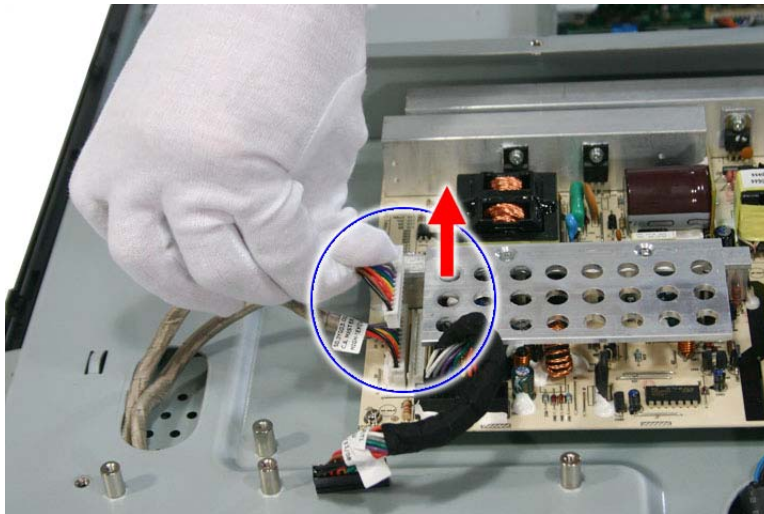

Inverter cables (above)

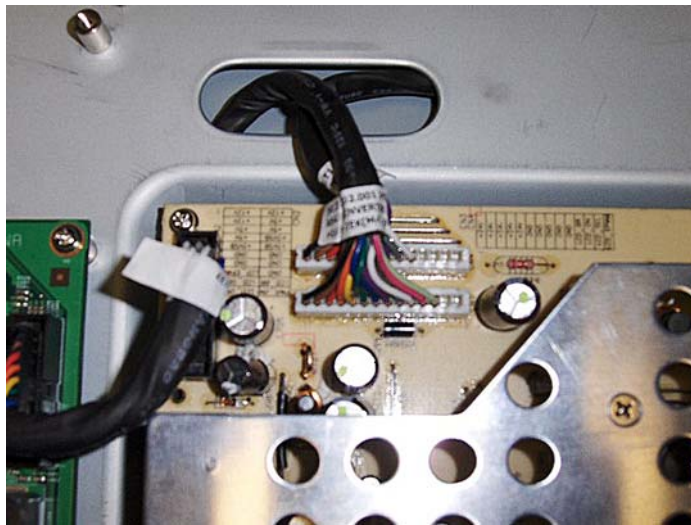

Inverter cables (above)

The Master inverter cable connector is closer to the outside of the board.

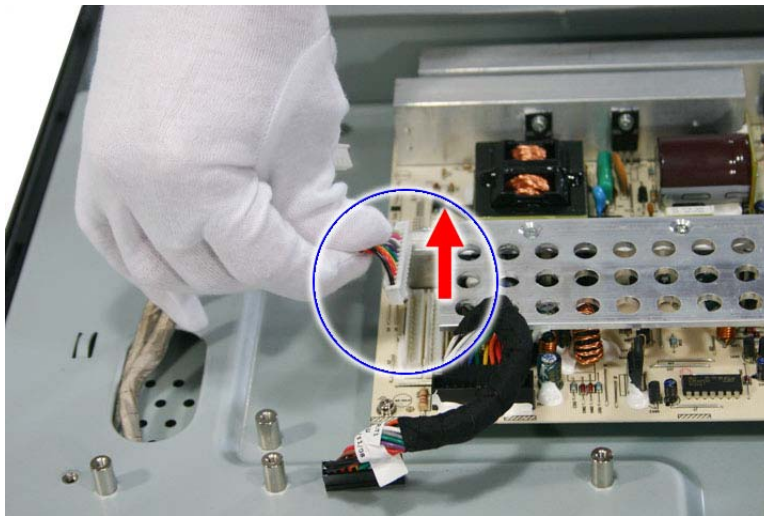

Inverter cable (above)

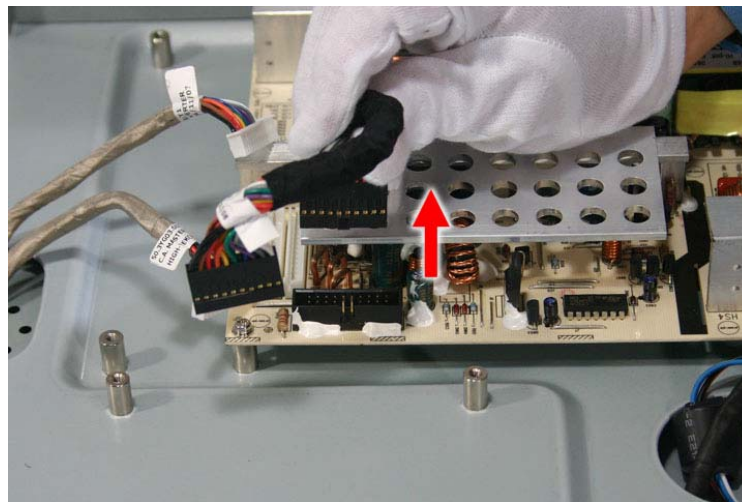

Power supply to main board connector cable (above)



2 Remove the four screws securing the power supply to the main bracket.

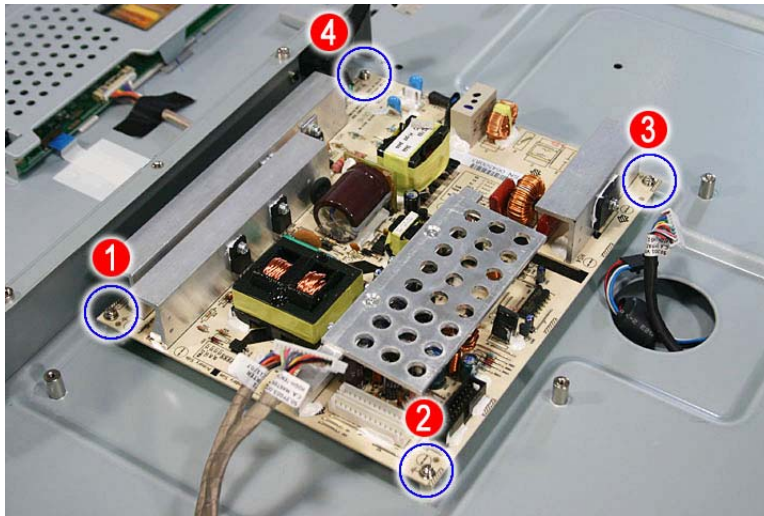

3 Remove the power supply.

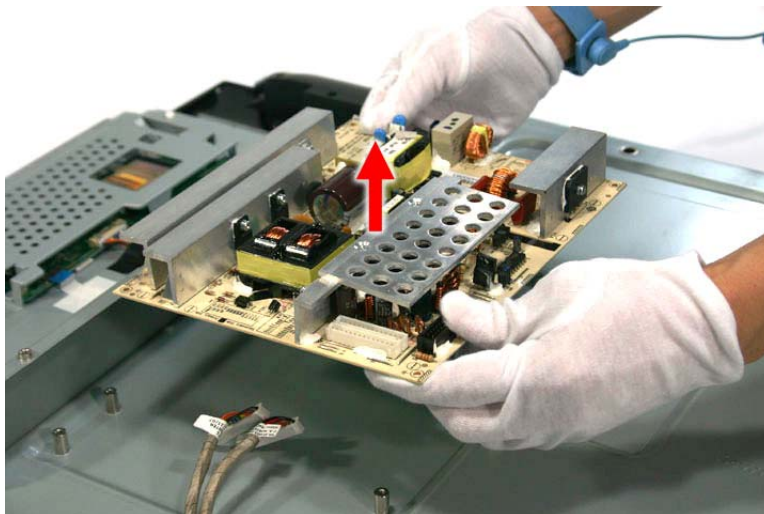

## Removing the Main Bracket

You can remove the main bracket with the power supply and main board in place. This is useful when replacing speakers, the control board, the IR board, or the inverters.

- 1 Remove the ten screws from the main bracket.

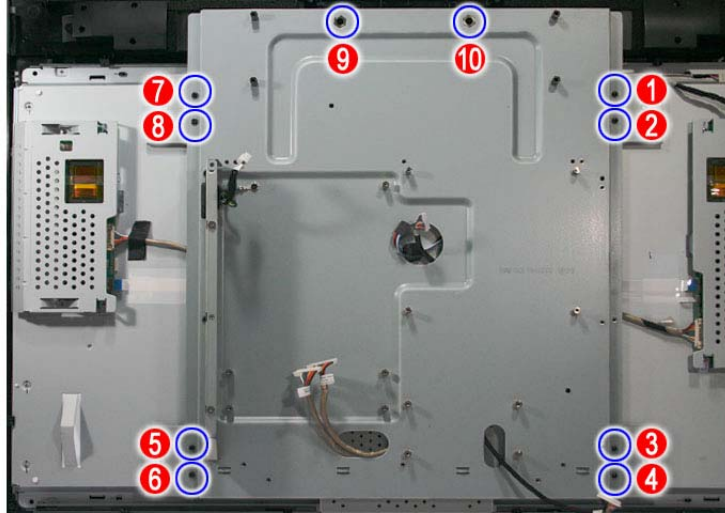

- 2 Remove the main bracket from the LCD panel

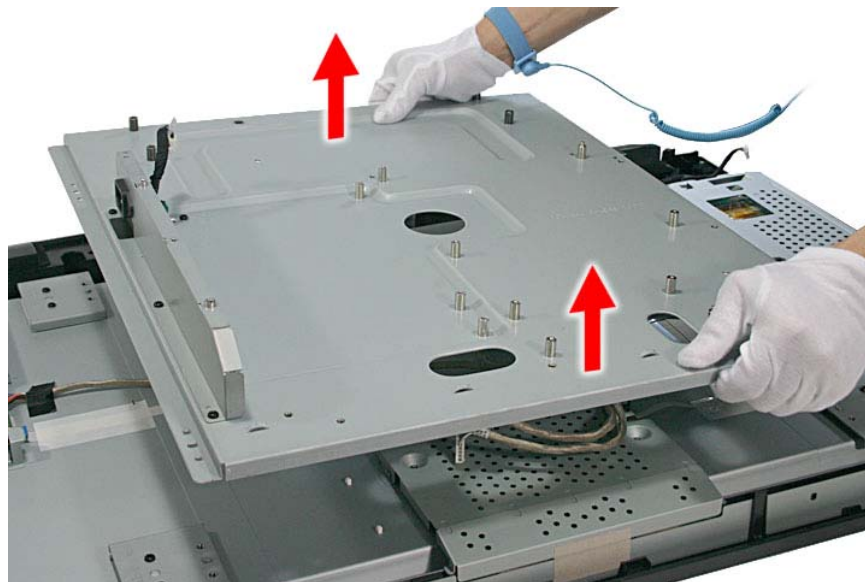

**Note:** When replacing the main bracket on the 32-inch model, place the bottom of the bracket about 1/2-inch above the bottom of the speakers.

## Removing the Inverters

When replacing inverters, first replace the board(s), and then test the unit. If the TV still does not work, replace the inverter cable(s). Inverters are spared as a pair (except for the 32-inch model), so you should replace both. The inverters are NOT the same – there is a Master and a Slave. If you are facing the back of the unit, the Master inverter is on the left side above the speaker marked **L** (for left).

When plugging inverter cables into the power supply, the Master inverter cable outboard and the Slave cable is inboard. You have to remove the main bracket, but do not have to remove the power supply or main board to remove the inverters.

**Note:** Inverter board cabling differs based on model.

### LT 3200 Inverter Removal

**Note:** Model LT3200 has only one inverter.

- 1 Remove the six screws that secure the inverter cover to the unit, and then lift the cover up and out of the unit.

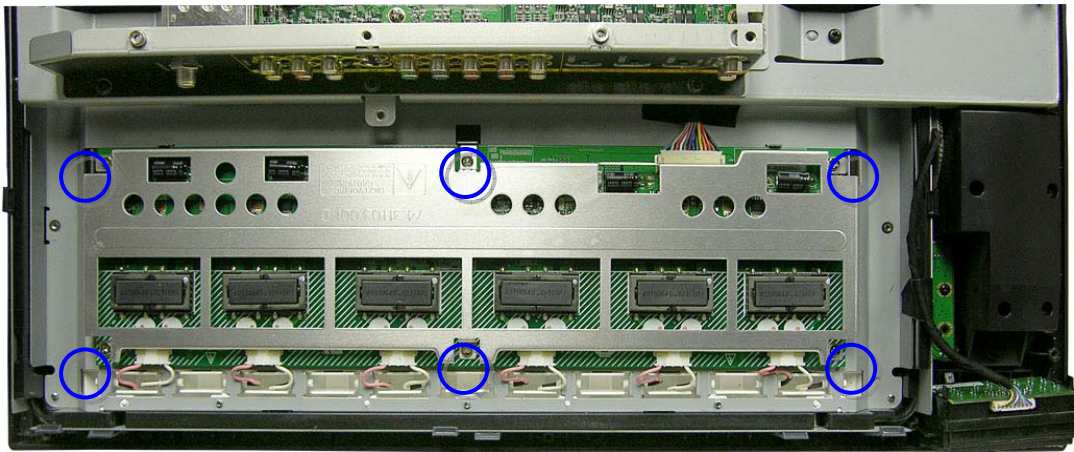

- 2 Disconnect the six cables from the connectors on the rear of the inverter board and the remaining cable from the connector on the front of the board.

**Note:** The connectors have a catch you must push down before removing the cable.

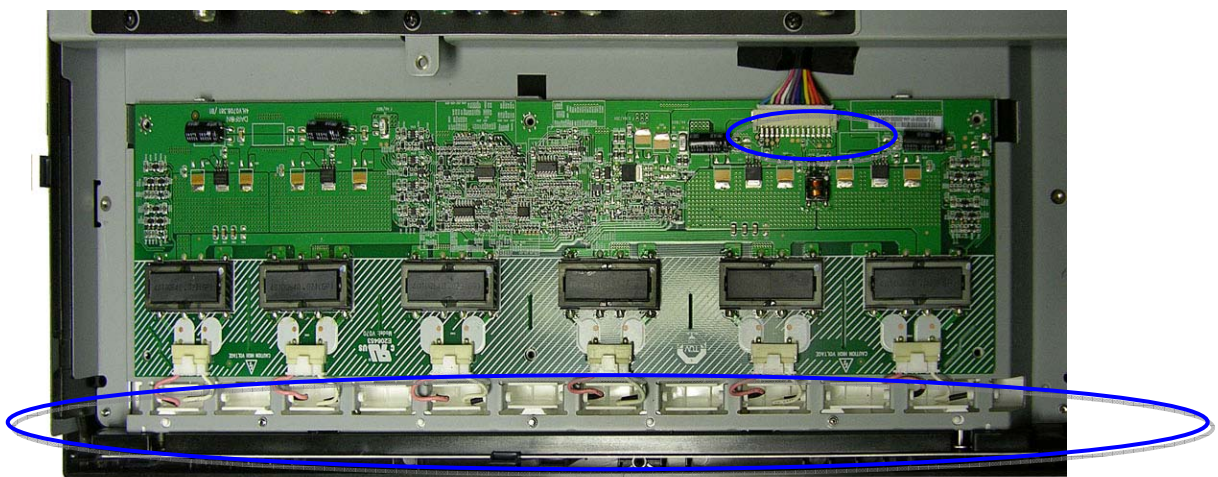

- 3 Lift the inverter board up and off the unit.

## LT 3700 Inverter Removal

**Note:** The 37-inch model has different sized inverters, as well as an additional flat ribbon cable from the inverter to the control board.

- 1 Remove the six screws that secure the inverter cover to the unit, and then lift the cover up and out of the unit.

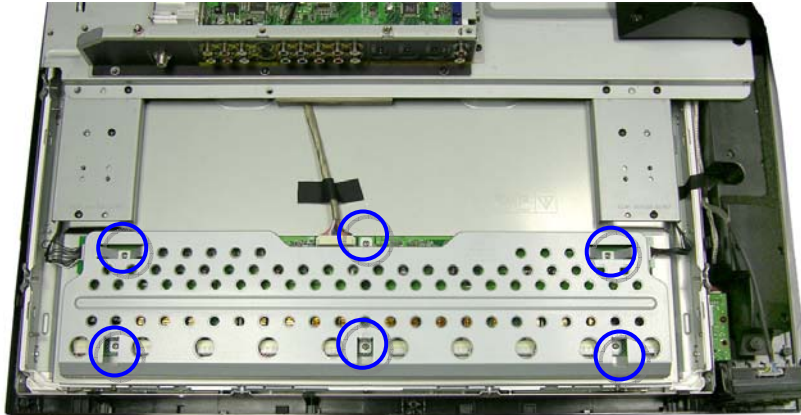

- 2 Disconnect the cables from the connectors on the inverter board.

**Note:** 4 total cables on Master. 3 total cables on Slave. To disconnect fragile flat ribbon cables, disconnect all other cables, grasp the end of the flat ribbon cable, and then pull the board away from the cable.

**Note:** To disconnect the cables, grasp both sides of the cable near the connector, and then pull the cable straight out of the connector.

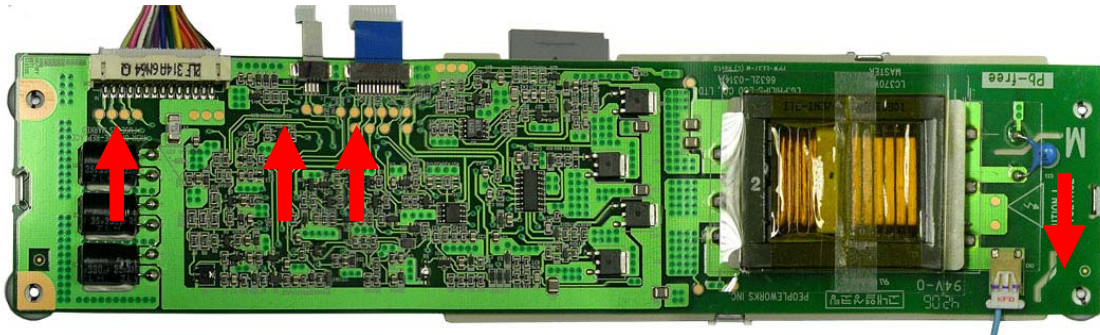

Master inverter (above)

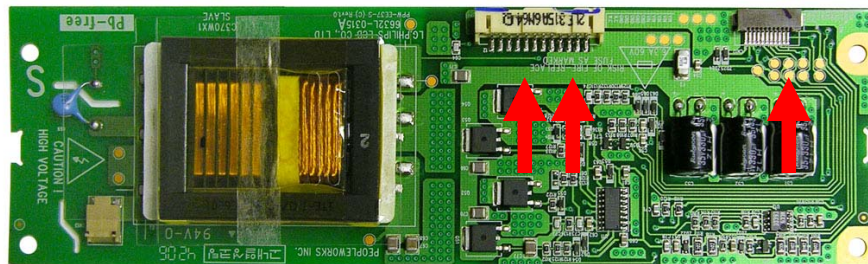

Slave inverter

- 3 Lift the inverter board up and off the unit.

## LT 4200 Inverter Removal

1 Remove the six screws that secure the inverter cover to the unit, and then lift the cover up and off the unit.

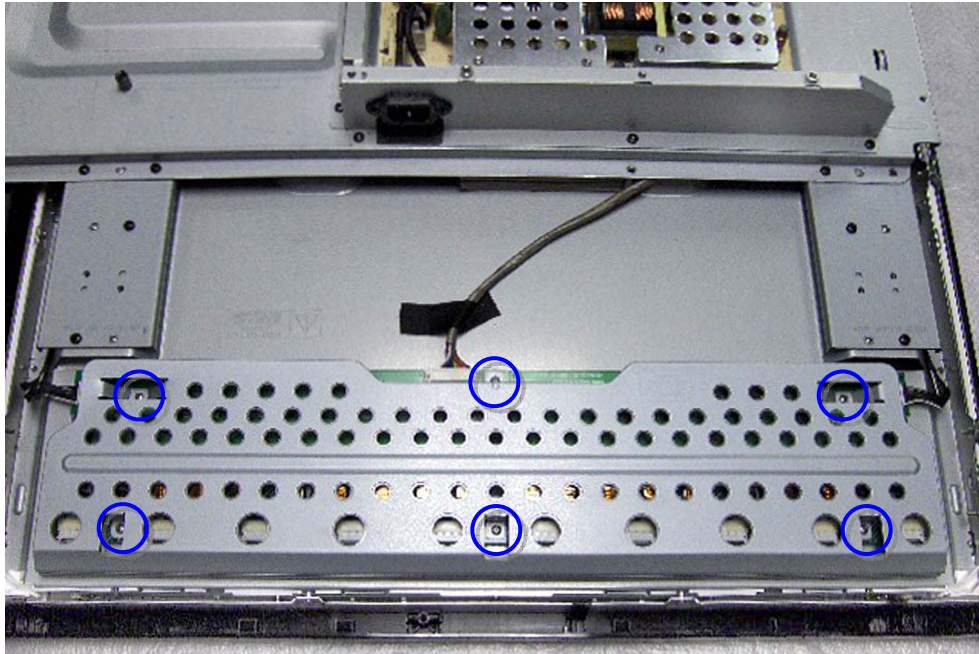

2 Disconnect the 10 cables from the connectors on the rear of the inverter board, and the remaining cables from the connectors on each side of the board.

**Note:** Grasp both sides of the cable connector and pull it straight from the connector on the board.

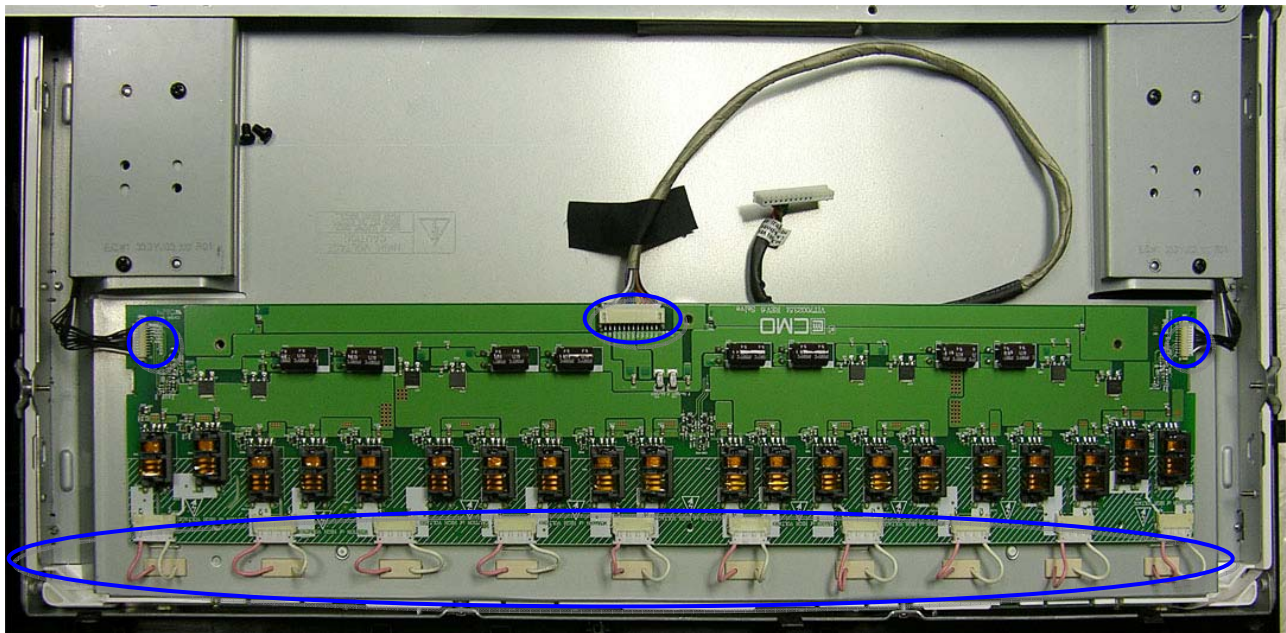

3 Lift the inverter board up and off the unit.

## LT 4700 Inverter Removal

1 Remove the six screws that secure the inverter cover to the unit, and then lift the cover up and off the unit.

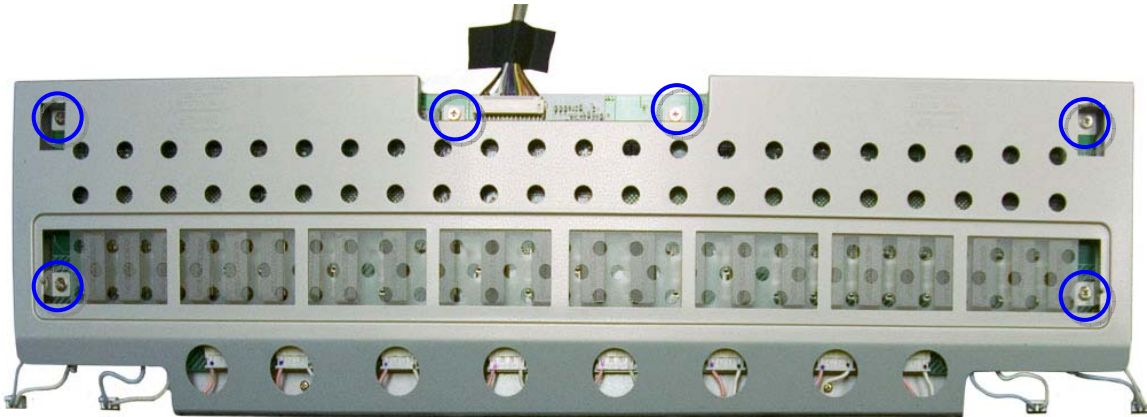

2 Disconnect the 15 cables from the connectors on the rear of the inverter board, and the remaining three cables from the connectors on each side of the board.

**Cable notes:** 15 total cables on each board – 12 on back of board, 1 on each side. Pull the blue tabs straight out to disconnect the cables.

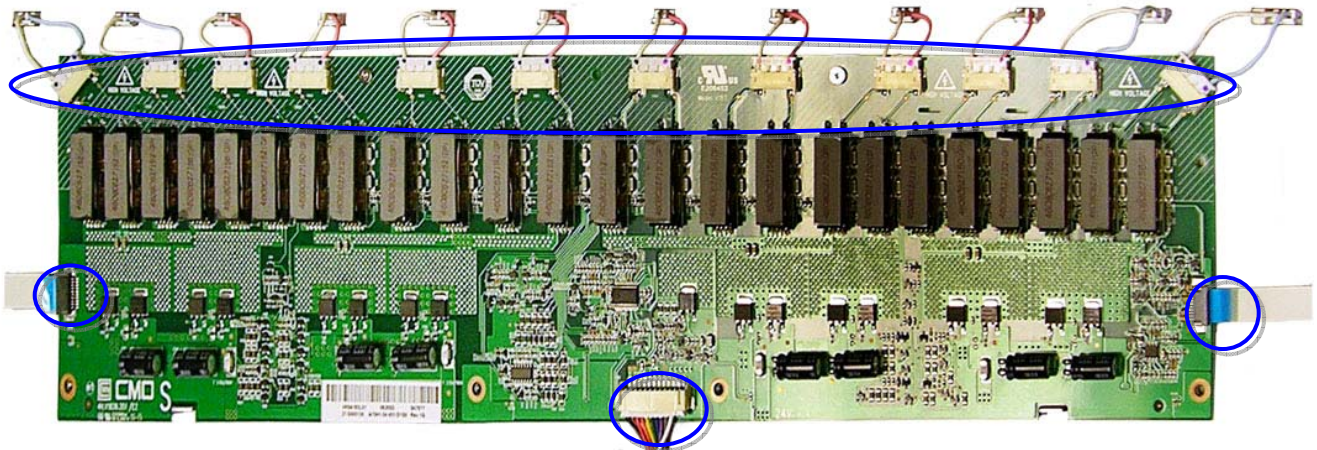

3 Lift the inverter board up and off the unit.

## Removing the Speakers

You have to remove the main bracket, but do not have to remove the power supply\* or main board to remove the speakers.

\* For the 32-inch model, you must remove the power supply to remove the speaker.

To remove the speakers without removing the power supply or main board, remove the screws that secure the main bracket, lift the bracket up to gain access to the speaker cable, and then disconnect and remove the cable.

**Note:** The left and right speakers are not the same.

1 Release the speaker cables from the latches.

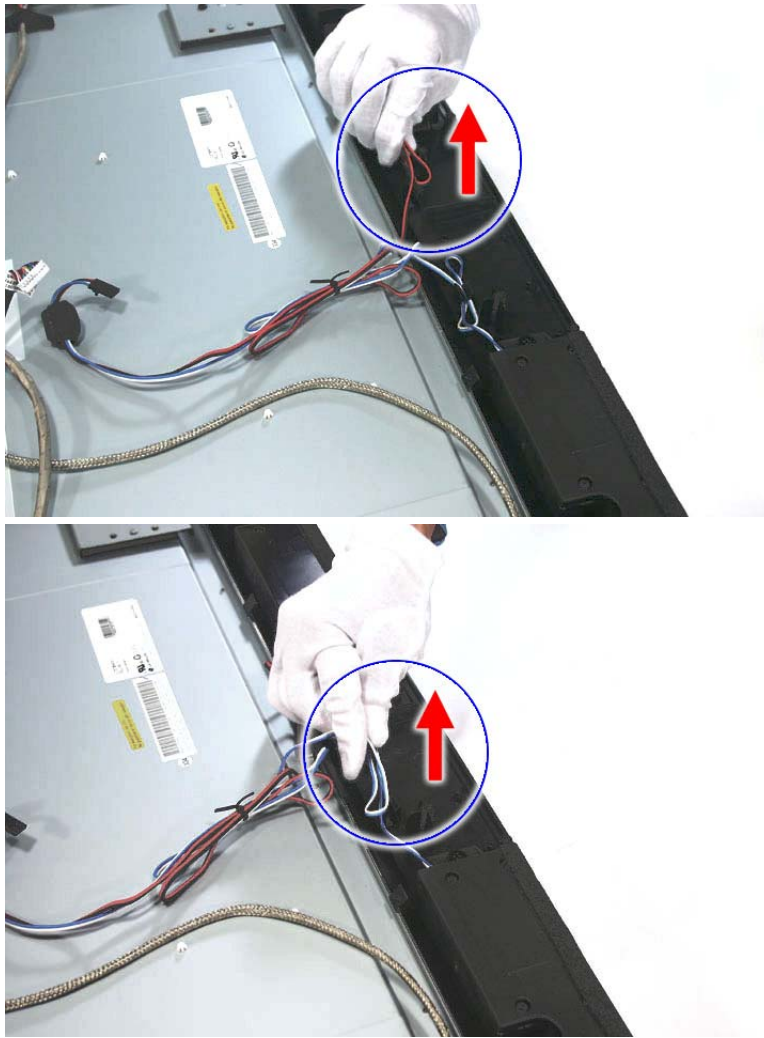

2 Remove the two screws from each speaker.

**Note:** For the 47-inch model, remove the wires from the clip holders.

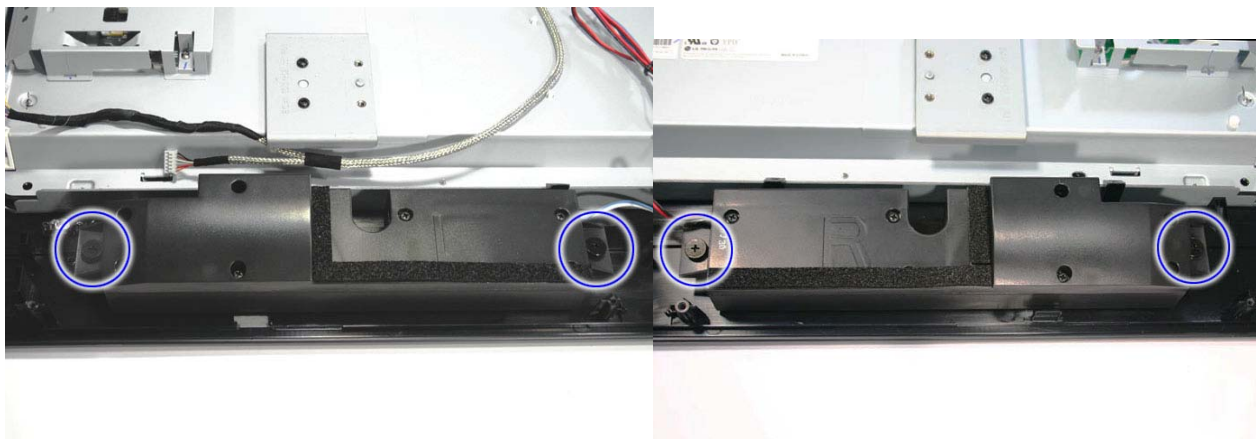

3 Remove the speakers from the LCD module.

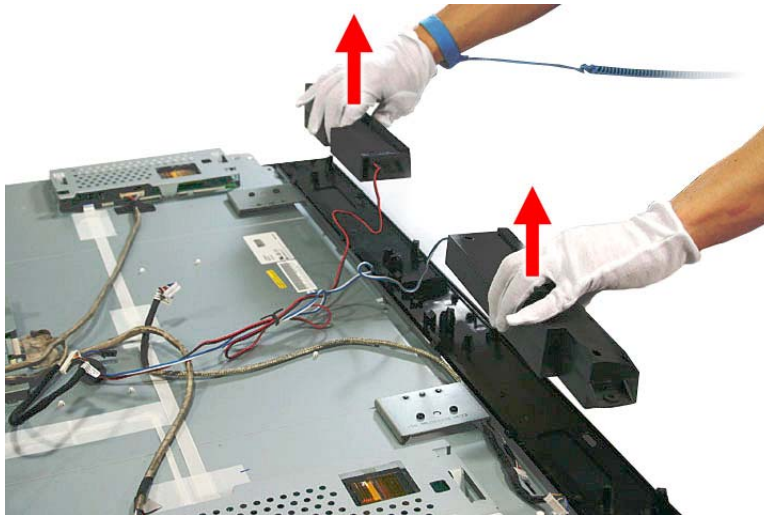

## Removing the Control Board

You have to remove the main bracket, but do not have to remove the main board or power supply to remove the control board.

### LT3200 Control Board Removal

- 1 Disconnect the front LVDS cable by pressing the spring-loaded latches on each side of the cable connector, and then pulling the cable from the connector.
- 2 Remove the five screws that secure the control board cover to the unit.



3 Lift the cover from the unit.

**Note:** You cannot remove the ZIF cables from the side of the unit on the 32-inch and 37-inch models.

4 Lift the board from the unit.



**Note:** When replacing the cover, insert the edge of the cover into the slots on the main bracket.

### LT 3700 Control Board Removal

1 Disconnect the front LVDS cable by pulling the cable from the connector.

**Note:** The latches are not spring-loaded on the 37-inch model.

2 Pull the small white ribbon cable straight out to remove it from the connector.

3 Remove the three screws that secure the control board cover to the unit.



4 Lift the cover from the unit.

5 Disconnect the two flat ribbon cables from the ZIF connectors at the top of the control board by flipping up the dark part of the connector and sliding the cable out of the socket.

**Note:** You cannot remove the ZIF cables from the side of the unit on the 32-inch and 37-inch models.



6 Lift the board from the unit.

**Note:** When replacing the cover, place the lip on the back of the cover into the slot on the main bracket, and then rotate the cover down into place.

**Note:** On the 37-inch model, when replacing the cover, put the cover over the board before reconnecting the screws.

### LT4200 Control Board Removal

- 1 Disconnect the front LVDS cable by pressing in on the spring-loaded latches on each side of the cable connector, and then pulling the cable from the connector.
- 2 Remove the four screws that secure the control board cover to the unit. Two of the screws are hidden under the pads.

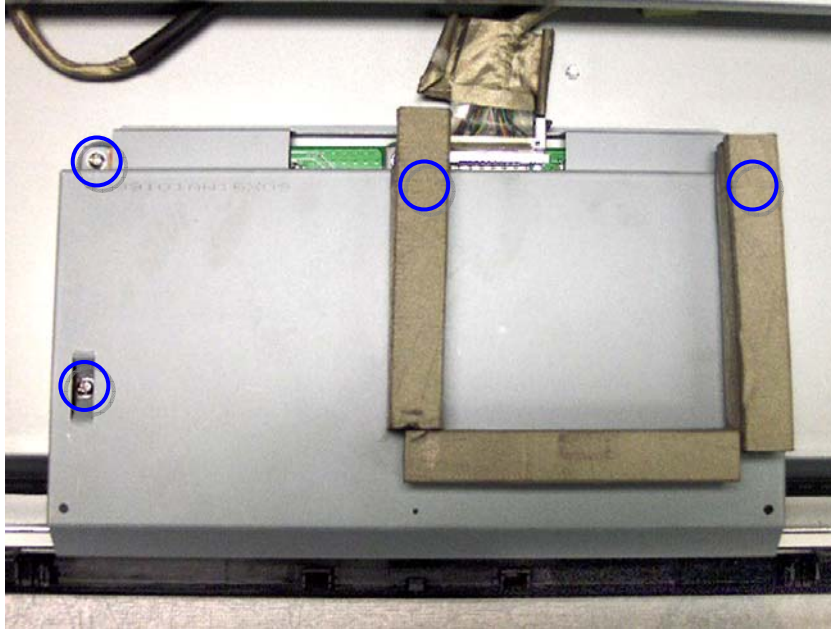

42-inch model shown

- 3 Lift the cover from the unit.
- 4 Disconnect the four flat ribbon cables from the ZIF connectors at the top of the control board by flipping up the dark part of the connector and sliding the cable out of the socket.

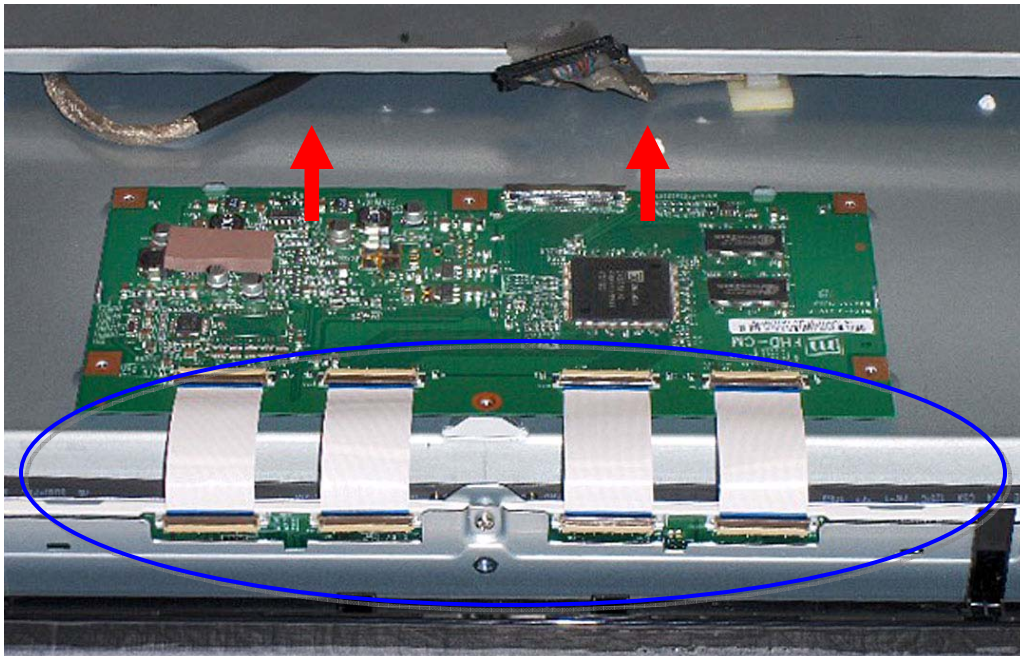

42-inch model shown

5 Remove the flat ribbon cables from the connectors on the main TV chassis.

6 Lift the board from the unit.

**Note:** When replacing the control board cover, place the lip on the back of the cover into the slot on the main bracket, and then rotate the cover down into place.

### LT4700 Control Board Removal

1 Disconnect the front LVDS cable by pressing in on the spring-loaded latches on each side of the cable connector, and then pulling the cable from the connector.

2 Remove the six screws that secure the control board cover to the unit.

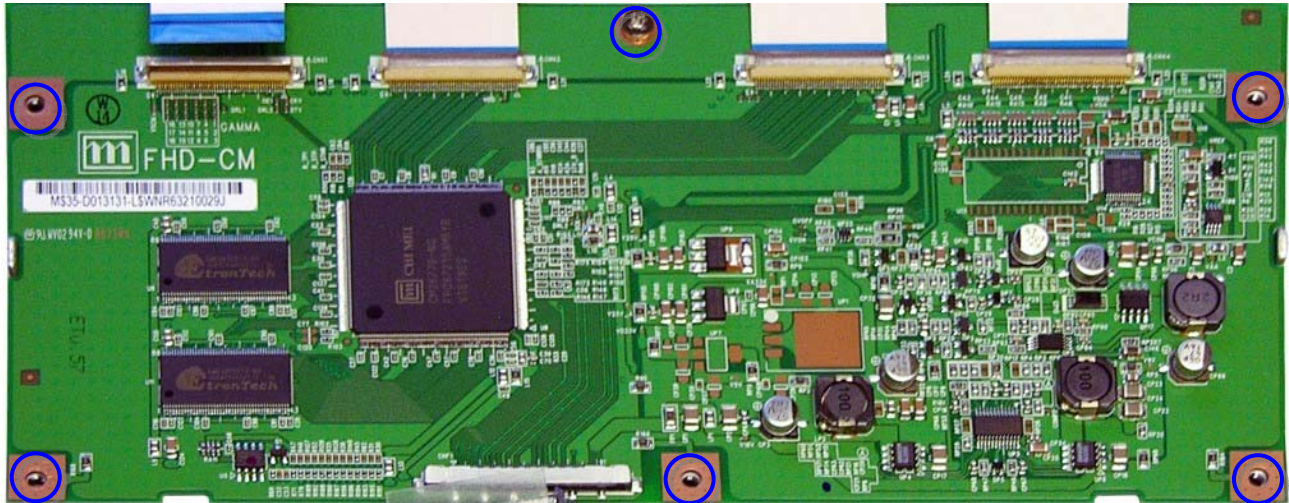

3 Lift the cover from the unit.

4 Disconnect the four flat ribbon cables from the ZIF connectors at the top of the control board by flipping up the dark part of the connector and sliding the cable out of the socket.

5 Remove the flat ribbon cables from the connectors on the main TV chassis.

6 Lift the board from the unit.

**Note:** When replacing the cover, place the lip on the back of the cover into the slot on the main bracket, and then rotate the cover down into place.

**Note:** To replace the board on the 47-inch model, replace one screw into the middle hole toward the top of the board, reconnect the flat ribbon cables, and then replace the remaining screws.

## Removing the Front Bezel

To remove the front bezel, remove the back cover, then put the unit back on the stand, as follows:

- 1 Remove the stand.
- 2 Remove the back cover.
- 3 Remove the IR/keypad assembly.
- 4 Remove the speakers.
- 5 Replace the stand and set the TV upright on the stand.



37-inch model with back cover removed

- 6 Unlatch the plastic tabs that secure the bezel to the unit.
- 7 Remove the bezel from the unit.

To replace the bezel, place the bezel on a large flat surface, and then place the panel straight down into the bezel.

# Diagnostics

This section identifies potential service modes used for service along with their function and purpose. This section also identifies error detection LEDs and error codes.

## LED Indicators

Indicator	Blink Frequency	Failure Part	Location
Amber and aqua LED blinking	1 sec interval	MCU-Host link error	Main board
Amber LED blinking	1 sec interval	TAFE does not respond	Main board
Aqua LED blinking	1 sec interval	Tuner does not respond	Main board
Amber LED blinking	2 sec interval	Digital Demodulator does not respond	Main board
Aqua LED blinking	2 sec interval	Audio process does not respond	Main board
Amber and aqua LED blinking	2 sec interval	More than two I2C devices error	Main board

### What is the special condition to watch out for with the following message: Red LED blinking 2 sec interval – Digital Demodulator does not respond?

Error code 003 (digital demodulator does not respond) requires source to be selected as “antenna” before the test is valid. If source is not antenna, it will always give you error code 003 because digital demodulator is not turned on until “antenna” source is selected.

## Software version information

**Note:** You must be in Fullmenu to perform this function with a link back to the place showing how to access Fullmenu.

To access the software version information OSD:

- 1 Turn the TV on.
- 2 Press the **Menu** button.
- 3 From OSD, select **Setup** -> **Time**.
- 4 Press the following keys: **SAP/MTS** -> **7** -> **7** -> **7**.  
The software version information displays on the lower right corner of the TV.



HOST: v1.0.0  
MCU: v1.0.0

## How to run diagnostics

- 1 Power off the TV and pull disconnect the power cord.
- 2 Plug in the power cord while holding the power button on the TV (not on the remote). Hold the power button until a testing message appears. This may take up to 30 seconds.
- 3 Diagnostic test begins.

# How to get back to normal TV operation after running diagnostics

- 1 After the diagnostic test finishes, power off the TV and disconnect the power cord.
- 2 Wait for about 30 seconds; and then plug the power cord back in. The TV returns to normal mode.

## Installation menu

The TVs incorporate custom menus that are accessible only through a special combination of the keys on the remote control. These menus are not available to all users and are to be used only by trained service professionals or custom installers. These instructions are provided as is and HP is not responsible for any damage to the TV due to improper use of these menus.

The installation menu allows you to change default setting values of current input audio and video modes. For example, to change the picture settings for a component input, switch the TV source to component before entering this mode.

To access the Installation menu:

- 1 Turn the TV on.
- 2 On the remote, press the **Menu** button.
- 3 From the OSD, select **Setup -> Time**.
- 4 If the TV is NOT in Hotel mode, press the following key sequences: **SAP/MTS -> 1 -> 3 -> 5**.
- 5 If the TV is in Hotel mode, change input source to **AV2**, then press **SOURCE -> 1 -> 3 -> 5**.

---

**Note:** Color adjustments in this menu apply to ALL modes (Cool, Standard, or Warm). If you want to adjust the color temperature of a single mode, you will need to adjust the **White Balance** settings in the Factory Menu.

---

### Color Adj.

Color Adj.		STD Value
	R	Default (values: 0~100)
	G	Default (values: 0~100)
	B	Default (values: 0~100)

---

**Note:** Each input group has the same values. The same group of inputs have the same values.

---

### Picture Adj.

Picture Adj.			Value
	Vivid	Brightness	Default (values: 0~100)
	STD	Contrast	Default (values: 0~100)
	Movie	Saturation	Default (values: 0~100)
		Hue	Default (values: 0~100)
		Sharpness	Default (values: 0~100)

By default, the TV expects the black levels of all 480i component inputs to be at 0 IRE. Since some DVD players output component 480i at 7.5 IRE, this menu allows an installer to change the default.

### Black Level format

Black Level	

	Light (0 IRE)
	Dark (7.5 IRE)

Active only for Component 480i input. This menu is enabled Component input only, The selection is only effective for 480i format.

### Audio re-map

The audio remap option allows a custom installer to use the Composite/S-Video audio ports as extra input audio ports for DVI sources. For example, if the installer wants to connect a set-top box to HDMI-2 using a DVI-to-HDMI cable, using this menu, the installer can assign the AV2 audio port as the corresponding audio port for HDMI-2. This allows installers to install up to three DVI sources with separate audio.

---

**Note:** This input needs to be remapped back to HDMI audio if the source can provide both video and audio over HDMI.

---

In certain applications, such as hotels, the TV provider may not want to allow users (guests) to change the TV settings. In Hotel Mode, the **Menu** and **Fav** (Channel Favorites) keys on the remote are disabled.

#### Remap AV audio port to HDMI audio

<b>Audio remap</b>	
	AV
	HDMI

AV: Audio port to AV input

HDMI: Audio port to HDMI

### Mode

Allows you to select Hotel or Normal mode; default is Normal mode.

<b>Mode</b>	
	Normal
	Hotel

### ClearUserROM

Clears all user setting values to default including password, channel list, and favorite channel list.

<b>ClearUserROM</b>
---------------------

### Exit

Select to exit from the Installation OSD menu.

<b>Exit</b>
-------------

### Hotel mode

Hotel mode allows hotels to not allow their guests to change TV configurations. This mode blocks some remote buttons and TV functionality, including the MENU and FAV buttons

## How to enable and disable

TVs are delivered to hotels in normal mode.

To access the installation menu:

- 1 Run the Setup wizard (or channel scan and time setup) through the main menu.
- 2 Access the install menu and change to HOTEL mode from Normal TV mode.

To access the installation menu:

- 1 Turn the TV on.
- 2 On the remote, press the **Menu** button.
- 3 From the OSD, select **Setup -> Time**.
- 4 Press the following key sequences: **SAP/MTS -> 1 -> 3 -> 5**.

To return to normal mode from Hotel mode:

- 1 On the remote, press the **Menu** button.
- 2 From the OSD, select **Setup -> Time**.
- 3 Change input source to **AV2**, and then press **SOURCE -> 1 -> 3 -> 5**.



# Troubleshooting

## Remote Control

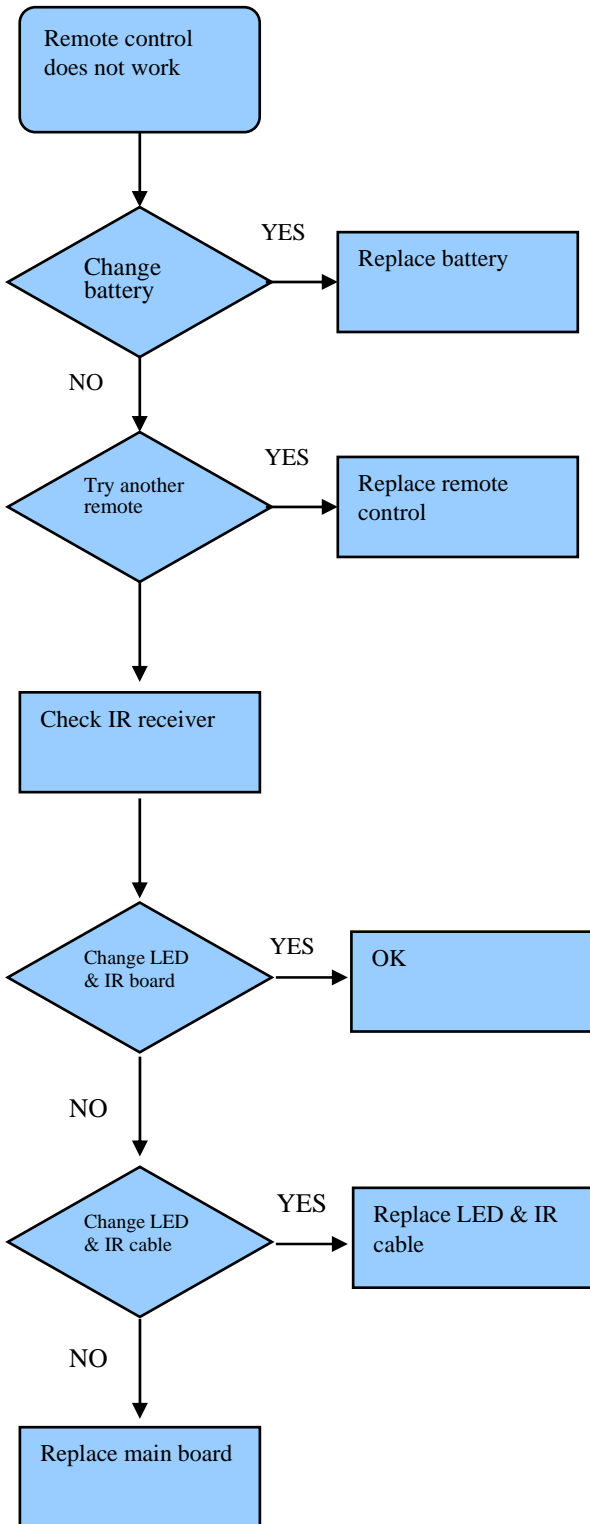

# Function Key

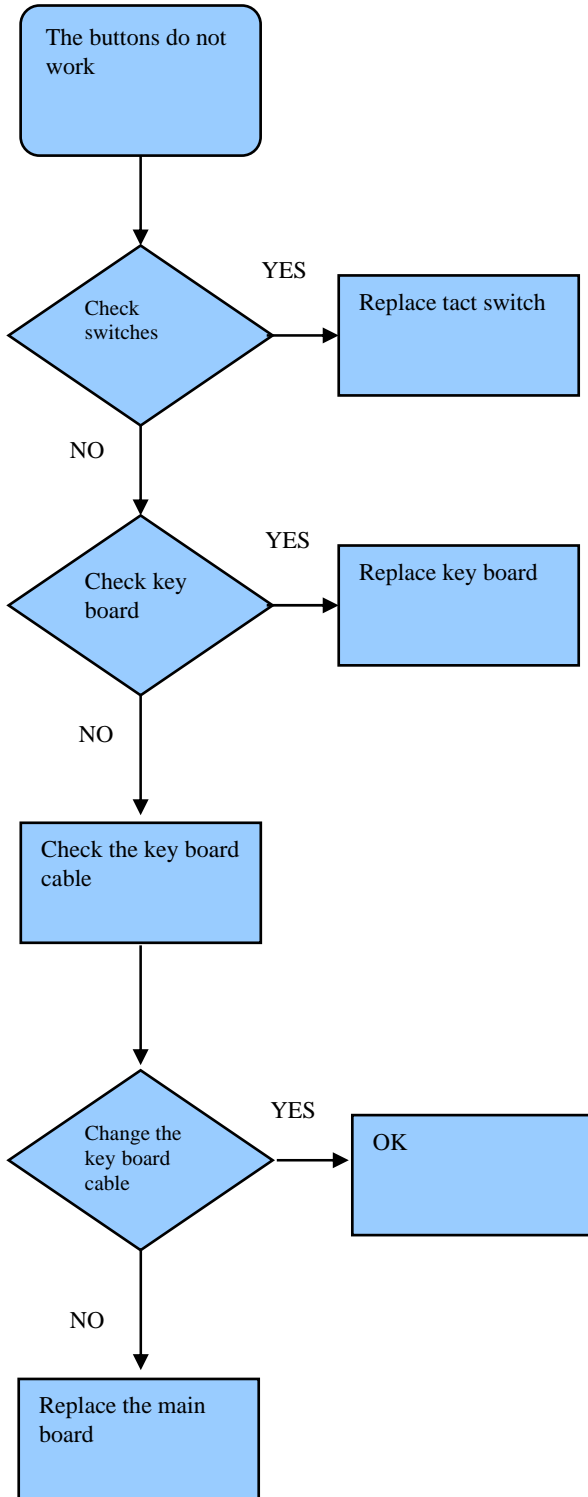

# Power: TV Does Not Turn On

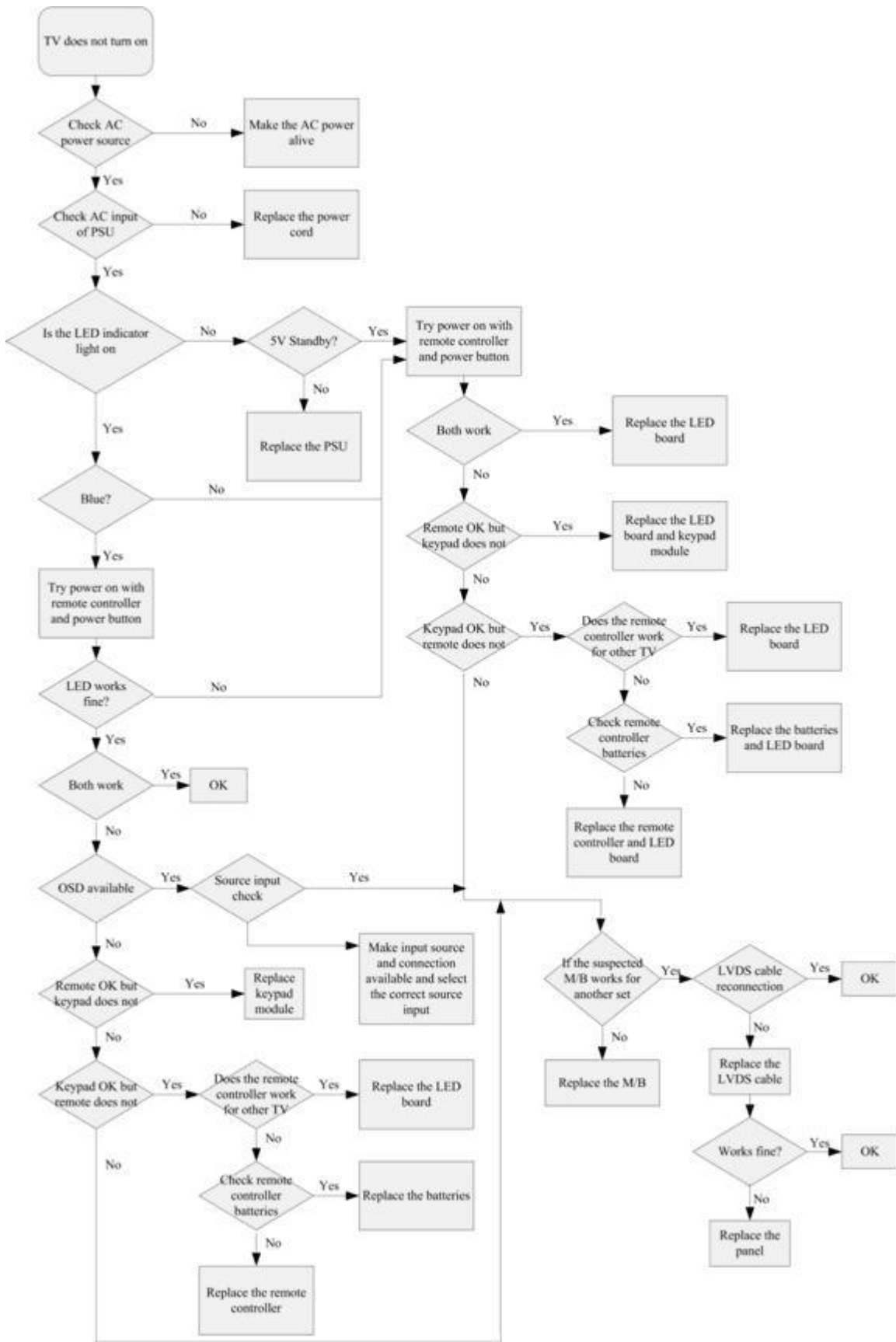

# Audio

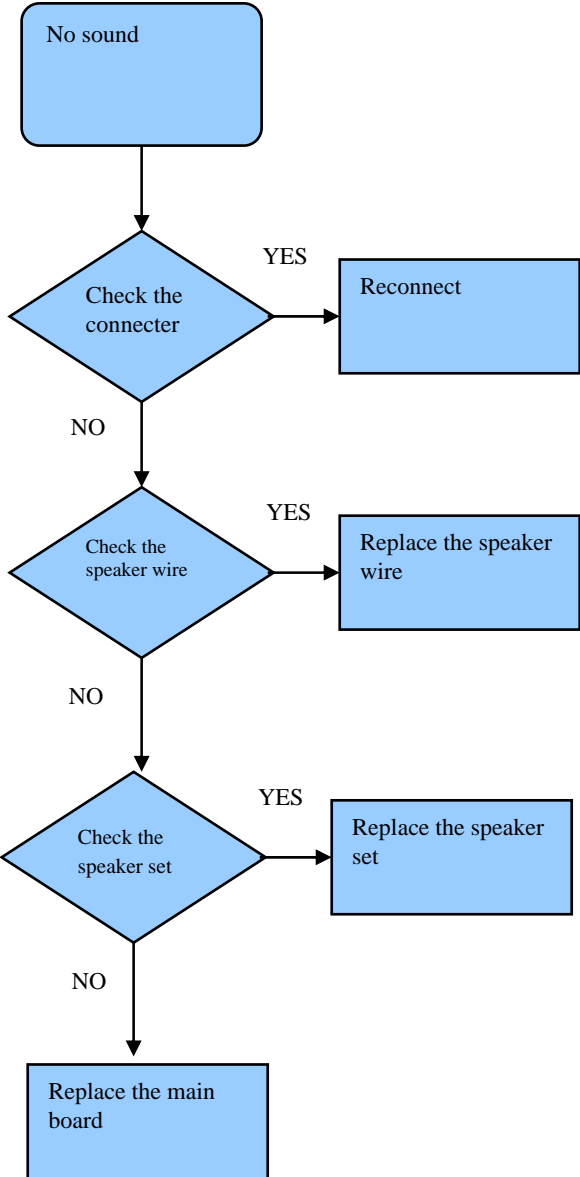

# VGA Input

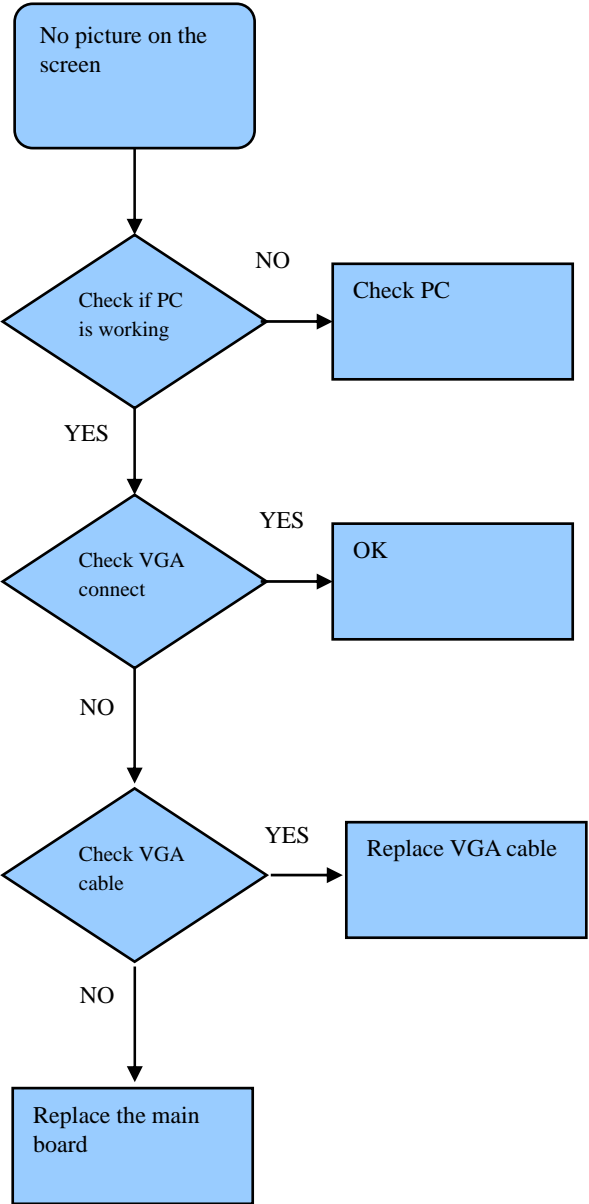

# HDMI Input

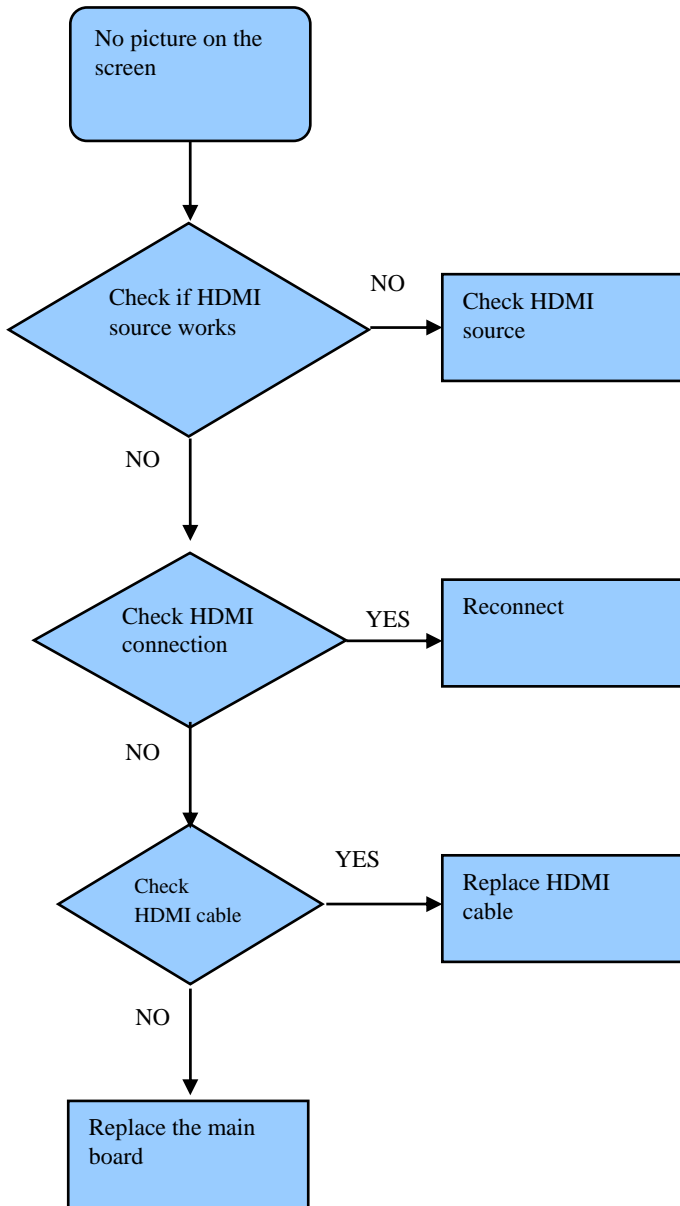

# DVI Input

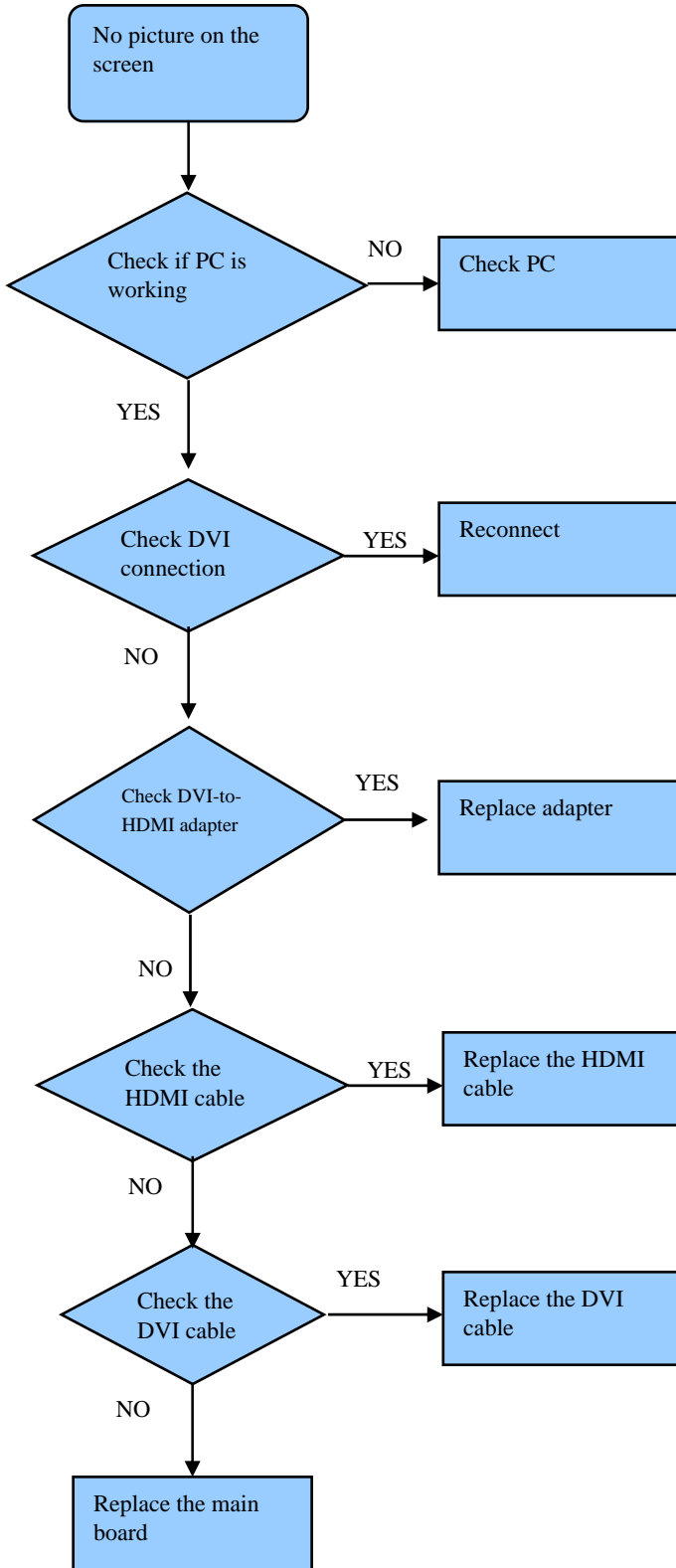

# YPbPr Input

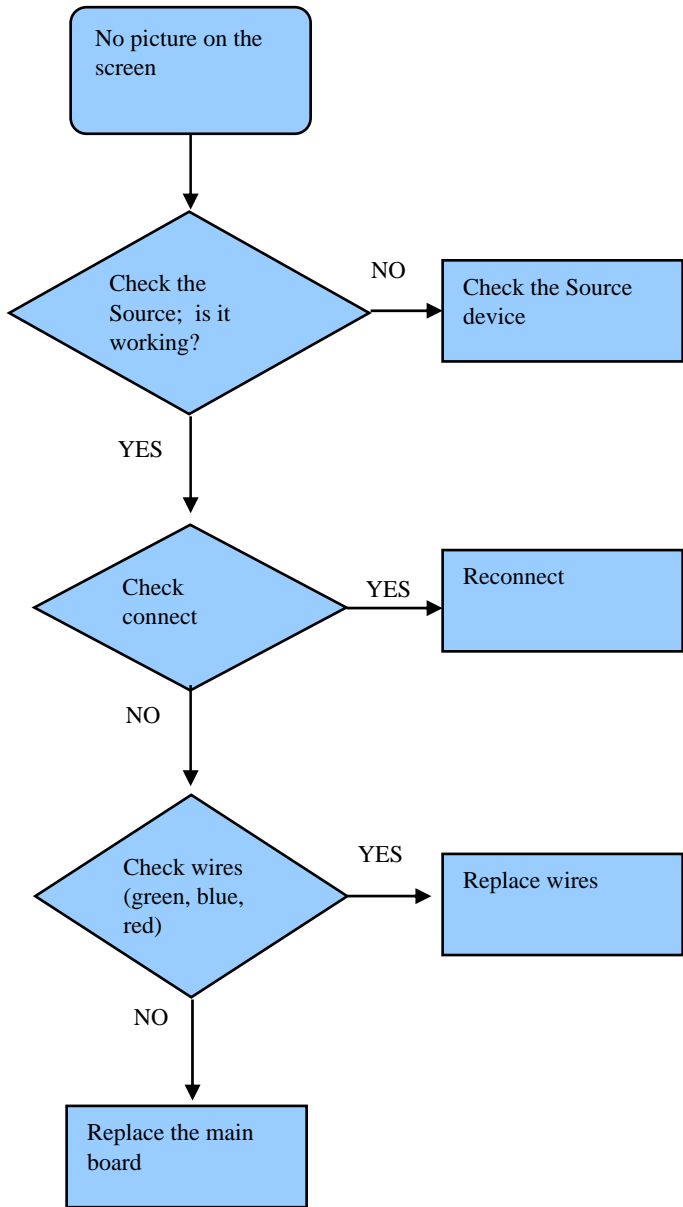



# TV/Video/S-video Input

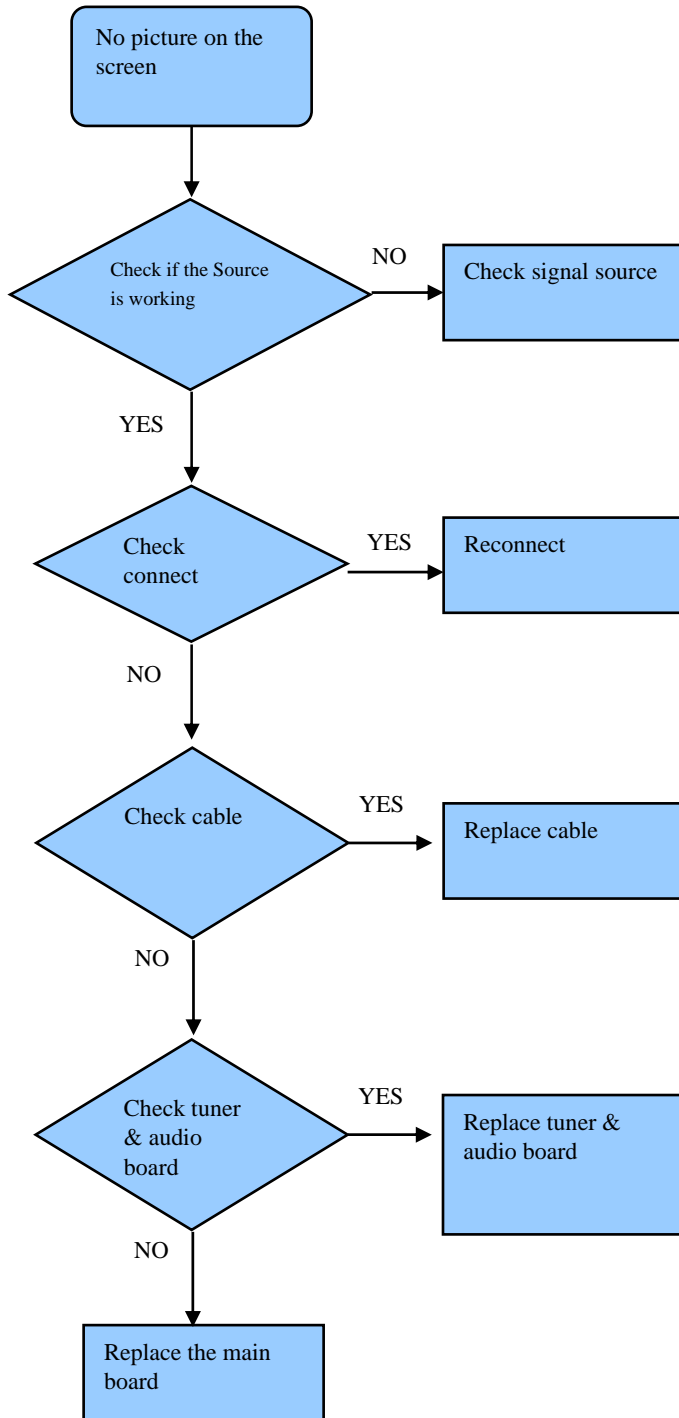

# Troubleshooting Tips

## No Power

- Check the power supply unit (PSU) – Is the PSU board defective?
- Is the power cord connector grounded?
- Check the cable between the PSU board and the main board.
- Is the keypad/remote control power button working?
- Is the power connector connected?

## No Video

- Is there an input source connected?
- Is the LED on?
  - Check the main board and panel cable connection.
  - Is the power on?
  - Is there battery in the remote control?

## Keypad abnormal

- Is the button working properly?
- Check whether the LED is on.
- Check module.
- Check the cable and main board connection.

## LED Display abnormal

- If the LED is off/dark/abnormal – check main board or cable.
- If the LED flickers – Power saving mode in VGA: push any key to restart.

## Abnormal Display

- Missing Line:
  1. Check the cable between the main board and the control board
  2. Check the panel board
- Bright Dot/Dark Dot/Light Leakage/Mura (cloudiness)/Image Sticking/Brightness spot/Particles/Dot Defect – Check panel
- No Display – Check the main board, inverter board, and panel board.
- Display Noise:
  1. Check the cable between the main board and the control board.
  2. Check the panel board.
- Flicker/Image too dark – Check main board or inverter board, load default settings.
- Gray value display – Check main board or panel cable, load default settings.
- VGA no image – Check main board or D-sub cable: is NB switch to LCD monitor?

## LED Display abnormal

The front panel LED uses the following blinking patterns to indicate failures:

Indicator	Blink Frequency	Failure Part	Location
Amber and aqua LED blinking	1 sec interval	MCU-Host link error	Main board
Amber LED blinking	1 sec interval	TAFE does not respond	Main board
Aqua LED blinking	1 sec interval	Tuner does not respond	Main board
Amber LED blinking	2 sec interval	Digital Demodulator does not respond	Main board
Aqua LED blinking	2 sec interval	Audio process does not respond	Main board
Amber and aqua LED blinking	2 sec interval	More than two I2C devices error	Main board

## LCD Panel Troubleshooting Tips

### Inverter board

Power board to panel inverter board (left, right)

Problem:

- No back light
- Screen flash
- If the board is shorted, no power

Action: Change inverter board

### Control board (panel driver)

On top of the LCD panel

Problem:

- Wrong color
- Screen has big block on H or V (over 10 cm)

Action: Change panel

### LVDS cable

Main board to LVDS cable to LCD panel connection

Problem: Line/display noise

Action: Change LVDS FPC cable or main board

### Screen

LCD panel

Problem:

- Mura (cloudiness)
- Crack

Action: Change LCD panel

## Example of defective LCDs

The pictures below are some of the example of what a defective LCD looks like and how to solve the problem:

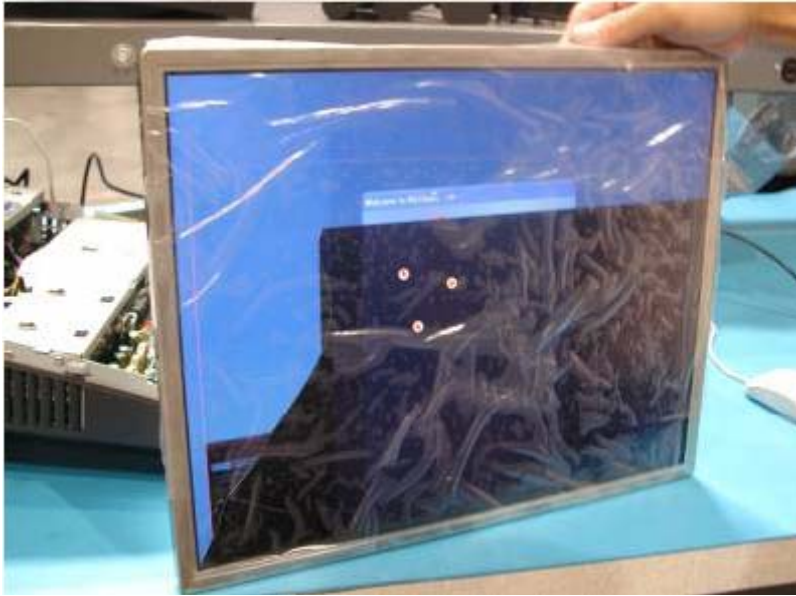

Problem: LCD crack

Solution: Change LCD panel



Problem: Scrape on the LCD panel (1)

Solution: Change LCD panel

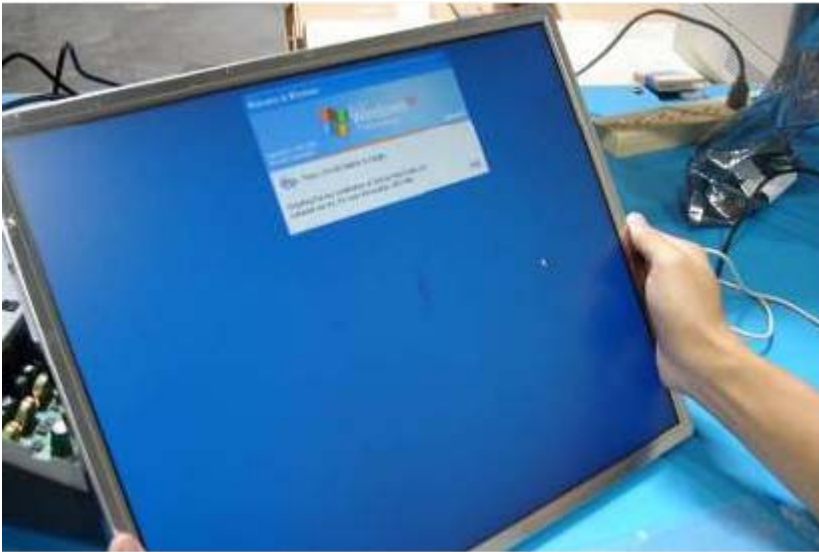

Problem: Scrape on the LCD panel (2)

Solution: Change LCD panel or change Polarizer



Problem: Mura (cloudiness)

Solution: Change LCD panel



Problem: Line

Solution: Change LCD panel

# Chassis Layout and Overall Wiring Diagrams

## Boards Layout (Typical of all models except 32-inch\*)

\* The 32-inch model has only one inverter.

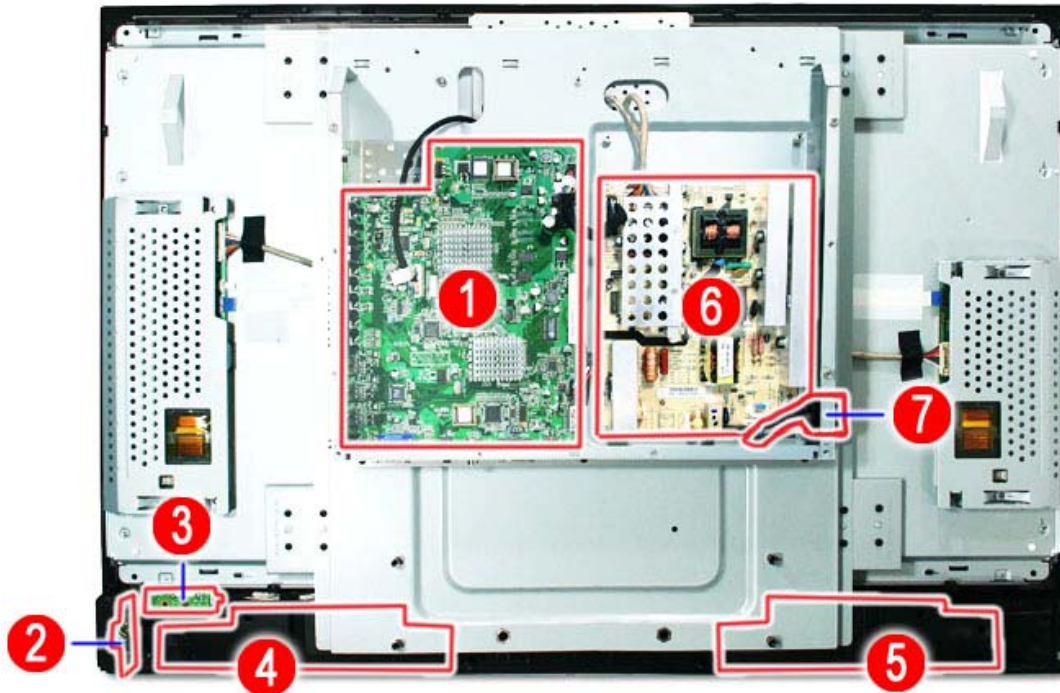

No.	Description
1	Main board
2	Keypad board
3	IR board
4	Speaker left
5	Speaker right
6	Power supply unit board
7	AC socket

# Connectors

## Main Board

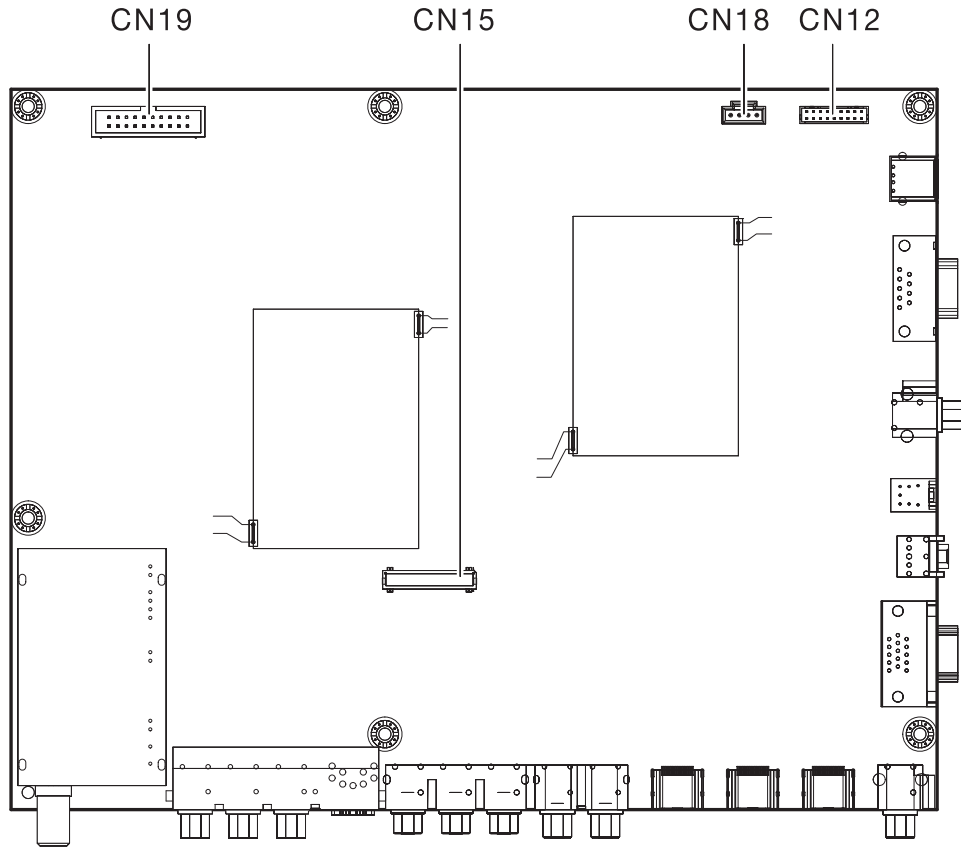

Connector	Specification	Description
CN19	13 pins/ROHS	Power supply from power converter board CN114
CN15	28 pins/ROHS	LVDS output signal (Between main board and panel)
CN18	4 pins/ROHS	Audio power
CN12	11 pins/ROHS	Keypad and IR control (connect to keypad board and IR board)



## Keypad and IR Boards



**Keypad Board**



**IR Board**

Connector	Specification	Description
CN1	9 pins/ROHS	Keypad control signal from main board CN12
CN1	6 pins/ROHS	IR signal and LED control from main board CN12

# Wires and Cables Wiring

## Main Board

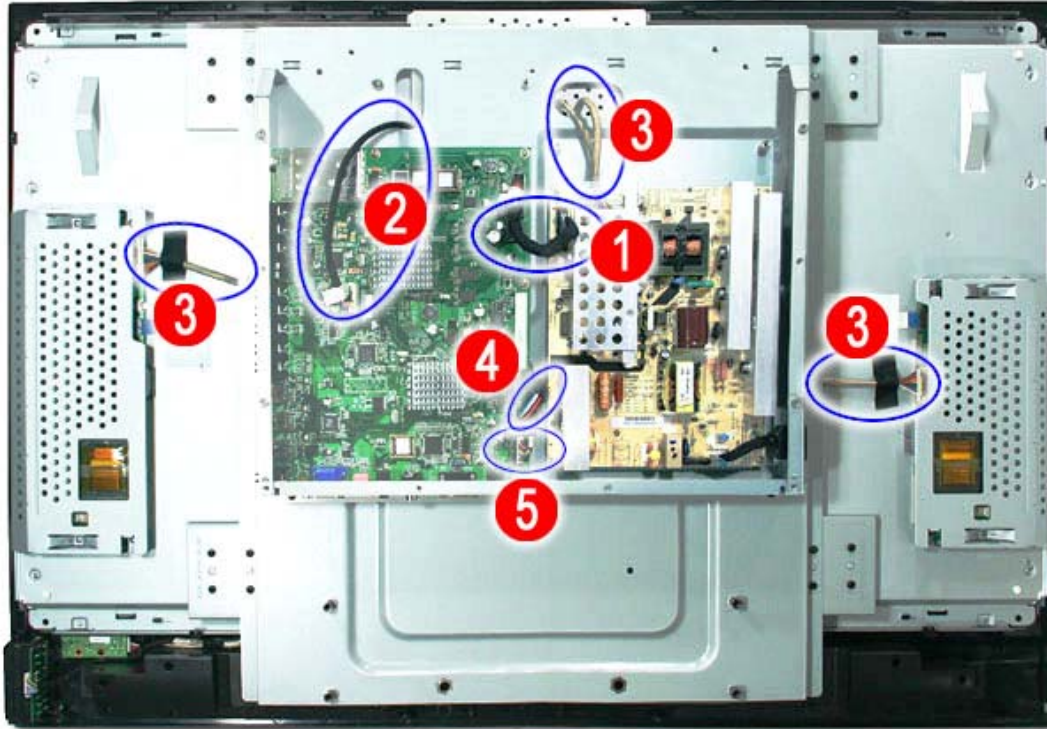

No.	Specification	Input and output signal
1	PSU ⇔ Main board	Vs, 5V, 12V
2	Panel ⇔ Main board	XY signal
3	Power supply ⇔ Inverter board	24V
4	Speaker ⇔ Main board	Audio signal
5	Keypad, IR ⇔ Main board	ADC signal

# Wiring Diagram

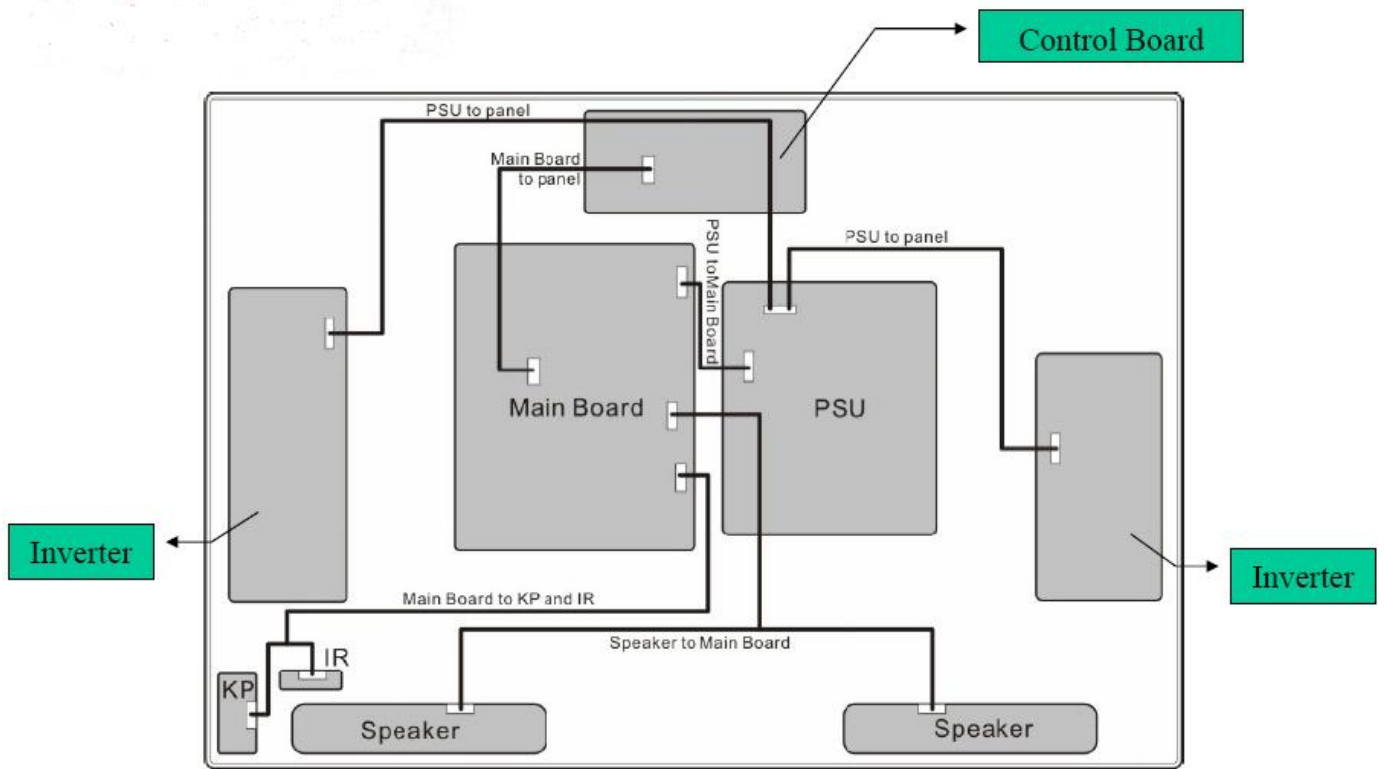

# Firmware Update Procedure

## Overview

Firmware updates are available for download from the HP Web site. The updates consist of two files, as follows:

- For the LT3200 and LT3700 — The **update\_LCD720.tgz** and **safe-kernel.img1** files
- For the LT4200 and LT4700 — The **update\_LCD1080.tgz** and **safe-kernel.img1** files

To transfer the firmware onto the TV, copy the update to a FAT32-formatted USB flash drive.

---

**Note:** The USB flash drive must be formatted in FAT32 or the update will not work.

**Note:** There must be no files on the flash drive except the two components of the firmware update as listed above.

**Note:** The firmware for the 32-inch and 37-inch TVs is not interchangeable with the firmware for the 42-inch and 47-inch TVs.

---

Once you have the correct firmware update on the USB drive, perform the following steps:

- 1 Unplug AC power.
  - 2 Plug in USB drive.
  - 3 Plug AC power back in.
  - 4 Turn on the TV using either the keypad or the remote control.
  - 5 Wait for 30 seconds. The system will start the firmware update and the blue LED will blink every half second. If the update fails, the LED turns amber and continues blinking every half second. If the update succeeds, the blue LED automatically turns off after 150 seconds, indicating that the firmware update is complete.
  - 6 Unplug AC power.
  - 7 Remove the USB drive.
  - 8 Plug in AC power.
  - 9 Turn on the TV using either the keypad or the remote control.
  - 10 Verify the firmware version is correct.
- 

**Note:** If the update fails, check the USB drive to ensure that it is formatted in FAT32 and that it is empty except for the two update files. If it still does not work, try using a different USB drive.

---

## Safe Software Update Procedure

### Introduction

This procedure is designed to prevent programming of the software image (**update.tgz**) to an improper TV board.

This procedure blocks programming between 720P and 1080P, between PDP and LCD, and between StarGate TVs and Volume TVs.

## Software Feature Requirement

- 1 **safe-kernel.img1** reads images with different names, as follows:
  - a. update\_LCD720.tgz
  - b. update\_LCD1080.tgz
- 2 **safe\_kerenl.img1** uncompresses **update\_xxx.tgz**, and then reads product IDs from it. Product IDs are as follows:
  - a. LCD720: all 720P LCD TVs
  - b. LCD 1080: all 1080P LCD TVs
- 3 Assume all TV boards are loaded and initially tested by the ODM and product IDs are embedded into a flash memory block.

## Software Update Procedure

- 1 Load Safe Kernel from a USB drive key.
- 2 Run Safe Kernel. When you run Safe kernel, it reads **update\_XXX.tgz**, uncompresses it, and extracts the Product ID of the software image file: **update\_xxx.tgz**.
- 3 During the software upgrade process, Safe Kernel extracts the Product ID from the flash memory of the main board.
- 4 Compare the product ID from the image file with the product ID from flash memory. If the product IDs match, programming of the flash memory starts. If the flash memory of the main board is blank (no ID is found), programming starts. This is primarily for manufacturing. If the two IDs do not match, programming stops, and an LED warning light blinks.

## Limitation of this Implementation

- No chip ID available (720P and 1080P have same chip).
- When flash memory of the main board is blank, you can program the firmware. PDP software (**update\_PDP.tgz**) can be programmed on a -new LCD main board (blank flash memory), which has no product ID. Please note that this is rare because all TV main boards are pre-programmed and verified in the factory, and the product ID is embedded in main board flash memory.
- Only one **update\_xxx.tgz** file from a software upgrade can be contained on a USB drive key. Even though there is only a single binary per resolution for LCDs and PDPs, service personnel should prepare multiple US drivers.

[www.hp.com](http://www.hp.com)



i n v e n t

Part Number 454404-002