

 Roland®

---

MIDI HUMAN RHYTHM COMPOSER

**R-8**

---

Owner's Manual



# R-8 Quick Operation Mode Table

## ■ Main Mode

### ● SONG

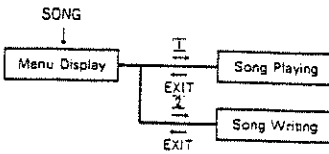

### ● PATTERN

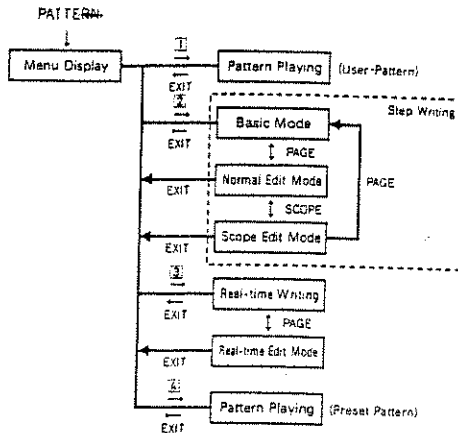

### ● MIDI

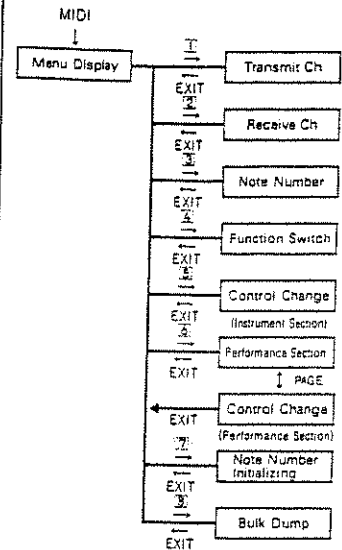

### ● Instrument Assignment

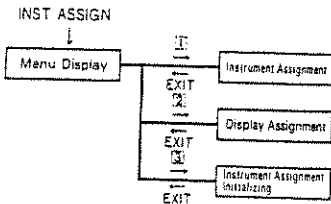

### ● CARD

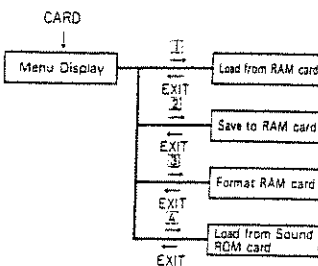

### ● Utility

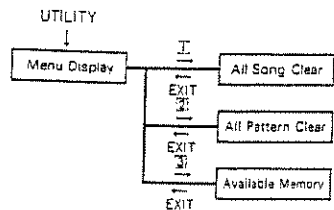

## ■ Edit Mode

### ● Sound Editing

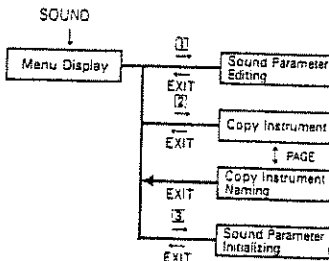

### ● Performance Editing

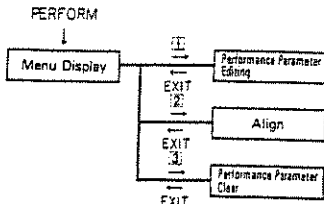

### ● Feel Editing

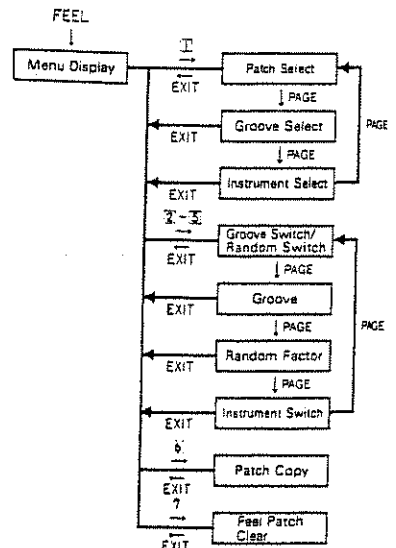

# Data Flow of each Parameters

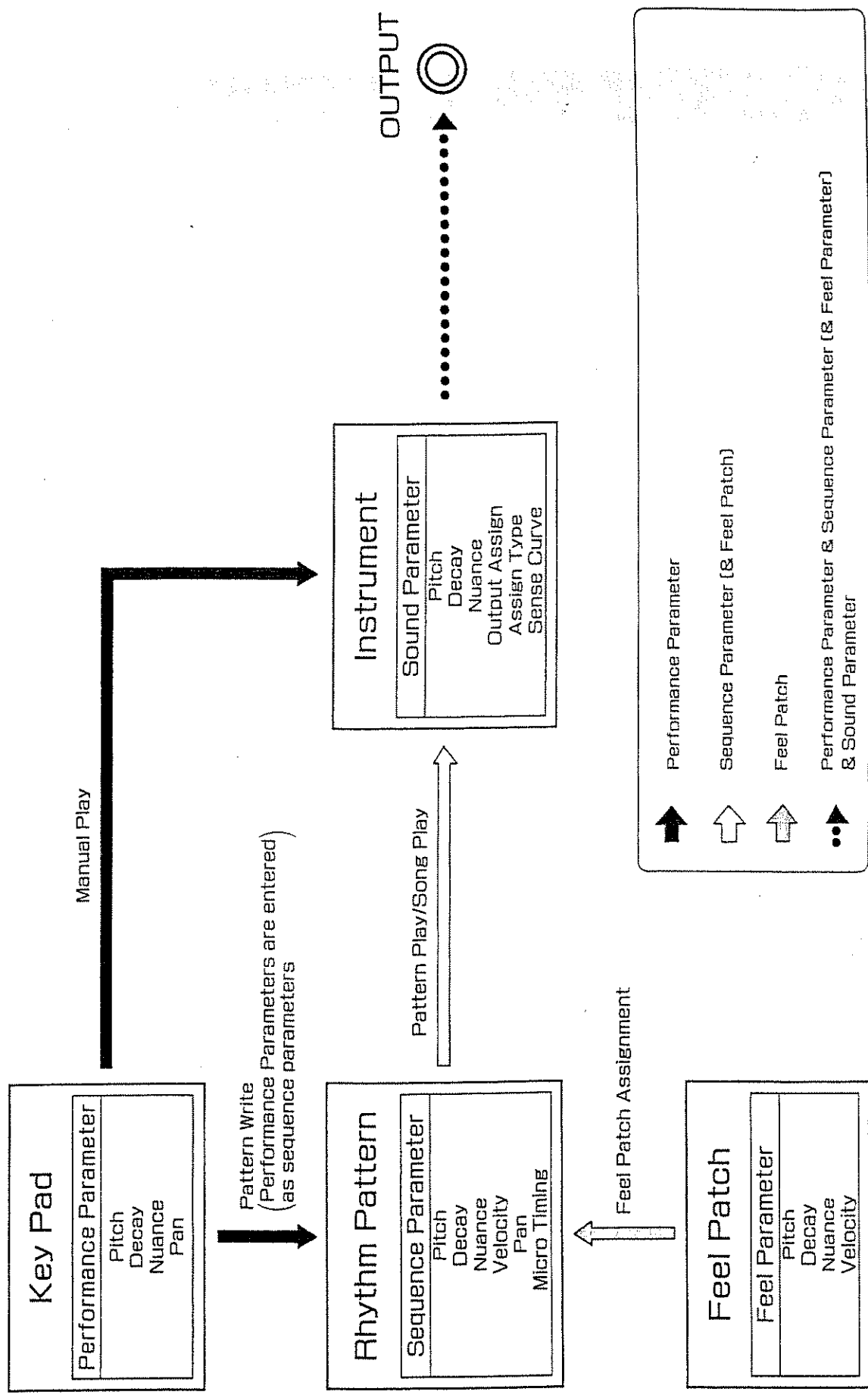

## ■Parameter Table

Parameter	Sound Parameter		Performance Parameter		Feel Parameter		Sequence Parameter	
	Display	Value Range	Display	Value Range	Display	Value Range	Display	Value Range
Velocity	—	—	—	—	VELO	-99~+99	VL	1~127
Pitch	PITCH	-4800~+4800	PITCH	-4800~+4800	PITCH	-99~+99	PT	-4800~+4800
Decay	DECAY	0~127	DECAY	-63~+63	DECAY	-99~+99	DC	-63~+63
Nuance	NUANCE	0~15	NUANCE	-7~+7	NUANCE	-7~+7	NU	-7~+7
Output Assign (Pan)	OUTPUT	LEFT 1~3/CENTER/ RIGHT 1~3/MULTI 1~8	PAN	OFF/LEFT 1~3/ CENTER/RIGHT 1~3	—	—	PN	OFF/L 1~3/C/R 1~3
Micro Timing	—	—	—	—	—	—	MT	-2~+1
Assign Type	ASSIGN	POLY/MONO/EXC 1~8	—	—	—	—	—	—
Sense Curve	CURVE	1~8	—	—	—	—	—	—

# Instrument Table

INST #	DISPLAY	INSTRUMENT NAME
1	*DRY-K1	DRY KICK 1
2	*DRY-K2	DRY KICK 2
3	*WOOD-K1	WOOD KICK 1
4	*DBLH-K1	DOUBLE HEAD KICK 1
5	*DBLH-K2	DOUBLE HEAD KICK 2
6	*SOLID-K	SOLID KICK
7	*ROOM-K1	ROOM AMBIENT KICK 1
8	*ROOM-K2	ROOM AMBIENT KICK 2
9	*MONDO-K	MONDO KICK
10	*WOOD-S1	WOOD SNARE 1
11	*OPEN-S1	OPEN SNARE 1
12	*TIGHT-S	TIGHT SNARE
13	*NICE-S1	NICE SNARE 1
14	*FAT-S1	FAT SNARE
15	*IMPCT-S	IMPACT SNARE
16	*SNAP-S1	SNAP SNARE
17	*OUCH-S	OUCH SNARE
18	*RVB-S1	REVERB SNARE
19	*PICL-S1	PICCOLO SNARE 1
20	*RIMSHT 1	RIMSHOT SNARE 1
21	*RIMSHT 2	RIMSHOT SNARE 2
22	SIDSTK 1	SIDE STICK 1
23	SIDSTK 2	SIDE STICK 2
24	*DRY-T1	DRY TOM 1
25	*DRY-T2	DRY TOM 2
26	*DRY-T3	DRY TOM 3
27	*DRY-T4	DRY TOM 4
28	*ROOM-T1	ROOM AMBIENT TOM 1
29	*ROOM-T2	ROOM AMBIENT TOM 2
30	*ROOM-T3	ROOM AMBIENT TOM 3
31	*ROOM-T4	ROOM AMBIENT TOM 4
32	*POWR-T1	POWER TOM 1
33	*POWR-T2	POWER TOM 2
34	*POWR-T3	POWER TOM 3
35	*POWR-T4	POWER TOM 4
36	DOOM-T1	DOOM TOM 1
37	**CLSD-H1	CLOSED HIHAT 1
38	**OPEN-H1	OPEN HIHAT 1
39	PDAL-H1	PEDAL CLOSED HIHAT
40	CRSH-C1	CRASH CYMBAL 1
41	**MLLT-C1	MALLET CRASH CYMBAL 1
42	**RIDE-C1	RIDE CYMBAL 1
43	**ROBL-C1	RIDE BELL CYMBAL 1
44	BELL-C1	RIDE CYMBAL BELL
45	BOBCLAP	BOB HAND CLAP
46	*OPEN-D1	OPEN DRUM 1
47	*TAIKO 1	TAIKO 1
48	CLAVE 1	CLAVE 1
49	CABASA 1	CABASA 1
50	COWBEL 1	COWBELL 1

51	TAMBRN 1	TAMBOURINE 1
52	SHAKER 1	SHAKER 1
53	MUTE-CG	MUTE HIGH CONGA
54	SLAP-CG	SLAP HIGH CONGA
55	LOW-CG	OPEN LOW CONGA
56	**SLID-CG	SLIDE LOW CONGA
57	AGOGO 1	AGOGO 1
58	**OCT-AGG	OCTAVE AGOGO
59	WHISTL 1	WHISTLE 1
60	WHISTL 2	WHISTLE 2
61	**CAN 1	CAN 1
62	**BACK-S1	BACK SNARE 1
63	BACK-T1	BACK TOM 1
64	BACK-C1	BACK CYMBAL 1
65	**SPARK 1	SPARK 1
66	**SURF	SURF
67	**WHEEL 1	WHEEL 1
68	REST	REST

COPY INST#	SOURCE INST#	DISPLAY	INSTRUMENT NAME
1	4	*DBLH-K3	DOUBLE HEAD KICK 3
2	20	*RIMSHT 3	RIMSHOT SNARE 3
3	36	DOOM-T2	DOOM TOM 2
4	36	DOOM-T3	DOOM TOM 3
5	37	**CLSD-H2	CLOSED HIHAT 2
6	37	**CLSD-H3	CLOSED HIHAT 3
7	38	**OPEN-H2	OPEN HIHAT 2
8	38	**OPEN-H3	OPEN HIHAT 3
9	40	CRSH-C2	CRASH CYMBAL 2
10	40	CHOK-C1	CHOKED CRASH CYMBAL 1
11	40	SPLA-C1	SPLASH CYMBAL 1
12	40	SPLA-C2	SPLASH CYMBAL 2
13	45	DRYCLAP	DRY HAND CLAP
14	46	*OPEN-D2	OPEN DRUM 2
15	49	CABASA 2	CABASA 2
16	50	COWBEL 2	COWBELL 2
17	55	HIGH-CG	OPEN HIGH CONGA
18	57	AGOGO 2	AGOGO 2
19	38	**PLATE 1	PLATE 1
20	57	RING 1	RING 1
21	59	PIPE 1	PIPE 1
22	48	WBLOCK 1	WOOD BLOCK 1
23	48	WBLOCK 2	WOOD BLOCK 2
24	65	**THRILLR	THRILLER
25	45	GUNSHT 1	GUN SHOT 1
26	52	SHADOW	SHADOW

\* The sound changes by changing the strength of Key Pad hitting or the setting of Nuance.  
 \*\* The sound changes by changing the setting of Nuance.

# R-8 AN EASY METHOD TO GET YOU STARTED

Because this booklet is intended to illustrate the basic steps that might be taken for creating patterns and songs, many other details are not touched upon. We recommend that you read through the owner's manual beforehand to gain further useful information. We are going to create a song using 5 simple patterns written in real-time. We will make a few real-time edits, insert some repeat marks and a tempo change, and hopefully you will understand how easy it is to use the R-8. This exercise uses very simple patterns which we invite you to copy as we go along, or create your own. (For those of you who cannot read musical notation, please program the patterns as you wish, but maintain the same length as our example.)

## Before Starting

To make sure we stay together through this simple process, first initialize your R-8 by holding **SELECT** and **PAGE** down while turning on the power. Press **ENTER** twice and it's initialized.

\*There are other ways of initializing specific parameters.

See the owner's manual on page 158.

## Let's Make Rhythm Patterns

We will use the Tempo of 120 BPM. To verify, push **TEMPO**, adjust if necessary, then push **TEMPO** again.

Press **PATTERN**, and select number 3 for Real-time Writing. The display shows:

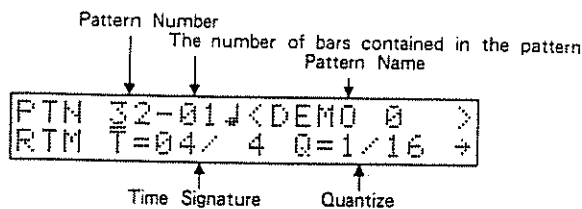

\* You can always exit from any step along the way by pressing **EXIT** if you are not sure of what should be showing in the display.

Well, now we are ready to proceed one by one with our series of patterns.





## Rhythm Pattern B

Let's go to pattern number 91. The cursor should be under the pattern number in the display. Using **-1/OFF** **+1/ON**, select the next pattern, in this case, 91.

Format the pattern the way we did with number 90 except this time select 4 bars for it's length. Press **ENTER** and then **START**. You'll hear the metronome.

The quantize resolution is on 1/16 and you will notice that you can change the resolution while the pattern is in the record mode. To change the resolution you can use the VALUE slider, Numerical keys, or **-1/OFF** **+1/ON**. Leave it at 1/16 for now.

Pattern number 91 will be your basic 8-beat rhythm, as shown :



I suggest you start with the Hi-hat, playing eighth notes for the 4 measures.

● Now let's suppose you want to do the Hi-hat again. Press **STOP**. Hold **SHIFT** down and press **CLEAR** (key pad 14). The display shows :

```
PTN CLEAR <PTN 91>
INST=(ALL INST)
```

↑  
Erasing all the Instrument

This is the stage where you can erase everything you have done in the pattern, including the length ; or you can just erase all of the Hi-hat, Kick, Snare or whatever you want. In this case, press the **CLOSED HH** (key pad 11), and it will appear in the display. Press **ENTER** and the Hi-hat is gone, and you can do it over again.

There is one other way of erasing, and that is in real-time. You should practice this once to understand. After you have programmed your Hi-hat part again, while the machine is still playing, hold **SHIFT** down and press the **CLOSED HH** (key pad 11) down for as long as you want to erase the sound. To experiment, I suggest you hold it down for the count of 4 and release it for 4, always keeping **SHIFT** pressed.

Now that you know how to do this, program the Hi-hat part again.

Program the Snare drum on the 2's and 4's and the Bass drum as is written above.

## Rhythm Pattern C

Press **STOP**, and go to pattern number 92. Hold **SHIFT** down, press **CLEAR** (key pad 14), and format pattern number 92 for 2 bars.

Press **START**. The metronome sounds and you will be able to refer to the bar number indicator in the display.

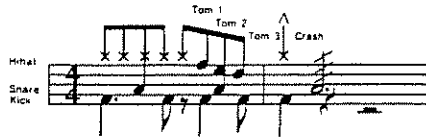

Here we are going to program the first measure first. Count along and enter 8th notes with the Hi-hat in the first measure. Enter the Kick and Snare as written. Add a simple Tom fill to lead into the second measure. If you make a mistake, it is easy to create each voice, one by one.

Now, enter a Crash and Kick on the first beat of the second measure. While the machine is running, (you should have a full first measure and the Crash on the first beat of the second) change the quantize resolution to 1/32. On beat "2" of measure "2" we are going to enter a roll.

First, stop the machine and while holding down **ROLL**, press any of the key pads and feel what the roll can do. Increase the pressure on the pad and the volume increases as well. We are going to enter a roll from beat "2" through beat "4".

Start the machine, and counting if you have to, press **ROLL** and the **SNARE** (key pad 14) at the same time, from beat "2" of the second measure. Stop before the "1" of the first measure. If you do not end the roll well, erase the Snare drum, either just the roll or all of the Snare in this pattern, and do it again.

### ● Real-time Edit (Pitch)

Let's have some fun with the roll. Let's use the real-time edit function, and change the pitch of the roll so that it starts low and finishes high.

Press **START**, and while the rhythm is playing, press **PAGE**.

The display shows :

```
PTN 92^02↓<+>EDIT!!>
RTM $UL= 064
```

Sequence parameter      Value

By pressing **SELECT** find "\$PT=0000" in the display.

Use the VALUE slider or **-1/OFF** **+1/ON** to determine the starting point of the pitch change. Move it to -2000. While the pattern is playing the roll, hold down the **SNARE** pad for the length of the roll only. Release your finger after the roll, and the next time it plays you will see what you have done. Now to correct this type of edit, you must just select the original setting, in this case 0000, hold down the key to be edited, and it will return to normal.

While the machine is playing, experiment with the VALUE slider, to see how gradual a change you can make in the tuning. If you hold down the **SNARE** pad while doing this, you will create a real-time edit. Do this until you have a rising-pitch roll.

Of course, with all the other parameters in this mode, there are changes you can make. Let's keep it simple for now. Press **PAGE** to return to the real-time write display.

## Rhythm Pattern D

Next, we want to program another 4 bar pattern. Format pattern number 93 for 4 bars, press **ENTER**, **START**, and program the same type of rhythm as pattern number 91, only this time play the eighth notes on the Ride Cymbal. Make sure you are still in Pad Bank "A". The pattern should sound as written here.



### ● Real-time Edit (Pan)

While the machine is running, press **PAGE** and then **SELECT** until "\$PN=\*OFF\*" appears in the display.

Hold down the **RIDE** (key pad 4) and with the VALUE slider or **-1/OFF** **+1/ON**, change the pan of the cymbal from L-3 to R-3. Try to do it in rhythm or as you please, and release your hands after you think you have got what you want. This is only to show you how it works. You can of course, go back and pan that rising-pitch roll from left to right if you like.

## Rhythm Pattern E

Format pattern number 94 for 2 bars. This is the ending pattern, so we will just make a simple accented ending, as shown here, or as you like.

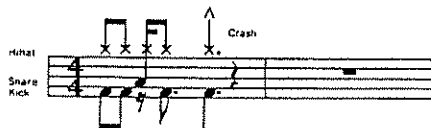

Remember, we changed the quantize resolution earlier, for programming the roll, and depending on your real-time tapping skills, you may find programming 8th notes with the  $1/32$  resolution a bit difficult. Change it as you wish. One reminder here. There is also a roll resolution. It is important to remember that the overall quantize resolution will determine how the roll sounds. Match the two or set quantize to HIGH. Also, roll resolution will change with the tempo.

## Putting it all together

So now we have 5 patterns to work with in making the song. 90, 91, 92, 93 and 94. Press **SONG** and the display shows :

```
PLAY WRITE
```

Press Numerical key 1, and select the song number, in this case, 1.

Press **EXIT** and then Numerical key 2, to write a song, and the display shows :

```
      Song Number      Song Name
      |                |
SONG 1 <----->
PART 001 PTN 00-01 ?
      |                |
      Part Number      Pattern Number
```

Here is where we select the order of patterns to be used in the song. We will be logical and start from 90.

Pressing either **+1/ON** or **-1/OFF** will change the numbers appearing in the right side of the display. With 90-01 showing, press **ENTER**. You will notice on the left side that "PART 002" shows. Here we are assigning rhythm patterns to "Parts" in the song.

Press **+1/ON** to change the display to show "PTN 91-04". Press **ENTER** again. Keep repeating this until you have made

5 parts in the song, with the patterns appearing in order from 90 to 94.

Press **EXIT** and then Numerical key 1 to go to song play mode.

Press **START** and what we have programmed is now a "song". Press **STOP**.

### ● Song Edits

Let's make a few simple edits to the song.

Press **SONG** or **EXIT**. Select number 2 for song write. Push **▶** until "PART 002 PTN 91-04" appears in the screen. Press **SHIFT** and **PART INSERT** (key pad 10). Display shows :

```
PART INSERT <SONG 1>
PART 002 PTN 91-04 ?
```

Press **SELECT** and "REP || :" shows in the display, Press **ENTER**.

What we have done is enter the repeat mark, as we want to repeat this four-bar pattern. Remember that a repeat mark is entered as a "Part", so the number of parts in a song will increase with every inserted change, like repeats or tempo changes. It's important to remember this when you are writing a song, so you do not get confused with the changes.

Now, with the cursor move it so "PART 004 PTN 92-02" shows in the display. Press **SHIFT** and **PART INSERT** (key pad 10). Use **SELECT** to bring ":|| x01?" into the display. Press **ENTER**.

What we have done is to enter repeat marks before and after pattern number 91. Use the same procedure for entering other song edits, such as tempo or level changes.

It is very easy and it is always simple to push **EXIT** to start your editing process all over again. This concept prevails throughout all the editing functions of the R-8. Though there is a lot you can do with it, each process is simple and easy to understand. We hope this has made some of the most important functions of the R-8 easier to understand.

Press **EXIT** or **SONG**, select number 1 for song play, and

any programming miracles, you are on your way! .

To check that you have gotten everything entered correctly, press **SONG**, Numerical key 2 and then . This will take you through the PART order of the song as it is finally programmed. It should read as shown below :

PART 001 PTN 90-01  
PART 002 REP || :  
PART 003 PTN 91-04  
PART 004 REP :|| x01  
PART 005 PTN 92-02  
PART 006 PTN 93-04  
PART 007 PTN 94-02

If you go beyond the end of the program of the song, a "?" will appear after the pattern number. The song will end with the last part/pattern you have selected.

# **R-8** HUMAN RHYTHM COMPOSER

---

## **Owner's Manual**

Thank you for purchasing the Roland Rhythm Composer R-8. The R-8 is a completely new - type rhythm machine, featuring various functions that now make possible extremely realistic performances.

To make the best use of the R-8, please read this owner's manual carefully.

---

**Copyright © 1988 by ROLAND CORPORATION**

All rights reserved. No part of this publication may be reproduced in any form without the written permission of ROLAND CORPORATION.

# CONTENTS

- Important Notes .....6
- Outline of the R-8 .....8
  - 1. About Human Feel .....8
  - 2. Features of the R-8 .....10
- Panel Descriptions .....11
- Basic Connections .....12

## PLAYING RHYTHM

- ① Let's Play .....14
  - 1. Manual Playing .....17
  - 2. Demonstration Songs .....20
  - 3. Pattern Playing .....23
    - a. Playing Preset Patterns .....23
    - b. Playing User-Patterns .....24
    - c. Feel Patch Assignment .....25
- ② Before Writing Rhythm Data
  - 1. Procedures for Rhythm Programming .....27
    - a. Three Procedures .....27
    - b. How to carry out Rhythm Programming .....28
  - 2. The R-8's Nine Modes .....31
  - 3. Basic Procedures .....33

## INSTRUMENT SETTINGS

- ① Instrument Assignment .....40
  - 1. Instrument Assigning .....40
  - 2. How to use a Sound ROM Card .....43
  - 3. Display Assign .....46
- ② Setting Sound Parameters .....47
  - 1. Description of Sound Parameters .....47
    - a. Pitch .....47
    - b. Decay .....48
    - c. Nuance .....49
    - d. Output Assign .....49
    - e. Assign Type .....50
    - f. Sense Curve .....51
  - 2. Editing Procedure .....52
  - 3. Copy Instrument .....54

## RHYTHM PATTERN PROGRAMMING

- ① Pattern Writing (Basic) .....58
  - 1. Default Settings for Pattern Write .....59
  - 2. Real-time Writing .....61
  - 3. Step Writing .....65
    - a. Step Writing Modes .....65

- b. Basic Step Writing .....69
- c. Step Writing in the Edit Mode .....71
- d. Examples for Step Writing .....75

## ② Pattern Writing (Advanced) .....77

- 1. Performance Parameters .....77
  - a. Functions of the Performance Parameters .....79
  - b. Setting Performance Parameters .....80
  - c. Using The Multi Assign Function .....81
- 2. Swing/Flam/Roll Entry .....84
  - a. Swing .....84
  - b. Flam .....86
  - c. Roll .....88
- 3. Macro Note .....89
  - a. Macro Note Setting .....89
  - b. Using Macro Note .....92
  - c. Macro Note Erasing .....95

## ③ Feel Patch .....96

- 1. Functions of Parameters .....98
  - a. Groove Select .....98
  - b. Instrument Select .....98
  - c. Groove Switch and Random Factor Switch .....99
  - d. Groove .....99
  - e. Random Factors .....99
  - f. Instrument Switch .....100
- 2. Editing Procedure .....101
  - a. Groove Setting .....101
  - b. Random Factor Setting .....103
- 3. Feel Patch Assignment .....105
- 4. Feel Patch Copy .....106

## ④ Rhythm Pattern Editing .....107

- 1. Editing Sequence Parameters .....107
  - a. Real-time Edit .....108
  - b. Step Edit .....110
- 2. Timing Edit .....112
  - a. Macro Timing Shift .....112
  - b. Micro Timing Shift .....113
- 3. Pattern Edit .....115
  - a. Instrument Change .....115
  - b. Pattern Append .....116
  - c. Pattern Extract .....117
  - d. Pattern Merge .....119
  - e. Reframe .....120



f. Pattern Copy	121
g. Pattern Name	123

## SONG PROGRAMMING

1 Song Write	126
1. Song Writing	127
2. Repeat	129
3. Tempo Change	131
4. Level Change	132
5. Label	133
a. Label Setting	133
b. Search Label	134
2 Song Edit	135
1. Part Delete	135
2. Part Insert	136
3. Part Copy	138
4. Song Copy	140
5. Song Clear	141
6. Song Name	142
3 Functions for Song Play	143
1. Continue Play	143
2. Song Chain	144
3. Initial Tempo and Initial Level	145
4. Search Label	146
5. Time Calculate	147
6. Time Display	149
7. Time Set	150

## OTHER USEFUL FUNCTIONS

1 Utility	152
a. Available Memory	152
b. All Song Clear	153
c. All Pattern Clear	153
2 Users Function	154
3 Initialization	158
4 Memory Card (RAM)	162
1. Formatting	163
2. Save	165
3. Load	166

5 Sync Play	167
1. Sync Mode Setting	167
2. MIDI Sync	169
3. Tape Sync	170

6 MIDI	172
1. MIDI Function Settings	172
a. Transmit Channel	173
b. Receive Channel	174
c. Note Numbers	175
d. Function Switch	176
e. Control Change	180
f. Performance Section	181
2. Example Setups	183
a. Using the R-8 as a MIDI Sound Module	183
b. Playing an external MIDI Sound Module with the R-8	185
3. Data Transfer via Exclusive	186
a. Transmit	186
b. Receive	188
c. Transmitting Sound Parameters	188

■ Reference	189
1. Error Message Table	189
2. Troubleshooting	192
3. Blank Chart	198
4. Preset pattern Table	204
5. Preprogrammed Sound Parameters and Note Numbers	205

■ MIDI Implementation	209
-----------------------	-----

■ Specifications	224
------------------	-----

■ Index to Functions	226
----------------------	-----

■ Index to Terminology	229
------------------------	-----

# ■ IMPORTANT NOTES

## ◇ Power Supply ◇

- Please use the supplied AC adapter with the R-8. Using any other AC adapter will cause trouble. Also, do not use the supplied AC adapter with any other unit but the R-8.
- The appropriate power supply for this unit is shown on its name plate. Please make sure that the line voltage in your country meets this requirement.
- Do not use the same socket used for any noise generating device. (such as a motor or variable lighting system)
- Make sure that the unit is turned off before connecting the power plug to the AC socket.
- When disconnecting the power plug from the socket, do not pull the cord, but hold the plug to avoid damaging the cord.
- Avoid damaging the power cord.
- If the unit is not to be used for a long period of time, unplug the cord from the socket.
- Disconnect the AC cord immediately in the event of an electrical storm.
- Before setting up the R-8 with other MIDI devices, turn this unit off along with all other units.
- If you must connect the instrument (this unit) to an amplifier while switched on, be sure to connect the cord to the instrument first. When disconnecting, disconnect the cord from the amplifier first.

## ◇ Room Location ◇

- Avoid using this device in excessive heat or humidity conditions, or where it may be affected by direct sunlight or dust and avoid places subject to high vibration.
- Operating the unit near a neon light, fluorescent lamp, TV or CRT display may cause noise interference. If so, change the angle or the position of the unit.
- Operating this unit near a TV or radio may cause picture or noise interference. If this happens, move the unit away from these instruments.
- Do not place or drop anything heavy on the main unit or its power cord.
- Static electricity may cause the built-in computer to malfunction. Should this occur, simply rest it by turning the power switch off and then on again after a few seconds.

### ◇ Cabinet Cleaning Care ◇

- For cleaning the unit, use a dry and soft cloth.
- Should the casing become soiled, use a cloth slightly dampened with water.
- To remove stubborn grime, clean the casing with a cloth moistened with a neutral detergent, then wipe it dry with a soft cloth.
- Do not use solvents such as paint thinner when cleaning.

### ◇ Memory Back Up System ◇

- This unit features a memory backup system that retains the data even after switched off. The battery that supports the backup circuit should be replaced every five years. Call the Roland service station for a battery replacement. (The first replacement may be required before five years, depending on how much time had passed before you purchased the unit.)
- Although we do our utmost to protect your data during repairs, sometimes, especially when working on the memory itself or on a related area, some of your important data may be lost. Keep a separate record of all the data that you consider important. This can be done by saving it into the RAM card or by writing it down on a sheet of paper.

### ◇ How To Handle The Unit ◇

- Adjust the volume control to a level that will not disturb the neighborhood, especially at night when sounds can travel over long distances.
- Do not allow fluid or foreign matter, such as water, beverages, coins and wires, to enter this unit.
- Do not examine or modify the internal components or circuitry. Electrical shocks or damage may result.
- Do not subject this unit to strong shocks, or move it while the power is on.
- If this unit fails to operate correctly, turn it off immediately and contact your Roland dealer.
- Never push or hit the display hard.
- Do not hit the key pads of the unit with a stick or anything hard.
- If the LCD display is difficult to view, adjust the contrast with the LCD Contrast Control Knob on the rear of the unit.

# ■ OUTLINE OF THE R-8

## 1. About Human Feel

Rhythm performances from conventional rhythm machines or sequencers sometimes a monotonous and mechanical impression to the listeners. Roland has succeeded in removing the causes of such limitations and has provided for expression of more realistic drum performances (a much more Human Feel). The result is the Roland rhythm machine R-8.

### -Causes of monotonous and mechanical rhythm

There are two elements that prevent past rhythm machines from obtaining realistic expression :

- When a human being plays a rhythm instrument, unlike a programmable rhythm machine, they change the strength or position with each beat to create accentuation. Thus, the effectiveness of the drum performance varies depending on the drummer.
- Even though one intends to play in exactly the same manner, the strength or positions of beating will vary slightly. This means that the overall performance will contain a variety of tonal and Rhythmical qualities.

### What the R-8 can do

The R-8 can express such subtle sound and timing changes as described above, presenting more realistic performances (what we call "Human Feel" in this manual), as follows.

#### ●Natural tone alteration according to the beating strength or beating positions

Depending on how hard you play the Snare drum, Kick drum or Tom, the tones of each drum voice (Snare, Kick, or Tom) will change in a very natural way.

#### ●Wide variety of sound editing parameters

By changing the setting of the parameters (Velocity, Pitch, Decay and Nuance), the tone of each Instrument can be edited to your taste. Also, even after having written a rhythm pattern, you can edit the sound of each Instrument.

● **Micro Timing**

The timing (steps) of the R-8's rhythm performance (Pattern Play or Song Play) can be set with minute precision, to a resolution of  $1/384$  note.

● **Feel Function**

A Feel Patch consists of two sections, Groove that changes the strength or position for beating, and Random Factor section which sets random and subtle tone changes. When playing a rhythm pattern, you can set a desired Feel Patch to the rhythm pattern. The same rhythm pattern will be played differently by changing the Feel Patch data.

## 2. Features Of The R-8

- The R-8 features 68 different high quality instruments (rhythm voices) sampled at 44.1kHz with 16 bit dynamic range. With the Touch Sense function provided on the Key Pads, you can obtain extremely realistic drum sounds, because of the natural alteration of the volume and tone according to the strength of pad striking.
- Some Instruments can be played so that the beating strength changes the nuance (Kick, Snare and Toms). With the Hihat and Ride cymbals only, the Nuance creates the effect of Hihats in different positions. Also, with Pan, Decay and Pitch settings a more expressive drumset can be realised.
- The Copy Instrument function allows you to create up to 28 different Instruments, in addition to the 68 existing Instruments.
- For more realistic performance, the R-8 allows delicate adjustments in timing / velocity / decay / pitch and nuance.
- The R-8's internal memory can store 32 Preset Rhythm Patterns, 100 User-programmed Patterns and 10 Songs.
- Up to eight Feel Patches ( regular tone changes in accord with accents set in the music, and random tone changes) can be set independently for User-programmed patterns.
- The following editing functions are available :
  - ☆ Pattern Copy.
  - ☆ Instrument Change this replaces one Instrument in a Pattern with another Instrument.
  - ☆ Merge function that mixes two Patterns.
  - ☆ Pattern Append function that joins more than one Pattern, etc.
- Using an optional sound ROM card, you can extend 26 more Instruments.
- Frequently used button procedures can be registered as Users Functions.
- Frequently used rhythm patterns can be registered as Macro Notes . The registered pattern can be entered by tapping the Key pad once in the rhythm pattern writing mode.
- The total performance time of a song can be checked, or the tempo needed for playing a song within a specified time can be calculated.

# ■ PANEL DESCRIPTIONS

## [Rear Panel]

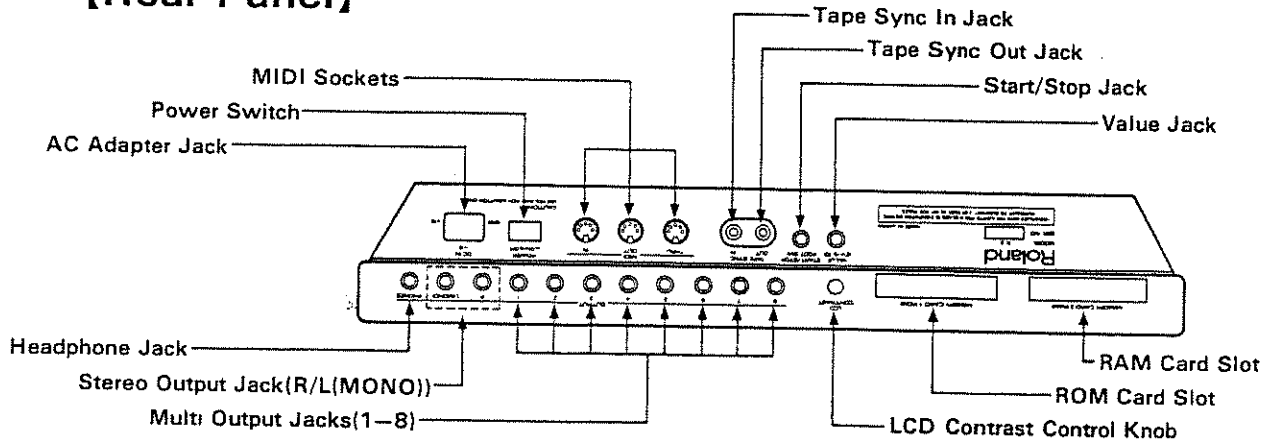

## [Front Panel]

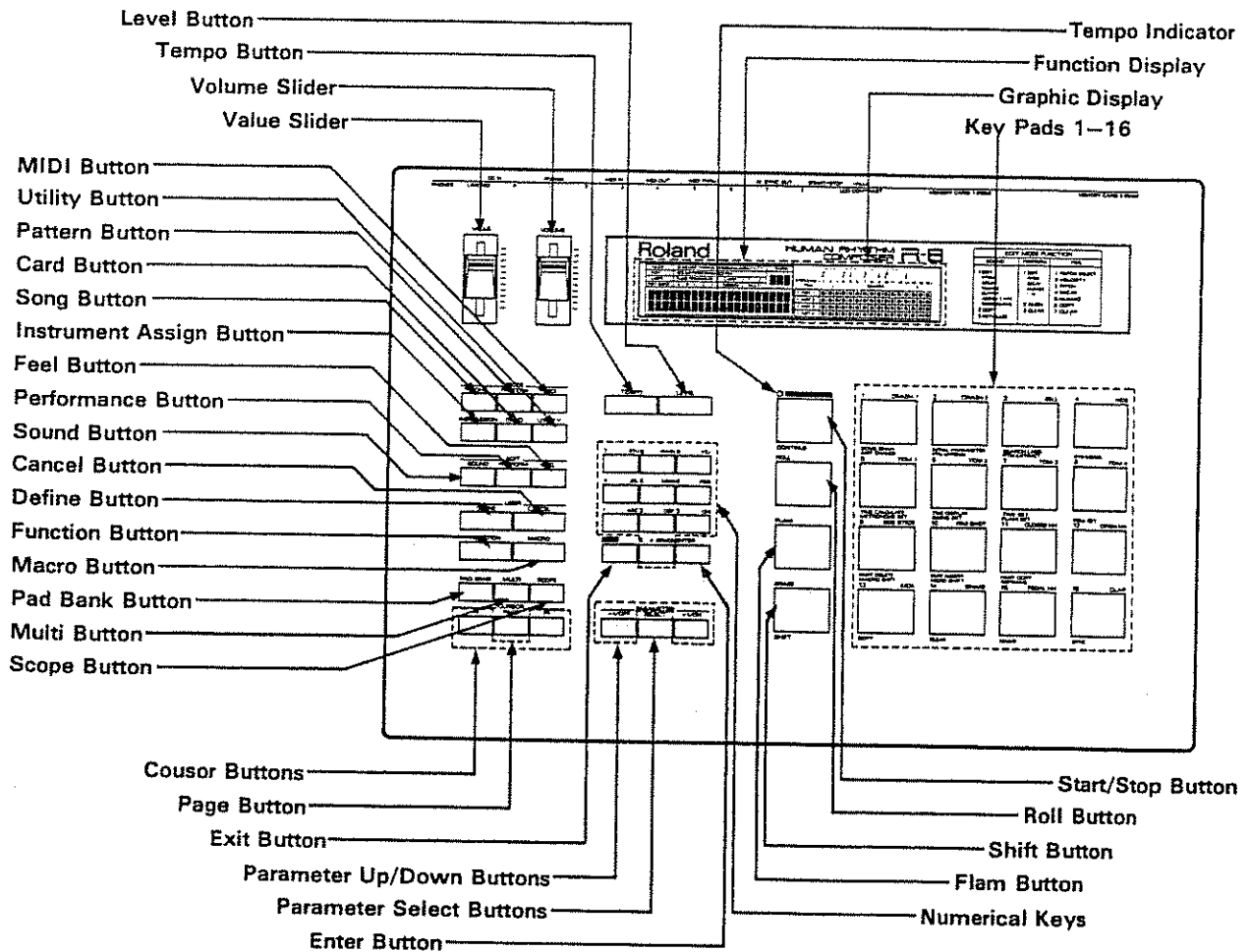

# ■ BASIC CONNECTIONS

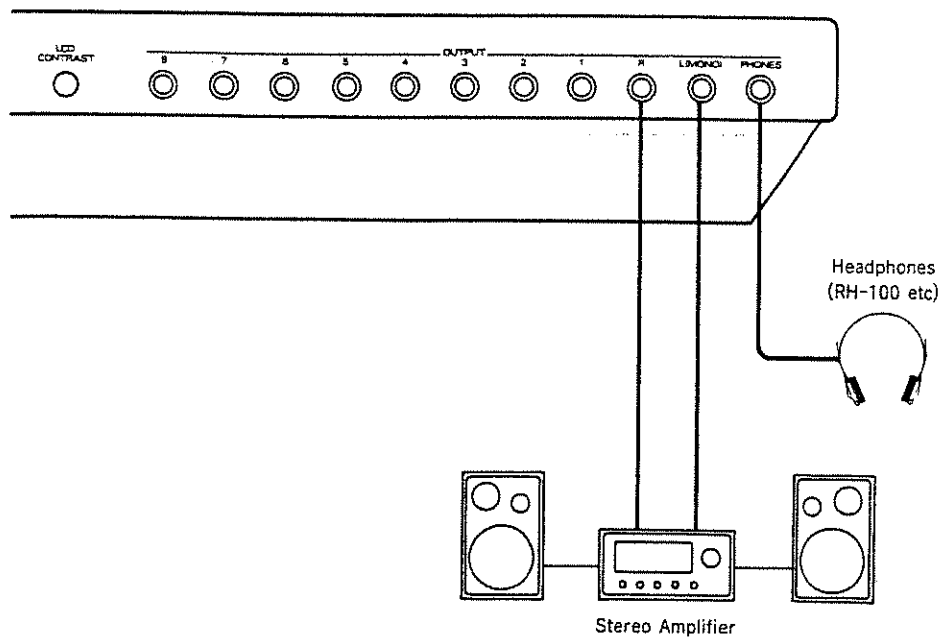

**Specific :** Instruments can be output from any individual Multi Output jacks (1 – 8).

At the manufacturer, all the Instruments are set to be output from the Stereo Output jacks, therefore no sound is output from the Multi Outputs.

If you wish to use the Multi Output jacks, change the Output Assign of each Instrument (see page 49).



# PLAYING RHYTHM

1 Let's Play

P. 14

2 Before Writing Rhythm Data P. 27

# 1 LET'S PLAY

The R-8 is programmed with 68 Rhythm Instruments plus 26 more Copy Instruments (when released from the manufacturer) as shown below. The sound of an Instrument with the "\*" mark will change in accord with settings for Nuance (see page 49) or the strength of Key pad hitting. The sound of an Instrument with the "\*\*\*" mark will change by editing the value of Nuance.

INST #	DISPLAY	INSTRUMENT NAME	COMMENT
1	* DRY_K1	DRY KICK 1	Close miking sound
2	* DRY_K2	DRY KICK 2	Close miking sound
3	* WOOD_K1	WOOD KICK 1	Close miking sound
4	* DBLH_K1	DOUBLE HEAD KICK 1	
5	* DBLH_K2	DOUBLE HEAD KICK 2	
6	* SOLID_K	SOLID KICK	
7	* ROOM_K1	ROOM AMBIENT KICK 1	With large room ambience
8	* ROOM_K2	ROOM AMBIENT KICK 2	With large room ambience
9	* MONDO_K	MONDO KICK	
10	* WOOD_S1	WOOD SNARE 1	Close miking sound (8 inch snare)
11	* OPEN_S1	OPEN SNARE 1	Close miking sound
12	* TIGHT_S	TIGHT SNARE	Close miking sound (5 inch snare)
13	* NICE_S1	NICE SNARE 1	With ambience
14	* FAT_S1	FAT SNARE 1	
15	* IMPCT_S	IMPACT SNARE	With ambience
16	* SNAP_S1	SNAP SNARE 1	
17	* OUCH_S	OUCH! SNARE	With Reverb effect
18	* RVB_S1	REVERB SNARE	With Reverb effect
19	* PICL_S1	PICCOLO SNARE 1	Close miking sound (3 inch snare)
20	* RIMSHT1	RIMSHOT SNARE 1	Close miking sound
21	* RIMSHT2	RIMSHOT SNARE 2	With ambience
22	SIDSTK1	SIDE STICK 1	
23	SIDSTK2	SIDE STICK 1	
24	* DRY_T1	DRY TOM 1	Close miking sound
25	* DRY_T2	DRY TOM 2	Close miking sound
26	* DRY_T3	DRY TOM 3	Close miking sound
27	* DRY_T4	DRY TOM 4	Close miking sound
28	* ROOM_T1	ROOM AMBIENT TOM1	With large room ambience
29	* ROOM_T2	ROOM AMBIENT TOM2	With large room ambience
30	* ROOM_T3	ROOM AMBIENT TOM3	With large room ambience
31	* ROOM_T4	ROOM AMBIENT TOM4	With large room ambience
32	* POWR_T1	POWER TOM 1	With ambience

INST #	DISPLAY	INSTRUMENT NAME	COMMENT
33	* POWR_T2	POWER TOM 2	With ambience
34	* POWR_T3	POWER TOM 3	With ambience
35	* POWR_T4	POWER TOM 4	With ambience
36	* DOOM_T1	DOOM TOM 1	With effect
37	** CLSD_H1	CLOSED HIHAT 1	
38	** OPEN_H1	OPEN HIHAT 1	
39	PDAL_H1	PEDAL CLOSED HIHAT	
40	CRSH_C1	CRASH CYMBAL 1	
41	** MLLT_C1	MALLET CRASH CYMBAL	Can be used for rolling with mallet
42	** RIDE_C1	RIDE CYMBAL 1	
43	** RDBL_C1	RIDE - BELL CYMBAL 1	Mixture of bell and ride
44	BELL_C1	RIDE CYMBAL BELL	
45	808CLAP	808 HAND CLAP	Handclap of the TR - 808
46	* OPEN_D1	OPEN DRUM 1	Large drum voice without Mute
47	* TAIKO1	TAIKO 1	Japanese drum, "Taiko"
48	CLAVE1	CLAVE 1	
49	CABASA1	CABASA 1	
50	COWBEL1	COWBELL 1	
51	TAMBRN1	TAMBOURINE 1	
52	SHAKER1	SHAKER 1	
53	MUTE_CG	MUTE HIGH CONGA	
54	SLAP_CG	SLAP HIGH CONGA	
55	LOW_CG	OPEN LOW CONGA	
56	** SLID_CG	SLIDE LOW CONGA	With sliding manner
57	AGOGO1	AGOGO 1	
58	** OCT_AGG	OCTAVE AGOGO	
59	WHISTL1	WHISTLE 1	Short Whistle
60	WHISTL2	WHISTLE 2	Long Whistle
61	** CAN1	CAN 1	
62	** BACK_S1	BACK SNARE 1	Reverse of RVB_S1 (INST # 18)
63	BACK_T1	BACK TOM 1	Reverse of DOOM_T1 (INST # 36)
64	BACK_C1	BACK CYMBAL 1	Reverse of CRSH_C1 (INST # 40)
65	** SPARK1	SPARK 1	
66	** SURF	SURF	
67	** WHEEL1	WHEEL 1	
68	REST	REST	No sound (for mute or choke)

## Copy Instruments

COPY INST #	SOURCE INST #	DISPLAY	INSTRUMENT NAME	COMMENT
1	4	* DBLH_K3	DOUBLE HEAD KICK 3	
2	20	* RIMSHT3	RIMSHOT SNARE 3	
3	36	.DOOM_T2	DOOM TOM 2	
4	36	DOOM_T3	DOOM TOM 3	
5	37	** CLSD_H2	CLOSED HIHAT 2	Harder than CLSD_H1
6	37	** CLSD_H3	CLOSED HIHAT 3	Similar to CLSD_H1, but hit at a position Closer to the edge
7	38	** OPEN_H2	OPEN HIHAT 2	Can be used as halfopen
8	38	** OPEN_H3	OPEN HIHAT 3	Open sound similar to bell
9	40	CRSH_C2	CRASH CYMBAL 2	
10	40	CHOK_C1	CHOKED CRASH CYMBAL 1	Muted with a hand immediately after hit
11	40	SPLA_C1	SPLASH CYMBAL 1	
12	40	SPLA_C2	SPLASH CYMBAL 2	
13	45	DRYCLAP	DRY HAND CLAP	
14	46	* OPEN_D2	OPEN DRUM 2	
15	49	CABASA2	CABASA 2	
16	50	COWBEL2	COWBELL 2	
17	55	HIGH_CG	OPEN HIGH CONGA	
18	57	AGOGO2	AGOGO 2	
19	38	** PLATE	PLATE 1	
20	57	RING1	RING 1	
21	59	PIPE1	PIPE 1	
22	48	WBLOCK1	WOOD BLOCK 1	
23	48	WBLOCK2	WOOD BLOCK 2	
24	65	** THRILLR	THRILLER	
25	45	GUNSHT1	GUN SHOT 1	
26	52	SHADOW	SHADOW	

## 1. Manual Playing

You can try out a variety of sounds by playing it manually :

- Step 1** Check that the unit is connected to your amplifier or mixer, switch the unit on.
- Step 2** Raise the VOLUME slider.

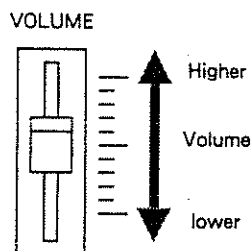

- Step 3** Simply tap each key ; all keys have different drum instruments. Depending on the strength of tapping, the volume varies. Instruments marked with "\*" (in the table shown on page 14) will vary in according to the tapping strength.

\*Tap the bottom of each key pad on the R-8 lightly, so that natural sound alteration (volume and tone) can be obtained. Hitting it with a drum stick will damage it.

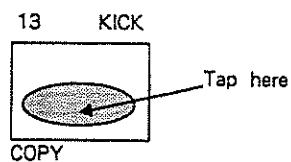

To obtain a Flam effect, hit a key pad while holding **FLAM** down.

To add a Roll effect, depress a key pad with **ROLL** held down : while the key pad is being pressed down, the relevant sound will keep playing as long as **ROLL** is held down.

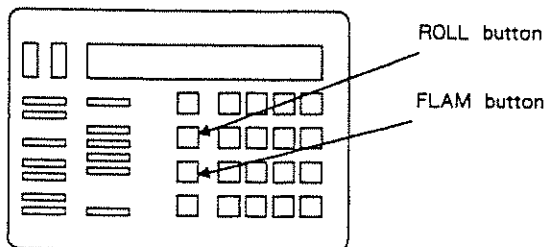

\* If you wish to change the interval for Flam/Roll, see page 86 and 88.

### Pad Bank Selection

Any of the 80 different Instruments can be assigned to each key pad. A Pad Bank is a set of Instrument assignments to the 16 key pads. The R-8 can store up to five Pad Banks (A to E). You can select any of those five Pad Banks.

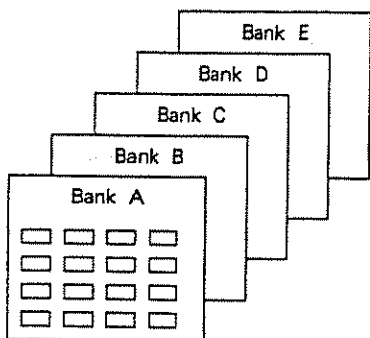

Procedure Press **PAD BANK** to change Banks.

The selected Pad Bank is shown in the display.

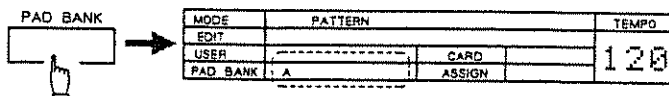

\*If you wish to change the Instrument assignment or play an instrument which is not assigned to any key pad, perform "Instrument Assignment" on page 40.

The five Pad Banks consist of the following instruments :

Bank A

CRSH_C1 (INT40)	CRSH_C2 (CPY09)	BELL_C1 (INT44)	RIDE_C1 (INT42)
DRY_T1 (INT24)	DRY_T2 (INT25)	DRY_T3 (INT26)	DRY_T4 (INT27)
SIDSTK1 (INT22)	RIMSHT1 (INT20)	CLSD_H1 (INT37)	OPEN_H1 (INT38)
DRY_K1 (INT01)	FAT_S1 (INT14)	PDAL_H1 (INT39)	808CLAP (INT45)

Bank B

CRSH_C1 (INT40)	CRSH_C2 (CPY09)	BELL_C1 (INT44)	RIDE_C1 (INT42)
ROOM_T1 (INT28)	ROOM_T2 (INT29)	ROOM_T3 (INT30)	ROOM_T4 (INT31)
BACK_S1 (INT62)	OUCH_S (INT17)	CLSD_H3 (CPY06)	OPEN_H2 (CPY07)
ROOM_K1 (INT07)	RVB_S1 (INT18)	PDAL_H1 (INT39)	COWBELL1 (INT50)

Bank C

CRSH_C1 (INT40)	CRSH_C2 (CPY09)	BELL_C1 (INT44)	RIDE_C1 (INT42)
POWR_T1 (INT32)	POER_T2 (INT33)	POWR_T3 (INT34)	POWR_T4 (INT35)
SIDTK2 (INT23)	RIMSHT2 (INT21)	CLSD_H1 (INT37)	OPEN_H1 (INT38)
DBLH_K2 (INT05)	IMPCT_S (INT15)	PDAL_H1 (INT39)	SPLA_C2 (CPY12)

Bank D

WBLOCK1 (CPY22)	WBLOCK2 (CPY23)	AGOGO1 (INT57)	AGOGO2 (CPY18)
LOW_CG (INT55)	HIGH_CG (CPY17)	SLAP_CG (INT54)	MUTE_CG (INT53)
TAMBRN1 (INT51)	SHAKER1 (INT52)	CABASA1 (INT49)	CABASA2 (CPY15)
OPEN_D1 (INT46)	CLAVE1 (INT48)	WHISTL1 (INT59)	WHISTL2 (INT60)

Bank E

CHOK_C1 (CPY10)	SPLA_C1 (CPY11)	RDBL_C1 (INT43)	MLLT_C1 (INT41)
DOOM_T1 (INT36)	DOOM_T2 (CPY03)	SPARK1 (INT65)	PLATE1 (CPY19)
BACK_C1 (INT64)	BACK_T1 (INT63)	SURF (INT66)	PIPE1 (CPY21)
WHEEL1 (INT67)	THRILLR (CPY24)	GUNSHT1 (CPY25)	SHADOW (CPY26)

INT: Internal Instrument  
 CPY: Copy Instrument

## 2. Demonstration Songs

Sample song programs are stored in your R-8. Do as follows to play the demo songs.

Step 1 Press **SONG**.



\*When the Menu Display is not shown, press **EXIT**.

Step 2 Press 1 in the Numerical Keys to select "PLAY".

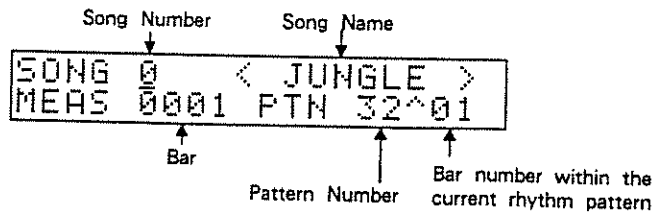

Step 3 Press 0 in the Numerical Keys to select song number 0.

\* **-1/OFF** **+1/ON** or VALUE slider can also be used for selecting a song.

Step 4 Press **START/STOP** to start playing.

The Tempo Indicator blinks in step with the playing song, and the display shows the current status of the demo playback.

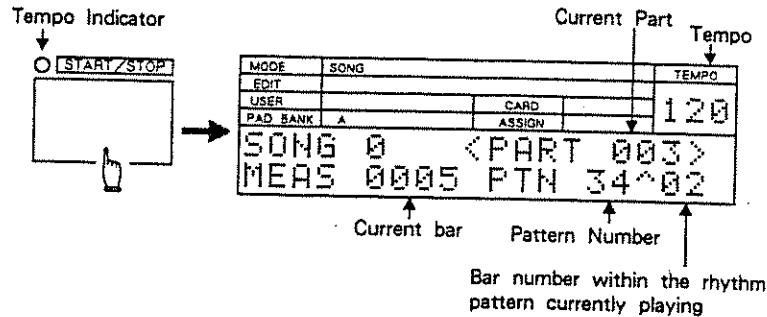

Step 5 Press **START/STOP** to stop playing.

Pressing **START/STOP** while holding **SHIFT** down will resume playing where it was stopped.



### Start/Stop using a Footswitch

By connecting a footswitch (optional DP-2) to the Start/Stop Jack at the rear of the unit, you can start or stop playing with the footswitch.

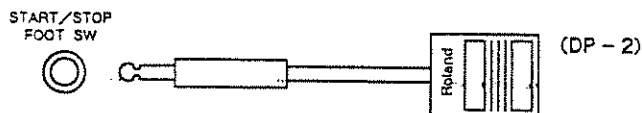

### Tempo Adjustment

To adjust the tempo, do as follows.

- Step 1 Press **TEMPO**.



- Step 2 Using **-1/OFF** **+1/ON** or the Numerical Keys, set the tempo (20 to 250).

Higher values quicken the tempo.

- Step 3 Press **TEMPO** to return to the previous display.

### Level Adjustment

To adjust the level of each Instrument, do as follows.

- Step 1 Press **LEVEL**.

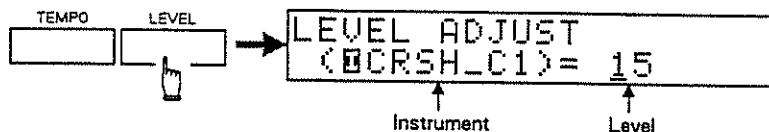

- Step 2 Press the key pad that correspond to the Instrument whose level is to be changed.

Change Pad Banks with **PAD BANK**, if necessary.

- Step 3 Using any of **-1/OFF** **+1/ON**, the VALUE slider, or the Numerical Keys, set the level (0 to 15).

Higher values increase the volume (At zero, no sound is produced).



### 3. Pattern Playing

A song is made of many rhythm patterns. Let's play some Preset rhythm patterns and User-programmed (in fact, preprogrammed from the manufacturer) rhythm patterns.

#### a. Playing Preset Patterns

In the R-8, 32 different rhythm patterns (Preset Pattern Numbers 00 to 31) are preprogrammed. Any Preset Rhythm Pattern cannot be used for writing a song, Unless it is copied to a User-Pattern with the Pattern Copy function (see page 121). Also, the copied pattern can be edited to make a different rhythm pattern.

Let's play a Preset Rhythm Pattern.

Step 1 Press **PATTERN** to turn to the Pattern Mode.

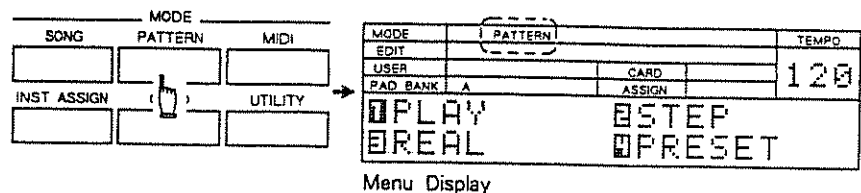

\*If the Menu Display does not appear, press **EXIT**.

Step 2 Press 4 in the Numerical Keys to select "PRESET".

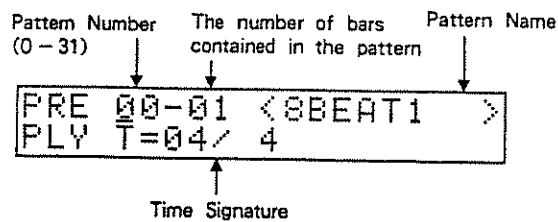

Step 3 Using **-1/OFF** **+1/ON**, VALUE slider or Numerical Keys, assign the Preset Number (0 to 31) you wish to play.

If you select a rhythm pattern made of more than one bar, you can start playing from the middle of the rhythm pattern.

Move the cursor to the Bar Number with **◀** and **▶**, then assign the bar number to start playing using **-1/OFF** **+1/ON**, VALUE slider or Numerical Keys.

Step 4 Press **START/STOP**, and the rhythm pattern is played repeatedly. To start playing from the assigned bar, press **START/STOP** while holding **SHIFT** down.

11 LETS PLAY

Step 5 Press **START/STOP** to stop playing.

Step 6 To play another Preset Pattern, repeat steps 3 and 4.

Step 7 Press **START/STOP** to stop playing.

\*To return to the Menu Display, press **EXIT**.

## b. Playing User-Patterns

User-patterns can be edited any time.

Now, let's play a user-pattern from the manufacturer (pattern numbers 00 to 31 are the same as the Preset patterns).

Step 1 Press **PATTERN** to turn to the Pattern Mode.

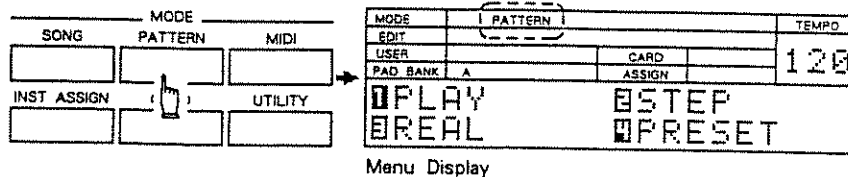

\*If the Menu Display does not appear, press **EXIT**.

Step 2 Press 1 in the Numerical Keys to select "PLAY".

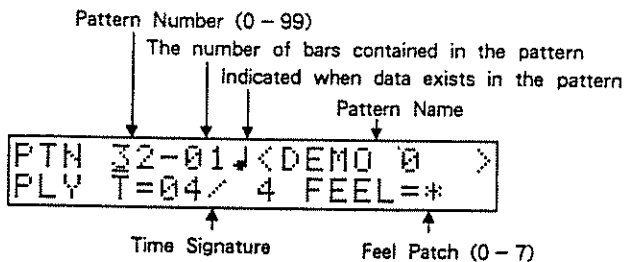

Step 3 Using **-1/OFF** **+1/ON**, VALUE slider or Numerical Keys, assign the Pattern Number (00 to 99) you wish to play.

If you select a rhythm pattern made of more than one bar, you can start playing from the middle of the rhythm pattern.

Move the cursor to the Bar Number with **◀** and **▶**, then assign the bar number to start playing using **-1/OFF** **+1/ON**, VALUE slider or Numerical Keys.

Step 4 Press **START/STOP**, and the rhythm pattern is played repeatedly.

To start playing from the assigned bar, press **START/STOP** while holding **SHIFT** down.

- Step 5** To play another User-Pattern, repeat step 3.  
The selected pattern number is shown in the display and played after the current pattern.

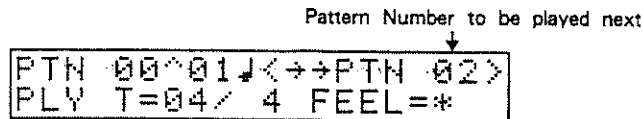

- Step 6** Press **START/STOP** to stop playing.

\*To return to the Menu Display, press **EXIT**.

### c. Feel Patch Assignment

Preset Rhythm Patterns contain rhythm patterns of past rhythm machine types, to demonstrate the effect of the Feel Patches. Feel Patches are not assigned to Preset Patterns, and therefore need to be copied to User-Patterns once.

- Step 1** Select a Preset pattern where you wish to assign a Feel Patch from the following pattern numbers.

Pattern Number	Type of the Rhythm Pattern
00, 01	8 beat type
04, 05	16 beat type
10, 11, 20	Triplet type

- Step 2** While holding **SHIFT** down, press Key pad 13 to enter the copying mode.

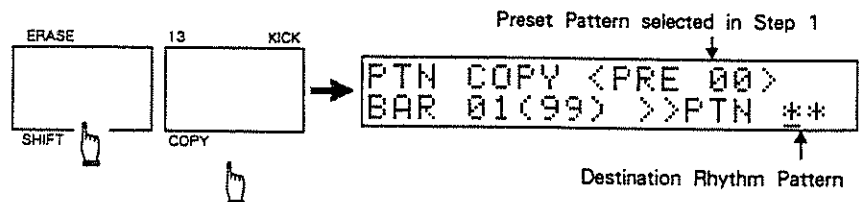

- Step 3** Select the destination rhythm pattern (User-Pattern 00 – 99), then press **ENTER**.  
Pressing **ENTER** will copy the source pattern to the selected destination pattern.

\*From the manufacturer, some demonstration rhythm patterns are preprogrammed in the User-Patterns. If you wish to retain these preprogrammed rhythm patterns, select a rhythm pattern number which contains no data.

Step 4 Press **EXIT** to return to the Menu Display.

Now, assign a preprogrammed Feel Patch to the copied User-Pattern.

Step 5 Press the Numerical Key 1, then assign the copied User-Pattern.

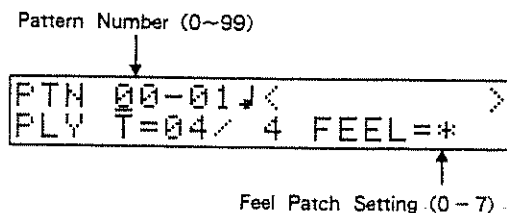

Step 6 Press **START/STOP** to listen to the rhythm pattern before assigning a Feel Patch. Press **START/STOP** to stop playing.

Step 7 Move the cursor to "FEEL" using **▶**, then select a Feel Patch with the Numerical Keys.

Select a Feel Patch that matches the rhythm pattern as shown in the table below.

Pattern Number	Feel Patch Number
00, 01	0, 1
04, 05	2 - 4
10, 11, 20	5 - 7

\*To retrieve the rhythm pattern where the Feel Patch was not yet assigned, lower the VALUE slider to the minimum, then set the Feel Patch setting to "\*".

Step 8 Press **START/STOP** to start playing.

Natural and realistic performance is obtained because of the Feel Patch.

Next, play the same rhythm pattern with a different Feel Patch.

Step 9 Stop playing, then take the similar procedure as step 7 to play the rhythm pattern with a different Feel Patch.

The rhythm will sound different from Step 8.

Now, you see that Feel Patches work to create natural and realistic rhythm performance and that the same rhythm pattern will sound drastically different by using different Feel Patches.

There will be much more different and effective ways to use the Feel Patches.

## 2 BEFORE WRITING RHYTHM DATA

### 1. Procedures for Rhythm Programming

#### a. Three Procedures

To create original rhythm data, take the following three procedures.

##### Instrument Setting

- The R-8 stores 68 different Instruments. It may be a good idea to assign the Instruments to each Pad Bank before making rhythm patterns.
- The tone of each Instrument can be changed by editing the Sound parameters. Also, apart from the 68 Instruments, 26 more Instruments can be created using the Copy Instrument function.
- Using a Sound ROM card (optional), you can extend 26 more Instruments.

##### Pattern Write

- Pattern Write makes rhythm patterns which will later be used for combining into song data.
- Up to 100 rhythm patterns can be stored in the unit. Each rhythm pattern can have up to 99 bars.
- There are two methods for programming a rhythm pattern; Step Writing, in which the timing of sounds to be produced is determined one step at a time, and Real-time Writing, which is programming a rhythm by actually playing the key pads.
- The programmed rhythm patterns can be later edited using the range of Editing functions.

##### Song Write

- You can create data for use in performance (a song) by combining rhythm patterns you have made in Pattern Write.
- In a Song, a repeat mark, tempo and level change data, which is called a Part, can be appended with each rhythm pattern.
- Up to 10 Songs can be stored in the unit. Each song can have up to 999 Parts.
- For quicker song programming, use Delete, Insert and Copy functions, etc.

## b. How to carry out Rhythm Programming

The R-8 features a great many functions and some of them may be unfamiliar to you. Some of you might feel lost and know not where to begin.

The following are three courses for rhythm pattern and song writing. Follow any course you like. To master the basic procedures for the R-8, follow all three courses.

The following three courses, however, do not include all the functions of the R-8. To make the best use of the R-8, read the owner's manual thoroughly.

The indexes (to functions and terminology) at the back of this owner's manual may be useful for accessing the function you want.

### 【Course 1】

Make a song using only the Preset or preprogrammed rhythm patterns.

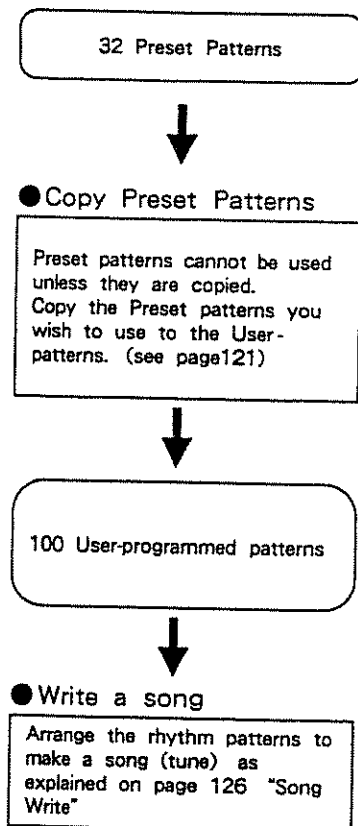



**[Course 2]**

Make a song using not only preset rhythm patterns but also your original rhythm patterns.

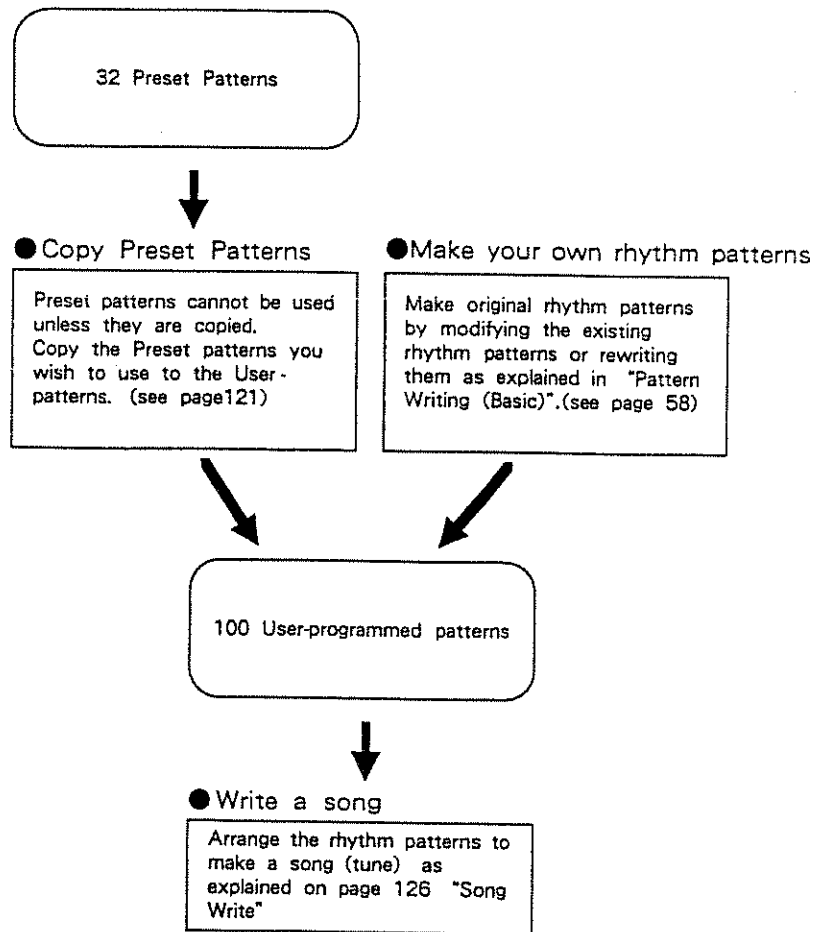

**[Course 3]**

Make a song with the Human Feel functions or Edit Functions.

➔ Procedure

➔ Editing procedure

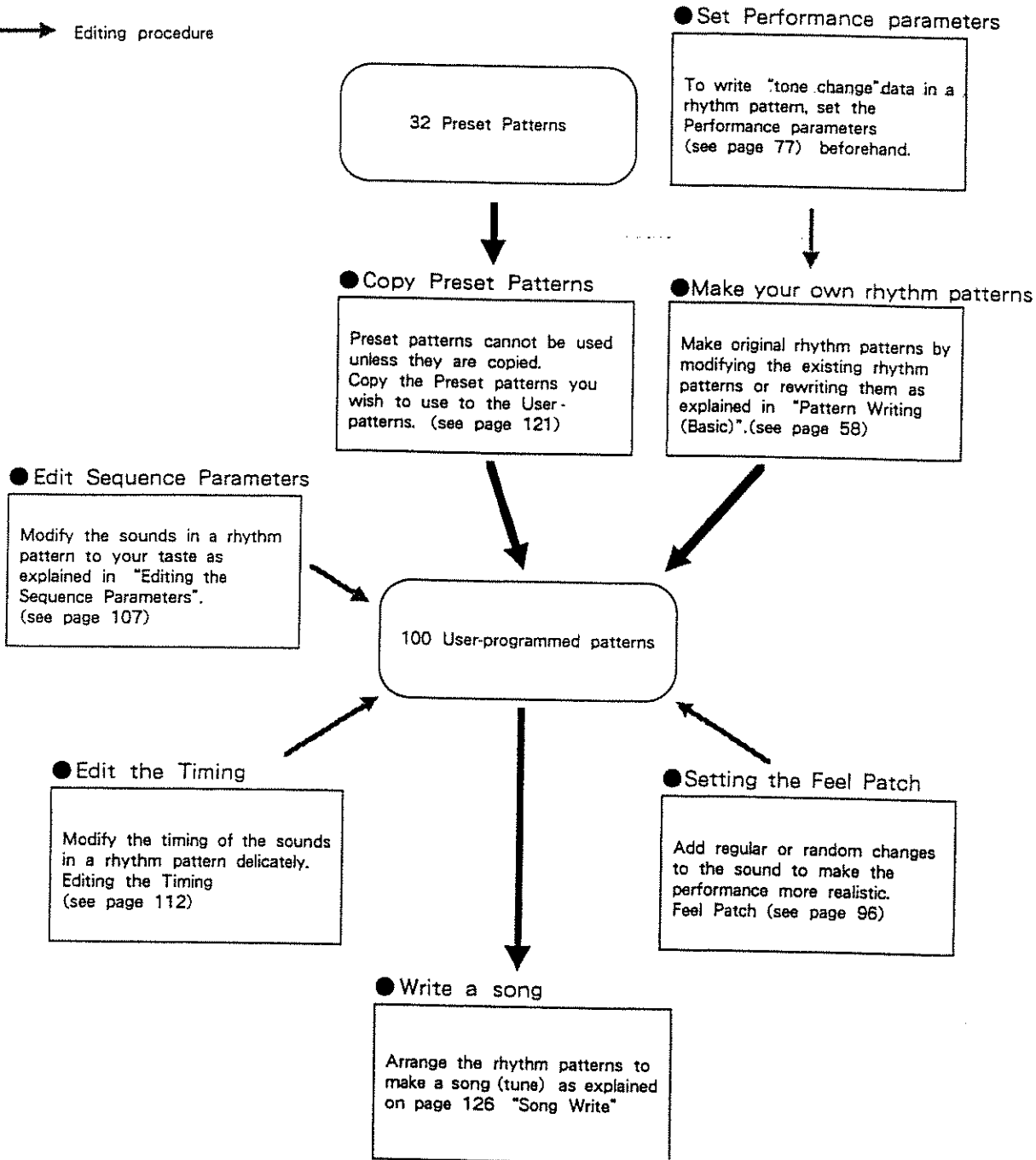

## 2. The R-8's Nine Modes

The R-8 has the following modes; six Main modes and three Edit modes.

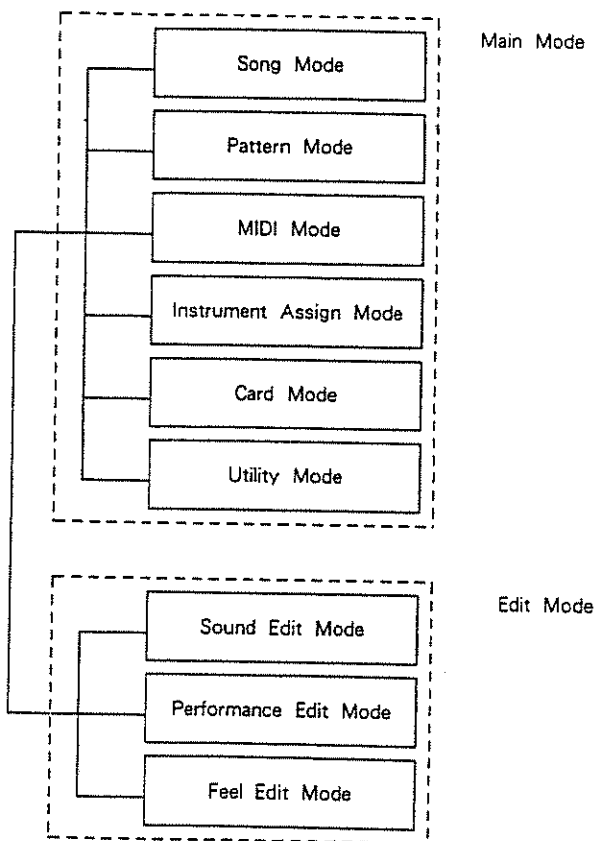

When the R-8 is on, it is set to one of the six Main modes. The Edit modes are of temporary status, so they can be reached from a Main mode at any time.

## Main Mode

### ● Song Mode

This mode is for playing, writing and editing Songs.

### ● Pattern Mode

This mode is for playing, writing and editing Rhythm Patterns.

### ● MIDI Mode

Select this mode to set MIDI parameters when using an external MIDI sound module or using the R-8 as a MIDI sound module.

### ● Instrument Assign Mode

This mode is used for assigning an instrument to each key pad or specifying instruments to be indicated in the Graphic display.

### ● Card Mode

This mode allows you to save data in the internal memory onto a memory card (RAM) or load data from an optional sound ROM card.

### ● Utility Mode

This mode allows you to check the remaining memory capacity or erase all song or rhythm pattern data.

## Edit Mode

### ● Sound Edit Mode

This mode is for setting how each Instrument is to be played, by editing Pitch, Nuance, Sense Curve, Assign Type, Decay and Output Assign parameters.

### ● Performance Edit Mode

This mode allows you to set how the Instrument plays for each key pad, by editing Pitch, Decay, Nuance and Pan parameters.

### ● Feel Edit Mode

This mode is for setting the Feel Patch.

### 3. Basic Procedures

Proceed with the R-8's basic operations in the following order. It is very important to understand this before actually moving into each operation section.

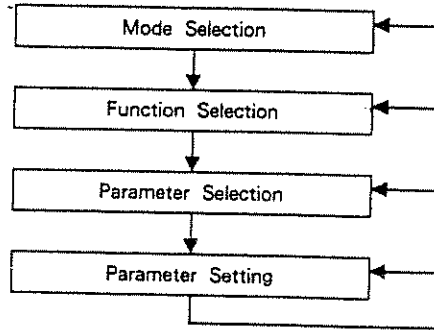

#### 1) Mode Selection

Select an appropriate Mode.

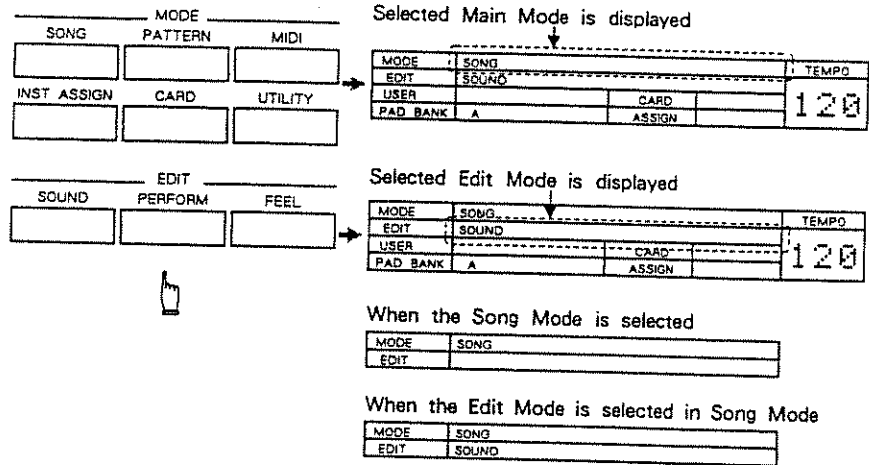

- Use an appropriate MODE button (SONG, PATTERN, MIDI, UTILITY, CARD or INST ASSIGN), for selecting a Main Mode (without rhythm playing).
- Use an appropriate Edit button (SOUND, PERFORM or FEEL), for selecting an Edit Mode. To return to the Main Mode, press the same EDIT button or any MODE button.

#### 2) Function Selection

Select a function you want.

- The Menu Display appears on selecting a mode.

Menu Display of the Song Mode

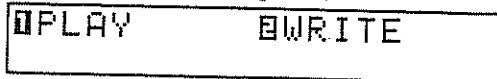

② BEFORE WRITING RHYTHM DATA

\*When a Menu Display does not appear, press **EXIT**. If a Main Mode is selected, pressing the same MODE button will call a Menu Display just the same.

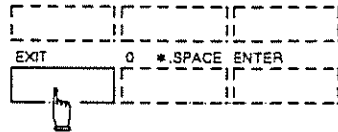

● A Menu Display shows the function names which are available in the current Mode.

Some Modes may have more than one page of menu display. If so, "→" is shown at the right corner of the display, and you can shift the menu displays using **PAGE**.

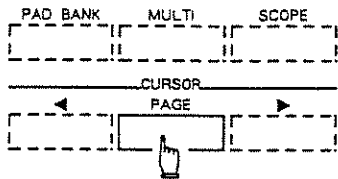

Indicated when another Menu Display follows.

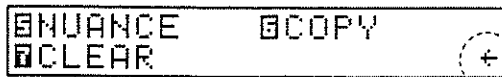

Indicated at the last Menu Display.

● Using the Numerical Keys, specify the number shown at the left of the function name, to change to the function setting display.

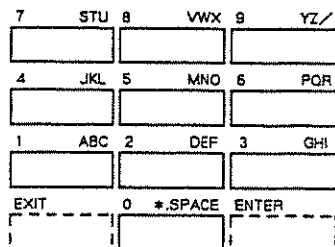

\*You can specify functions which reside in other pages of menu displays (those is not shown in the current menu display).

● To select another function that belongs to the same Mode, press **EXIT** to return to a Menu display.

- The Song Mode and Pattern Mode feature functions (Shift Functions) which are not shown in the Menu Display. Shift functions are written under each key pad. To use a Shift function, with the unit stopped, tap the relevant key pad while holding **SHIFT** down.

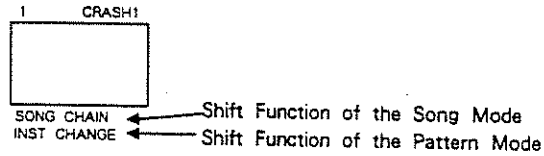

**3) Parameter Selection** Select the parameter you want from the function in use, as follows.

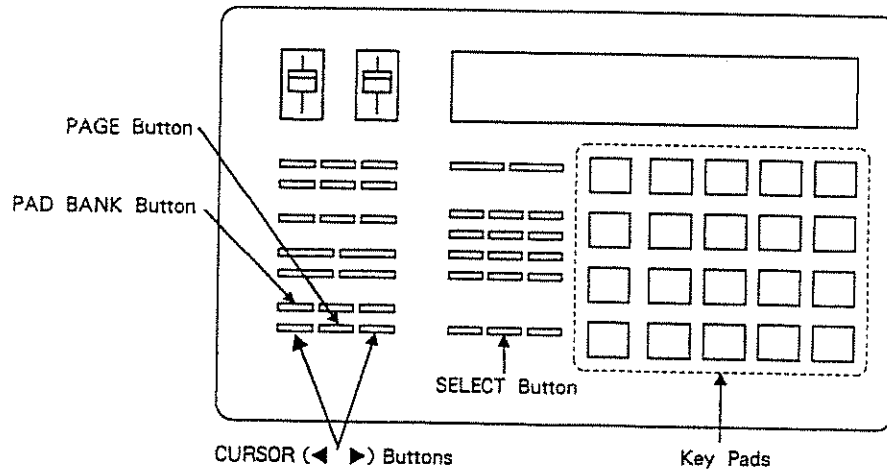

- **PAGE** Some Functions have more than one page of displays. When a function has more than one page, "→" is shown at the right corner of the display, and you can shift pages using **PAGE**.
- **◀ ▶** (Cursor Buttons) When more than one parameter is shown in the display, you can move the cursor (underline character) to the value of the relevant parameter using **◀** or **▶**.
- **SELECT** When "\$" is shown at the left of a parameter, pressing **SELECT** will change parameters.
- **PAD BANK** / Key Pad Use this for selecting an Instrument or writing rhythm patterns.

4) Parameter Setting The value of a parameter can be edited as shown below.

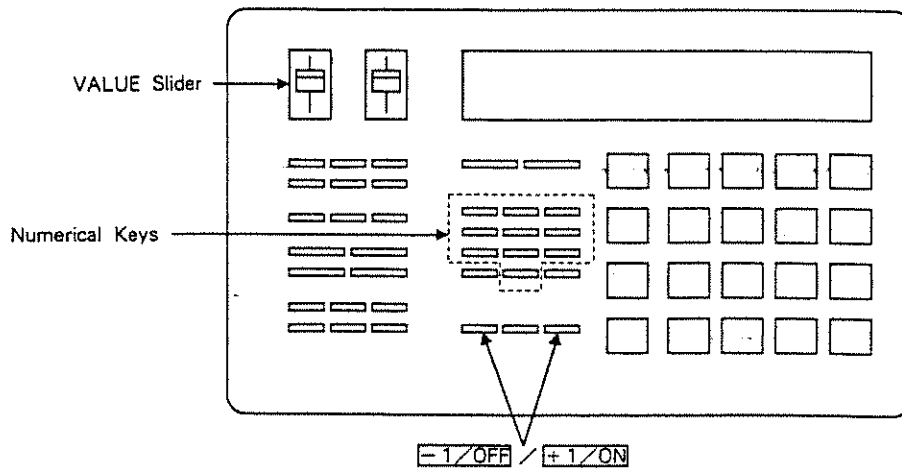

● **-1/OFF** **+1/ON**

Use these buttons to make precise changes in value.

**+1/ON** increases values, while **-1/OFF** decreases them.

While holding **+1/ON** (**-1/OFF**) down, press **-1/OFF** (**+1/ON**) to quicken the value changes.

● VALUE Slider

Use this to change values drastically.

● Numerical Keys

Use these to enter numbers and letters; or to set beat or Quantize values. When you enter a number, put 0 instead of leaving it empty.

< Ex. >

To change from 123 to 15, enter 015 instead of just 15.

To change 13 to 3, enter 03 instead of just 3.

To set a beat or Quantize, the following values can be entered using Numerical Keys 1 to 9.

7	STU	8	VWX	9	YZ/
1/32	1/48	HIGH (1/96)			
4	JKL	5	MNO	6	PQR
1/12	1/16	1/24			
1	ABC	2	DEF	3	GHI
1/4	1/6	1/8			

\*Parameters whose values are enclosed with the \* marks (Ex. \*POLY\*) cannot be entered with the Numerical Keys.



Indications shown in the display have the following meanings :

Mode	Display	Description
Function Selecting Parameter Selecting	⇄ ⇄ Lower right corner or upper right corner	The display changed with [PAGE]. → shift to the next display. ← shift to the first display.
Parameter Selecting	⌘ Parameter Name	Pressing [SELECT] changes the parameters.
Parameter Setting	* Value *	The value cannot be entered with Numerical keys.
	*:*:	The value is not set or cannot be set.
Instrument Selecting	(Instrument Name)	Specify the instrument with a Key Pad.
Rhythm Pattern Display	PTN00-00	Pattern number and the number of bars contained.
	PTN00^00	Pattern number and current bar.
	PTN00...00	Pattern number and the bar number that can be written (in the step writing).
	PTN00-00↓	Data is written in the pattern number currently shown.
	PTN00-00*	No data exists in the pattern number currently shown.
Song Writing	?	No data is written in the selected part. Or the data currently shown in the display is not yet written in the Part.



# INSTRUMENT SETTINGS

**1** Instrument Assignment P. 40

**2** Setting Sound Parameters P. 47

# 1 INSTRUMENT ASSIGNMENT

This section explains about the Instrument Assignment to each key pad, how to use a ROM card and how to set the Instrument to be shown in the Graphic Display.

## 1. Instrument Assigning

To each key pad, you can assign one of the 68 instruments, 26 instruments on a Sound ROM card or 26 Copy Instruments (see page 54).

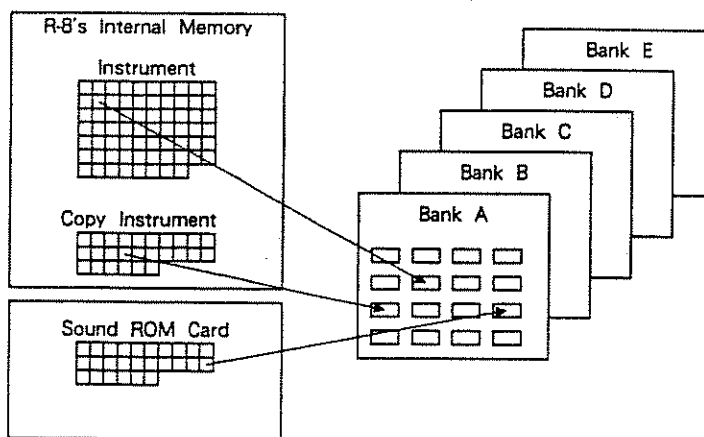

\*When you are using instruments on a Sound ROM card, read the next chapter "How to use a Sound ROM card", then follow the procedure.

\*Even after you have edited the original instrument assignment (preset from the manufacturer), it can be restored at any time with the Instrument Assign Initialize procedure (see page 158).

Step 1 Press **INST ASSIGN** to turn to the Instrument Assign Mode.

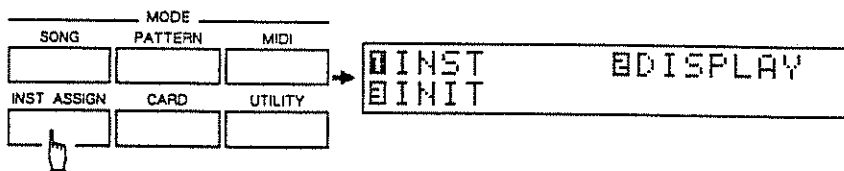

\*If the Menu Display is not shown, press **EXIT**.

Step 2 Press Numerical Key 1 to select "INST".

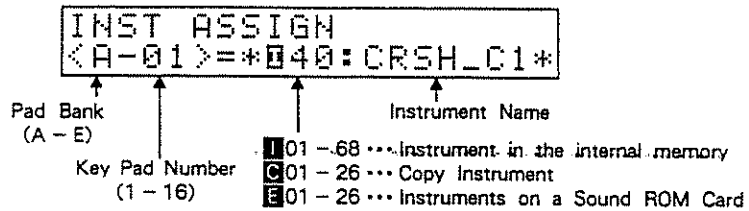

\*If the key pads are set to Multi Assign (see page 81), the display will respond as shown below. Turn to the Instrument Assign mode by pressing **MULTI**.



Step 3 Select a Pad Bank with **PAD BANK**.

Step 4 Tap the key pad for which you wish to change the assignment.

Step 5 Using **-1/OFF** **+1/ON** or VALUE slider, specify the instrument to be assigned.

\*You can assign the same instrument to more than one key pad.

\*If you have assigned an instrument on a ROM card without connecting the relevant card, " \* **E** 01 : CARD01 \*" is displayed.

Step 6 To continue, and edit the other Banks, repeat steps 3 to 5.

Step 7 Press **EXIT** to return to the Menu Display.

**How to use a Rest** Instrument number 68 has no sound data (rest). Using the Rest, you can create a choking gate, or mute effect.

**Procedure** Set the Assign Type (see page 50) of the Rest and the instrument to the same EXC number. Then play the Rest (assigned key) right after the instrument. In this way, the instrument is muted in the middle.

< Ex. > **Choking effect** : hitting a crash cymbal then muting it with your hand.  
**Gate Snare** : Cutting the snare's reverberation with gate.

\*The muting effect using the Rest can be written in a rhythm pattern, then it will be performed (muted) at the right timing according to the tempo.

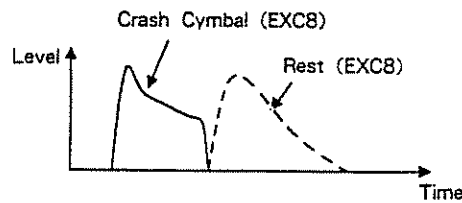

## Brush Roll Performance

To use the Brush Roll on the optional Sound ROM card :

●Set the Assign Type (see page 50) of the Roll Brush sound to any of the EXC numbers.

By entering Roll Brush sounds continuously, the sustained sound of the Brush Roll is muted, effecting Brush Roll performance.

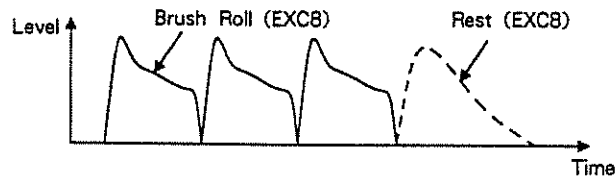

\*By setting the Assign Type of the Brush Roll and the Rest (Instrument Number 68) to the same EXC number, then entering a Rest right after the last sound, the last Brush sound will also be muted.

●Brush Roll sound is a slow rising sound, and therefore will be played rhythmically by shifting the overall timing forward with "Macro Timing Shift" (see page 112), or "Micro Timing Shift" (see page 113).

## 2. How to use a Sound ROM Card

Using an optional Sound ROM card, you can extend 26 more Instruments.

### Playing the Demonstration Song on the Sound ROM card

A Sound ROM card contains some demonstration songs. To play these songs, do as follows.

\*Loading demonstration songs into R-8's internal memory will erase any current song and rhythm pattern data stored in the R-8.

- Step 1 Connect the ROM card to the ROM Card Slot securely (so that it clicks).

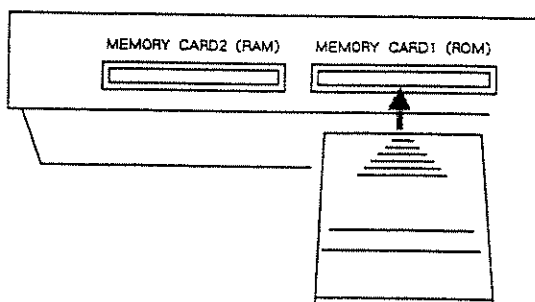

- Step 2 Press **CARD** to turn to the Card Mode.

```

LOAD RAM  SAVE RAM
FORMAT    LOAD ROM
    
```

- Step 3 Press Numerical Key 4 to select "LOAD ROM".

```

LOAD ROM CARD
LOAD ROM
    
```

- Step 4 Press Numerical Key 2 to select "SOUND & DEMO".

```

LOAD ROM SOUND&DEMO
Are you sure ?
    
```

\*Press **EXIT** if you want to leave the mode.

- Step 5 Press **ENTER**.

The message "Loading" appears showing that the demonstration songs are now being loading.

- Step 6 Assign Song Number 0 in the Song mode, then press **START/STOP** to start playing.

**Loading a ROM Card** When using a brand new ROM card, you need to perform the ROM Card Loading procedure so that the R-8 can recognize the specified ROM card. By loading the ROM card, instruments on the ROM card can be used.

Also, when switching ROM cards, load each ROM card. The instruments on the ROM card cannot be used unless they are loaded to the R-8.

\*While using any instrument on a ROM card, keep the ROM card connected to the R-8.

\*If you load the ROM card after editing the Sound parameters of the Instrument on the ROM card, the Sound Parameters of the Instrument (on the ROM card) will return to the previous values before any editing was made. To retain the original data being edited, save it onto a RAM card (see page 165).

\*The loaded data of a ROM card can be written on a RAM card. When you use a RAM card that contains a ROM card's data, you do not need to re-load the ROM card.

● To use a brand new ROM card

When you use a brand new ROM card, insert the ROM card with the R-8 switched off, then switch it on. In this way, the ROM card will be automatically loaded.

When the loading is completed, Card Number 1 is displayed.

MODE	PATTERN		TEMPO
EDIT			
USER		CARD	1
PAD BANK	A	ASSIGN	120



●To exchange a ROM card follows :

To replace the ROM card with another one, load the ROM card as follows :

Step 1 Connect the ROM card to the ROM Card Slot securely (so that it clicks).

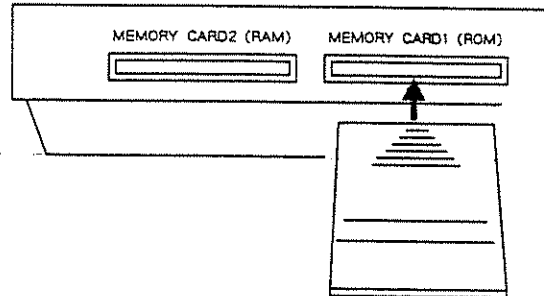

Step 2 Press **CARD** to turn to the Card Mode.

```

LOAD RAM  SAVE RAM
FORMAT    LOAD ROM
    
```

Step 3 Press Numerical Key 4 to select "LOAD ROM".

```

LOAD ROM CARD
LOAD ROM
    
```

Step 4 Press Numerical Key 1 to select "SOUND".

Name of the ROM card previously loaded

```

LOADED=<          >
LOAD <          > OK?
    
```

Name of the connected ROM card

\*If the card is not correctly connected, the display responds with "Card not ready".

If this happens, remove the card, reinsert it properly, then repeat the procedure.

\*If the connected ROM card is not the specified one, the display responds with "Illegal card". If this happens, remove the card, insert a proper card, then repeat the procedure.

\*Press **EXIT** if you want to leave the mode.

Step 5 Press **ENTER**.

"Completed" appears in the display showing that the loading is done. When the loading is completed, the display shows Card Number 1.

MODE	CARD		TEMPO
EDIT			
USER		CARD 1	120
PAD BANK A		ASSIGN	

### 3. Display Assign

According to the mode currently selected, the Graphic Display shows the rhythm pattern, level and pan setting of the instruments you specified.

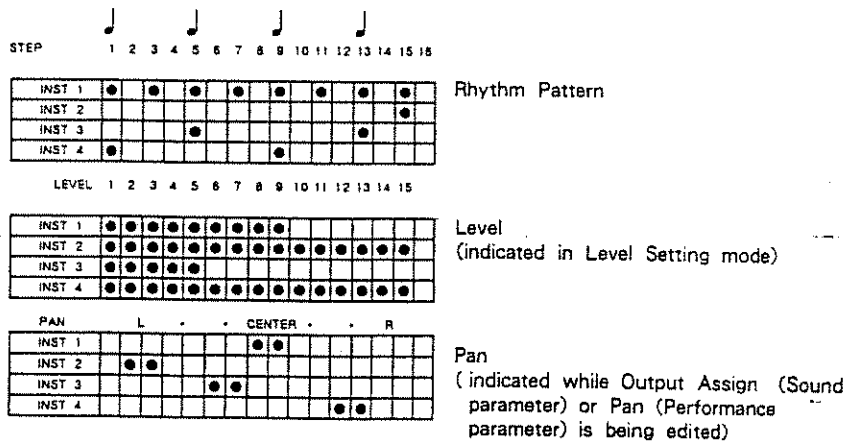

The instruments shown at INST 2 to 4 can be changed as follows.

\*INST 1 displays the last instrument specified in Step Writing.

Step 1 Press **INST ASSIGN** to turn to the Instrument Assign mode.

Step 2 Press Numerical Key 2 to select "DISPLAY".

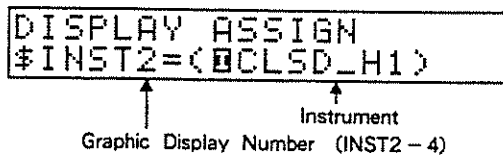

Step 3 Specify INST 2 to 4 shown in the graphic display with **SELECT**.

Step 4 Press the key pad that corresponds to the instrument to be assigned.

Step 5 Press **EXIT** to return to the Menu Display.

## 2 SETTING SOUND PARAMETERS

Each Instrument's (rhythm voices) tone can be edited to your taste. Up to 26 edited versions of Instrument data can be registered as a Copy instrument.

The following parameters are involved for instrument editing.

Display	Parameter
PITCH	Pitch
DECAY	Decay
NUANCE	Nuance
OUTPUT	Output Assign
ASSIGN	Assign Type
CURVE	Sense Curve

\*Pitch, Decay, Nuance and Output Assign can be edited separately for each key pad using performance parameters (see page 77).

### 1. Description of Sound Parameters

#### a. Pitch (-4800 to +4800cent)

```
SOUND EDIT(OVERRIDE_C1)
$PITCH = 0000
```

The pitch of each instrument can be set in 10 cent steps. Higher values increase the pitch (semitone = 100 cents).



\*Some instruments will not become higher or lower than a certain pitch.

b. Decay (000 to 127)

```
SOUND EDIT(BRIDE_C1)
$DECAY = 050:050
```

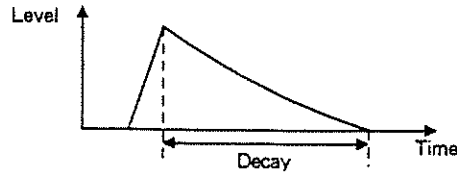
This sets the decay time of the instrument. Higher values make the decay time longer.



An Instrument which can accept Nuance (see next page) allows you to set two different decay times. Two values are shown in the display so that you can set each of them by moving the cursor with  and .

- An Instruments marked with "\*" on page 14, such as kick drum, snare drum and tom, allow you to set the decay time individually for the attack sound content (higher frequency content: the value shown left) and the shell resonance content (lower frequency content: the value shown right). Therefore, the snare on a snare drum or muting condition of a tom - tom can be controlled.

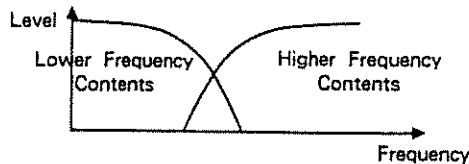

- Hihat or Ride Cymbal with the "\*" mark allows you to set the decay times individually for the sound created by hitting the inner part of the cymbal (the value at the right) and the outer part of the cymbal (the value at the left).

The sound can be delicately controlled by setting the decay times for the inside and outside of a cymbal.

Hitting inside

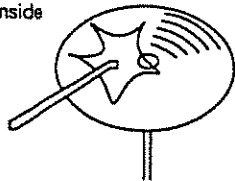

Hitting outside

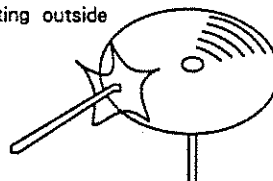

\*Decay time of some instruments cannot be set longer or shorter than a certain value.

\*Decay time does not change in reversed type instruments.

c. Nuance (0 to 15)

```
SOUND EDIT( BRIDE_C1 )
#NUANCE= 08
```

The nuance of an Instrument marked with the "\*" or "\*" \* " mark (in the table shown on page 14) can be changed using the Nuance parameter.

- In an Instrument with the "\*" mark, lower frequency sounds will be increased by raising the value.
- In Hi-hat or Ride Cymbal with the "\*" \* " mark, higher values represent sound created by hitting closer to the center of the cymbal.

\* Instruments for which Nuance cannot be set will show "--" instead of the value.

d. Output Assign

(LEFT 1 to 3, CENTER, RIGHT 1 to 3, MULTI 1 to 8)

```
SOUND EDIT( DRY_K1 )
#OUTPUT=*CENTER*
```

This selects the output jack (Stereo out/Multi out 1-8) that outputs each instrument. When stereo outputs are being used, one of the 7 panning levels can be selected.

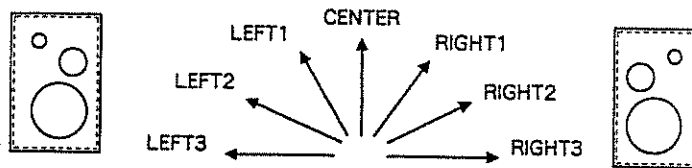

When Stereo Output is assigned, the set pan level is shown in the graphic display.

PAN	L	CENTER	R
INST 1			● ●
INST 2		● ●	
INST 3		● ●	
INST 4	● ●		

LEFT2    CENTER    RIGHT3

You can make INST 2 to 4 show the data of any Instrument you like. To change the Instruments, take the Display Assign procedure (see page 46). INST 1 shows the last instrument specified in the Step Writing.

e. Assign Type (Poly/Mono/EXC 1 to 8)

```
SOUND EDIT( DRY_K1 )  
$ASSIGN=*POLY*
```

When more than one instrument or the same instrument are played simultaneously, this parameter determines how the instruments should play.

●POLY

This is effective for playing a long decay sound like a cymbal continuously without cancelling sounds each time it is played.

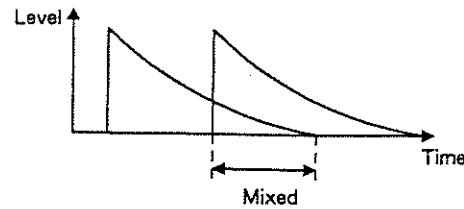

●MONO

If a long decay instrument is played continuously, every time it is played the decay will be cut.

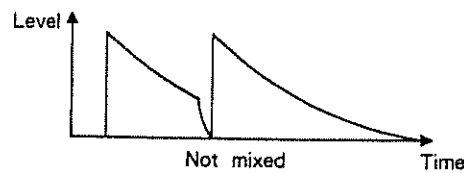

●EXC 1 to 8

The instruments which are set to the same EXC numbers cannot be played at the same time. Set two instruments (such as open and closed hihats) which are not normally played simultaneously to the same EXC number.

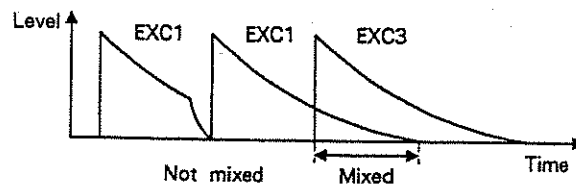

f. Sense Curve (1 to 8)

```
SOUND EDIT(DDRY_K1 )
$CURVE = 2
```

This selects one of the eight Sense Curves that determine tone and volume changes caused by tapping the key pads.

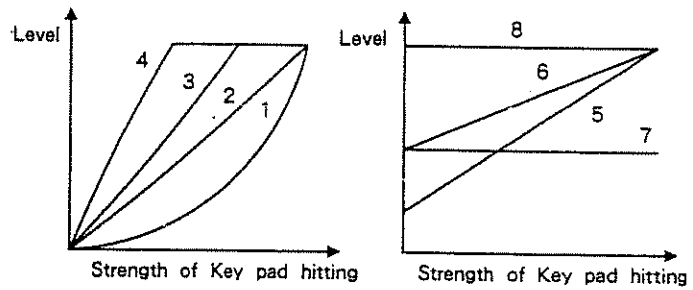

## 2. Editing Procedure

The following editing procedure can set the Sound parameters of the Instrument assigned to key pads.

\*When the instrument you wish to edit is not assigned to any Key pad, assign it to a Key pad using the Instrument Assign procedure (See page 40). To use an instrument from an optional Sound ROM card, take the same procedure.

\*Even after editing Sound parameters, you can initialize them (restore the data preprogrammed from the manufacturer). See page 159 "Initializing Sound Parameters".

Step 1 Press **SOUND** to turn to the Sound Edit Mode.

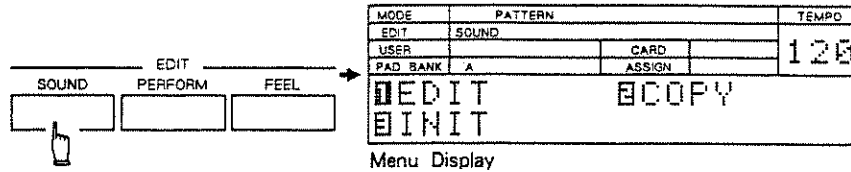

\*If the Menu Display is not shown, press **EXIT**.

Step 2 Press Numerical Key 1 to select "EDIT".

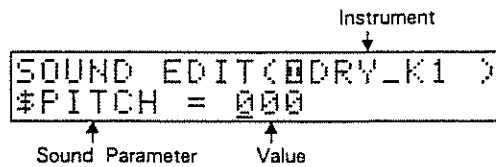

Step 3 Tap a key pad that corresponds to the instrument to be edited. Switch the Pad Banks with **PAD BANK**, if necessary.

\*If you have assigned an instrument on a ROM card without connecting the relevant card, "E CARD01" is displayed.

Step 4 Select a parameter with **SELECT**.

Pressing **SELECT** calls parameters in sequence as shown below.

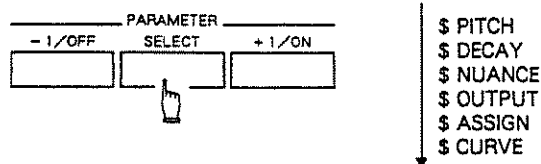



Step 5 Using   or VALUE slider, change values (Monitor the sound by tapping the key pads).

\*Parameters other than Output Assign and Assign Type can be entered with the Numerical Keys.

Step 6 To continue, and edit the other parameters, repeat steps 4 and 5.

Step 7 To continue, and edit the other instruments, repeat steps 3 to 6.

Step 8 Press  to return to the previous display.



- Step 5 Press **ENTER** .  
 "Completed" appears in the display showing that the instrument is registered as a Copy Instrument.
- Step 6 Press **EXIT** to return to the Menu Display.
- \*When you have copied an instrument on a Sound ROM card to a Copy Instrument number, keep the card connected.

### Naming a Copy Instrument

A Copy Instrument can be named using up to 7 letters.

With the unit set to the Sound Edit Mode, do as follows :

- Step 1 In the Menu display, Press Numerical Key 2 to select "COPY".
- Step 2 Press **PAGE** to cause the display to change for naming instruments.

```

EDIT COPY NAME
*COPY01*= <DBLH_K3>←
    
```

↑  
Name of the Copy Instrument

- Step 3 Using **-1/OFF** **+1/ON** or VALUE slider, specify the Copy Instrument number (COPY 01 to 26) to be named.
- Step 4 Move the cursor to the position with **◀** and **▶**, you wish to change, then change numbers/letters/symbols using **-1/OFF** **+1/ON**, VALUE slider or Numerical Keys.  
 Pressing a Numerical Key also switches the number and letter/symbol mode alternately. Pressing the Numerical Key while holding **SHIFT** down will produce lowercase letters.
- Step 5 Press **EXIT** to return to the Menu Display.



# RHYTHM PATTERN PROGRAMMING

<b>1</b>	Pattern Writing (Basic)	P. 58
<b>2</b>	Pattern Writing (Advanced)	P. 77
<b>3</b>	Feel Patch	P. 96
<b>4</b>	Rhythm Pattern Editing	P. 107

# 1 PATTERN WRITING (Basic)

Up to 100 different rhythm patterns (each consisting of up to 99 bars) can be programmed in the R-8.

\*The R-8's memory capacity is limited. It may not allow you to program 100 rhythm patterns if they consist of many steps and/or bars.

To check how many more rhythm patterns can be written into memory, use the Available Memory function (see page 152).

There are two ways of writing patterns :

## Real-time Writing

We can write rhythm patterns by tapping the key pads in time to the metronome. The Quantize function can correct timing inconsistency in rhythm pattern writing.

## Step Writing

Enter the timing (a step) for each instrument. This method may be suitable for those who are not good at Real-time writing.

You can use both methods for writing one rhythm pattern. For instance, you may write a basic rhythm pattern in Step time, then add some more sounds in Real-time. Or you may make a rhythm pattern in Real-time then modify it using the Step Writing.

# 1. Default Settings for Pattern Writing

Before writing rhythm patterns either in the Step time or Real-time, take the following procedure.

Step 1 Press **PATTERN** to turn to the Pattern Mode.



\*If the Menu Display is not shown, press **EXIT**.

Step 2 To select Real-time writing, press Numerical Key 3, and to select Step writing, press Numerical Key 2.

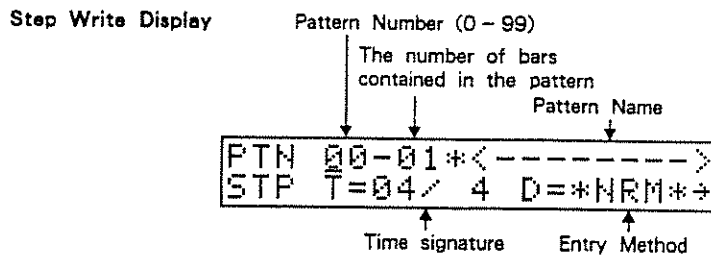
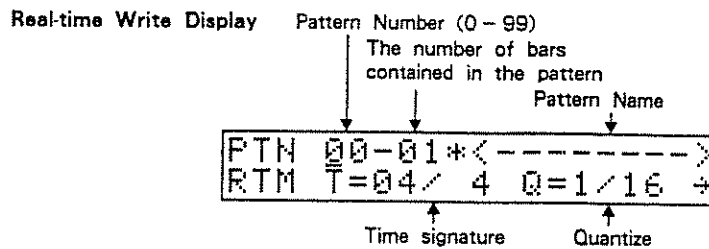

Step 3 Using **-1/OFF** **+1/ON**, VALUE slider or Numerical Keys, select a pattern number (00 to 99).

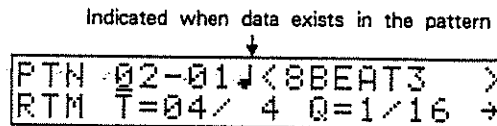

If you wish to erase the entire rhythm pattern, specific instrument go to step 4 and/or 5. Otherwise, move to the Real-time Writing (page 61) or Step Writing (page 65).

Step 4 While holding **SHIFT** down, tap key pad 14.

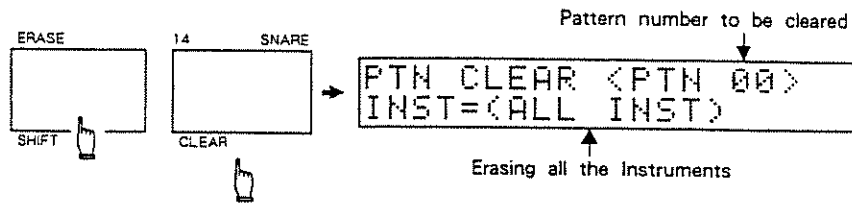

\*If no performance data is written in the selected rhythm pattern, the Measure/Time setting display appears. Skip step 5 and go to step 6.

Step 5 Erase unneeded Instruments.

● To erase all the instruments, press **ENTER**.

The Measure/Time setting display appears, so that you can continue to step 6.

● To erase specific Instruments, tap the key pads that correspond to the Instruments, then press **ENTER** (The names of the specified Instruments are shown).

The Pattern Write display appears, so that you can move to Step writing (page 65) or Real-time writing (next page).

\*To leave the mode, press **EXIT**.

Step 6 Using **-1/OFF** **+1/ON**, VALUE slider or Numerical Keys, set the number of bars (00 to 99) to be used in the pattern.



Step 7 Set the Time Signature of the rhythm pattern.

Move the cursor to the time signature with **◀** and **▶**, then specify the timing using **-1/OFF** **+1/ON**, VALUE slider or Numerical Keys.

(Variable Range : 1-8/4, 1-12/6, 1-16/8, 1-24/12, 1-32/16, 1-48/24, 1-64/32)

Step 8 Press **ENTER** to return to the display of step 2.

Go to Step writing (page 65) or Real-time writing (next page).

\*If you switch off the unit during Pattern writing, the data you have written may be erased.



## 2. Real-time Writing

Take the following procedure after the "Default Settings for Pattern Writing" procedure (page 59).

\*In the Real-time writing mode, you can use the metronome, preset by the manufacturer, to play in quarter note timing with Real-time writing. To change the metronome settings, see page 63.

### Quantize

The Quantize function can correct the timing of the key pad tapping according to the set resolution. If you wish to write data in the timing of key pad tapping, set resolution to HIGH.

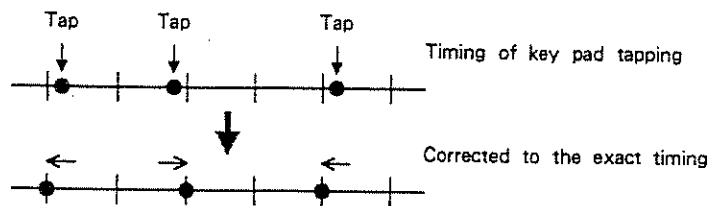

To change the Quantize setting, do as follows with the unit set to the Real-time writing mode.

\*The Quantize values can also be changed during Real-time writing. In this case, the edited quantize value is in effect from the next bar.

Step 1 Move the cursor to the Quantize value with and .

```
PTN 00-01* <----->
RTM T=04/ 4 Q=1/16 +
```

↑  
Quantize value

Step 2 Specify the Quantize value using 1/OFF 1/ON, VALUE slider or Numerical Keys 1 to 9.

(The variable range: 1/4, 1/6, 1/8, 1/12, 1/16, 1/24, 1/32, 1/48, HIGH = 1/96 notes)

### Real-time Writing

Now, let's enter Instruments with Real-time Writing.

Step 1 Press **START/STOP** to start playing the rhythm pattern.

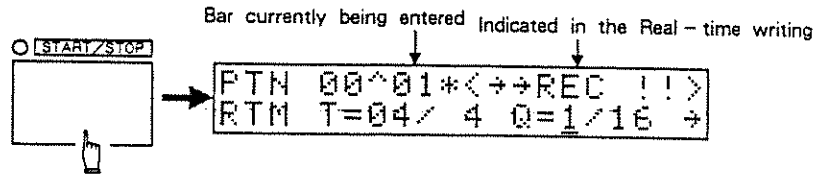

\*The metronome plays according to the setting of the metronome (next page).

Step 2 Press **TEMPO**, then set the tempo using **-1/OFF** / **+1/ON**, VALUE slider or Numerical Keys.

\*During tempo setting, you can play a rhythm by tapping the key pads, but the rhythm pattern is not written in memory. So, you may practice playing.

Step 3 Press **TEMPO** to return to the Real-time Writing display.

Step 4 Tap the key pads in time to the metronome to write the instrument sounds (the written sounds will be played repeatedly).

If necessary, change Pad Banks with **PAD BANK**.

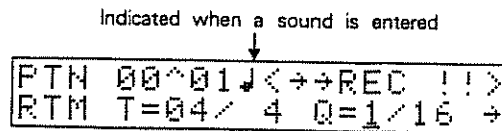

Step 5 Press **START/STOP** to stop playing.

Step 6 Press **EXIT** to return to the Menu Display.

### Erasing the sounds

To erase some sounds you have written, while still in the Real-time writing mode, hold **SHIFT** down, and without releasing it, push the key pad of that instrument until the sound has disappeared. Do this with the unit playing the rhythm.

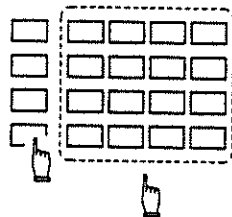

### Graphic Display

The written rhythm pattern is shown in the graphic display (Even finer timing values are shown with 16th note or triplet).

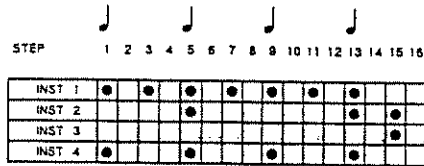

INST 1 shows the last Instrument written with Step Writing.

INST 2 to 4 can freely be assigned the Instrument to be shown.

To assign the instruments, take the Display Assign procedure (page 46).

### Metronome Settings

The following parameters are integral to metronome setting.

#### ● Interval

This selects the timing of the metronome.

(1/4, 1/6, 1/8, 1/12, 1/16, 1/24, 1/32)

#### ● Mode

This selects one of the following modes.

EVERY REC .....Metronome is always on (in the Real-time writing).

EMPTY REC .....Metronome plays when no data is written in the rhythm pattern and does not play when any sound is written.

EVER OFF .....Metronome is off.

#### ● Level

This sets the volume of the metronome (0 - 15). At zero, the metronome does not sound.

#### ● Output

This selects an output jack where the metronome is output, from the Stereo output and Multi outputs 1 - 8. When the Stereo output jack is selected, one of the 7 pan settings (LEFT 1 - 3, CENTER, RIGHT 1 - 3) can be set.

□ PATTERN WRITING (Basic)

To change the Metronome settings, do as follows with the unit set to the Pattern Playing mode and stopped.

Step 1 While holding **SHIFT** down, tap key pad 5.

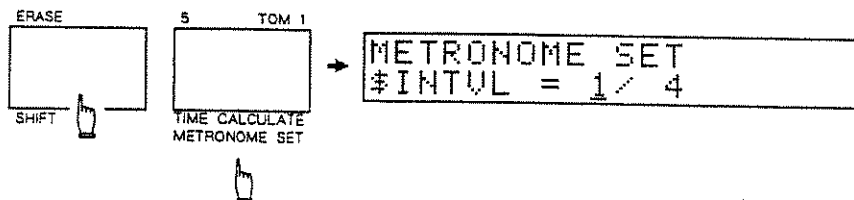

Step 2 Press **SELECT** to select the parameter to be edited.

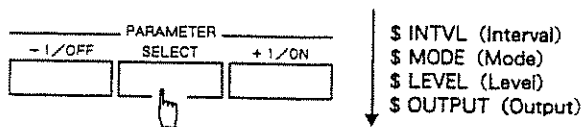

Step 3 Edit the value of the parameter with **-1/OFF** / **+1/ON**, or VALUE slider. The Interval and Level can also be set with Numerical Keys.

Step 4 Repeat steps 2 and 3 to continue and edit the other parameters.

Step 5 Press **ENTER** to return to the previous display.

### 3. Step Writing

The Step writing mode allows you to write one step for each Instrument at a time.

#### a. Step Writing modes

The Step Writing consists of the three displays (modes) as shown below. Select a display you need.

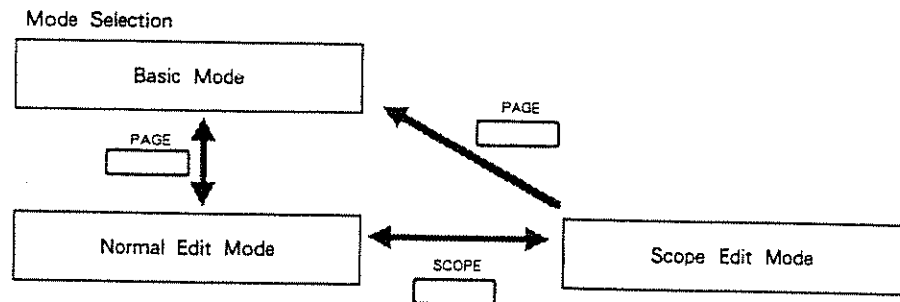

Functions of Modes

Mode Display Function	Basic Mode	Edit Mode	
		Normal Edit Mode	Scope Edit Mode
Rhythm Pattern selection	○	×	×
Entry Method selection	○	×	×
Step Write			
In Step unit	○	○	○
In Scope Step unit	×	×	○
Sequence Parameter Editing			
In Step unit	×	○	○
In Scope Step unit	×	×	○

**Basic Mode**

To select the Basic Mode for Step Writing, select "STEP" in the Menu Display.

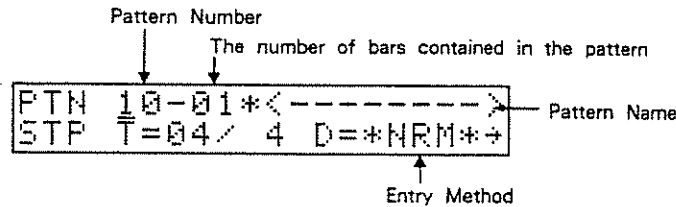

**1) Selecting a rhythm pattern**

This selects the rhythm pattern where you write data.

**2) Changing bars for writing steps**

In Step writing, the steps are specified using the 16 key pads. When the total number of steps is more than 16 (that is, the rhythm pattern is made of more than one bar), you need to change bars for making a rhythm pattern.

**3) Setting the length of a step and the graphic display**

Depending on the rhythm pattern to be programmed, you can select either of the two step entry modes.

\*The step entry modes cannot be changed while the rhythm is playing in the Step Writing.

**● Normal Entry (NRM)**

This mode may be selected for making 8 or 16 beat rhythm pattern. In this normal entry mode, one step is 16th note (Quantize Q = 1/16 in the Real-time writing).



**● Triplet Entry (TRI)**

This mode may be selected for making triplet type rhythm patterns. In this Triplet entry mode, one step is a triplet (Quantize Q = 1/12 in the Real-time writing).

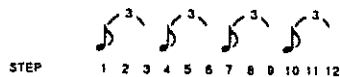

4) **Basic Step Writing** The steps are entered using the 16 key pads for each Instrument respectively.

\*In the Basic Mode, when the total number of steps in a bar exceeds 16 (Ex. 5/4 time), the exceeded steps cannot be written. You should use the Normal Editing or Scope Editing mode.

**Normal Editing Mode** To select the Normal Editing mode, press **PAGE** in the Basic mode.

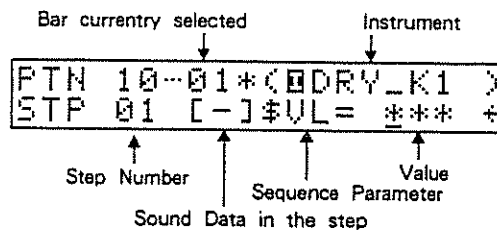

1) **Step Write** Just like in the Basic mode, the steps are entered using the 16 key pads for each Instrument respectively.

2) **Editing Sequence Parameters** For each step you have written, sequence parameters (see page 107) can be set. The Normal Editing mode allows editing of the sequence parameters in a step unit.

**Scope Editing Mode**

To select the Scope Editing mode, press **SCOPE** in the Normal Editing mode.

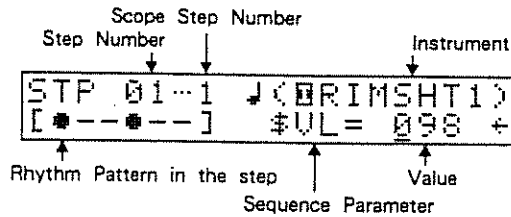

The Scope Editing mode has the following functions.

**1) Step Writing in each Scope Step**

In the Scope Editing mode, you can use a fine timing (1/96 note = Quantize Q = HIGH in the Real-time writing) for specifying steps (Scope steps).

Specify the step which you wish to write using a Scope step, then set the scope step. The number of scope steps which can be specified vary depending on the setting of the entry mode (6 in Normal Entry, and 8 in the Triplet Entry).

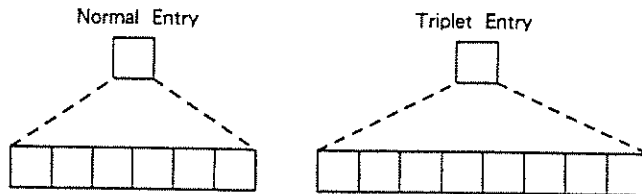

**2) Editing Sequence Parameters in Scope Step unit**

For each step you have written, sequence parameters (that affect the Tone of Instruments) can be set. The Scope Editing mode allows you to edit the sequence parameters in a Scope step unit.



## b. Basic Step Writing

The following explains Step Write in the Basic mode.

- Step 1** To write a rhythm pattern made of more than one bar, specify the number of bars to be written. Move the cursor to the bar number with ◀ and ▶, then using **-1/OFF** **+1/ON**, Numerical Keys or VALUE slider, set the bar number.

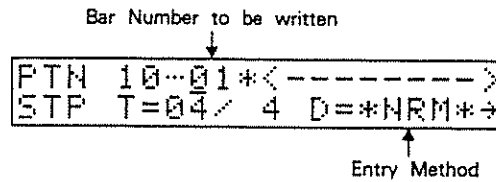

- Step 2** Select the length of a step. Move the cursor to the value of "D" with ◀ and ▶, then using **-1/OFF** **+1/ON** or VALUE slider, select Normal Entry (16th note) or Triplet Entry (triplet).
- Step 3** Tap the key pad which corresponds to the Instrument to be entered (without the rhythm playing).  
If necessary, change Pad Banks with **PAD BANK**.
- Step 4** Press **START/STOP** to start playing the rhythm.

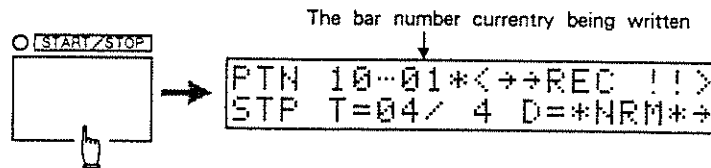

\*While the rhythm is playing, key pads 1 to 16 behave as step number setting keys.

- Step 5** Set the steps with the key pad 1 to 16. (The entered sound will be played repeatedly.)  
The velocity (dynamics) is also entered at the same time.

\*To cancel the step you have written, simply tap the same key pad.



### c. Step Writing in the Edit Mode

This section describes how to program rhythm patterns which cannot be made in the Basic Mode.

\*The Edit mode also allows you to edit Sequence parameters (see page 107).

#### Normal Edit Mode

The basic step writing procedure in the Normal Edit mode is the same as the Basic mode (see the previous section). The Normal Edit mode, however, can set the steps even for the rhythm pattern which have more than 16 steps (Ex. 5/4 time). Do as follows :

Step 1 Press **PAGE** in the Basic mode to turn to the Normal Edit Mode.

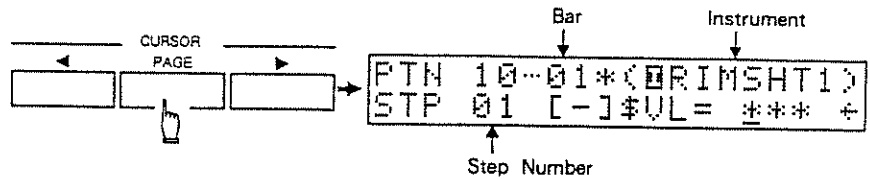

When a bar contains more than 17 steps (13 steps in the Triplet Entry), the "▶" mark appears at the right of step number 16.

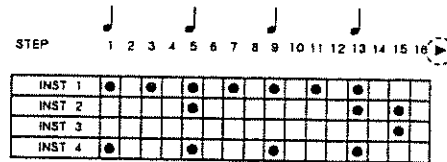

Step 2 Press **◀** and **▶** to advance the step numbers. Pressing **▶** (**◀**) while holding **◀** (**▶**) down will quicken the change.

When the step number exceeds 16 (12 in the Triplet Entry), the key pads and the step number assignments change ( the "◀" mark appears at the left of step number 1).

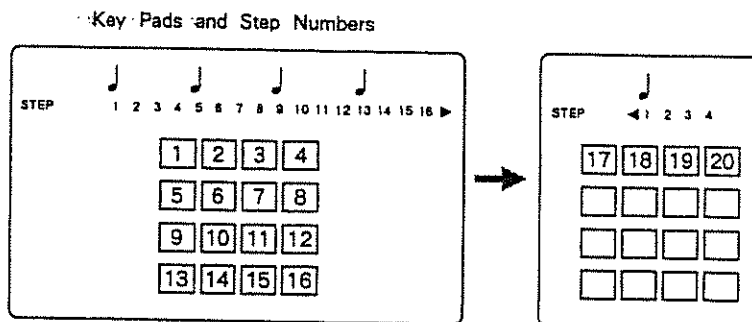

**□ PATTERN WRITING (Basic)**

\*When writing steps of a rhythm pattern made of more than one bar, pressing  will advance the step numbers, then moves to the next bar.

**Step 3** Using the same procedure as the Basic mode, set the steps with key pads.

\*The number shown at the lower right of the display is the value of the sequence parameter (see page 107).

### Scope Edit Mode

In the Scope Editing mode, you can use a fine timing (1/96 note = Quantize Q = HIGH in the Real-time writing) for specifying steps (Scope steps).

Select the step number which you wish to write a sound in a fine timing, and specify the steps in a Scope step unit (1 to 6 in Normal Entry, and 1 to 8 in the Triplet Entry).

Step 1 Press **SCOPE** in the Normal Edit mode to change to the Scope Edit mode.

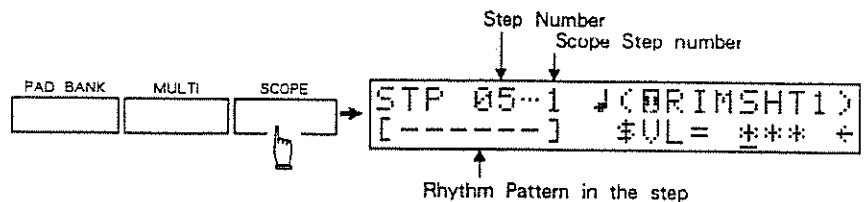

Step 2 Press the key pad that corresponds to the Instrument to be written (without the rhythm playing).

Step 3 Press **START/STOP** to start playing the rhythm.

\*With the start of play, the Key pads take on the function of scope step number assignment.

Step 4 Set the number of steps to be entered in Scope step with **◀** and **▶**. Pressing **▶** (or **◀**) while holding **◀** (or **▶**) will quicken the change of step numbers.

\*The Scope Step number shown in the display bears no meaning with respect to the correspondence between the Key pads and Scop Step numbers.

Step 5 Set the Scope step number with the key pad 1 to 6 (1 to 8 in Triplet entry). The strength of hitting key pads is entered at the same time.

< Ex. > When Scope Step Numbers 1 and 4 are selected

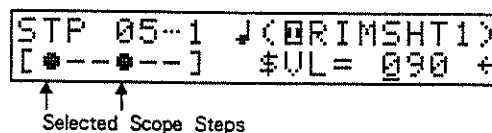

\*To cancel a step you have selected, simply tap the same key pad.

□ PATTERN WRITING (Basic)

- Step 6 To continue, and set the other step numbers, repeat steps 4 and 5.
- Step 7 To continue, and set another instrument, stop playing and set it using an appropriate key pad.

\*Pressing **SCOPE** returns the unit to the Normal Edit mode, while pressing **PAGE** returns to the Basic mode.

To check the Scope step status, change to the Normal Edit mode. The display will respond as shown below :

Sign	Scope Step Number setting	
—	[ — — — — — ]	No sound is entered in the step number currently shown in the display.
●	[ ● — — — — ]	An instrument is entered in Scope Step number 1.
⊗	[ ● — — ● — — ] [ ● — ● — — ] etc.	Instruments are entered in the Scope Step number 1 and the other Scope Step numbers.
F	[ F — — — — ]	Flam sound is entered in Scope Step number 1.
□	[ F — — ● — — ] [ F — — — F — ] etc.	Flam sound is entered in Scope Step number 1 and sounds are entered in the other Scope Step numbers.
⋆	[ — — — ● — — ] [ — — F — ● — ] etc.	Instruments are entered in the Scope Step numbers differently from the above settings.

\*For detailed explanation of Flam entry (see page 86).

d. Examples for Step Writing

Enter the following score in the Step Writing.

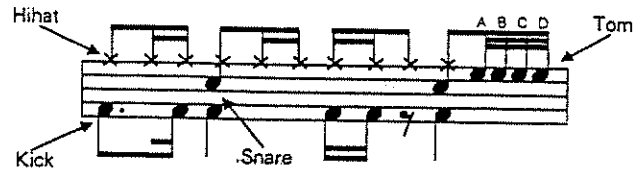

The score may be modified as shown below for Step Writing.

STEP	1	2	3	4	5	6	7	8	9	10	11	12	13	14	15	16
Hihat	●	●	●	●	●	●	●	●	●	●	●	●	●	●	●	●
Tom																
Snare				●												
Kick	●		●	●												

**Step 1** Erase all the unneeded data in the rhythm pattern and set the bar number to 1 and timing to 4/4 (See page 59).

**Step 2** This rhythm pattern is 16 beats, therefore select the Normal Entry in the Basic mode.

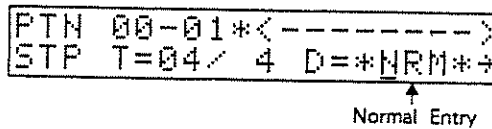

**Step 3** Enter the kick drum.  
In the Basic mode and stopped, press the key pad for the kick drum (key pad 13 in Pad Bank A).

**Step 4** Press **START/STOP** to start playing.

**Step 5** Tap the key pads that correspond to the step numbers to set the steps (step numbers 1, 4, 5, 9, 10 and 13).

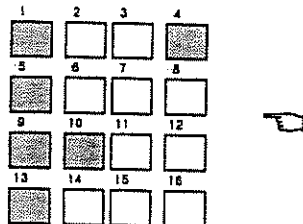

\*Be careful about the accents, since the strength of the key pad hitting is entered at the same time.

1 PATTERN WRITING (Basic)

**Step 6** Enter the snare drum.  
Stop playing the rhythm, then press the key pad for the snare drum (key pad 14 in Pad Bank A).

**Step 7** Press **START/STOP** to start playing, then tap key pads 5 and 13.

**Step 8** Enter the Hihat in the same way (step numbers 1, 3, 4, 5, 7, 8, 9, 10, 11 and 13).

**Step 9** Enter the tom.  
Stop playing the rhythm, then press the key pad for the tom (key pad 6 in Pad Bank A).

Tom uses 1/32 notes, and therefore cannot select B or D step in the score. So, perform the Scope editing for step numbers 15 and 16.

**Step 10** Press **PAGE**, then **SCOPE** to change to the Scope Edit mode.

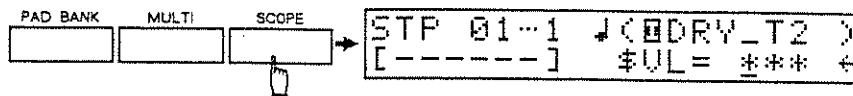

**Step 11** Specify step number 15 using **◀** and **▶**.

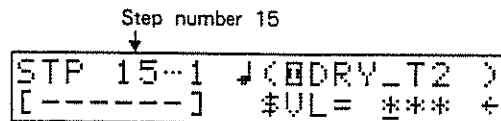

**Step 12** Start playing the rhythm, then select the Scope step number using the relevant key pad.

The Scope step is 1/96 note, therefore A and B in the score are Scope step numbers 1 and 4.



**Step 13** Specify step number 16 with **▶**, then repeat the procedure 12.

**Step 14** Stop playing, then press **EXIT** to return to the Menu Display.



## 2 PATTERN WRITING (Advanced)

### 1. Performance Parameters

The tone of an instrument assigned to each key pad can be changed by editing the Performance parameters ; Pitch, Decay, Nuance and Pan.

Sound parameters and Performance parameters function as follows.

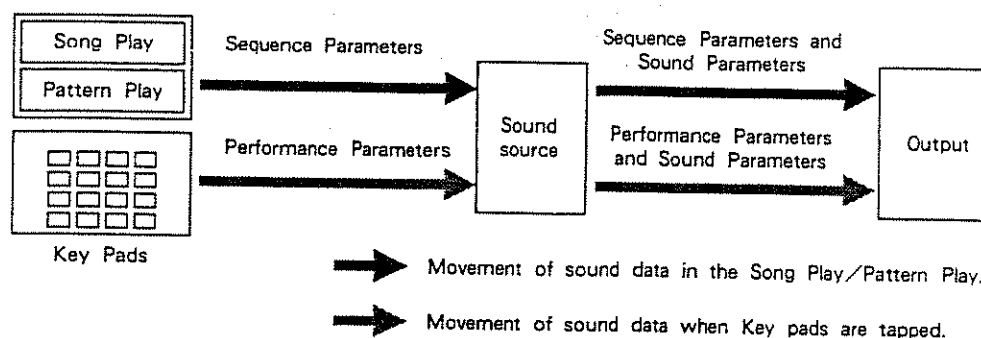

#### Sound Parameters

Sound parameters determine the sound which is the basic element of an Instrument.

● Sound parameters should normally be set before writing a rhythm pattern.

● If you wish to change the overall sound of an instrument after writing a song, you can do it by editing sound parameters.

\*Editing Sound parameters will affect the instruments in all the rhythm patterns. If you wish to retain the original sound even after edited, save it onto a memory card (See page 165).

## Performance Parameters

Performance parameters set the amount of changes made to the values of the Sound parameters for each key pad. Tapping a Key pad will output the mixture of the sound parameter value and the performance parameter value.

● **Value of a Performance parameter is effective only on the sound played by the relevant key pad. It has no effect when rhythm patterns or a song is being played.**

● **The set Performance parameters are entered into a rhythm pattern in the Pattern Writing as Sequence parameters (sound data).**

If you have set Performance parameters before writing the rhythm pattern, you can change the sound of an Instrument in a specific rhythm pattern.

If you change Performance parameters during rhythm pattern writing or change Sequence parameters after writing a rhythm pattern, you can change the sound of the same Instruments in the rhythm pattern.

● **Using the Multi Assign function (see page 81), you may assign the same Instrument to all 16 key pads and set the Performance parameters in each key pad to different values, so that you can play a Instrument with different sounds.**

To set the Performance parameters of the key pads to values different from each other by a certain level in sequence, the Align function can be used (see page 82).

\* **The sound of each Instrument changes within the variable range of each Sound parameter. If you have set a value (add Performance parameter's value to Sound parameter's value) exceeding the range, there will be no more change in the actual sound.**

## a. Functions of the Performance Parameters

### 1) Pitch

(- 4800 to  
+ 4800 cents)

This can be set in 10 cent steps. Higher values raise the pitch.

\*At zero, the same pitch as the Sound parameter's is obtained.

### 2) Decay

(- 63 to + 63)

Higher values make longer decay time.

If the Instrument can set the Nuance, the value set here will be added to each decay (Sound parameter).

\*At zero, the same decay as the Sound parameter's is obtained.

### 3) Nuance

(- 7 to + 7)

The sound can be altered delicately with the Nuance function.

\*If the Instrument which cannot set the Nuance is assigned, setting the Nuance will not affect the sound.

\*At zero, the same nuance as the Sound parameter's is obtained.

### 4) Pan

(LEFT 1 to 3,  
CENTER, RIGHT 1 to  
3, OFF)

When the Output Assign (Sound Parameter) of an Instrument is set to Stereo Out (LEFT 1 to 3, CENTER, RIGHT 1 to 3), this parameter allows you to set the pan value (sound field positionings).

\*The Pan setting of the Performance parameter is given priority. At OFF, the same pan setting as the Sound parameter's is obtained.

\*If the Output Assign (Sound parameter) of an Instrument is set to MULTI OUT (MULTI's 1 to 8), the pan setting will be ignored.

\*The Pan you are currently setting can be seen at INST 1 in the graphic display.

## b. Setting Performance Parameters

Set the Performance parameters for each key pad.

Step 1 Press **PERFORM** to turn to the Performance Edit mode.

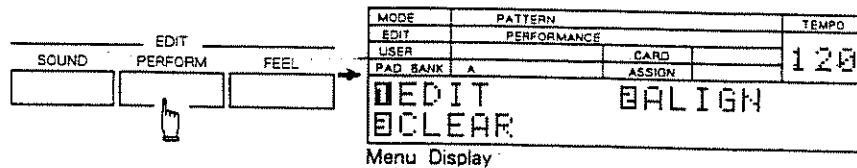

\*If the Menu Display is not shown, press **EXIT**.

Step 2 Press Numerical Key 1 to select "EDIT".

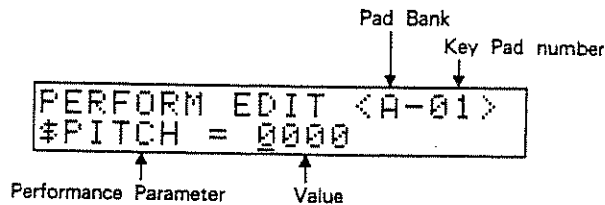

Step 3 Tap the key pad whose Performance parameters you wish to edit. If necessary, change the Pad Banks with **PAD BANK**.

Step 4 Select the parameter to be edited with **SELECT**.

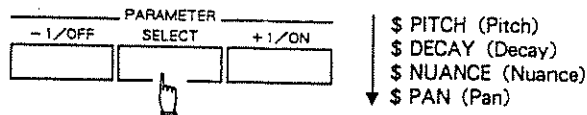

Step 5 Using **-1/OFF** **+1/ON** or VALUE slider, change the values (Parameters other than Pan can be set with Numerical Keys).

Tap the key pads to listen to the sound.

Step 6 To continue to change the other parameters, repeat steps 4 and 5 as many times as necessary.

Step 7 To continue, and edit the other key pads, repeat steps 3 to 6 as many times as necessary.

Step 8 Press **PERFORM** to return to the previous display.

### c. Using the Multi Assign Function

The Multi Assign function allows you to assign the same Instrument to all 16 key pads. This assignment is independent from the five pad Banks.

Use this function together with the Align function (that automatically sets the Performance parameters of the Key pads to certain values in sequence). Using this function, you can play Hihat that has continuously changing decays, or perform a "melodic tom" by shifting pitches in semitone steps.

**Instrument Selection** Select the Instrument to be assigned to all the 16 key pads.

**Step 1** Press **INST ASSIGN** to turn to the Instrument Assign mode.

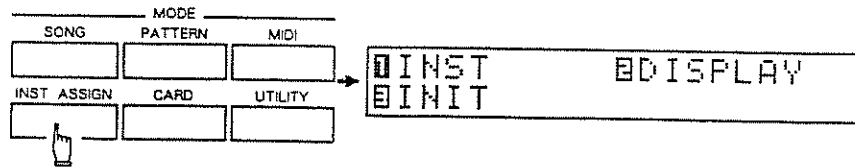

\*If the Menu Display is not shown, press **EXIT**.

**Step 2** Press Numerical Key 1 to select "INST".

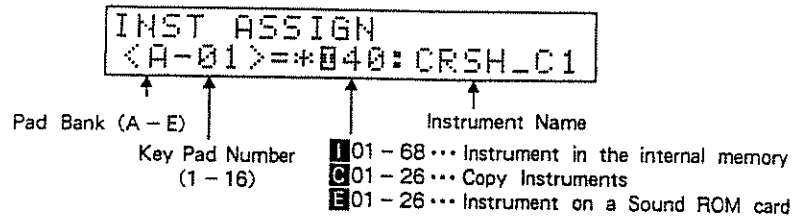

**Step 3** Press **MULTI** to set to the Multi Assign mode.

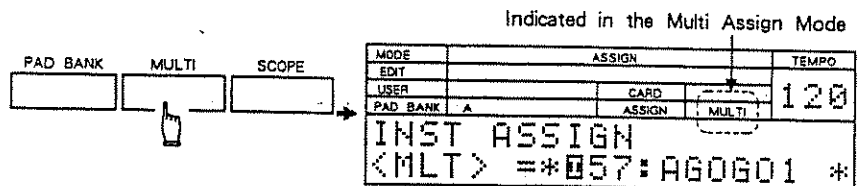

\*Further presses of **MULTI** switches alternately between the Instrument Assign and Multi Assign modes.

**Step 4** Using **-1/OFF** **+1/ON** or VALUE slider, select the Instrument to be used.

**Step 5** Press **EXIT** to return to the Menu Display.

▣ PATTERN WRITING (Advanced)

**Performance Parameters in the Align Function** The Align function allows you to set the Performance parameters (Pitch, Decay and Nuance only) of key pads 1 to 16 in the sequence as shown below.

Pitch				Decay				Nuance			
-800	-700	-600	-500	-36	-33	-30	-27	-7	-7	-6	-5
-400	-300	-200	-100	-24	-21	-18	-15	-4	-3	-2	-1
0	+100	+200	+300	-12	-9	-6	-3	0	+1	+2	+3
+400	+500	+600	+700	0	+3	+6	+9	+4	+5	+6	+7

Step 1 Press **PERFORM** to turn to the Performance Edit mode.

Step 2 Press Numerical Key 2 to select "ALIGN".

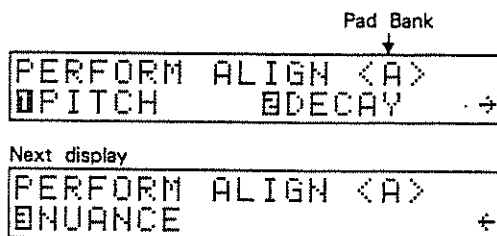

Step 3 Press **MULTI** to change to the Multi Assign mode.

- \*Further pressing of **MULTI** switches alternately between the Instrument Assign and Multi Assign modes. Pad Banks cannot be changed in the Multi Assign mode.
- \*To set the Performance parameters of Pad Banks A to E with the Align function, select a Pad Bank with **PAD BANK**.

Step 4 Select the Performance parameter where you wish to use the Align function, with Numerical Keys 1-3.



Step 5 Press **ENTER**.

The display responds with "Are you sure?".

\*To leave the mode, press **EXIT**.

Step 6 To continue, press **ENTER**.

"Completed" appears, showing that the Align is done.

\*Should the total value of the Sound parameter and Performance parameter exceed the variable range of the Sound parameter, the value will be automatically set within the range.

### Multi Assign Performance

To play the R-8 with the Multi Assign function, press **MULTI** to turn to the Multi Assign mode.

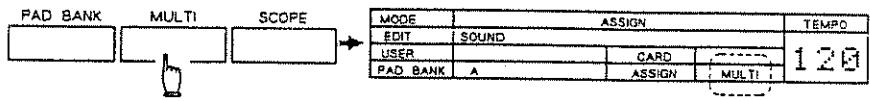

Indicated in the Multi Assign Mode

\*Further pressing of **MULTI** switches alternately between the Instrument Assign and Multi Assign modes. Pad Banks cannot be changed in the Multi Assign mode.

\*If the Multi Assign mode is selected during rhythm pattern writing, the Performance parameter assigned with the Multi Assign function will be entered as a Sequence parameter.

## 2. Swing/Flam/Roll Entry

### a. Swing

Swing is a feeling most commonly referred to as the "groove" of Jazz or Shuffle rhythms. The Swing effect can be set for each rhythm pattern separately, and is most effective if added to triplet type rhythm patterns. (Jazz, Shuffle, etc.)

\*The Swing effect is effective for pattern playing or song playing but has no effect in pattern writing.

The Swing is determined by the Swing Point and Swing Delay.

#### ● Swing Point

The Swing effect is obtained by delaying the timing of certain beats. The Swing Point sets the position (beat) where the timing is to be delayed.

$1/4$ ,  $1/8$ ,  $1/16$  or  $1/32$  delays the timing of the even number multiple beats.

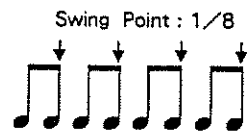

$1/6$ ,  $1/12$  or  $1/24$  delays the timing of the beats positioned in multiples of three.

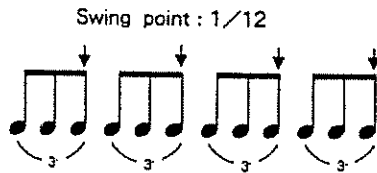

#### ● Swing Delay

This sets the amount of delay.



Now, let's set the swing effect in a rhythm pattern.

**Swing Setting**

With the unit set to a Pattern Mode ("PLAY", "REAL" or "STEP") and stopped, do as follows.

**Step 1** Specify the Pattern number where you wish to set the Swing effect.

**Step 2** Tap key pad 6 while holding **SHIFT** down.

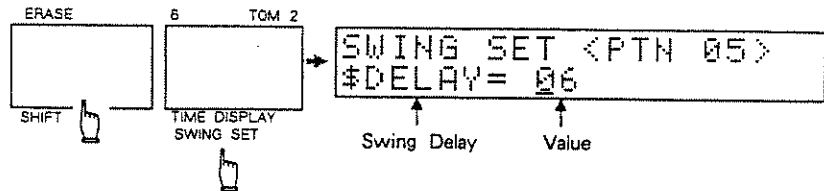

**Step 3** Using **-1/OFF** **+1/ON**, VALUE slider or Numerical Keys, set the Swing Delay value.

Higher values emphasize the feeling. (At zero, no Swing is obtained.)

\*The variable range for the Swing Delay value changes depending on the Swing Point.

**Step 4** Press **SELECT** to change to "POINT" display.

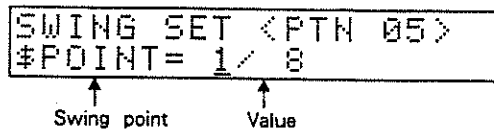

**Step 5** Using **-1/OFF** **+1/ON**, VALUE slider or Numerical Keys 1 to 7, set the Swing Point.

(Value : 1/4, 1/6, 1/8, 1/12, 1/16, 1/24, 1/32)

**Step 6** Press **ENTER** to return to the previous display.

## b. Flam

A Flam is created when two sticks are dropped at the same time, yet from different heights. The Flam effect can be set for each rhythm pattern separately.

The Flam effect is determined by Flam Interval and Flam Ratio.

### ● Flam Interval

This sets the interval between the two sticks in 32 levels (0 to 31).

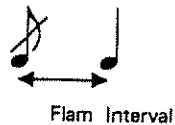

### ● Flam Ratio

This sets the intensity (velocity) of the first and second sticks.

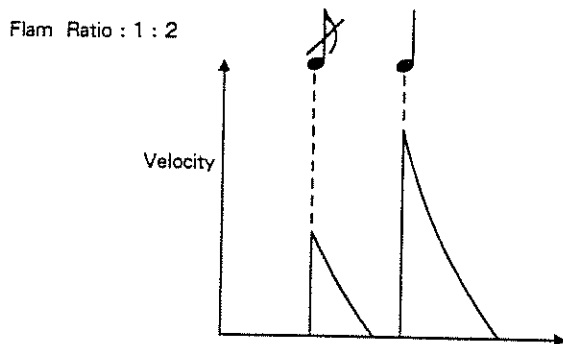

## Flam Setting

Now, let's set the flam value.

With the unit set to a Pattern Mode ("PLAY", "REAL" or "STEP") and stopped, do as follows.

**Step 1** Specify the Pattern number where you wish to set the Flam effect.

**Step 2** Tap key pad 7 while holding **SHIFT** down.

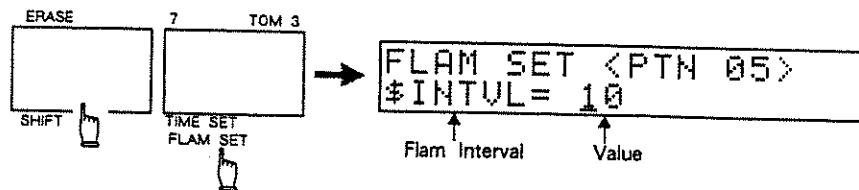

Step 3 Using **-1/OFF** **+1/ON**, VALUE slider or Numerical Keys, set the Flam Interval value (0 to 31). (At zero, no Flam is obtained.)

Step 4 Press **SELECT** to change to "RATIO" display.

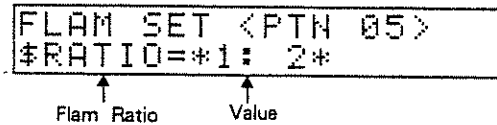

Step 5 Using **-1/OFF** **+1/ON** or VALUE slider, set the Flam Ratio. (Value : 1 : 1, 1 : 2, 1 : 4, 1 : 8, 1 : 16, 1 : 32)

Step 6 Press **ENTER** to return to the previous display.

### Flam Entry

To write the Flam you have set, do as follows.

#### ● In the Real-time Writing mode

While holding **FLAM** down, tap the key pad in the timing for Flam entry (with the unit playing the rhythm).

< Ex. > Adding Flam to the Instrument of Key Pad 14

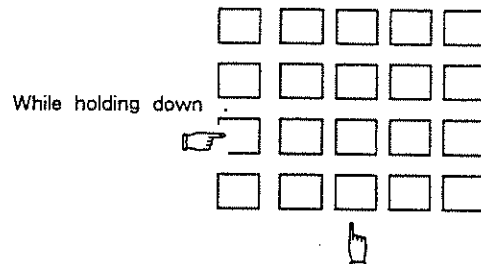

#### ● In the Step Writing mode

With the rhythm playing, hold **FLAM** down and press the key pad that corresponds to the step (or Scope step) where the Flam is to be entered. In the Normal Edit/Scope Edit mode, you can check the Flam entry status.

Normal Edit Mode

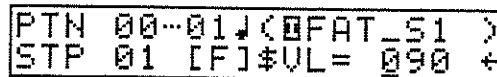

↑ F is shown at the step where Flam is set

Scope Edit Mode

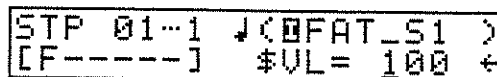

↑ F is shown at the Scope step where Flam is set

### c. Roll

Roll is playing sounds sequentially in the same intervals.

#### Roll Setting

Now, let's set the Roll interval.

With the unit set to a Pattern mode and stopped, do as follows.

Step 1 Tap key pad 8 while holding **SHIFT** down.

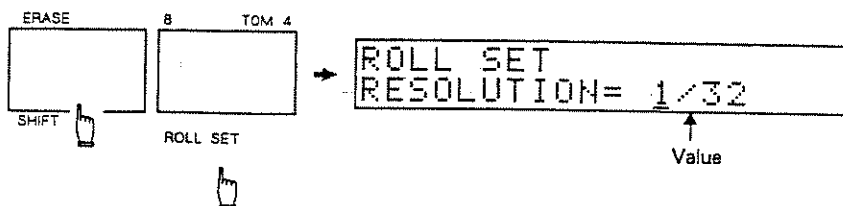

Step 2 Using **-1/OFF** **+1/ON**, **VALUE** slider or Numerical Keys 1 to 9, set the value of the interval.  
(Value: 1/4, 1/6, 1/8, 1/12, 1/16, 1/24, 1/32, 1/48, HIGH (1/96 notes))

Step 3 Press **ENTER** to return to the previous display.

#### Roll Entry

To write the Roll you have set, with the unit set to the Real-time Writing mode, do as follows.

\*When writing a Roll into a Rhythm pattern, the Quantize setting will determine the resolution of the Roll match the two settings.

Procedure While holding Roll down, keep pressing the relevant key pad.

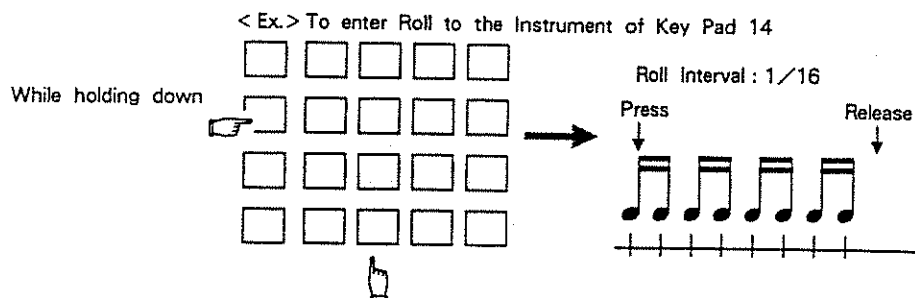

The Roll effect is written until the key pad is released (the level changes depending on how hard you press the key pad).

\*In the Step Writing mode, the Roll effect cannot be written.

\*The Roll effect can be performed in the mode other than Pattern Write. Even when the rhythm is not playing, the Roll rate can be changed with the tempo.

### 3. Macro Note

Up to 10 different Macro Notes can be registered in the R-8. A Macro Note is a performance pattern made of up to 16 steps. The Macro Note patterns you have registered can be written into the rhythm pattern just by tapping the key pad once. For quicker rhythm pattern programming, it may be wise to register performance patterns which are frequently used.

Also, in modes other than Pattern Writing, the specified Instrument can be played using the performance pattern of a Macro Note.

#### a. Macro Note Setting

A Macro Note can be set in the same way as step writing (setting one Step and another). Each step you have entered can have a relative velocity value. By decreasing the velocity values according to the step number, delay effect can be obtained.

\*The relative velocity value is the amount of change to be made to the basic strength (zero) of key pad hitting set for each step.

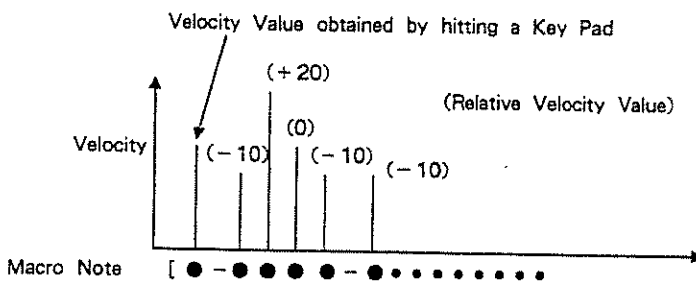

#### < Example of Macro Note Setting >

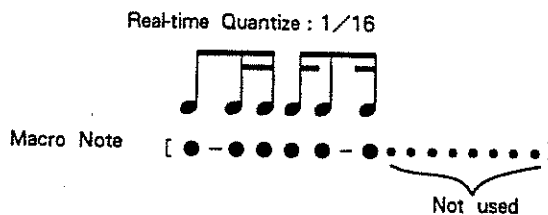

With the unit stopped, do as follows.

Step 1 Press **DEFINE**.

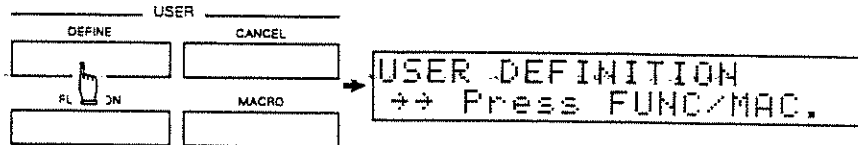

Step 2 Press **MACRO** to change to the Macro Note setting display.

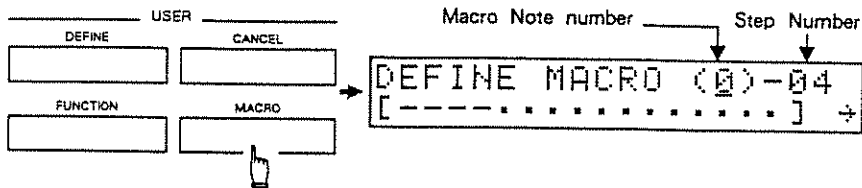

Step 3 Using **-1/OFF** / **+/ON**, VALUE slider, or Numerical Keys, specify a Macro Note number (0 to 9) to be registered.

\*Key pads 1 to 16 now work as step number assigning keys.

Step 4 Using **◀** and **▶**, move the cursor to the right, to set the number of steps (2 to 16).

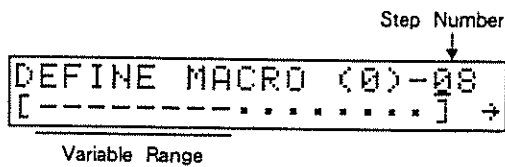

\*The timing value (note length) of a step is determined by the Quantize value in the Real-time writing (or the length of a step in the Step writing) used for Macro Note.

- Step 5 Tap the key pad that corresponds to the Step number to be entered (To cancel the Step number you have entered, simply tap the same key pad).

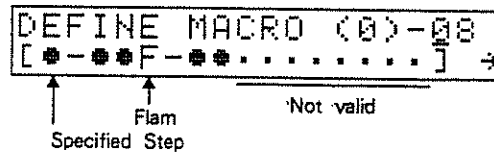

\*To add the **FLAM** effect, tap the key pad while holding **FLAM** down.

\* Pressing key pads does not create sounds.

- Step 6 Press **PAGE** to select the Relative Velocity Value setting display.

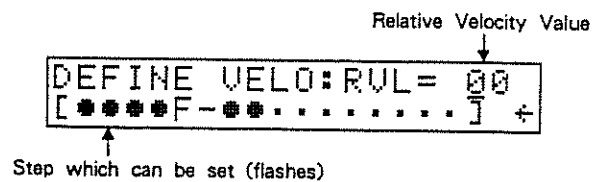

- Step 7 Specify the Step number with **◀** and **▶**, then using **-1/OFF** **+ /ON**, VALUE slider, or Numerical Keys, set the Relative Velocity value (-99 to +99) of each step.

\*When the Macro mode is "ON", the actual sound can be monitored by playing Key pads. (See next page)

- Step 8 To continue, and set the other Macro Notes, change the displays with **PAGE** and repeat steps 3 to 7.

- Step 9 Press **DEFINE** to return to the previous display.

## b. Using Macro Note

Now, play the registered Macro Note pattern with an Instrument. Macro Notes can be used in other modes, as well as the Rhythm pattern writing. To use the Macro Notes, set the Macro Mode ON.

### Setting Macro Modes

Using the following procedure, the Macro Notes you have set can be played.

Step 1 Press **MACRO**.

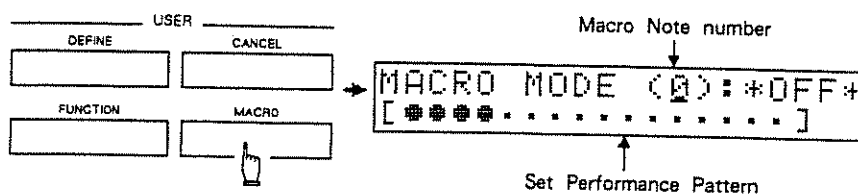

Step 2 Using **-1/OFF** **+ / ON**, VALUE slider, or Numerical Keys, select the number of the Macro Note to be played.

Step 3 Move the cursor with **◀** and **▶**, then set the Macro Mode to ON.

ON: The Macro Note you select is played by hitting a key pad.

OFF: Normal condition (playing a key pad generates sound once).

Step 4 Press **MACRO** to return to the previous display.

With the Macro Mode set to ON, the specified Macro Note is played by hitting a key pad even in modes other than Pattern Writing.

The timing value (the length of the note) of a step is determined by the last Quantize selected in Real-time writing. Also, the speed of the Macro Note performance is determined by the set tempo.



**In Real-time Writing Mode**

The following explains how to use Macro Notes in the Real-Time writing mode.

With the unit set to the Real-time writing mode, do as follows.

\*The timing value (the length of the note) of a step for Macro Note is determined by the Quantize setting.

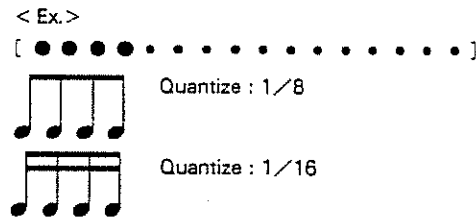

**Step 1** Specify the Macro Note number to be used.

- ① Press **MACRO**.
- ② Using **-1/OFF** **+1/ON**, **VALUE** slider, or **Numerical Keys**, select the number of the Macro Note (0 to 9) to be played.
- ③ Press **MACRO** to return to the previous display.

**Step 2** Tap the key pad where the Macro Note is to be entered with the unit playing the rhythm.

The Macro Note data is written in the same timing as you tap the key pad.

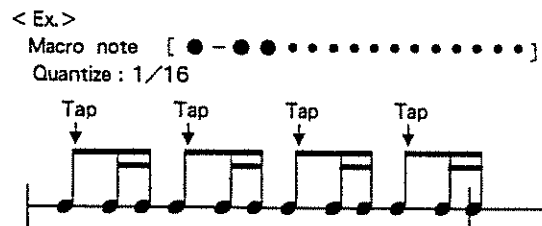

**In the Step Writing Mode**

The following explains how to use Macro Notes in the Step writing mode.

The timing value (the length of the note) of a step for Macro Note differs depending on the current mode as shown below.

mode \ Entry Method	Normal Entry	Triplet Entry
Basic Mode	1/16 note	Triplet
Normal Edit Mode	1/16 note	Triplet
Scope Edit Mode	1/96 note	1/96 note

With the unit set to the Step writing mode, do as follows.

**Step 1** Specify the Macro Note number to be used.

- ① Press **MACRO**.
- ② Using **-1/OFF** / **+ / ON**, VALUE slider, or Numerical Keys, select the number of the Macro Note (0 to 9) to be played.
- ③ Press **MACRO** to return to the previous display.

**Step 2** Tap the key pad for the first step of the Macro Note with the unit playing the rhythm.

Macro Note data is written from the step number of the pad tapped.

< Ex. > Selecting Step Number 9 with Normal Entry of the Basic (or normal Edit) Mode.

Macro Note [ ● ● ● ● ● ● ● ● ● ● ]



\*Macro Note data cannot be written into the steps which cannot be specified with key pads.



# 3 FEEL PATCH

When humans express themselves rhythmically, unlike programmable rhythm machines, they use natural dynamics and accentuation. Even when they mean to play in exactly the same manner, the strength or positions of beating will vary slightly (random change). This means that the created sounds will not be perfectly consistent. The R-8 can set up to eight Feel Patches which contain regular tone changes (according to the accents set in the music) and random tone changes. By adding a Feel Patch to the rhythm pattern previously programmed, you can express subtle sound changes, creating a more "Human Feel".

## Feel Patch Structure

A Feel Patch is accompanied by two elements ; Groove and Random Factor. By combining the two elements, Sequence parameters (Velocity, Pitch, Nuance and Decay) can be changed.

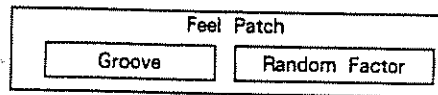

### ●Groove

The Groove is associated with regular changes of accent and tone. This, therefore, can express the accents's changes which a drummer purposely creates.

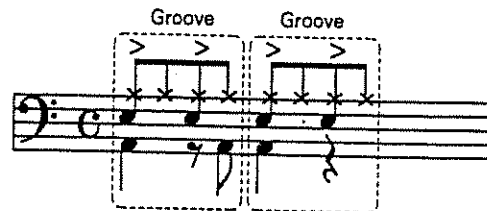

The Groove sets the timing for the changes and relative values of some Sequence parameters.

By assigning the Groove settings to the existing rhythm patterns, the relative values are added to the same sounds (sequence parameters of the specified Instruments) as the timing set in the Groove, changing the sounds in a certain cycle.

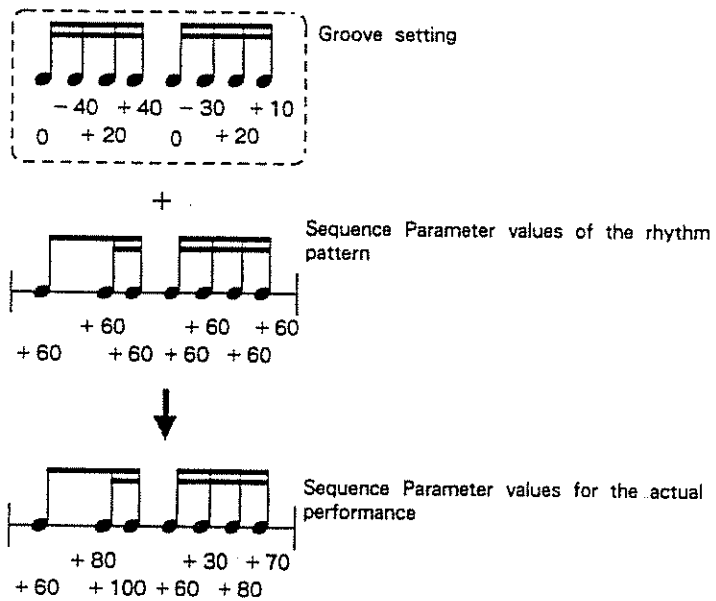

● **Random Factors**

The Random Factors are used to alter the values of the specified Sequence parameters at random.

By changing the Nuance of a drum instrument, the sound will change delicately in each striking. Also, by changing the Nuance of a cymbal instrument, the sound will change depending on the position of striking. Such random changes create more realistic and natural performance.

## 1. Functions of Parameters

A Feel Patch is accompanied by the following parameters.

Parameter	Variable Range
Groove Select Groove Type Groove Step	1 - 8 1/4 - 1/32
Instrument Select	INST1 - 8
Groove Switch Random factor Switch	ON/OFF ON/OFF
Groove	- 99 - + 99 (Nuance : - 7 - + 7)
Random Factor Probability Random Depth	1 - 8 1 - 4
Instrument Switch INST1 - 8	ON/OFF

### a. Groove Select

```
GROOVE SELECT <#0>
TYPE= 4 STEP=1/8 →
```

↑                    ↑  
Groove Type       Groove Step

This parameter consists of two elements for setting the timing for the accents's changes, Groove Type and Groove Step.

- Groove Type sets the number of notes whose accents should be changed, from 1 to 8.
- Groove Step sets the timing value (length) of the note from 1/4 to 1/32.

### b. Instrument Select

```
FEEL INST SELECT<#0>
$INST1=(0OPEN_H1) →
```

↑  
Instrument

This sets eight Instruments which should be accentuated with the Groove and Random Factors.

c. Groove Switch and Random Factor Switch



For each Sequence parameter, On/Off of the Groove and Random Factors can be set.

d. Groove

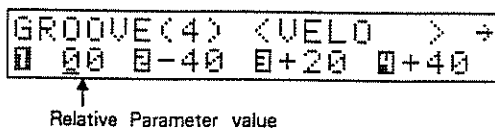

This sets the relative value for each Sequence parameter (-7 to +7 for Nuance and -99 to +99 for the other parameters) to each timing set with the Groove Select. The relative values set for the Sequence parameters are added to the same sound (specified Instruments) as the timing set in the Groove .

\*The Sequence parameters whose Groove Switches are set to OFF do not change.

e. Random Factors

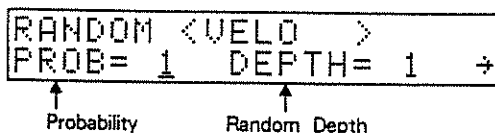

The Random Factors are Probability and Random Depth. Set these factors in each Sequence parameter to create irregular changes.

\*The Sequence parameters whose Random Factor Switches are set to OFF do not change.

●Probability (1 to 8)

This sets the ratio and the width of change of each Sequence parameter. Higher values increase the ratio and width of the change caused on the Sequence parameter.

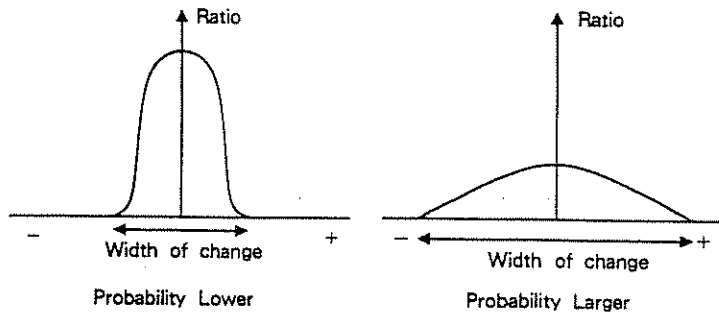

●Random Depth (1 to 4)

This sets the amount of the changes in the Probability. Higher values make it wider.

f. Instrument Switch

```
INST SWITCH <VELO >
$1: @OPEN_H1=*ON* ←
```

↑  
Instrument selected with Instrument Select

This selects whether to add the Feel Patch to each Instrument selected with the Instrument Select, for each Sequence parameter.

\*When the same Instrument is selected more than once with the Instrument select, set any Instrument Switch to "ON" to obtain the Feel Patch effect.



## 2. Editing Procedure

### a. Groove Setting

Step 1 Press **FEEL** to turn to the Feel Edit Mode.



Step 2 Press Numerical Key 1 to select "PATCH".

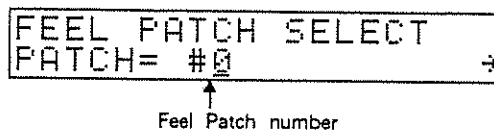

Step 3 Using **-1/OFF** **+1/ON**, VALUE slider or Numerical Keys, select the feel Patch number (0 to 7) to be used.

Step 4 Change to the Groove Select display with **PAGE**.



Step 5 Using **◀** and **▶** move the cursor, then using **-1/OFF** **+1/ON**, VALUE slider or Numerical Keys, select the Groove Type (1 to 8) and the Groove Step (1/4 to 1/32).

Step 6 Press **PAGE** to change to the Instrument Select display.



Step 7 Change Instruments (INST 1 to 8) using **SELECT**, then press the key pad corresponding to each Instrument to be edited with the Groove (common for Random Factors).

If necessary, change Pad Banks with **PAD BANK**.

Step 8 Press **EXIT** to return to the Menu Display.

3 FEEL PATCH

- Step 9 Select the Sequence parameter to be edited with Numerical Keys 2 - 5.
- 2 : Velocity
  - 3 : Pitch
  - 4 : Decay
  - 5 : Nuance

- Step 10 Using **-1/OFF** **+1/ON** or VALUE slider, select ON or OFF for the Groove Switch.

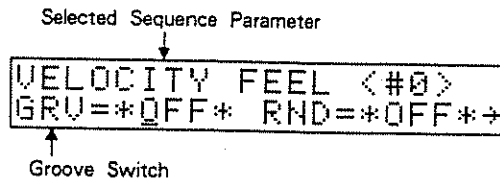

- Step 11 Press **PAGE** to turn to the Groove Setting display.

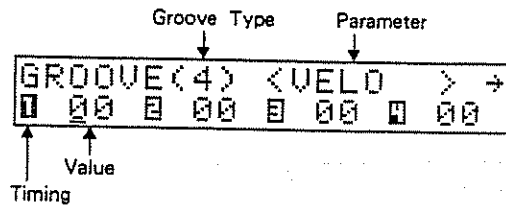

- Step 12 Move the cursor with **◀** or **▶**, then using **-1/OFF** **+1/ON**, VALUE slider or Numerical Keys, set the relative value for each timing (-7 to +7 for Nuance and -99 to +99 for the other parameters).

\*When the Groove Type is to be set to higher than 4, change to the 5 to 8 timing setting display with **▶**.

- Step 13 Select the Instrument Switch setting display with **PAGE**.

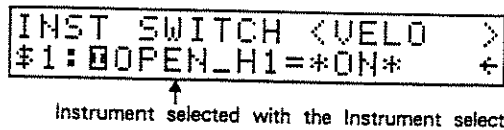

- Step 14 Change Instruments (INST 1 to 8) using **SELECT**, then with **-1/OFF** **+1/ON** or VALUE slider, select On or Off for the Instrument Switch.

- Step 15 To continue, and edit another Sequence parameter, press **EXIT** to return to the Menu Display then repeat steps 9 to 14.

- Step 16 Press **FEEL** to return to the previous display.

## b. Random Factor Setting

Step 1 Press **FEEL** to turn to the Feel Edit mode.



Step 2 Press Numerical Key 1 to select "PATCH".

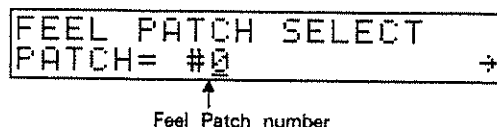

Step 3 Using **-1/OFF** **+1/ON**, VALUE slider or Numerical Keys, select the Feel Patch number (0 to 7) to be used.

Step 4 Press **PAGE** to change to the Instrument Select display.



Step 5 Change Instruments (INST 1 to 8) using **SELECT**, then press the key pad corresponding to each Instrument to be edited with the Random Factors (common for Groove).

If necessary, change Pad Banks with **PAD BANK**.

Step 6 Press **EXIT** to return to the Menu Display.

Step 7 Select the Sequence parameter to be edited with Numerical Keys 2 to 5.

2: Velocity

3: Pitch

4: Decay

5: Nuance



### 3. Feel Patch Assignment

The Feel Patches you have made can be assigned to the User-patterns. Feel Patches change the feeling of the rhythm performance.

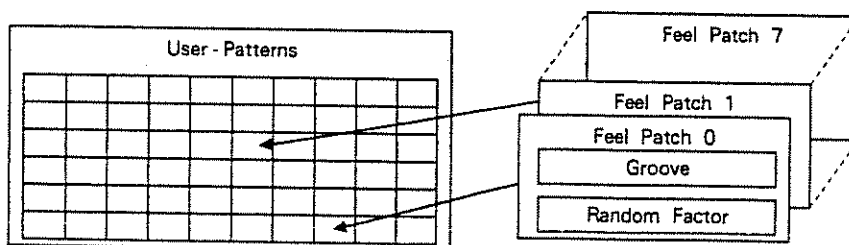

With the unit set to the Pattern Play mode and stopped, do as follows.

- Step 1 Select the rhythm pattern which you wish to assign a Feel Patch.
- Step 2 Move the cursor to "FEEL" value with and , then using , VALUE slider or Numerical Keys, select a Feel Patch (0 to 7).

```
PTN 00-01 ↓ < 8 BEAT 1 >
PLY T=04 / 4 FEEL=0
                ↑
                Feel Patch Number
```

\*If you do not assign any Feel Patch, select "\*" (This is not included in the Numerical Keys).

- Step 3 Start playing the rhythm pattern. It will be played with the Feel Patch assigned to it.

\*The Feel Patch assigned to a rhythm pattern has no effect in the Pattern Writing mode.

## 4. Feel Patch Copy

The Feel Patch Copy function allows you to copy the contents of a Feel Patch to a different Feel Patch number.

With the unit set to the Feel Edit mode and showing the Menu Display, do as follows.

- Step 1 Press Numerical Key 1 to select "PATCH".
- Step 2 Using **-1/OFF** **+1/ON** , VALUE slider or Numerical Keys, select the source Feel Patch (0 to 7) to be copied.
- Step 3 Press **EXIT** to return to the Menu Display.
- Step 4 Press Numerical Key 6, select "COPY".

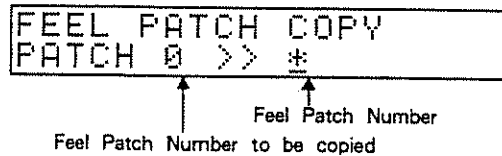

- Step 5 Using **-1/OFF** **+1/ON** , VALUE slider or Numerical Keys, select the destination Feel Patch (0 to 7).

\*To leave this mode, press **EXIT** .

- Step 6 Press **ENTER** .  
The display shows the message "Completed" , and the Feel Patch is copied.

## 4 RHYTHM PATTERN EDITING

### 1. Editing Sequence Parameters

Sequence parameters can be set to each sound entered in a rhythm pattern. There are six Sequence parameters, Velocity, Pitch, Decay, Nuance, Pan and Micro Timing. By editing Sequence parameters, the tone and timing can be changed after programming a rhythm pattern.

#### Functions of Sequence Parameters

##### ●Velocity

This parameter controls the intensity of key pad striking in the Pattern Writing mode. Higher values make the sound stronger.

##### ●Micro Timing

This shifts the sound entered in a rhythm pattern forward or backward in  $1/384$  note unit (Micro Timing).  $-2, -1, 0$  or  $+1$  can be selected for Micro Timing. Negative values quicken the timing and positive values slow it. In the Pattern Writing, it is set to zero.

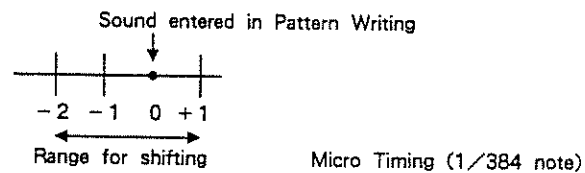

\*To change the timing drastically, perform the Macro Timing Shift (see page 112).

##### ●Pitch/Decay/Nuance/Pan

These parameters have the values of Performance parameter set in the Pattern Writing (see page 77). If they are not programmed in the Pattern Writing, then they will be set to zero.

### Editing Procedure

There are two methods for editing Sequence parameters.

#### ● Real-time Edit

This allows you to edit parameters by using the **VALUE** slider or foot volume while a rhythm is being played.

#### ● Step Edit

This allows you to edit parameters in each sound written in the pattern.

### a. Real-time Edit

This allows you to edit each parameter by using the **VALUE** slider or foot volume while a rhythm is being played.

**Using a Foot Volume** A foot volume may be useful for changing values continuously. Connect a foot volume (optional EV-5, EV-10) to the **VALUE** jack on the rear of the R-8. Pressing the pedal deeper increases values.

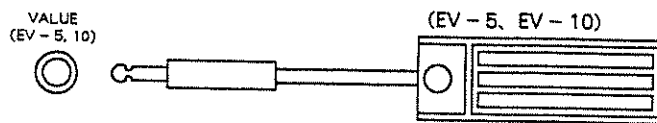



With the unit set to the Real-time Writing mode, do as follows.

Step 1 Press **PAGE** to turn to the Real-Time Editing mode.

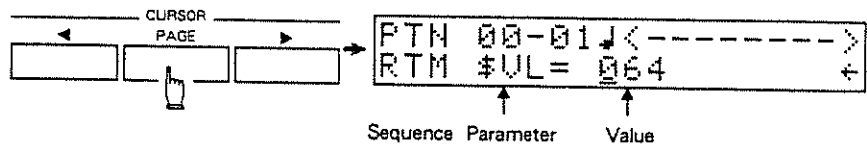

Step 2 Using **SELECT**, select the Sequence parameter to be edited.

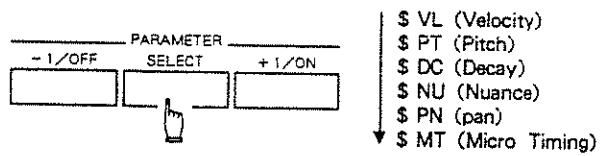

Step 3 Using **-1/OFF**, **+1/ON**, VALUE slider, Numerical Keys or foot volume edit the value of the parameter.

\*If you wish to change values continuously, set the basic value here (When using a foot volume, set the value with the foot volume).

Step 4 Press **START/STOP** to start playing.

Step 5 Hold down the key pad that corresponds to the Instrument to be edited. While the key pad is being pressed, the sequence parameters of the playing sound are edited.

To change values continuously, edit the value of the parameter while holding the key pad down.

\*The Micro Timing does not change during writing. To check it, set to the Pattern Play or Song Play mode.

Step 6 To continue, and edit the other parameters, repeat steps 2 to 5.

Step 7 Stop playing.

Step 8 Press **EXIT** to return to the Menu Display.

## b. Step Edit

Step Editing allows you to edit the Sequence parameters of each sound written in a rhythm pattern.

With the unit set to Normal Edit (or Scope Edit) in the Step Writing mode and stopped, do as follows.

**Step 1** Press the key pad that corresponds to the Instrument to be edited.

**Step 2** Using **SELECT**, select the parameter to be edited.

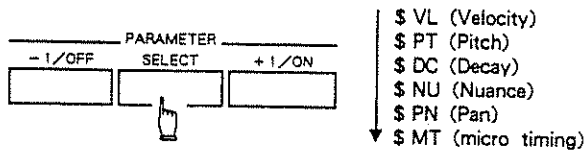

\*If you wish to listen to the actual sound, press **START/STOP** to start playing the rhythm.

**Step 3** Specify the Step number (or Scope Step number) to be edited with **◀** or **▶**, then using **-1/OFF**, **+1/ON**, **VALUE** slider or Numerical Keys, edit the value of the parameter.

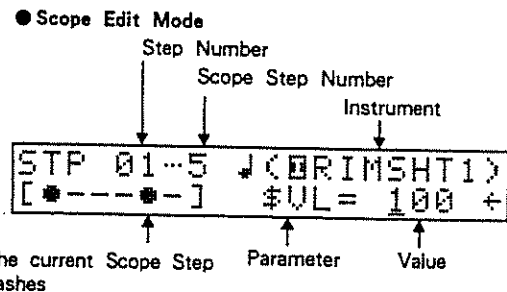
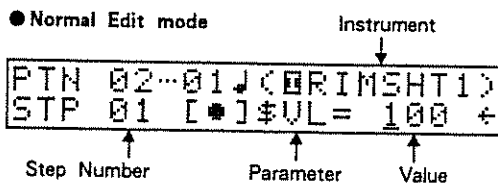

\*If no sound is entered in the Step number (or Scope Step number) you have selected, editing cannot be performed ("\*\*\*" is shown instead of the value).

\*The Micro Timing does not change during writing. To check it, set to the Pattern Play or Song Play mode.

- Step 4 To continue, and edit another Instrument, stop playing the rhythm, then specify the Instrument using the appropriate key pad.
- Step 5 Stop playing.
- Step 6 Press **EXIT** to return to the Menu display.

## 2. Timing Edit

The sound written in a rhythm pattern can be shifted forward or backward using 1/96 note unit (Macro Timing) or 1/384 note (Micro Timing).

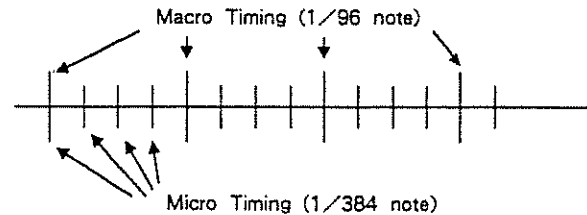

### a. Macro Timing Shift

The Macro Timing Shift function can shift the steps of a rhythm pattern for each note, in 1/96 note (Macro Timing) forward or backward.

\*Any note (step) pushed outside the rhythm pattern with the Macro Timing Shift will be automatically returned into the rhythm pattern.

With the unit set to the Normal Edit mode (or Scope Edit mode) in the Step Writing mode and stopped, take the following procedure.

- Step 1 Press the key pad that corresponds to the Instrument to be timing-shifted.
- Step 2 Using and , specify the Step number (or Scope Step number) to be timing-shifted.

- Step 3 Press key pad 9 while holding **SHIFT** down.

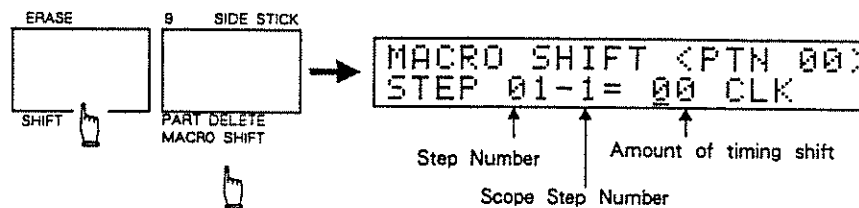

- Step 4 Using **-1/OFF** **+1/ON**, VALUE slider or Numerical Keys, set the amount of timing shift by clock number (-12 to +12 : 1 clock = 1/96 note). Negative values quicken the timing and positive values slow it.

\*Press **EXIT** to leave the mode.

- Step 5 Press **ENTER**.

The display shows the message "Completed", and the timing is changed.

## b. Micro Timing Shift

The sound written in a rhythm pattern can be shifted forward or backward using 1/384 note unit. The Micro Timing Shift can be performed for the entire Instrument (or rhythm pattern) or for each step.

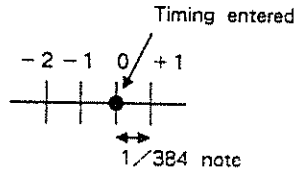

\*To perform the Micro Timing Shift for each step, see "Step Edit" on page 110.

\*If the Micro Timing Shift causes the sound to exceed the variable range (-2 to +1), it will be automatically corrected within the range.

With the unit set to a Pattern Mode ("PLAY", "REAL" or "STEP") and stopped, take the following procedure.

Step 1 Specify the rhythm pattern number whose timing should be shifted.

Step 2 Press key pad 10 while holding **SHIFT** down.

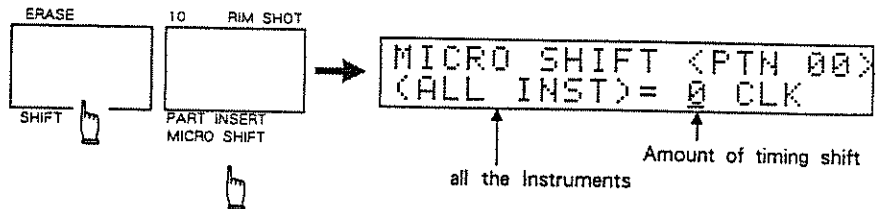

To shift the timing of all the Instruments, skip the following step 3 and go to step 4.

Step 3 Press the key pad that corresponds to the instrument to be timing-shifted. If necessary, change Pad Banks with **PAD BANK**.



#### ④ RHYTHM PATTERN EDITING

Step 4 Using **-1/OFF** **+1/ON** , VALUE slider or Numerical Keys, set the amount of timing shift (variable range : - 3 to + 3).

Negative values quicken the timing and positive values slow it.

\*To leave the mode, press **EXIT** .

Step 5 Press **ENTER** .

The display shows the message "Completed", and the timing is changed.

### 3. Pattern Edit

#### a. Instrument Change

The Instrument Change function allows you to swap an Instrument in a rhythm pattern with a different Instrument and play it.

With the unit set to a Pattern Mode ("PLAY", "REAL" or "STEP") and stopped, do as follows.

**Step 1** Specify the Pattern number for which you wish to use the Instrument Change function.

**Step 2** While holding **SHIFT** down, press key pad 1.

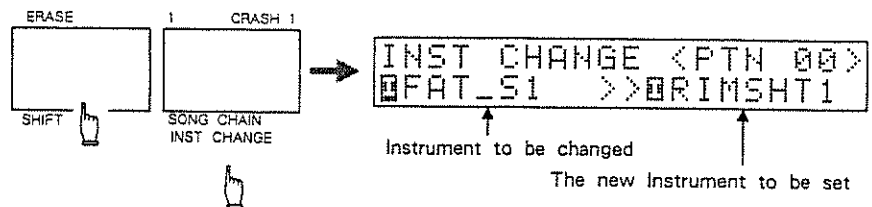

**Step 3** With **◀** and **▶**, move the cursor and specify the original Instrument and the new Instrument respectively with the corresponding key pads.

If necessary, change Pad Banks with **PAD BANK**.

\*To cancel this mode, press **EXIT**.

**Step 4** Press **ENTER**.

The display shows "Completed" and the Instrument Change is done.

\*If the Instrument you specify as the original Instrument does not exist, the message "Inst not found" is shown in the display and the Instrument Change is not executed.

## b. Pattern Append

Two rhythm patterns can be joined (appended), making one rhythm pattern. This may be useful for writing a Song that has a lot of same combinations of the specific Rhythm Pattern.

<Ex.> Appending Pattern 2 to Pattern 1

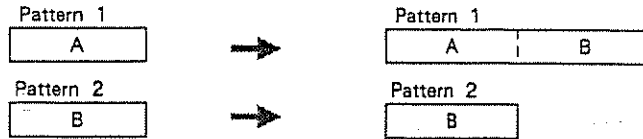

\*It is not possible to append the rhythm patterns of different time signatures.

\*The settings of the Swing, Flam and Feel Patch of the rhythm pattern selected in step 3 have priority.

\*If the total bar numbers of the two rhythm patterns exceeds 99, the Pattern Append cannot be executed.

With the unit set to a Pattern Mode ("PLAY", "REAL" or "STEP") and stopped, do as follows.

Step 1 Specify the Pattern number to be appended.

Step 2 While holding **SHIFT** down, press key pad 2.

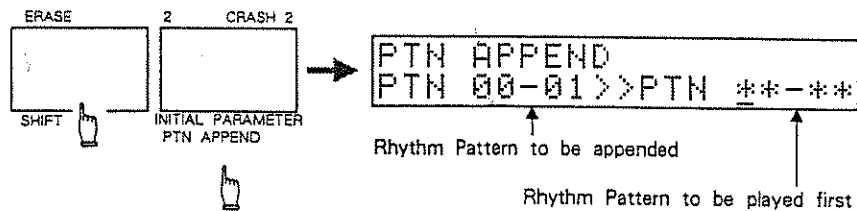

Step 3 Specify the Pattern number to be played first.

\*To cancel this mode, press **EXIT**.

Step 4 Press **ENTER**.

The display shows "Completed" and the Pattern Append is done.



### c. Pattern Extract

The Pattern Extract function allows you to extract the specified instrument data from a rhythm pattern and copy it to a different rhythm pattern number. This function may be used for using the same Instrument data in more than one rhythm pattern.

<Ex.> Extracting Pattern 1 and copying it into Pattern 2

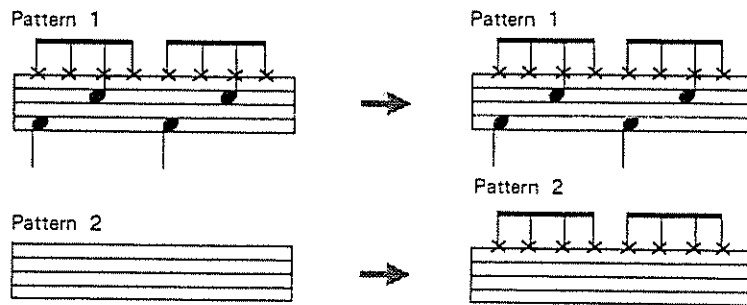

Set the unit to a Pattern mode ("PLAY", "REAL", or "STEP") and stopped. do as follows.

Step 1 Specify the Pattern number to be extracted.

Step 2 While holding **SHIFT** down, press key pad 3.

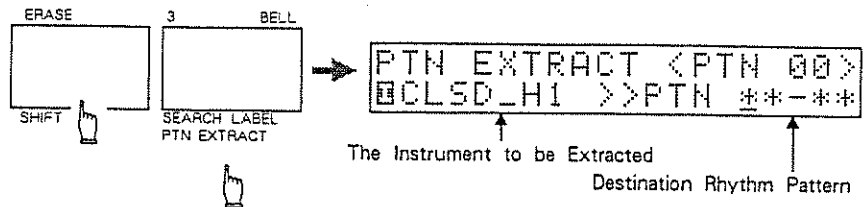

Step 3 Press the key pad that corresponds to the instrument to be extracted. If necessary, change Pad Banks with **PAD BANK**.

Step 4 Using **-1/OFF** **+1/ON**, **VALUE** slider or Numerical Keys, specify the destination Pattern (0 to 99).

#### 4) RHYTHM PATTERN EDITING

Step 5 Press **ENTER** .

If the destination rhythm pattern has no data, the message "Completed" appears in the display showing that the copy is done.

If there is any data written in the destination rhythm pattern, the message "Overwrite OK ?" appears in the display. To copy, press **ENTER** again, to cancel press **EXIT** .

\*Any previous data in the destination rhythm pattern is erased.

\*If the instrument you have specified in step 3 does not exist in the rhythm pattern, the message "inst not found" appears in the display and the copy is not executed.

### d. Pattern Merge

The Pattern Merge function mixes (merges) two rhythm patterns, making one rhythm pattern.

< Ex. > Merging Pattern 2 to Pattern 1

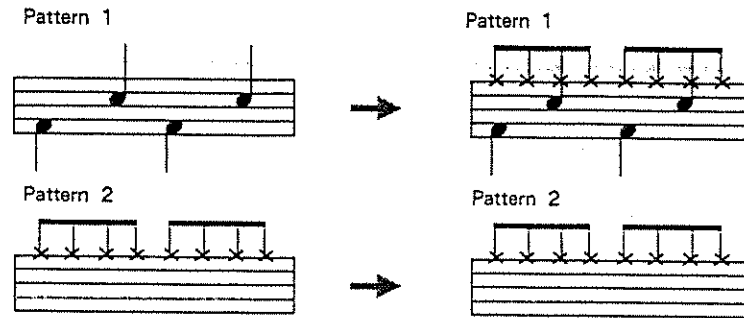

\*The merged rhythm patterns cannot be restored.

\*It is not possible to merge the rhythm patterns of different sizes or time signatures.

\*The settings of the Swing, Flam and Feel Patch of the destination rhythm pattern have priority.

Set the unit to a Pattern mode ("PLAY", "REAL", or "STEP") and stopped, do as follows.

Step 1 Specify the source Pattern number to be merged.

Step 2 While holding **SHIFT** down, press key pad 4.

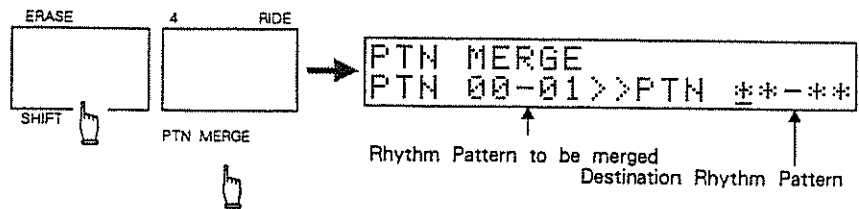

Step 3 Using **-1/OFF** **+1/ON**, VALUE slider or Numerical Keys, specify the destination Pattern (0 to 99).

\*To leave this mode, press **EXIT**.

Step 4 Press **ENTER**.

The message "Completed" appears in the display showing that the merge is done.

e. Reframe

The Reframe function allows you to set a start point at any position in a rhythm pattern and to shift the data from the start point to the end forward. This function may be useful to correct the delayed timing of the data you have entered when you are writing a rhythm pattern of more than one bar in Real-time.

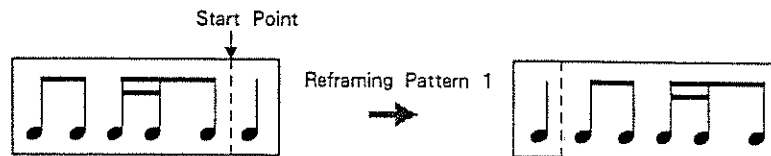

Set the unit to a Pattern mode ("PLAY", "REAL", or "STEP") and stopped, do as follows.

Step 1 Specify the Pattern number to be reframed.

Step 2 While holding **SHIFT** down, press key pad 11.

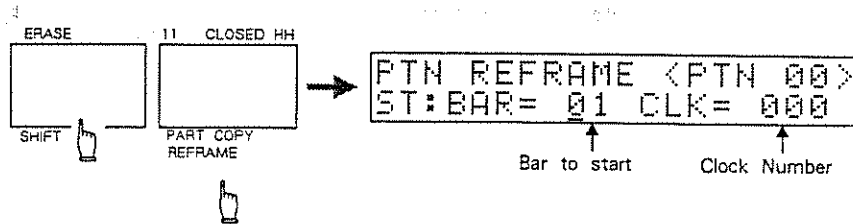

If you have specified a rhythm pattern of only one bar, skip the following step and go to step 4.

Step 3 Using **-1/OFF** **+1/ON**, VALUE slider or Numerical Keys, specify the first bar to be played.

Step 4 Move the cursor to the right with **◀** and **▶**, then using **-1/OFF** **+1/ON**, VALUE slider or Numerical Keys, specify the start point using clock number (1 clock = 1/96).

\*To leave this mode, press **EXIT**.

Step 5 Press **ENTER**.

The message "Completed" appears in the display showing that the reframe is done.

## f. Pattern Copy

This function copies a User-Pattern or Preset pattern to a different pattern number. There are two types of Pattern Copy; one is copying the entire rhythm pattern and the other is copying selected bars from the pattern, giving you total freedom to create Rhythm patterns and Songs.

< Ex. > Copying Pattern 1 to Pattern 2



< Ex. > Copying "B" bar in Pattern 1 into Pattern 2

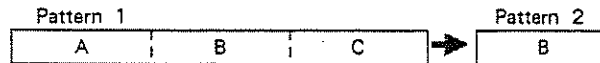

When using a User-pattern, set the unit to a Pattern mode ("PLAY", "REAL", or "STEP") and stopped, do as follows.

When using a Preset pattern, set the unit to "PRESET" and stopped, and take the following procedure.

**Step 1** Specify the Pattern number to be copied.

**Step 2** While holding **SHIFT** down, press key pad 13.

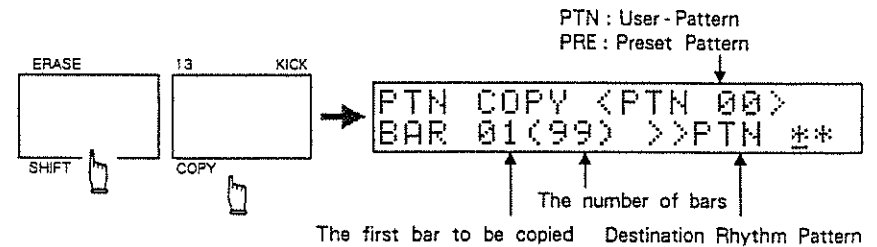

**Step 3** Using **-1/OFF** **+1/ON**, **VALUE** slider or **Numerical Keys**, specify the destination pattern number.

To copy the entire rhythm pattern, skip the next step and go to step 5.

#### 4 RHYTHM PATTERN EDITING

Step 4 Move the cursor with ◀ and ▶, then using -1/OFF +1/ON, VALUE slider or Numerical Keys, specify the first bar to be copied and the number of bars to be copied respectively.

Step 5 Press ENTER.

If the destination rhythm pattern has no data, the message "Completed" appears in the display showing that the copy is done.

If there is any data written in the destination rhythm pattern, the message "Overwrite OK ?" appears in the display. To copy, press ENTER again, to cancel press EXIT.

\*Any previous data in the destination rhythm pattern is erased.

\*If the number of bars to be copied exceeds the total length of the rhythm pattern, the rhythm pattern will be copied up to the end.

## g. Pattern Name

A rhythm pattern can be named using up to 8 letters. The Pattern Name is shown in the display in the Pattern Play and Pattern Write mode.

Pattern names will help you recognize rhythm patterns when writing a song.

Set the unit to a Pattern mode ("PLAY", "REAL", or "STEP") and stopped, do as follows.

**Step 1** Specify the Pattern number to be named.

**Step 2** While holding **SHIFT** down, press key pad 15.



**Step 3** Move the cursor with **◀** and **▶**, then using **-1/OFF** **+1/ON**, VALUE slider or Numerical Keys, select numbers/letters/symbols.

Pressing a Numerical Key also offers switching between numbers, letters and symbols (the letters and symbols written at the upper right of each key). Pressing a Numerical Key while holding **SHIFT** down will produce lowercase letters.

**Step 4** Press **ENTER** to return to the previous display.





# SONG PROGRAMMING

<b>1</b>	Song Write	P. 126
----------	------------	--------

<b>2</b>	Song Edit	P. 135
----------	-----------	--------

<b>3</b>	Functions for Song Play	P. 143
----------	-------------------------	--------

# 1 SONG WRITE

The R-8 allows you to write up to ten songs using the rhythm patterns you have programmed. Tempo and level data can also be written in a song.

\*Preset rhythm patterns cannot be used for a song unless you copy them into User-programmed pattern with the Pattern Copy function (see page 121).

## Song Data

Repeat, Tempo Change, Level Change and Label data can be written in a Song as well as rhythm patterns.

### ●Repeat

This repeats playing the specified rhythm patterns in a Song.

### ●Tempo Change

The tempo of a song can be changed for each Rhythm pattern.

### ●Level Change

The level of a song can be changed for each Rhythm pattern.

### ●Label

This allows you to put a label (within eight letters) at a certain position in a Song. Later, with the Search Label function, you can quickly access the labeled position.

## Song Structure

Rhythm Patterns and the relevant data are written into a song as a PART which is a unit constructing a song. Parts written in a song are numbered (Part Number) in the sequence as they have been written. One song can contain up to 999 Parts.

Part Number	001	002	003	004	005	006	007	008	009
Song Data	Rhythm Pattern 01	Rhythm Pattern 02	Tempo Change	Repeat   :	Rhythm Pattern 04	Repeat :   × 1	Label	Level Change	Rhythm Pattern 10

●Tempo and Level Change parameters: These have effect on the succeeding rhythm patterns (after the Tempo or Level changes are entered).

●Repeat parameter: This repeats the rhythm patterns between the beginning and ending Parts (using the repeat signs as show above).

# 1. Song Writing

Let's write a song using rhythm patterns.

Step 1 Press **SONG** to turn to the Song Mode.

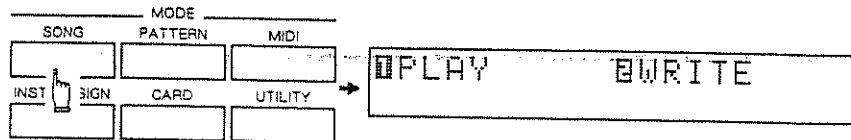

\*If the Menu Display is not shown, press **EXIT**.

Step 2 Press Numerical Key 1, to select "PLAY", then specify a song number.

Step 3 Press **EXIT** to return to the Menu display, then specify "WRITE" pressing Numerical Key 2.

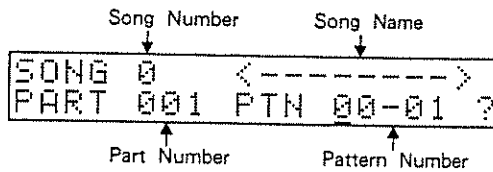

\*To erase the entire song data, take the Song Clear procedure (see page 141).

Step 4 Using **-1/OFF** **+1/ON**, VALUE slider or Numerical Keys, specify a pattern number (0 to 99) to be written in the song.



? :Indicated when no rhythm pattern is written in the Part currently shown.

To play the rhythm pattern you have specified, press **START/STOP**.

## 1 SONG WRITE

Step 5 Press **ENTER**.

The rhythm pattern is written in the song, a part number in the display advanced.

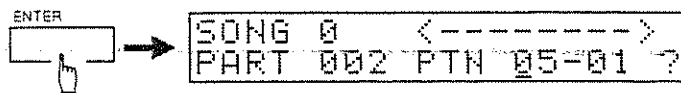

Step 6 Repeat steps 4 and 5 until you have written up to the last bar.

Step 7 If the unit is playing a rhythm pattern, stop it.

Step 8 Press **EXIT** to return to the Menu Display.

## Changing Pattern Numbers

To change the Pattern Numbers written in a song afterwards, do as follows with the unit set to the Song Write mode.

Step 1 Specify the Part of the pattern number to be changed with **◀** and **▶**. Pressing **▶** (or **◀**) while holding **◀** (or **▶**) down will quicken the change of the Part numbers.

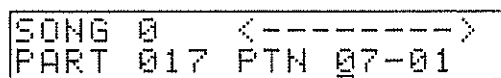

Step 2 Using **-1/OFF** **+1/ON**, VALUE slider or Numerical Keys, specify the pattern number (0 to 99) to be changed.

Step 3 Press **ENTER**.

Now the rhythm patterns are rewritten.

Step 4 Repeat the above procedures as many times as necessary.

\*To delete a Part or insert a new Part, see page 135 "Song Edit".

## 2. Repeat

The Repeat function allows you to repeat playing the rhythm patterns you have specified. Specify the first (||:) and last (:||) Parts to be played, then the number of repeats, if you like.

Song Data						
Rhythm Pattern A	Repeat   :	Rhythm Pattern B	Rhythm Pattern C	Repeat :   x 1	Rhythm Pattern D	Rhythm Pattern E
Song Playing						
Rhythm Pattern A	Rhythm Pattern B	Rhythm Pattern C	Rhythm Pattern B	Rhythm Pattern C	Rhythm Pattern D	Rhythm Pattern E

Shown as above are the repeat marks. To insert Repeat Parts after having written a song, use the Part Insert procedure (see page 136).

- Step 1 Before writing a rhythm pattern where the repeat starts, select "REP ||:" with **SELECT**.

```
SONG 0 <----->
PART 017 REP ||: ?
```

↑  
Repeat Mark

- Step 2 Press **ENTER**.  
Repeat Part for start (||:) is written.

- Step 3 Write the rhythm patterns to be repeated.

- Step 4 Select "REP :|| x 01" with **SELECT**, then using **-1/OFF** **+1/ON**, VALUE slider or Numerical Keys, specify the number of repeats (1 to 99).

```
SONG 0 <----->
PART 022 REP || x01 ?
```

↑  
Number of Repeats

- Step 5 Press **ENTER**.  
Repeat ending is written (:||).

\*Within one set of Repeat Marks another eight sets of Repeat Marks can be used.

\*When the number of start marks (|:) does not match the number of end marks (:|), the song will be played as follows.

< Ex. >

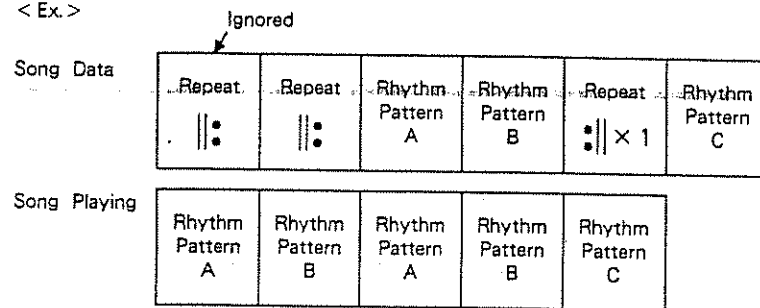

### 3. Tempo Change

It is possible to insert a Tempo Change in a Part of a song.

Song Data	Rhythm Pattern A	Rhythm Pattern A	Tempo Change +10	Rhythm Pattern B	Rhythm Pattern C
Song Playing	Rhythm Pattern A	Rhythm Pattern A	Rhythm Pattern B	Rhythm Pattern C	
Tempo	120	120	130	130	

Shown above are Tempo Change Parts written inbetween the patterns. To insert a Tempo change Part after having written a song, use the Part Insert procedure (see page 136).

- Step 1 Before entering a rhythm pattern where you wish to change Tempo, select "TEMPO" with **SELECT**.

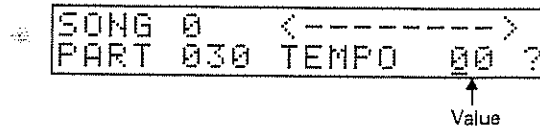

- Step 2 Set the amount of tempo to be changed (-99 to +99), using **-1/OFF** **+1/ON** or Numerical Keys.

Negative values reduce the tempo and positive values increase it.

- Step 3 Press **ENTER**.

Tempo Part is written.

\*The tempo value set here is the amount of tempo to be changed from the base tempo. Should the total of the base tempo and the tempo value set here exceed 20 to 250, there will be no effect beyond the range.

## 4. Level Change

It is possible to insert a Level Change in a Part of a song.

Song Data	Rhythm Pattern A	Rhythm Pattern B	Level Change - 8	Rhythm Pattern C	Rhythm Pattern D
Song Playing	Rhythm Pattern A	Rhythm Pattern B	Rhythm Pattern C	Rhythm Pattern D	
Level	32	32	24	24	

Shown above is a Level Change written inbetween the patterns. To insert a Level change after having written a song, use the Part Insert procedure (see page 136).

- Step 1 Before entering a rhythm pattern where you wish to change levels, select "LEVEL" with **SELECT**.

```

SONG 0 <----->
PART 030 LEVEL 00 ?
    
```

↑  
Value

- Step 2 Set the amount of level to be changed (- 32 to + 32) using **-1/OFF**, **+1/ON**, VALUE slider or Numerical Keys.

Negative values decrease the level and positive values increase it.

- Step 3 Press **ENTER**.

Level Part is written.

\*The level value set here is the amount of level to be changed from the Initial Level (see page 145). Should the total of the Initial Level and the value set here exceed the maximum level, higher levels will not be obtained.



## 5. Label

The Label function allows you to put a Label at any place in a song, and name the Label using up to eight letters.

If a label is written at important position in a song, you can quickly go to the specified label even after the Part numbers are changed by Part Delete or Part Insert, using the Search Label function.

Also, in song playing, you can start playing from the labeled position.

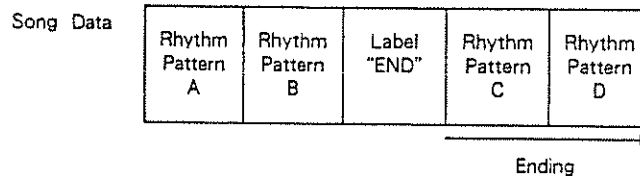

### a. Label Setting

Shown above is a Label inserted inbetween rhythm patterns. To enter a Label Part after having written a song, use the Part Insert procedure (see page 136).

- Step 1** Before writing a rhythm pattern where you wish to put a Label, select " " with **SELECT** .

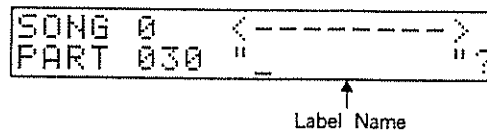

- Step 2** Move the cursor with **-1/OFF** **+1/ON** , then name the Label using VALUE slider or Numerical Keys.

Pressing the Numerical Key switches alternately between numbers and letters /symbols (written at the upper right of each key). To write a small letter, press the Numerical Key while holding **SHIFT** down.

- Step 3** Press **ENTER** .  
Label Part is written.

## b. Search Label

When more than one label are written, all the labels will be searched in sequence until the Part of the assigned label is found.

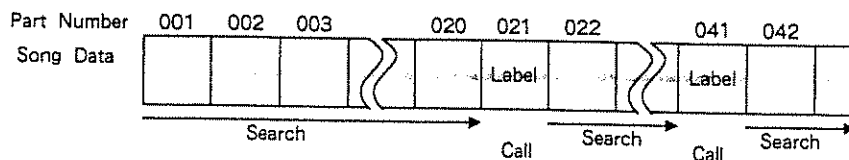

\*See page 146 for details of how to use the Search Label function in Song Play.

With the unit set to the Song Write mode and stopped, do as follows.

**Step 1** Press key pad 3 while holding **SHIFT** down.

The Label Search starts from the beginning of the song. When the first label is found, the display responds with :

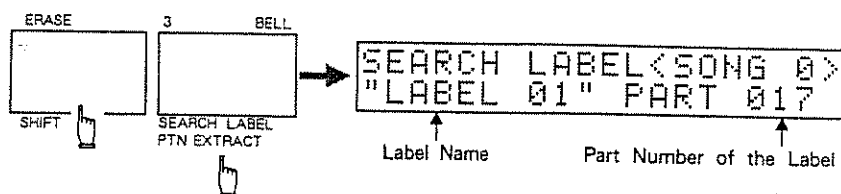

\*When the label is not found, "Label not found" is shown in the display.

**Step 2** To search for another label, press **-1/OFF** or **+1/ON**.

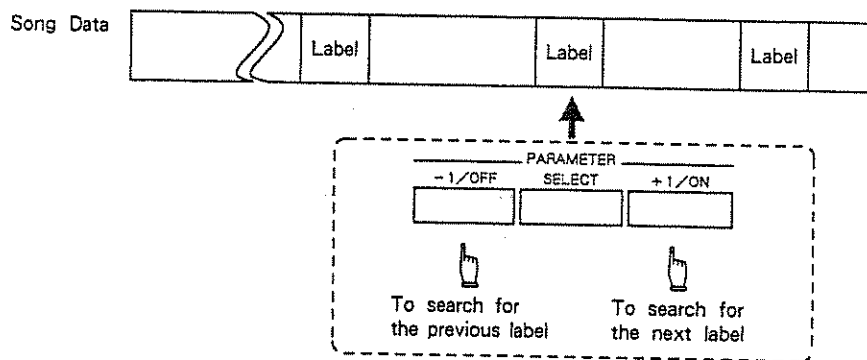

**Step 3** Press **ENTER** to return to the display of Song Write mode.

# 2 SONG EDIT

## 1. Part Delete

Specified Parts can be deleted.

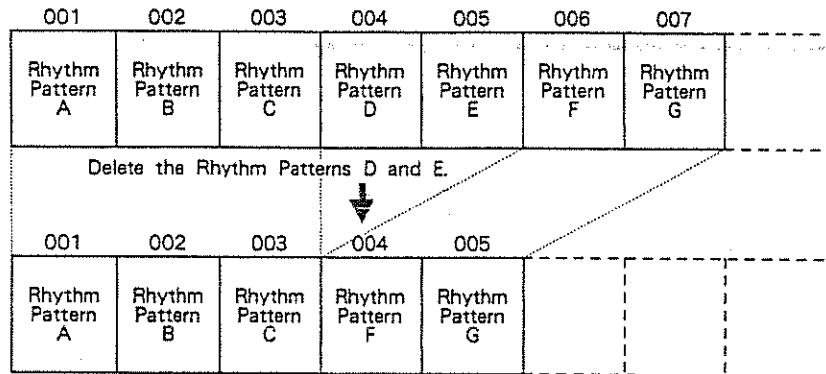

With the unit set to the Song Write mode and stopped, do as follows.

Step 1 Specify the Part where the deleting starts using **◀** and **▶**.

Step 2 Press key pad 9 while holding **SHIFT** down.

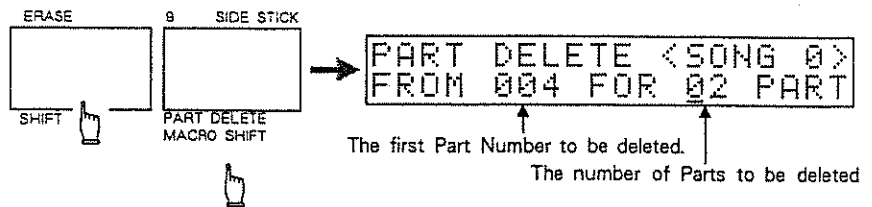

Step 3 Specify the number (1 to 99) of Parts to be deleted using **-1/OFF**, **+1/ON**, VALUE slider or Numerical Keys.

\*It is not possible to set the number of Part larger than the number of Parts you have used in the Song.

\*To leave this mode, press **EXIT**.

Step 4 Press **ENTER**.

"Completed" appears in the display showing that the deleting is done.

\*If there is no Part to be deleted, the "No Part exists" message appears in the display.

## 2. Part Insert

A new Part can be inserted inbetween any Part Numbers.

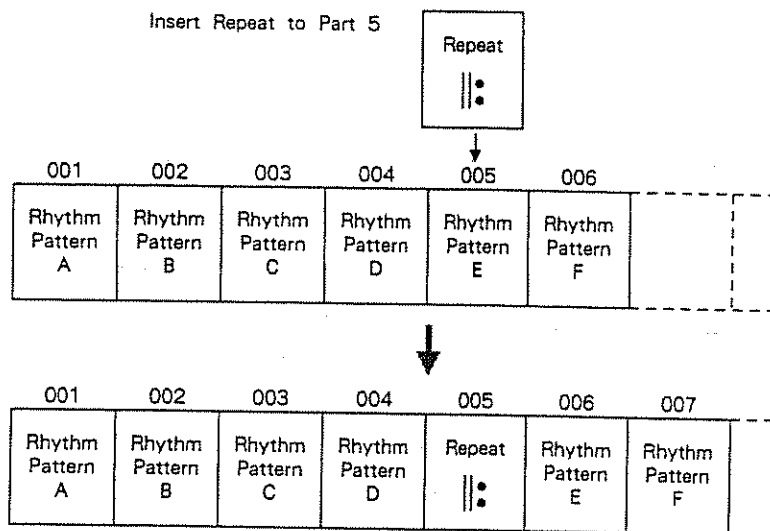

With the unit set to the Song Write mode and stopped, do as follows.

**Step 1** Specify the Part number where a new Part is to be inserted using and .

\*The new Part is inserted before the specified Part.

**Step 2** Press key pad 10 while holding **SHIFT** down.

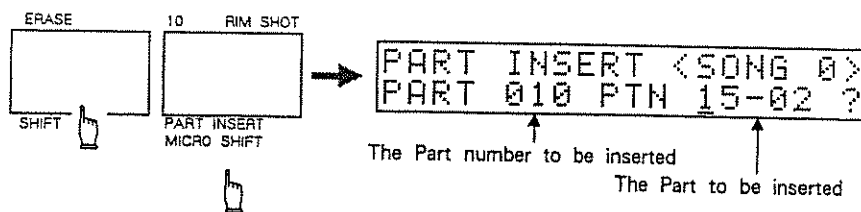

**Step 3** Specify the Part to be inserted.

●To insert a rhythm pattern, specify the rhythm pattern number using **-1/OFF** **+1/ON**, VALUE slider or Numerical Keys.

●To insert Repeat/Tempo Change/Level Change/Label, select the relevant parameter with **SELECT**, then set the value.

\*How to set each parameter is explained on page 129 (Repeat), 131 (Tempo Change), 132 (Level Change) or 133 (Label).

\*To leave this mode, press **EXIT**.

Step 4 Press **ENTER**.

"Completed" appears in the display showing the insertion is done.

### 3. Part Copy

The Part Copy function copies specified Parts (Source Parts) to other Parts (destination). This function may be useful for writing a song consisting of the same patterns.

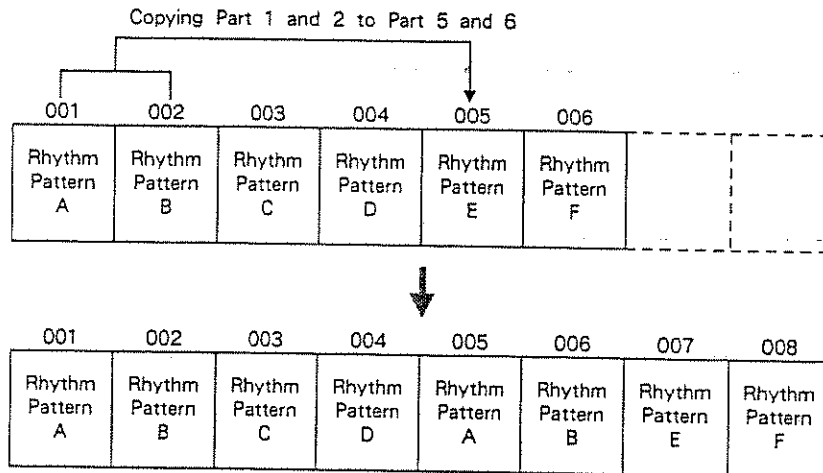

\*The Part Copy function cannot copy Parts to a different song.

\*It is not possible to copy Parts into Parts which are specified as source Parts.

With the unit set to the Song Write mode and stopped, do as follows.

Step 1 Specify the destination Part number using and .

Step 2 Press key pad 11 while holding down.

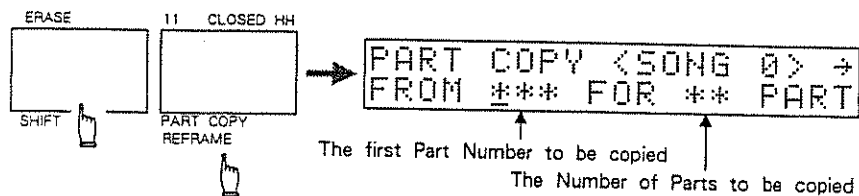

Step 3 Move the cursor with and , then specify the first Part to be copied and the number of Parts (1 - 99) to be copied using , VALUE slider or Numerical Keys.

Step 4 Press **PAGE** to select Copy Number setting display.

```

PART COPY <SONG 0> +
COPY TIMES 1
    
```

↑  
Number of copies

Step 5 Set how many times the Parts should be copied with **-1/OFF** **+1/ON**, VALUE slider or Numerical Keys. (Valid: 1 to 9)

\*To leave this mode, press **EXIT**.

Step 6 Press **ENTER**.

"Completed" appears in the display showing the copying is done.

\*If you have assigned the destination Part within the Part that has been specified, "Part overlap" is displayed, and the Step 2 display is returned to. When this happens, repeat step 3 to 6.

\*If the specified Part does not exist, "No part exists" is displayed.

## 4. Song Copy

The entire data of a song can be copied to another song number. This function may be useful for retaining the source song data before experimenting with various edits.

With the unit set to the Song Play mode and stopped, do as follows.

Step 1 Specify the source Song number to be copied.

Step 2 Press key pad 13 while holding **SHIFT** down.

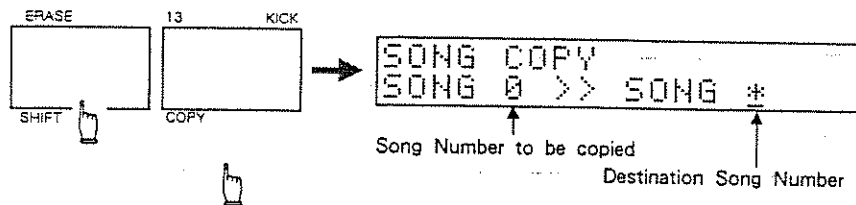

Step 3 Specify the destination Song number using **-1/OFF**, **+1/ON**, VALUE slider or Numerical Keys.

\*To leave this mode, press **EXIT**.

Step 4 Press **ENTER**.

When the destination song does not have any data, the copying is done and "Completed" appears in the display.

When there is data in the destination song, the display shows the message "Overwrite OK?". If you wish to copy, press **ENTER**, and to stop copying, press **EXIT**.



## 5. Song Clear

The Song Clear function clears the entire song data. Use this function to write a song from scratch.

With the unit set to the Song Play mode and stopped, do as follows.

**Step 1** Specify the Song number to be cleared.

**Step 2** Press key pad 14 while holding **SHIFT** down.

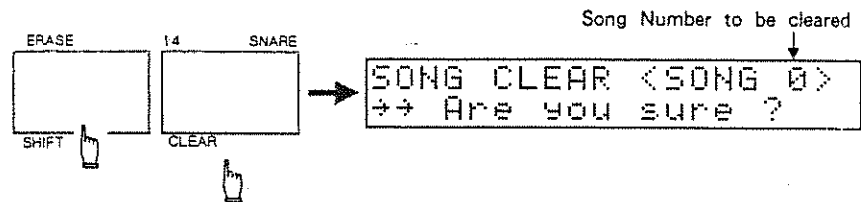

\*To leave this mode, press **EXIT**.

**Step 3** Press **ENTER**.

"Completed" appears showing that the song clear is done.

## 6. Song Name

The Song Name function allows you to name each song within eight letters.

The Song name you have written appears in the display in the Song Play or Write mode for you to check.

With the unit set to the Song Play mode and stopped, do as follows.

**Step 1** Specify the Song number to be named.

**Step 2** Press key pad 15 while holding **SHIFT** down.

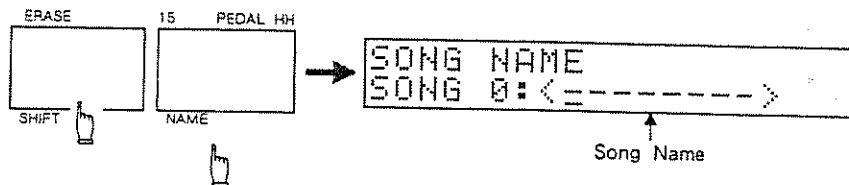

**Step 3** Move the cursor with **◀** and **▶**, then name the Song using **-1/OFF**, **+1/ON**, VALUE slider or Numerical Keys.

Pressing the Numerical Key also switches alternately between numbers and letters/symbols (written at the upper right of each key). To write a small letter, press the Numerical Key while holding **SHIFT** down.

**Step 4** Press **ENTER** to return to the previous display.

## 3 FUNCTIONS FOR SONG PLAY

### 1. Continue Play

This allows you to start playing a song from the exact point where you have stopped, or from a selected bar as show below.

With the unit set to the Song Play mode and stopped, do as follows :

- Step 1 Move the cursor to "MEAS" with ◀ and ▶, then using [-1/OFF] or Numerical Keys, specify the bar where you wish to start playing.

```

SONG 0 <----->
MEAS 0017 PTN 35^01
    
```

↑  
The first bar to be played

- Step 2 Press [START/STOP] while holding [SHIFT] down.

## 2. Song Chain

In each song, you can specify one song number to be played next (in the Chain). By setting a song number to be chained in each song, you can play more than one song continuously.

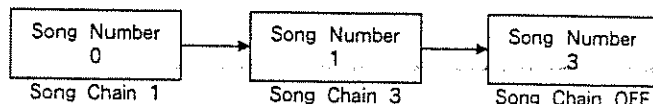

With the unit set to the Song Play mode and stopped, do as follows :

- Step 1** Specify the song number.
- Step 2** Press key pad 1 while holding **SHIFT** down.

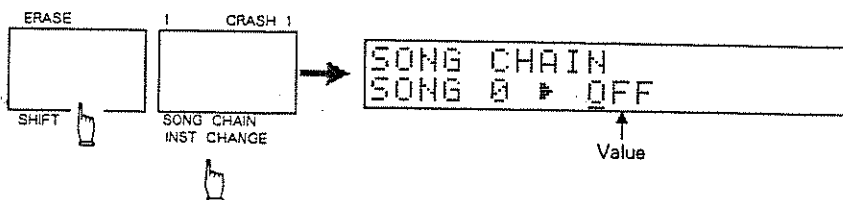

- Step 3** Specify the song numbers (0 to 9) to be chained using **-1/OFF** **+1/ON**, **VALUE** slider or Numerical Keys.  
To set the Song Chain function off, select "OFF". To repeat playing one song, specify the same song number.
- Step 4** Press **ENTER** to return to the previous Display.

The song number you have set here will be shown during song playing.

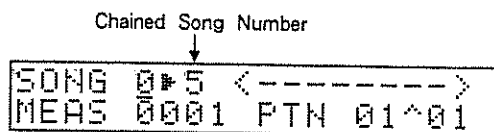

### 3. Initial Tempo and Initial Level

Each song can have a base tempo and level (initial tempo and level) for playing. The initial tempo and level you set will be automatically selected when selecting a song.

With the unit set to the Song Play mode and stopped, do as follows :

Step 1 Specify the song number whose initial tempo or level you wish to set.

Step 2 Press key pad 2 while holding **SHIFT** down.

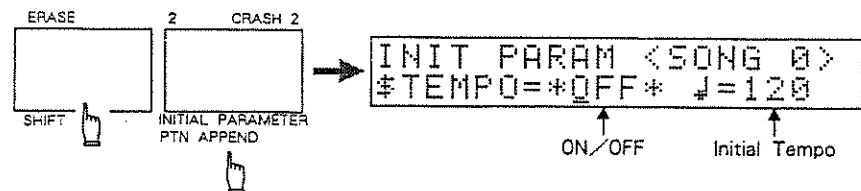

Step 3 Select ON/Off of the initial tempo using **-1/OFF** **+1/ON** or VALUE slider.  
 ON : The initial tempo you set is used  
 OFF : The initial tempo is not set

Step 4 Move the cursor to the right with **▶**, then set the initial tempo (20 – 250) using **-1/OFF** **+1/ON**, or Numerical Keys.

Step 5 Press **SELECT** to make the display show the initial level.

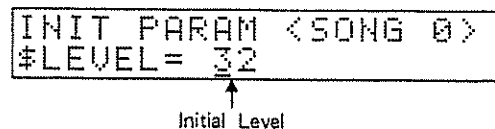

Step 6 Set the initial level (0 – 32) using **-1/OFF** **+1/ON**, VALUE slider or Numerical Keys.

Step 7 Press **ENTER** to return to the previous display.

## 4. Search Label

This function allows you to search for the label set in a song and play from the next rhythm pattern.

\*How to set labels is fully explained on page 133.

With the unit set to the Song Play mode and stopped, do as follows :

**Step 1** Press key pad 3 while holding **SHIFT** down.

Labels are searched from the beginning of the song. When the first label is found, the display responds with :

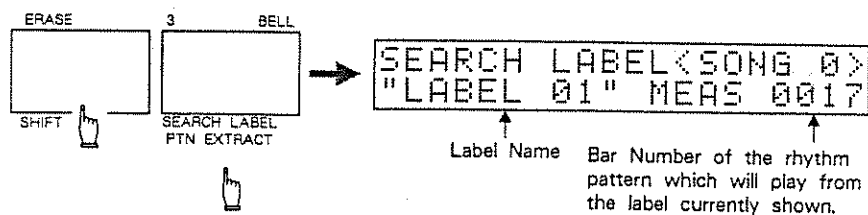

\*When the label is not found, the message "Label not found" appears.

**Step 2** To search another label, press **-1/OFF** **+1/ON**.

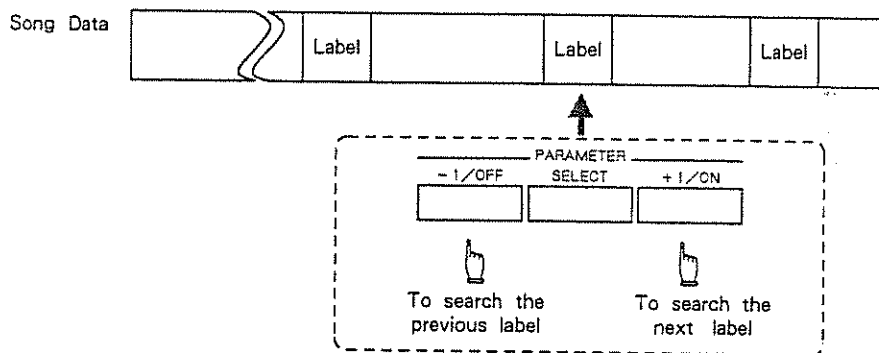

**Step 3** Press **ENTER** to return to the display of Song Play mode.

**Step 4** Press **START/STOP** while holding **SHIFT** down, and the song starts playing from the label.

## 5. Time Calculate

This function allows you to calculate the time needed for a song to be played up to the last bar or a specific bar according to the initial tempo (see page 145) set in the song.

\*The Time Calculate function is not obtained unless the Initial Tempo is set to ON.

### Time Calculation for the entire song

With the unit set to the Song Play mode and stopped, do as follows:

Step 1 Specify the song number for which you wish to calculate time.

Step 2 Press key pad 5 while holding **SHIFT** down.

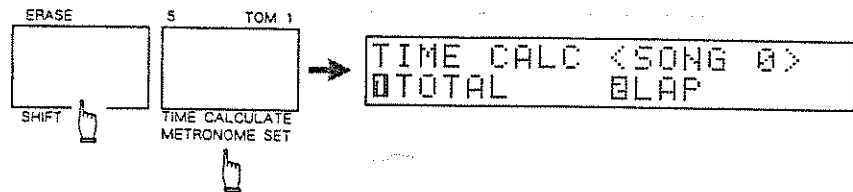

Step 3 Press Numerical Key 1 to select "TOTAL".

The display shows "Calculating", showing that the total time is now being calculated, and calculated time is later displayed.

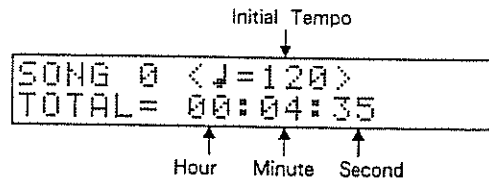

Step 4 Press **ENTER** to return to the previous display.

\*If The Initial Tempo is set to "OFF", "Init Tempo Off" message appears in the display.

### 3 FUNCTIONS FOR SONG PLAY

#### Time Calculation up to the specified bar

With the unit set to the Song Play mode and stopped, do as follows.

Step 1 Play the song up to the bar where you wish to calculate time.

\*You can also specify the bar number using **-1/OFF** **+1/ON** or Numerical Keys: with the unit set to the Song Play mode and stopped, move the cursor to "MEAS" with **◀** and **▶**, then set the bar using **-1/OFF** **+1/ON** or Numerical Keys. In this case, the unit calculates the time needed before the specified bar starts playing.

Step 2 Press key pad 5 while holding **SHIFT** down.

Step 3 Press Numerical Key 2 to select "LAP".

The display shows "Calculating", showing that the time is now being calculated.

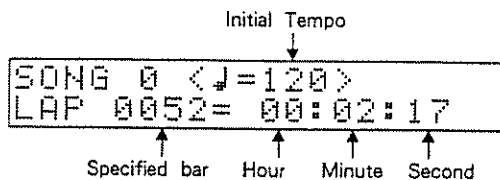

Step 4 Press **ENTER** to return to the previous display.



## 6. Time Display

The Time Display function allows you to check the time spent so far from the moment the song starts playing or resumes playing with the Continue Play (see page 143).

With the unit set to the Song Play mode and stopped, do as follows :

- Step 1** Press key pad 6 while holding **SHIFT** down.

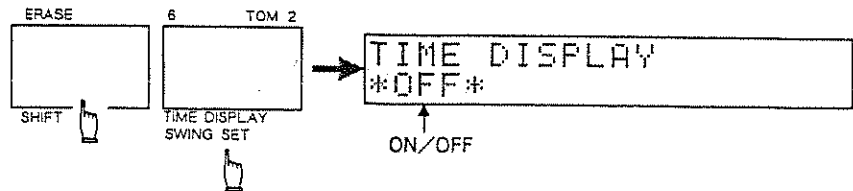

- Step 2** Select ON/OFF of the Time Display function using **-1/OFF** **+1/ON** or VALUE slider.

ON : The playing time is displayed

OFF : The playing time is not displayed

- Step 3** Press **ENTER** to return to the previous display.

With the Time Display function set to ON, the display responds as shown below during song playing.

Performance time  
↓

```

SONG 0 <00:02:17>
MEAS 0052 PTN 20^01
    
```

## 7. Time Set

This function allows you to set the initial tempo so that the song can be played within the specified time.

With the unit set to the Song Play mode and stopped, do as follows.

\*The Time Set function is not obtained unless the Initial Tempo (see page 145) is set to ON.

Step 1 Specify the song number which you wish to time set.

Step 2 Press key pad 7 while holding **SHIFT** down.

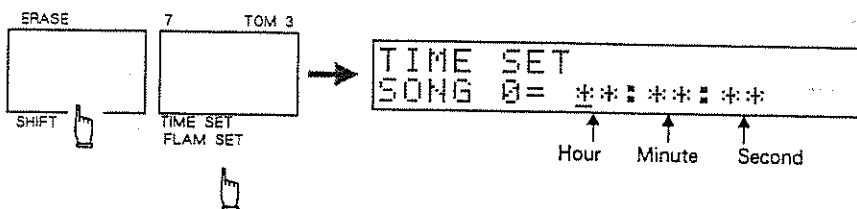

Step 3 Move the cursor with **◀** and **▶**, then set the performance time with **-1/OFF** **+1/ON**, VALUE slider or Numerical Keys.

Step 4 Press **ENTER**.

"Calculating ..." appears showing that the initial tempo is now being calculated, and the set initial tempo is later displayed.

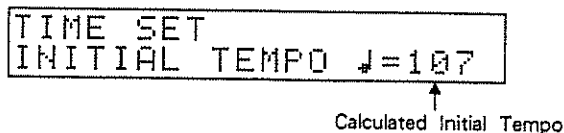

\*When the initial tempo exceeds 20 to 250, the display shows "Out of range", and the initial tempo is not entered.

Step 5 Press **ENTER** again to return to the previous display.

\*If The Initial Tempo is set to "OFF", "Init Tempo Off" message appears in the display.

# OTHER USEFUL FUNCTIONS

1	Utility	P. 152
2	Users Function	P. 154
3	Initialization	P. 158
4	Memory Card (RAM)	P. 162
5	Sync Play	P. 167
6	MIDI	P. 172

# 1 UTILITY

The Utility Mode is accompanied by three functions :

- Available Memory (checking the remaining memory of the song and rhythm patterns)
- All Song Clear (erasing the entire song data)
- All Pattern Clear (erasing all the User-programmed rhythm patterns)

## a. Available Memory

This function allows you to check the remaining memory for the song and rhythm pattern data. It is shown in percentage (%). At 0%, no more data can be written.

Step 1 Press **UTILITY** to turn to the Utility Mode.

Step 2 Press Numerical Key 3 to select "AVAIL".

```
AVAILABLE MEMORY  
SONG= 70% PTN= 60%
```

↑ Remaining memory for songs      ↑ Remaining memory for rhythm patterns

The remaining memory capacity for songs and rhythm patterns is shown.

Step 3 Press **EXIT** to return to the menu display.

## b. All Song Clear

This function erases the entire song data in the R-8.

Step 1 Press **UTILITY** to turn to the Utility Mode.

Step 2 Press Numerical Key 1 to select "SONG CLR".

```
ALL SONG CLEAR
++ Press ENTER.
```

Step 3 Press **ENTER**.

```
ALL SONG CLEAR
++ Are you sure ?
```

\*To leave this mode, press **EXIT**.

Step 4 Press **ENTER**.

"Completed" appears in the display showing that all songs are erased.

## c. All Pattern Clear

This function erases the entire User-programmed pattern data in the R-8.

Step 1 Press **UTILITY** to turn to the Utility Mode.

Step 2 Press Numerical Key 2 to select "PTN CLR".

```
ALL PATTERN CLEAR
++ Press ENTER.
```

Step 3 Press **ENTER**.

```
ALL PATTERN CLEAR
++ Are you sure ?
```

\*To leave this mode, press **EXIT**.

Step 4 Press **ENTER**.

"Completed" appears in the display showing that all rhythm patterns are erased.

## 2 USERS FUNCTION

The Users function allows you to set a sequence of keystrokes. Up to ten different settings (Users functions) can be registered. Once the sequence of the procedures (Users function) are registered, you can perform the entire procedure just by calling it.

**How to register the Users function** With the unit stopped, a sequence of procedures can be registered in a Users function as follows :

Step 1 Press **DEFINE** .



Step 2 Press **FUNCTION** .

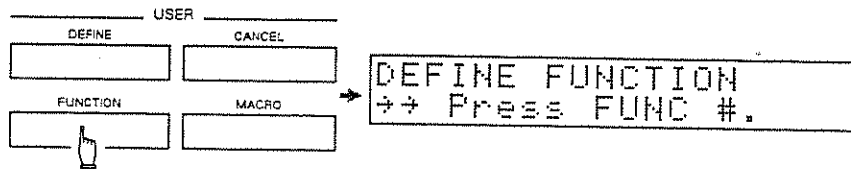

Step 3 Specify the number of the Users function to be used with Numerical Keys 0 to 9.

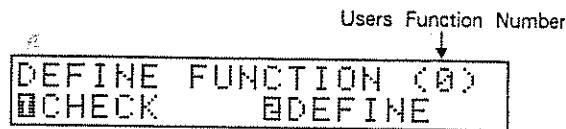

Step 4 Press Numerical Key 2 to select "DEFINE".

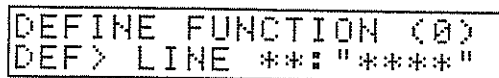

Step 5 Press the buttons in the sequence you wish to register (Up to 16 button procedures can be registered).

```
DEFINE FUNCTION (0)
DEF> LINE 01:"PTN "
```

Line Number (1 - 16)      Name of the pressed button

\*If you fail to specify the buttons in the right order from mode selection, the registered buttons do not function properly.

\*Each time you register a button procedure, a line number advances.

\*CANCEL, DEFINE, MACRO and FUNCTION buttons cannot be registered.

\*Pattern writing procedure with key pads cannot be registered.

Step 6 Press **DEFINE** to return to the previous display.

[Ex.]

●With the unit stopped, play from the 17th bar of Song number 3.

Line Number	Button	Display	Operation
1	SONG	SONG	Select the Song Play Mode
2	EXIT	EXIT	
3	Numerical Key 1	N1	
4	Numerical Key 3	N3	Select Song No. 3
5	▶	CUR >	Assign bar 17
6	Numerical Key 0	N0	
7	Numerical Key 0	N0	
8	Numerical Key 1	N1	
9	Numerical Key 7	N7	Continue to start
10	SHIFT	SHFT	
11	START/STOP	S/S	

●With the unit in the Real-time Writing mode and Stopped, erasing the entire data of the next pattern number, and setting for four-quarter time, one bar.

Line Number	Button	Display	Operation
1	PATTERN	PTN	Select the Real-Time Write
2	EXIT	EXIT	
3	Numerical Key 3	N3	
4	◀	CUR <	Select the next rhythm pattern
5	◀	CUR <	
6	+ 1/ON	PAR >	
7	SHIFT	SHFT	Erase the entire data to set it to four-quarter time and single bar
8	Key Pad 14	PD14	
9	ENTER	ENTR	
10	ENTER	ENTR	

### Executing the registered Users function

Specify the Users Function you have registered to execute it.

Step 1 Press **FUNCTION**.

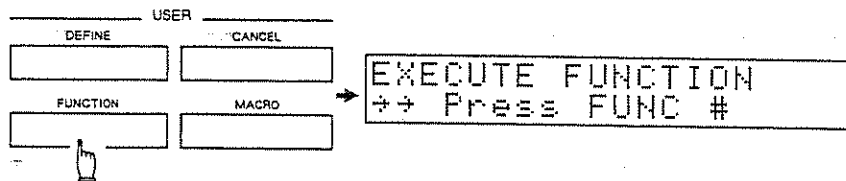

Pressing **FUNCTION** again will return to the previous display.

Step 2 Specify the number of the Users function to be used with the Numerical Keys. The selected Users function is now performed.

### Checking the Users function

To check the Users Function you have registered, with the unit stopped, use the following procedure.

Step 1 Press **DEFINE**.

Step 2 Press **FUNCTION**.

Step 3 Specify the number of the Users Functions (0-9) you wish to check with the Numerical Keys. (0 to 9)

Step 4 Press Numerical Key 1 to select "CHECK".

```
DEFINE FUNCTION (0)  
CHK> LINE 01: "SONG"
```



Step 5 Using **-1/OFF** **+1/ON**, change the line numbers to display the button name of each line number.

Display	Button	Display	Button	Display	Button
SONG	SONG	PAD	PAD BANK	EXIT	EXIT
PTN	PATTERN	MLT	MULTI	ENTR	ENTER
MIDI	MIDI	SCP	SCOPE	PAR <	- 1/OFF
ASGN	INST ASSIGN	CUR >	▶	SEL	SELECT
CARD	CARD	PAGE	PAGE	PAR >	+ 1/ON
UTIL	UTILITY	CUR <	◀	S/S	START/STOP
SND	SOUND	TMP	TEMPO	ROLL	ROLL
PFM	PERFORM	LVL	LEVEL	FLAM	FLAM
FEEL	FEEL	NO~9	Numerical Key 0-9	SHFT	SHIFT
				PD1~16	Key Pads 1 - 16

Step 6 Press **DEFINE** to return to the previous display.

### Clearing the Users function

To clear the Users function you have registered With the unit stopped, do as follows :

Step 1 Press **CANCEL** .



Step 2 Press **FUNCTION** .

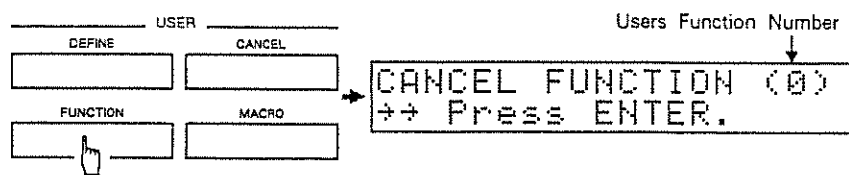

Step 3 Specify the number of the Users Function you wish to erase with **-1/OFF** and **+1/ON**, VALUE slider or the Numerical Keys.

Step 4 Press **ENTER** .  
The display responds with "Are you sure?".

Step 5 To continue, press **ENTER** .

\*To cancel this mode, press **EXIT** .

## 3 INITIALIZATION

The Initializing function of the R-8 can recall the factory preset data (data preprogrammed by the manufacturer) at any time even after it has been edited.

### Initializing Note Numbers

The setting of the note numbers can be returned to the factory presets.

Step 1 Press **MIDI** to turn to the MIDI Mode.

Step 2 Press Numerical Key 7 to select "NT # INIT".

```
NOTE# INITIALIZE  
↔ Press ENTER.
```

Step 3 Press **ENTER**.  
The display responds with "Are you sure?".

Step 4 To continue, press **ENTER** again.  
To stop, press **EXIT**.

### Initializing Instrument Assignment

The instrument assignments to the key pads and instrument under Multi Assign can be returned to the factory presets.

Step 1 Press **INST ASSIGN** to turn to the Instrument Assign Mode.

Step 2 Press Numerical Key 3 to select "INIT".

```
ASSIGN INIT <ALL>  
↔ Press ENTER.
```

To initialize the entire Instrument Assignment, skip the following step 3, then go to step 4.

Step 3 To initialize the instrument of a certain Pad Bank, select the Pad Bank with **PAD BANK**.

To initialize an instrument in the Multi Assign, press **MULTI**.

Step 4 Press **ENTER**.  
The display responds with "Are you sure?".

Step 5 To continue, press **ENTER** again.  
To stop, press **EXIT**.

## Initializing Sound Parameters

The Sound Parameters can be returned to the factory preset values.

Step 1 Press **SOUND** to turn to the Sound Edit Mode.

Step 2 Press Numerical Key 3 to select "INIT".

```
SOUND INIT
01 SOUND BALL
```

Step 3 Specify the instrument to be initialized with the Numerical Keys.  
To initialize a specific instrument, press Numerical Key 1.

```
SOUND INIT(01CRSH_G1)
→→ Press ENTER.
```

To initialize all the instruments, press Numerical Key 2.

```
SOUND INIT <ALL>
→→ Press ENTER.
```

\*If you have pressed Numerical Key 2 in the above step, skip step 4 and go to step 5.

Step 4 Tap the key pad that corresponds to the instrument to be initialized.  
If necessary, change Pad Banks with **PAD BANK**.

Step 5 Press **ENTER**.  
The display responds with "Are you sure?".

Step 6 To continue, press **ENTER** again.  
To stop, press **EXIT**.

### 3) INITIALIZATION

#### Clearing Performance Parameters

The performance parameters of all the key pads can be cleared (Pan = OFF, all the other parameters = 0).

- Step 1 Press **PERFORM** to turn to the Performance Edit Mode.
- Step 2 Press Numerical Key 3 to select "CLEAR".

```
PERFORM CLEAR <ALL>
→→ Press ENTER.
```

To initialize the Performance parameters of all the key pads, skip the following step 3, then go to step 4.

- Step 3 To initialize performance parameters of a certain Pad Bank, select the Pad Bank with **PAD BANK**.  
To initialize Performance parameters in the Multi Assign, press **MULTI**.

- Step 4 Press **ENTER**.  
The display responds with "Are you sure?".

- Step 5 To continue, press **ENTER** again.  
To stop, press **EXIT**.

#### Clearing Feel Patches

The settings of the Feel Patches can be cleared.

- Step 1 Press **FEEL** to turn to the Feel Edit Mode.
- Step 2 Press Numerical Key 1 to select "PATCH".
- Step 3 Specify the Feel Patch number to be cleared.
- Step 4 Press **EXIT** to return to the Menu Display, then select "CLEAR" by pressing Numerical Key 7.

Feel Patch Number  
↓

```
FEEL PATCH CLEAR <#0>
→→ Press ENTER.
```

- Step 5 Press **ENTER**.  
The display responds with "Are you sure?".

- Step 6 To continue, press **ENTER** again.  
To stop, press **EXIT**.

**Initializing the R-8**

The entire data of the R-8 can be initialized. Meanwhile the demonstration songs/User-patterns (Preset patterns are copied to pattern numbers 00 to 31) and Feel Patches are set.

- Step 1 Switch the R-8 off.

- Step 2 While holding **PAGE** and **SELECT** down, switch the unit on.

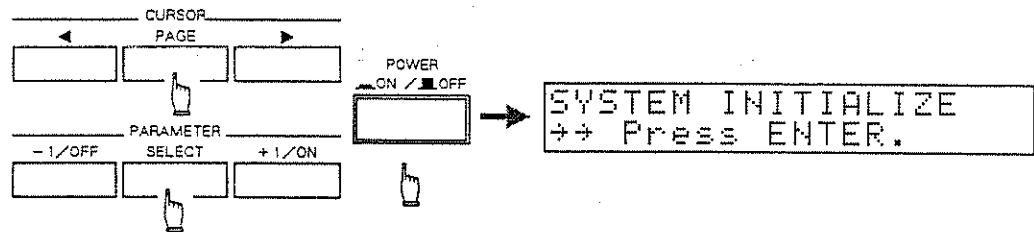

- Step 4 Press **ENTER**.  
The display responds with "Are you sure?".

- Step 5 To continue, press **ENTER** again.  
To stop, press **EXIT**.

## 4 MEMORY CARD (RAM)

All data programmed in the R-8, such as rhythm patterns, songs, sound parameters, performance parameters can be saved onto a RAM card (optional).

\*The Sound ROM card cannot hold the R-8's data.

### Notes on using a RAM card

- Use only the M-256E or M-256D RAM card.
- Read the instructions supplied with the card carefully.
- Normally set the protect switch on the RAM card to the ON position to protect data saved. Set it to OFF only when saving data onto the card.
- Inserting a RAM card with protect "OFF" into the ROM card slot will erase the data on the RAM card. When using it again later, format it.
- If you keep the RAM card connected to the R-8 with the R-8 switched off, the lithium battery in the card will be wasted. When you switch off the R-8, remove the card.
- If an error message is shown in the display, resolve it as explained in "Error Message Table" on page 189.
- Do not switch off the unit while loading or saving a RAM card. Data on the card or in the internal memory of the R-8 may be erased.

# 1. Formatting

To save data onto a brand new RAM card or one used for another unit, the following formatting procedure is required. Formatting saves the entire data in the R-8 onto the card.

\*Formatting will erase any previous data stored on the RAM card.

Step 1 Connect the RAM card to the RAM Card Slot securely (until it clicks).

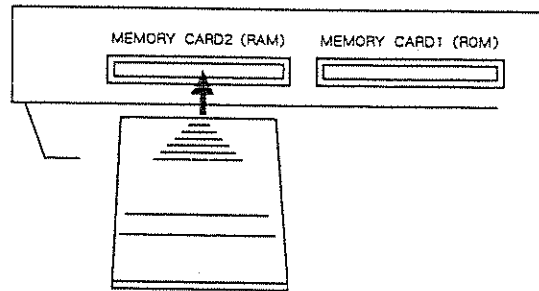

Card Number 2 is indicated

MODE	PATTERN		TEMPO
EDIT			
USER		CARD	2
PAD BANK	A	ASSIGN	120

Step 2 Set the protect switch on the RAM card to OFF.

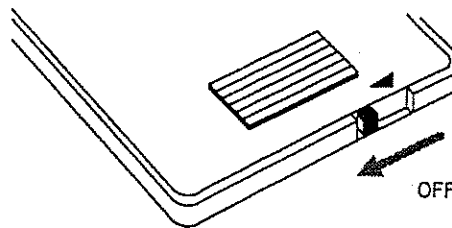

Step 3 Press **CARD** to turn to the Card Mode.

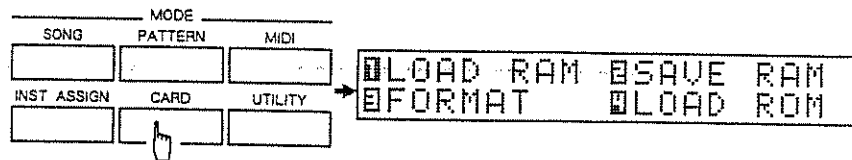

④ MEMORY CARD (RAM)

Step 4 Press Numerical Key 3 to select "FORMAT".

●If you are using a brand new card, the Card Name setting display appears :

```
RAM CARD FORMAT
CARD NAME: < _ >
```

●If any data is written on the card, the following display appears :

```
RAM CARD FORMAT
Data exist : FORMAT?
```

To continue, press **ENTER** , and to stop, press **EXIT** .

\*If the RAM card is not connected correctly, the "Card not ready" message appears.  
If this happens, remove the card, reinsert it properly, then repeat the procedure.

\*If the connected card cannot be used for the R-8, the "Illegal card" message appears.

Step 5 Move the cursor with **◀** and **▶** , then set a card name with **-1/OFF** **+1/ON** , VALUE slider, or Numerical Keys.

Pressing a Numerical Key also switches alternately between numbers and letters/symbols mode (marked at the upper right of the keys). If you wish to use small letters, press a Numerical Key while holding **SHIFT** down.

Step 6 Press **ENTER** .

```
RAM CARD FORMAT
++ Are you sure ?
```

\*To leave this mode, press **EXIT** .

Step 7 Press **ENTER** again.

"Completed" appears showing the card is now formatted.

Step 8 Set the protect switch on the card back to ON.



## 2. Save

The saving procedure saves the data on the R-8 onto a RAM card.

\*To save data onto a brand new RAM card or the one used for the other unit, the formatting procedure (see page 163) is required. Formatting saves the entire data in the R-8 onto the RAM card.

Step 1 Connect the RAM card to the RAM Card Slot securely (until it clicks).

Step 2 Set the protect switch on the RAM card to OFF.

Step 3 Press **CARD** to turn to the Card Mode.

Step 4 Press Numerical Key 2 to select "SAVE RAM".

```
SAVE TO RAM CARD
[ALL] [SEQ] [SETUP]
```

Step 5 Specify the data group to be saved using Numerical Keys 1 to 3.  
Normally, use the All mode.

- 1 : ALL ...Saving the entire data in the R-8 (SEQ and SETUP)
- 2 : SEQ ...Saving rhythm patterns and song data
- 3 : SETUP ...Saving Instrument Assign, Sound Parameters (Data of a ROM card), Performance Parameters, Macro Notes, Users Function, Metronome, Sync Mode, Feel Patches and setting of MIDI functions

The display responds with :

Selected data group	Card Name
↓	↓
<pre>SAVE &lt;ALL&gt; MUSIC 1 ↔↔ Are you sure ?</pre>	

\*Saving with ALL or SETUP will copy the Loading status of the ROM card at the same time.

\*To leave this mode, press **EXIT**.

Step 6 Press **ENTER**.  
"Completed" appears showing data is now saved onto the card.

Step 7 Set the protect switch on the card back to ON.

### 3. Load

The loading procedure copies data on a RAM card into the R-8.

**Step 1** Connect the RAM card to the RAM Card Slot securely (until it clicks).

**Step 2** Press **CARD** to turn to the Card Mode.

**Step 3** Press Numerical Key 1 to select "LOAD RAM".

```
LOAD FROM RAM CARD
[ALL] [SEQ] [SETUP]
```

**Step 4** Specify the data group to be loaded using Numerical Keys 1 to 3.  
Normally, use the All mode.

1: ALL ...Loading the entire data on a RAM card (SEQ and SETUP)

2: SEQ ...Loading rhythm patterns and song data

3: SETUP ...Loading Instrument Assign, Sound Parameters (Data of a ROM card),  
Performance Parameters, Macro Notes, Users Function, Metronome,  
Sync Mode, Feel Patches and setting of MIDI Functions

The display responds with:

```
Selected data group      Card Name
      ↓                  ↓
LOAD <SEQ>#MUSIC 1
→→ Are you sure ?
```

\*To leave this mode, press **EXIT**.

**Step 5** Press **ENTER**.

"Completed" appears showing data is now loaded into the R-8.

\*Once you have loaded parameter data of ROM card from RAM card, the Instruments on the Loaded ROM card are ready to be used just by connecting the card to the unit.

## 5 SYNC PLAY

The R-8 can sync to other MIDI equipment or MTR (multi track recorder).

### 1. Sync Mode Setting

The R-8 can select to what device it should sync to.

With the unit set to the Song or Pattern Mode and stopped, do as follows:

Step 1 Tap key pad 16 while holding **SHIFT** down.

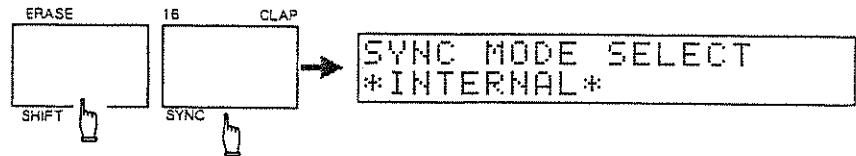

Step 2 Select one of the three Sync Modes using **-1/OFF**, **+1/ON**, or VALUE slider.

INTERNAL ...An external device syncs to the R-8

TAPE .....The R-8 syncs to the sync signal recorded on an MTR

MIDI .....The R-8 syncs to the MIDI clock signal of an external MIDI device

\*When the Sync mode is set to MIDI (TAPE) but clock signals (Sync signals) are not being received, the Roll or Macro Note effect cannot be obtained with the Key pads.

Step 3 Press **ENTER** to return to the previous display.

### Tempo Display

If the "MIDI" or "TAPE" Sync Mode is selected, the tempo display will be as shown below, and the tempo control cannot be done on the R-8.

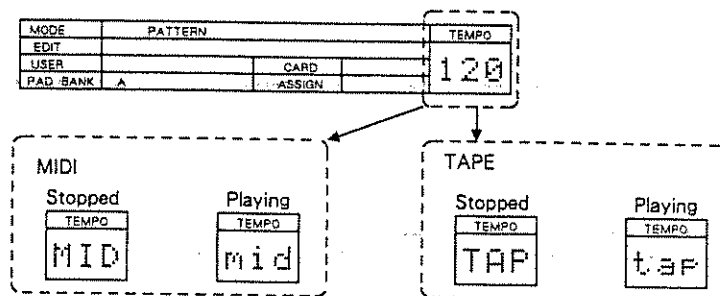

If **START/STOP** is pressed without any sync signal being fed into the R-8, the display shows the normal playing indication, but the R-8 does not start playing until the sync signal is sent from the external device.

## 2. MIDI Sync

In MIDI sync, the R-8 plays as a master or slave.

### When the R-8 is a master device

To control an external device with the R-8's Start/Stop or tempo, set up the R-8 with an external device as shown below.

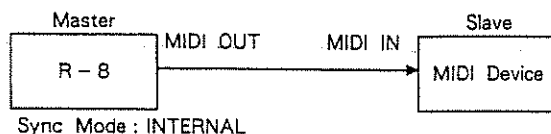

\*When the slave device (external device) can receive MIDI Song Select or Song Position Pointer messages, the song numbers/bar numbers set on the R-8 are also selected on the slave device.

### When the R-8 is a slave device

To control the R-8 with the Start/Stop or tempo of the external device, set up the R-8 and the external device as shown below.

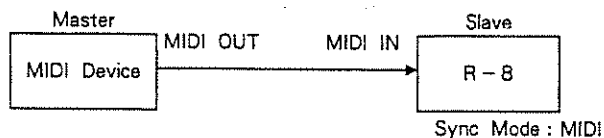

\*When the master device (external device) can transmit MIDI Song Select or Song Position Pointer messages, the song numbers/bar numbers set on the external device are also selected on the R-8.

### 3. Tape Sync

The R-8 syncs to the FSK signal recorded in an MTR. You may use the R-8 as a tape sync interface, to make another MIDI device which does not feature a tape sync function play to the MTR.

#### Recording Sync signals

To record tape sync signals from the R-8 to an MTR, do as follows.

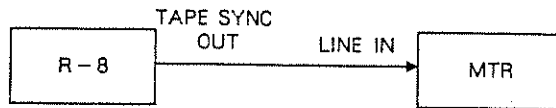

\*When recording tape sync signals, do not use noise reduction or an equalizer. It will cause malfunctions to the R-8. If you cannot avoid using them in recording because of the specifications of the MTR you use, you must use them in exactly the same settings during playback.

Step 1 Set the Sync Mode of the R-8 to "INTERNAL" (see page 167).

Step 2 Adjust the recording level (approx. -10 to -3VU) of the MTR.

\*When the R-8 is stopped, pilot signals are always output from the TAPE SYNC OUT jack.

Step 3 Set the tempo for the sync play.

Step 4 Start recording on the MTR first, then start the R-8 in a few seconds.

Step 5 When the R-8 stops playing, wait for a few seconds and stop the MTR.

## Sync Play

The R-8 syncs to the MTR's tape sync signals.

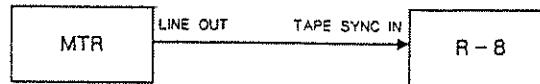

- Step 1 Rewind the tape until the pilot tone changes to a modulated tone.
- Step 2 Set the Sync mode of the R-8 to "TAPE" (see page 167).
- Step 3 Start the MTR (Set the track of the tape sync signals to Play mode, and the other tracks to Recording mode if necessary).
- Step 4 Press **START/STOP** on the R-8.

\*Be sure to press **START/STOP** before the pilot tone changes to a modulated tone.

\*When the tones change, the R-8 starts syncing to the tape sync signals.

\*It is not possible to start tape sync while the tape is playing.

\*When the tape sync does not perform well, adjust the output level of the tape sync signals then repeat the procedure. If you fail, record the tape sync signals again at a different level.

# 6 MIDI

The R-8 can be played using an external MIDI device, or can play an external rhythm machine or MIDI module. Also, using MIDI exclusive messages, the entire data in the internal memory of the R-8 can be transferred to an external device.

\*Read the separate booklet "Guide Book for MIDI".

## 1. MIDI Function Settings

The R-8 transmits and receives MIDI messages as shown below.

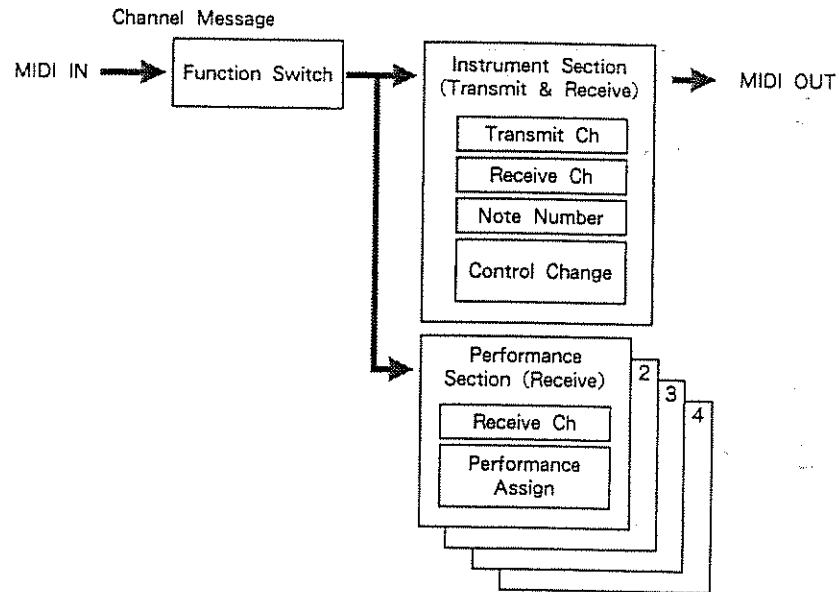

### Instrument Section

The Instrument section should be set when you play the R-8's rhythm voices with external MIDI equipment. In this section, a note number is assigned to each instrument.

It is possible to play the instruments according to the assigned note numbers with performance data sent from an external MIDI device, or to play more than one MIDI device with the performance data of the R-8.

### Performance Section 1 to 4

The Performance section should be set when you play the R-8 as a synthesizer sound module using an external MIDI keyboard.

In this section, one instrument is assigned to each four sections. The parameters (Pitch/Decay/Nuance/Pan) of the assigned instrument can be changed depending on the keys you play on the keyboard.



### a. Transmit Channel (Instrument Section)

When playing an external MIDI sound module with the performance data (note messages) sent from the R-8, the transmit channel of the R-8 can be set for each instrument.

When using only one MIDI sound module, set the transmit channels of all the instruments to the same number. When using more than one MIDI sound module, set different channels if necessary to differentiate instruments.

\*The Note number setting of each instrument preprogrammed from the manufacturer is shown on page 208.

Step 1 Press **MIDI** to turn to the MIDI mode.

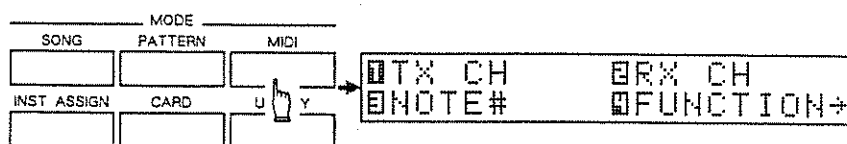

Step 2 Press Numerical Key 1 to select "TX CH".

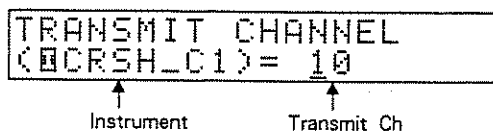

Step 3 Tap the key pad for the instrument whose transmit channel is to be set. Change Pad Banks with **PAD BANK**, if necessary.

Step 4 Set the transmit channel (1 to 16) with **-1/OFF** **+1/ON**, VALUE slider or Numerical Keys.

Step 5 To continue, and set the transmit channels of another instrument, repeat steps 3 and 4.

Step 6 Press **EXIT** to return to the Menu Display.

b. Receive Channel (Instrument Section/Performance Section)

This sets the R-8's receive channel where MIDI messages are received from an external MIDI device, for each section.

\*The receive channel of the Instrument Section is the Basic channel on which Exclusive messages are received.

\*Set the receive channels of the Performance section and Instrument section to different numbers. If they are set to the same number, the Instrument section will be given priority.

Step 1 With the Menu Display shown in the MIDI mode, press Numerical Key 2 to select "RX CH".

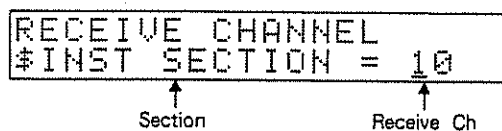

Step 2 Using **SELECT**, select the section whose receive channel is to be set.

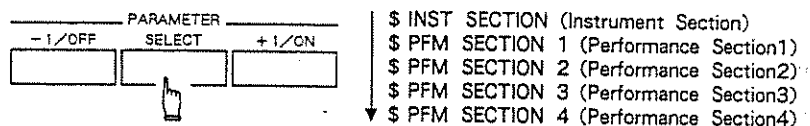

Step 3 Set the receive channel (1 to 16) with **-1/OFF** **+1/ON**, VALUE slider or Numerical Keys.

\*Set the unused Performance section to "OFF". (OFF cannot be set with the Numerical Keys.)

Step 4 Press **EXIT** to return to the Menu Display.

### c. Note Numbers (Instrument Section)

When Note messages are received on the receive channel set in the instrument section, Note numbers decide what instruments should be played. When the R-8 transmits Note messages, the note numbers set here will be used (see page 173).

~~\* Preset settings for Note numbers are shown on page 208.~~

- Step 1 With the Menu Display shown in the MIDI mode, press Numerical Key 3 to select "NOTE #".

```

NOTE NUMBER ASSIGN
(C@POWER_T4)= 035(B 1)
  
```

↑ instrument     
↑ Note number     
↑ Note Name

- Step 2 Tap the key pad for the instrument whose note number is to be set. Change Pad Banks with **PAD BANK**, if necessary.
- Step 3 Set the note number (0 to 127) with **-1/OFF** **+1/ON**, VALUE slider or Numerical Keys.
- \*Set Instruments that do not receive or transmit Note messages to "OFF". (This cannot be set with Numerical Keys.)
- Step 4 To continue, and set the note numbers of another instrument, repeat steps 2 and 3.
- Step 5 Press **EXIT** to return to the Menu Display.

d. Function Switch (Instrument Section/Performance Section)

A function switch selects whether or not to receive the MIDI channel messages. There are other switches for selecting respectively whether to transmit or receive. They are Note Off, Pan, Program Change and Exclusive switches.

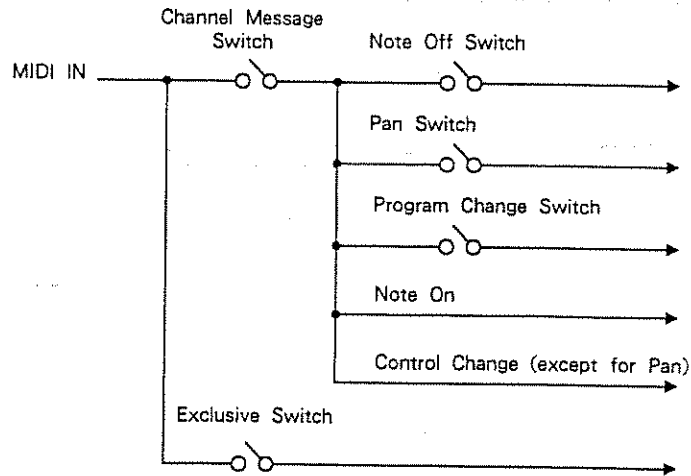

\*The setting of the Function Switch is relevant to all the sections.

Description of  
Function Switches

●Channel Message Switch

This selects whether or not to transmit and receive the Channel messages (Note/Program Change/Control Change).

\*If the Channel Message Switch is set "OFF", no Channel message is transmitted or received regardless of the settings of the Note Off, Pan or Program Change switches.

●Note Off Switch

This selects whether or not to receive the Note Off (or Note On with Velocity zero) messages sent by releasing Keys on a keyboard. Normally it should be set to "OFF", and set to "ON" to mute a long decay sound.

ON..... The instrument of the note number is muted upon receiving Note Off.

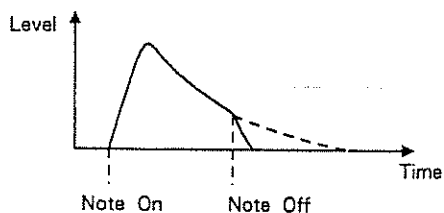

OFF..... The instrument of the note number is not muted even when Note Off is received.

●Pan Switch

This selects whether or not to control the pan (Control Change number 10) from an external MIDI device.

ON..... The pan of the instrument in the section which receives the Pan message (if it is in the Instrument section, all the instruments) is changed and remains intact until another Pan message is received.

OFF..... Pan messages are not received.

\*The Pan messages can control only the sound played by the MIDI messages received at MIDI IN, but cannot control the sound (Song Play or Pattern Play) played by the R-8 itself.

\*When the Pan Switch is set to "ON", the Pan assigned to the other Control Change numbers will be invalid.

● **Program Change Switch**

This selects whether or not to receive the Program Change messages.

ON.....Pattern Numbers/Feel Patch Numbers are changed according to the Program Change Numbers received on the Basic Channel (receive channel of the instrument section).

Mode	Receivable Range	Operation
Song Play Mode	1 - 8/128	Changes to the Feel Patch that is one number smaller than the receiving number. The selected Feel Patch is retained until it is changed to another Feel Patch or cancelled.  * "128" will cancel the assignment of the Feel Patches.
Pattern Play Mode	1 - 100	Changes to the Rhythm Pattern that is one number smaller than the receiving number.

OFF.....Program Changes are not received.

\*Even if the Program Change Switch is set to "ON", no Program Change is received if the unit is set to modes other than Song Play or Pattern Play mode.

\*If the Program Change Switch is set to "ON" in the Song Playing mode, the Feel Patch assigned to each rhythm pattern will be ignored.

● **Exclusive Switch**

This selects whether or not to receive MIDI exclusive messages.

ON.....Exclusive messages are received when the the R-8 is stopped.

OFF.....Exclusive messages are not received.

Now, let's set the Function Switches.

- Step 1 With the Menu Display shown in the MIDI mode, press Numerical Key 4 to select "FUNCTION".

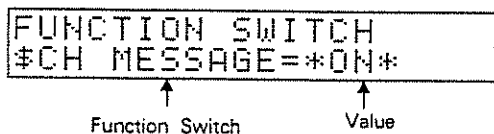

- Step 2 Using **SELECT**, specify the Function Switch to be used.

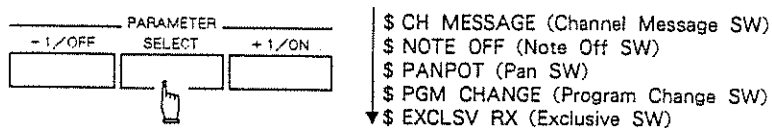

- Step 3 Select ON or OFF with **-1/OFF** **+1/ON**, or VALUE slider.
- Step 4 To continue, and set the other switches, repeat steps 2 and 3.
- Step 5 Press **EXIT** to return to the Menu Display.

### e. Control Change (Instrument Section)

Control Change messages (Modulation and General purpose controls 1 to 8) sent from an external MIDI device can control a parameter (Pitch, Decay, Nuance or Pan) of the specified instrument.

Once the Control Change is set, the corresponding control change (the value of the specified parameter) is transmitted when the specified instrument is played.

If you record these performance messages into a MIDI sequencer from the R-8, the instruments will be faithfully played back on the R-8 with the recorded performance data.

- Step 1 With the Menu Display shown in the MIDI mode, press Numerical Key 5 to select "CTRL CHG".

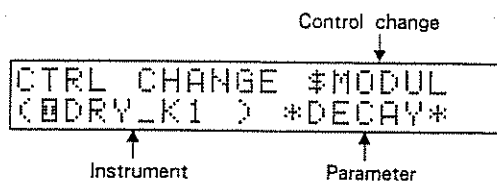

- Step 2 Using **SELECT**, select one of the Control Changes.

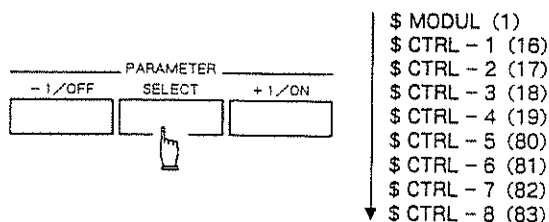

\*The numbers shown in ( ) represent Control Change numbers.

- Step 3 Press the key pad that corresponds to the instrument that transmits or receives the Control Change.

- Step 4 Using **-1/OFF** **+1/ON** or VALUE slider, specify parameter (Parameters: Pitch, Decay, Nuance or Pan).

\*"Pitch" cannot be selected with CTRL - 5 to 8.

\*Set the parameter of the unused Control Change to "OFF".

- Step 5 To continue, and set the other Control Changes, repeat steps 2 to 4.

- Step 6 Press **EXIT** to return to the Menu Display.



## f. Performance Section

The Performance section is used for changing parameter values (Pitch, Decay, Nuance or Pan) of a certain instrument depending on the playing key on the keyboard.

### Function of the Performance Section

Assign an instrument and a parameter to be changed to each Performance section. Then set how it should be changed using the following parameters.

#### ●Center Note Number

This sets the base (0) note number (0 to 127) for changing the parameter values.

\*The base value of the pan is the center.

#### ●Keyboard Follower

This sets the amount of changes from the center note number between two note numbers.

The parameter value of the center note number is zero, and increases as a note number advances, and decreases as note number goes backward.

Parameter	Variable range
Pitch	0~990
Decay	0~9
Nuance	0~3
Pan	0~1

< Ex. > Playing the R - 8      Center Note : C4 (60)  
 Keyboard Follower : 100

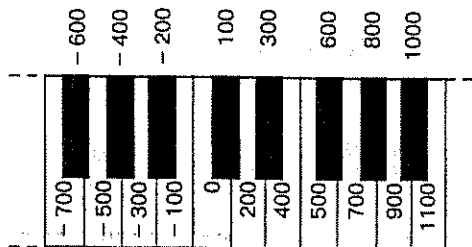

#### ●Control Change

Independently of the parameters set in each Performance section, another one control change (MODUL/CTRL - 1 to 8) can control the parameters (Decay/Nuance/Pan). Using the control Changes, it is possible to control a different parameter with the modulation lever, etc. while changing the parameter specified here from the Keyboard.



## 2. Example Setups

### a. Using the R-8 as a MIDI Sound Module

The R-8 can be played by a sequencer, rhythm machine, MIDI keyboard or MIDI drum pads.

When the R-8 is played by an external MIDI device, the sound of each instrument can be edited using Sound parameters (see page 47). Performance parameters have no effect.

#### Using the R-8 as a rhythm sound module

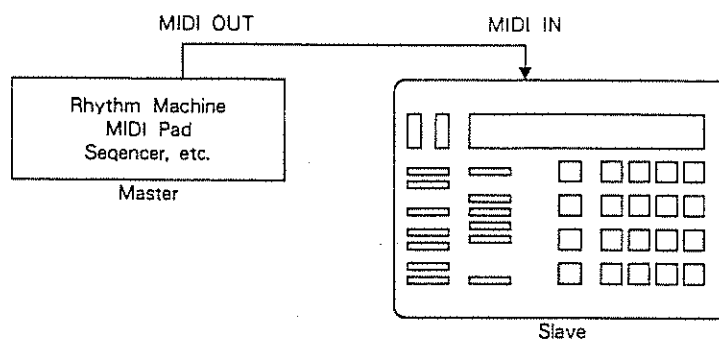

Set the MIDI parameters as follows.

- Set the Channel Message Switch (Function Switch) to "ON" (see page 177).
- Set the receive channel of the Instrument section to the same number as the transmit channel of the MIDI device (see page 174).
- Change the note number assignment to instruments if necessary (see page 175).

\*When the PAD-80 is used as a master and the Pan Switch (one of the Function Switches) is set to "ON", the pan for each pad can be received (see page 177).

Performance data from an external device can be written into rhythm patterns with the R-8 in the Real-time Write mode. However, Note Off cannot be entered to a rhythm pattern, therefore mute effect cannot be created.

**Using the R-8 as a sound source for a MIDI keyboard**

Depending on the key played on the keyboard, the pitch, pan, decay or nuance of specified instruments will be changed accordingly.

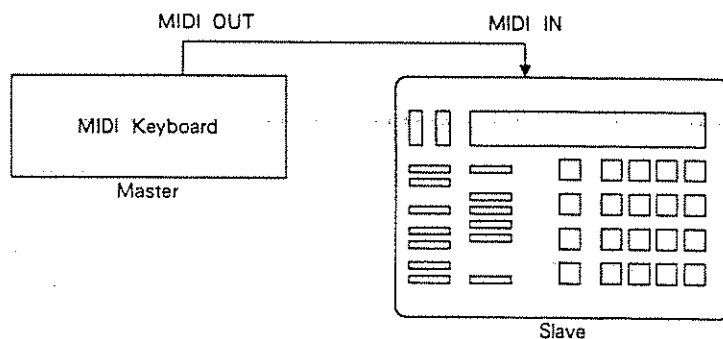

Set the MIDI parameters as follows.

- Set the Channel Message Switch (Function Switch) to "ON" (see page 177).
- Set the receive channel of any Performance section, 1 to 4, to the same number as the transmit channel of the MIDI keyboard (see page 174).
- Set the Instrument, Parameter, Center Note Number and Keyboard Follower of the selected Performance section to appropriate values (see page 181).

Performance data from an external device can be written into rhythm patterns with the R-8 set to the Real-time Write mode. However, Note Off cannot be entered to a rhythm pattern, therefore mute effect cannot be created.

## b. Playing an external MIDI sound module with the R-8

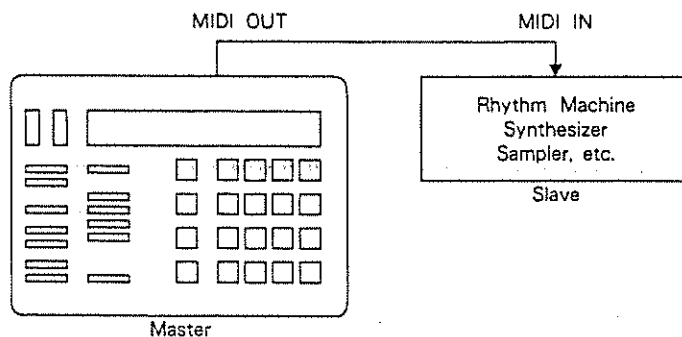

\*When using a sampler unit or synthesizer, select a sound with a quick attack and long release time (the time needed from Note Off to zero) to prevent the created sound from muting or cutting.

Set the MIDI parameters as follows.

- Set the Channel Message Switch (Function Switch) to "ON" (see page 177).
- Set the transmit channel of each instrument to the same number as the receive channel of the slave device (see page 173).
- Change the note number assignment to instruments if necessary (see page 175).

### 3. Data Transfer via Exclusive

Using MIDI Exclusive messages, the entire data written in the R-8 can be transferred to another R-8 or any MIDI device which can receive Exclusive messages. Also, the Sound parameters of any instrument can be transferred using the Exclusive messages.

#### a. Transmit (Bulk Dump)

Data stored in the R-8 is transferred.

##### Connections

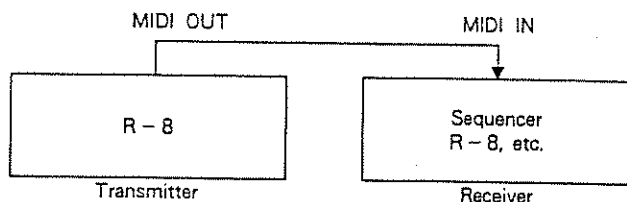

- Step 1 Set the basic channel (receive channel of the instrument section) to the basic channel of the receive unit (see page 174).
- Step 2 With the Menu Display shown in the MIDI mode, press Numerical Key 8 to select "BLK DUMP".

```
BULK DUMP
[ ] ALL [ ] SEQ [ ] SETUP →
```

Next Display

```
BULK DUMP
[ ] 1 PTN ←
```

- Step 3 Using Numerical Keys 1 to 4, specify the data group to be transferred.

- 1: ALL .....The entire data is transferred. (SEQ and SETUP)
- 2: SEQ .....Rhythm Patterns and Song data are transferred.
- 3: SETUP.....Instrument Assign, Sound Parameters (Data of ROM card), Performance Parameters, Macro Notes, Users Function, Metronome, Sync Mode, Feel Patches and setting of MIDI functions data are transferred.
- 4: 1-PTN ....One Rhythm Pattern is transferred.

The display responds with :

Select Data Group  
↓  
BULK DUMP <ALL>  
↔↔ Press ENTER.

When you have pressed Numerical Key 4, specify the Pattern number to be transferred with -1/OFF +1/ON, VALUE slider or Numerical Keys.

BULK DUMP <PTN 30>  
↔↔ Press ENTER.

Step 4 Press ENTER.

The display responds with "Are you sure?".

Step 5 Press ENTER to transfer the data.

When the data transfer is finished, "Completed" appears in the display.

\*To leave this mode, press EXIT.

## 6 MIDI

### b. Receive

The R-8 receives exclusive messages from another R-8 or MIDI device.

#### Connections

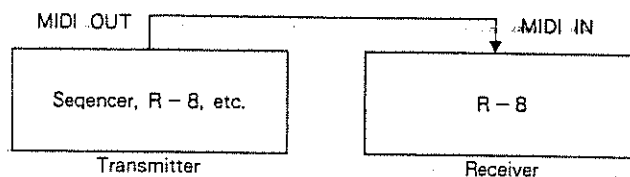

**Step 1** Set the basic channel (receive channel of the instrument section) to the basic channel of the Transmitter (see page 174).

**Step 2** Set the Exclusive Switch (Function Switch) to "ON" (see page 178).

If the R-8 is stopped, it receives Exclusive messages.

### c. Transmitting Sound Parameters

Sound parameters of an instrument can be transferred via the Exclusive messages.

#### Connections

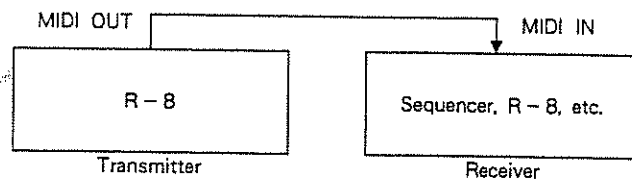

**Step 1** With the unit set to the Edit Mode of Sound parameters, specify the instrument whose Sound parameters should be transferred.

**Step 2** Press **ENTER** to transfer the data.



# ■ REFERENCE

## 1. Error Messages Table

If an error message is shown in the display, resolve it as follows.

```
→→ Card not ready.
```

- A RAM Card is not correctly connected to the RAM Card Slot.

- ☐ Insert a RAM Card properly.

Name of previously loaded ROM card

```
LOADED=<          >
→→ Card not ready.
```

- A Sound ROM Card is not correctly connected to the ROM Card Slot.

- ☐ Insert a Sound ROM Card properly.

```
→→ Card protected.
```

- The protect switch on the RAM card is set to "ON".

- ☐ Set the switch to "OFF".

```
→→ Illegal card !
```

- The card connected to the RAM Card Slot cannot be used with the R-8.

- ☐ Replace the card with the specified RAM card (M-256E or M-256D).

```
Pull out this CARD.
```

- The card connected to the ROM Card Slot is not the R-8's Sound ROM card.

- ☐ Remove the card from the ROM Card Slot.

```
→→ Ptn memory full !!
```

- There is no memory left for rhythm patterns. Press **EXIT**, return to the previous mode.

- ☐ To continue to write rhythm patterns, clear unneeded existing patterns.

→→ Song memory full.

● There is no memory left for songs.

☐ To continue to write or edit song data, clear unneeded existing songs.

→→ Bar # overflow.

● As a result of Pattern Append the number of bars in the pattern exceeds 99.

☐ Change the settings so that the total number will not exceed 99.

→→ Empty pattern.

● There is no data in the source rhythm pattern for Pattern Copy, Pattern Merge, Pattern Append, etc.

☐ Select another rhythm pattern.

→→ Event unpointed.

● In Micro Timing Shift or Macro Timing Shift, the sound to be timing-shifted is not yet selected.

☐ Check the procedure for the Micro Timing (Macro Timing) Shift.

→→ Inst not found.

● In Pattern Extract or Instrument Change, the instrument you specified does not exist in the pattern.

☐ Select a different source pattern or instrument.

→→ Checksum Error !!

● Exclusive messages are not received correctly.

Press **EXIT**, return to the previous mode.

☐ Repeat the procedure carefully.

⇒⇒ MIDI buffer full!!

- Too many MIDI messages are received at the same time, making it impossible to deal with them. Press **[EXIT]**, and return to the previous mode.
  - ☐ When it is shown during data receiving, decrease the amount of MIDI messages on the transmitter.
  - ☐ Set the Function Switches so that unneeded data will not be transmitted or received.

⇒⇒ Part overlap.

- You have selected a Destination Part within the specified source Part with Part Copy.
  - ☐ Set an appropriate Part number.

⇒⇒ No part exists.

- There is no data in the specified Part in the Part Copy or Part Delete procedure.
  - ☐ Set the specified Part properly.
  - ☐ Check if there is performance data in the specified Part.

⇒⇒ Part# overflow.

- Part Insert or Part Copy will result in more than 999 Parts in a song.
  - ☐ Set so that the total number of Parts does not exceed 999.

⇒⇒ No area.

- There is not enough memory left for executing copy function.
  - ☐ Delete unneeded rhythm patterns, then repeat the procedure.

⇒⇒ Aborted.

- This is shown when a procedure is stopped in the middle, or when a procedure cannot be executed.

## 2. Troubleshooting

### Instrument

● No sound is heard

The level is set to zero.

- ☐ Raise the level.

A REST is assigned to the key pad.

- ☐ Instrument number 68 is a REST, and therefore has no sound data (see page 42)

With the Macro Mode set to "ON", unspecified Macro note is selected.

- ☐ Set the Macro Mode to "OFF".

You have not loaded the Sound ROM card yet.

- ☐ Load the Sound ROM card.

More than 13 notes are simultaneously played.

- ☐ The R-8's maximum number of voices is 12 and therefore cannot play more than 13 notes at the same time.

● The volume of sound does not change by changing the strength of Key pad hitting.

The Sense Curve (Sound Parameter) is set to 7 or 8.

- ☐ Change the value of the Sense Curve.

● The volume is too low

The level is set too low.

- ☐ Raise the level.

You are tapping the upper part of the key pad.

- ☐ Tap the lower part of the key pad.

The Sense Curves are not set correctly.

- ☐ Change the Sense Curves.

● The sound is strange

Sound Parameters are not set properly.

- ☐ Change the values of Sound parameters or initialize them.

Performance Parameters are not set properly.

- ☐ Change the values of Performance parameters or clear them.

●The sound does not change after editing Sound parameters or Performance parameters.

☐The total value of the Sound parameter and Performance parameters exceeds the maximum range of the Sound parameter.

Even if it is within the range, this could happen when using certain instruments or parameters.

●Tapping a key pad produces continual sound.

The Macro Mode is set to "ON".

☐Set the Macro Mode to "OFF".

●The same instrument is played by all the key pads.

The unit is set to the Multi Assign mode.

☐Press **MULTI** to cancel the Multi Assign mode.

●Pad Banks cannot be changed.

The unit is set to the Multi Assign mode.

☐Press **MULTI** to cancel the Multi Assign mode.

## Rhythm Patterns

●Pressing **START/STOP** does not cause the unit to play.

The Sync mode is set to "TAPE" or "MIDI".

☐Set the Sync mode to "INTERNAL".

●The instrument written in a rhythm pattern sounds different.

You have edited Sound parameters.

☐Editing a Sound parameter affects instruments existing in any rhythm pattern as well.

●The Swing effect is not obtained.

The Swing Delay parameter is set to zero.

☐Set the Swing Delay to an appropriate value.

The Swing point is not set properly.

☐Set the Swing point properly.

The unit is set to the Real-time Write or Step Write mode.

☐The Swing effect is not obtained during pattern writing.

- Real-time writing cannot be done.

The unit is set to the Real-time Edit mode.

- ☞ Press **PAGE** to turn to the Real-time Write mode.

## Feel Patch

- Feel Patch data has no effect.

The Groove Switch or Random Factor Switch is set to "OFF".

- ☞ Set the Groove Switch or Random Factor Switch to "ON".

The instrument selected with Instrument Select is not used in the rhythm pattern.

- ☞ Change the Instrument Select.

The Instrument Switch is set to "OFF".

- ☞ Set the Instrument Switch to "ON".

The unit is set to the Real-time Write mode or Step Write mode.

- ☞ The Feel Patch has no effect during pattern writing.

- Even when the Instrument Switch is set to "OFF", the sound of such instrument changes.

- ☞ Check if the same instrument is assigned more than once with the Instrument Select.

## Song

- Pressing **START/STOP** does not cause the unit to play.

There is no data written in the selected song.

- ☞ Reselect a song or write data with Song Write.

The Sync mode is set to "TAPE" or "MIDI".

- ☞ Set the Sync mode to "INTERNAL".

- When a song is played, another song starts afterwards.

Song Chain is set.

- ☞ Cancel the Song Chain.

- The tempo of the song changes when it starts playing.

Initial Tempo is set in the song.

- ☞ Set the Initial Tempo to "OFF".

- The level of the song changes when it starts playing.

Initial Level is set in the song.

- ☐Change the Initial Level.

## RAM Card

- Data cannot be saved.

The protect switch on the RAM card is set to "ON".

- ☐Set it to "OFF".

The RAM card is not formatted.

- ☐Format the RAM card.

- Data on a RAM card is erased.

If you connect a RAM card to the ROM card slot with the protect switch set to OFF, the data on the RAM card is erased.

- ☐Format the RAM card.

## Sound ROM Card

- The instruments on the card do not sound.

The Sound ROM card is not loaded yet.

- ☐Load the Sound ROM card.

## MIDI

(When the R-8 is a slave)

- No sound is heard.

The MIDI channels of the two units are not set to the same number.

- ☐Set the MIDI channels of the two units to the same number.

Instruments are not correctly assigned to note numbers.

- ☐Change the note numbers.

The Channel Message Switch is set to "OFF".

- ☐Set the Channel Message Switch to "ON".

- No sound is created in the Performance section.

The receive channels of the Performance section and Instrument section are set to the same number.

- ☐Set the receive channels of the Performance section and Instrument section to different numbers.

● Only one instrument can be played.

MIDI messages are received on the receive channel of the Performance section.

☞ Set the receive channel of the Instrument section correctly.

● Sound is muted partway through.

The Note Off Switch is set to "ON".

☞ Set the Note Off Switch to "OFF".

● The Pan does not change.

The Pan Switch is set to "OFF".

☞ Set the Pan Switch to "ON".

● Exclusive messages are not received.

The basic channels of the receiver and the transmitter are not set to the same number.

☞ Set the basic channels to the same numbers. The basic channel of the R-8 is the receive channel of the Instrument section.

The Exclusive Switch is set to "OFF".

☞ Set the Exclusive Switch to "ON".

(When the R-8 is a master device)

● No sound is heard.

The MIDI channels of the two units are not set to the same number.

☞ Set the MIDI channels of the two units to the same number.

Instruments are not correctly assigned to the note numbers.

☞ Change the note numbers.

The Note Number of the Instrument is set to "OFF".

☞ Set the Note Number of the Instrument.

The Channel Message Switch is set to "OFF".

☞ Set the Channel Message Switch to "ON".



Others

●The metronome stops in the middle.

The Metronome mode is set to "EMPTY REC".

- ☐Change the Metronome mode.

●Metronome is not heard.

The metronome level is set to zero.

- ☐Increase the level of the metronome.

The Metronome mode is set to "EVER OFF".

- ☐Change the Metronome mode.

●The Flam effect is not obtained.

The Flam interval is set to zero.

- ☐Set the Flam interval to an appropriate value.

The Flam ratio is not set correctly.

- ☐Change the Flam ratio.

The Macro mode is set to "ON".

- ☐Set the Macro mode to "OFF".

●The Roll effect is not obtained.

The Macro mode is set to "ON".

- ☐Set the Macro mode to "OFF".

●The Modes are not changed by pressing buttons.

The unit is set to the Users Function mode.

- ☐Press **DEFINE** to cancel the Users Function.

### 3. Blank Chart

【Sound Parameters and Note Numbers】

INST #	INST NAME	PITCH	DECAY	NUANCE	OUTPUT ASSIGN	ASSIGN TYPE	SENSE CURVE	NOTE #
1			:					
2			:					
3			:					
4			:					
5			:					
6			:					
7			:					
8			:					
9			:					
10			:					
11			:					
12			:					
13			:					
14			:					
15			:					
16			:					
17			:					
18			:					
19			:					
20			:					
21			:					
22			:					
23			:					
24			:					
25			:					
26			:					
27			:					

INST #	INST NAME	PITCH	DECAY	NUANCE	OUTPUT ASSIGN	ASSIGN TYPE	SENSE CURVE	NOTE #
28			:					
29			:					
30			:					
31			:					
32			:					
33			:					
34			:					
35			:					
36			:					
37			:					
38			:					
39			:					
40			:					
41			:					
42			:					
43			:					
44			:					
45			:					
46			:					
47			:					
48			:					
49			:					
50			:					
51			:					
52			:					
53			:					
54			:					

■ REFERENCE

INST #	INST NAME	PITCH	DECAY	NUANCE	OUTPUT ASSIGN	ASSIGN TYPE	SENSE CURVE	NOTE #
55			:					
56			:					
57			:					
58			:					
59			:					
60			:					
61			:					
62			:					
63			:					
64			:					
65			:					
66			:					
67			:					
68			:					

COPY INST #	SOURCE INST #	INST NAME	PITCH	DECAY	NUANCE	OUTPUT ASSIGN	ASSIGN TYPE	SENSE CURVE	NOTE #
1				:					
2				:					
3				:					
4				:					
5				:					
6				:					
7				:					
8				:					
9				:					
10				:					
11				:					
12				:					
13				:					
14				:					
15				:					
16				:					
17				:					
18				:					
19				:					
20				:					
21				:					
22				:					
23				:					
24				:					
25				:					
26				:					

**【Instrument Assigns and Performance Parameters】**

Instrument Assign

1	2	3	4
5	6	7	8
9	10	11	12
13	14	15	16

Performance Parameter

Key Pad #	Pitch	Decay	Nuance	Pan
1				
2				
3				
4				
5				
6				
7				
8				
9				
10				
11				
12				
13				
14				
15				
16				



## 4. Preset Pattern Table

Pattern #	Pattern Name Display	Description
00	8BEAT1	* Rhythm Pattern with no accent
01	8BEAT2	* Rhythm Pattern with no accent
02	8BEAT3	
03	8BEAT4	
04	16BEAT1	* Rhythm Pattern with no accent
05	16BEAT2	* Rhythm Pattern with no accent
06	16BEAT3	
07	DISCO1	
08	DISCO2	
09	SLOWROCK	Appropriate tempo is about J = 85
10	SHUFFLE1	* Rhythm Pattern with no accent
11	SHUFFLE2	* Rhythm Pattern with no accent
12	FUNKY1	
13	FUNKY2	
14	FUNKY3	
15	OLDIES1	Appropriate tempo is about J = 90
16	OLDIES2	Appropriate tempo is about J = 180
17	OLDIES3	
18	METAL1	
19	METAL2	
20	SWING1	* Rhythm Pattern with no accent
21	SWING2	
22	BOSANOVA	
23	MAMBO	
24	MERENGUE	
25	RHUMBA	
26	BEGUINE	
27	SAMBA	
28	SALSA	
29	TANGO	
30	REGGAE	
31	COUNT	



## 5. Preprogrammed Sound Parameters and Note Numbers

INST #	INSTRUMENT NAME	PITCH	DECAY	NUANCE	OUTPUT ASSIGN	ASSIGN TYPE	SENSE CURVE	NOTE #
1	DRY_K1	0	4:19	8	CENTER	POLY	2	35
2	DRY_K2	0	20:12	8	CENTER	POLY	2	OFF
3	WOOD_K1	0	16:14	8	CENTER	POLY	2	85
4	DBLH_K1	0	19:13	8	CENTER	POLY	2	OFF
5	DBLH_K2	0	25:12	8	CENTER	POLY	2	84
6	SOLID_K	0	7:7	8	CENTER	POLY	2	OFF
7	ROOM_K1	0	24:20	8	CENTER	POLY	2	36
8	ROOM_K2	0	24:24	8	CENTER	POLY	2	OFF
9	MONDO_K	0	20:23	8	CENTER	POLY	2	OFF
10	WOOD_S1	0	19:14	8	CENTER	POLY	2	88
11	OPEN_S1	0	27:14	8	CENTER	POLY	2	86
12	TIGHT_S	0	19:14	8	CENTER	POLY	2	OFF
13	NICE_S1	0	23:17	8	CENTER	POLY	2	87
14	FAT_S1	0	22:15	8	CENTER	POLY	2	38
15	IMPCT_S	0	23:16	8	CENTER	POLY	2	58
16	SNAP_S1	0	16:13	8	CENTER	POLY	2	OFF
17	OUCH_S	0	20:16	8	CENTER	POLY	2	OFF
18	RVB_S1	0	35:33	8	CENTER	POLY	2	40
19	PICL_S1	0	19:16	8	CENTER	POLY	2	OFF
20	RIMSHT1	0	16:13	8	CENTER	POLY	2	OFF
21	RIMSHT2	0	21:17	8	CENTER	POLY	2	OFF
22	SIDSTK1	0	10:--	--	CENTER	POLY	2	37
23	SIDSTK2	0	5:--	--	CENTER	POLY	2	OFF
24	DRY_T1	0	30:35	8	RIGHT3	POLY	2	OFF
25	DRY_T2	0	29:33	8	RIGHT1	POLY	2	41
26	DRY_T3	0	28:30	8	LEFT 1	POLY	2	45
27	DRY_T4	0	27:24	8	LEFT 3	POLY	2	48
28	ROOM_T1	0	34:33	8	RIGHT3	POLY	2	OFF
29	ROOM_T2	0	33:31	8	RIGHT1	POLY	2	43
30	ROOM_T3	0	32:29	8	LEFT 1	POLY	2	47
31	ROOM_T4	0	31:27	8	LEFT 3	POLY	2	50
32	POWR_T1	0	34:27	8	RIGHT3	POLY	2	OFF
33	POWR_T2	0	33:25	8	RIGHT1	POLY	2	89
34	POWR_T3	0	32:23	8	LEFT 1	POLY	2	91

■ REFERENCE

INST #	INSTRUMENT NAME	PITCH	DECAY	NUANCE	OUTPUT ASSIGN	ASSIGN TYPE	SENSE CURVE	NOTE #
35	POWR_T4	0	31:20	8	LEFT 3	POLY	2	93
36	DOOM_T1	0	50:--	--	RIGHT3	POLY	2	OFF
37	CLSD_H1	0	12:12	8	LEFT 1	EXC1	2	42
38	OPEN_H1	0	35:40	8	LEFT 1	EXC1	2	46
39	PDAL_H1	0	15:--	--	LEFT 1	EXC1	2	44
40	CRSH_C1	0	55:--	--	LEFT 2	POLY	2	49
41	MLLT_C1	0	60:60	5	LEFT 1	POLY	2	OFF
42	RIDE_C1	0	50:50	8	RIGHT2	POLY	2	51
43	RDBL_C1	0	50:50	8	RIGHT2	POLY	2	OFF
44	BELL_C1	0	50:--	--	RIGHT2	POLY	2	53
45	808CLAP	0	23:--	--	RIGHT1	POLY	2	39
46	OPEN_D1	0	28:30	8	RIGHT1	POLY	2	OFF
47	TAIKO1	0	8:30	8	CENTER	POLY	2	OFF
48	CLAVE1	0	9:--	--	CENTER	POLY	2	75
49	CABASA1	0	8:--	--	RIGHT2	POLY	2	69
50	COWBEL1	0	16:--	--	LEFT 2	POLY	2	56
51	TAMBRN1	0	21:--	--	LEFT 1	POLY	2	54
52	SHAKER1	0	12:--	--	LEFT 2	POLY	2	OFF
53	MUTE_CG	0	10:--	--	RIGHT1	POLY	2	62
54	SLAP_CG	0	20:--	--	RIGHT1	POLY	2	OFF
55	LOW_CG	0	29:--	--	CENTER	POLY	2	64
56	SLID_CG	0	18:50	8	CENTER	POLY	2	OFF
57	AGOGO1	0	20:--	--	RIGHT2	POLY	2	68
58	OCT_AGG	0	20:20	8	LEFT 2	POLY	2	OFF
59	WHISTL1	0	7:--	--	LEFT 2	EXC2	2	71
60	WHISTL2	0	3:--	--	LEFT 2	EXC2	2	72
61	CAN1	0	20:30	8	RIGHT3	POLY	2	OFF
62	BACK_S1	0	0:0	8	LEFT 1	POLY	2	OFF
63	BACK_T1	0	0:--	--	RIGHT1	POLY	2	OFF
64	BACK_C1	0	0:--	--	CENTER	POLY	2	OFF
65	SPARK1	0	70:70	8	LEFT 2	POLY	2	OFF
66	SURF	0	127:127	8	CENTER	POLY	2	OFF
67	WHEEL1	0	60:60	8	RIGHT2	POLY	2	OFF
68	REST	0	0:--	--	CENTER	EXC8	2	OFF

COPY INST #	SOURCE INST #	INSTRUMENT NAME	PITCH	DECAY	NUANCE	OUTPUT ASSIGN	ASSIGN TYPE	SENSE CURVE	NOTE #
1	4	DBLH_K3	+ 500	12:10	8	CENTER	POLY	2	OFF
2	20	RIMSHT3	+ 500	21:14	8	CENTER	POLY	2	OFF
3	36	DOOM_T2	+ 500	50:--	--	RIGHT1	POLY	2	OFF
4	36	DOOM_T3	+ 1100	50:--	--	LEFT 1	POLY	2	OFF
5	37	CLSD_H2	0	10:12	15	LEFT 1	EXC1	2	90
6	37	CLSD_H3	0	20:20	0	LEFT 1	EXC1	2	OFF
7	38	OPEN_H2	0	20:20	0	LEFT 1	EXC1	2	OFF
8	38	OPEN_H3	0	45:40	15	LEFT 1	EXC1	2	OFF
9	40	CRSH_C2	+ 110	55:--	--	RIGHT2	POLY	2	OFF
10	40	CHOK_C1	0	14:--	--	LEFT 2	POLY	2	57
11	40	SPLA_C1	+ 900	22:--	--	RIGHT1	POLY	2	55
12	40	SPLA_C2	+ 1100	22:--	--	CENTER	POLY	2	OFF
13	45	DRYCLAP	- 200	12:--	--	RIGHT1	POLY	2	OFF
14	46	OPEN_D2	+ 700	26:28	8	RIGHT1	POLY	2	OFF
15	49	CABASA2	+ 500	8:--	--	RIGHT3	POLY	2	OFF
16	50	COWBEL2	- 500	16:--	--	LEFT 3	POLY	2	OFF
17	55	HIGH_CG	+ 660	29:--	--	RIGHT1	POLY	2	63
18	57	AGOGO2	+ 700	20:--	--	RIGHT3	POLY	2	67
19	38	PLATE1	- 1200	50:10	15	LEFT 3	POLY	2	OFF
20	57	RING1	+ 1600	25:--	--	CENTER	POLY	2	OFF
21	59	PIPE1	- 2200	10:--	--	RIGHT2	POLY	2	OFF
22	48	WBLOCK1	- 1500	9:--	--	LEFT 3	POLY	2	82
23	48	WBLOCK2	- 1200	9:--	--	LEFT 2	POLY	2	OFF
24	65	THRILLR	- 3600	70:70	8	RIGHT1	POLY	2	OFF
25	45	GUNSHT1	- 1950	60:--	--	CENTER	POLY	2	OFF
26	52	SHADOW	- 3600	70:--	--	CENTER	POLY	2	OFF

INSTRUMENT NAME (INST #)	NOTE
OFF	97
OFF	96
OFF	95
OFF	94
POWER T4 (I 35)	93
OFF	92
POWER T3 (I 34)	91
CLSD H2 (C 05)	90
POWER T2 (I 33)	89
WOOD S1 (I 10)	88
NICE S1 (I 13)	87
OPEN S1 (I 11)	86
WOOD K1 (I 03)	85
DBLH K2 (I 05)	84
OFF	83
WBLOCK1 (C 22)	82
OFF	81
OFF	80
OFF	79
OFF	78
OFF	77
OFF	76
CLAVE1 (I 48)	75
OFF	74
OFF	73
WHISTL2 (I 60)	72
WHISTL1 (I 59)	71
OFF	70
CABASA1 (I 49)	69
AGOGO1 (I 57)	68
AGOGO2 (C 18)	67
OFF	66
OFF	65
LOW CG (I 55)	64
HIGH CG (C 17)	63
MUTE CG (I 53)	62
OFF	61
OFF	60
OFF	59
IMPCT S (I 15)	58
CHOK C1 (C 10)	57
COWBEL1 (I 50)	56
SPLA C1 (C 11)	55
TAMBRN1 (I 51)	54
BELL C1 (I 44)	53
OFF	52
RIDE C1 (I 42)	51
ROOM T4 (I 31)	50
CRSH C1 (I 40)	49
DRY T4 (I 27)	48
ROOM T3 (I 30)	47
OPEN H1 (I 38)	46
DRY T3 (I 26)	45
PDAL H1 (I 39)	44
ROOM T2 (I 29)	43
CLSD H1 (I 37)	42
DRY T2 (I 25)	41
RVB S1 (I 18)	40
BOBCLAP (I 45)	39
FAT S1 (I 14)	38
SIDSTK1 (I 22)	37
ROOM K1 (I 07)	36
DRY K1 (I 01)	35
OFF	34

C7

C6

C5

C4

C3

C2

## Roland Exclusive Messages

### 1. Data Format for Exclusive Messages

Roland's MIDI implementation uses the following data format for all exclusive messages (type IV):

Byte	Description
F0H	Exclusive status
41H	Manufacturer ID (Roland)
DEV	Device ID
MDL	Model ID
CMD	Command ID
{BODY}	Main data
F7H	End of exclusive

#### # MIDI status : F0H, F7H

An exclusive message must be flanked by a pair of status codes, starting with a Manufacturer-ID immediately after F0H (MIDI version 1.0).

#### # Manufacturer-ID : 41H

The Manufacturer-ID identifies the manufacturer of a MIDI instrument that triggers an exclusive message. Value 41H represents Roland's Manufacturer-ID.

#### # Device-ID : DEV

The Device-ID contains a unique value that identifies the individual device in the multiple implementation of MIDI instruments. It is usually set to 00H - 0FH, a value smaller by one than that of a basic channel, but value 00H - 1FH may be used for a device with multiple basic channels.

#### # Model-ID : MDL

The Model-ID contains a value that uniquely identifies one model from another. Different models, however, may share an identical Model-ID if they handle similar data.

The Model-ID format may contain 00H in one or more places to provide an extended data field. The following are examples of valid Model-IDs, each representing a unique model:

01H  
02H  
03H  
00H, 01H  
00H, 02H  
00H, 00H, 01H

#### # Command-ID : CMD

The Command-ID indicates the function of an exclusive message. The Command-ID format may contain 00H in one or more places to provide an extended data field. The following are examples of valid Command-IDs, each representing a unique function:

01H  
02H  
03H  
00H, 01H  
00H, 02H  
00H, 00H, 01H

#### # Main data : BODY

This field contains a message to be exchanged across an interface. The exact data size and contents will vary with the Model-ID and Command-ID.

### 2. Address-mapped Data Transfer

Address mapping is a technique for transferring messages conforming to the data format given in Section 1. It assigns a series of memory-resident records—waveform and tone data, switch status, and parameters, for example—to specific locations in a machine-dependent address space, thereby allowing access to data residing at the address a message specifies.

Address-mapped data transfer is therefore independent of models and data categories. This technique allows use of two different transfer procedures: one-way transfer and handshake transfer.

#### # One-way transfer procedure (See Section 3 for details.)

This procedure is suited for the transfer of a small amount of data. It sends out an exclusive message completely independent of a receiving device status.

Connection Diagram

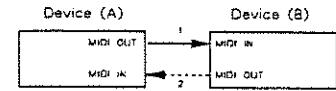

Connection point 2 is essential for "Request data" procedures. (See Section 3.)

#### # Handshake-transfer procedure (See Section 4 for details.)

This procedure initiates a predetermined transfer sequence (handshaking) across the interface before data transfer takes place. Handshaking ensures that reliability and transfer speed are high enough to handle a large amount of data.

Connection Diagram

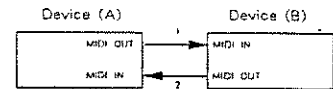

Connection points 1 and 2 is essential.

#### Notes on the above two procedures

- \* There are separate Command-IDs for different transfer procedures.
- \* Devices A and B cannot exchange data unless they use the same transfer procedure, share identical Device-ID and Model ID, and are ready for communication.

### 3. One-way Transfer Procedure

This procedure sends out data all the way until it stops when the messages are so short that answerbacks need not be checked.

For long messages, however, the receiving device must acquire each message in time with the transfer sequence, which inserts intervals of at least 20 milliseconds in between.

#### Types of Messages

Message	Command ID
Request data 1	RQ1 (11H)
Data set 1	DT1 (12H)

#### # Request data # 1 : RQ1 (11H)

This message is sent out when there is a need to acquire data from a device at the other end of the interface. It contains data for the address and size that specify designation and length, respectively, of data required.

On receiving an RQ1 message, the remote device checks its memory for the data address and size that satisfy the request.

If it finds them and is ready for communication, the device will transmit a "Data set 1" (DT1) message, which contains the requested data. Otherwise, the device will send out nothing.

Byte	Description
F0H	Exclusive status
41H	Manufacturer ID (Roland)
DEV	Device ID
MDL	Model ID
11H	Command ID
aaH	Address MSB
⋮	⋮
⋮	LSB
ssH	Size MSB
⋮	⋮
⋮	LSB
sum	Check sum
F7H	End of exclusive



# Request data : RQD (41H)

This message is sent out when there is a need to acquire data from a device at the other end of the interface. It contains data for the address and size that specify designation and length, respectively, of data required.

On receiving an RQD message, the remote device checks its memory for the data address and size which satisfy the request. If it finds them and is ready for communication, the device will transmit a "Data set (DAT)" message, which contains the requested data. Otherwise, it will return a "Rejection (RJC)" message.

Byte	Description
F0H	Exclusive status
41H	Manufacturer ID (Roland)
DEV	Device ID
MDL	Model ID
41H	Command ID
aaH	Address MSB
⋮	⋮
	LSB
ssH	Size MSB
⋮	⋮
	LSB
sum	Check sum
F7H	End of exclusive

\*The size of the requested data does not indicate the number of bytes that make up a "Data set (DAT)" message, but represents the address fields where the requested data resides.

\*Some models are subject to limitations in data format used for a single transaction. Requested data, for example, may have a limit in length or must be divided into predetermined address fields before it is exchanged across the interface.

\*The same number of bytes comprises address and size data, which, however, vary with the Model-ID.

\*The error checking process uses a checksum that provides a bit pattern where the least significant 7 bits are zero when values for an address, size, and that checksum are summed.

# Data set : DAT (42H)

This message corresponds to the actual data transfer process. Because every byte in the data is assigned a unique address, the message can convey the starting address of one or more data as well as a series of data formatted in an address-dependent order.

Although the MIDI standards inhibit non-real time messages from interrupting an exclusive one, some devices support a "soft-through" mechanism for such interrupts. To maintain compatibility with such devices, Roland has limited the DAT to 256 bytes so that an excessively long message is sent out in separate segments.

Byte	Description
F0H	Exclusive status
41H	Manufacturer ID (Roland)
DEV	Device ID
MDL	Model ID
42H	Command ID
aaH	Address MSB
⋮	⋮
	LSB
ddH	Data
⋮	⋮
sum	Check sum
F7H	End of exclusive

\*A DAT message is capable of providing only the valid data among those specified by an RQD or WSD message.

\*Some models are subject to limitations in data format used for a single transaction. Requested data, for example, may have a limit in length or must be divided into predetermined address fields before it is exchanged across the interface.

\*The number of bytes comprising address data varies from one model ID to another.

\*The error checking process uses a checksum that provides a bit pattern where the least significant 7 bits are zero when values for an address, size, and that checksum are summed.

# Acknowledge : ACK (43H)

This message is sent out when no error was detected on reception of a WSD, DAT, "End of data (EOD)", or some other message and a requested setup or action is complete. Unless it receives an ACK message, the device at the other end will not proceed to the next operation.

Byte	Description
F0H	Exclusive status
41H	Manufacturer ID (Roland)
DEV	Device ID
MDL	Model ID
43H	Command ID
F7H	End of exclusive

# End of data : EOD (45H)

This message is sent out to inform a remote device of the end of a message. Communication, however, will not come to an end unless the remote device returns an ACK message even though an EOD message was transmitted.

Byte	Description
F0H	Exclusive status
41H	Manufacturer ID (Roland)
DEV	Device ID
MDL	Model ID
45H	Command ID
F7H	End of exclusive

# Communications error : ERR (4EH)

This message warns the remote device of a communications fault encountered during message transmission due, for example, to a checksum error. An ERR message may be replaced with a "Rejection (RJC)" one, which terminates the current message transaction in midstream.

When it receives an ERR message, the sending device may either attempt to send out the last message a second time or terminate communication by sending out an RJC message.

Byte	Description
F0H	Exclusive status
41H	Manufacturer ID (Roland)
DEV	Device ID
MDL	Model ID
4EH	Command ID
F7H	End of exclusive

### # Rejection : RJC (4FH)

This message is sent out when there is a need to terminate communication by overriding the current message. An RJC message will be triggered when :

- a WSD or RQD message has specified an illegal data address or size.
- the device is not ready for communication.
- an illegal number of addresses or data has been detected.
- data transfer has been terminated by an operator.
- a communications error has occurred.

An ERR message may be sent out by a device on either side of the interface. Communication must be terminated immediately when either side triggers an ERR message.

Byte	Description
FOH	Exclusive status
41H	Manufacturer ID (Roland)
DEV	Device ID
MDL	Model ID
4FH	Command ID
F7H	End of exclusive

### # Example of Message Transactions

● Data transfer from device (A) to device (B).

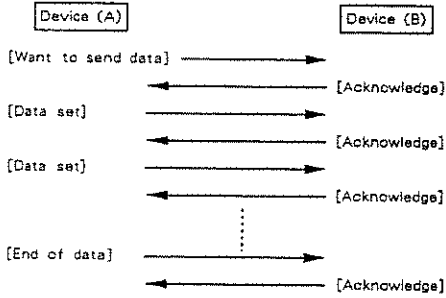

● Device (A) requests and receives data from device (B).

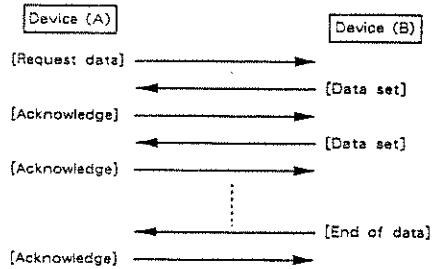

● Error occurs while device (A) is receiving data from device (B).

1) Data transfer from device (A) to device (B).

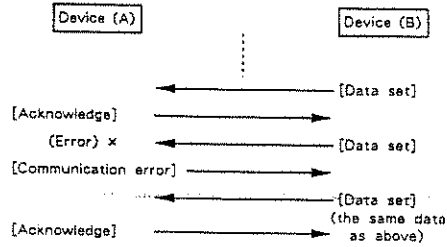

2) Device (B) rejects the data re-transmitted, and quits data transfer.

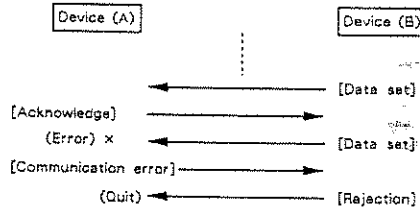

3) Device (A) immediately quits data transfer.

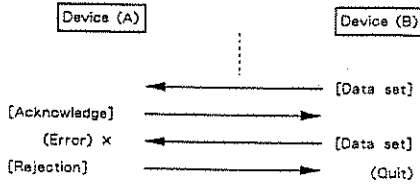



**1. TRANSMITTED DATA**

■ Channel Voice Message

● Note off

Status	Second	Third
9nH	kkH	00H

kk = Note number 0H - 7FH (0 - 127)  
 n = MIDI Channel 0H - FH (1 - 16)

● Note on

Status	Second	Third	vvH
9nH	kkH		vvH

kk = Note number 0H - 7FH (0 - 127)  
 vv = Velocity 01H - 7FH (1 - 127)  
 n = MIDI Channel 0H - FH (1 - 16)

Note number (0 - 127 or OFF), and transmitting channel (1 - 16) can be set for each instrument. An instrument whose note number is set at OFF cannot send any Note event.

The period between a Note On and the subsequent Note Off is in the range of 25ms and 50ms. If, however, another note is made on the same instrument before the Note Off for the previous note is issued, a Note Off for the previous note precedes the new Note On.

The R-8 does not transmit a note event if the Function switch is set at CHANNEL MESSAGE = OFF.

● Control change

○ Modulation Depth

Status	Second	Third
BnH	01H	vvH (MSB)
BnH	21H	vvH (LSB)

○ General purpose Controller - 1

Status	Second	Third
BnH	10H	vvH (MSB)
BnH	30H	vvH (LSB)

○ General purpose Controller - 2

Status	Second	Third
BnH	11H	vvH (MSB)
BnH	31H	vvH (LSB)

○ General purpose Controller - 3

Status	Second	Third
BnH	12H	vvH (MSB)
BnH	32H	vvH (LSB)

○ General purpose Controller - 4

Status	Second	Third
BnH	13H	vvH (MSB)
BnH	33H	vvH (LSB)

○ General purpose Controller - 5

Status	Second	Third
BnH	50H	vvH

○ General purpose Controller - 6

Status	Second	Third
BnH	51H	vvH

○ General purpose Controller - 7

Status	Second	Third
BnH	62H	vvH

○ General purpose Controller - 8

Status	Second	Third
BnH	63H	vvH

vv = Performance parameter value 0H - 7FH (0 - 127) \*1-1  
 n = MIDI Channel 0H - FH (1 - 16)

Instruments and Performance parameters can be assigned to each of 9 controls (Modulation Depth and General purpose controllers (1-8)). These 9 controls may be set to have no Performance parameter.

If an instrument has an assigned control number, it is sent with the current performance parameter value which is sent through the Control Change just before the Note event is sent.

Table \*1-1 relates Performance Parameter values to those actually transmitted by a Control Change. Since a Performance Pitch value requires 2 bytes for being transmitted, Control Number 21H, 30H, 31H,

32H or 33H is used as the lower byte. The Performance value of Decay, Nuance or Pan can be expressed in 1 byte and does not need such Control Number. General purpose controllers, 5-8 have no Control Number usable as lower byte and are not used in transmitting Performance Pitch.

No Control Change is transmitted when the Function switch is set at CHANNEL MESSAGE = OFF.

\*1-1 Control Change Value

parameter	transmitted	received
	- 4800 -> 0400H	0000H-0407H -> - 4800
	- 4790 -> 0410H	0408H-0417H -> - 4790
	- 4780 -> 0420H	0418H-0427H -> - 4780
	:	:
	- 0090 -> 3E70H	3E68H-3E77H -> - 0090
	- 0080 -> 3F00H	3E78H-3F07H -> - 0080
	- 0070 -> 3F10H	3F08H-3F17H -> - 0070
	:	:
	- 0010 -> 3F70H	3F68H-3F77H -> - 0010
pitch	0000 -> 4000H	3F78H-4007H -> 0000
	+ 0010 -> 4010H	4008H-4017H -> + 0010
	:	:
	+ 0070 -> 4070H	4068H-4077H -> + 0070
	+ 0080 -> 4100H	4078H-4107H -> + 0080
	+ 0090 -> 4110H	4108H-4117H -> + 0090
	:	:
	+ 4780 -> 7B50H	7B58H-7B67H -> + 4780
	+ 4790 -> 7B70H	7B68H-7B77H -> + 4790
	+ 4800 -> 7C00H	7B78H-7B7FH -> + 4800
	:	:
	- 63 -> 01H	00H -> - 63
	- 62 -> 02H	01H -> - 62
	:	:
	- 01 -> 3FH	3FH -> - 01
decay	00 -> 40H	40H -> 00
	+ 01 -> 41H	41H -> + 01
	:	:
	+ 62 -> 7EH	7EH -> + 62
	+ 63 -> 7FH	7FH -> + 63
	:	:
	- 7 -> 0BH	00H-0BH -> - 7
	- 6 -> 10H	0CH-13H -> - 6
	- 5 -> 18H	14H-1BH -> - 5
	:	:
	- 1 -> 3BH	34H-3BH -> - 1
nuance	0 -> 40H	3CH-43H -> 0
	+ 1 -> 4BH	44H-4BH -> + 1
	:	:
	+ 5 -> 6BH	64H-6BH -> + 5
	+ 6 -> 70H	6CH-73H -> + 6
	+ 7 -> 7BH	74H-7FH -> + 7
	:	:
	0 (L3) -> 0BH	00H-0FH -> 0 (L3)
	1 (L2) -> 1BH	10H-1FH -> 1 (L2)
	2 (L1) -> 2BH	20H-2FH -> 2 (L1)
pan	3 (C) -> 3BH	30H-3FH -> 3 (C)
	4 (R1) -> 4BH	40H-4FH -> 4 (R1)
	5 (R2) -> 5BH	50H-5FH -> 5 (R2)
	6 (R3) -> 6BH	60H-6FH -> 6 (R3)
	7 (OFF) -> 7FH	70H-7FH -> 7 (OFF)

■ System Exclusive message

Status  
 FOH : System Exclusive  
 F7H : EOX (End of Exclusive)

With the R-8, the System Exclusive Message can be used to transmit sound parameter of each instrument and Bulk Dump / Load of sequence data, set-up data and one pattern.  
 For details refer to para. 4. Exclusive Communications and "Roland Exclusive Messages".

■ System common message

● Song position pointer

Status            Second            Third  
 F2H                11H                    hhH

ll = song position (LSB) 0H - 7FH (0 - 127)  
 hh = song position (MSB) 0H - 7FH (0 - 127)

Transmitted in one of the following operations:  
 Song Play mode - measure reposition or measure selection Pattern Play or Real Time Write mode - bar reposition or bar selection

● Song select

Status            Second  
 F3H                ssh

ss = song select 0H - 9H (0 - 9)

Transmitted when a Song is selected in Song Play mode.

■ System Real Time message

● Timing Clock

Status  
 FBH

Transmitted when Sync mode is other than MIDI, even in non-play period.

● Start

Status  
 FAH

Transmitted upon pressing START key for initiating play with Sync mode set at other than MIDI.

● Continue

Status  
 FBH

Transmitted when CONTINUE START is made for initiating play with Sync mode set at other than MIDI.

● Stop

Status  
 FCH

Transmitted when STOP is made with Sync mode set at other than MIDI.

● Active Sensing

Status  
 FEH

Transmitted for checking MIDI connection between R-8 and external equipment.

**2. RECOGNIZED RECEIVE DATA (INSTRUMENT SECTION)**

■ Channel Voice Message

● Note off

Status            Second            Third  
 8nH                kkH                    vvH  
 9nH                kkH                    00H

kk = Note number 0H - 7FH (0 - 127)  
 vv = Velocity ignored  
 n = MIDI Channel 0H - FH (1 - 16)

Mutes the sounding notes upon receiving a Note Off message if the Function switch is set at NOTE OFF = ON.

● Note on

Status            Second            Third  
 9nH                kkH                    vvH

kk = Note number 0H - 7FH (0 - 127)  
 vv = Velocity 01H - 7FH (1 - 127)  
 n = MIDI Channel 0H - FH (1 - 16)

When the R-8 receives a Note On on the channel assigned to the Instrument Section, it sounds the instrument assigned that Note Number.  
 In the case when one or more instrument has been set to the same Note Number, up to 12 instruments can sound simultaneously; if more than 12 instruments have the same Note Number, priority is given to larger Instrument Numbers.

The R-8 ignores note events if Function switch is set at CHANNEL MESSAGE = OFF.

● Control change

○ Panpot

Status            Second            Third  
 BnH                OAH                    vvH

vv = Panpot 0H - 7FH (0 - 127) \*2-1  
 n = MIDI Channel 0H - FH (1 - 16)

When the R-8 receives a PANPOT with the Function switch set at PANPOT = ON: Every time the R-8 receives a Note On on the receiving channel of the Instrument Section, it sounds on the PANPOT position until the Panpot having different value is given.  
 Refer to Table \*2-1 for the relationship between Panpot values and positions of the instrument.

The R-8 does not recognize Panpot if the Function switch is set at CHANNEL MESSAGE = OFF or PANPOT = OFF.

\*2-1 Control Change Value (Panpot)

Parameter	received
	00H-12H -> 0 (L3)
	13H-24H -> 1 (L2)
	25H-36H -> 2 (L1)
pan	37H-48H -> 3 (C)
	49H-5AH -> 4 (R1)
	5BH-6CH -> 5 (R2)
	6DH-7FH -> 6 (R3)

○ Modulation Depth

Status            Second            Third  
 BnH                01H                    vvH (MSB)  
 BnH                21H                    vvH (LSB)

○ General purpose Controller - 1

Status            Second            Third  
 BnH                10H                    vvH (MSB)  
 BnH                30H                    vvH (LSB)

○ General purpose Controller - 2

Status	Second	Third
BnH	11H	vvH (MSB)
BnH	31H	vvH (LSB)

○ General purpose Controller - 3

Status	Second	Third
BnH	12H	vvH (MSB)
BnH	32H	vvH (LSB)

○ General purpose Controller - 4

Status	Second	Third
BnH	13H	vvH (MSB)
BnH	33H	vvH (LSB)

○ General purpose Controller - 5

Status	Second	Third
BnH	50H	vvH

○ General purpose Controller - 6

Status	Second	Third
BnH	51H	vvH

○ General purpose Controller - 7

Status	Second	Third
BnH	52H	vvH

○ General purpose Controller - 8

Status	Second	Third
BnH	53H	vvH

vv = Performance parameter value 0H - 7FH (0 - 127) \*1 - 1  
 n = MIDI Channel 0H - FH (1 - 16)

Instruments and Performance parameters can be assigned to each of 9 controls (Modulation Depth and General purpose controllers (1 - 8)). These 9 controls may be set to have no Performance parameter. (This assignment is in common with that of transmitter.)

When the R-8 receives Modulation Depth or General purpose controllers (1 - 8) on the Receiving Channel of the Instrument Section, it memorizes the value with Control Number.

Upon receiving a Note On, and if an instrument has an assigned Control Number, the R-8 sounds the Performance Parameter which has been converted from the value memorized in the Control Change.

Refer to Table \*1-1 for relationship between received Control Change values and Performance Parameters.

The R-8 does not recognize Control Change if the Function switch is set at CHANNEL MESSAGE = OFF.

● Program change

Status	Second
CnH	ppH

(Pattern Play mode)

pp = Program number 0H - 63H (1 - 100)  
 n = MIDI Channel 0H - FH (1 - 16)

When the R-8 receives a Program Change on the Basic Channel (Instrument Section receiving channel) in Pattern Play mode with the Function switch set at PROGRAM CHANGE = ON, it changes the Pattern number to the new number (one number smaller than the program number).

(Song Play mode)

pp = Program number 0H - 7H (1 - 8)  
 7FH (128)  
 n = MIDI Channel 0H - FH (1 - 16)

When the R-8 receives a Program Change on the Basic Channel (Instrument Section receiving channel) in Song Play mode with the Function switch set at PROGRAM CHANGE = ON, it changes the Feel Patch number to the new number (one number smaller than the program number).

Reception of 7FH (128) has an effect of no-Feel Patch.

The R-8 ignores Program Change when the Function switch is set at CHANNEL MESSAGE = OFF or PROGRAM CHANGE = OFF.

■ System Exclusive message

Status	Second	Third
F0H		System Exclusive
F7H		EOX (End of Exclusive)

With the R-8 the System Exclusive Message can be used to receive Sound Parameter of each instrument and Bulk Dump/Load of Sequence data, Set-up data and one pattern.

For details refer to para. 4. Exclusive Communications and "Roland Exclusive Message". The R-8 ignores Exclusive Message if the Function switch is set at EXCLSV RX = OFF.

■ System common message

● Song position pointer

Status	Second	Third
F2H	11H	hhH

ll = song position (LSB) 0H - 7FH (0 - 127)  
 hh = song position (MSB) 0H - 7FH (0 - 127)

Recognized only when the R-8 is in stop with Sync at MIDI.  
 When the R-8 receives Song Position Pointer in Song Play mode it calls the position in the song and when in Pattern Play mode or Real Time Write mode, the position in the pattern.

● Song select

Status	Second
F3H	ssH

ss = song select 0H - 9H (0 - 9)

Recognized only when the R-8 is in stop with Sync at MIDI.  
 When received in Song Play mode, it changes the songs.

■ System Real Time message

● Timing Clock

Status
F8H

Recognized only when the Sync mode is set at MIDI.

● Start

Status
FAH

Recognized only when the Sync mode is set at MIDI.

● Continue

Status
FBH

Recognized only when the Sync mode is set at MIDI.

● Stop

Status
FCH

Recognized only when the Sync mode is set at MIDI.

### 3. RECOGNIZED RECEIVE DATA (PERFORMANCE SECTION 1 - 4)

#### ■ Channel Voice Message

##### ● Note off

Status	Second	Third	
8nH	kkH		vvH
9nH	kkH		00H

kk = Note number 0H - 7FH (0 - 127)  
 vv = Velocity ignored  
 n = MIDI Channel 0H - FH (1 - 16)

When the Function switch is set at NOTE OFF = ON, the received Note Off message mutes the sounds being reproduced.

##### ● Note on

Status	Second	Third	
9nH	kkH		vvH

kk = Note number 0H - 7FH (0 - 127)  
 vv = Velocity 01H - 7FH (1 - 127)  
 n = MIDI Channel 0H - FH (1 - 16)

All sections can be assigned a channel (1 - 16) or OFF.  
 When the R-8 receives Note On on the MIDI receiving channel of a Performance Section, the instrument allocated to that section will sound.

The Performance parameter to be controlled by Note number can be selected from panel operation for each section. Received Note number will be converted into the Performance Parameter before the instrument is reproduced.

When Instrument Section and Performance Section are set at the same receiving channel, priority is given to the Instrument Section. If more than one Performance Section is set at the same receiving channel, they are reproduced simultaneously.

The R-8 ignores Note event when the Function switch is set at CHANNEL MESSAGE = OFF.

##### ● Control change

##### ○ Panpot

Status	Second	Third
BnH	OAH	vvH

vv = Panpot 0H - 7FH (0 - 127) \* 2 - 1  
 n = MIDI Channel 0H - FH (1 - 16)

When a Panpot is received with the Function switch set at PANPOT = ON, the subsequent Note On's on the same channel cause the instruments to sound on the same position. To change the position Panpot of different value must be issued on that channel. Refer to Fig. \* 2 - 1 for Panpot values vs Positions.

Panpot is ignored if the Function switch is set at CHANNEL MESSAGE = OFF or PANPOT = OFF.

##### ○ Modulation Depth

Status	Second	Third
BnH	01H	vvH

##### ○ General purpose Controller - 1

Status	Second	Third
BnH	10H	vvH

##### ○ General purpose Controller - 2

Status	Second	Third
BnH	11H	vvH

##### ○ General purpose Controller - 3

Status	Second	Third
BnH	12H	vvH

##### ○ General purpose Controller - 4

Status	Second	Third
BnH	13H	vvH

##### ○ General purpose Controller - 5

Status	Second	Third
BnH	50H	vvH

##### ○ General purpose Controller - 6

Status	Second	Third
BnH	51H	vvH

##### ○ General purpose Controller - 7

Status	Second	Third
BnH	52H	vvH

##### ○ General purpose Controller - 8

Status	Second	Third
BnH	53H	vvH

vv = Performance parameter value 0H - 7FH (0 - 127) \* 1 - 1  
 n = MIDI Channel 0H - FH (1 - 16)

A control (Modulation Depth, or General purpose controllers (1 - 8)) and a Performance Parameter can be assigned to each section (No - Control - change - received can also be set).

The R-8, when it receives a Control on the receiving channel of a particular Performance Section, memorizes the value for that section, and converts this memorized value to generate the Performance Parameter when it reproduces a sound upon receiving a Note On. Refer to Table \* 1 - 1 for relationship between received control change values and performance parameters.

The R-8 does not recognize Control Change if the function switch is set at CHANNEL MESSAGE = OFF.

#### 4. EXCLUSIVE COMMUNICATIONS

With the R-8, Exclusive One Way Messages can be used for transferring of sound parameters and bulk dumping/loading of the internal memory.

In Exclusive message, the model ID is expressed by 28H and device ID by the basic channel number. In actual data, the value of device ID is smaller the basic channel number by 1.

##### ■ ONE - WAY COMMUNICATIONS

Request Data RQ1 11H

byte	Description
FOH	Exclusive status
41H	Manufactures ID (Roland)
DEV	Device ID
28H	Model ID (R-8)
11H	Command ID (RQ1)
aaH	Address MSB
aaH	Address
aaH	Address
aaH	Address LSB
saH	Size MSB
saH	Size
saH	Size
saH	Size LSB
sum	Check sum
F7H	EOX (End of exclusive)

Data set DT1 12H

byte	Description
FOH	Exclusive status
41H	Manufactures ID (Roland)
DEV	Device ID
28H	Model ID (R-8)
12H	Command ID (DT1)
aaH	Address MSB
aaH	Address
aaH	Address
aaH	Address LSB
ddH	Data
:	:
sum	Check sum
F7H	EOX (End of exclusive)

The R-8 sends parameter (s) by using one way communications in either of the following cases.

1. One Way Bulk Dump is selected and executed from MIDI Bulk Dump operation. (A group of designated parameters are sent.)
2. ENTER key is pressed during Sound Edit. (The sound parameters of the sound being edited are sent.)

The R-8 receives parameter (s) by using one way communications in either of the following cases.

The R-8's sequencer is stopped and EXCLSV RX of MIDI FUNCTION SW is ON.

Also note that Song data and Pattern data can be received on All songs. All patterns or one pattern basis while the remaining parameters can be received in a unit of mapped one byte.

#### 5. PARAMETER ADDRESS MAP

Addresses are shown in 7-bit hexadecimal

Address	MSB			LSB
Binary	0aaa aaaa	0bbb bbbb	0ccc cccc	0ddd dddd
7-bit hex.	AA	BB	CC	DD

##### ■ Parameter base address

Start address	Description	
00 00 00 00	Sound Parameter #1	#5-1
00 00 00 0A	Sound Parameter #2	
:	:	
00 00 09 26	Sound Parameter #120	
00 01 00 00	Copy Sound Area	#5-2
00 02 00 00	RDM Card data Area	#5-3
00 03 00 00	Performance Parameter #A-1	#5-4
00 03 00 08	Performance Parameter #A-2	
:	:	
00 03 00 78	Performance Parameter #A-16	
00 03 01 00	Performance Parameter #B-1	
:	:	
00 03 01 78	Performance Parameter #B-16	
00 03 02 00	Performance Parameter #C-1	
:	:	
00 03 02 78	Performance Parameter #C-16	
00 03 03 00	Performance Parameter #D-1	
:	:	
00 03 03 78	Performance Parameter #D-16	
00 03 04 00	Performance Parameter #E-1	
:	:	
00 03 04 78	Performance Parameter #E-16	
00 03 05 00	Performance Parameter #M-1	
:	:	
00 03 05 78	Performance Parameter #M-16	
00 04 00 00	Feel Patch #0	#5-5
00 04 00 5C	Feel Patch #1	
:	:	
00 04 05 04	Feel Patch #7	
00 05 00 00	Assign Area	#5-6
00 06 00 00	Output Level	#5-7
00 07 00 00	MIDI Parameter Area	#5-8
00 08 00 00	System data Area	#5-9
01 00 00 00	Song data Area	#5-10
02 00 00 00	PTN 00 data Area	#5-11
02 02 00 00	PTH 01 data Area	
:	:	
03 45 00 00	PTN 99 data Area	

\*5-1 Sound Parameter

Offset address	Description	
00 00	0000 aaaa	Pitch data bit3-0 0 - 480
00 01	0000 bbbb	: bit7-4
00 02	0000 000c	: bit8
00 03	0000 000a	sign Pitch 0 - 1 (0=plus 1=minus)
00 04	0aaa aaaa	Decay for Partial-1 0 - 127
00 05	0aaa aaaa	Decay for Partial-2 0 - 127
00 06	0000 aaaa	Nuance 0 - 15
00 07	0000 aaaa	Output 0 - 14 (LEFT3-1,CENTER, RIGHT1-3,MULTI1-8)
00 08	0000 aaaa	Assign Type 0 - 9 (EXCL-8,MONO,POLY)
00 09	0000 0aaa	Curve 0 - 7 (1 - 8)
Total size		00 00 00 0A

\*5-2 Copy Sound Area

Offset address	Description	
00 00	0aaa aaaa	Source Inst no. #1 0 - 119
00 01	0aaa aaaa	Source Inst no. #2 0 - 119
:	:	:
00 19	0aaa aaaa	Source Inst no. #26 0 - 119
00 1A	:	Copy Sound Name #1 *5-2-1
00 21	:	Copy Sound Name #2
:	:	:
01 49	:	Copy Sound Name #26
Total size		00 00 01 50

\*5-2-1 Copy Sound Name

Offset address	Description	
00 00	0aaa aaaa	Copy Sound Name char.1 32 - 127
:	:	:
00 06	0aaa aaaa	Copy Sound Name char.7 32 - 127
Total size		00 00 00 07

\*5-3 ROM Card data Area

Offset address	Description	
00 00	0aaa aaaa	ROM Card data 0 - 127
:	:	:
14 31	0aaa aaaa	ROM Card data 0 - 127
Total size		00 00 14 32

The data in this area will be read in when LOAD ROM is executed in Card mode.

\*5-4 Performance Parameter

Offset address	Description	
00 00	0000 aaaa	Pitch data bit3-0 0 - 480
00 01	0000 bbbb	: bit7-4
00 02	0000 000c	: bit8
00 03	0000 000a	sign Pitch 0 - 1 (0=plus 1=minus)
00 04	0aaa aaaa	Decay -83 - +63 *
00 05	0000 aaaa	Nuance -7 - +7 *
00 06	0000 0aaa	Pan 0 - 7 (LEFT3, 2, 1, CENTER, RIGHT1, 2, 3, OFF)
00 07	0xxx xxxx	dummy (ignored if received)
Total size		00 00 00 08
* 2's-complement		

\*5-5 Feel Patch Parameter

Offset address	Description	
00 00	0aaa aaaa	Inst no. #1 0 - 119
:	:	:
00 07	0aaa aaaa	Inst no. #8 0 - 119
00 08	0000 dcba	Inst sw. #1
:	:	:
:	:	a : Velocity 0 - 1 (OFF, ON)
:	:	b : Decay 0 - 1 (OFF, ON)
:	:	c : Pitch 0 - 1 (OFF, ON)
:	:	d : Nuance 0 - 1 (OFF, ON)
00 0F	0000 dcba	Inst sw. #8
:	:	:
:	:	a : Velocity 0 - 1 (OFF, ON)
:	:	b : Decay 0 - 1 (OFF, ON)
:	:	c : Pitch 0 - 1 (OFF, ON)
:	:	d : Nuance 0 - 1 (OFF, ON)
00 10	0000 dcba	Random sw
:	:	:
:	:	a : Velocity 0 - 1 (OFF, ON)
:	:	b : Decay 0 - 1 (OFF, ON)
:	:	c : Pitch 0 - 1 (OFF, ON)
:	:	d : Nuance 0 - 1 (OFF, ON)
00 11	0000 aaaa	Random Probability for Velocity 1 - 8
00 12	0000 aaaa	Random Probability for Decay 1 - 8
00 13	0000 aaaa	Random Probability for Pitch 1 - 8
00 14	0000 aaaa	Random Probability for Nuance 1 - 8
00 15	0000 0aaa	Random Depth for Velocity 1 - 4
00 16	0000 0aaa	Random Depth for Decay 1 - 4
00 17	0000 0aaa	Random Depth for Pitch 1 - 4
00 18	0000 0aaa	Random Depth for Nuance 1 - 4
00 19	0000 dcba	Groove sw.
:	:	:
:	:	a : Velocity 0 - 1 (OFF, ON)
:	:	b : Decay 0 - 1 (OFF, ON)
:	:	c : Pitch 0 - 1 (OFF, ON)
:	:	d : Nuance 0 - 1 (OFF, ON)
00 1A	0000 aaaa	Groove Type 1 - 8
00 1B	0000 0aaa	Groove Step 1 - 7 (1/4, 1/8, 1/8, 1/12, 1/16, 1/24, 1/32)
00 1C	:	Groove Velocity offset #1 *5-5-1
:	:	:
00 2A	:	Groove Velocity offset #8
00 2C	:	Groove Decay offset #1 *5-5-1
:	:	:
00 3A	:	Groove Decay offset #8
00 3C	:	Groove Pitch offset #1 *5-5-1
:	:	:
00 4A	:	Groove Pitch offset #8

00 4C	Groove Nuance offset #1	*5-5-1
00 5A	Groove Nuance offset #8	
-----		
Total size	00 00 00 5C	

\*5-5-1 Groove offset

Offset address	Description	
00	0aaa aaaa	absolute value 0 - 99
01	0000 000a	sign bit 0 - 1 (0=plus, 1=minus)
-----		
Total size	00 00 00 02	

\*5-6 Assign Parameter

Offset address	Description	
00 00	0aaa aaaa	Inst# (Pad A-1) 0 - 119
00 0F	0aaa aaaa	Inst# (Pad A-15) 0 - 119
00 1D	0aaa aaaa	Inst# (Pad B-1) 0 - 119
00 1F	0aaa aaaa	Inst# (Pad B-15) 0 - 119
00 2C	0aaa aaaa	Inst# (Pad C-1) 0 - 119
00 2F	0aaa aaaa	Inst# (Pad C-15) 0 - 119
00 3D	0aaa aaaa	Inst# (Pad D-1) 0 - 119
00 3F	0aaa aaaa	Inst# (Pad D-15) 0 - 119
00 4D	0aaa aaaa	Inst# (Pad E-1) 0 - 119
00 4F	0aaa aaaa	Inst# (Pad E-15) 0 - 119
00 50	0aaa aaaa	Inst# (Display assign #2) 0 - 119
00 51	0aaa aaaa	Inst# (Display assign #3) 0 - 119
00 52	0aaa aaaa	Inst# (Display assign #4) 0 - 119
00 53	0aaa aaaa	Inst# (Multi) 0 - 119
-----		
Total size	00 00 00 54	

\*5-7 Output Level

Offset address	Description	
00 00	0000 aaaa	Output Level #1 0 - 15
00 01	0000 aaaa	Output Level #2 0 - 15
00 77	0000 aaaa	Output Level #120 0 - 15
-----		
Total size	00 00 00 78	

\*5-8 MIDI Parameter Area

Offset address	Description	
00 00	0000 aaaa	Tx Channel #1 0 - 15 (1 - 16)
00 77	0000 aaaa	Tx Channel #120 0 - 15 (1 - 16)
00 78	000a aaaa	Rx Channel (Perform Section #1) 0 - 15 (1-16, OFF)
00 79	000a aaaa	Rx Channel (Perform Section #2) 0 - 15 (1-16, OFF)
00 7A	000a aaaa	Rx Channel (Perform Section #3) 0 - 15 (1-16, OFF)
00 7B	000a aaaa	Rx Channel (Perform Section #4) 0 - 15 (1-16, OFF)
00 7C		Note no. assign #1 *5-8-1
00 7E		Note no. assign #2 *5-8-1
02 6A		Note no. assign #120 *5-8-1
02 6C	0000 dcba	Function sw. a : CR MESSAGE 0 - 1 (OFF, ON) b : NOTE OFF 0 - 1 (OFF, ON) c : PANPOT 0 - 1 (OFF, ON) d : PGH CHANGE 0 - 1 (OFF, ON)
02 5D		Control Change Parameter *5-8-2
02 7F		Performance Section #1 *5-8-3
03 03		Performance Section #2 *5-8-3
03 11		Performance Section #4 *5-8-3
-----		
Total size	00 00 03 17	

\*5-8-1 Note# assign

Offset address	Description	
00	0aaa aaaa	note no. 0 - 127
01	0000 000a	ON/OFF flag 0 - 1 (OFF, ON)
-----		
Total size	00 00 00 02	

\*5-8-2 Control Change Parameter

Offset address	Description	
00	0aaa aaaa	Modulation Control Inst# 0 - 119
01	0000 0aaa	Control Parameter 0 - 4 (Pitch, Decay, Nuance, Pan, Off)
02	0aaa aaaa	General purpose Controller 1 Control Inst# 0 - 119
03	0000 0aaa	Control Parameter 0 - 4 General purpose Controller 2
04	0aaa aaaa	Control Inst# 0 - 119
05	0000 0aaa	Control Parameter 0 - 4
06	0aaa aaaa	Control Inst# 0 - 119
07	0000 0aaa	Control Parameter 0 - 4
08	0aaa aaaa	Control Inst# 0 - 119
09	0000 0aaa	Control Parameter 0 - 4
-----		
Total size	00 00 00 12	

\*5-8-3 Performance Section

Offset address	Description
00   0aaa aaaa	Control Inst# 0 - 119
01   0000 00aa	Parameter(Note# Controlled) 0 - 3 (Pitch, Decay, Nuance, Pan)
02   0aaa aaaa	Center note no. 0 - 127
03   0aaa aaaa	Keyboard follow 0 - 99
04   0000 aaaa	Control change no. 0 - 9 (Modulation, Controller 1-8, OFF)
05   0000 00aa	Parameter(Control change) 1 - 3 (Decay, Nuance, Pan)
Total size   00 00 00 06	

\*5-9 System data Area

Offset address	Description
00 00   0000 00aa	Sync mode 0 - 2 (INTERNAL, MIDI, TAPE)
00 01   0000 aaaa	ROLL Resolution 1 - 9 (1/4, 1/8, 1/8, 1/12, 1/16, 1/24, 1/32, 1/48, HIGH)
00 02	Metronome set *5-9-1
00 06	User function #0 *5-9-2
00 16	User function #1
:	:
01 16	User function #9
01 26	Macro #0 *5-9-3
01 4D	Macro #1
:	:
04 05	Macro #3
Total size   00 00 04 2C	

\*5-9-1 Metronome Set

Offset address	Description
00   0000 0aaa	Interval 1 - 7 (1/4, 1/8, 1/8, 1/12, 1/16, 1/24, 1/32)
01   0000 00aa	Mode 0 - 2 (OFF, EMPTY, EVERY)
02   0000 aaaa	Level 0 - 15
03   0000 aaaa	Output 0 - 14 (LEFT1-3, CENTER, RIGHT1-3, MULTI1-8)
Total size   00 00 00 04	

\*5-9-2 User function

Offset address	Description
00   0aaa aaaa	key# (LINE 01) 0 - 52
01   0aaa aaaa	key# (LINE 02) 0 - 52
:	:
0F   0aaa aaaa	key# (LINE 16) 0 - 52
Total size   00 00 00 10	

\*5-9-3 Macro

Offset address	Description
00   000a aaaa	Macro note Length 2 - 16
01   0000 dcba	Normal timing (step1-4) a: step1 ON/OFF flag 0 - 1 (OFF, ON) b: step2 ON/OFF flag 0 - 1 (OFF, ON) c: step3 ON/OFF flag 0 - 1 (OFF, ON) d: step4 ON/OFF flag 0 - 1 (OFF, ON)
02   0000 dcba	Normal timing (step5-8)
03   0000 dcba	Normal timing (step9-12)
04   0000 dcba	Normal timing (step13-16)
05   0000 dcba	Flam timing (step1-4) a: step1 ON/OFF flag 0 - 1 (OFF, ON) b: step2 ON/OFF flag 0 - 1 (OFF, ON) c: step3 ON/OFF flag 0 - 1 (OFF, ON) d: step4 ON/OFF flag 0 - 1 (OFF, ON)
06   0000 dcba	Flam timing (step5-8)
07   0000 dcba	Flam timing (step9-12)
08   0000 dcba	Flam timing (step13-16)
09   0aaa aaaa	Relative velocity (step 2) absolute value 0 - 99
0A   0000 000a	sign bit 0 - 1
0B   0aaa aaaa	Relative velocity (step 3) absolute value 0 - 99
0C   0000 000a	sign bit 0 - 1
:	:
25   0aaa aaaa	Relative velocity (step 16) absolute value 0 - 99
26   0000 000a	sign bit 0 - 1
Total size   00 00 00 27	

\*5-10 Song data Area

Data included in the area are: Song data, Song name, Song chain and initial parameters of Songs 0 to 9.

When the data in this area are transmitted from Bulk Dump operation, the size of the data depends upon that of Song data.

If you want to send Data Request to the R-8 in this area, set the address to 01 00 00 00, and the size to 01 00 00 00.

The R-8 ignores Data Requests designating different address or size.

No data in this area can be transferred in units of one byte.

\*5-11 Pattern data Area

Data included in the area are: Rhythm data, Time signature, Number of measures, Flam interval, Flam ratio, Shuffle point, Shuffle delay, Feel patch number in each pattern, and Pattern names.

When the data in this area are transmitted from Bulk Dump operation, the size of the data depends upon the number of notes.

If you want to send Data Request to the R-8 in this area, set the address and the size as follows.

one pattern ..... address = the address of the pattern  
size = 00 02 00 00

all pattern ..... address = 02 00 00 00  
size = 01 48 00 00

The R-8 ignores Data Requests designating different address or size.  
No data in the area can be received in unit of one byte.



----- Address Map -----

Address	Block	Sub block	Reference
00 00 00 00	Sound Param.	Inst #1	5-1
		Inst #2	
		:	
		Inst #119	
		Inst #120	
00 01 00 00	Copy Sound data		5-2
00 02 00 00	ROM Card data		5-3
00 03 00 00	Perform Param.	A-1	5-4
		A-2	
		:	
		M-15	
		M-16	
00 04 00 00	Feel Patch	#0	5-5
		#1	
		:	
		#6	
		#7	
00 05 00 00	Assign Param.		5-6
00 06 00 00	Output Level	Inst #1	5-7
		Inst #2	
		:	
		Inst #119	
		Inst #120	
00 07 00 00	MIDI Param.		5-8
00 08 00 00	System data		5-9
01 00 00 00	Song data		5-10
02 00 00 00	Pattern data	PTN 00	5-11
		PTN 01	
		:	
		PTN 98	
		PTN 99	

# MIDI Implementation Chart

Function ...		Transmitted	Recognized	Remarks
Basic Channel	Default Changed	1 - 16 1 - 16	1 - 16 1 - 16	Memorized (Non - volatile)
Mode	Default Messages Altered	Mode 3 x *****	Mode 3 x	
Note Number	True Voice	0 - 127 ** *****	0 - 127 **	Assignable to each instrument
Velocity	Note ON Note OFF	* 9n v = 1 - 127 x 9n v = 0	* 9b v = 1 - 127 x	n = Inst Ch *** b = Basic Ch
After Touch	Key's Ch's	x x	x x	
Pitch Bender		x	x	
Control Change	1, 33	*	*	Modulation
	10	x	*	Panpot
	16, 48	*	*	General purpose control - 1
	17, 49	*	*	General purpose control - 2
	18, 50	*	*	General purpose control - 3
	19, 51	*	*	General purpose control - 4
	80	*	*	General purpose control - 5
	81	*	*	General purpose control - 6
82	*	*	General purpose control - 7	
83	*	*	General purpose control - 8	
Prog Change	True #	x *****	*	
System Exclusive		○	*	
System Common	Song Pos Song Sel Tune	○ ○ x	○ SYNC = MIDI ○ SYNC = MIDI x	0 - 9
System Real Time	Clock Commands	○ SYNC = INT/TAPE ○ SYNC = INT/TAPE	○ SYNC = MIDI ○ SYNC = MIDI	
Aux Message	Local ON/OFF All Notes OFF Active Sense Reset	x x ○ x	x x x x	
Notes	<p>* Can be set to ○ or x manually and memorized.                  ** Can be changed manually and memorized.                  *** Transmit channel of each instrument can be changed to 1 to 16 manually.</p>			

Mode 1 : OMNI ON, POLY  
 Mode 3 : OMNI OFF, POLY

Mode 2 : OMNI ON, MONO  
 Mode 4 : OMNI OFF, MONO

○ : Yes  
 x : No

Function ...		Transmitted	Recognized	Remarks
Basic Channel	Default Changed	x x	OFF OFF, 1 - 16 **	Memorized (Non - volatile)
Mode	Default Messages Altered	x x *****	Mode 3 x	
Note Number	True Voice	x *****	0 - 127	
Velocity	Note ON Note OFF	x x	○ 9n v = 1 - 127 x	n = Section Ch
After Touch	Key's Ch's	x x	x x	
Pitch Bender		x	x	
Control Change	1	x	*	Modulation
	10	x	*	Panpot
	16	x	*	General purpose control - 1
	17	x	*	General purpose control - 2
	18	x	*	General purpose control - 3
	19	x	*	General purpose control - 4
	80	x	*	General purpose control - 5
	81	x	*	General purpose control - 6
82	x	*	General purpose control - 7	
83	x	*	General purpose control - 8	
Prog Change	True #	x *****	x	
System Exclusive		x	x	
System Common	Song Pos Song Sel Tune	x x x	x x x	
System Real Time	Clock Commands	x x	x x	
Aux Message	Local ON/OFF All Notes OFF Active Sense Reset	x x x x	x x x x	
<p>Notes</p> <p>* Can be set to ○ or x manually and memorized. (for each Performance Section)</p> <p>** If channel is set to OFF, R - 8 cannot recognize any message.</p>				

Mode 1 : OMNI ON, POLY  
Mode 3 : OMNI OFF, POLY

Mode 2 : OMNI ON, MONO  
Mode 4 : OMNI OFF, MONO

○ : Yes  
x : No

## ■ SPECIFICATIONS

R-8 : Human Rhythm Composer

### ● Sound Source

Sampling Frequency : 44.1 kHz  
Dynamic Range : 16 bit  
Maximum Voices : 32Voices  
68 Internal Instrument Voices  
26 Copy Instrument Voices  
26 External Instrument Voices  
(On a Sound ROM Card)

### (Sound Parameters)

Pitch :  $\pm 4$  oct (in 10 cent steps)  
Decay : 0 to 127  
Nuance : 0 to 15  
Output Assign : Multi Out 1 to 8/  
Stereo Out (7 level pan)  
Assign Type : MONO/POLY/EXC1 to 8  
Sense Curve : 1 to 8

### ● Rhythm Pattern

32 Preset Patterns  
100 User-Patterns  
(Maximum number of bars writable : 99)  
Memorized Data : Velocity/Pitch/Decay/  
Nuance/Pan/Micro Timing

### ● Song

10 Songs (total of up to 999 parts)  
Memorized Data : Initial Tempo/Initial Level/  
Rhythm Pattern/Repeat/Tempo Change/  
Level Change/Label

### ● 8 Feel Patches

● 10 Users Functions (Maximum number of  
lines : 16)

● 10 Macro Notes (Maximum number of  
notes : 16)

### ● External Memory

Memory Card : M-256E, M-256D

### ● Step Resolution

1/96 note (in Writing)  
1/384 note (in Playing)

● Tempo : 20 to 250 beats per measure

### ● Display

Function Display (2 line, 20 characters)  
Graphic Display  
Tempo Indicator

### ● Control Section

#### [Front Panel]

Value Slider  
Volume Slider  
Song Button  
Pattern Button  
MIDI Button  
Instrument Assign Button  
Card Button  
Utility Button  
Sound Button  
Performance Button  
Feel Button  
Define Button  
Cancel Button  
Function Button  
Macro Button  
Pad Bank Button  
Multi Button  
Scope Button  
Cursor Buttons  
Page Button  
Tempo Button  
Level Button  
Numerical Keys  
Exit Button  
Enter Button  
Parameter Up/Down Button  
Parameter Select Button  
Start/Stop Button  
Roll Button  
Flam Button  
Shift Button  
Key Pads 1 to 16 (with Velocity)

#### [Rear Panel]

Power Switch  
LCD Contrast Control Knob

● **Output Jacks**

Multi Output Jacks 1 to 8  
Stereo Output Jacks (R/L (MONO))  
Headphone Jack

● **Connection Jacks**

RAM Card Slot  
ROM Card Slot  
Start/Stop Jack  
Value Jack  
Tape Sync In Jack  
Tape Sync Out Jack  
MIDI Sockets (IN/OUT/THRU)  
AC Adapter Socket ( $\pm 10V$ )

● **Dimensions**

410 (W) × 290 (D) × 70 (H) mm  
16 - 1/8" × 11 - 7/16" × 2 - 3/4"

● **Weight 3.1kg/6 lb 13 oz**

● **Power Consumption 7 W**

● **Accessories**

AC Adapter  
(ACH series : dedicated to the R-8)  
Owner's Manual  
Quick Operation Mode Table  
Instrument Table  
Data flow of each Parameters  
Parameter Chart  
Guide Book for MIDI

● **Options**

RAM Card (M-256E/M-256D)  
Sound ROM Card  
Pedal Switch (DP-2)  
Footswitch (FS-5U)  
Foot Volume (EV-5/EV-10)

\*The specifications of this product are subject to change without prior notice, in the interest of for improvement.

## ■ Index to Functions

### [Instrument Setting]

- Editing tone of each Instrument
  - ☞Sound Parameter Setting ..... Page 47
- Changing Instrument assignment to each Key Pad
  - ☞Instrument Assign ..... Page 40
- Editing Instrument tones for each Key Pad
  - ☞Performance Parameters ..... Page 77
- Assigning one Instrument to the 16 Key pads then playing it in a changed pitch or tone in each Key Pad.
  - ☞Using the Multi Assign ..... Page 81
  - ☞Alignment ..... Page 82
- Using a ROM Card
  - ☞How to use a ROM Card ..... Page 43
- Using an edited Instrument for another Instrument
  - ☞Copy Instrument ..... Page 54
- Saving Instrument data onto a RAM card
  - ☞Save ..... Page 165
- Restoring the Sound Parameter Settings preprogrammed from the manufacturer
  - ☞How to initialize the Sound Parameters ..... Page 159
- Restoring the Instrument Assignment preprogrammed from the manufacturer
  - ☞How to initialize the Instrument Assignment ..... Page 158
- Clearing the Performance Parameters.
  - ☞How to clear the Performance Parameters ..... Page 160

### [Rhythm Pattern Writing]

- Writing a rhythm pattern by tapping key pads
  - ☞Default Settings for Pattern Write ..... Page 59
  - ☞Real-time Writing ..... Page 61
- Writing a rhythm pattern by entering a step at a time
  - ☞Default Settings for Pattern Write ..... Page 59
  - ☞Step Writing ..... Page 65
- Adding the Swing effect
  - ☞Swing ..... Page 84
- Adding the Flam effect
  - ☞Flam ..... Page 86
- Adding the Roll effect
  - ☞Roll ..... Page 88
- Playing performance pattern by tapping the Key pads once.
  - ☞Macro Note ..... Page 89
- Setting Feel Patch data
  - ☞Feel Patch ..... Page 96
- Changing tones of sound in a rhythm pattern
  - ☞Editing Sequence Parameters ..... Page 107
- Swapping Instruments in a rhythm pattern
  - ☞Instrument Change ..... Page 115
- Joining two rhythm patterns
  - ☞Pattern Append ..... Page 116
- Copying an Instrument's rhythm pattern to another pattern
  - ☞Pattern Extract ..... Page 117

- Merging two rhythm patterns
  - ☐ Pattern Merge ..... Page 119
- Change the Start point of the rhythm pattern.
  - ☐ Reframe ..... Page 120
- Copying a Preset or a User-programmed pattern to another User-programmed pattern
  - ☐ Pattern Copy ..... Page 121
- Naming a rhythm pattern
  - ☐ Pattern Naming ..... Page 123
- Checking the memory remaining for rhythm patterns
  - ☐ Available Memory ..... Page 152
- Saving rhythm pattern data onto a RAM card
  - ☐ Save ..... Page 165
- Erasing the entire rhythm pattern data
  - ☐ All Pattern Clear ..... Page 153

## [Song Writing]

- Writing a song using rhythm patterns
  - ☐ Song Write ..... Page 127
- Repeat playing rhythm patterns you specified
  - ☐ Repeat ..... Page 129
- Changing the tempo in the middle of a Song
  - ☐ Tempo Change ..... Page 131
- Changing the level in the middle of a Song
  - ☐ Level Change ..... Page 132
- Writing a label in a Part of a Song. Getting to the label written in a Song.
  - ☐ Label ..... Page 133
- Deleting the specified Part
  - ☐ Part Delete ..... Page 135
- Adding Song Data
  - ☐ Part Insert ..... Page 136
- Copying specified Parts to a different location
  - ☐ Part Copy ..... Page 138
- Copying the entire Song to another Song Number
  - ☐ Song Copy ..... Page 140
- Erasing a Song data
  - ☐ Song Clear ..... Page 141
- Erasing all Song data
  - ☐ All Song Clear ..... Page 153
- Naming a Song
  - ☐ Song Name ..... Page 142
- Saving Song data onto a RAM card
  - ☐ Save ..... Page 165

## [Song Playing]

- Playing from the middle of a song (from a specified bar)
  - ☐Continue Play .....Page 143
- Playing more than one song continuously
  - ☐Song Chain .....Page 144
- Setting the base tempo and level of a song
  - ☐Initial Tempo and Initial Level .....Page 145
- Playing from a labeled position
  - ☐Search Label .....Page 146
- Checking the time needed for a song to be played
  - ☐Time Calculate .....Page 147
  - ☐Time Display .....Page 149
- Playing a song within the specified time
  - ☐Time Set .....Page 150
- Checking the remaining memory for song data
  - ☐Available Memory .....Page 152

## [Sync Playing]

- Determining how the R-8 should sync
  - ☐Sync Mode .....Page 167
- Sync'ing to an external MIDI device
  - ☐MIDI Sync .....Page 169
- Sync'ing to an MTR (multi-track recorder)
  - ☐Tape Sync .....Page 170

## [MIDI]

- MIDI Structure
  - ☐MIDI Structure .....Page 172
- Setting a Transmit Channel for each Instrument
  - ☐Transmit Channel .....Page 173
- Setting a Receive Channel for each Section
  - ☐Receive Channel .....Page 174
- Setting a Note Number for each Instrument
  - ☐Note Numbers .....Page 175
- Setting Channel Messages, Receive and Transmit
  - ☐Function Switches .....Page 176
- Setting the Control Changes
  - ☐Control Change .....Page 180
- External MIDI Equipment
  - ☐Example Setups .....Page 183
- Data Transfer via Exclusive messages
  - ☐Data Transfer via Exclusive .....Page 186
- Restore the Note numbers preprogrammed from the manufacturer.
  - ☐How to initialize the Note Numbers .....Page 158



## ■ Index to Terminology

### A

Align Function	82
All Pattern Clear	153
All Song Clear	153
Assign Type	50
Available Memory	152

### B

Basic Channel	174
Basic Mode	66
Bulk Dump	186

### C

Card Mode	32
Center Note Number	181
Channel Message	176
Channel Message Switch	177
Continue Play	143
Copy Instrument	54
Control Change	180

### D

Decay	48
Display Assign	46

### E

Edit Mode	31
Error Message	189
Exclusive Message	186
Exclusive Switch	178

### F

Feel Edit Mode	32
Feel Patch	96
Flam	86
Flam Interval	86
Flam Ratio	86
Formatting	163
Function Switch	176

### G

Groove	96
Groove Select	98
Groove Step	98
Groove Switch	99
Groove Type	98

### I

Initialization	158
Initial Level	145
Initial Tempo	145
Instrument Assigning	40
Instrument Assign Mode	32
Instrument Change	115
Instrument Section	172
Instrument Select	98
Instrument Switch	100

### K

Keyboard Follower	181
-------------------	-----

### L

Label	133
Level Adjustment	21
Level Change	132
Load	166

### M

Macro Mode	92
Macro Note	89
Macro Timing Shift	112
Main Mode	31
Memory Card	162
Menu Display	34
Metronome Setting	63
Micro Timing Shift	113
MIDI Mode	32
MIDI Sync	169
Multi Assignment	81

### N

Normal Editing Mode	67
Normal Entry	66
Note Message	175
Note Number	175
Note Off Message	177
Note Off Switch	177
Nuance	49

### O

Output Assign	49
---------------	----

**P**

Pad Bank	18
Pan	49
Pan Switch	177
Part	126
Part Copy	138
Part Delete	135
Part Insert	136
Pattern Append	116
Pattern Copy	121
Pattern Extract	117
Pattern Merge	119
Pattern Mode	32
Pattern Name	123
Pattern Write	58
Performance Edit Mode	32
Performance Parameter	77
Performance Section	172
Pitch	47
Preset Pattern	23
Probability	100
Program Change Message	178
Program Change Switch	178
Protect Switch	162

**Q**

Quantize	61
----------	----

**R**

RAM Card	162
Random Depth	100
Random Factor	99
Random Factor Switch	99
Real-time Edit	108
Real-time Writing	61
Receive Channel	174
Reframe	120
Repeat	129
Rhythm Pattern	27
Roll	88
ROM Card	43

**S**

Save	165
Scope Editing Mode	68
Scope Step	68
Search Label	134

Sense Curve	51
Sequence Parameter	107
Song	27
Song Clear	141
Song Edit	135
Song Chain	144
Song Copy	140
Song Mode	32
Song Name	142
Song Write	126
Sound Edit Mode	32
Sound Parameter	47
Sound ROM Card	43
Step	65
Step Edit	110
Step Writing	65
Swing	84
Swing Delay	84
Swing Point	84
Sync Mode	167

**T**

Tape Sync	170
Tempo Adjustment	21
Tempo Change	131
Time Calculate	147
Time Display	149
Time Set	150
Transmit Channel	173
Triplet Entry	66

**U**

User Pattern	24
Users Function	154
Utility	152
Utility Mode	32

**V**

Velocity	107
----------	-----



**Roland®**

---

**10685**

UPC 10685



10991

**Roland®**